

M5 IgA IGHV1-18/J1 51bp (2156)

- Germline
- Inferred
- Choroid plexus
- Pia mater
- Cortex
- Lesion
- CLN
- Spleen
- Multiple CNS tissues
- Peripheral and CNS tissues

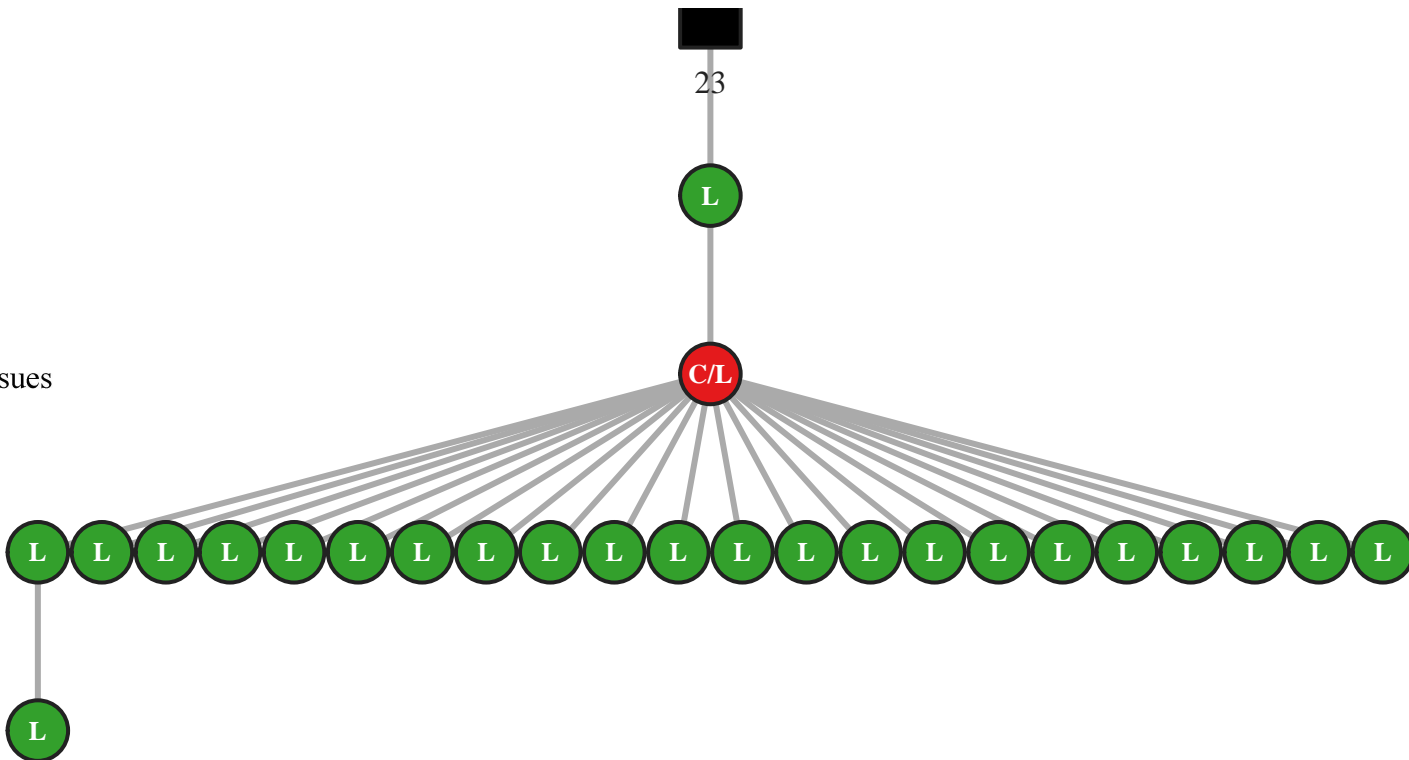

M5 IgG IGHV1-18/J2 39bp (49388)

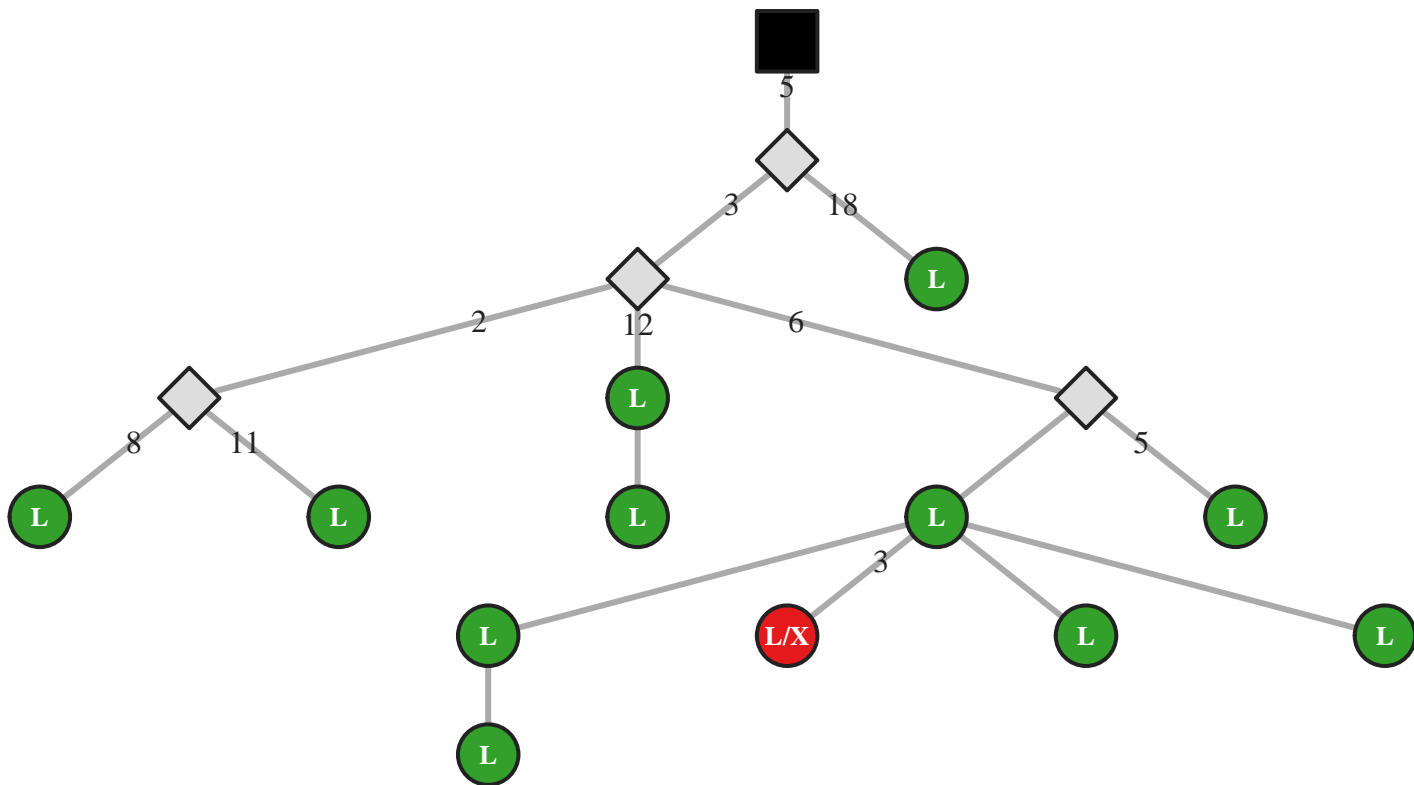

M5 IgG IGHV1-18/J2 48bp (13466)

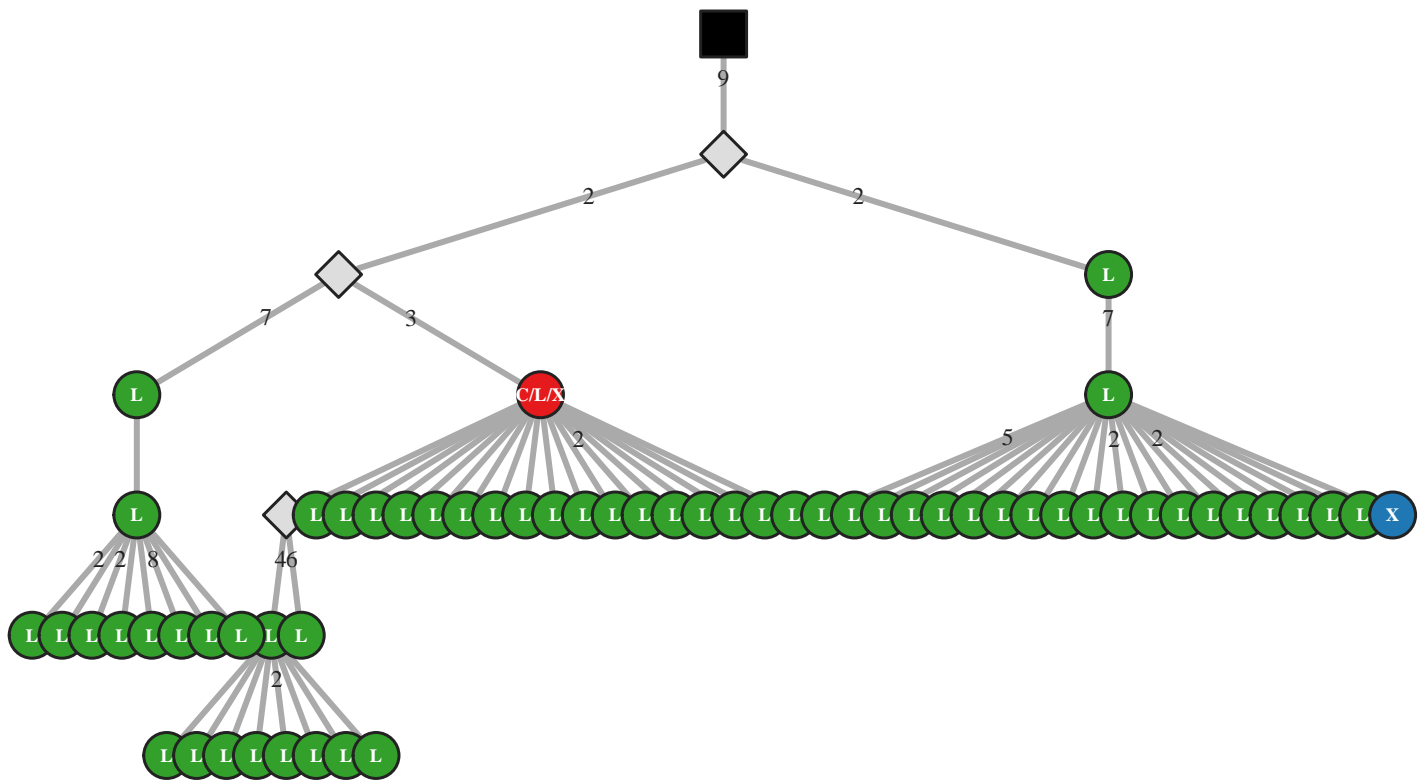

M5 IgG IGHV1-18/J3 33bp (13473)

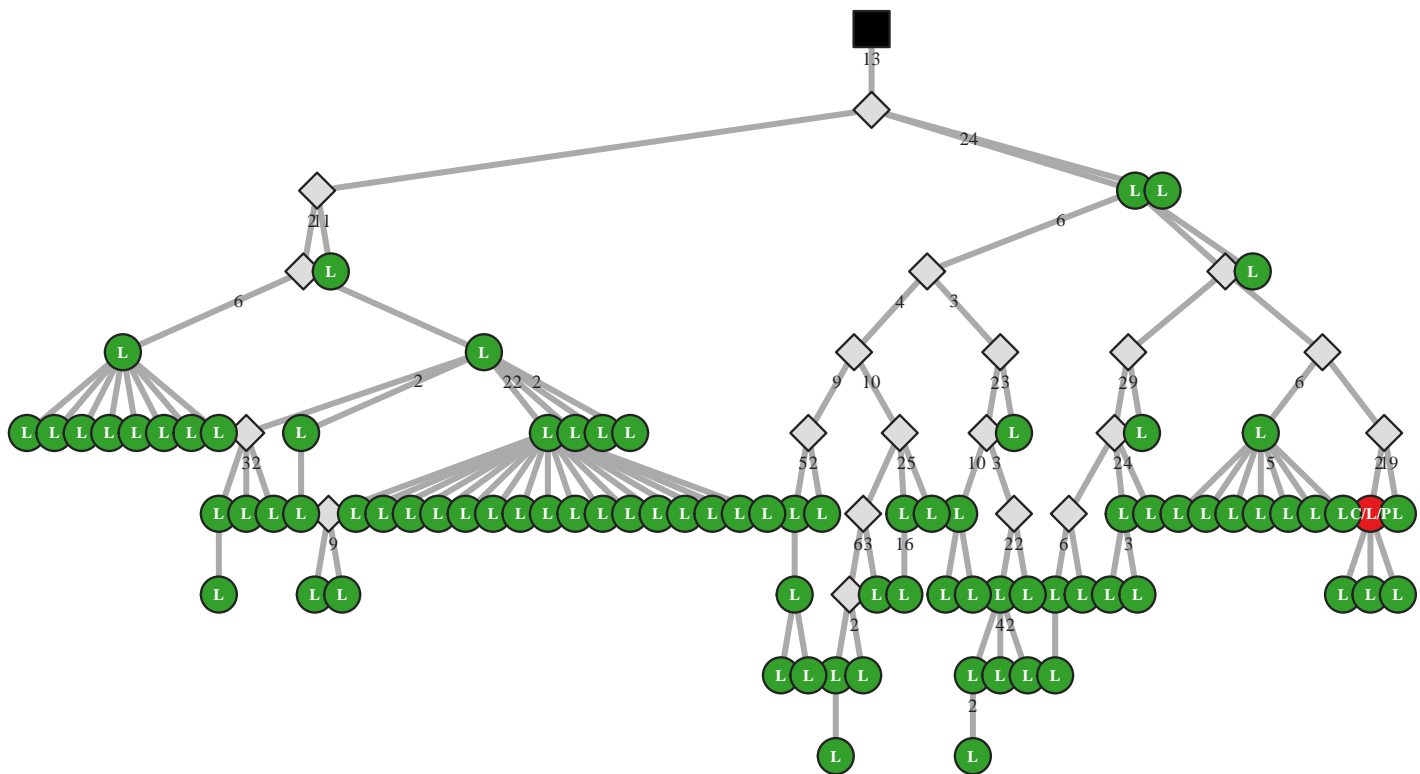

M5 IgM IGHV1-18/J3 39bp (37325)

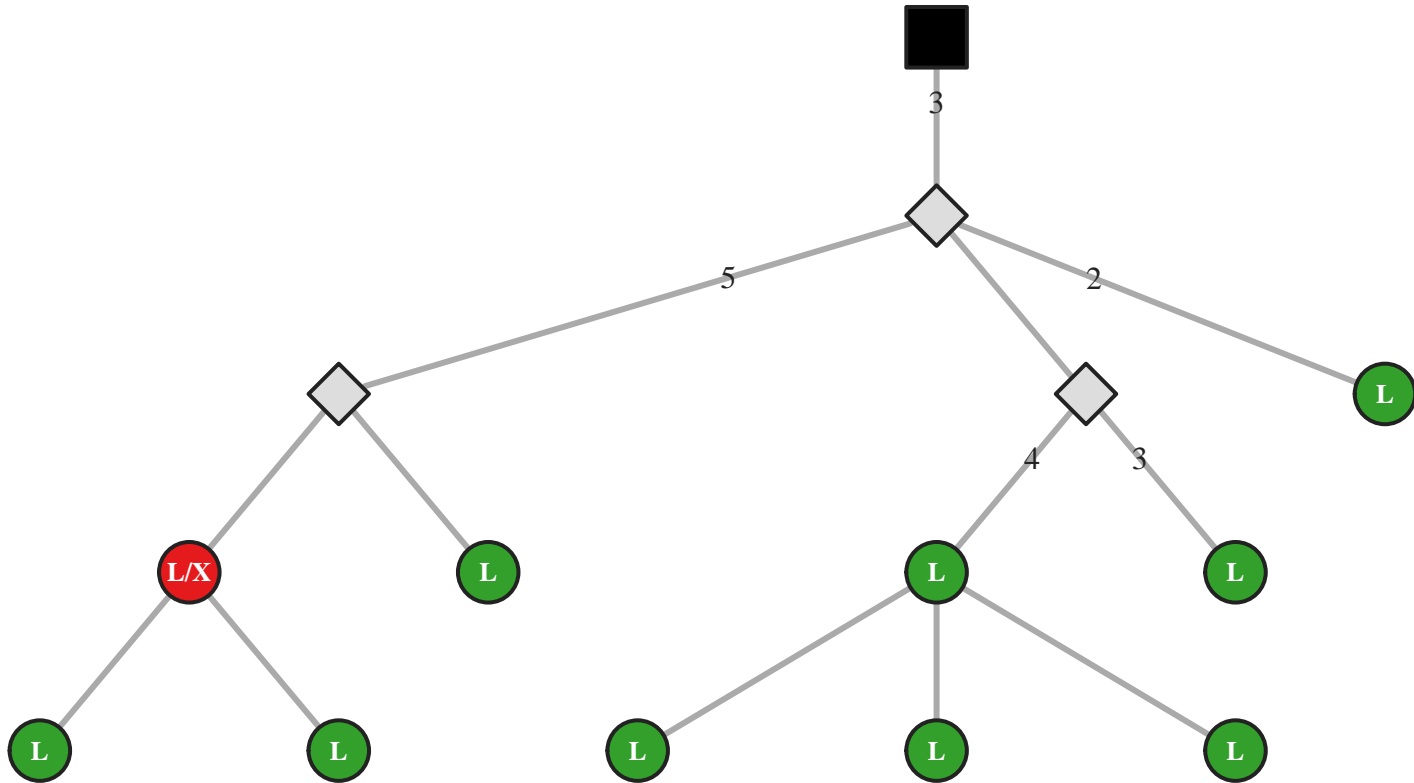

M5 IgM IGHV1-18/J3 45bp (29072)

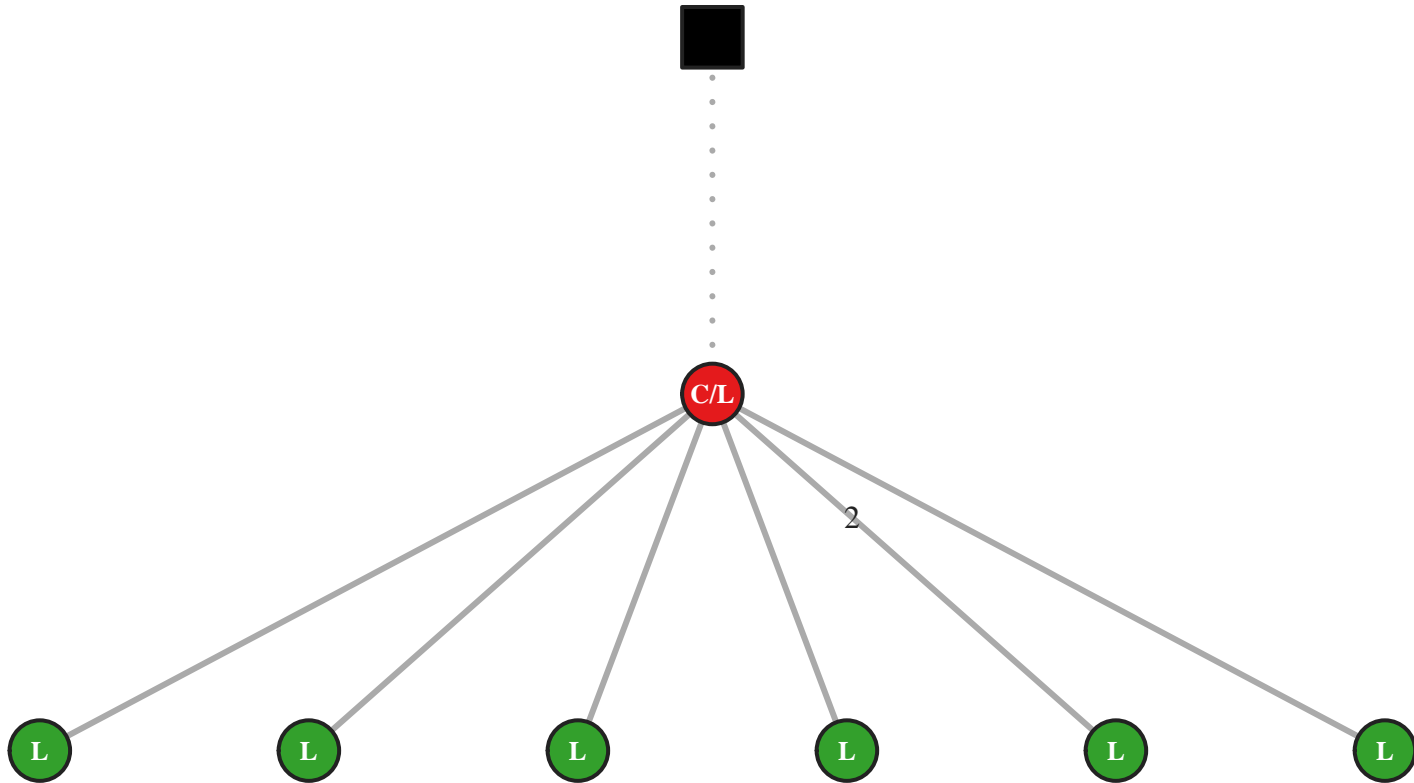

M5 IgG IGHV1-18/J3 51bp (22686)

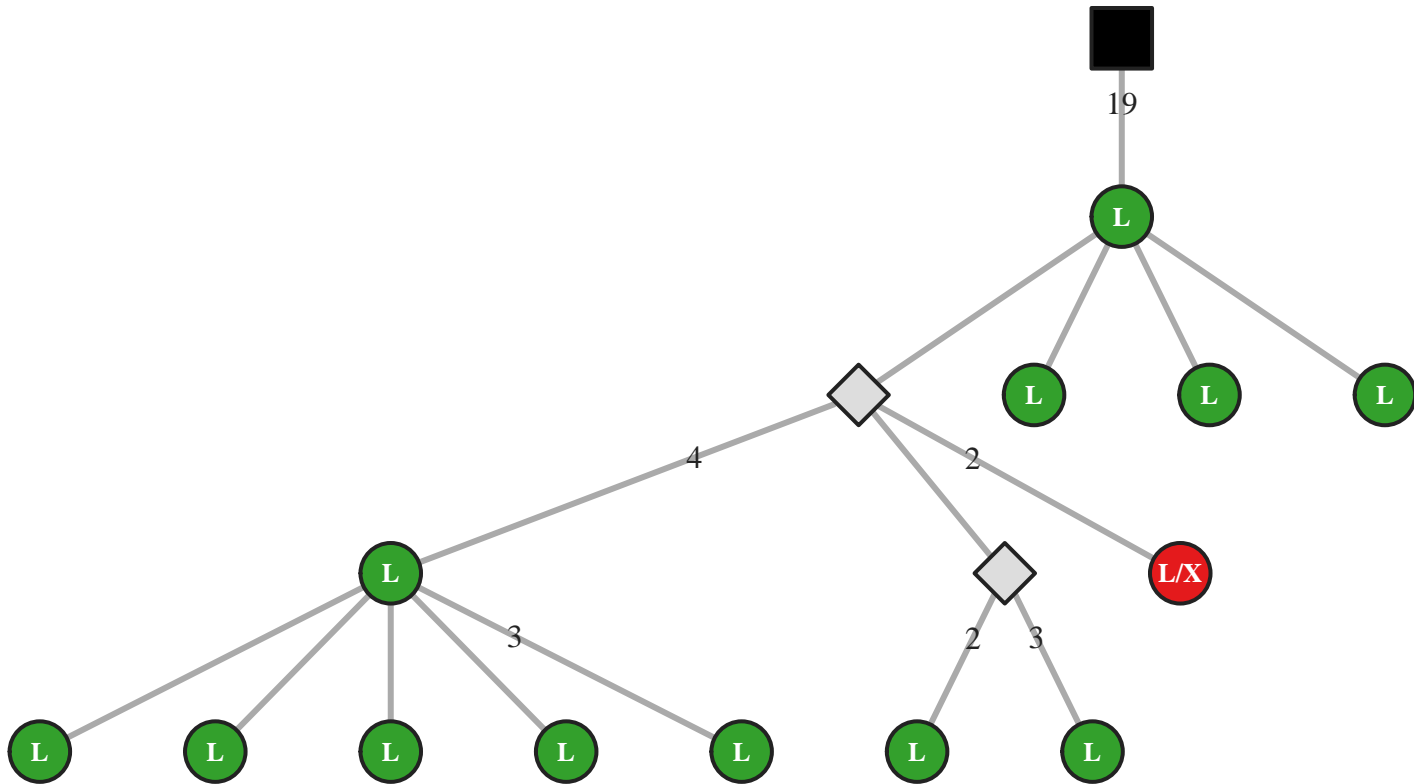

M5 IgG IGHV1-18/J3 57bp (31424)

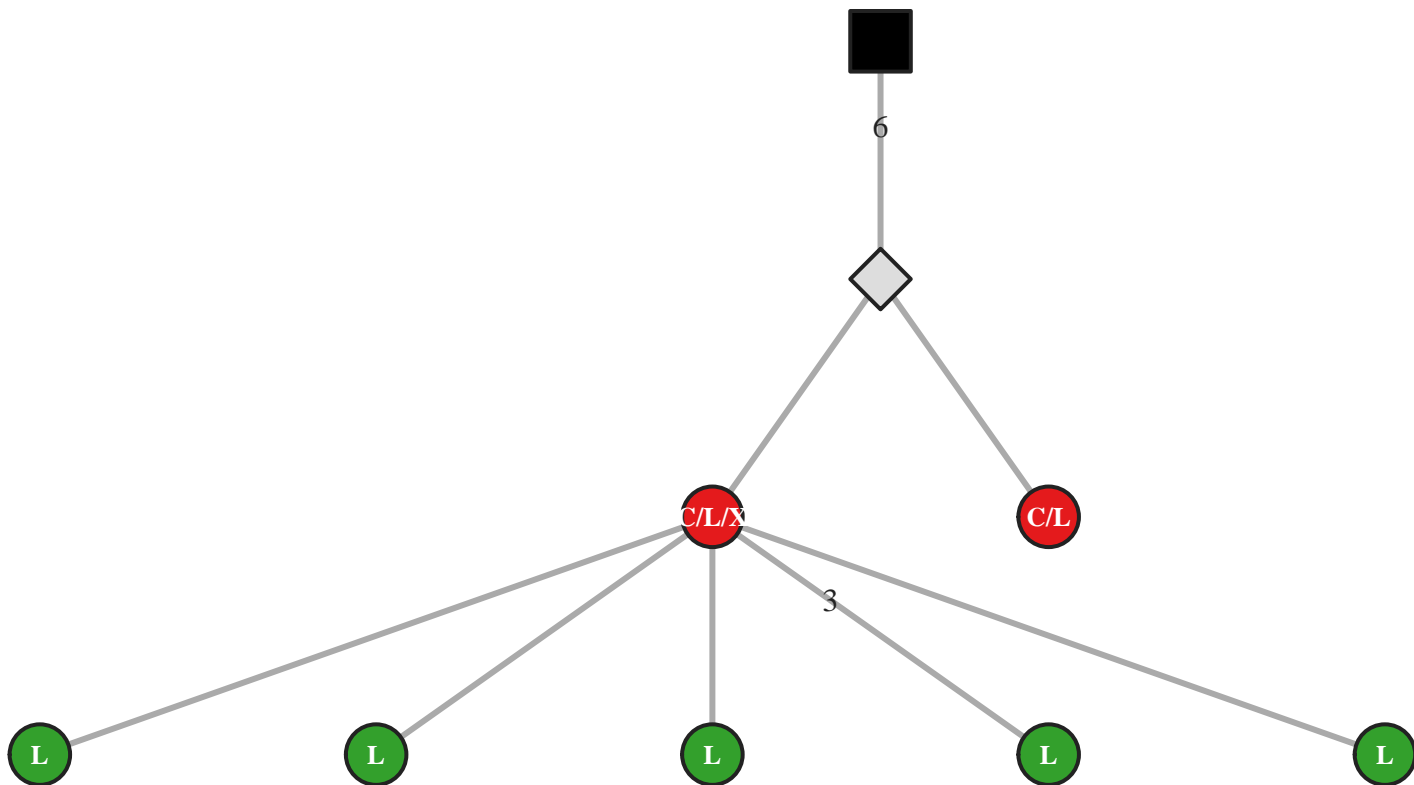

M5 IgG IGHV1-18/J3 60bp (22692)

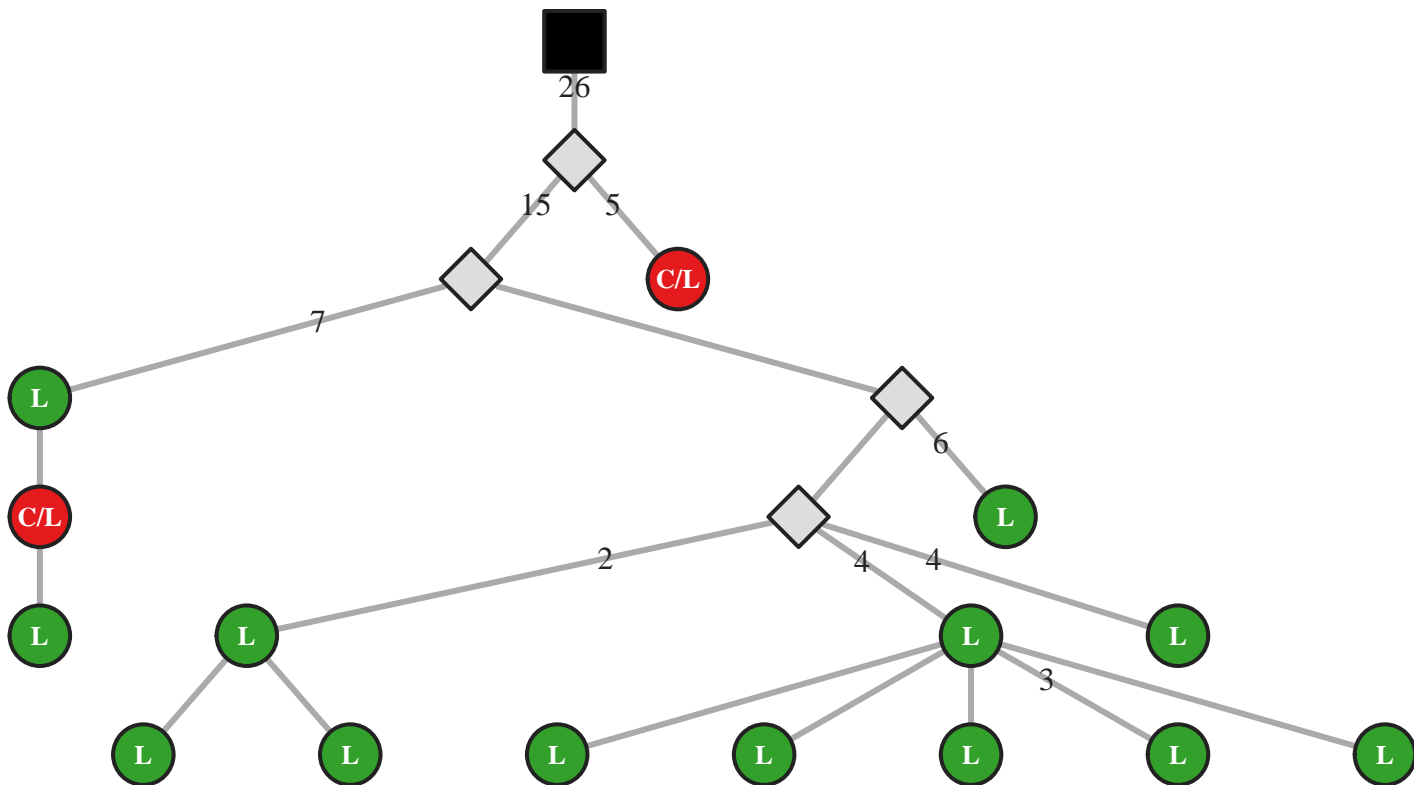

M5 IgG IGHV1-18/J4 33bp (13493)

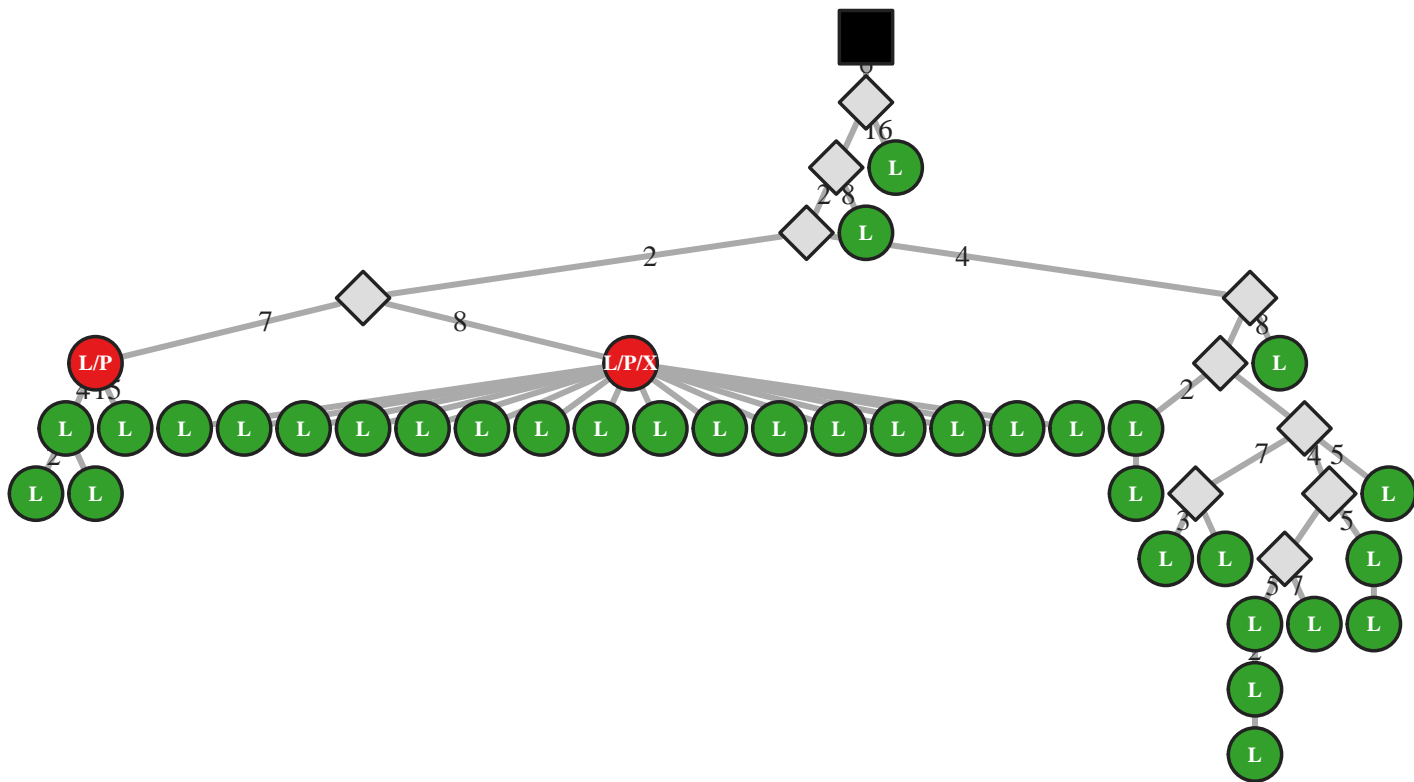

M5 IgA IGHV1-18/J4 36bp (11789)

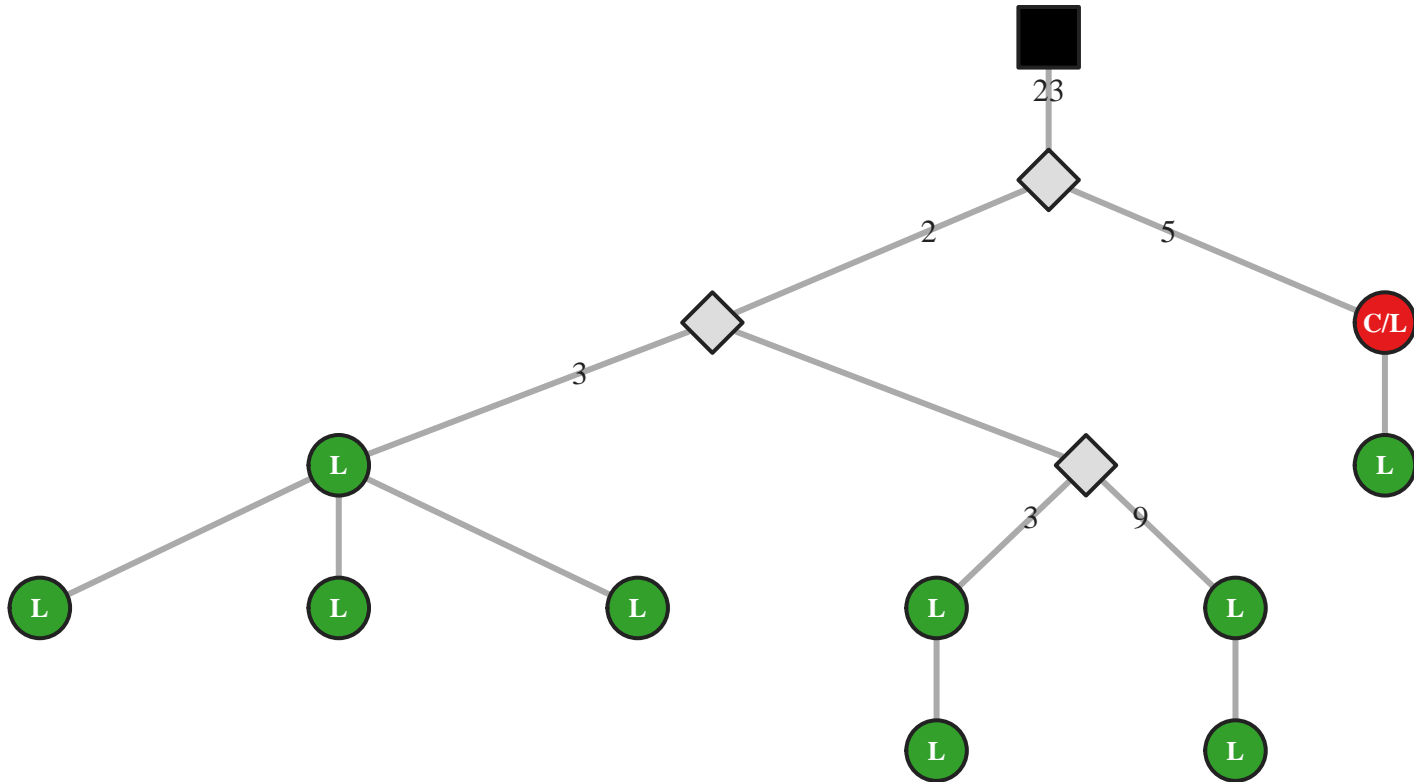

M5 IgG IGHV1-18/J4 36bp (31447)

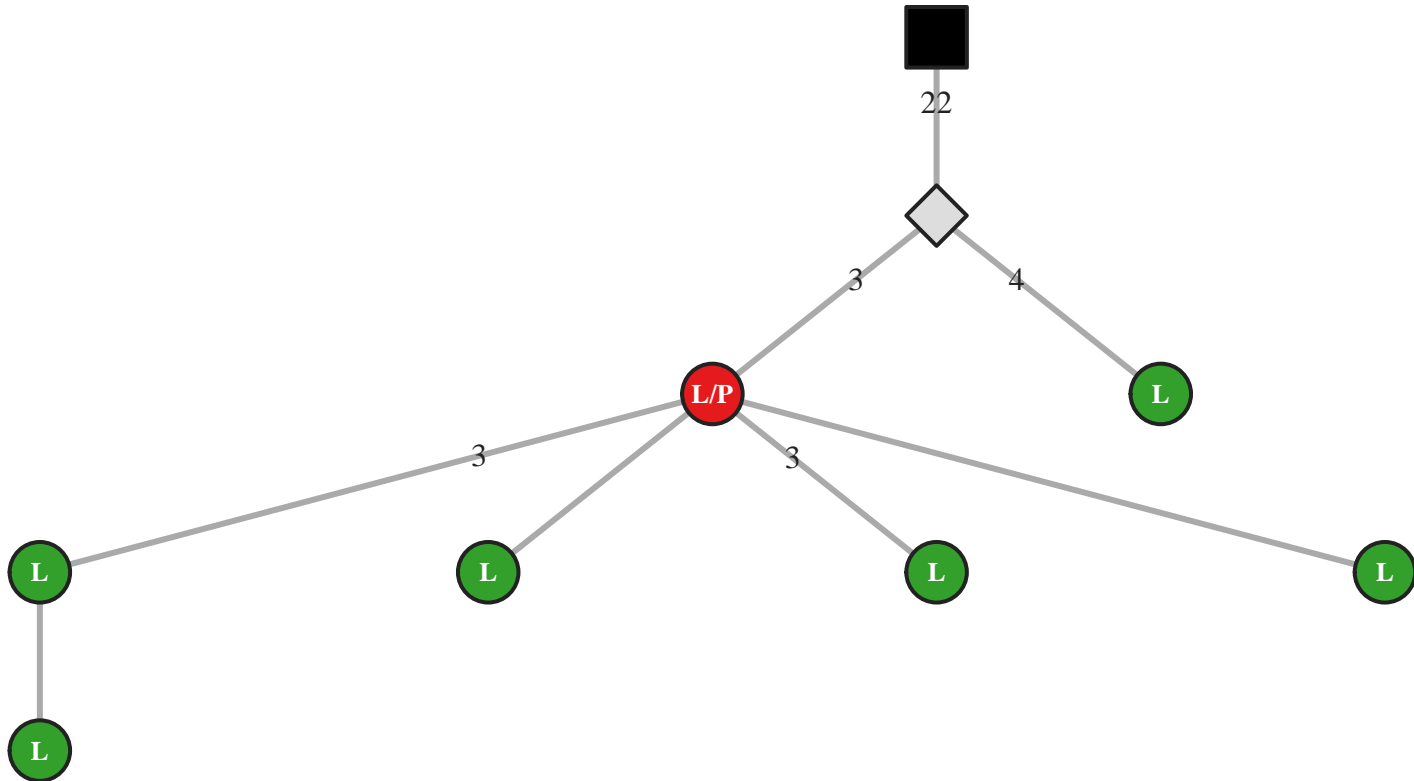

M5 IgG IGHV1-18/J4 36bp (31461)

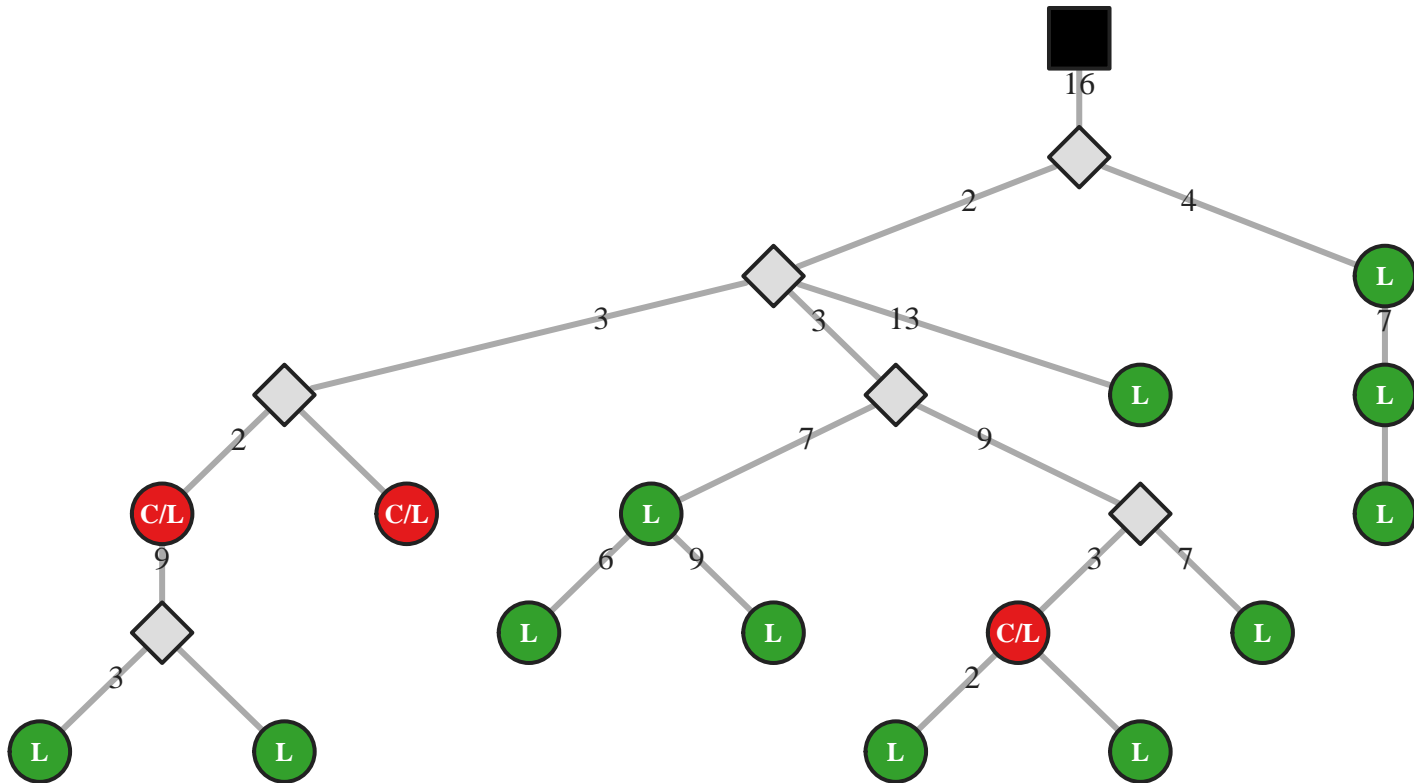

M5 IgG IGHV1-18/J4 36bp (31473)

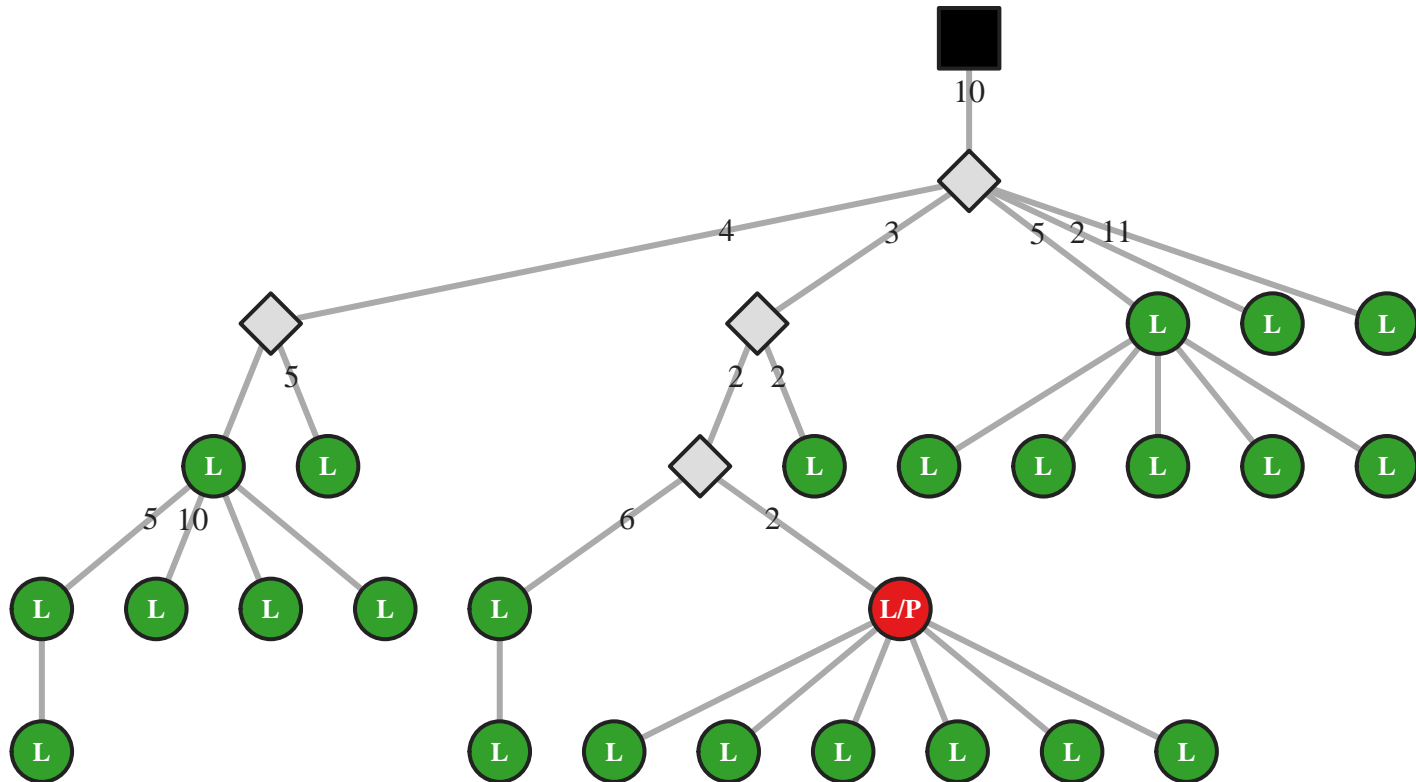

M5 IgA IGHV1-18/J4 39bp (29974)

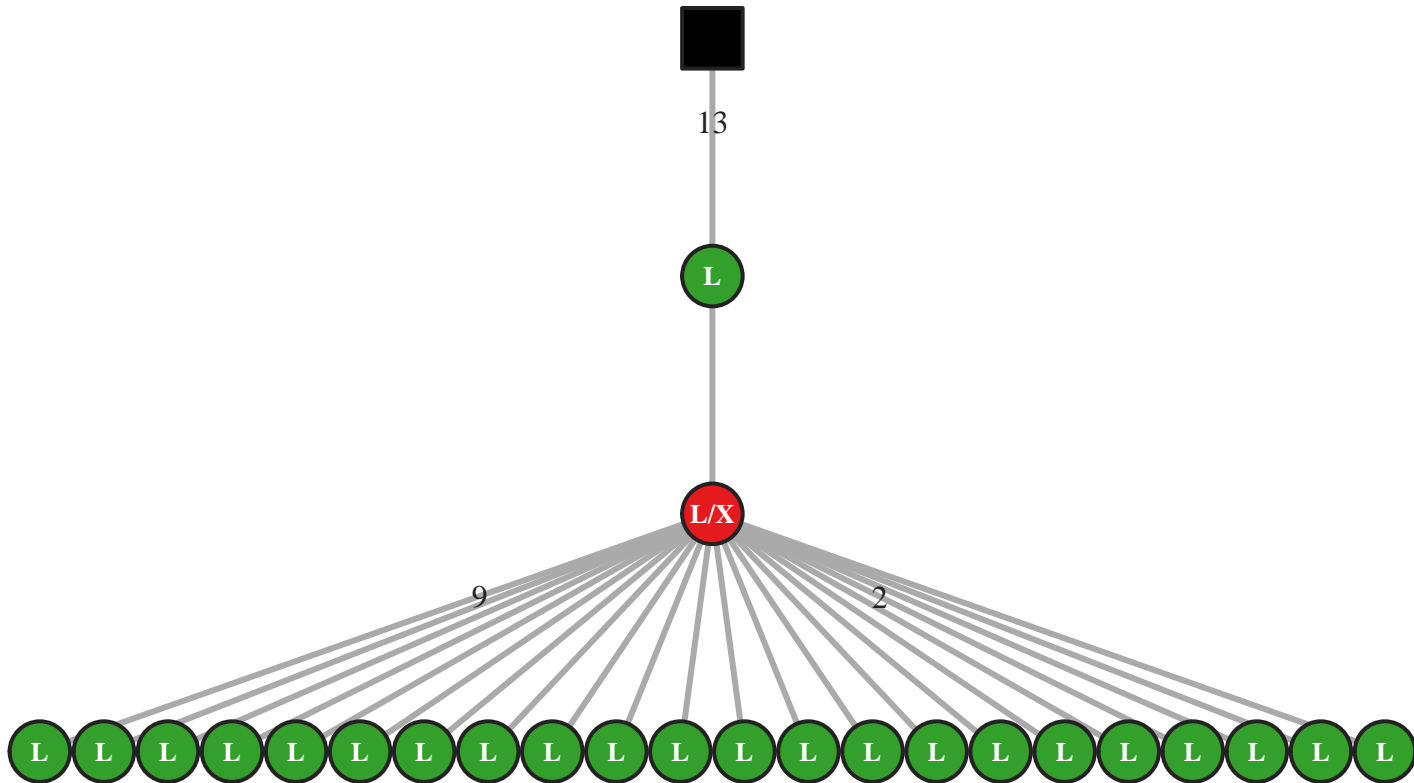

M5 IgG IGHV1-18/J4 39bp (39601)

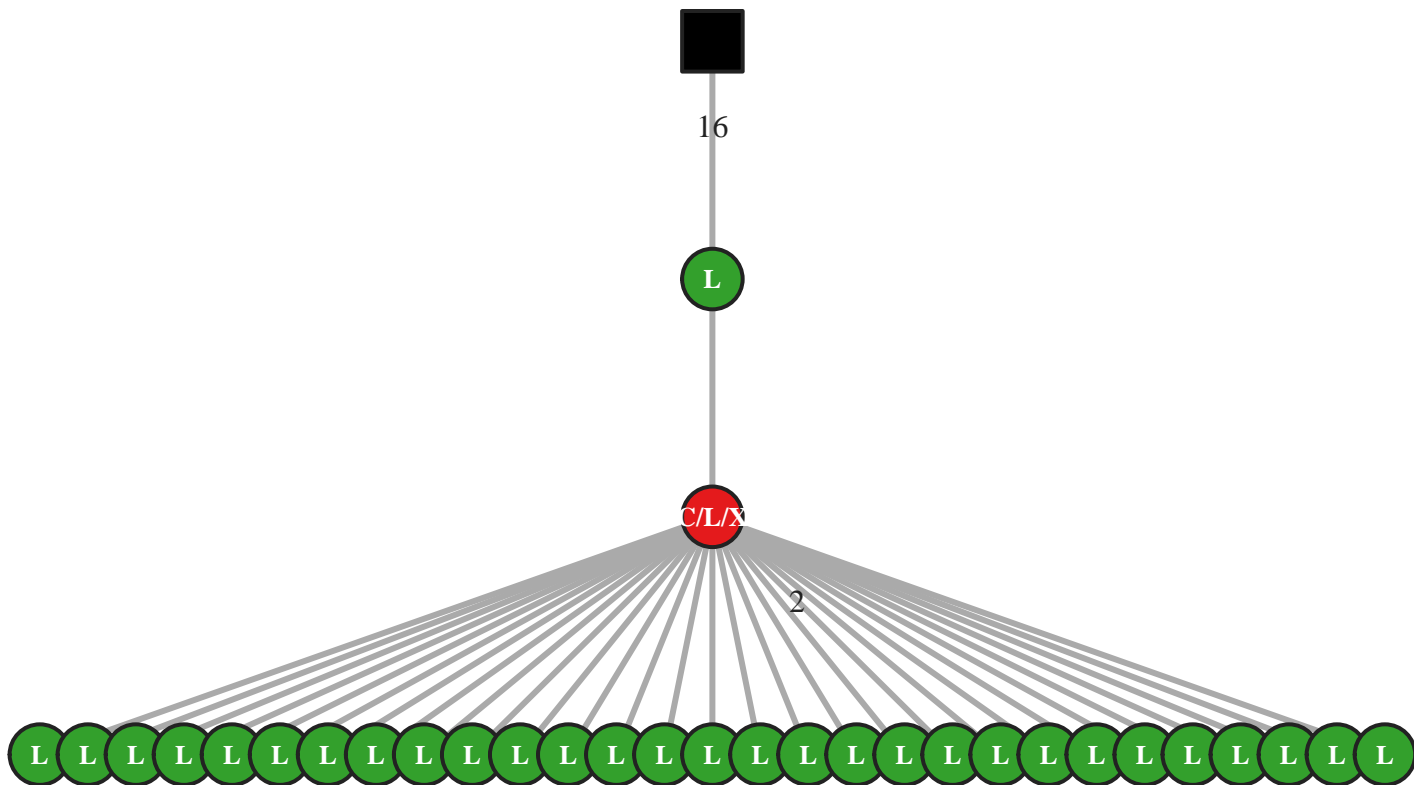

M5 IgG IGHV1-18/J4 39bp (39606)

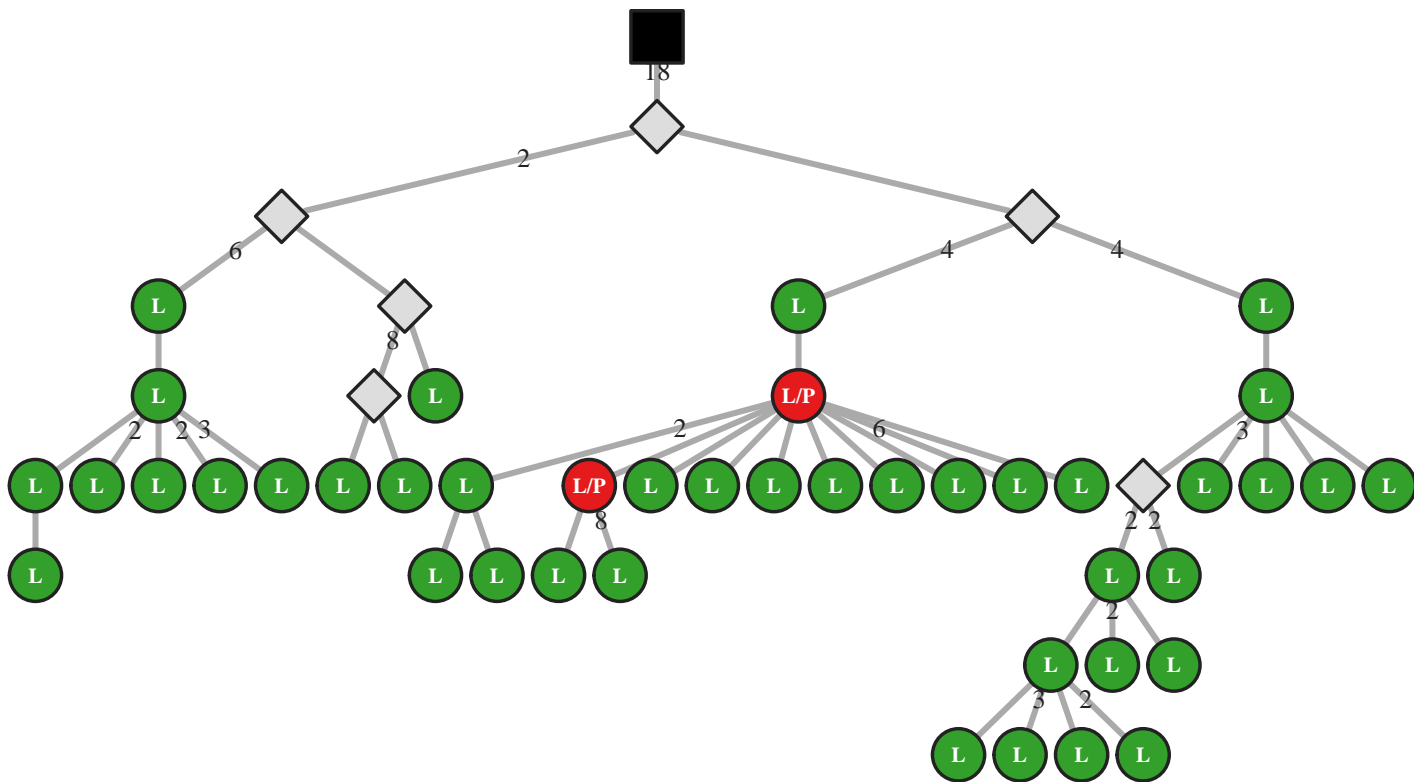

M5 IgG IGHV1-18/J4 39bp (39615)

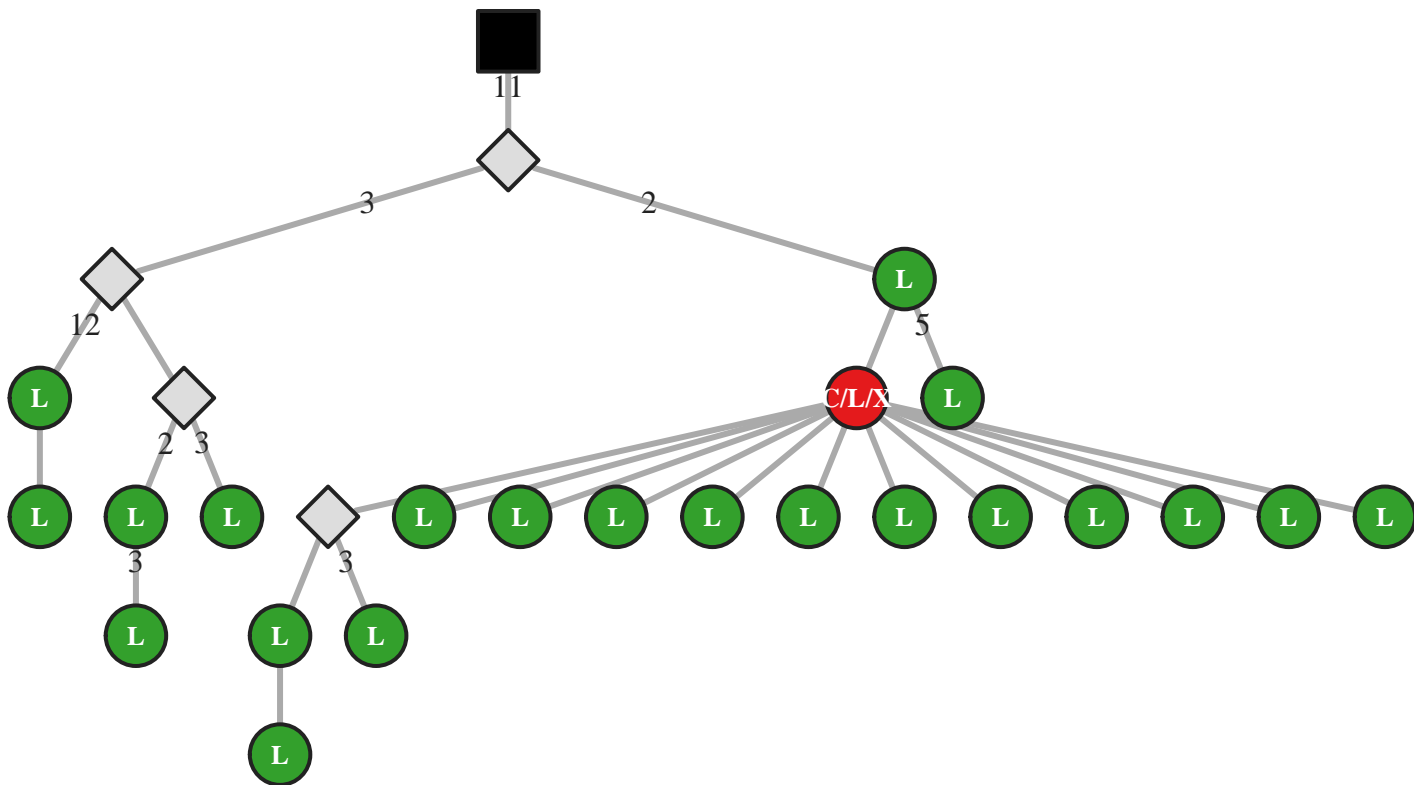

M5 IgG IGHV1-18/J4 39bp (39622)

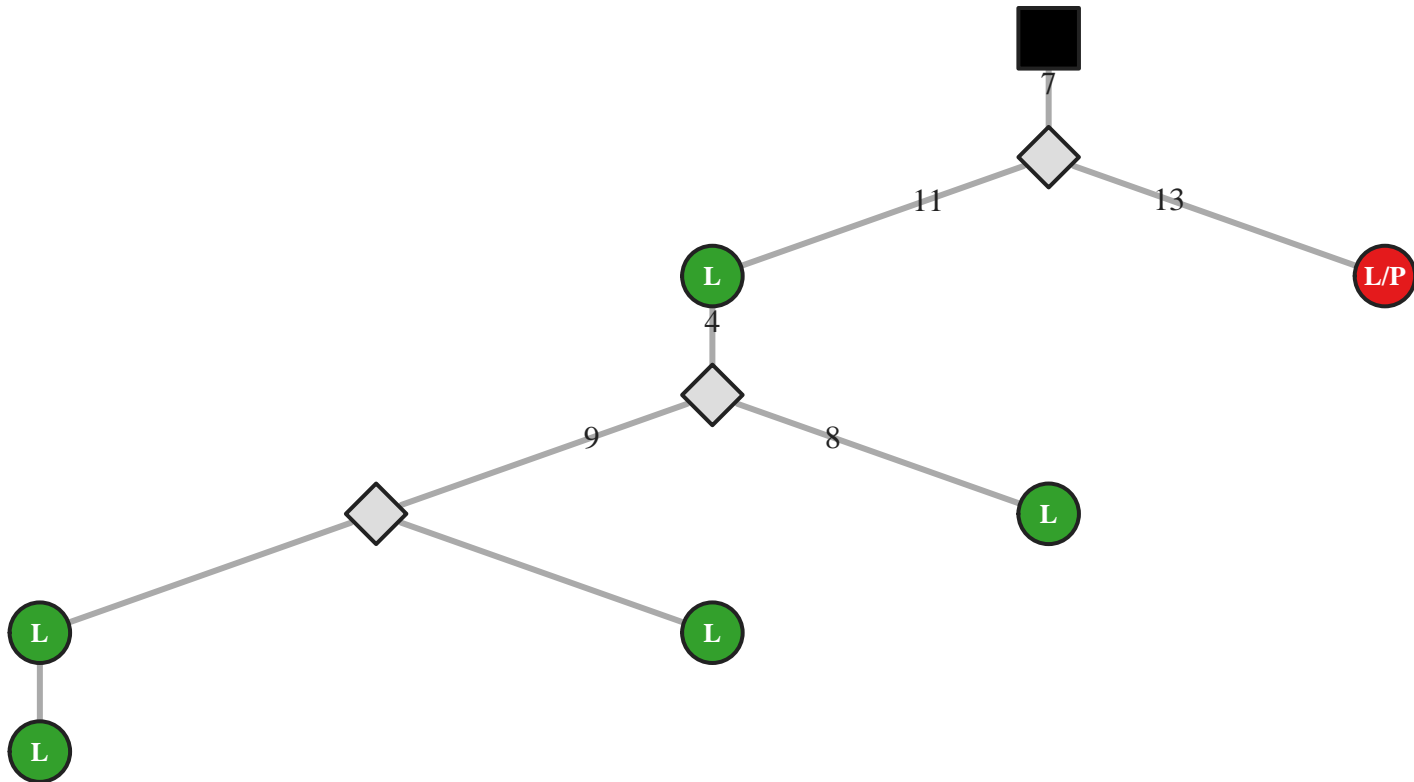

M5 IgG IGHV1-18/J4 39bp (39634)

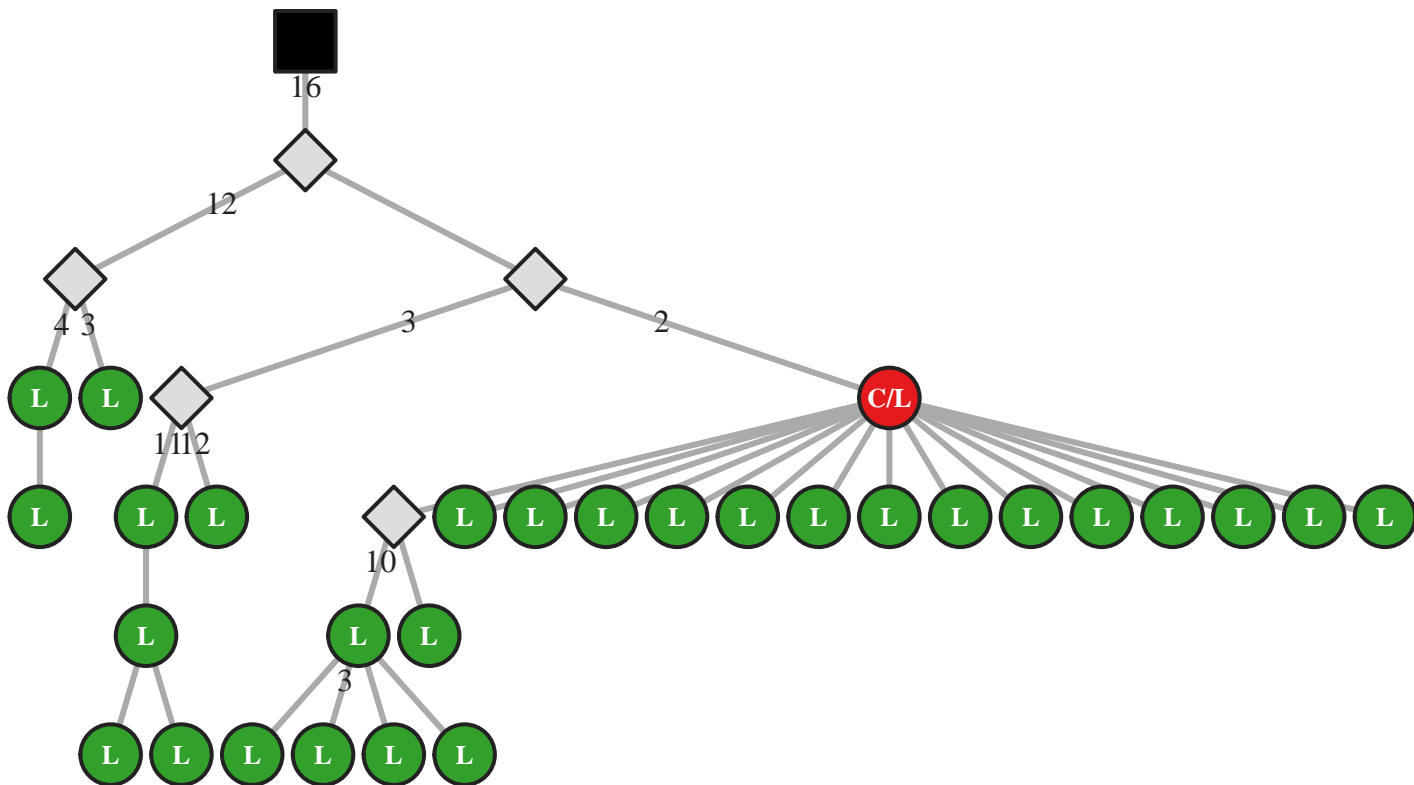

M5 IgA IGHV1-18/J4 42bp (11805)

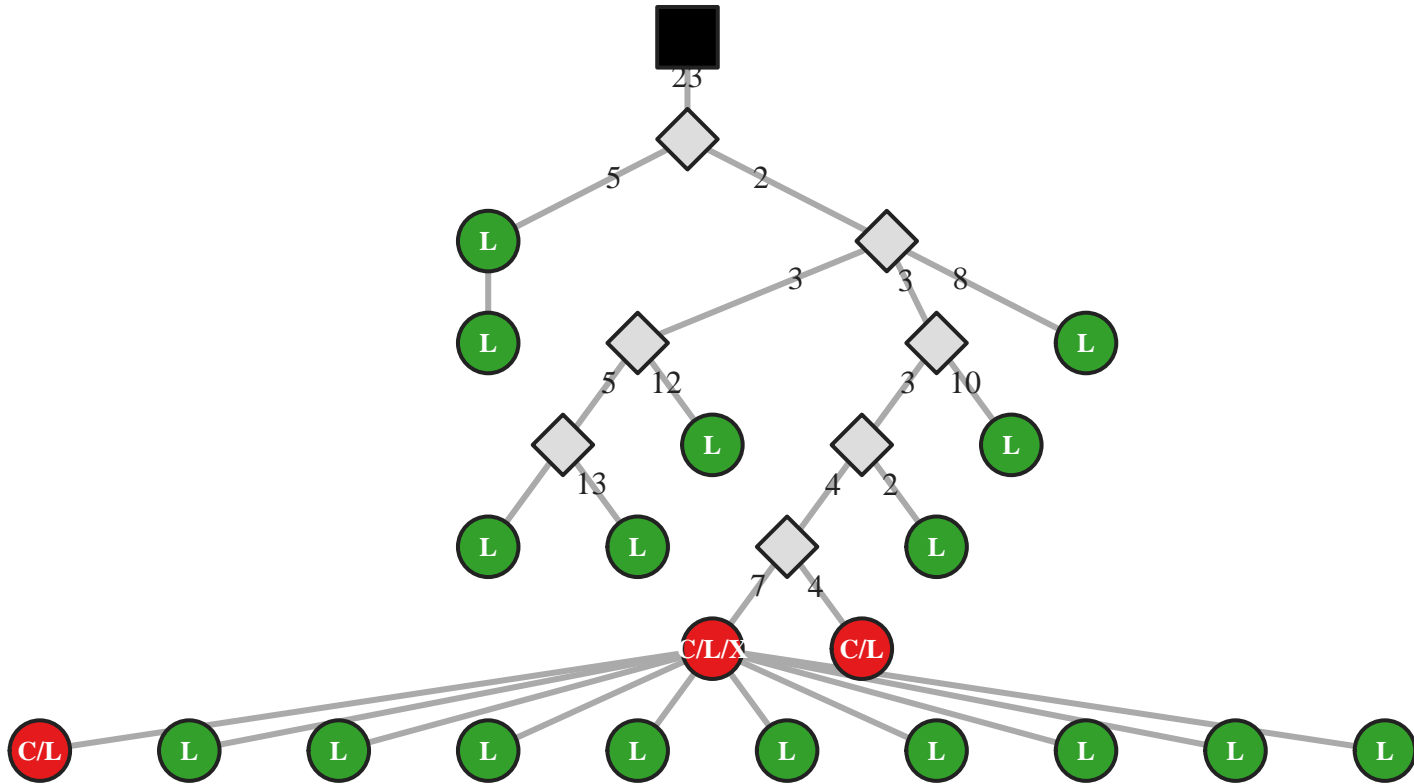

M5 IgG IGHV1-18/J4 42bp (31481)

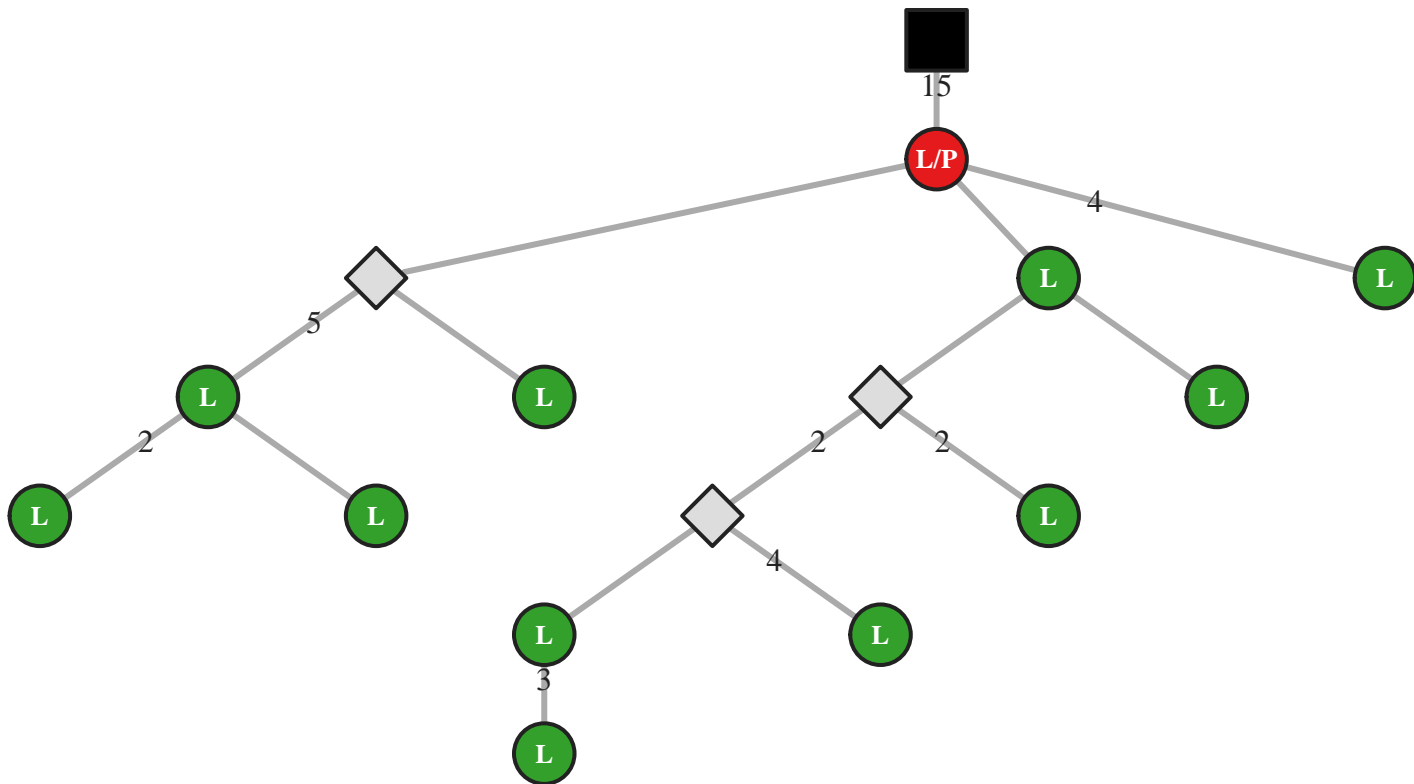

M5 IgG IGHV1-18/J4 42bp (31549)

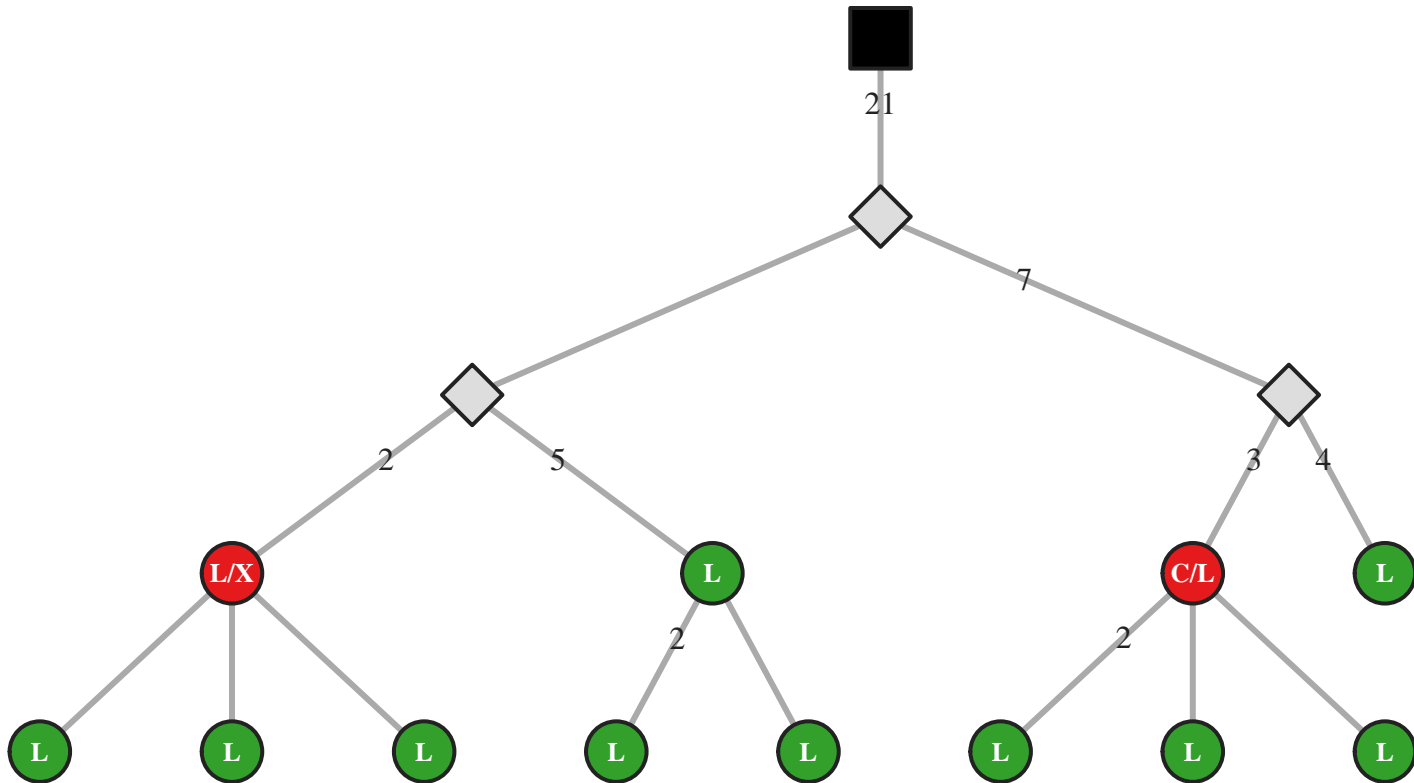

M5 IgG IGHV1-18/J4 45bp (3687)

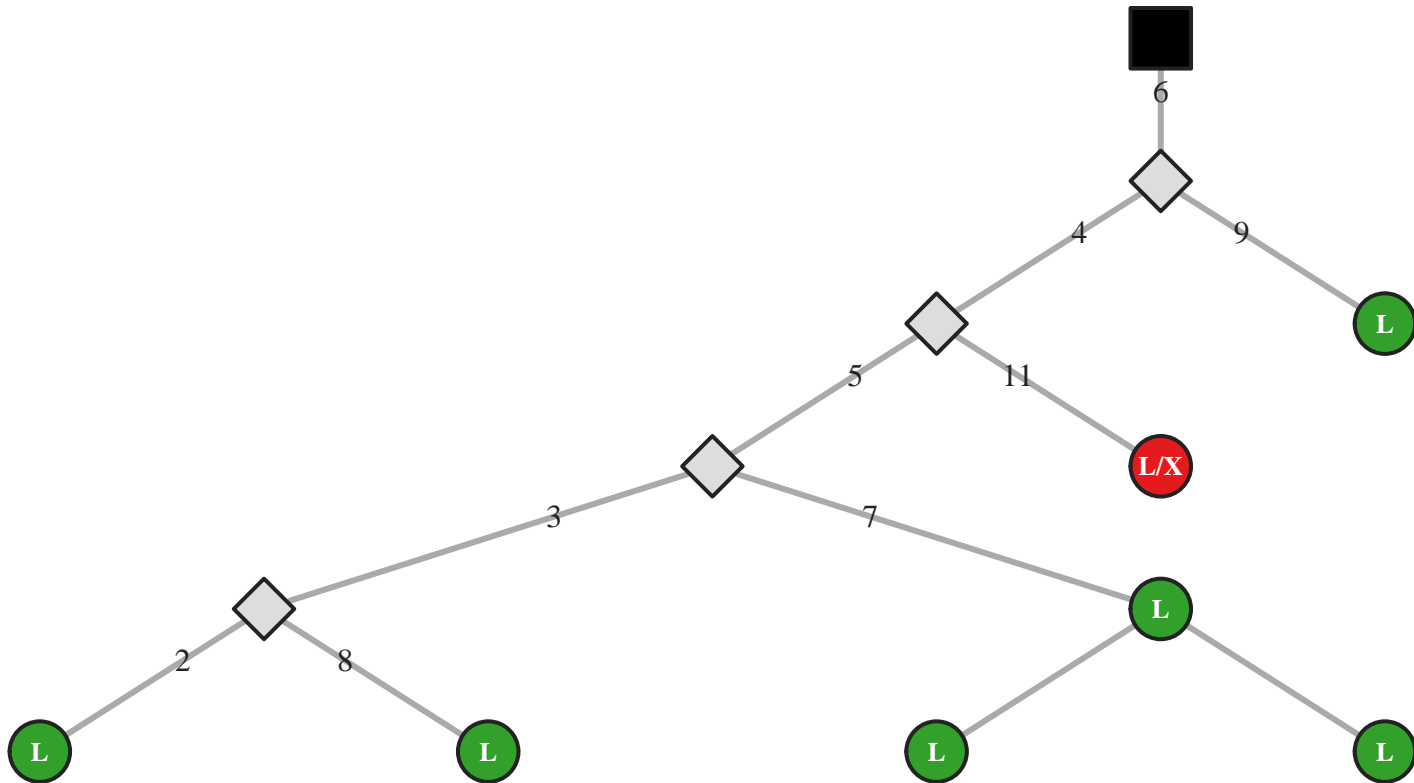

M5 IgG IGHV1-18/J4 45bp (3688)

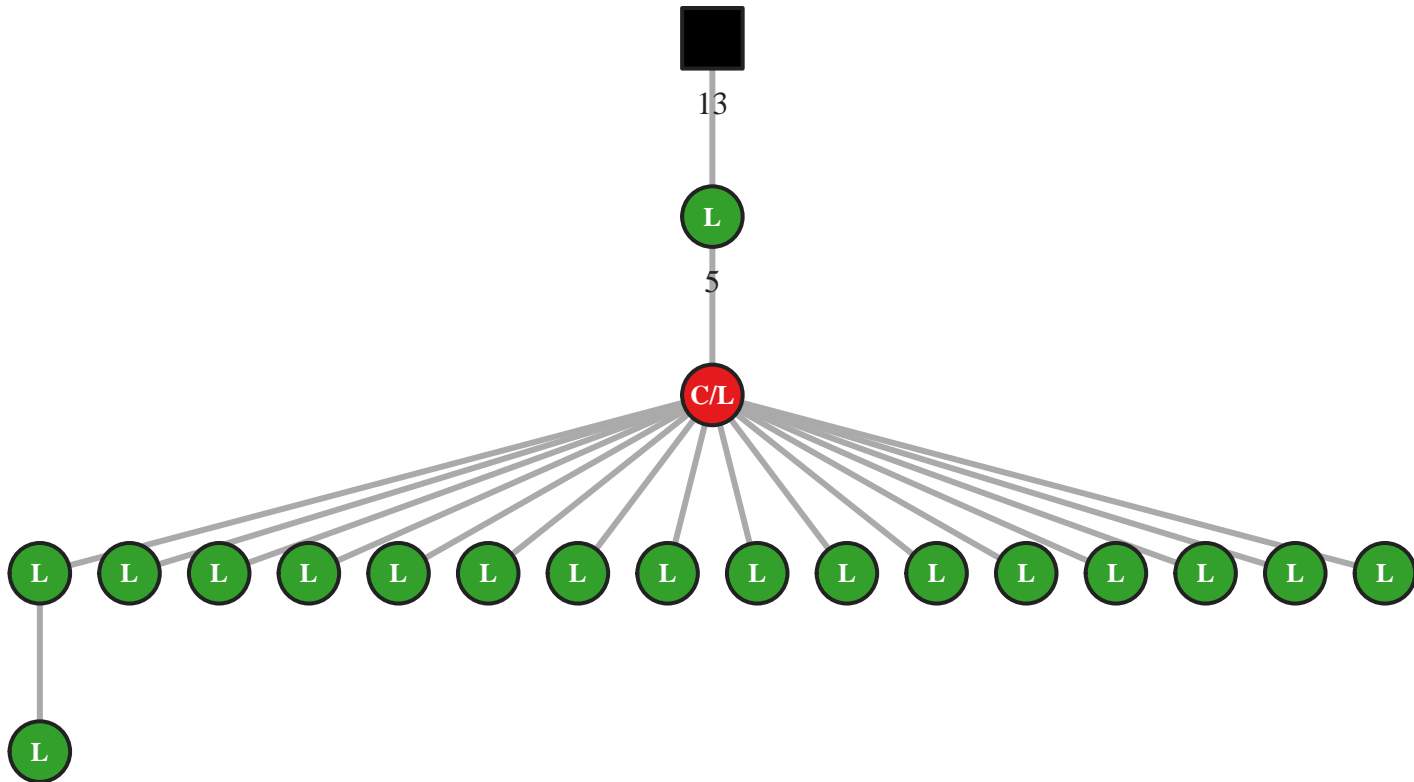

M5 IgG IGHV1-18/J4 45bp (3710)

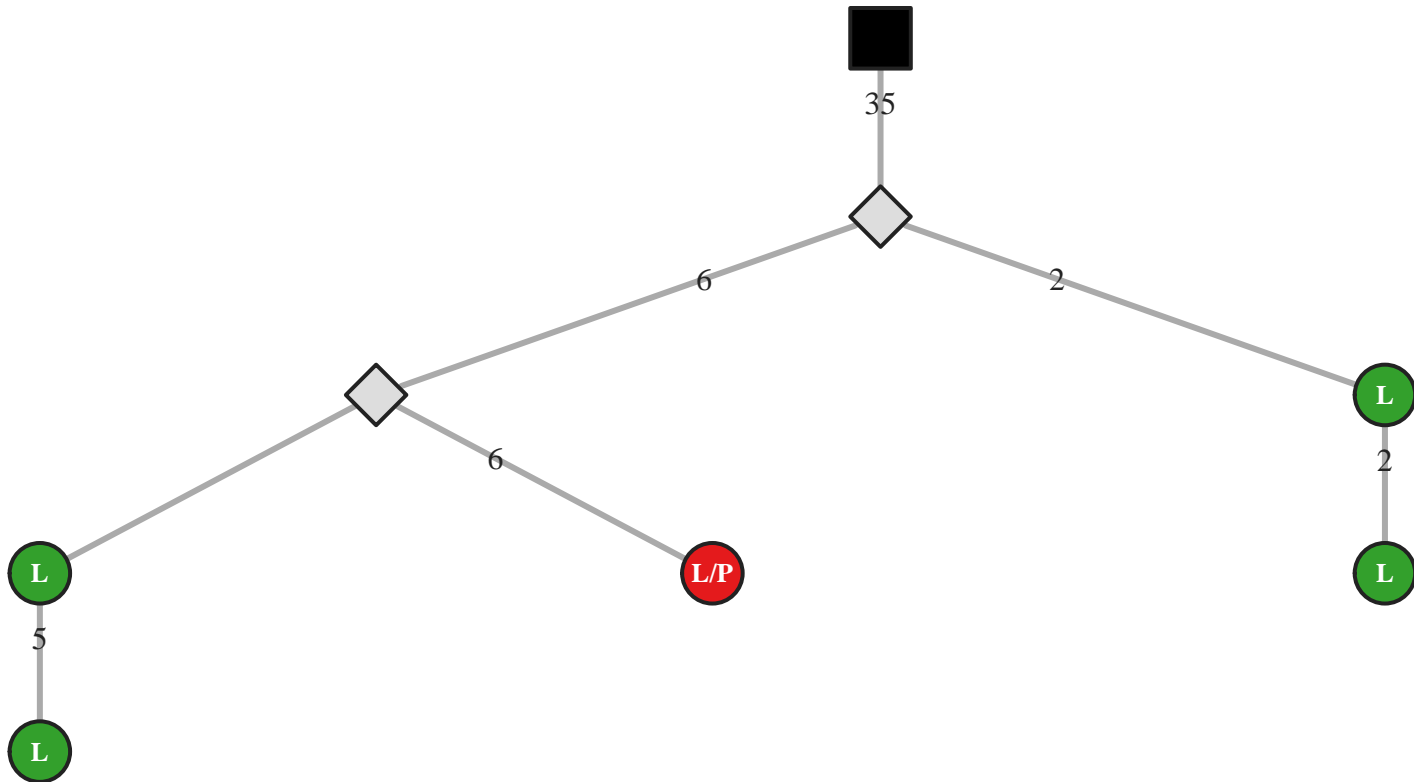

M5 IgG IGHV1-18/J4 45bp (3712)

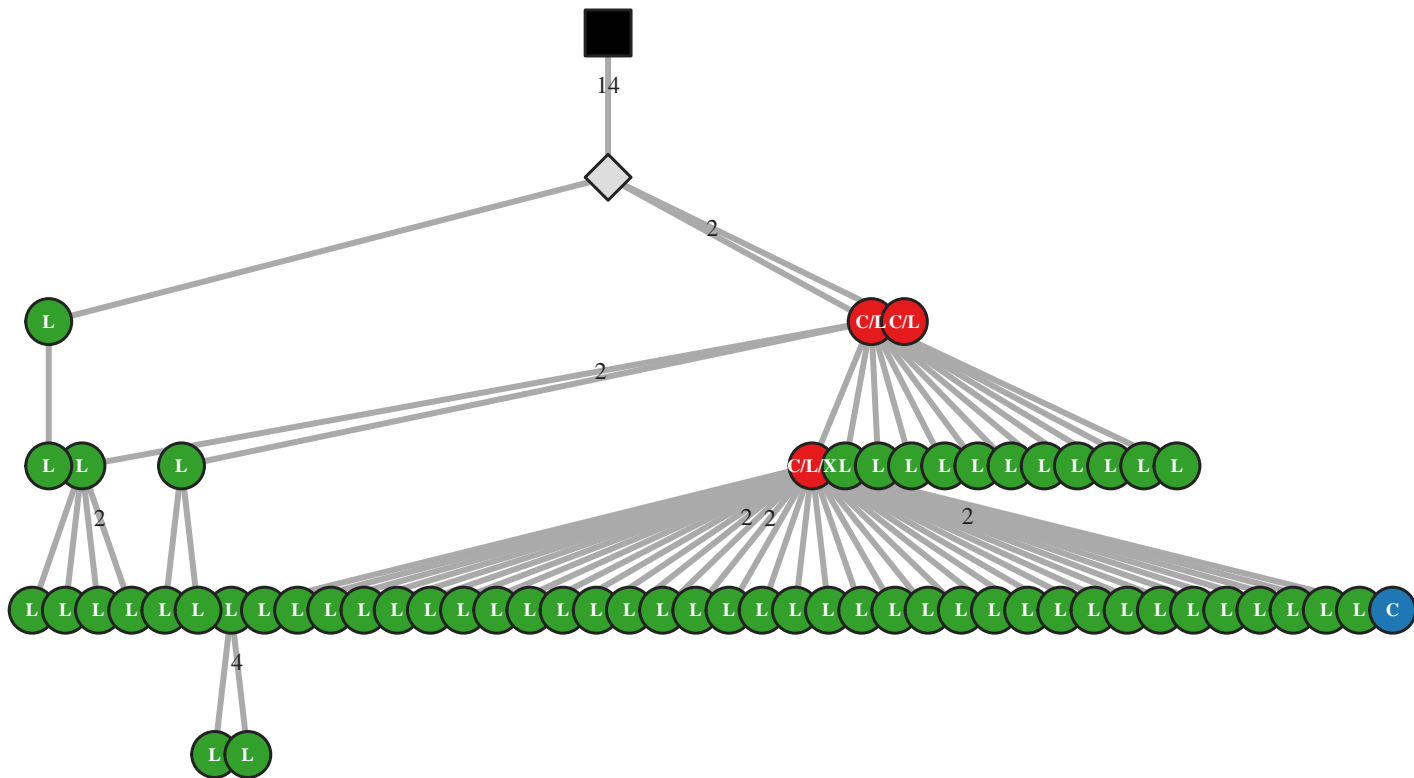

M5 IgA IGHV1-18/J4 48bp (48306)

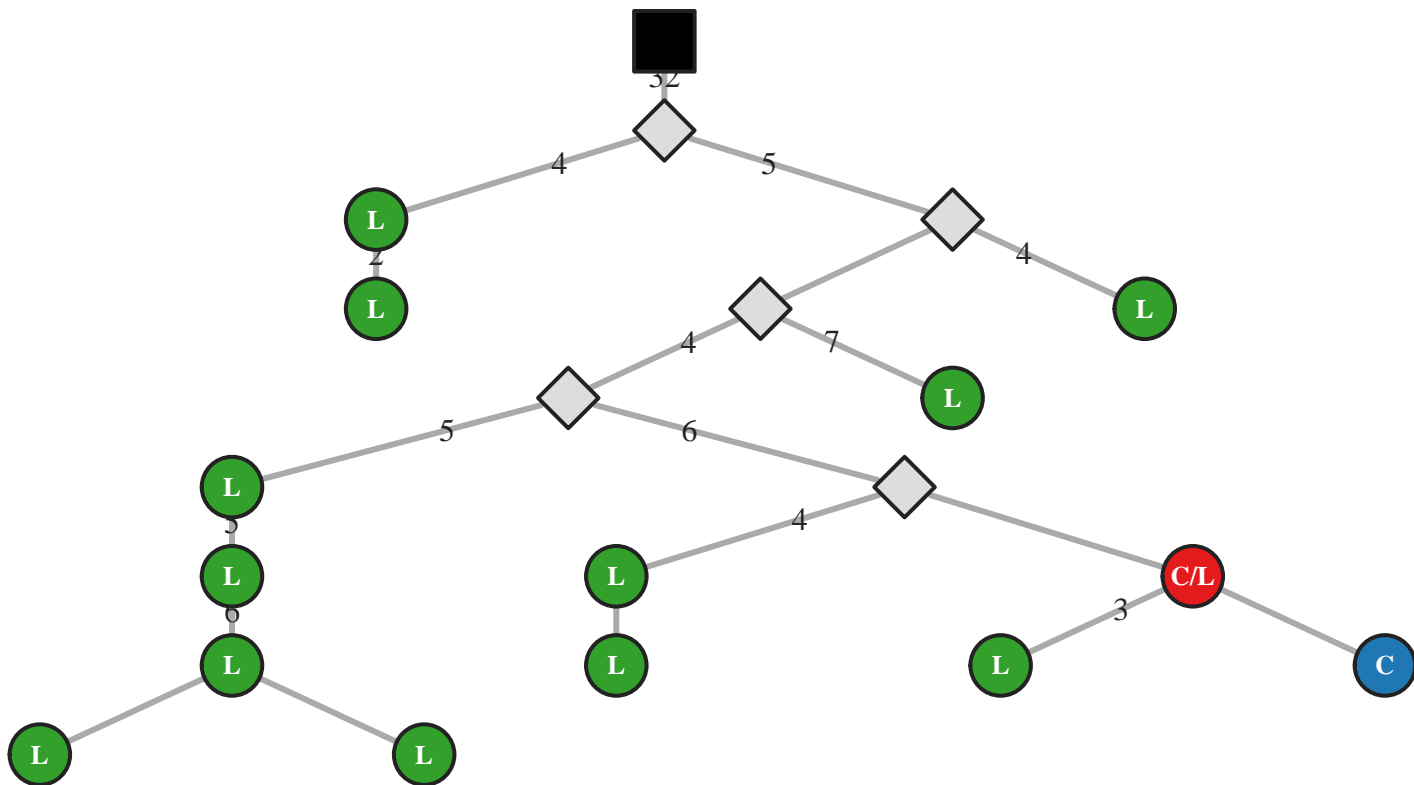

M5 IgA IGHV1-18/J4 48bp (48308)

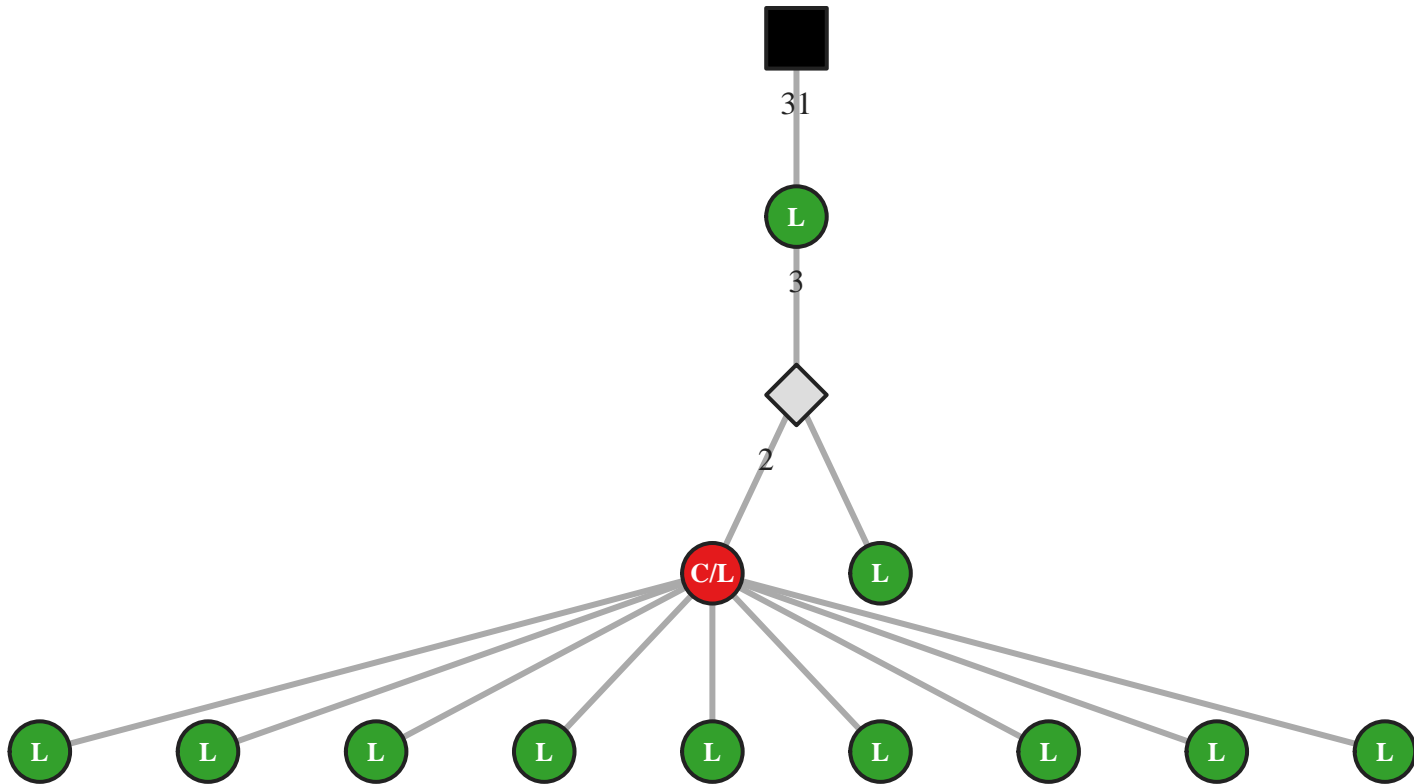

M5 IgG IGHV1-18/J4 48bp (3827)

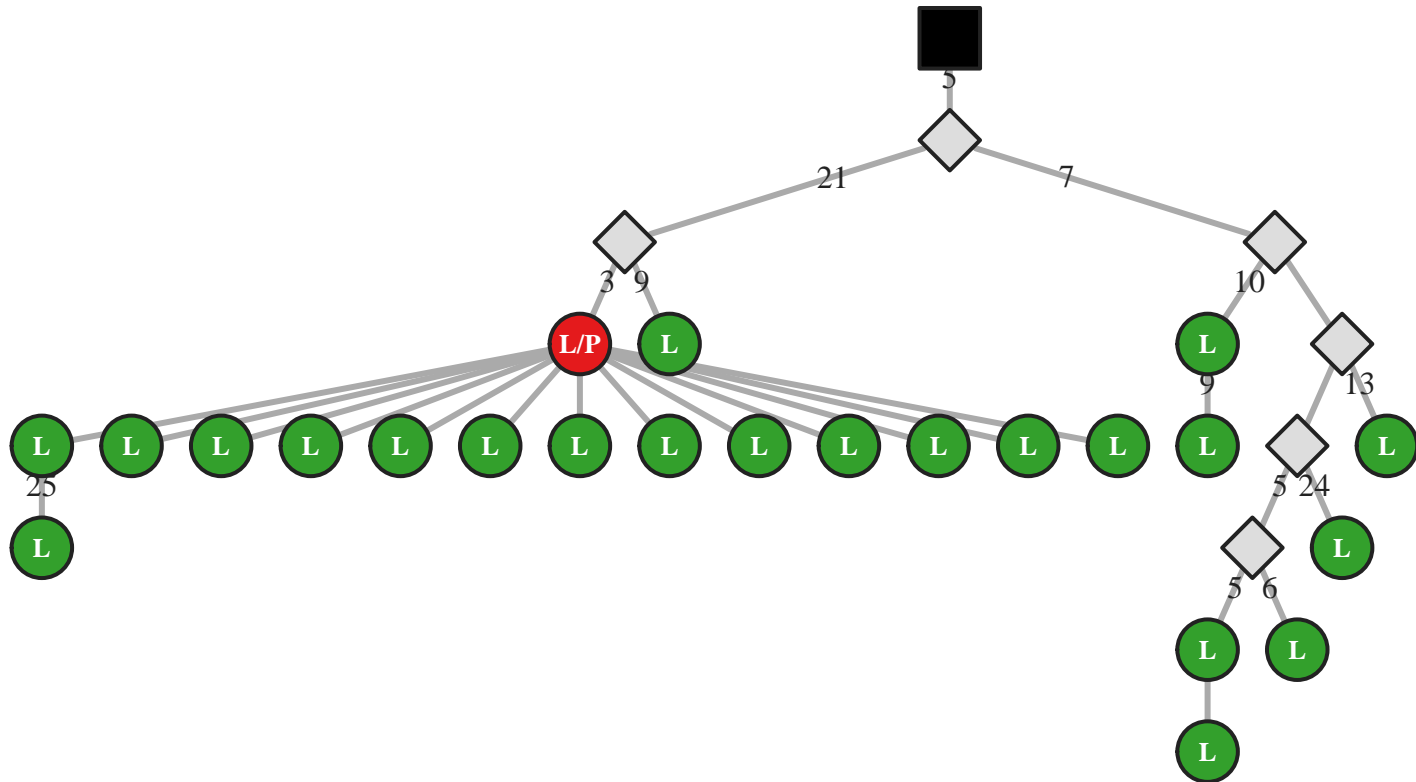

M5 IgA IGHV1-18/J4 51bp (48333)

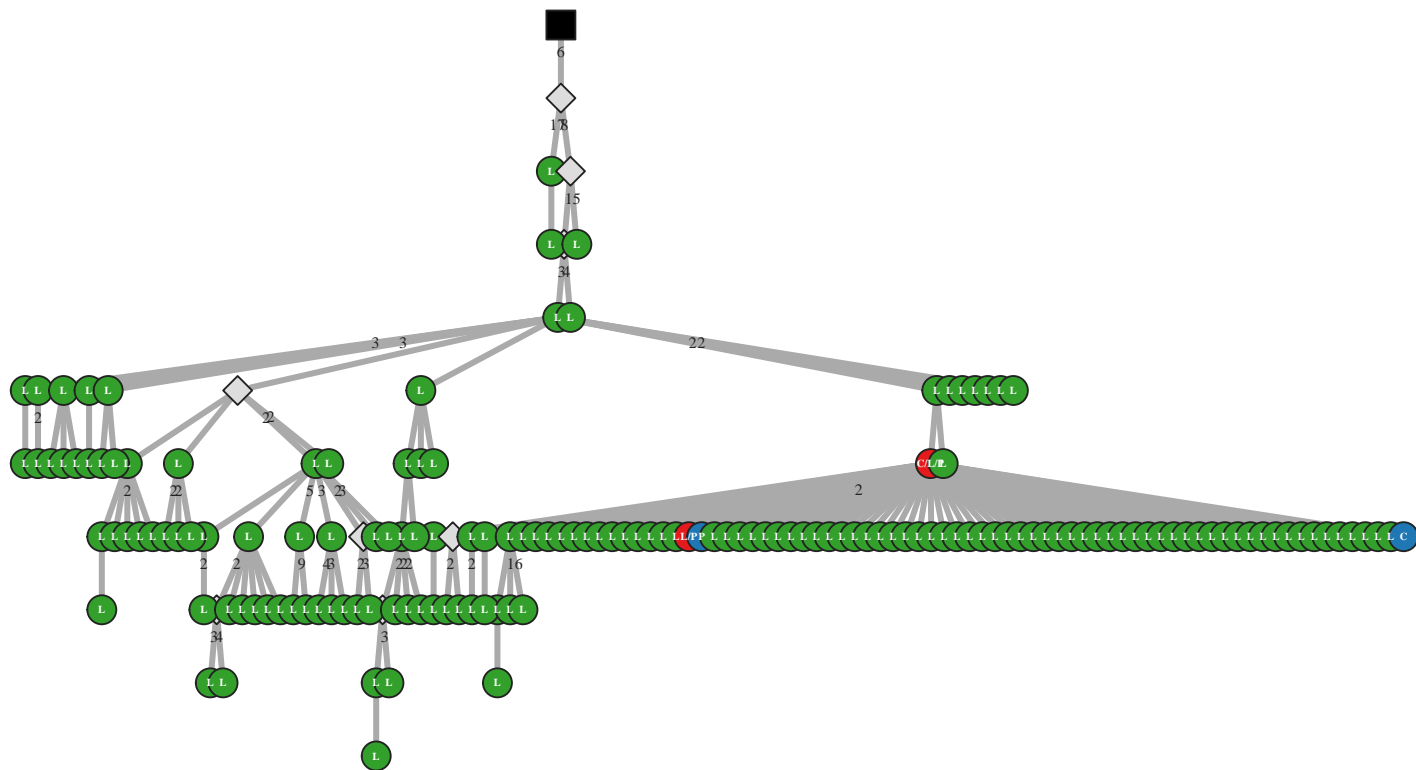

M5 IgG IGHV1-18/J4 51bp (22712)

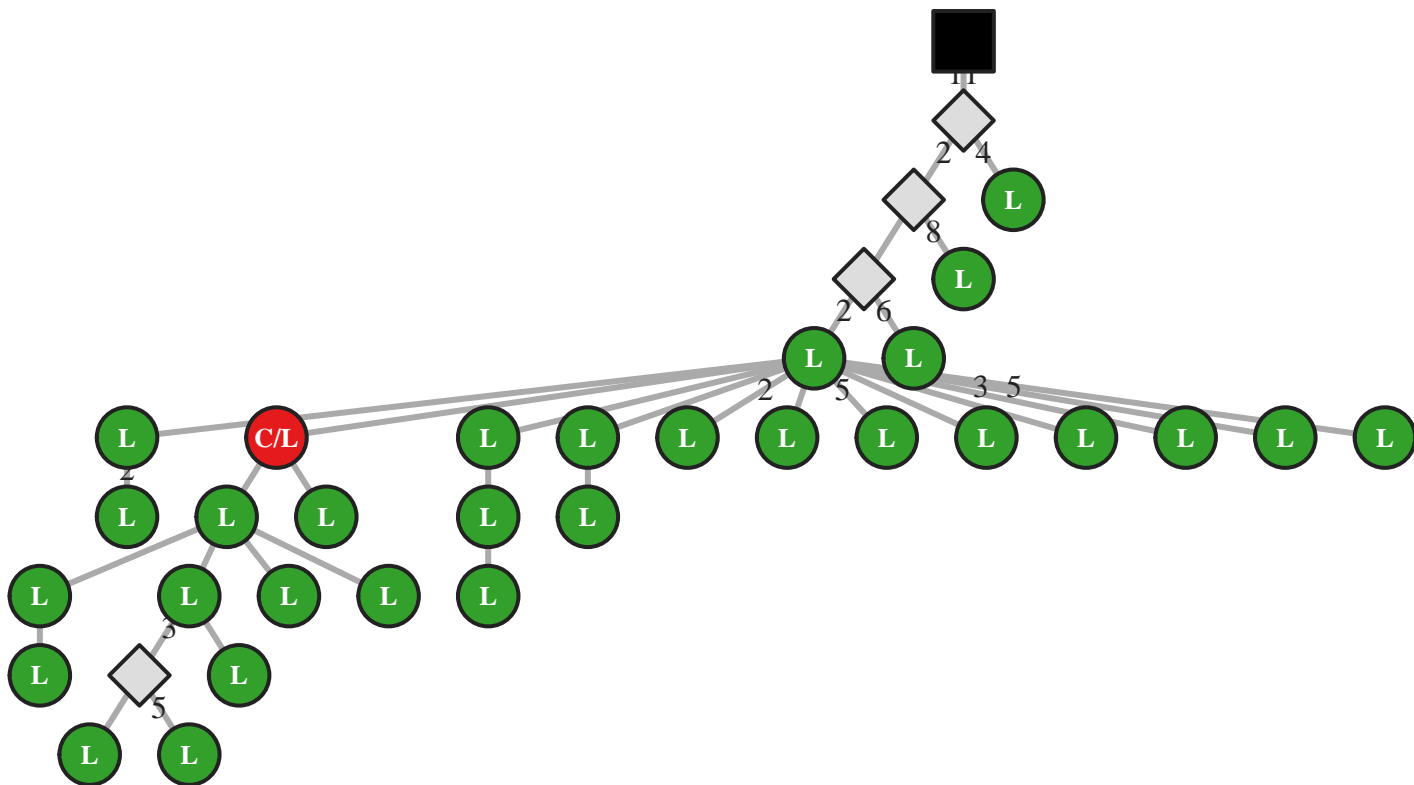

M5 IgG IGHV1-18/J4 51bp (22735)

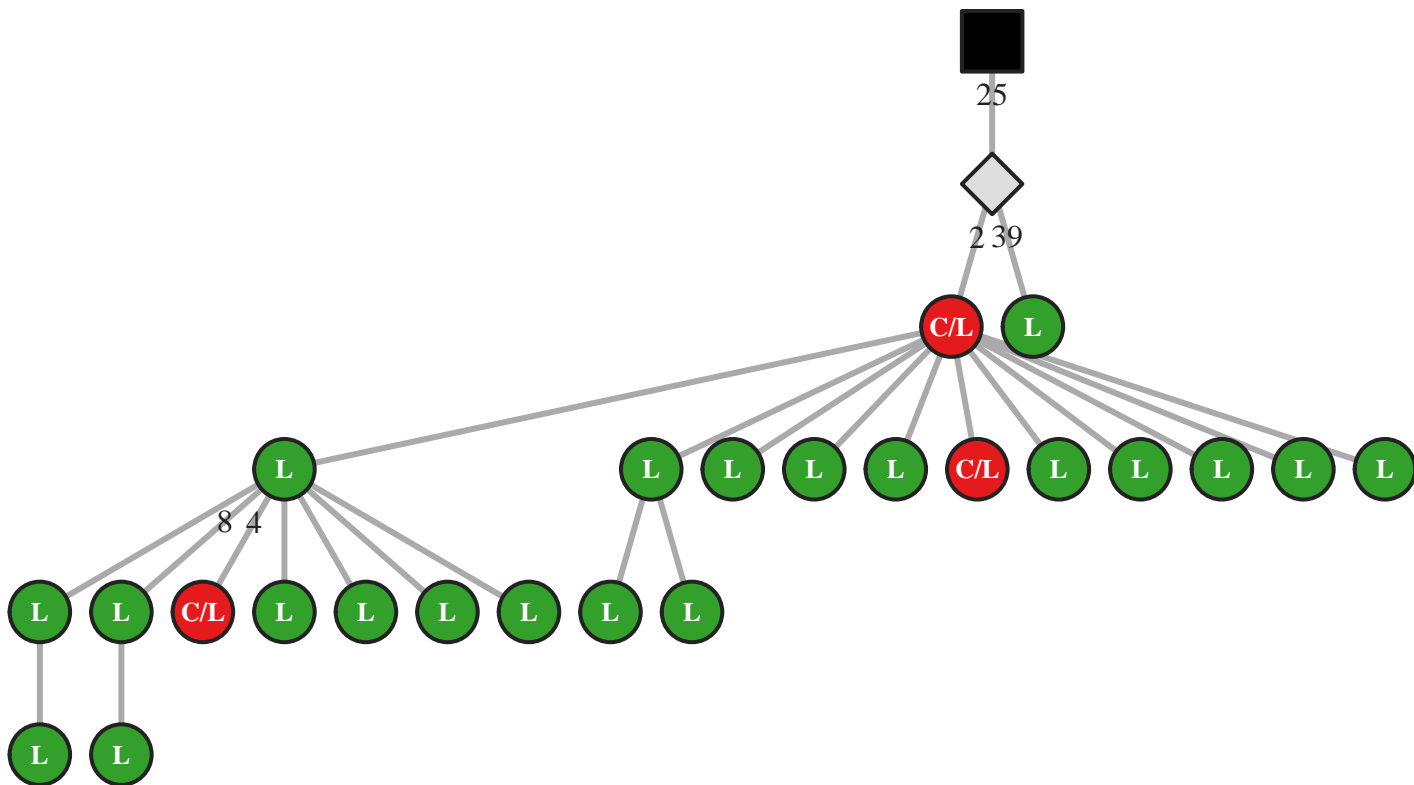

M5 IgG IGHV1-18/J4 51bp (22739)

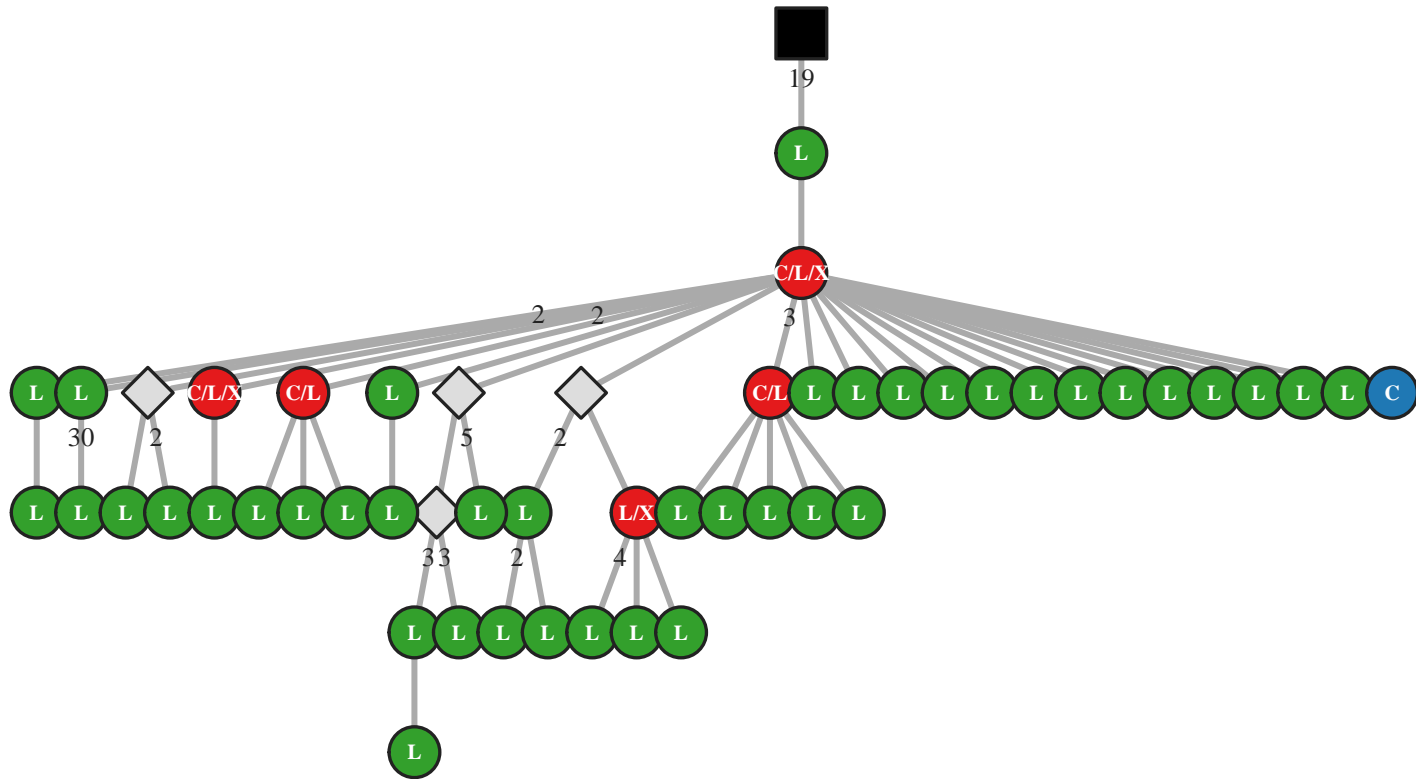

M5 IgG IGHV1-18/J4 51bp (22740)

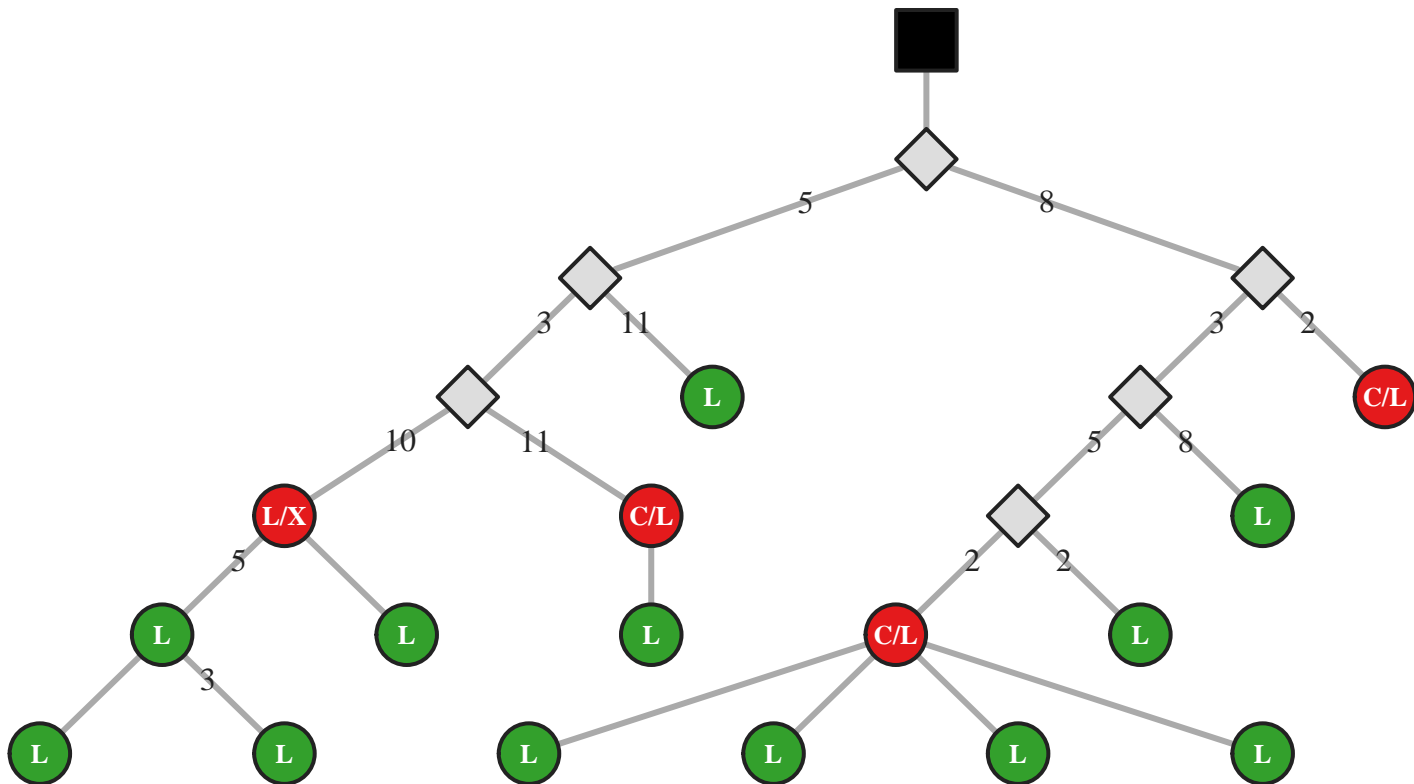

M5 IgG IGHV1-18/J4 51bp (22781)

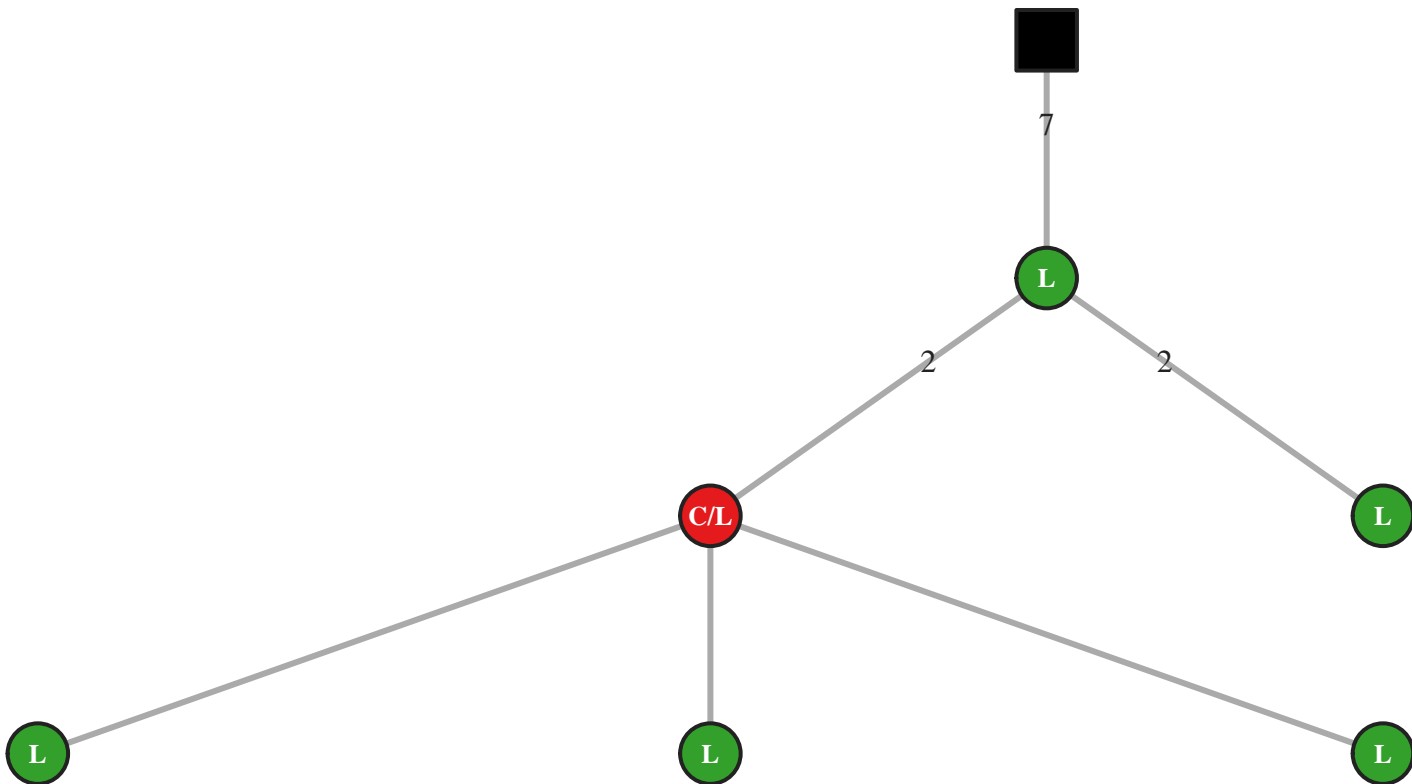

M5 IgG IGHV1-18/J4 54bp (3888)

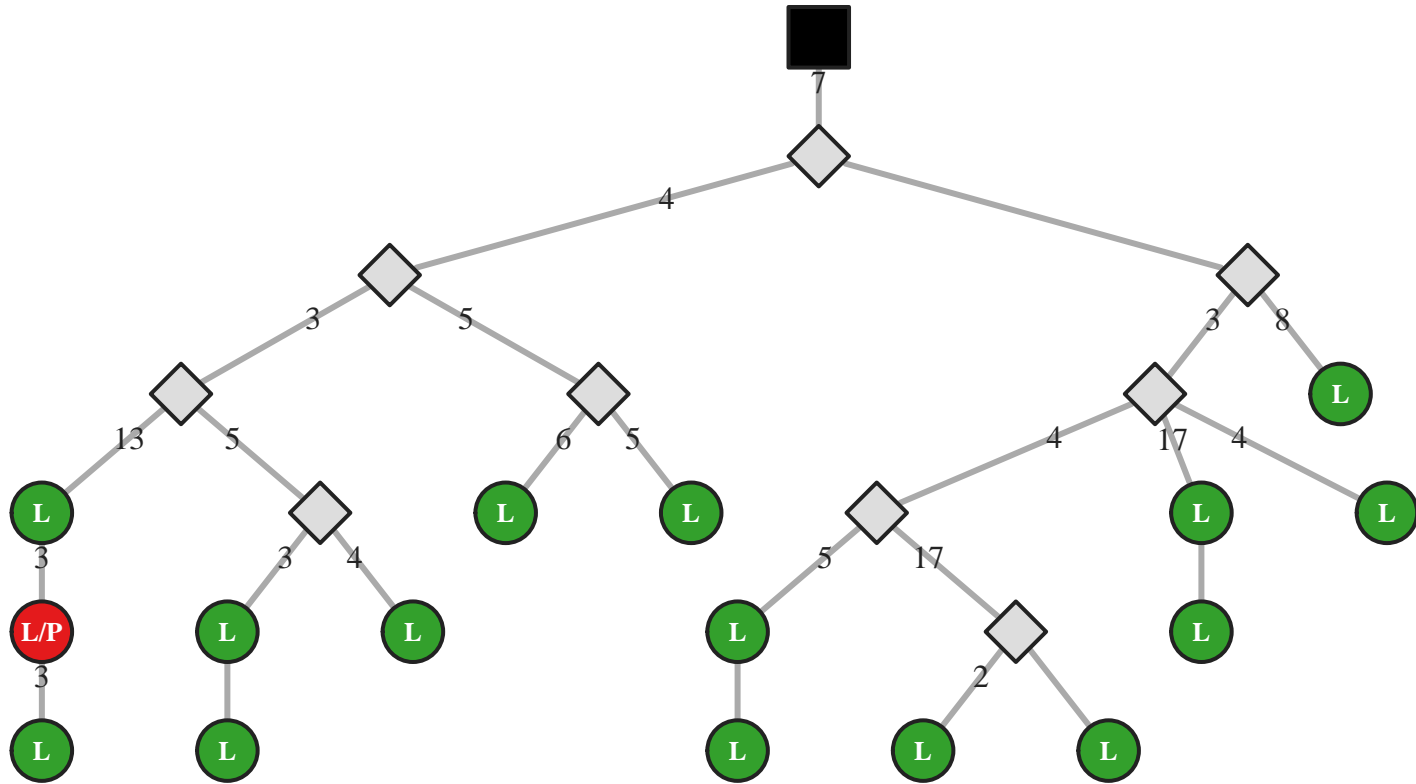

M5 IgG IGHV1-18/J4 54bp (3935)

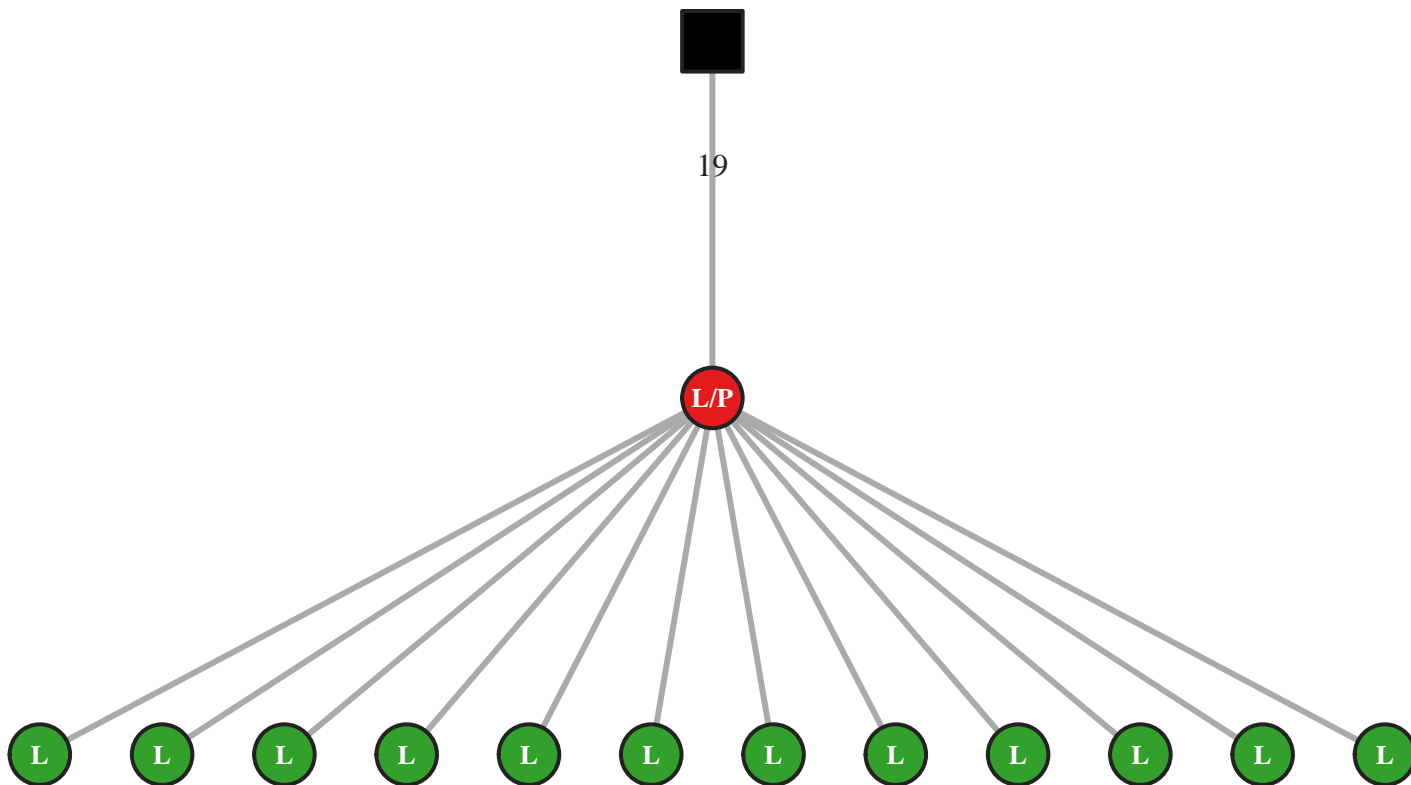

M5 IgG IGHV1-18/J4 57bp (3998)

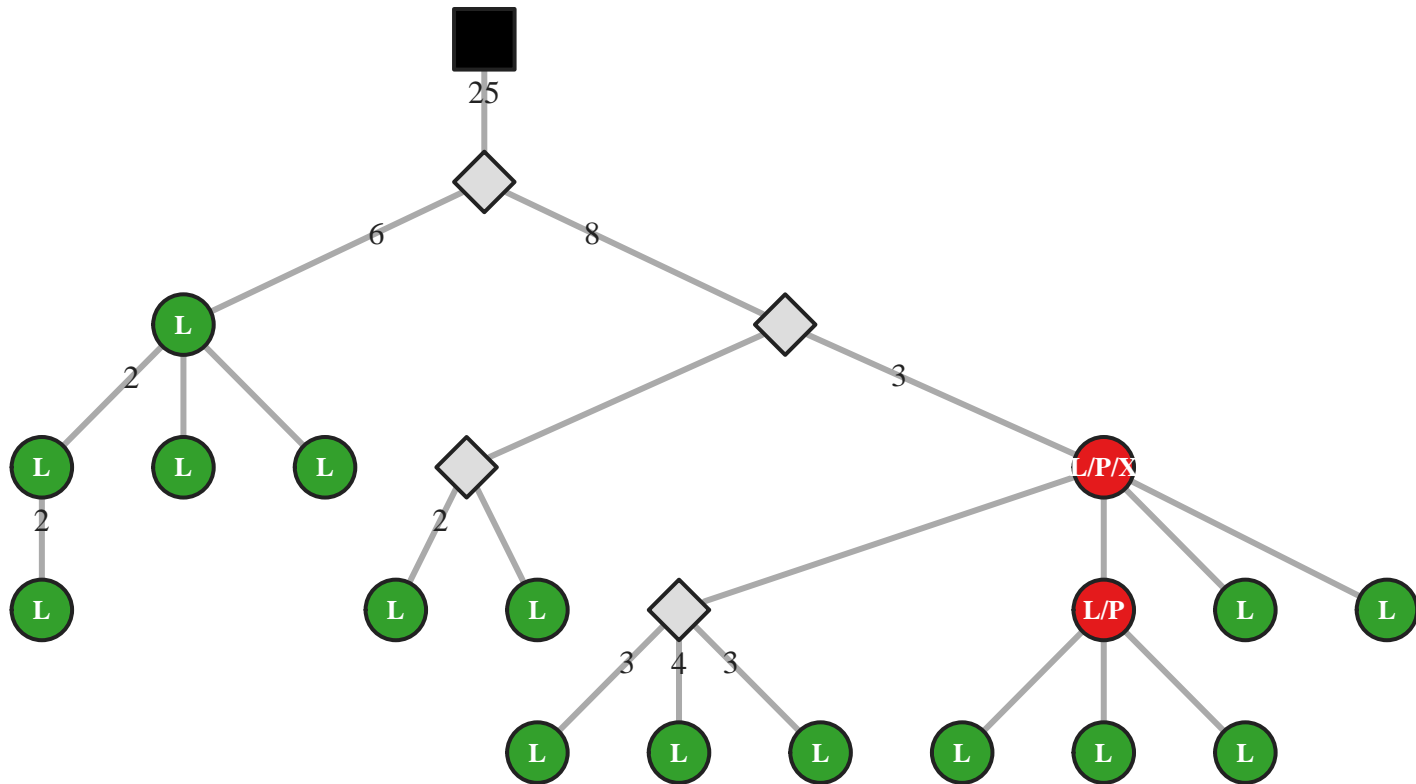

M5 IgG IGHV1-18/J4 57bp (4034)

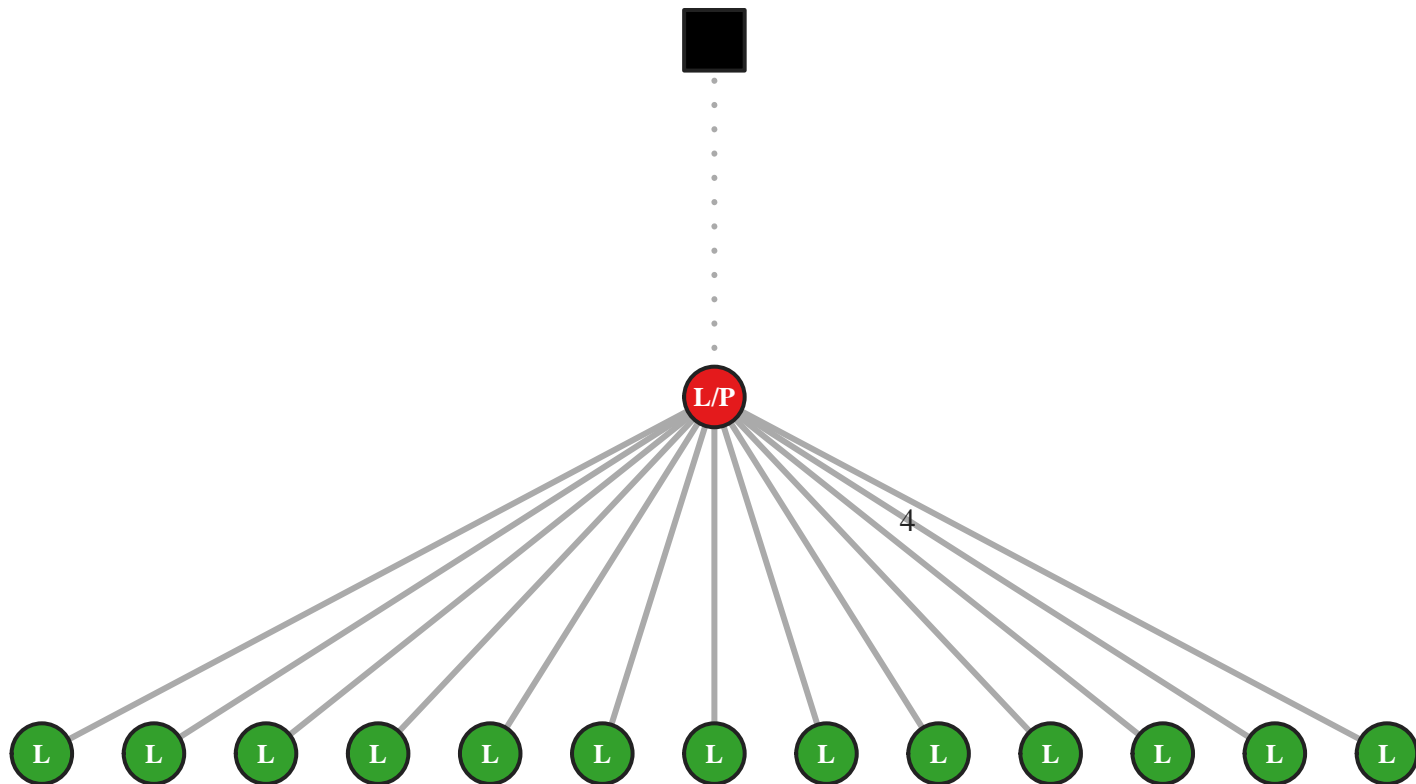

M5 IgG IGHV1-18/J4 63bp (31591)

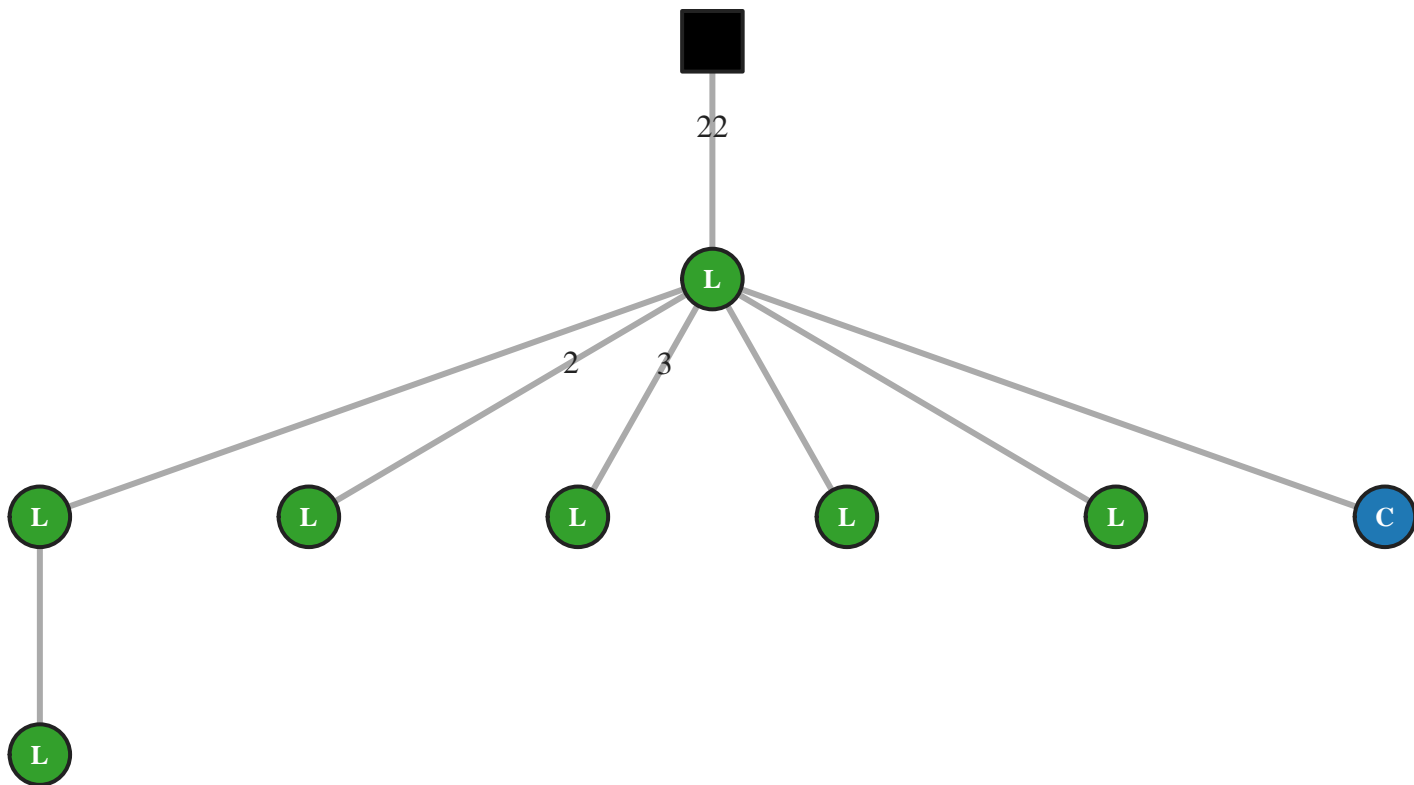

M5 IgG IGHV1-18/J4 63bp (31620)

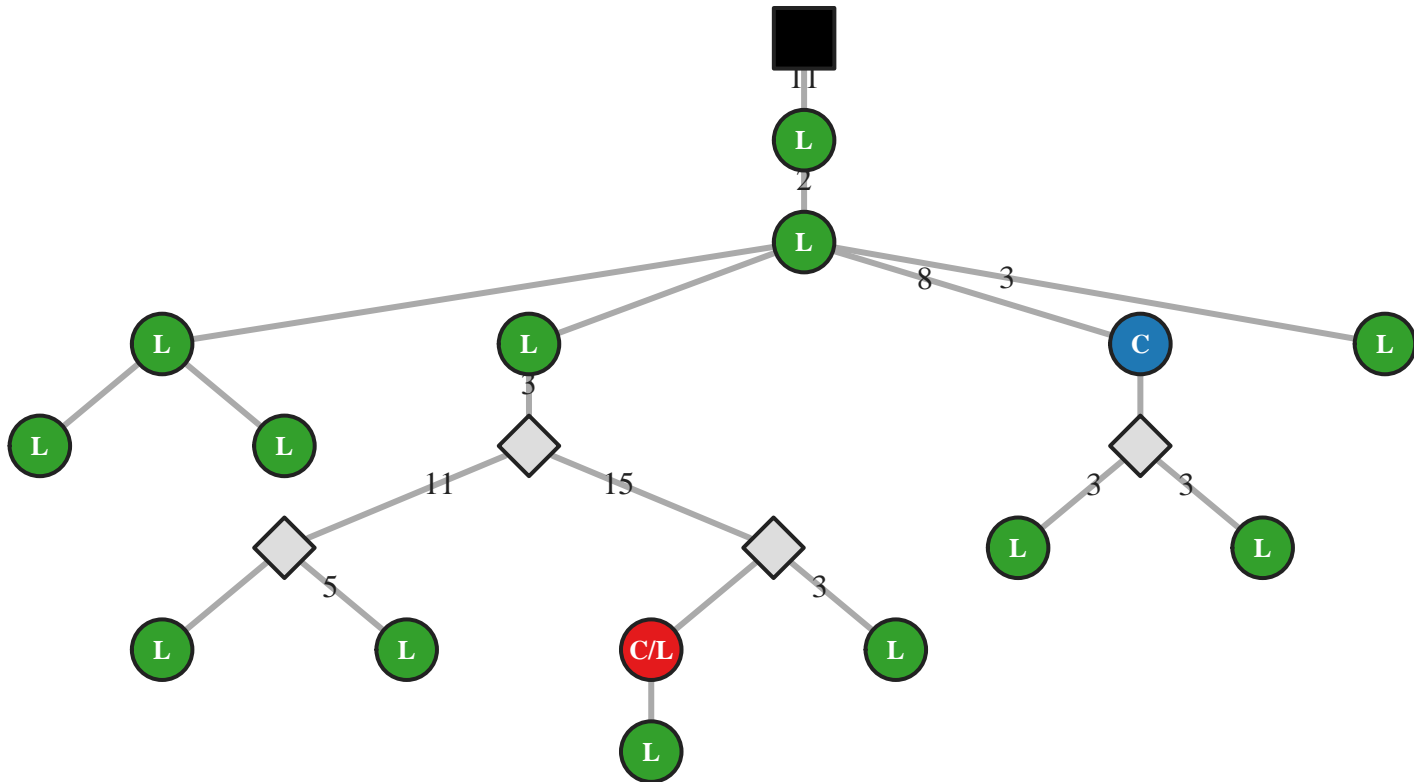

M5 IgG IGHV1-18/J5 27bp (22807)

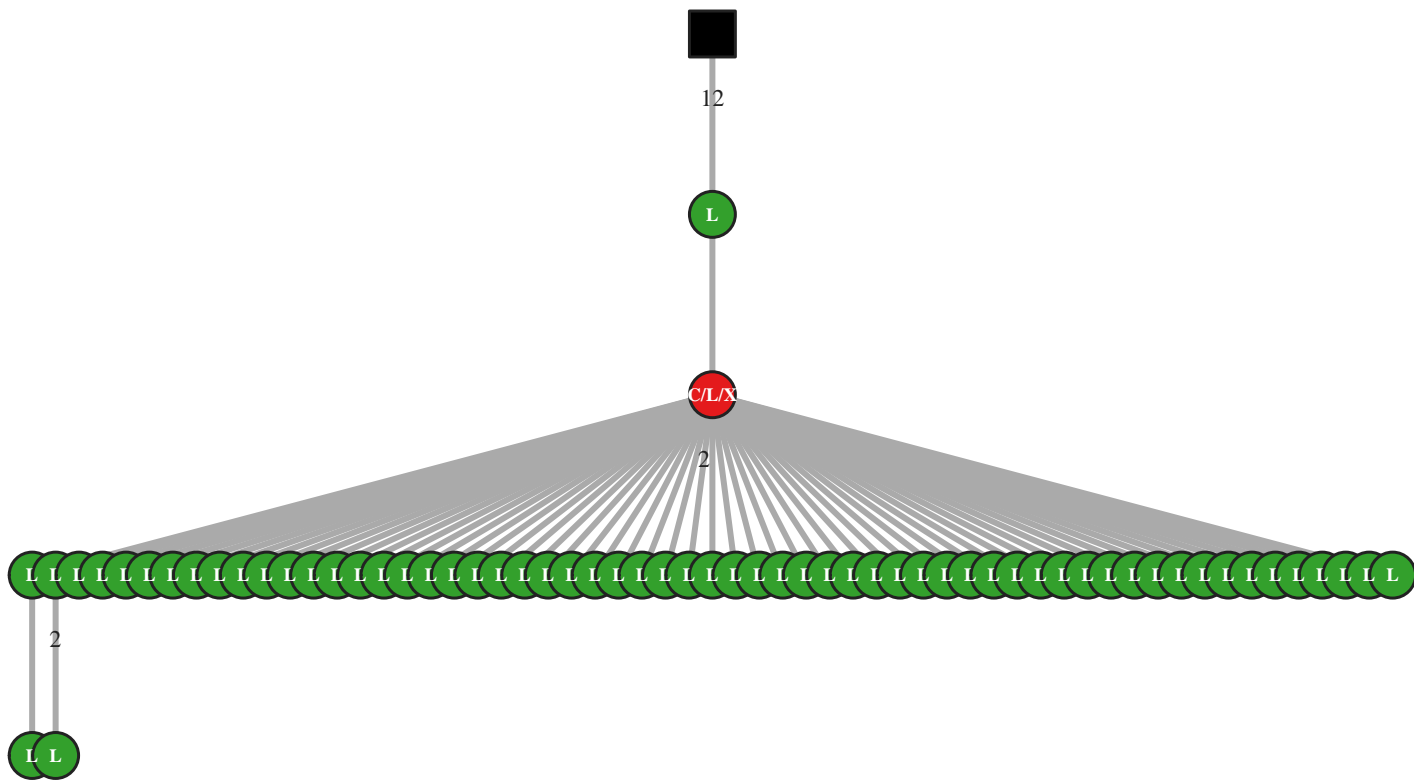

M5 IgG IGHV1-18/J5 45bp (49471)

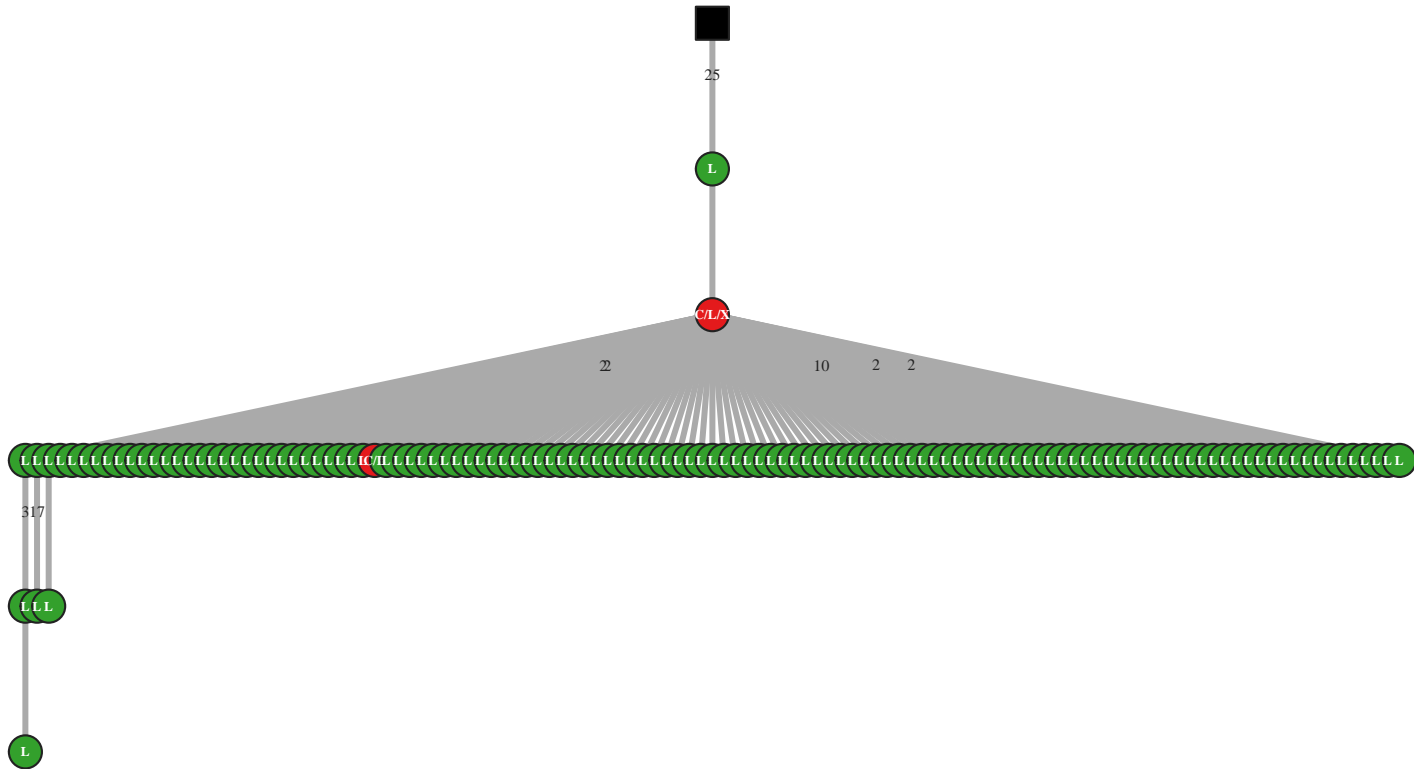

M5 IgG IGHV1-18/J5 48bp (22823)

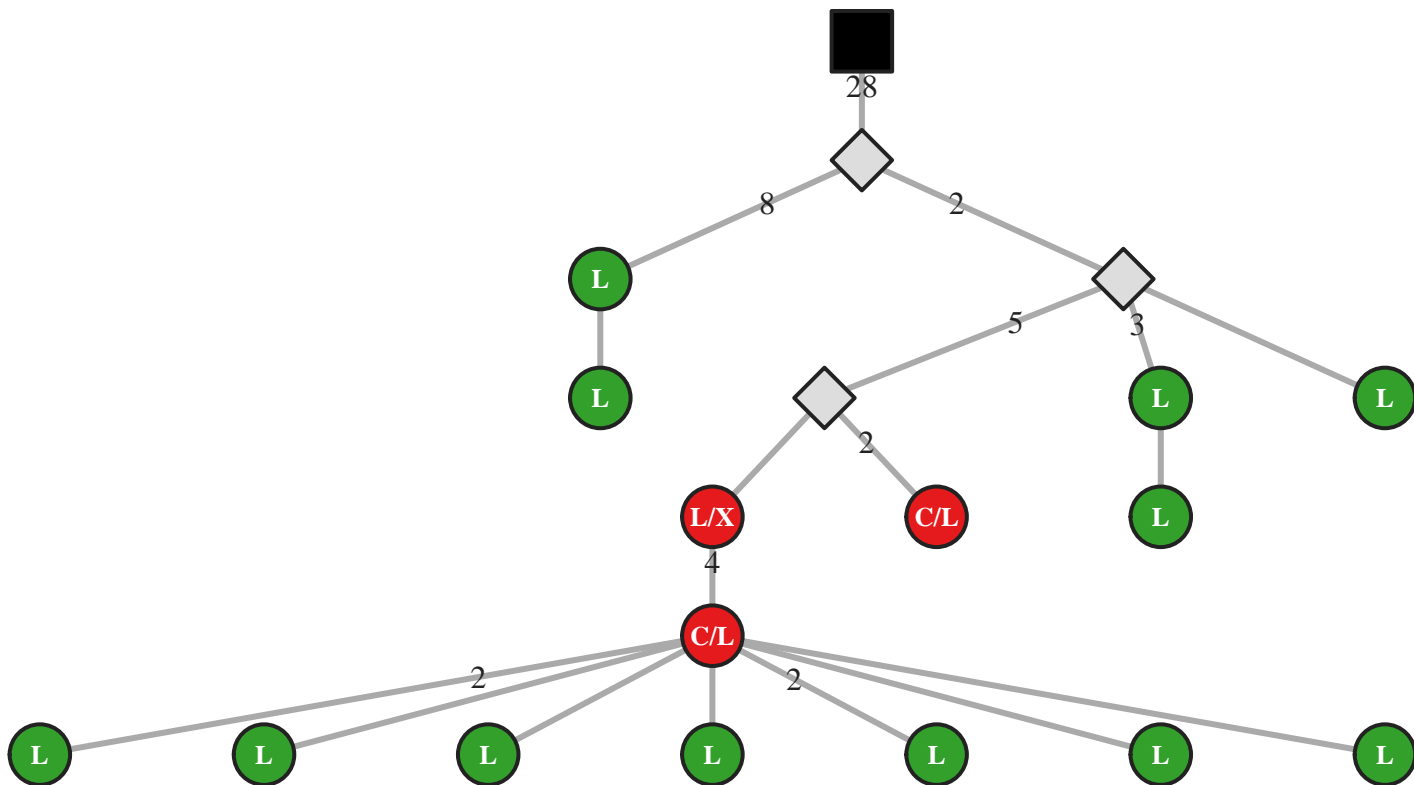

M5 IgG IGHV1-18/J5 51bp (22868)

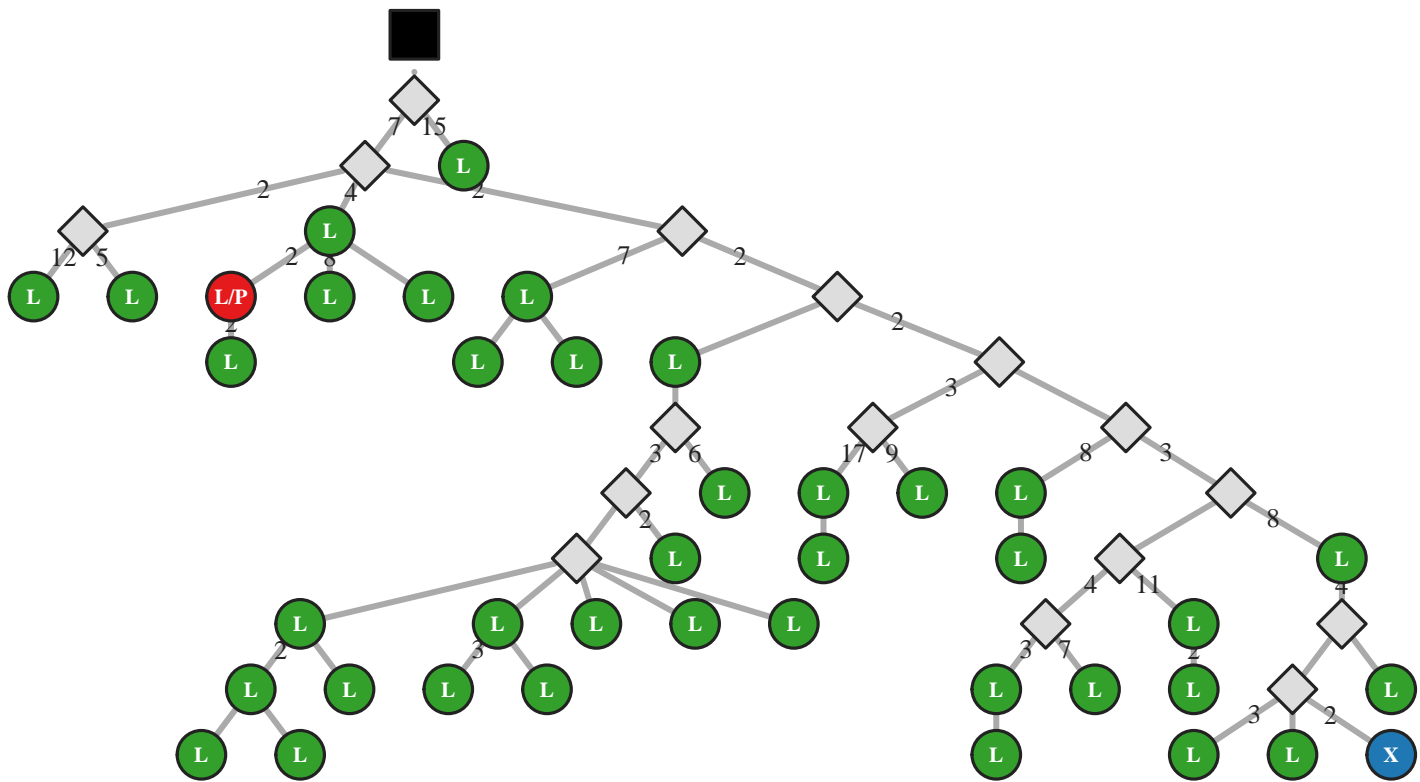

M5 IgG IGHV1-18/J5 63bp (22906)

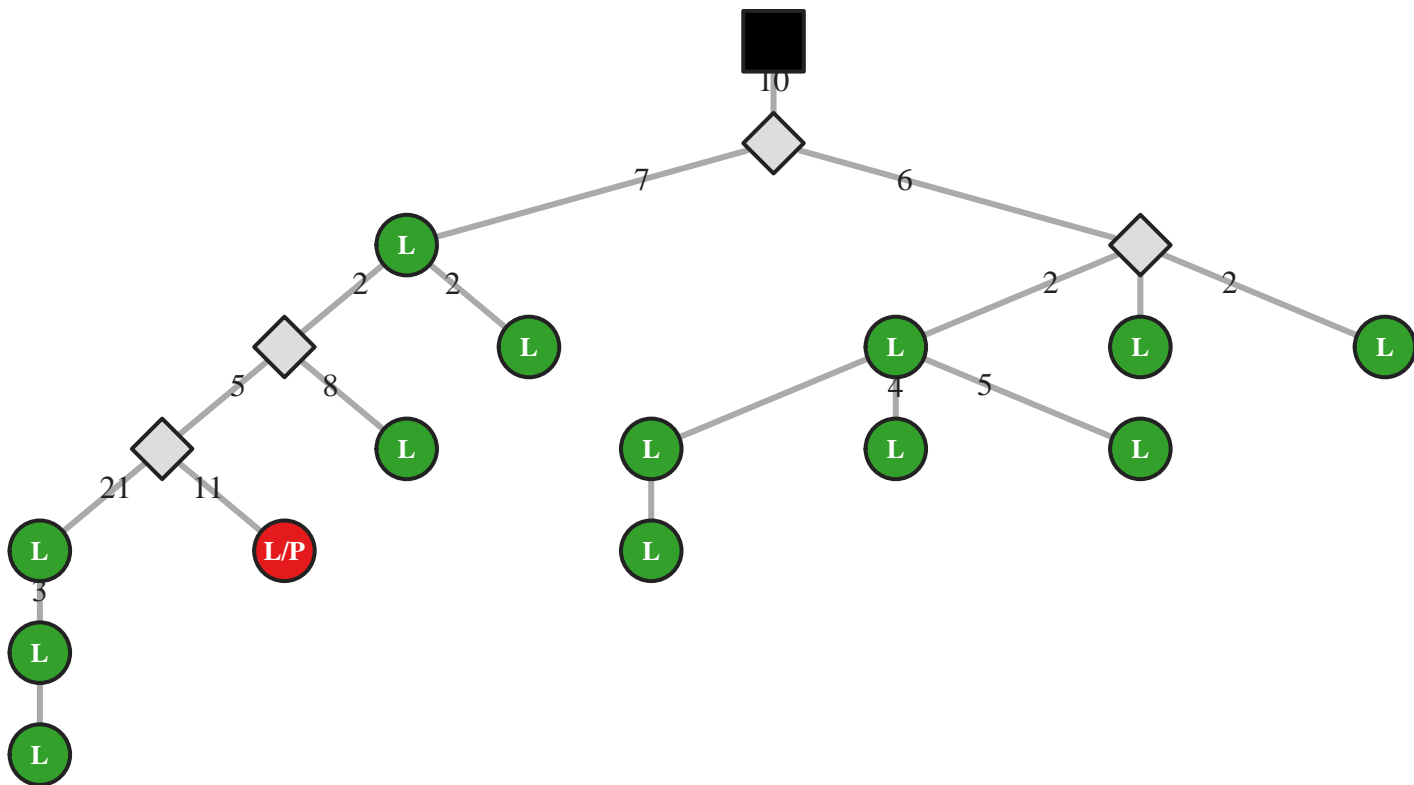

M5 IgG IGHV1-18/J5 66bp (31644)

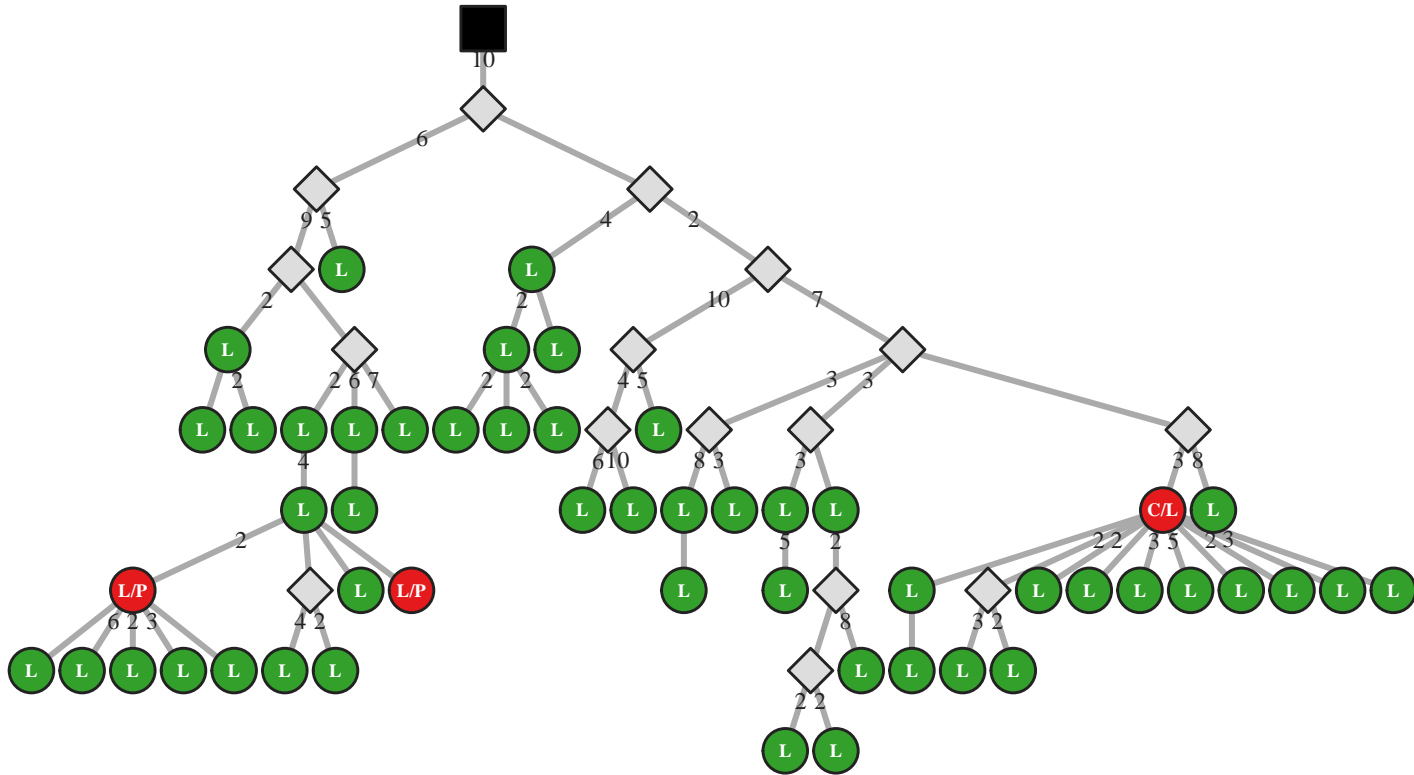

M5 IgG IGHV1-18/J6 30bp (49480)

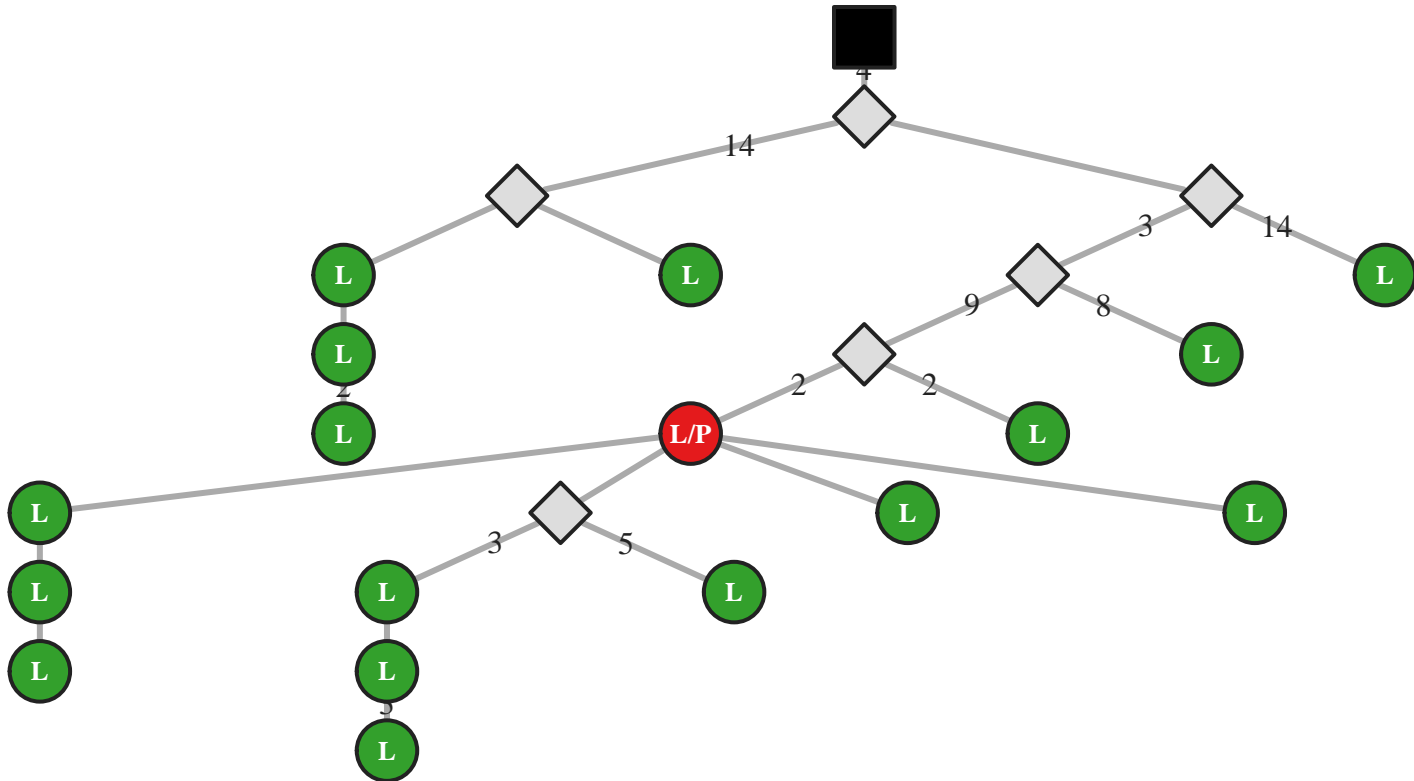

M5 IgG IGHV1-18/J6 36bp (4074)

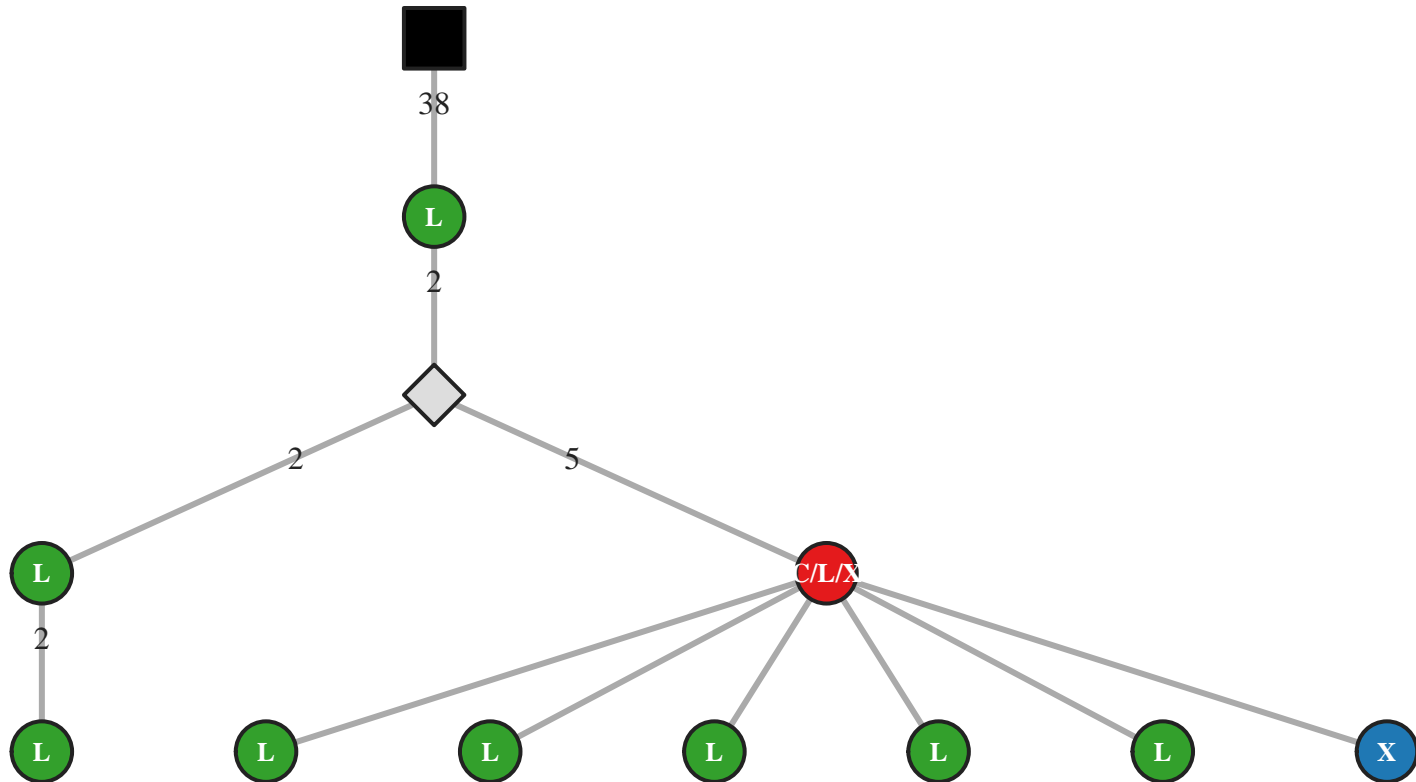

M5 IgG IGHV1-18/J6 48bp (22941)

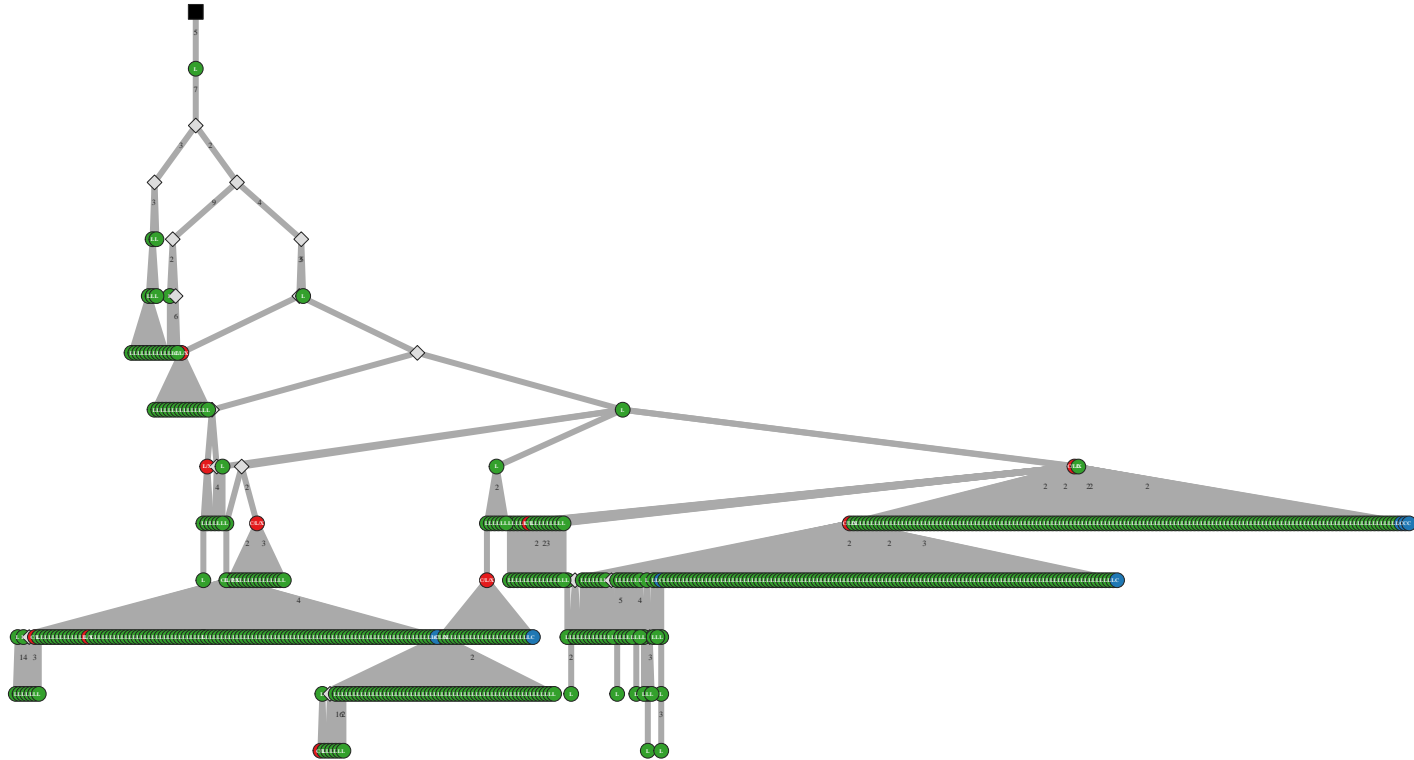

M5 IgG IGHV1-18/J6 51bp (13592)

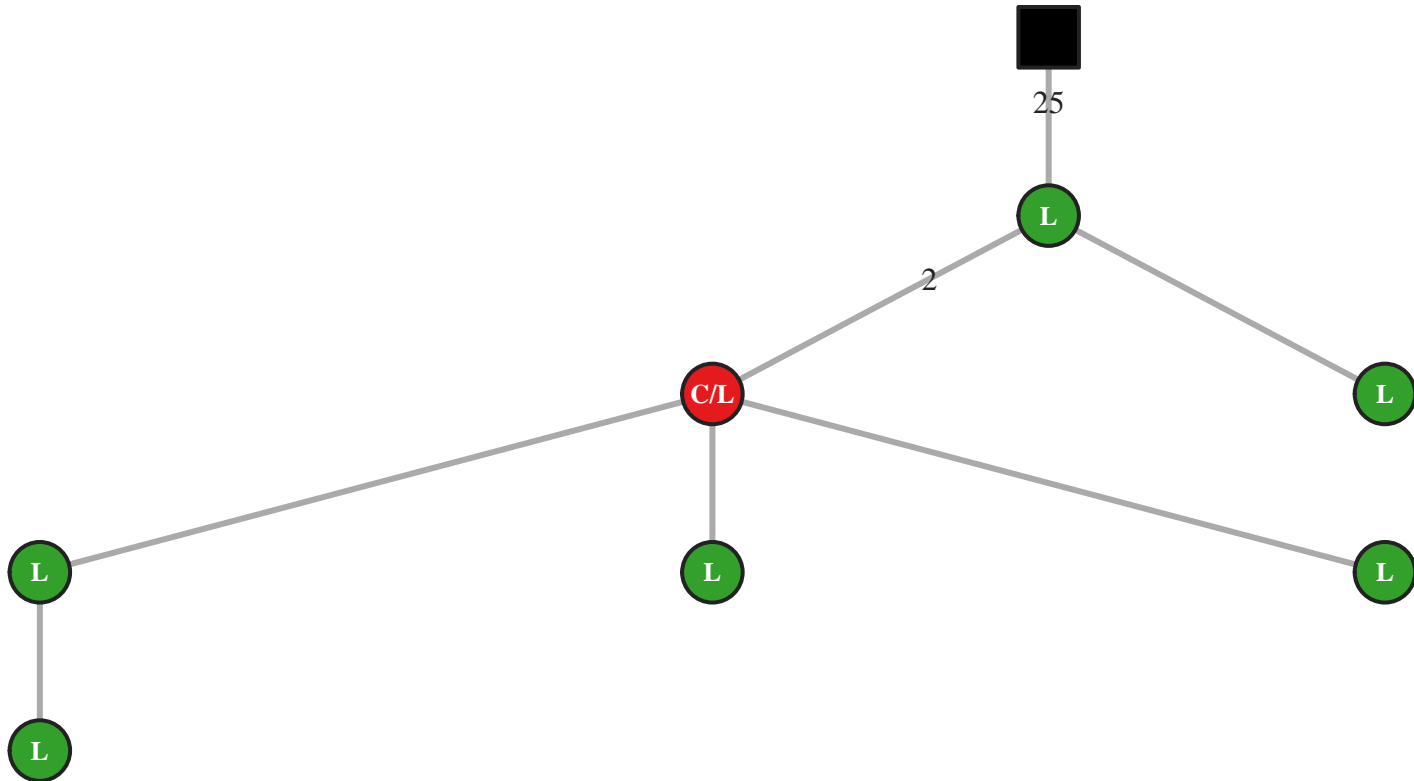

M5 IgG IGHV1-18/J6 54bp (49505)

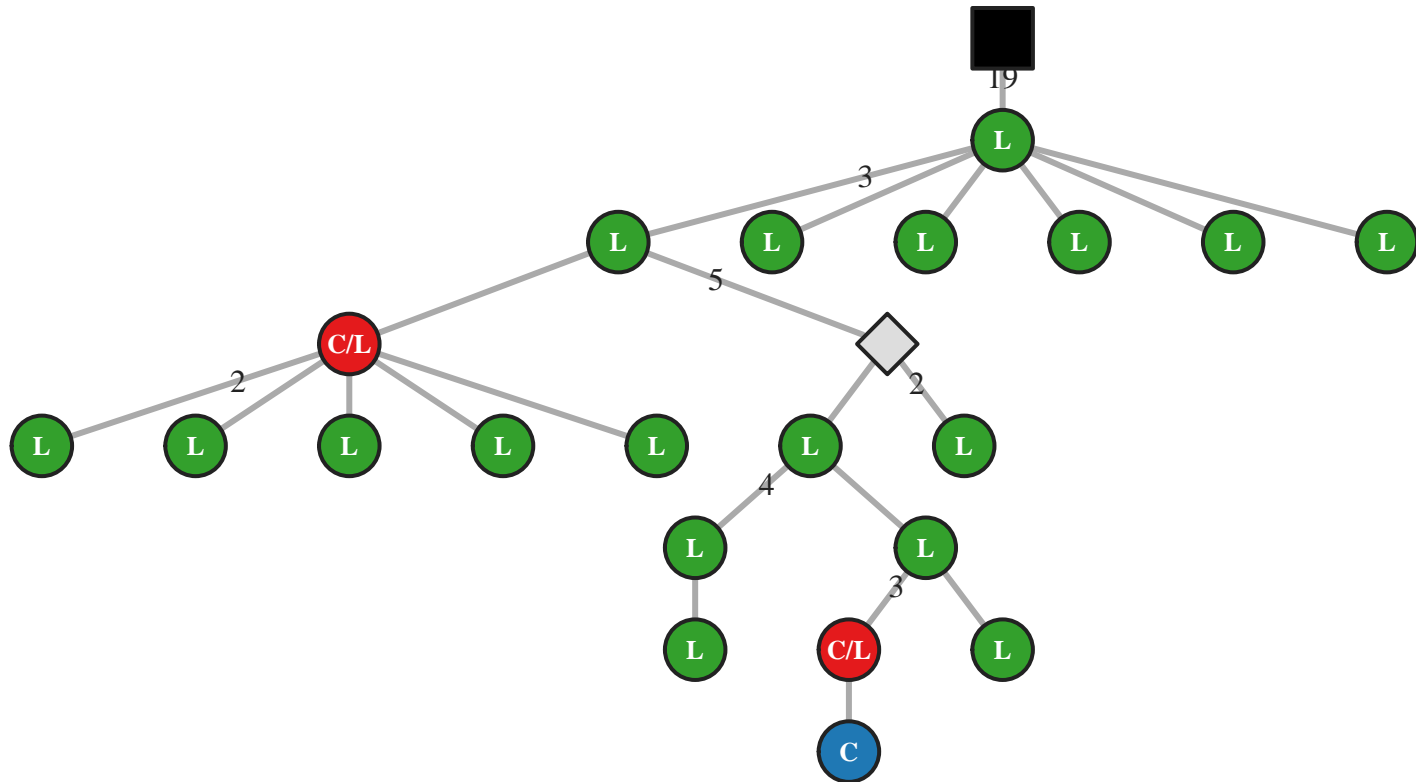

M5 IgA IGHV1-18/J6 60bp (38157)

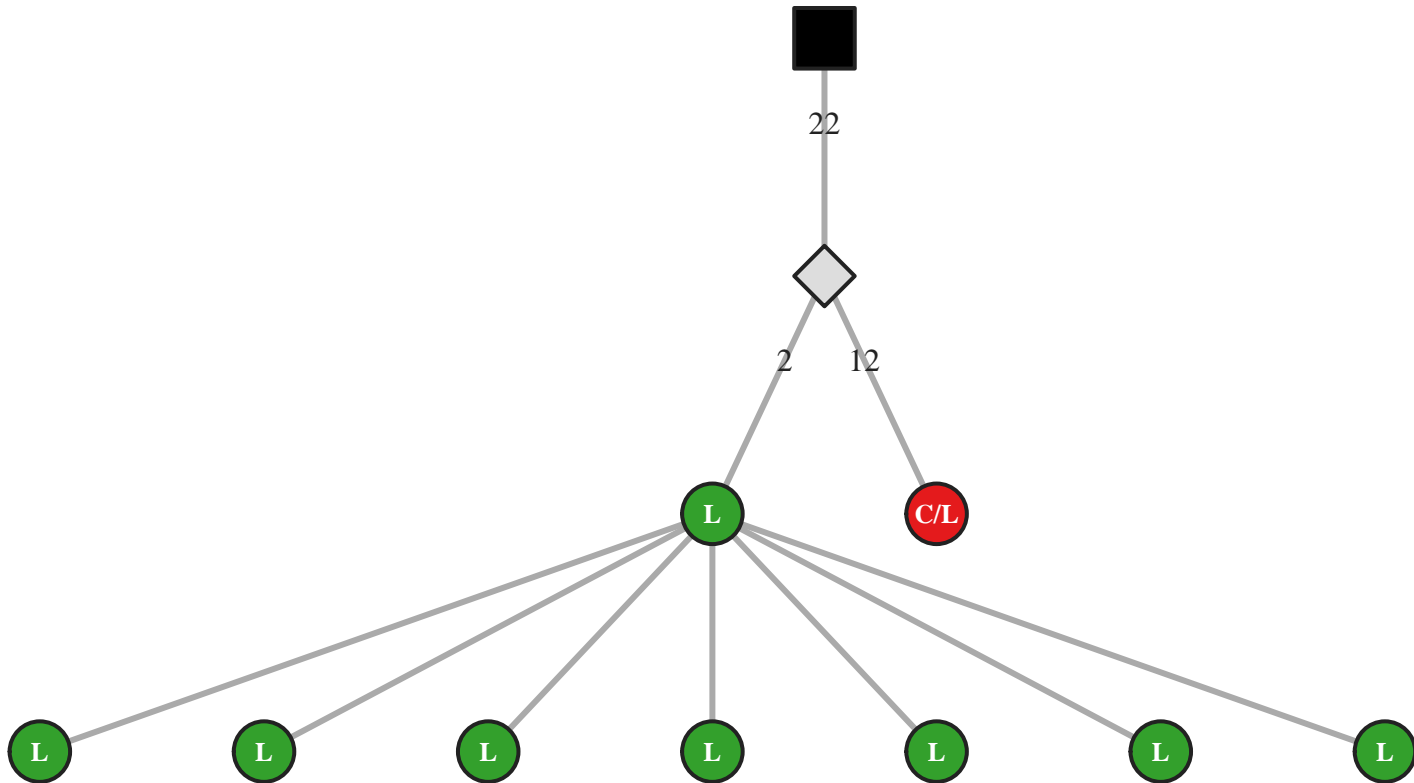

M5 IgG IGHV1-18/J6 60bp (13631)

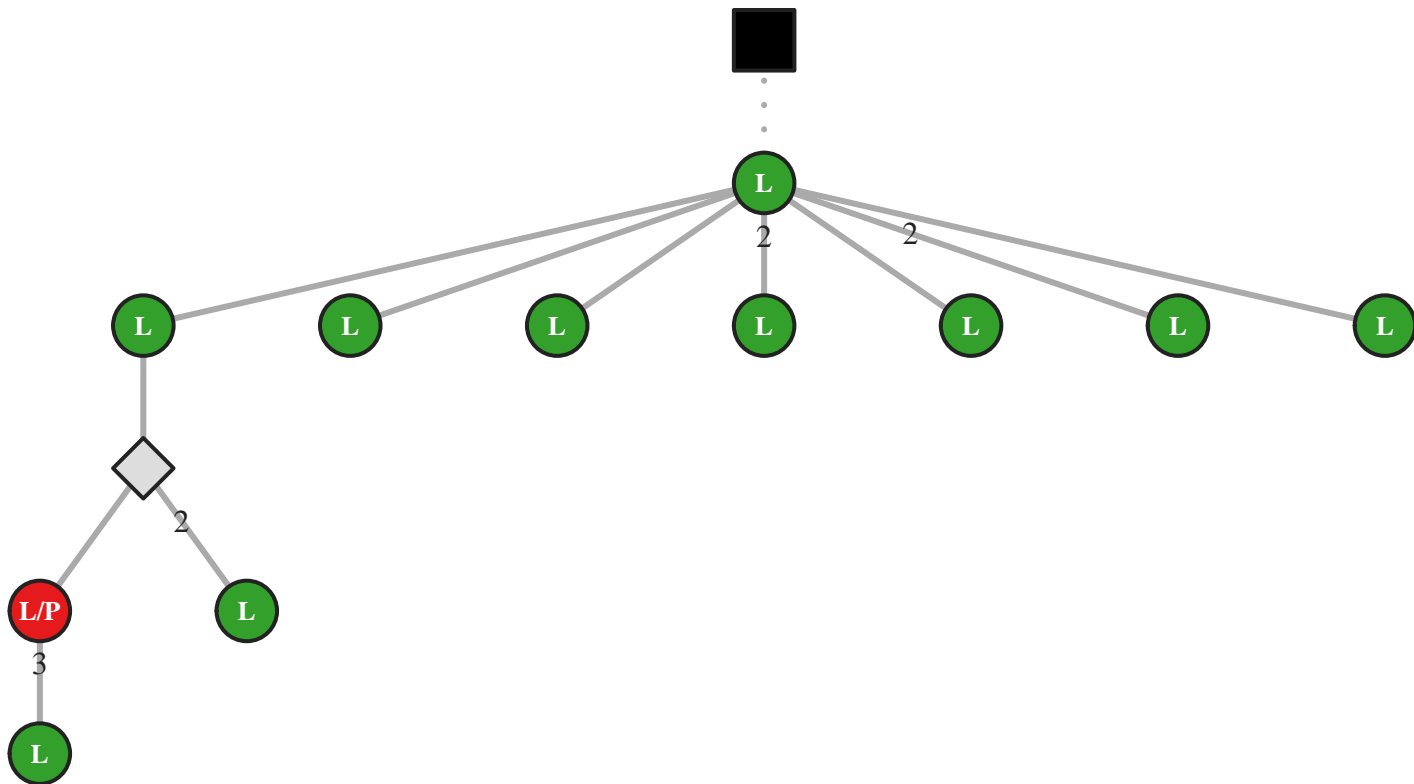

M5 IgG IGHV1-18/J6 63bp (22991)

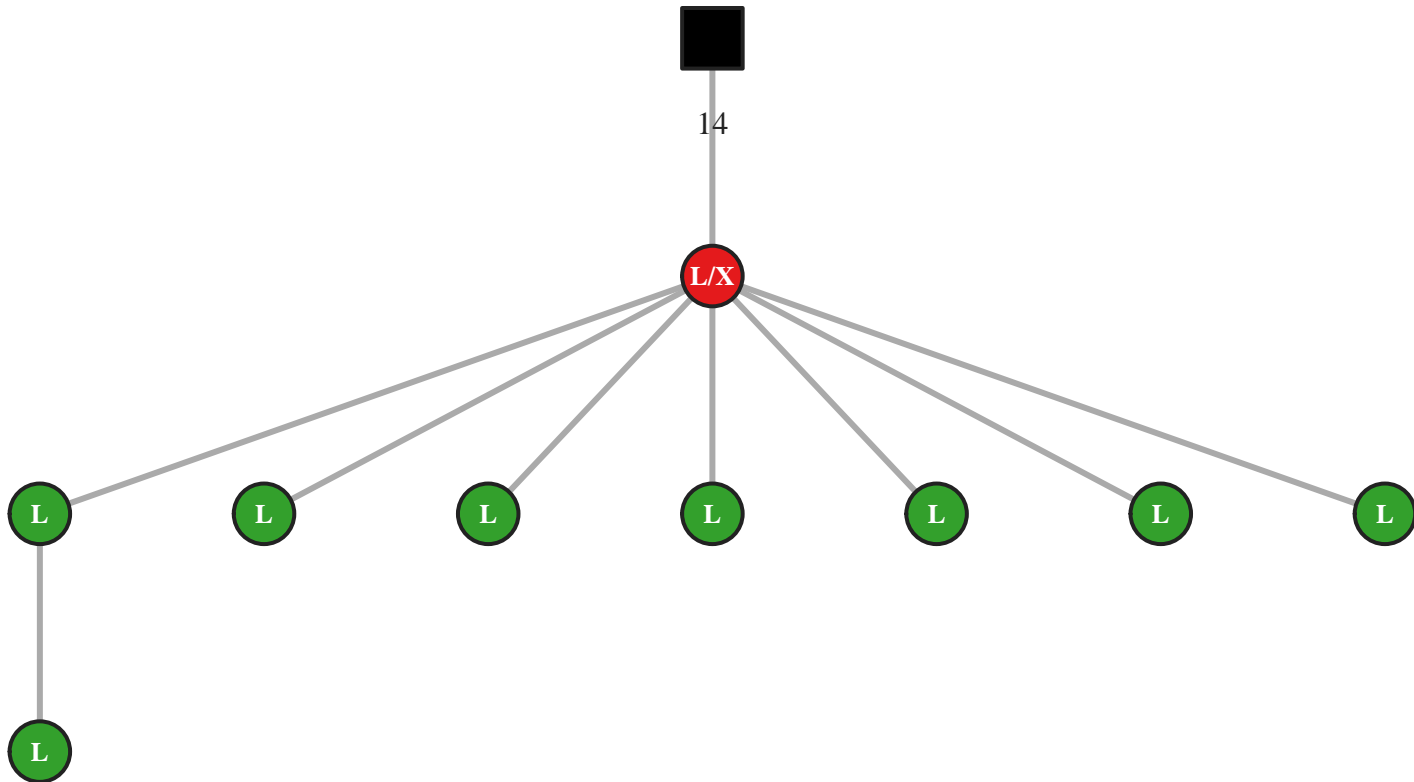

M5 IgG IGHV1-18/J6 75bp (39783)

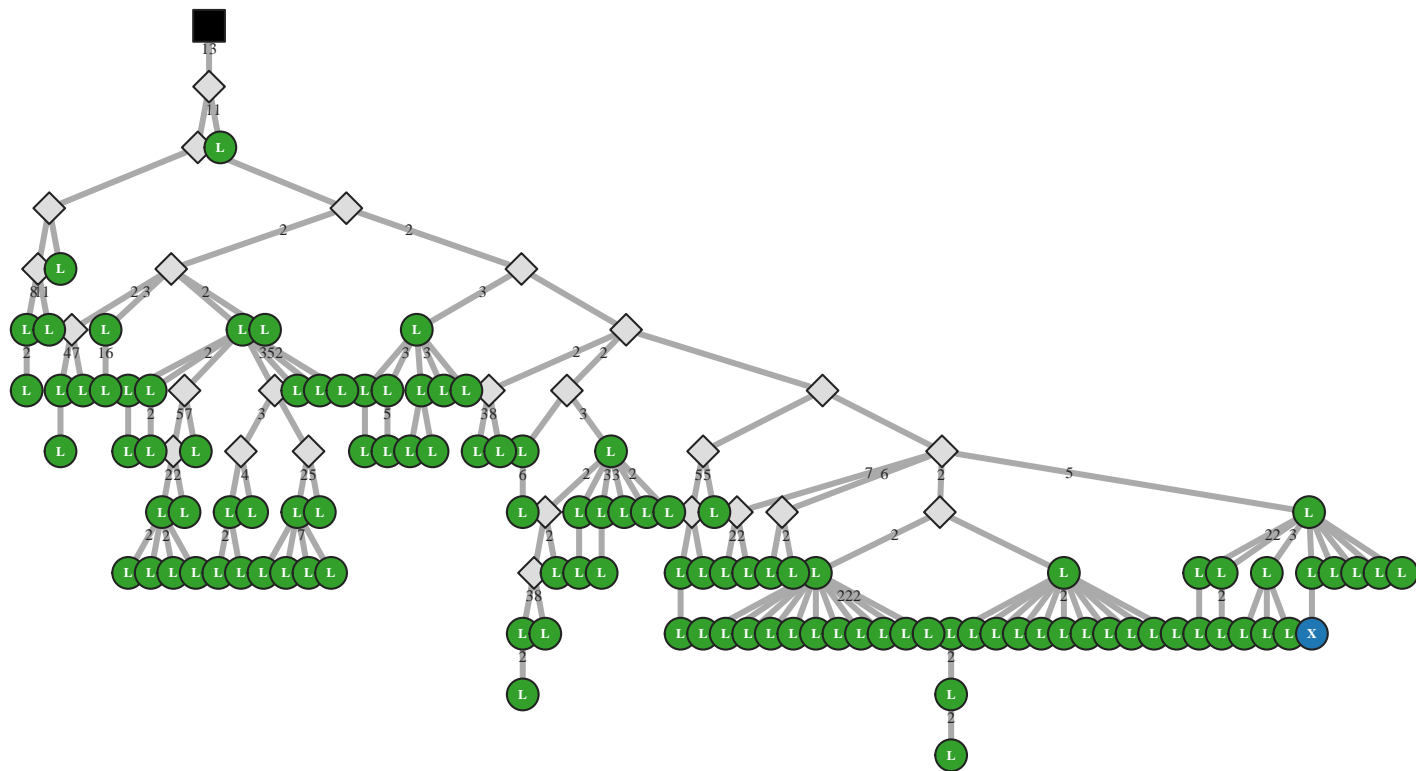

M5 IgG IGHV1-2/J3 39bp (13731)

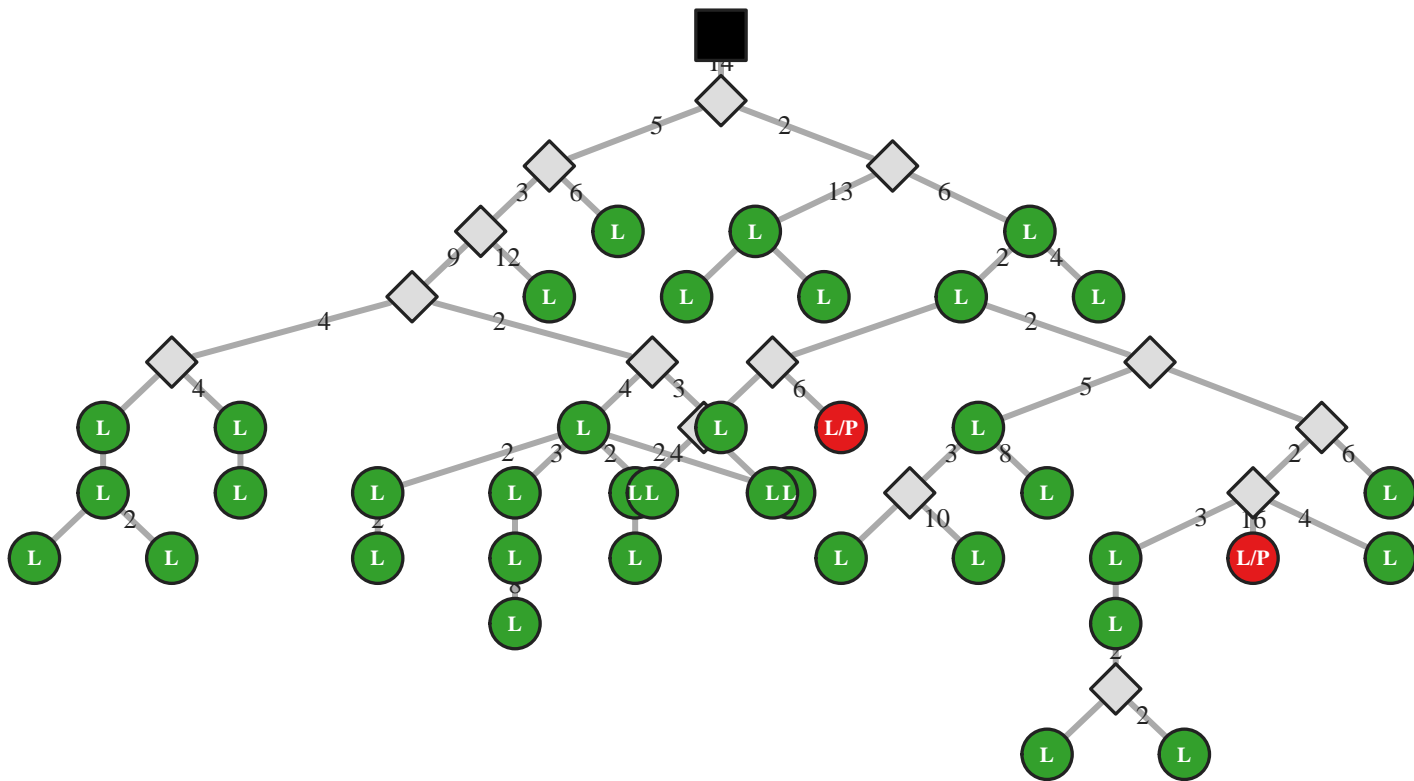

M5 IgG IGHV1-2/J3 45bp (31760)

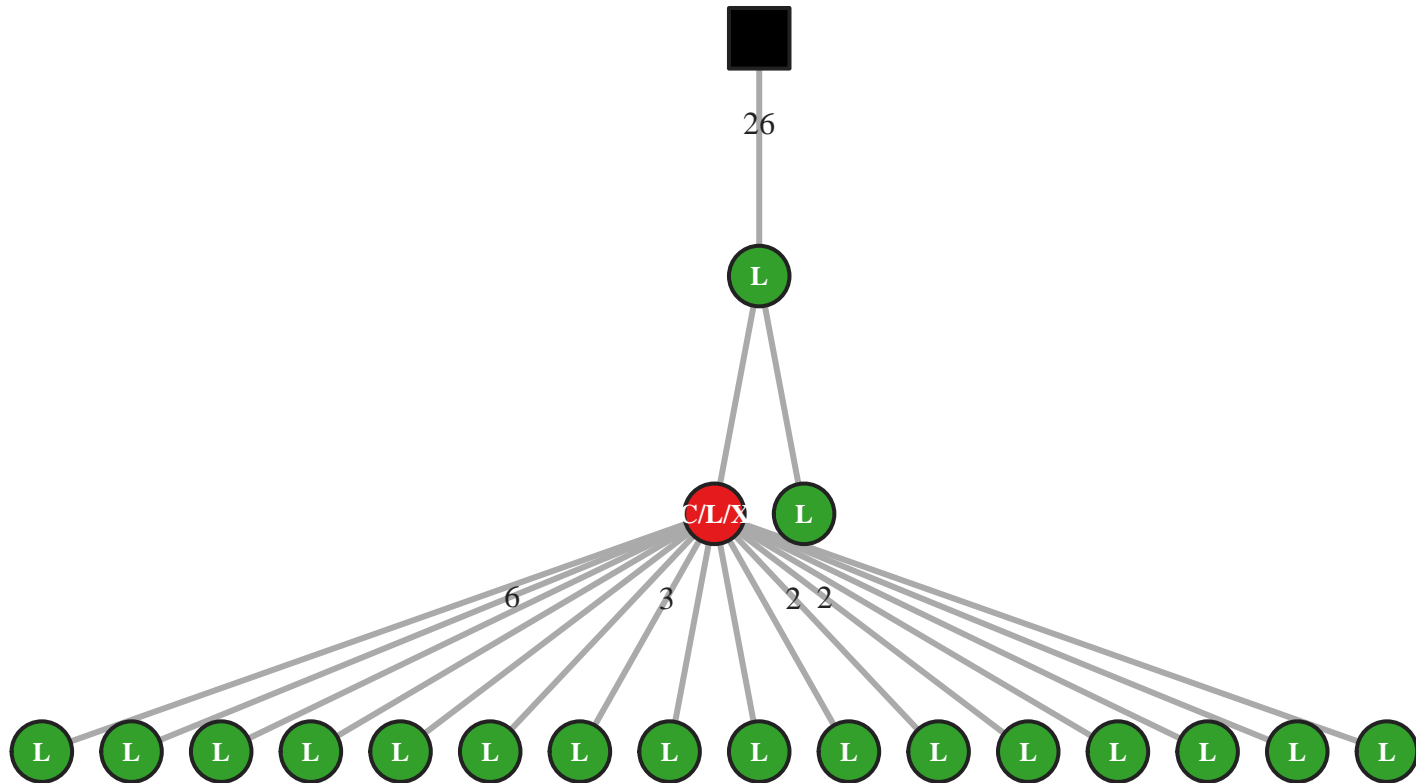

M5 IgG IGHV1-2/J3 51bp (4250)

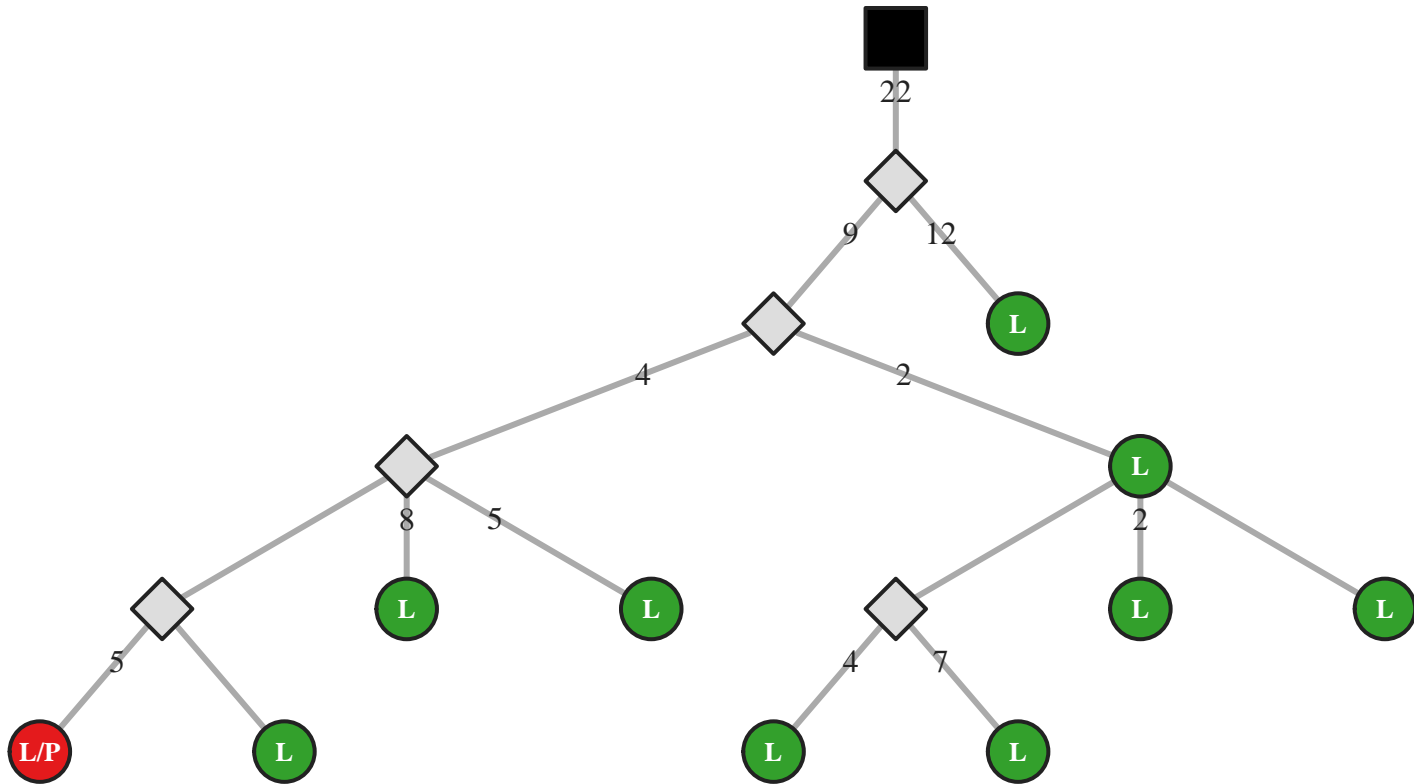

M5 IgG IGHV1-2/J3 51bp (4255)

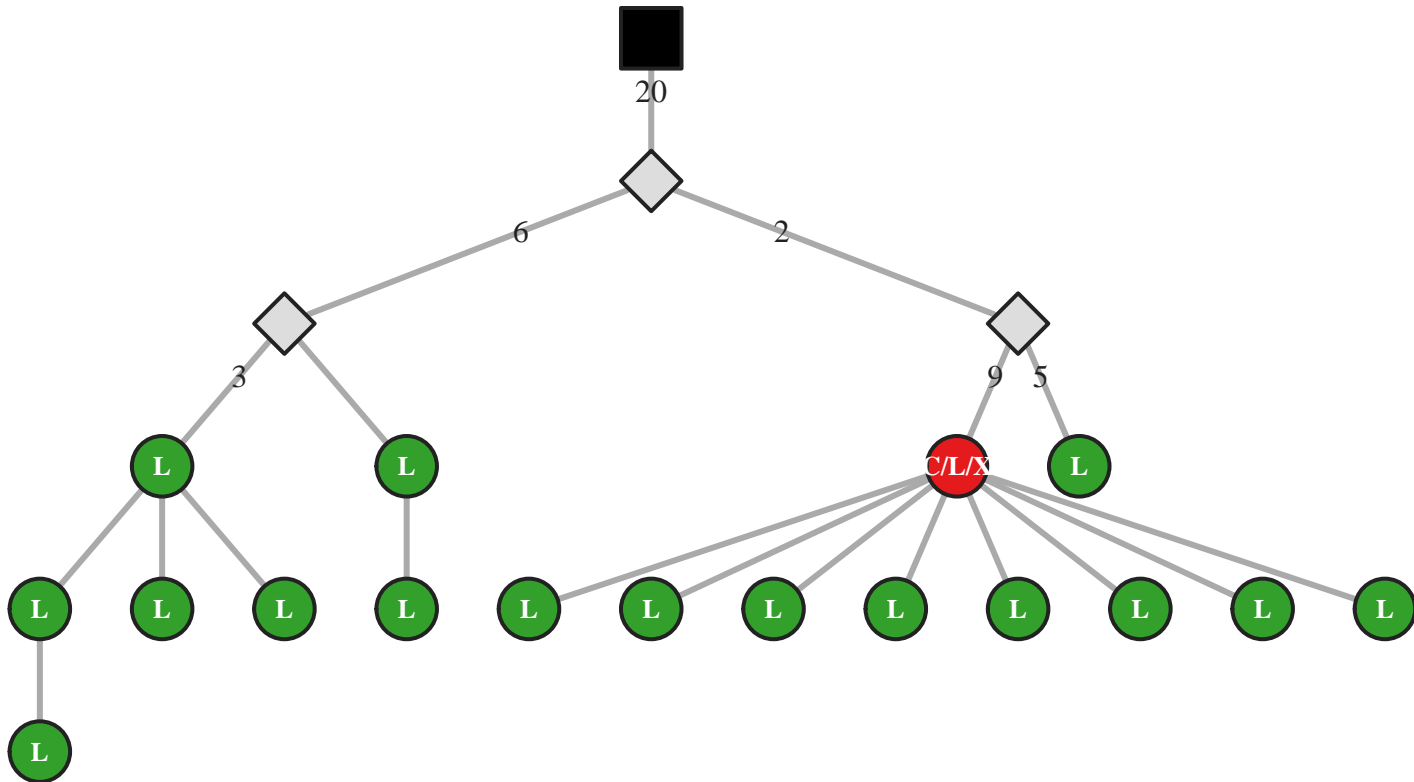

M5 IgA IGHV1-2/J3 57bp (30058)

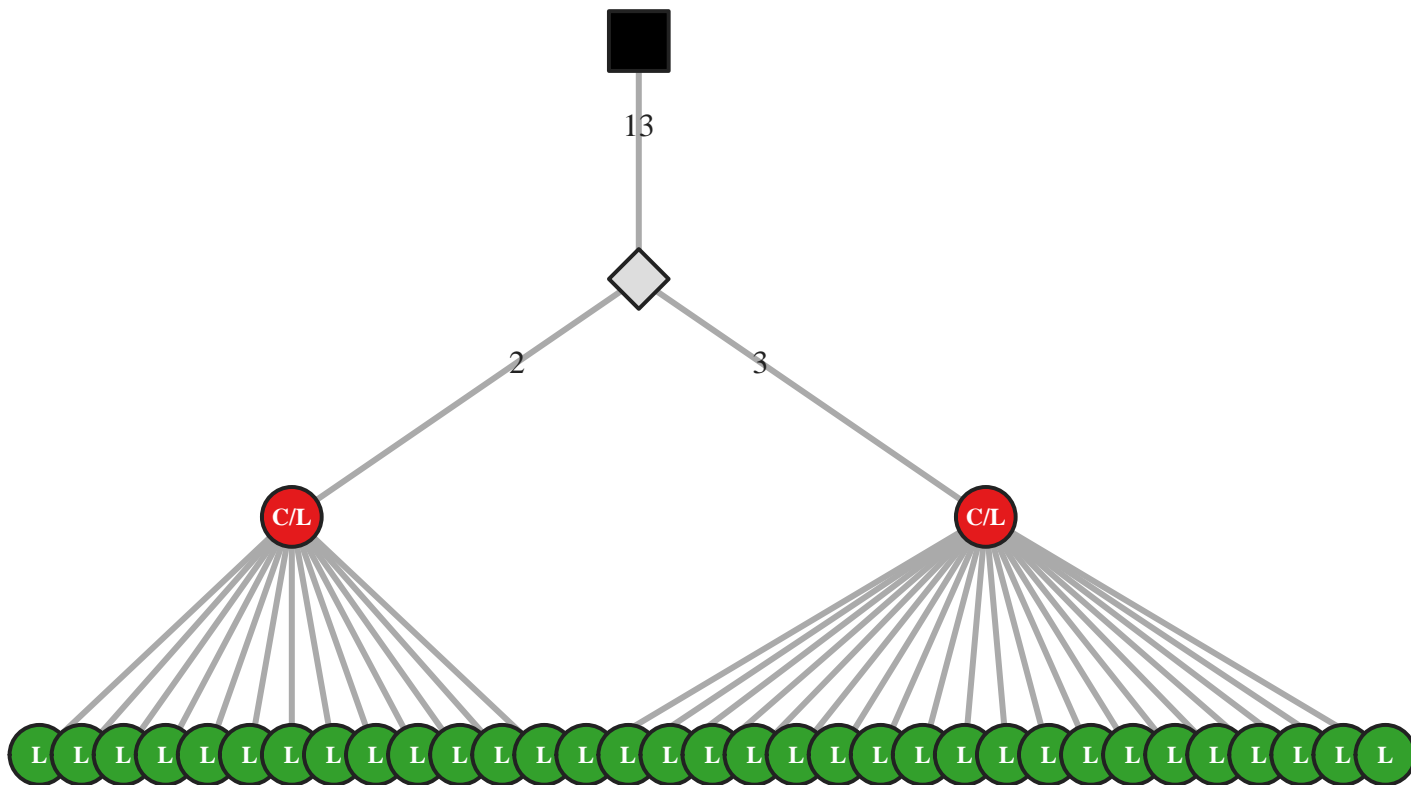

M5 IgG IGHV1-2/J4 24bp (23162)

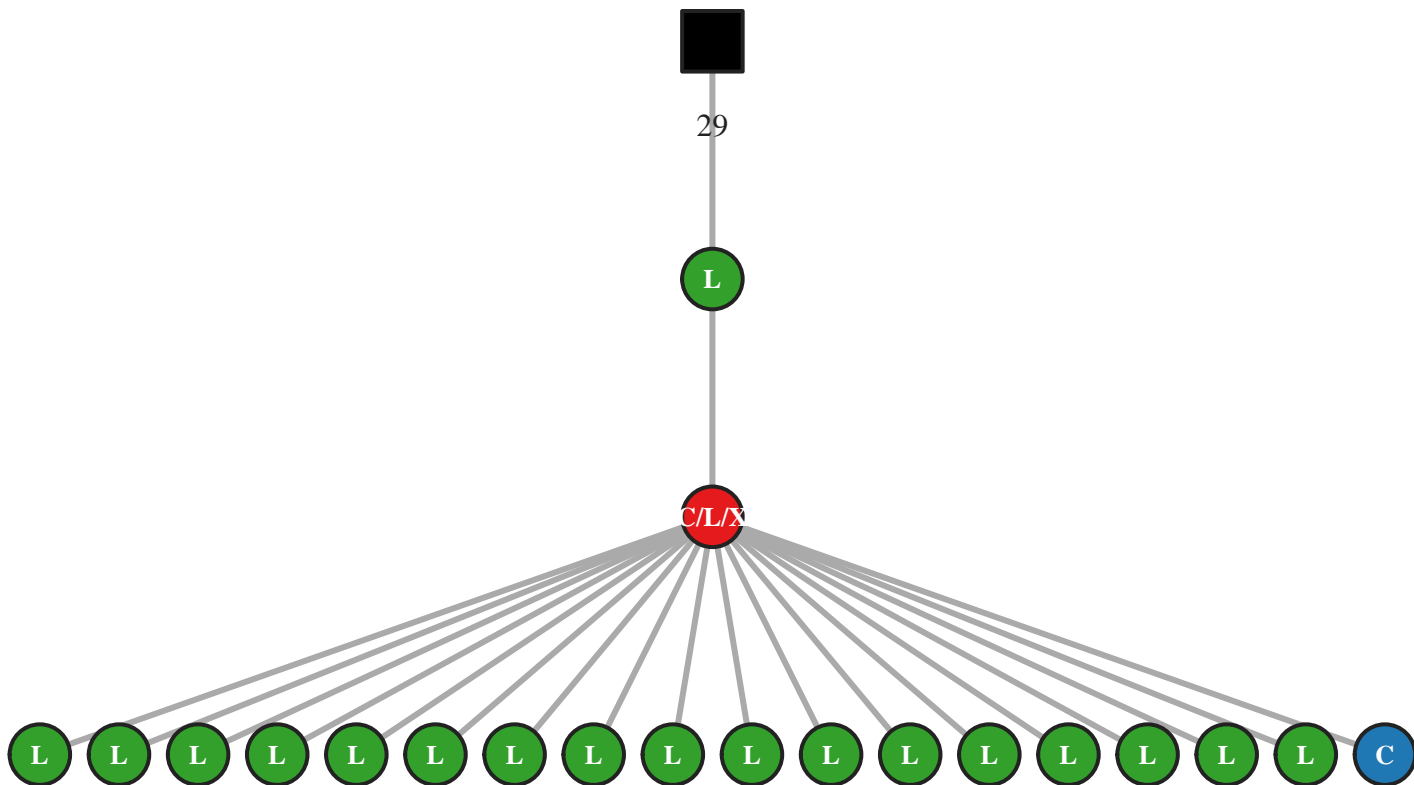

M5 IgM IGHV1-2/J4 33bp (20270)

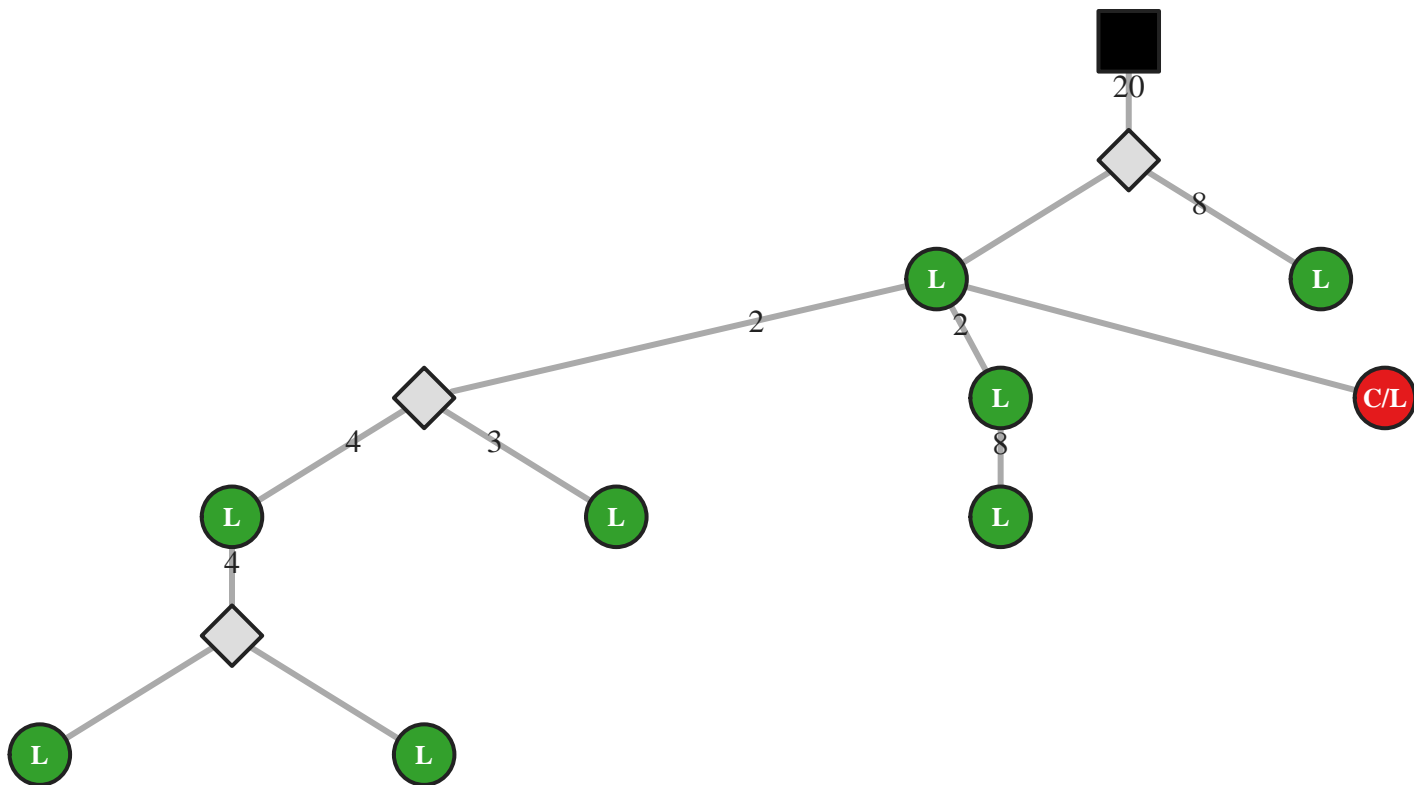

M5 IgG IGHV1-2/J4 36bp (4289)

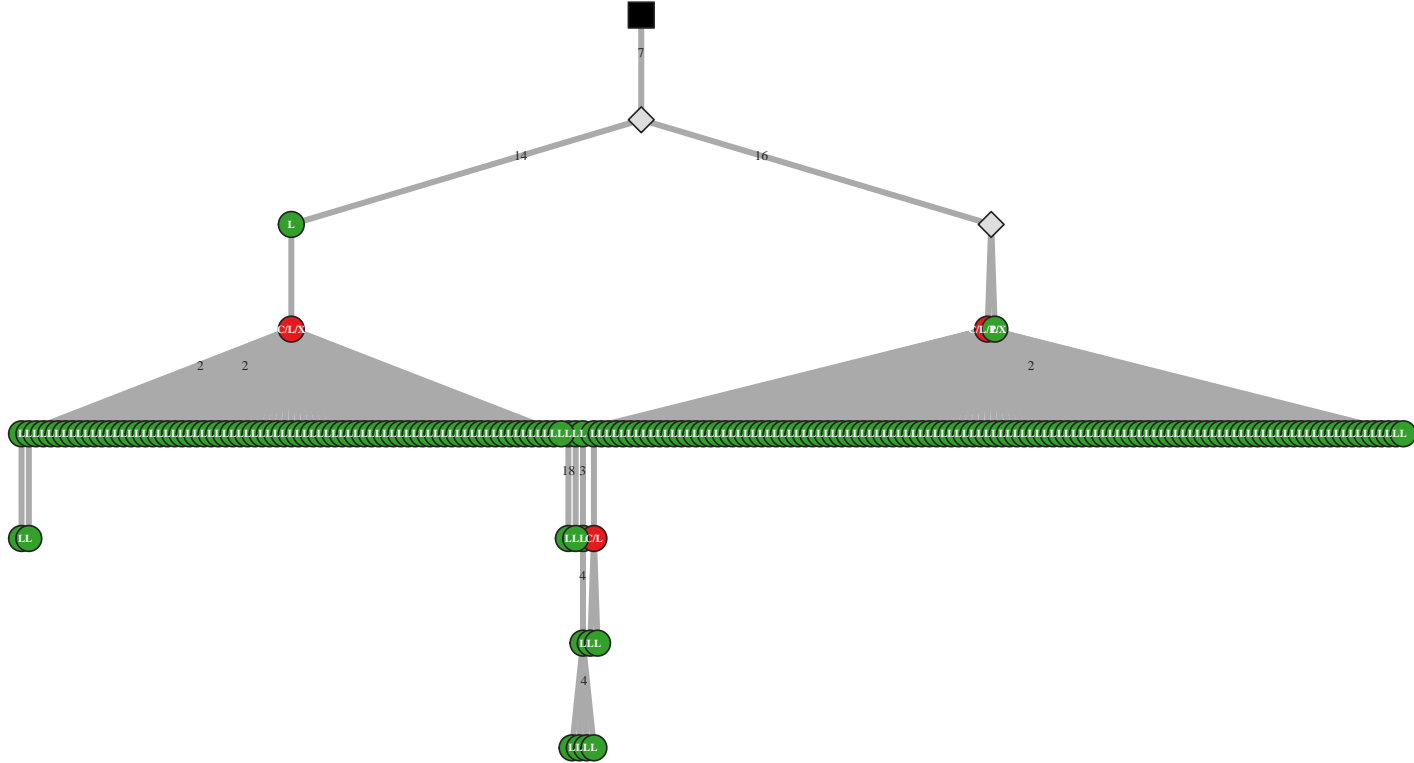

M5 IgG IGHV1-2/J4 36bp (4304)

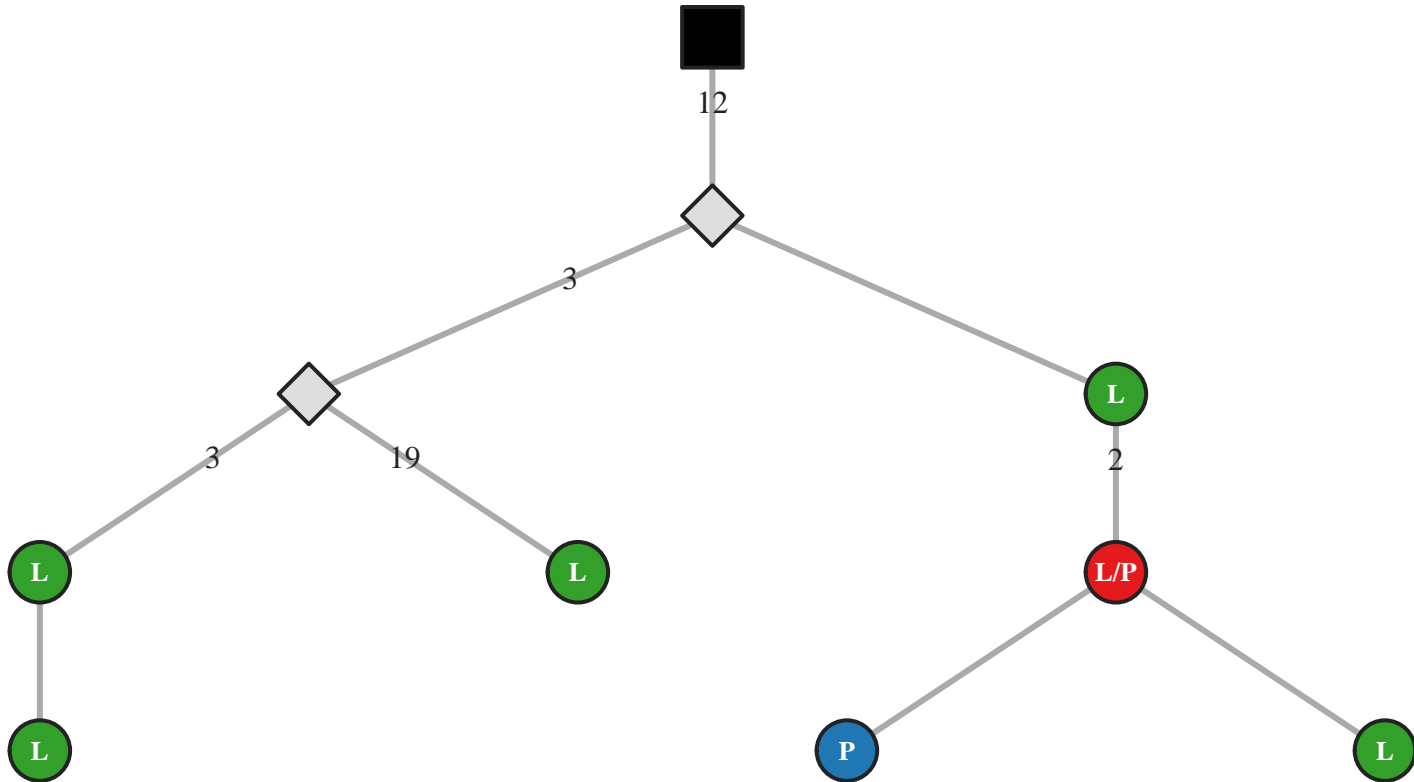

M5 IgG IGHV1-2/J4 39bp (13795)

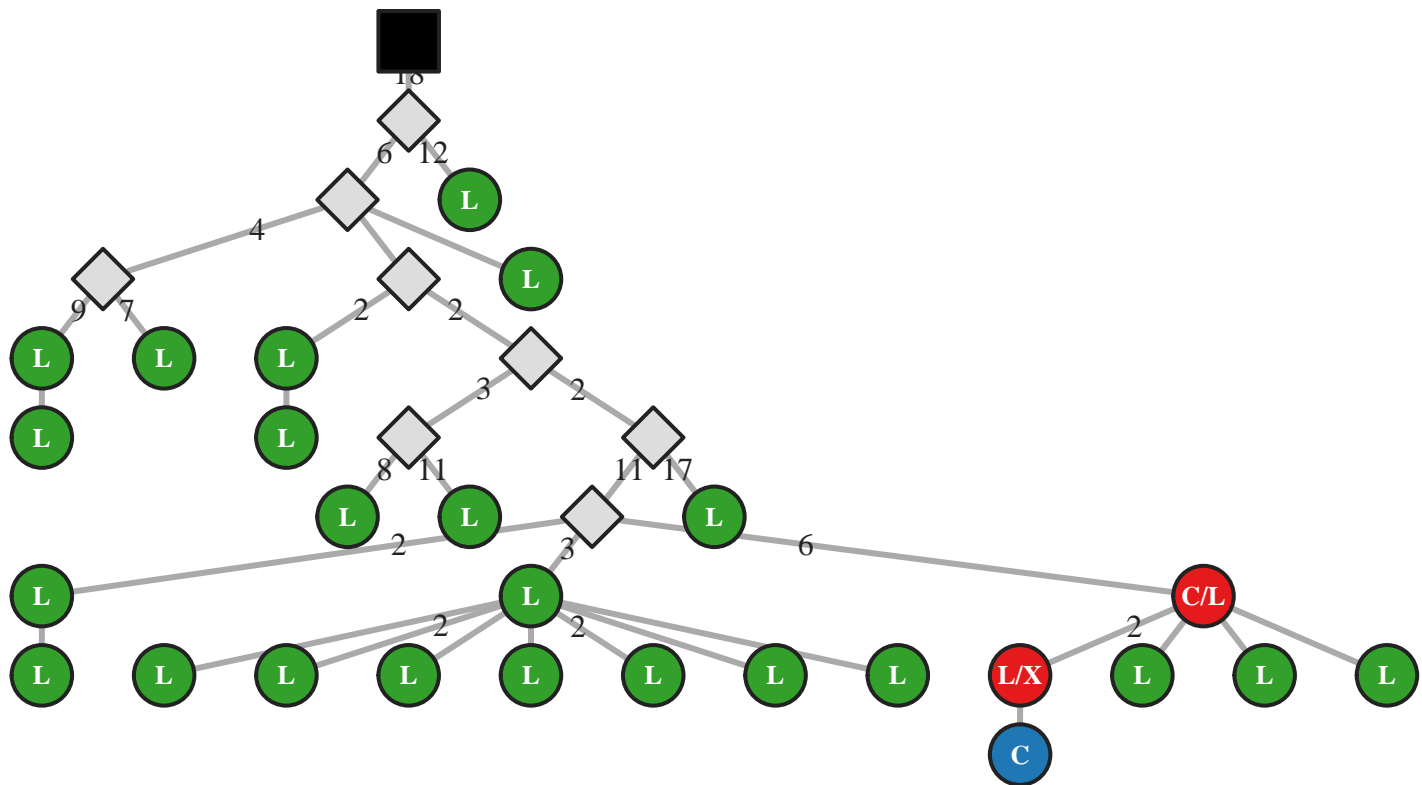

M5 IgG IGHV1-2/J4 39bp (13796)

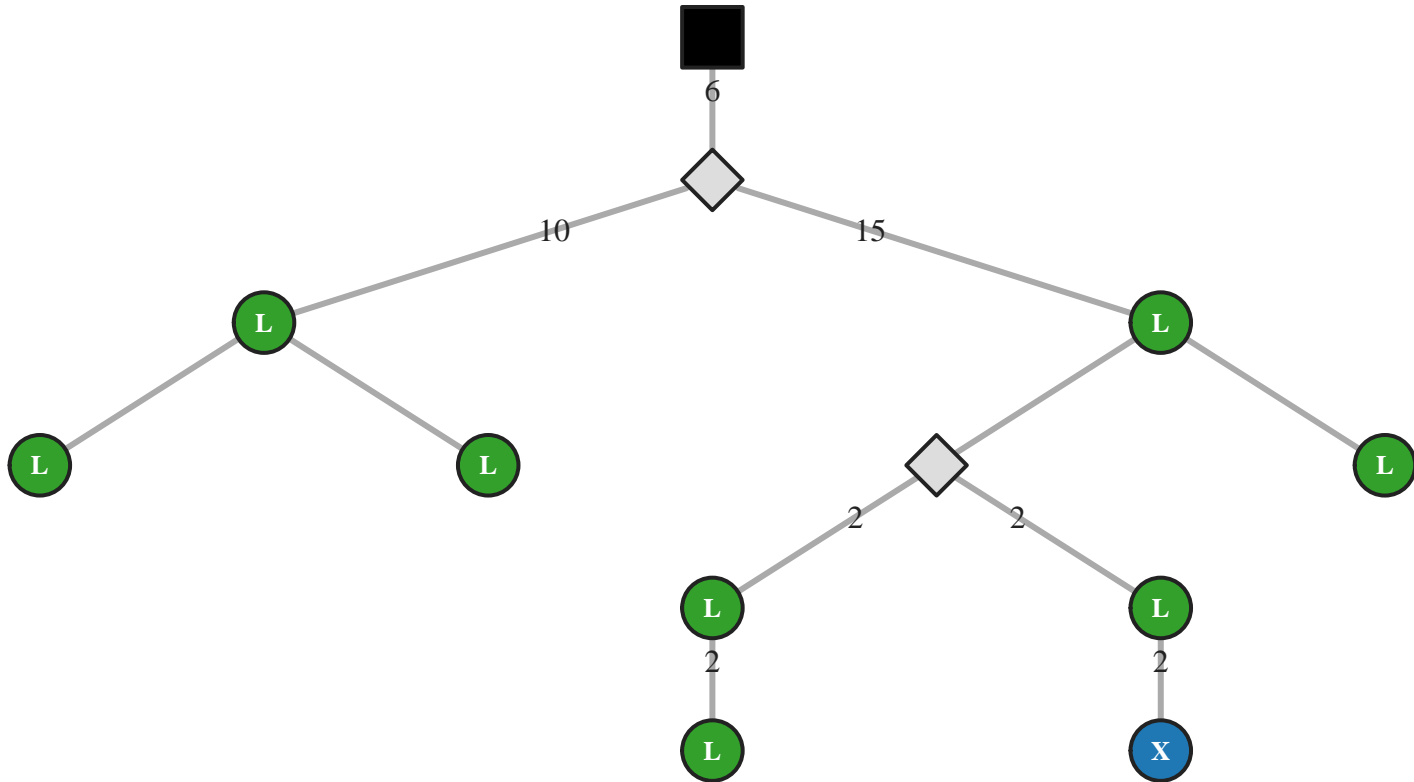

M5 IgG IGHV1-2/J4 39bp (13801)

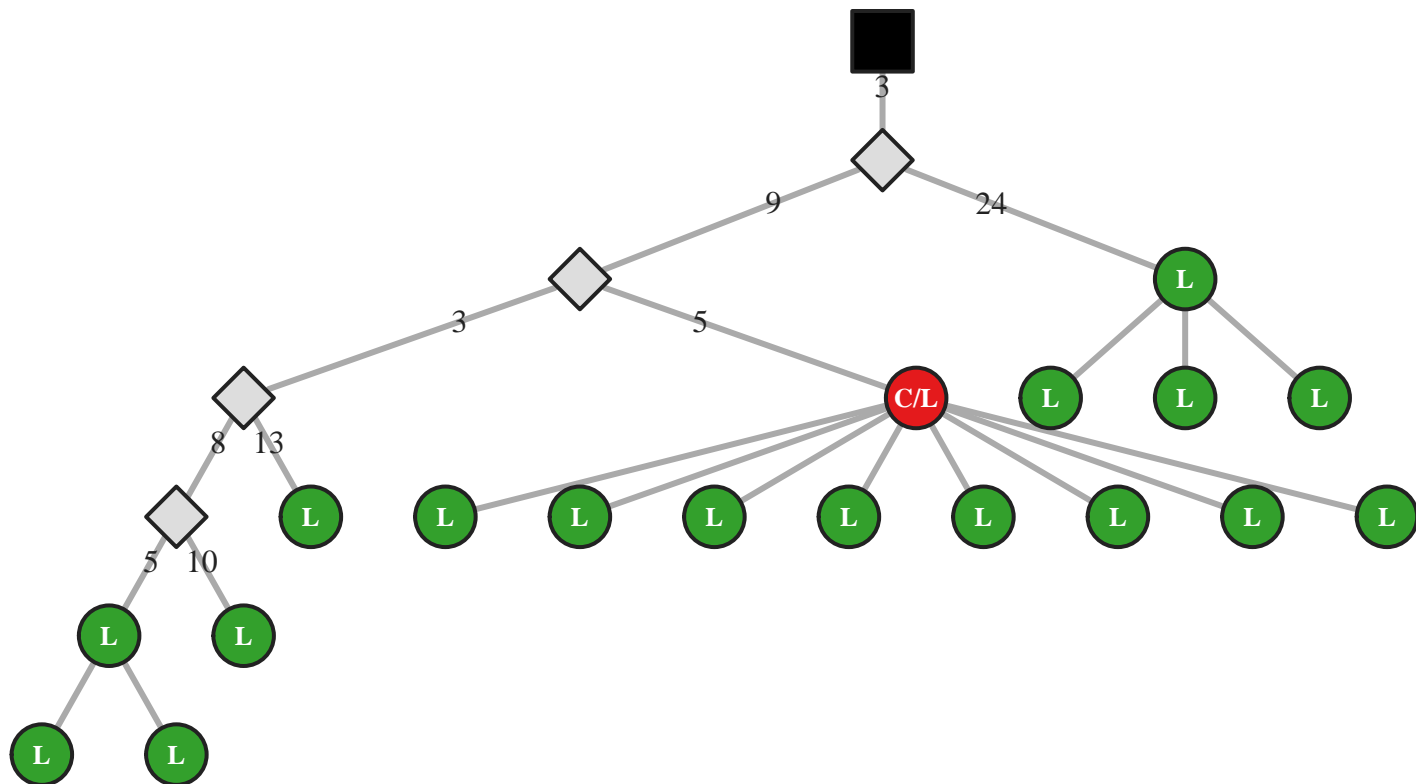

M5 IgG IGHV1-2/J4 39bp (13803)

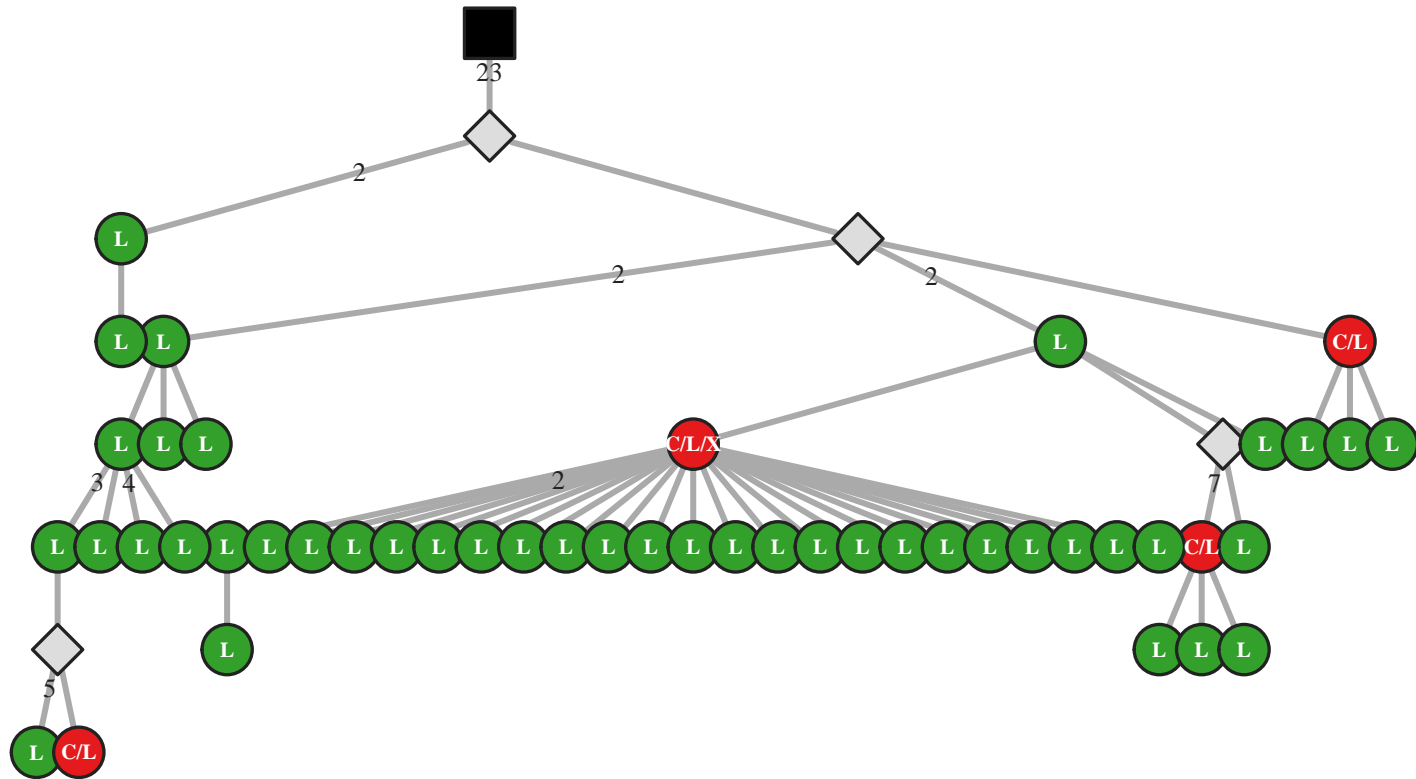

M5 IgG IGHV1-2/J4 39bp (13831)

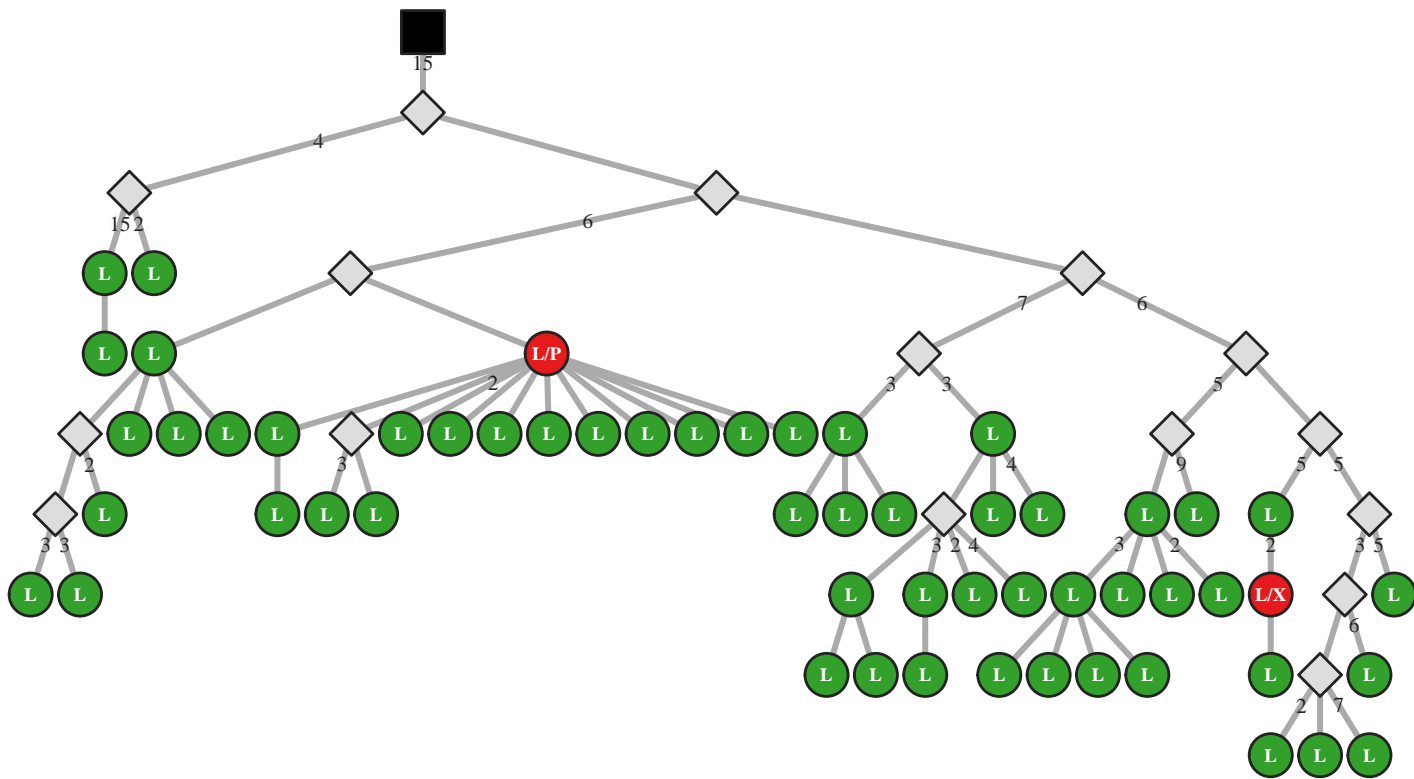

M5 IgG IGHV1-2/J4 42bp (31823)

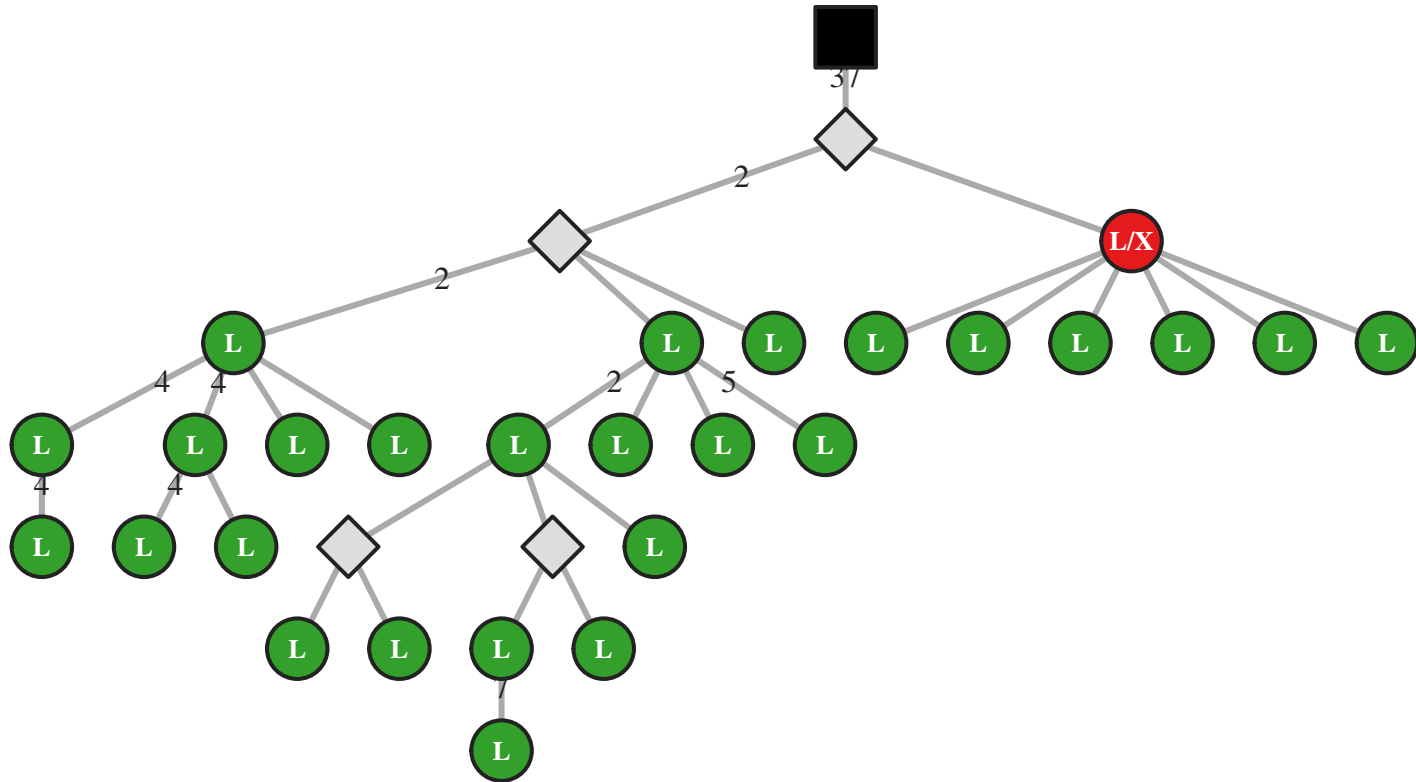

M5 IgG IGHV1-2/J4 42bp (31833)

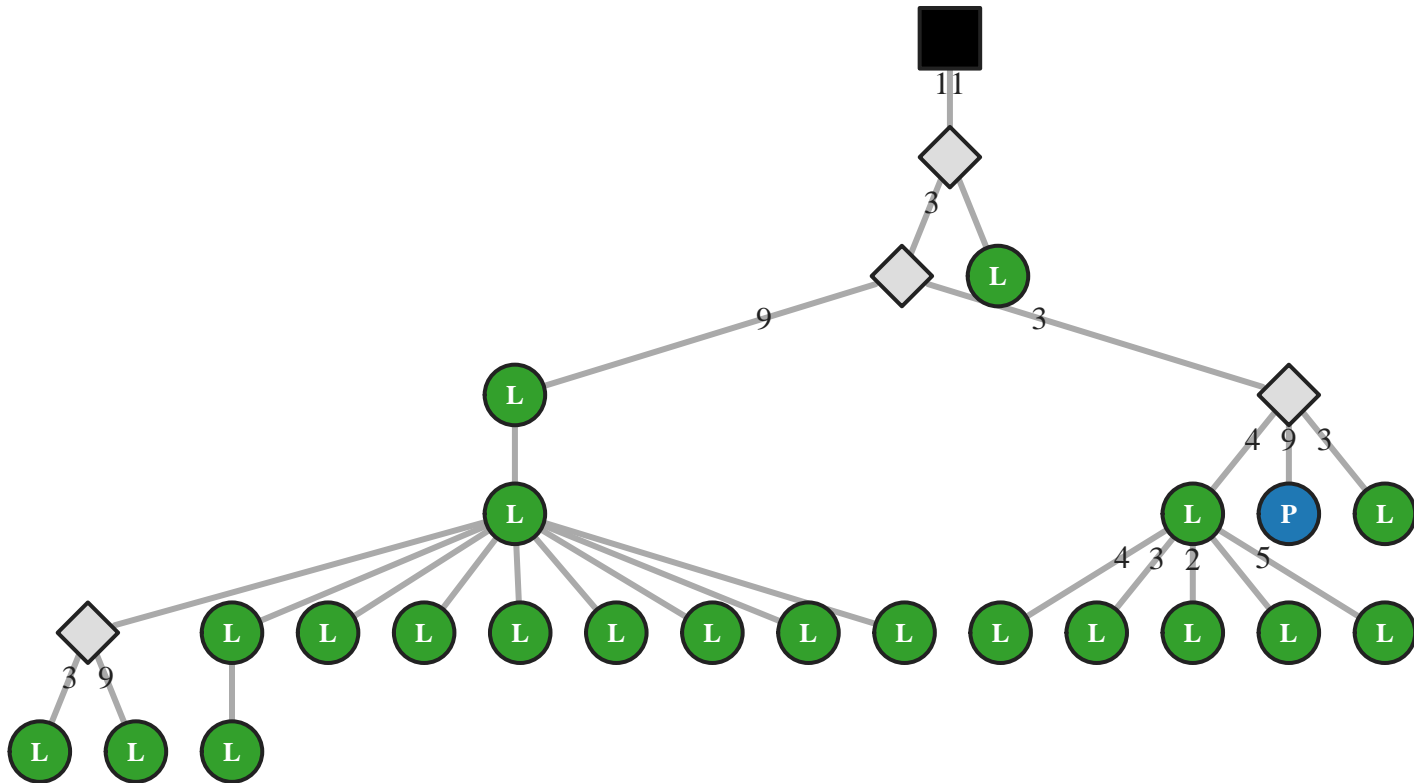

M5 IgG IGHV1-2/J4 42bp (31880)

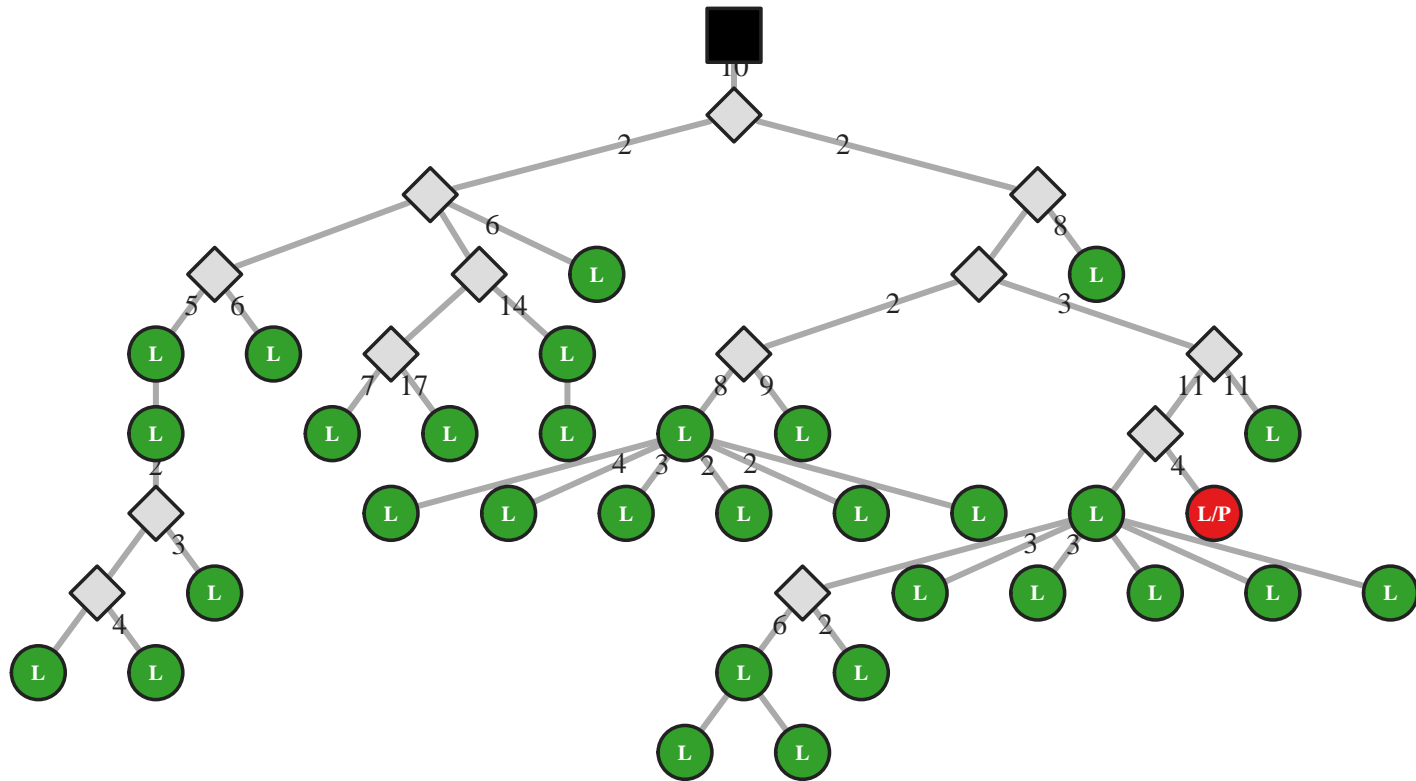

M5 IgG IGHV1-2/J4 42bp (31881)

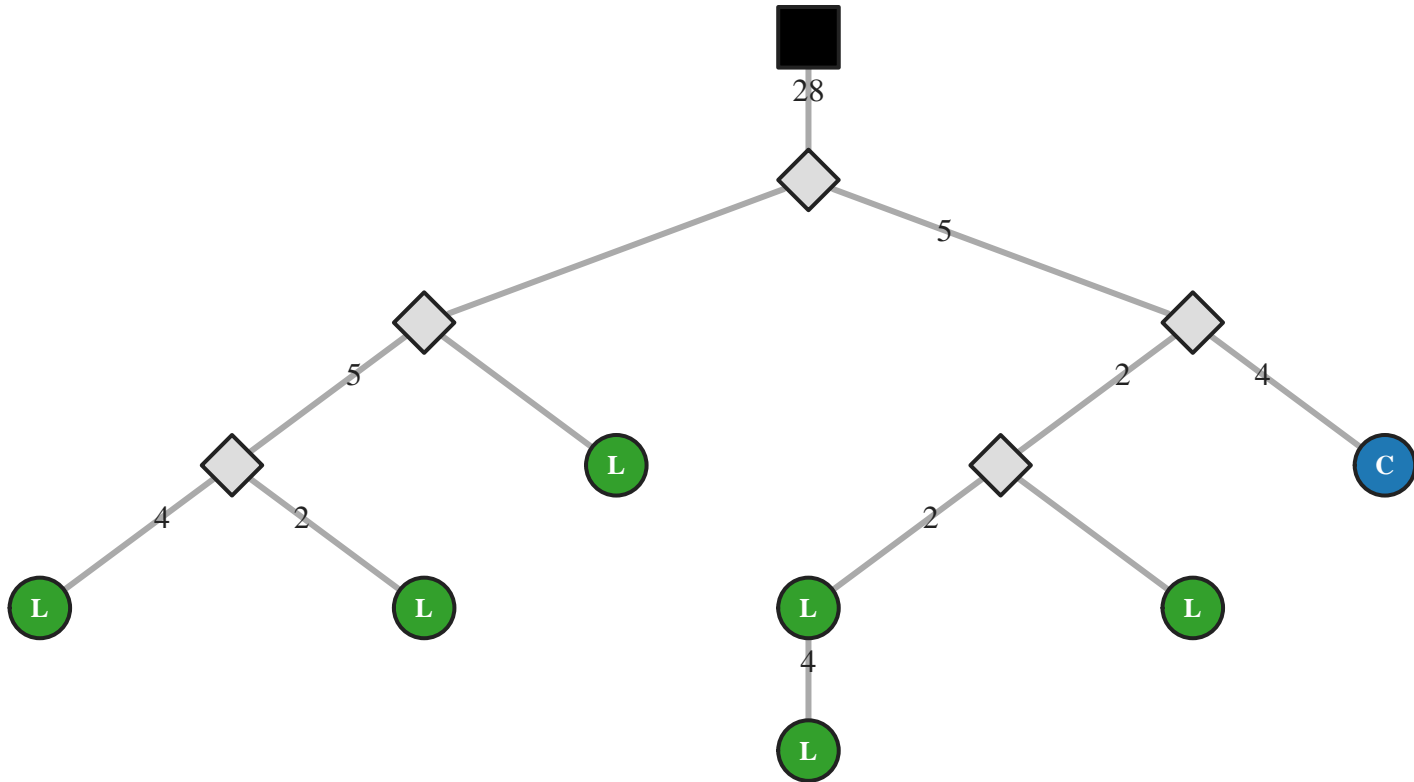

M5 IgM IGHV1-2/J4 42bp (20292)

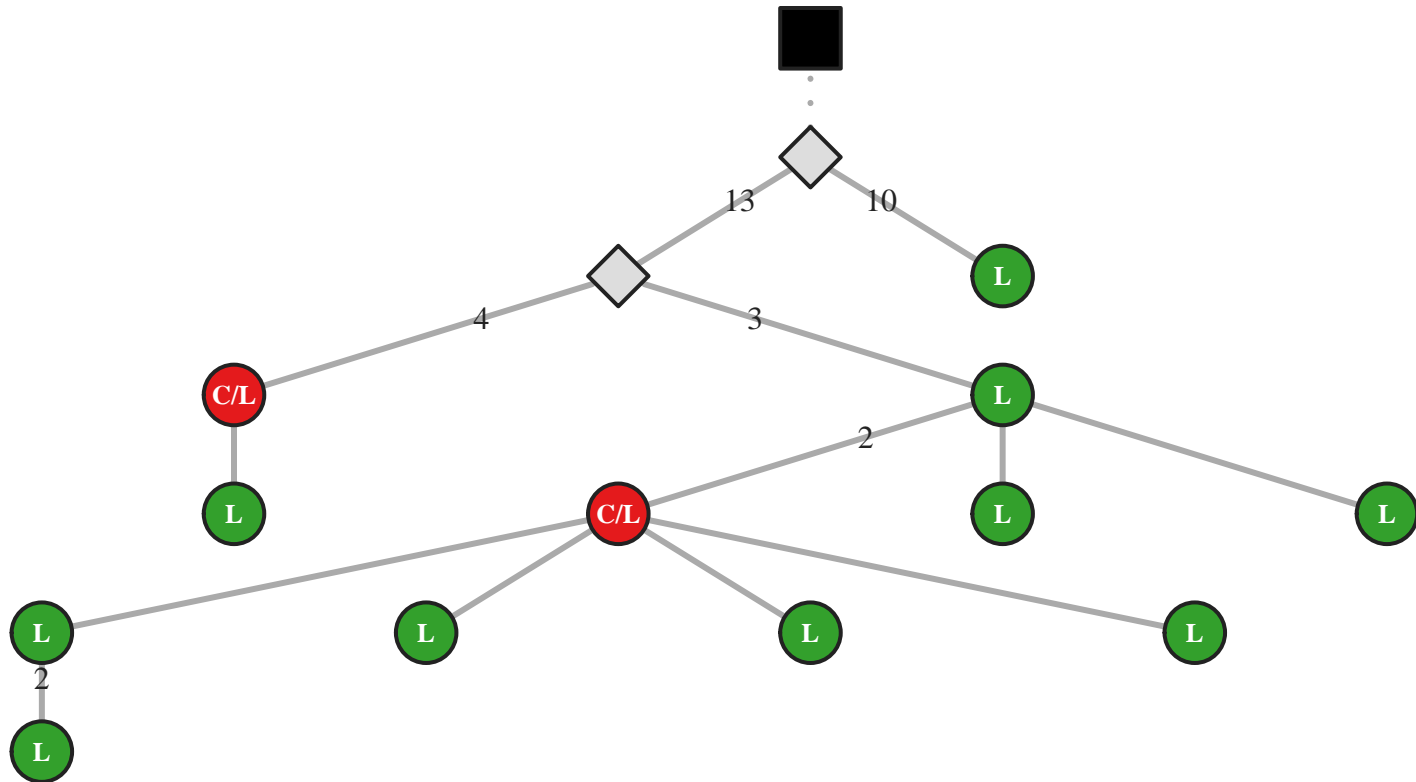

M5 IgA IGHV1-2/J4 45bp (30078)

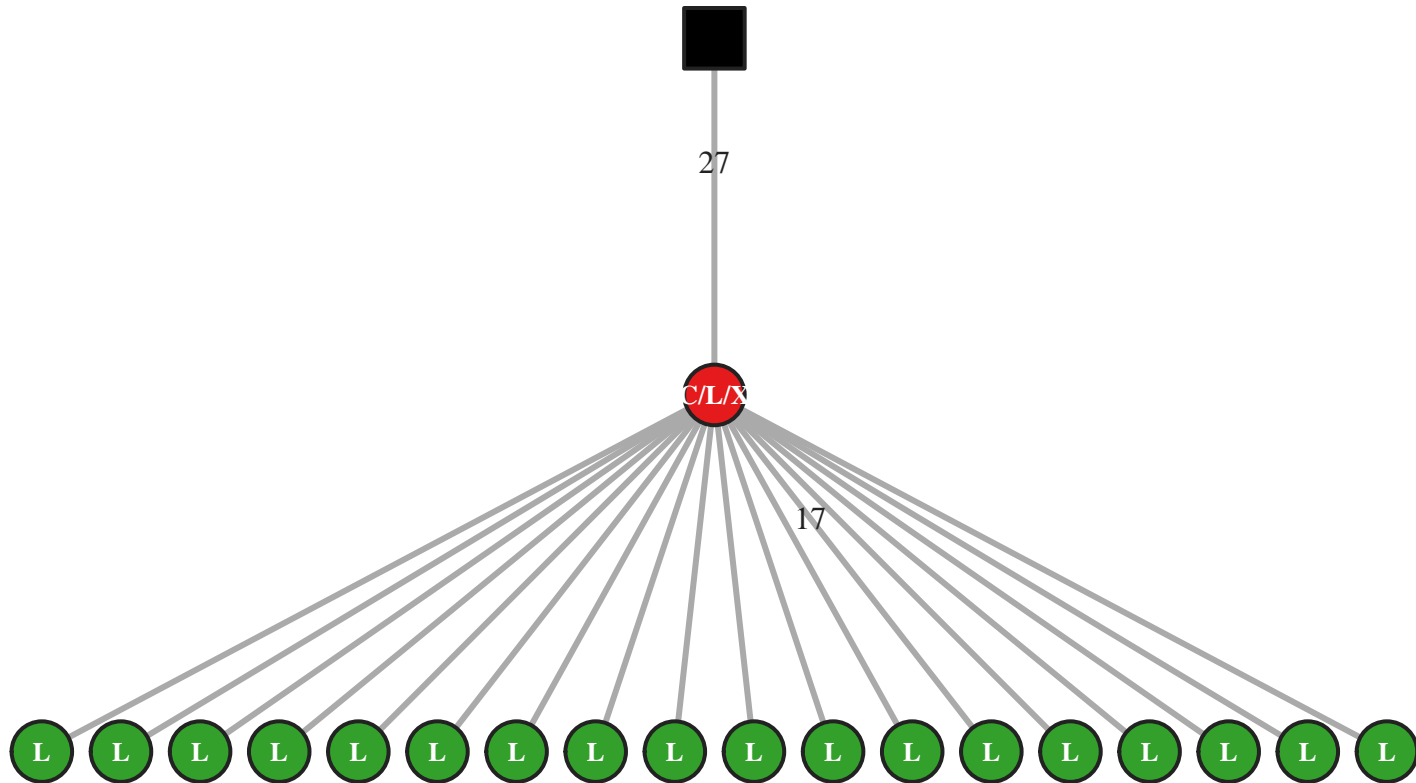

M5 IgA IGHV1-2/J4 45bp (30112)

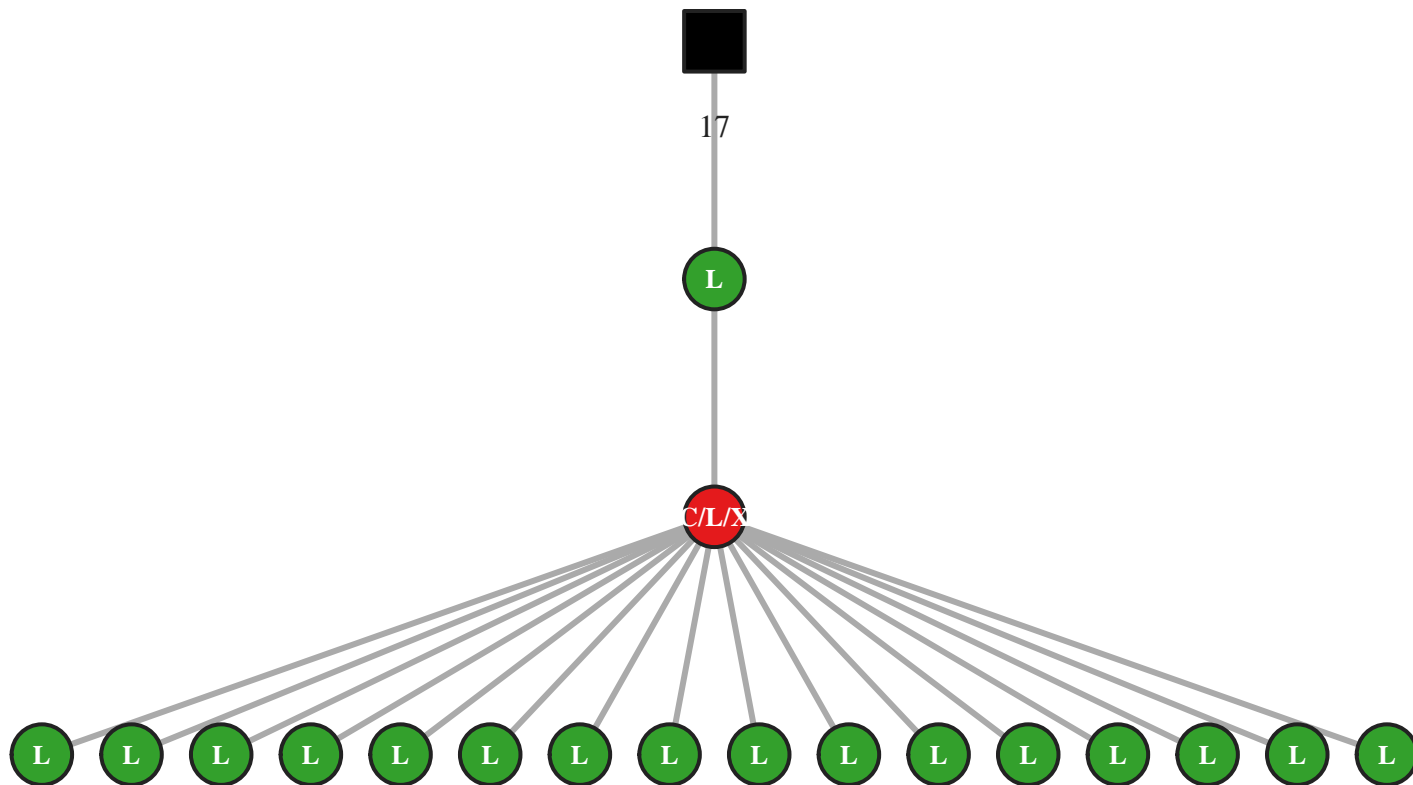

M5 IgG IGHV1-2/J4 45bp (4330)

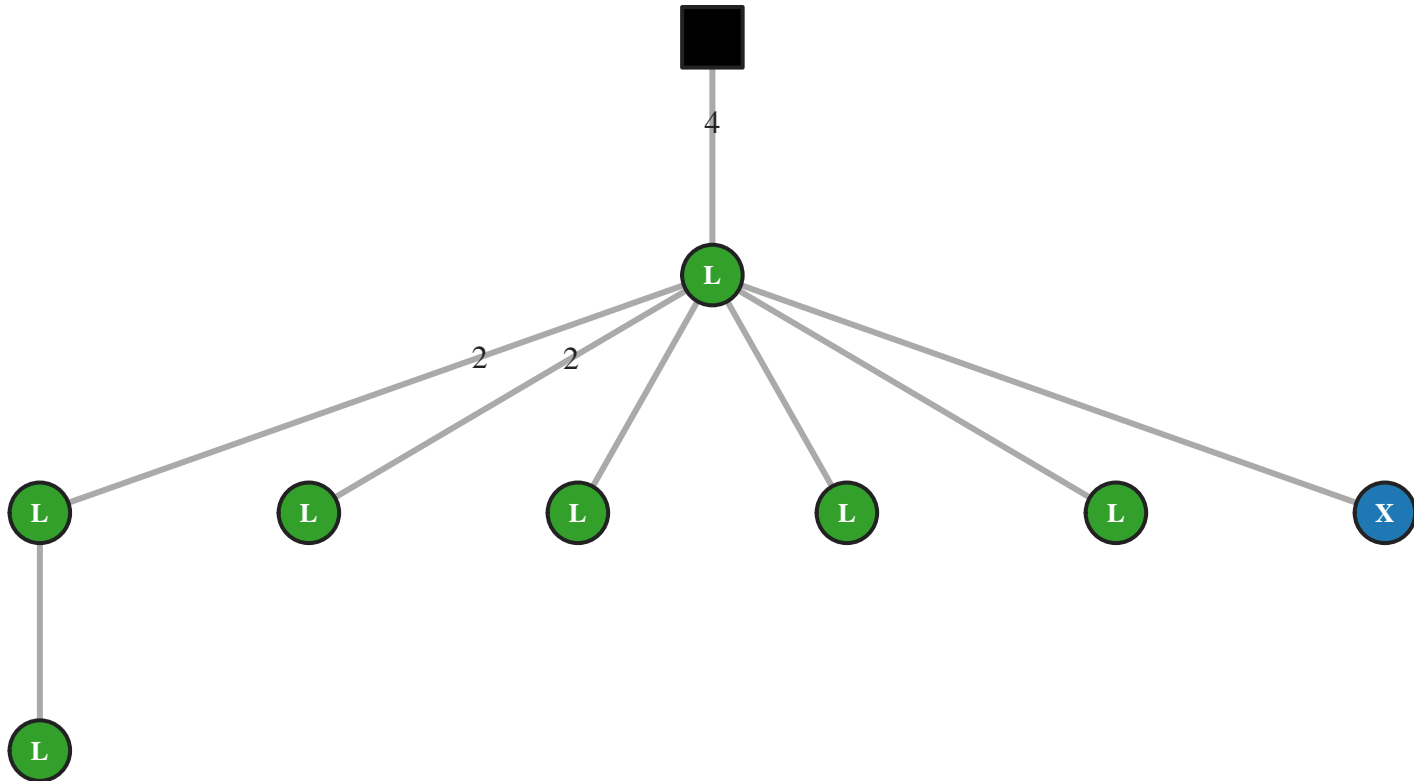

M5 IgG IGHV1-2/J4 45bp (4341)

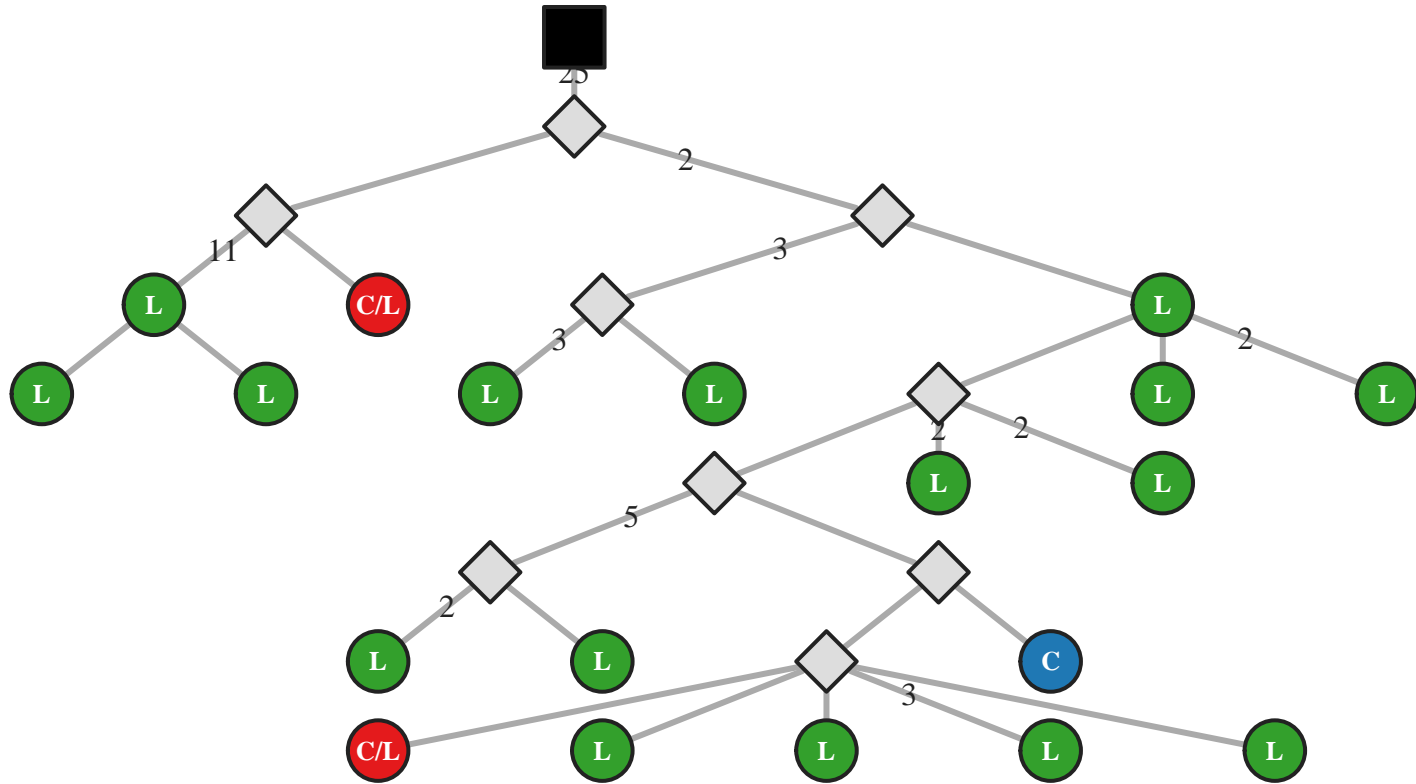

M5 IgG IGHV1-2/J4 45bp (4345)

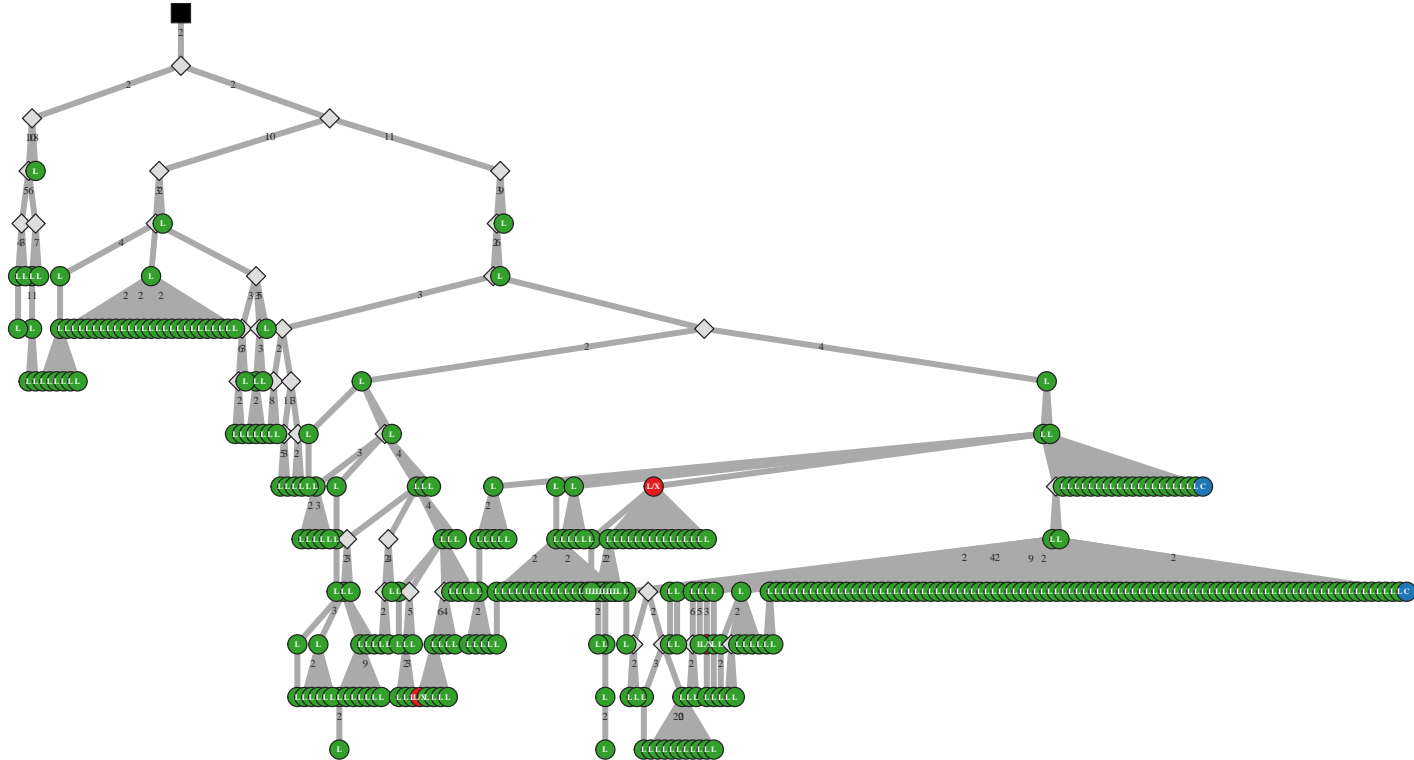

M5 IgG IGHV1-2/J4 45bp (4349)

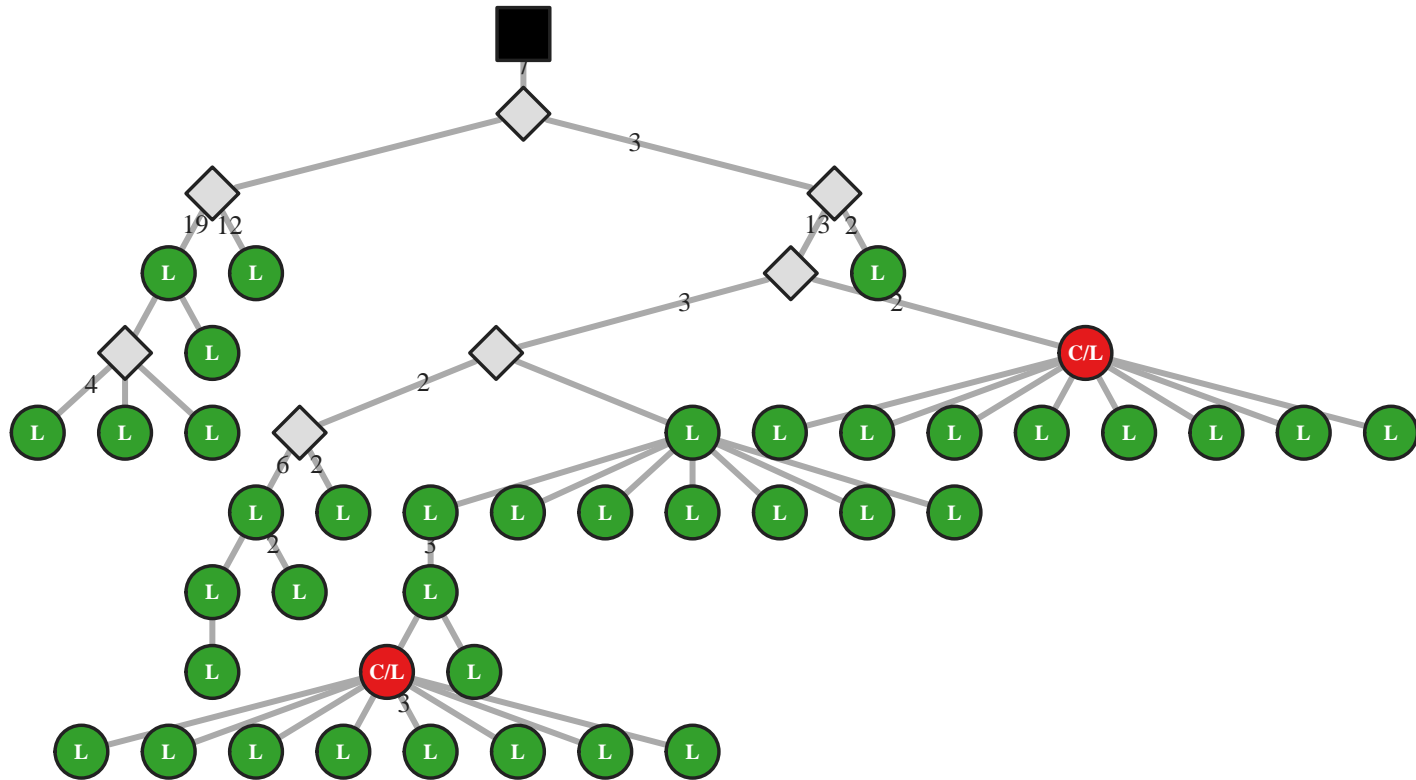

M5 IgA IGHV1-2/J4 48bp (11847)

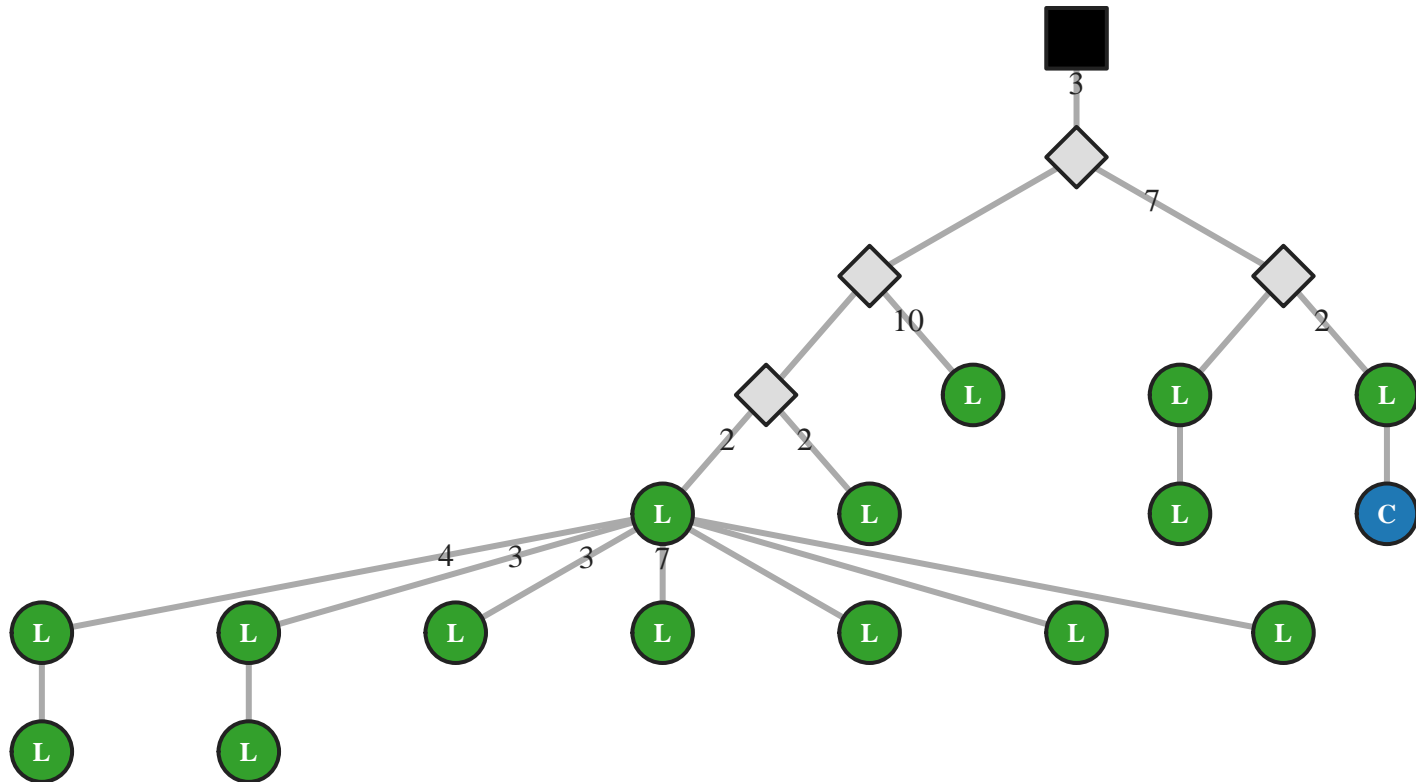

M5 IgA IGHV1-2/J4 48bp (11883)

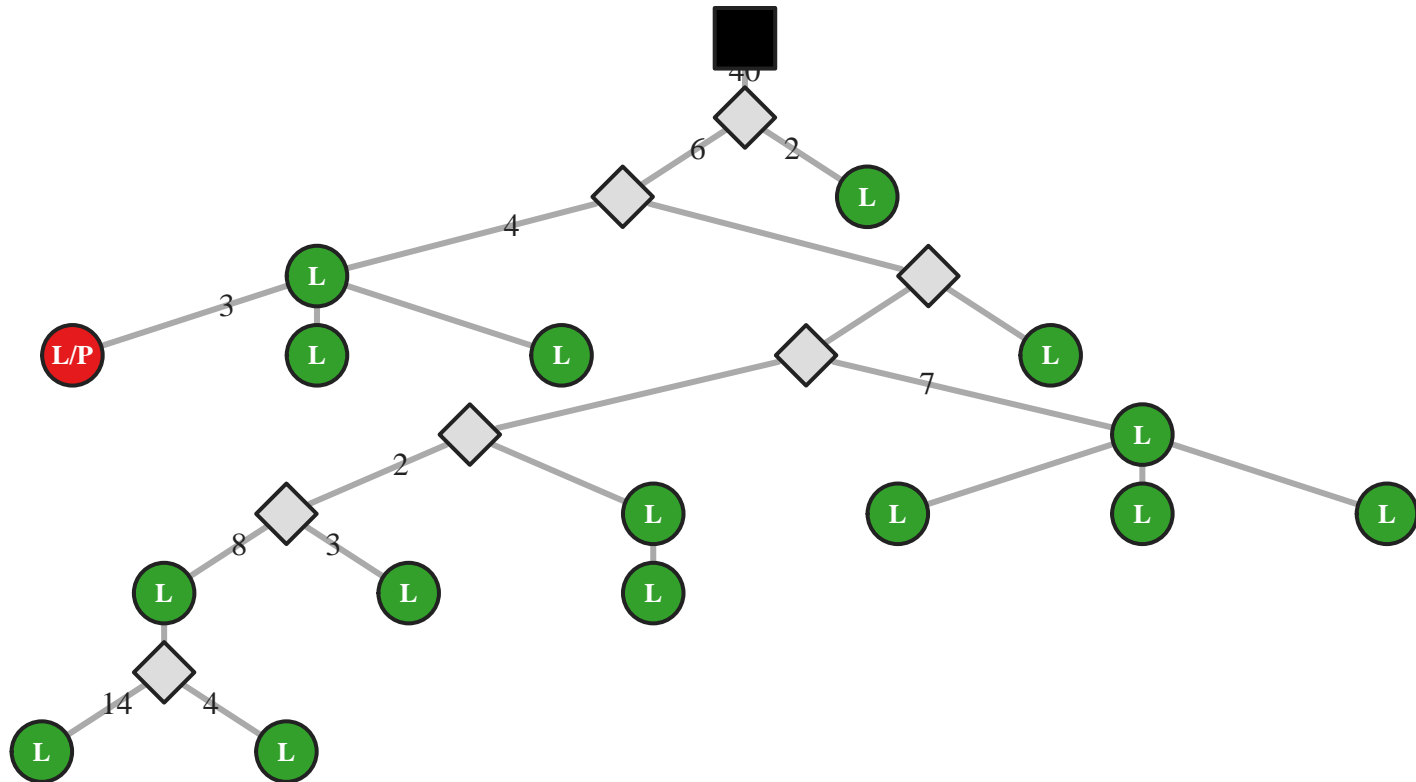

M5 IgG IGHV1-2/J4 48bp (39951)

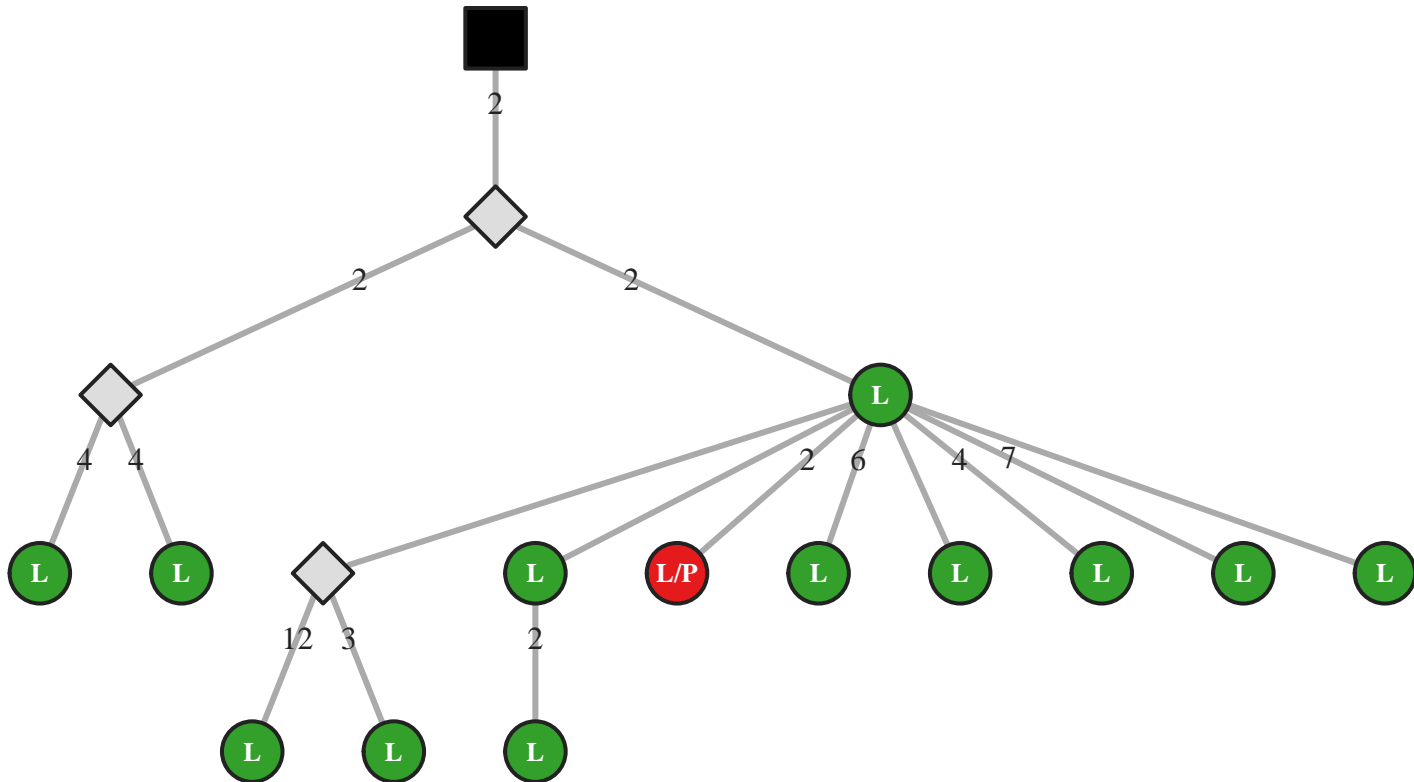

M5 IgG IGHV1-2/J4 48bp (39962)

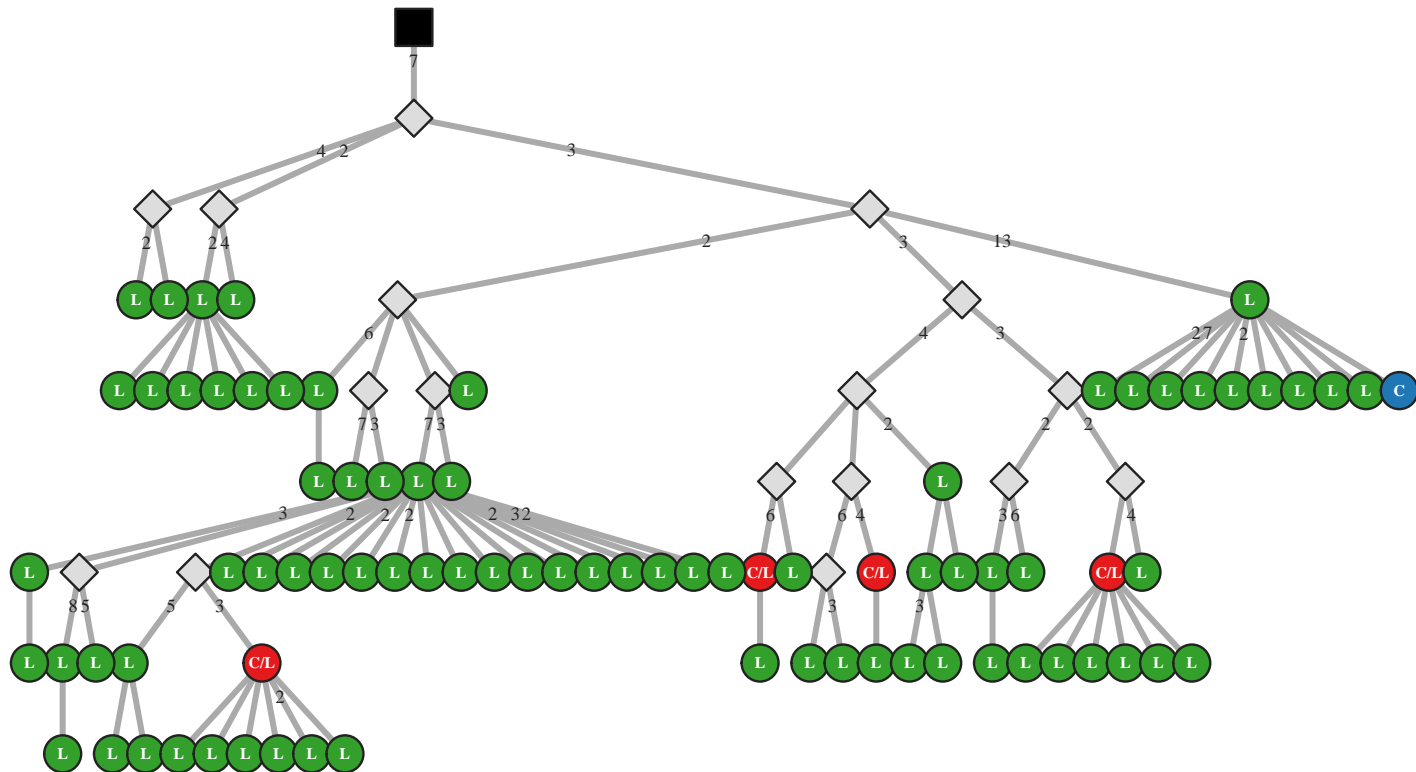

M5 IgA IGHV1-2/J4 51bp (11892)

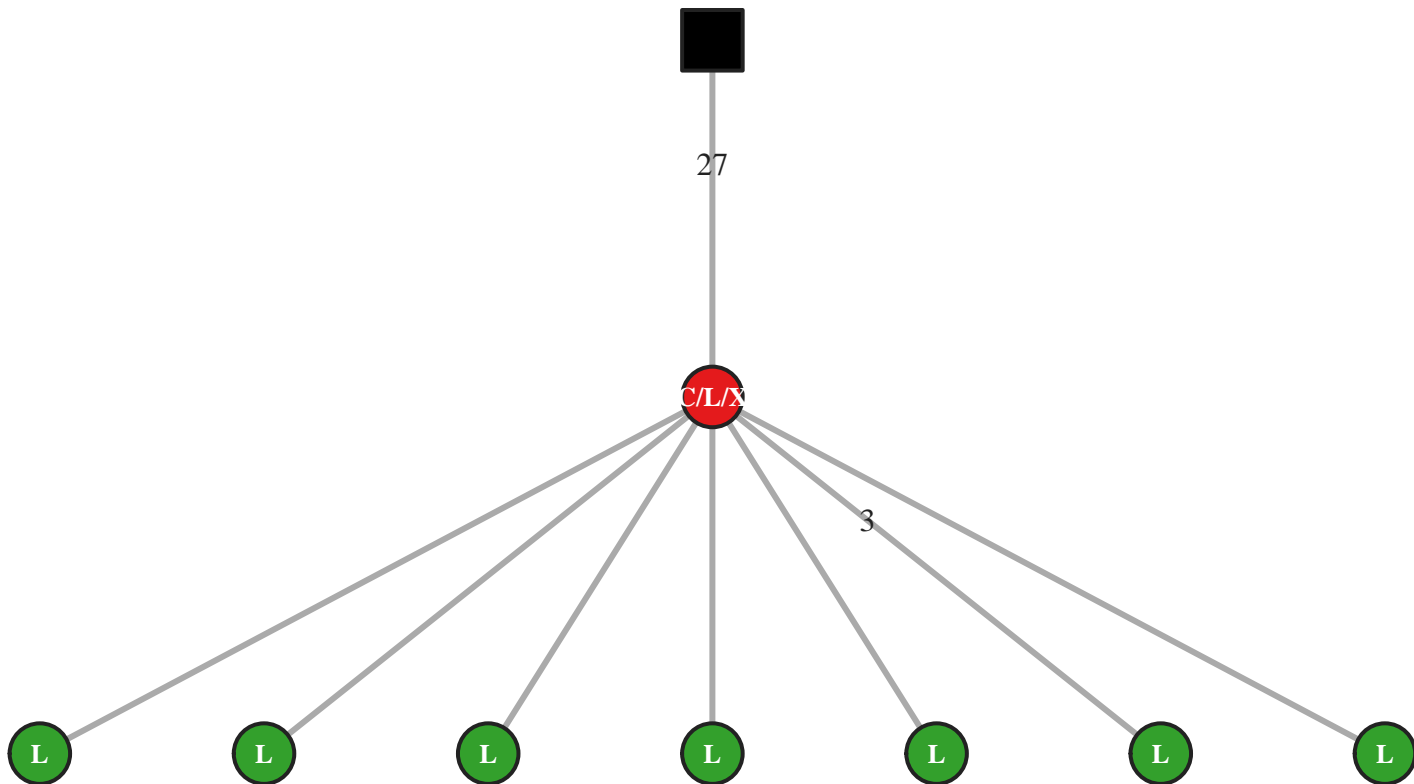

M5 IgG IGHV1-2/J4 51bp (40084)

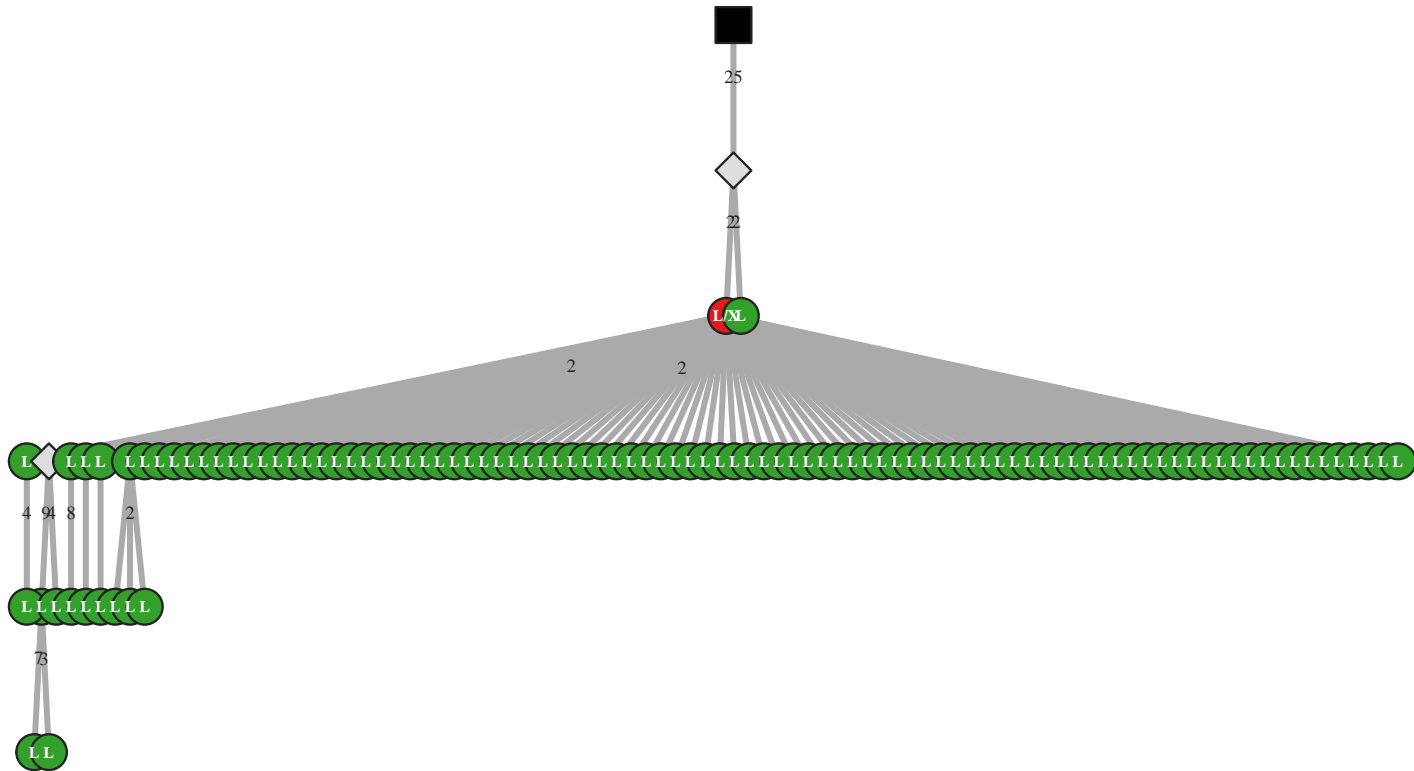

M5 IgG IGHV1-2/J4 51bp (40091)

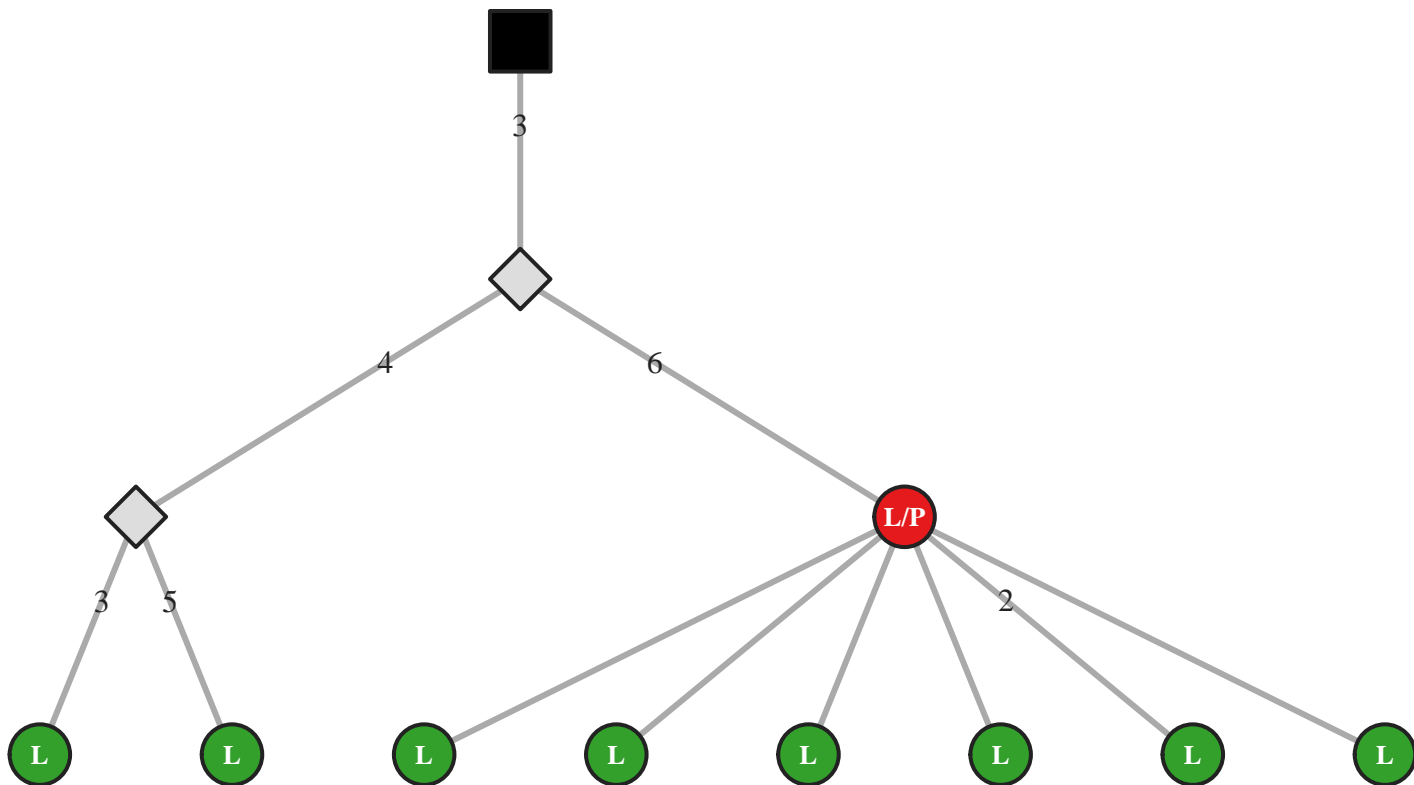

M5 IgG IGHV1-2/J4 51bp (40093)

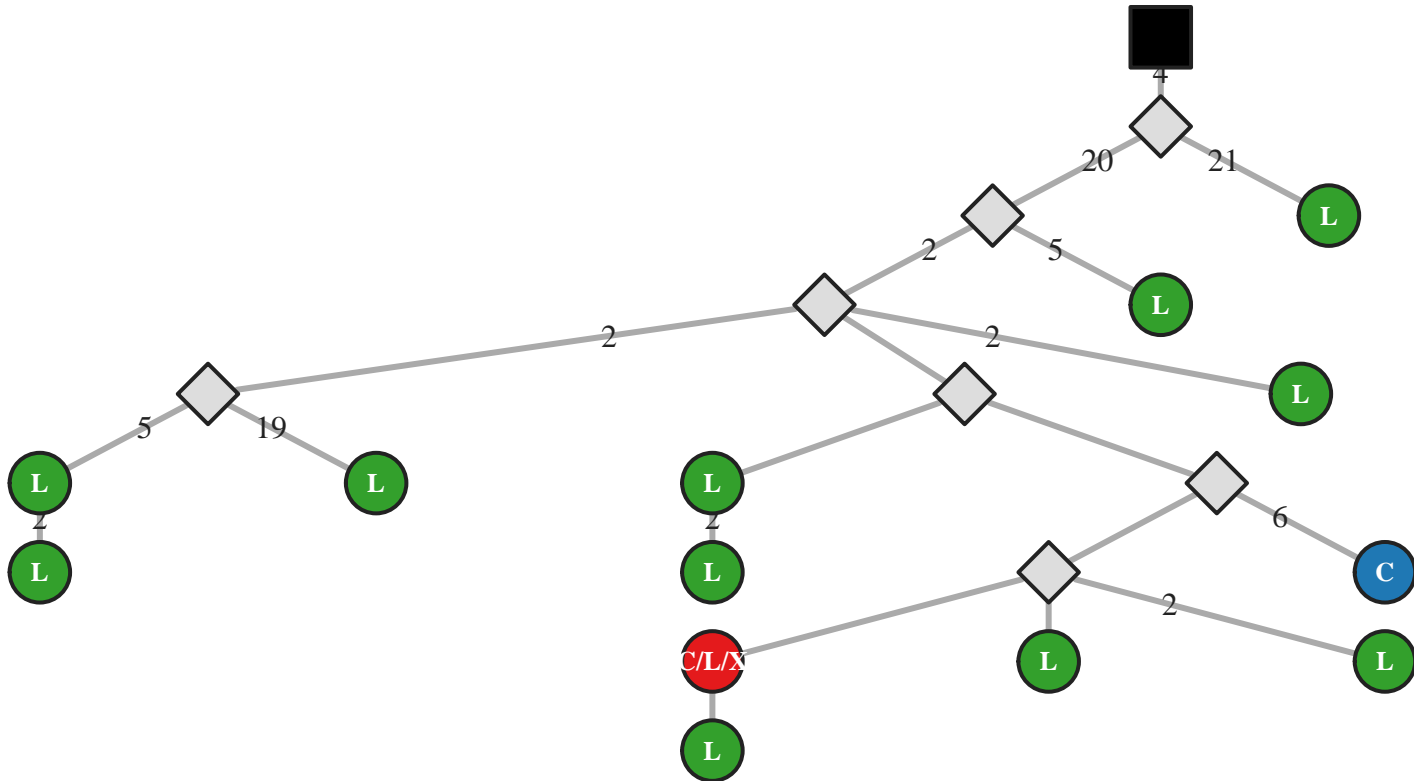

M5 IgG IGHV1-2/J4 51bp (40101)

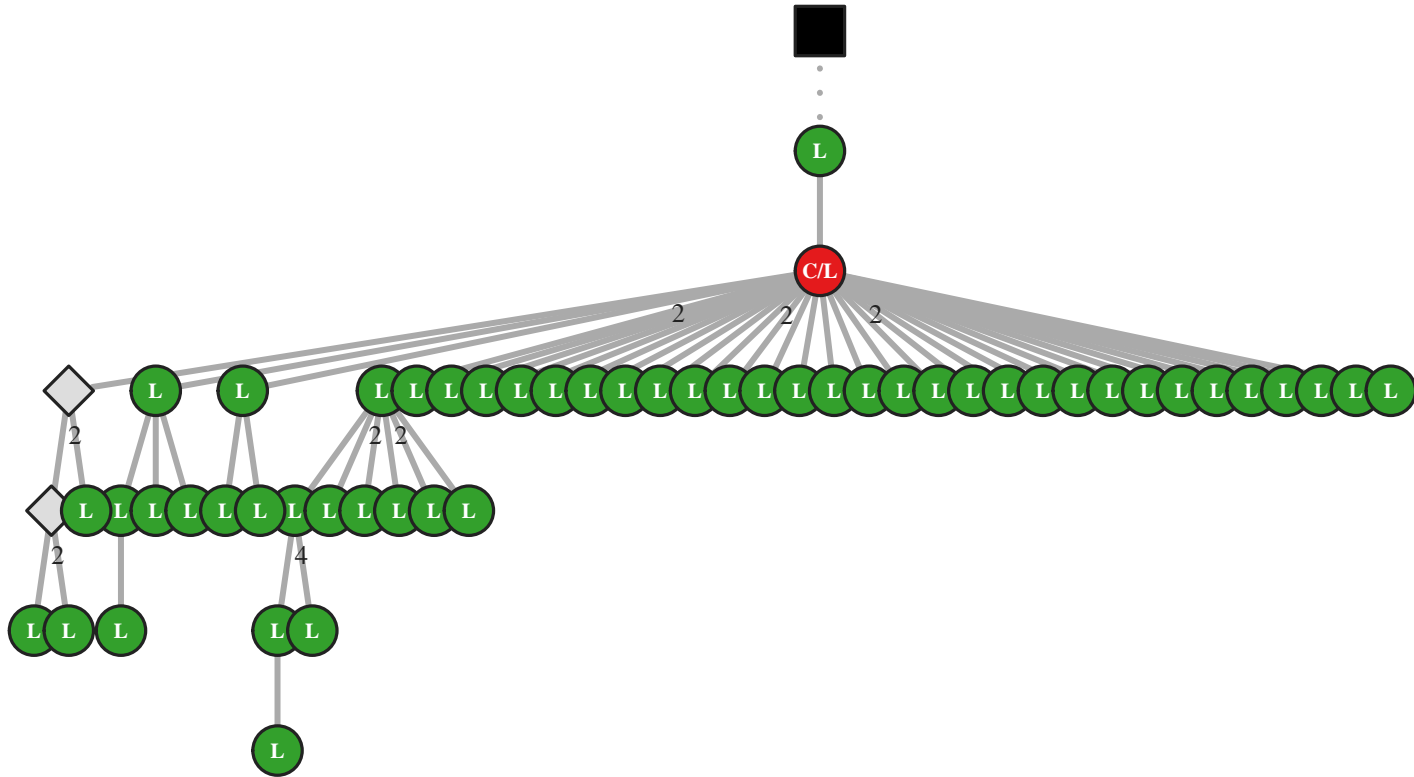

M5 IgM IGHV1-2/J4 51bp (10907)

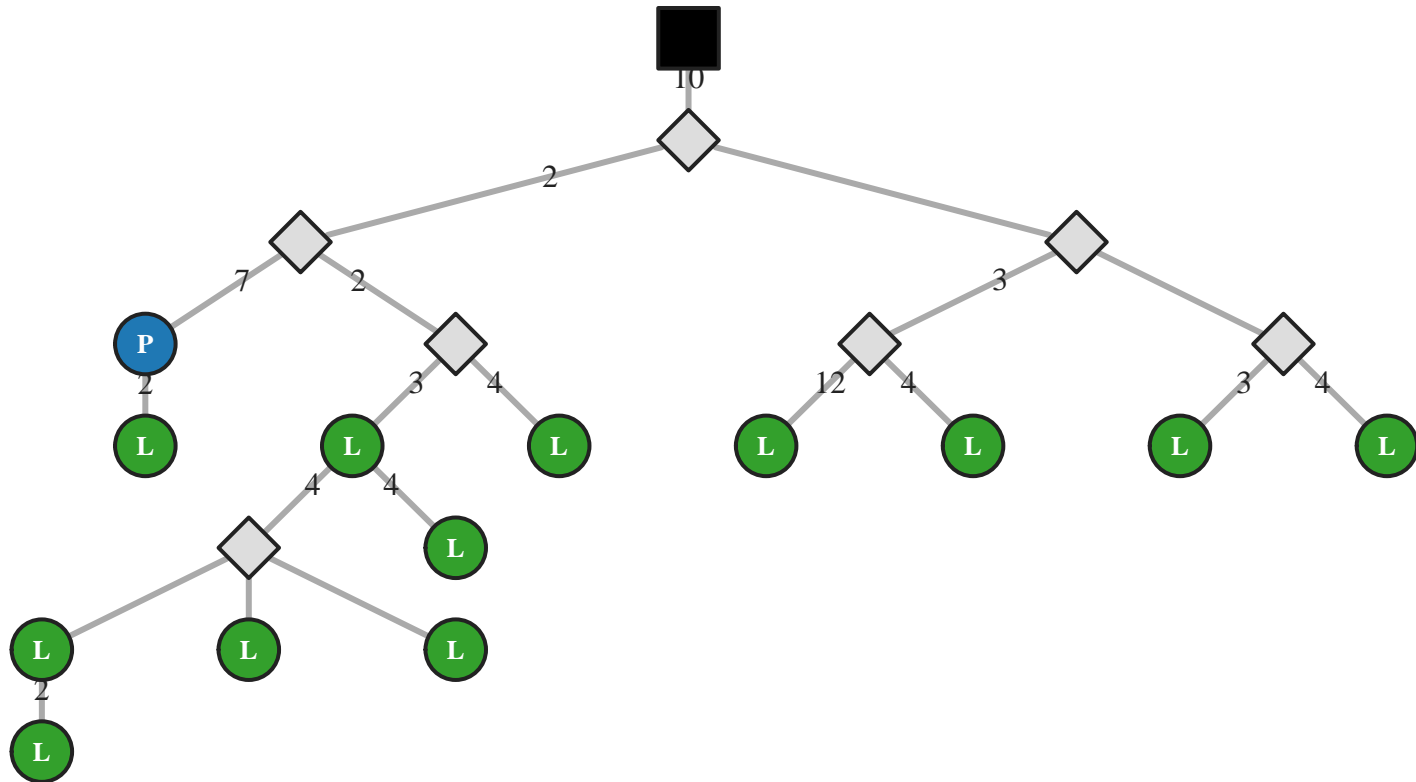

M5 IgM IGHV1-2/J4 51bp (10910)

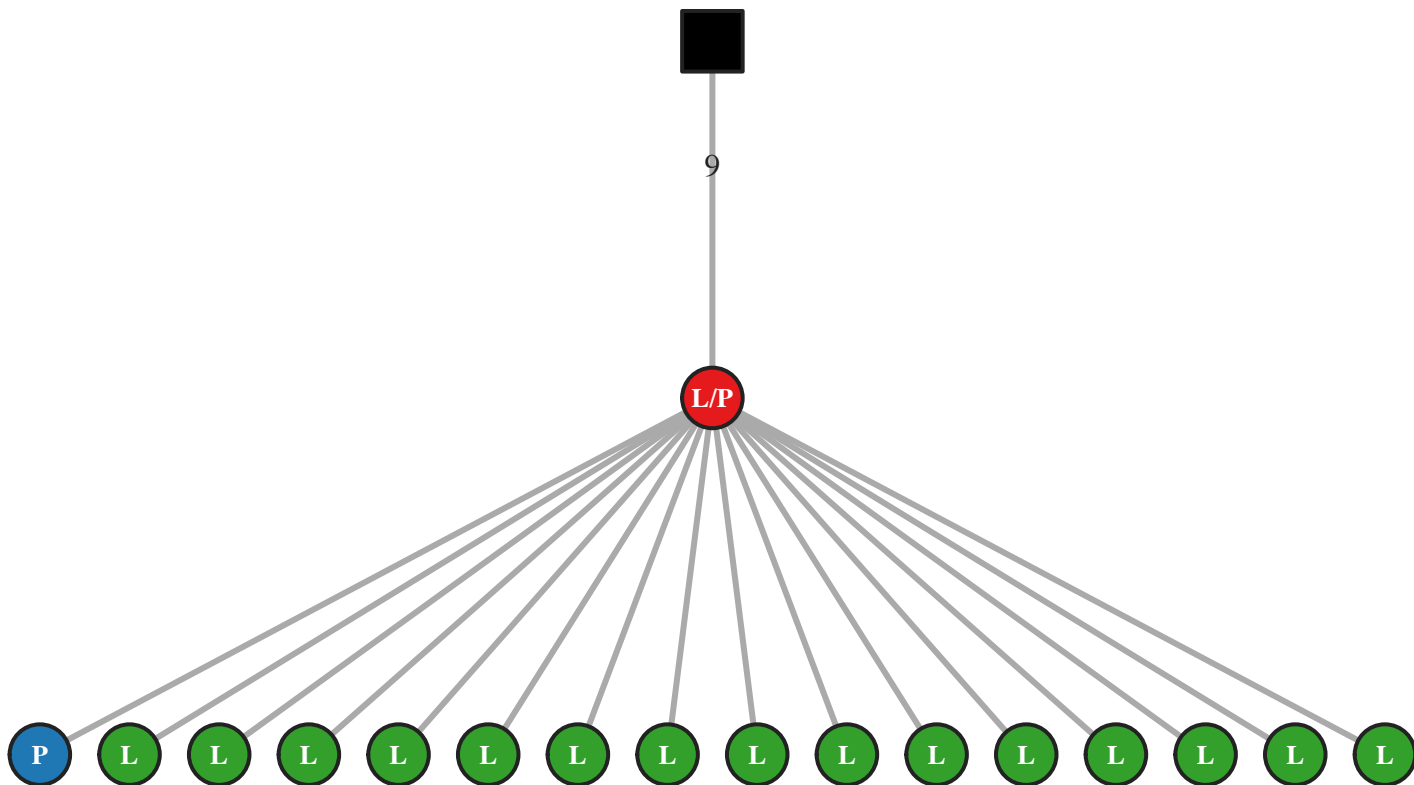

M5 IgA IGHV1-2/J4 54bp (38239)

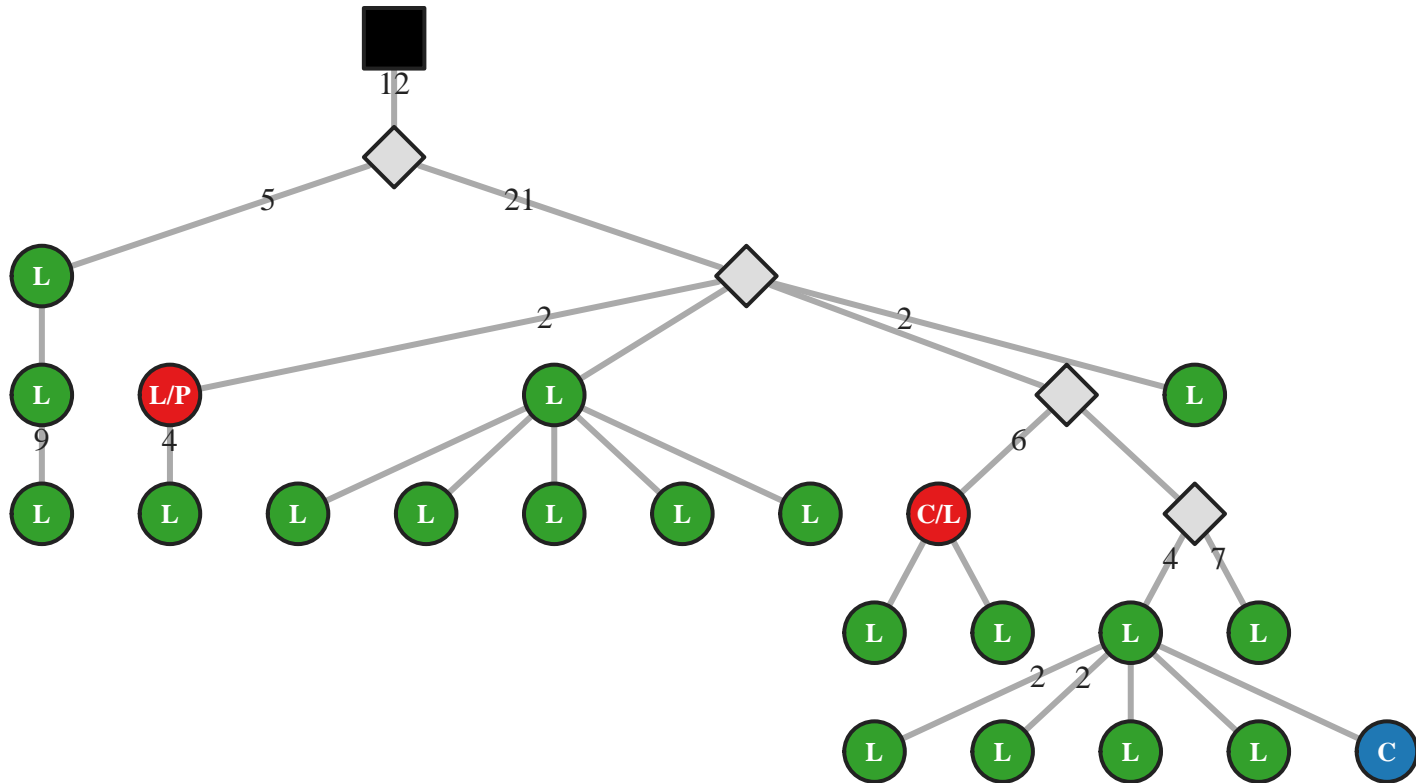

M5 IgG IGHV1-2/J4 54bp (23220)

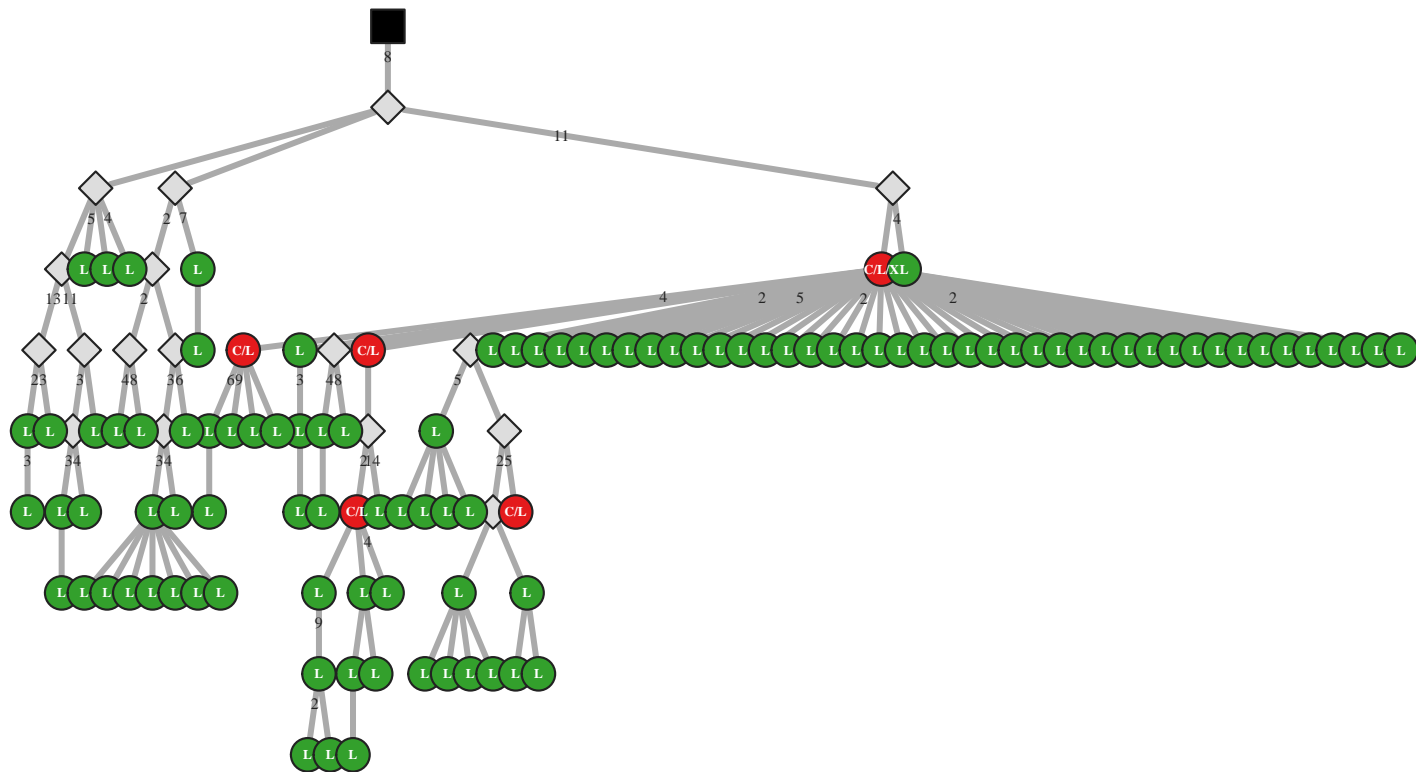

M5 IgA IGHV1-2/J4 57bp (2252)

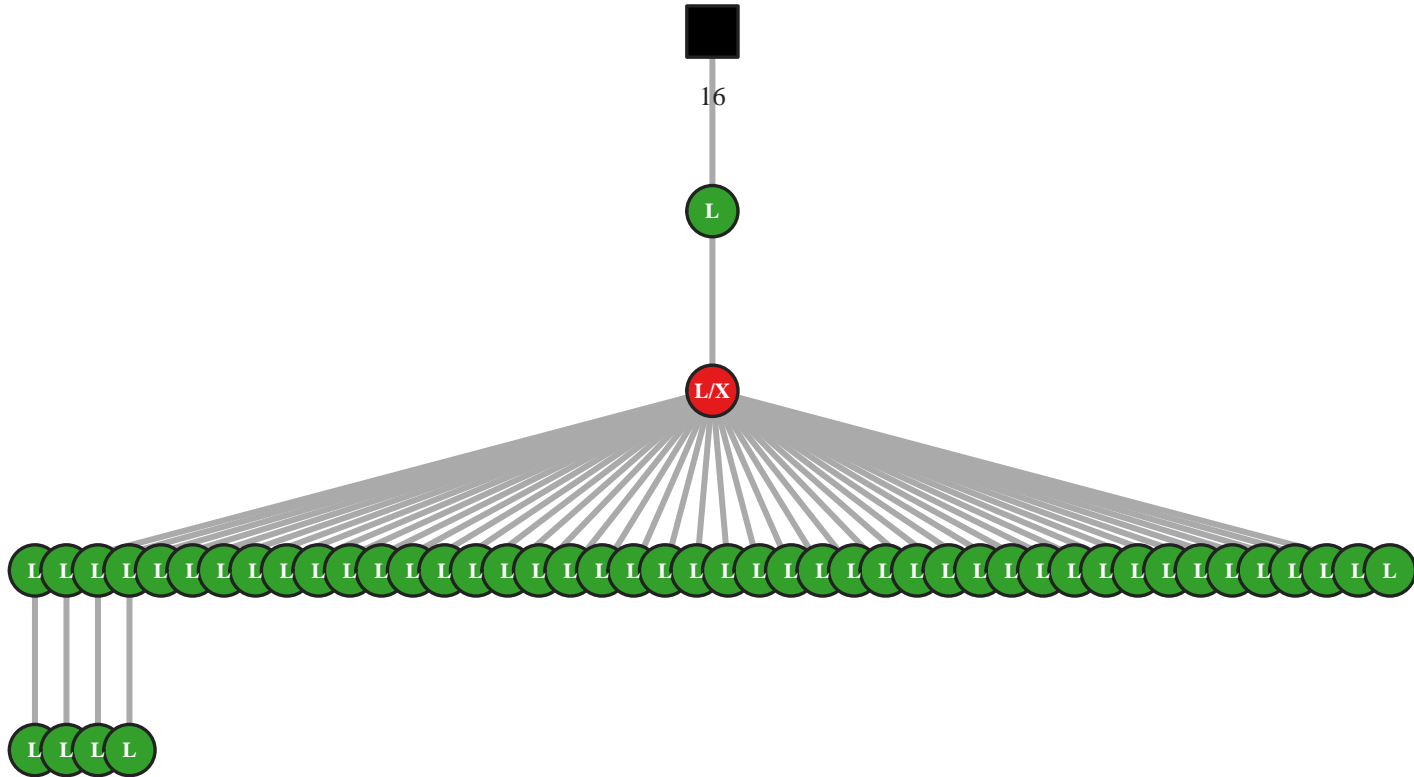

M5 IgG IGHV1-2/J4 57bp (13884)

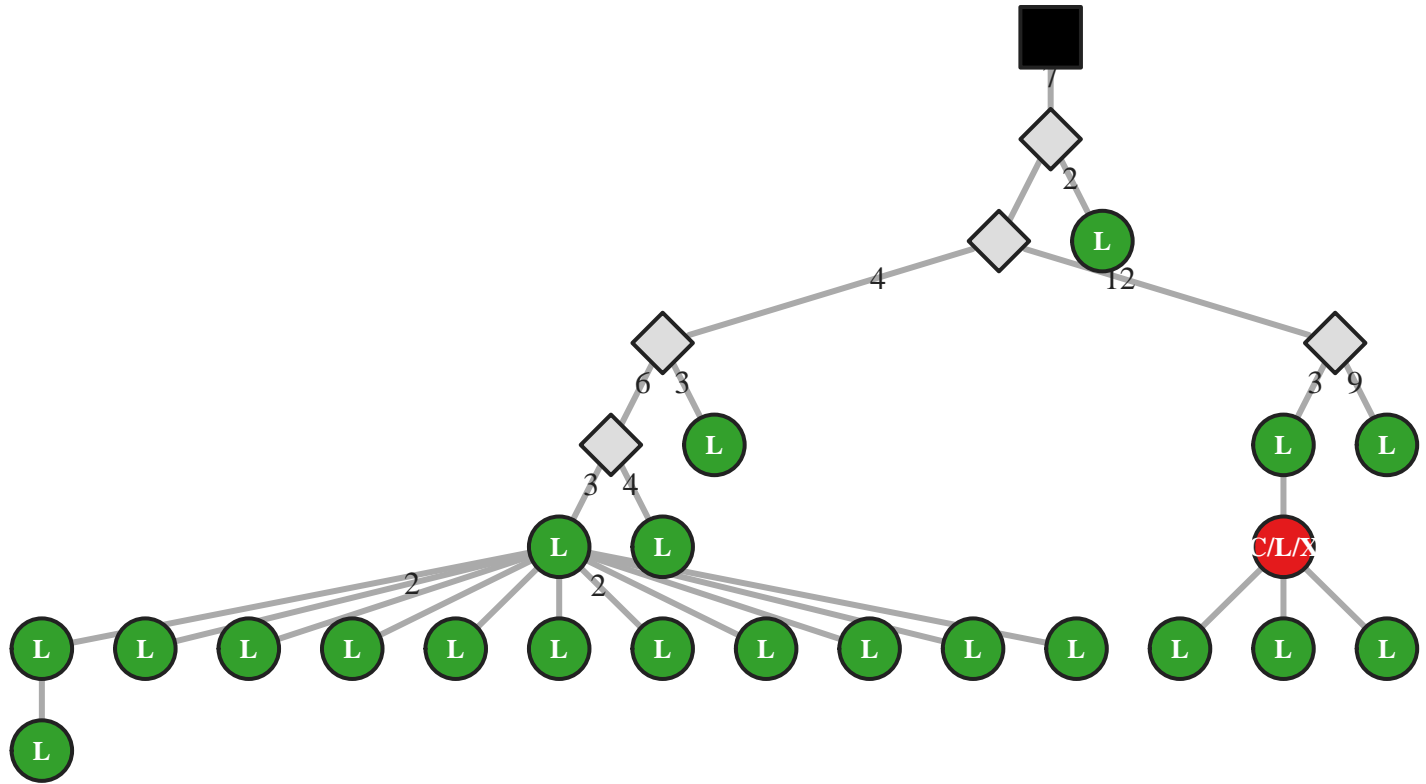

M5 IgG IGHV1-2/J4 57bp (13935)

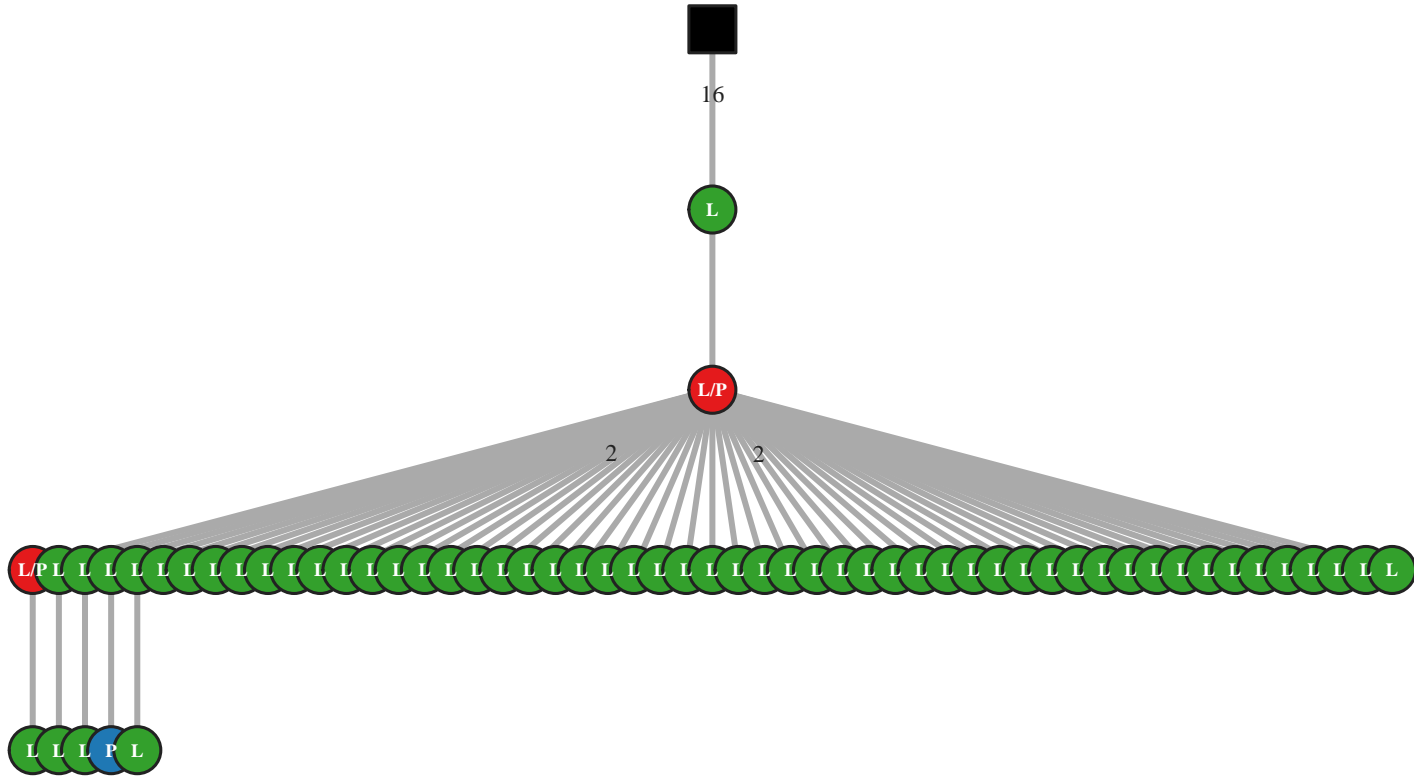

M5 IgA IGHV1-2/J4 60bp (48404)

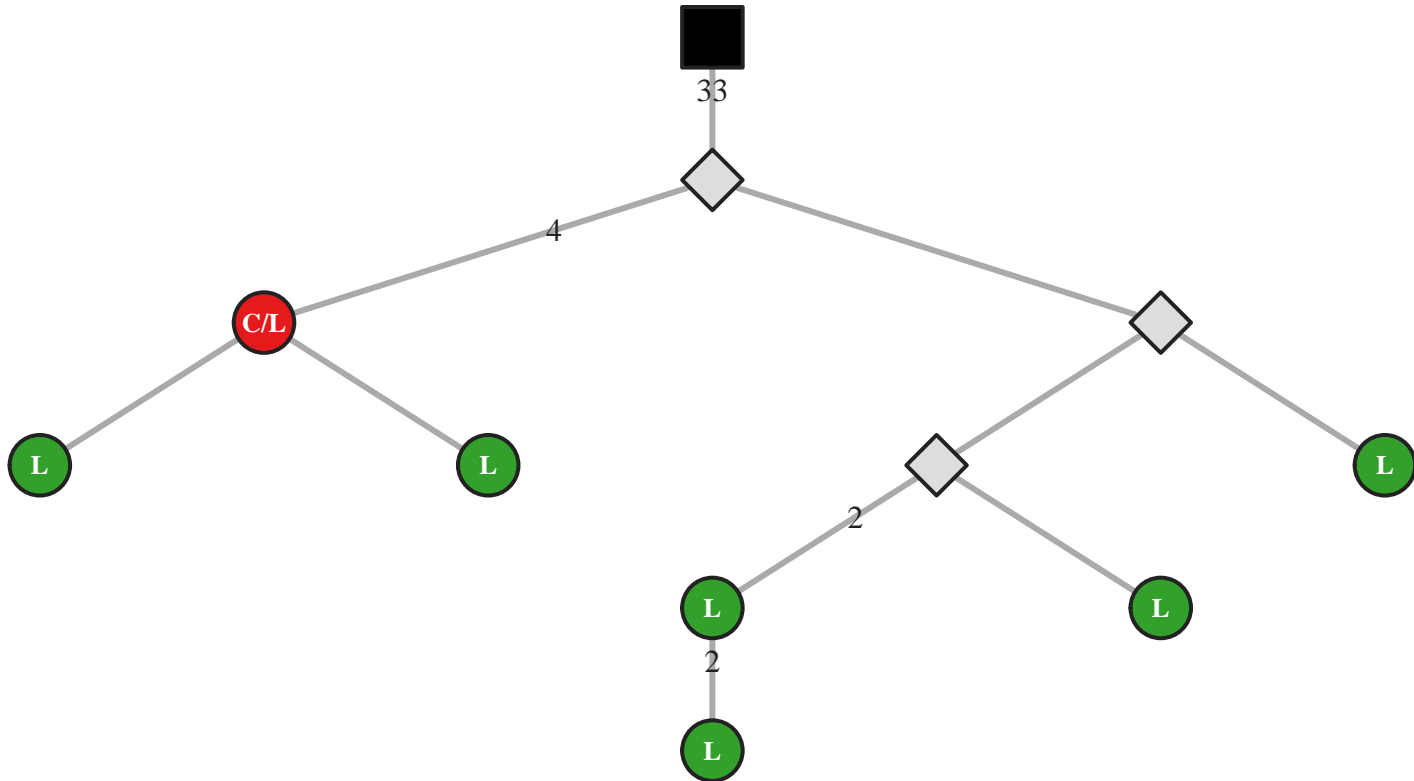

M5 IgG IGHV1-2/J4 60bp (13943)

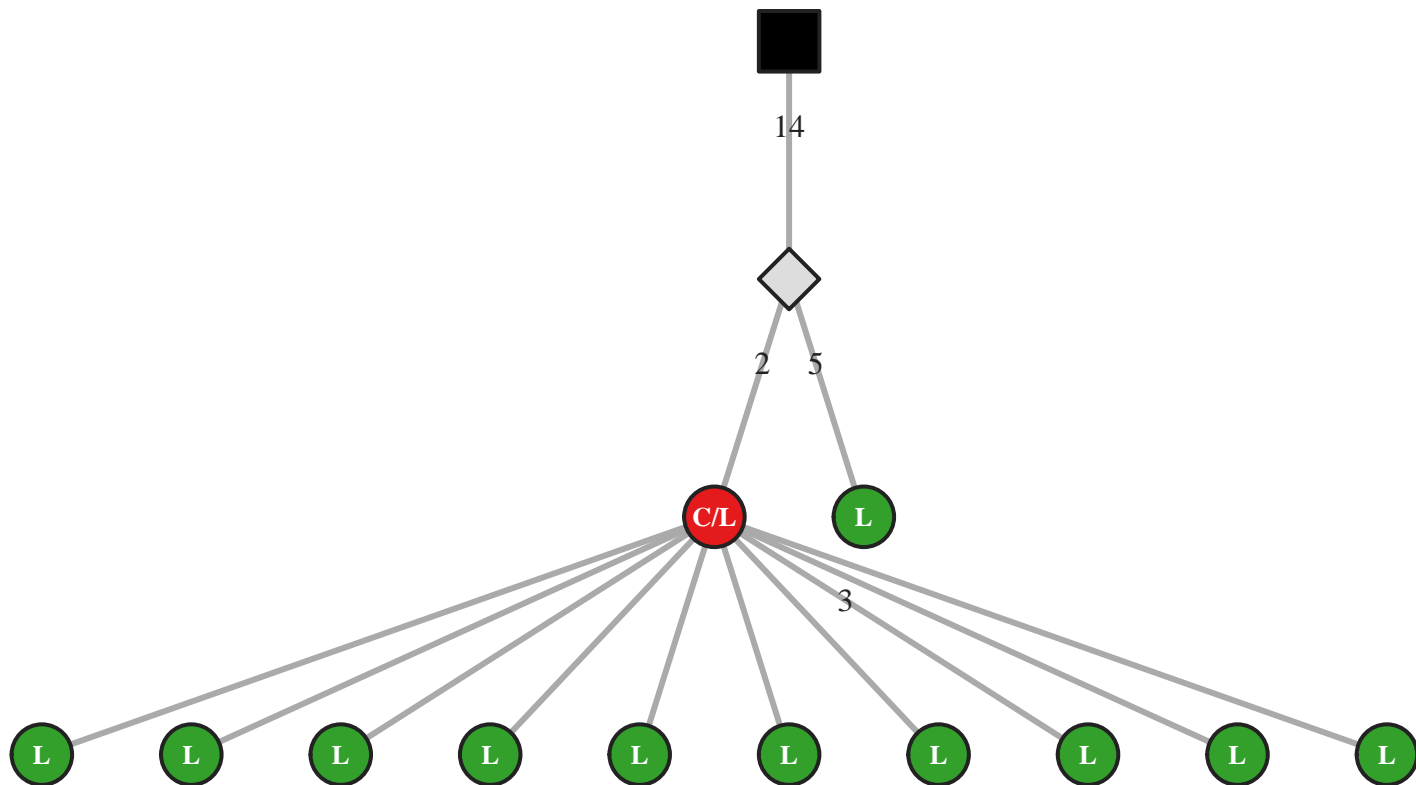

M5 IgG IGHV1-2/J4 60bp (13950)

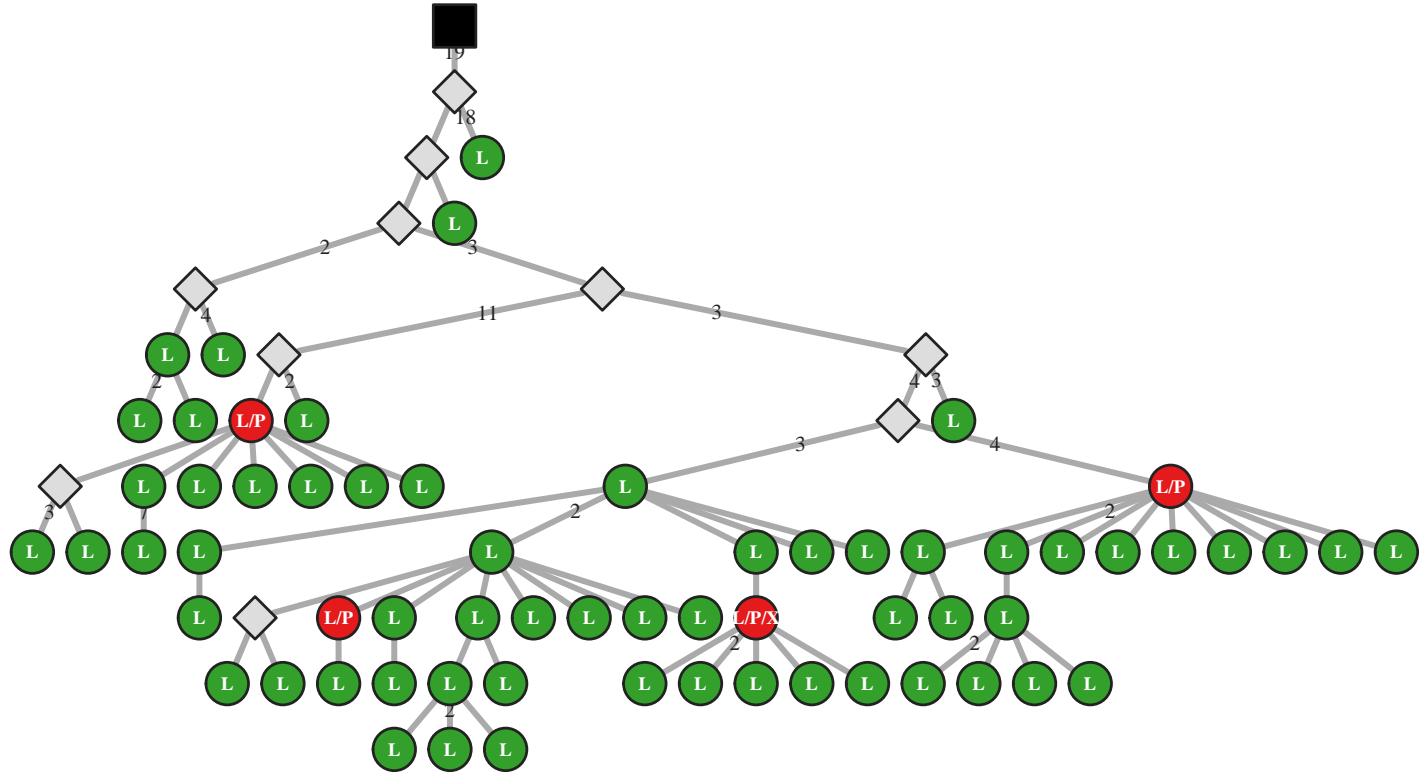

M5 IgG IGHV1-2/J4 60bp (13972)

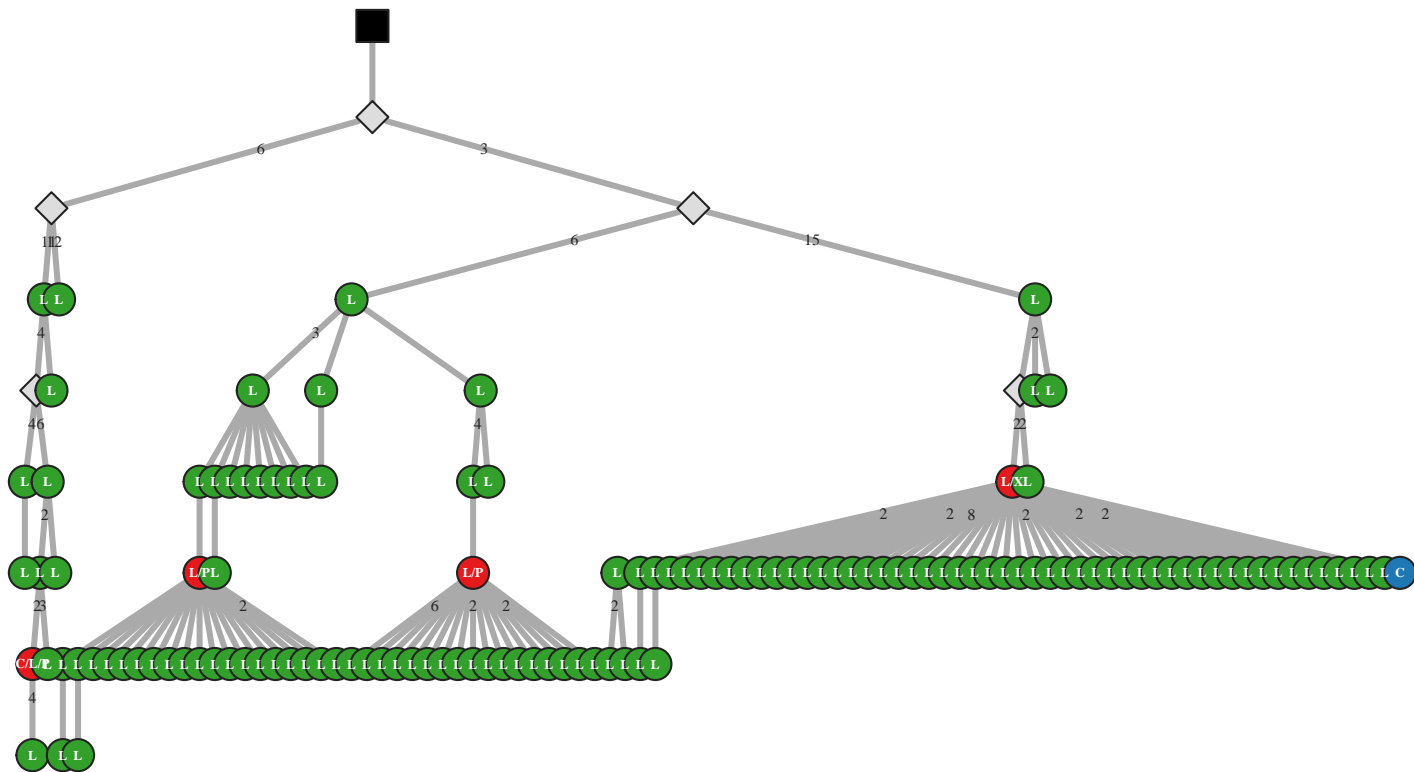

M5 IgG IGHV1-2/J4 60bp (13983)

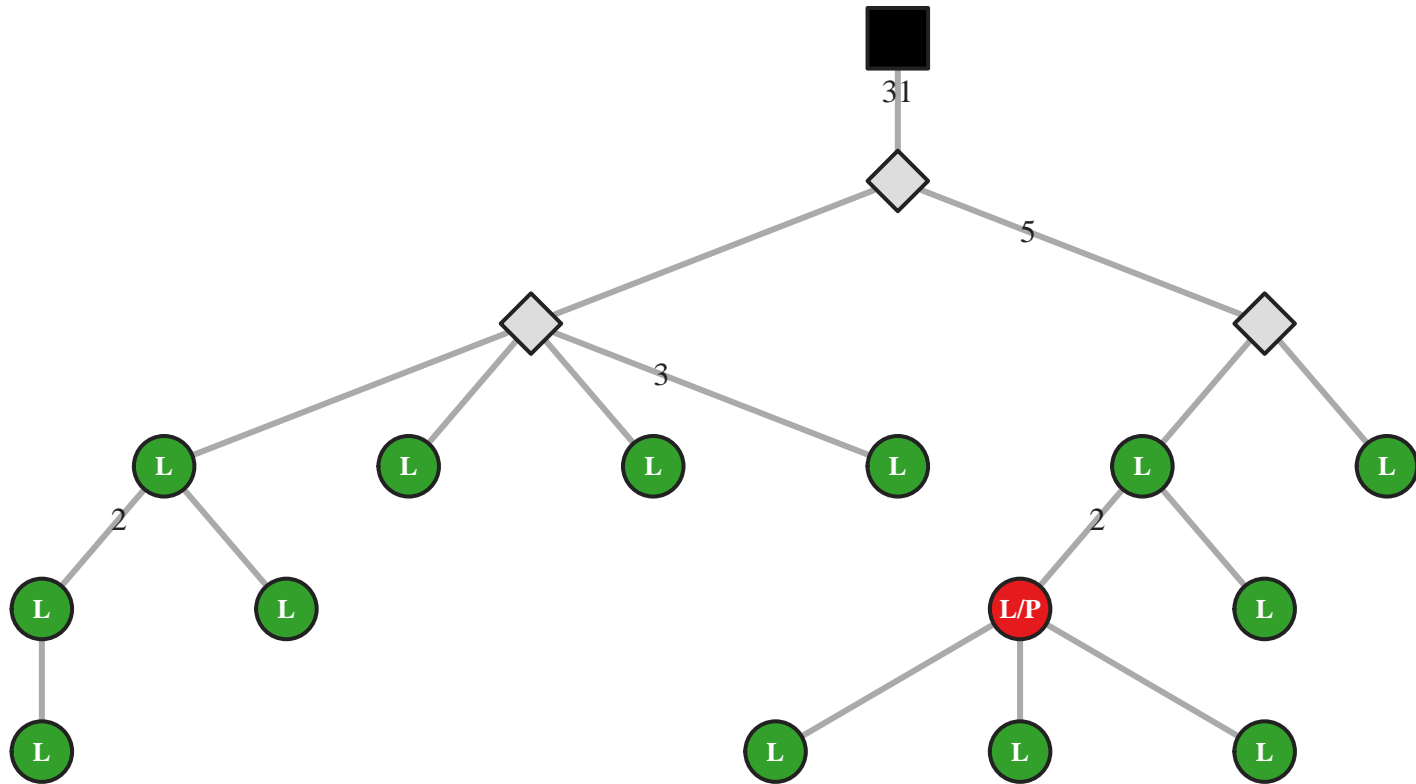

M5 IgA IGHV1-2/J4 63bp (2260)

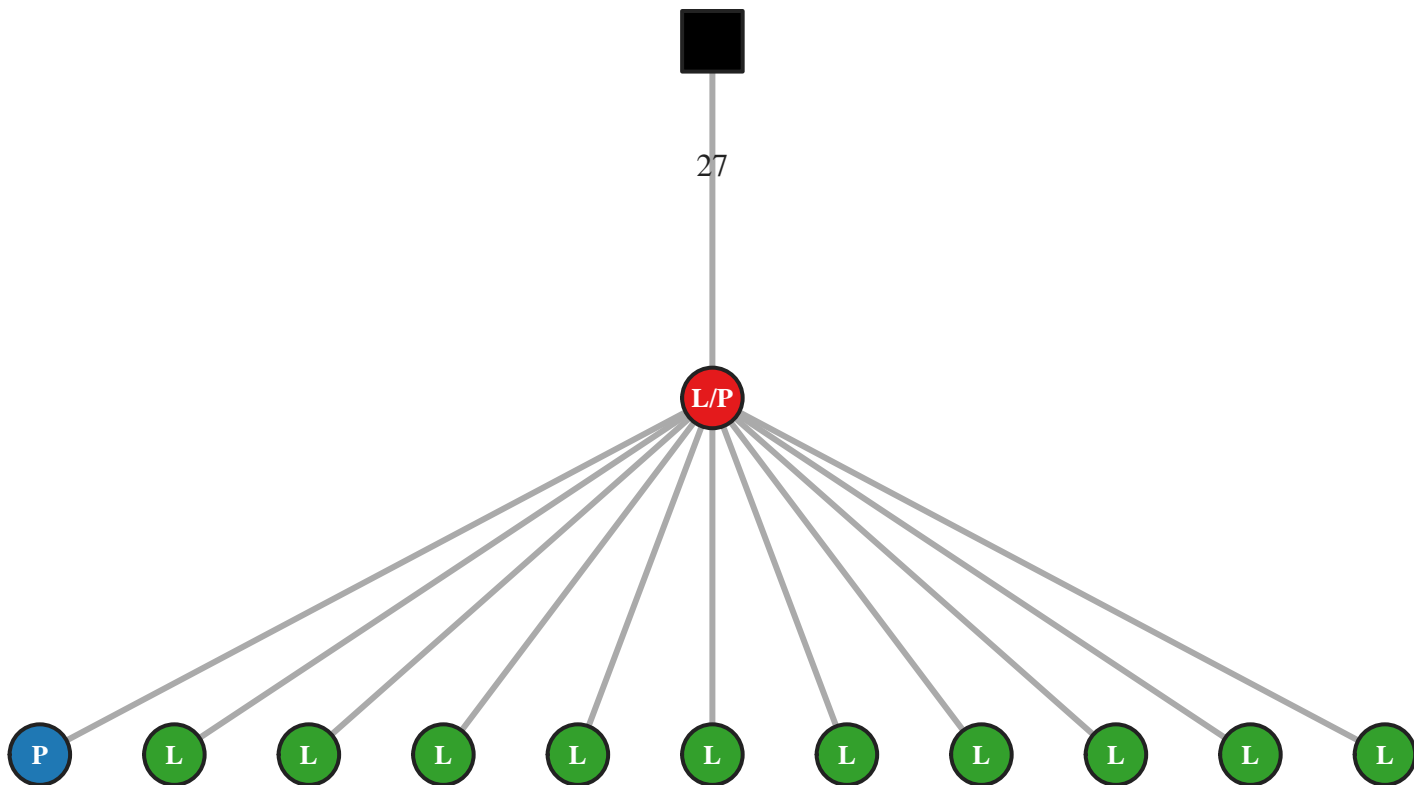

M5 IgG IGHV1-2/J4 66bp (23253)

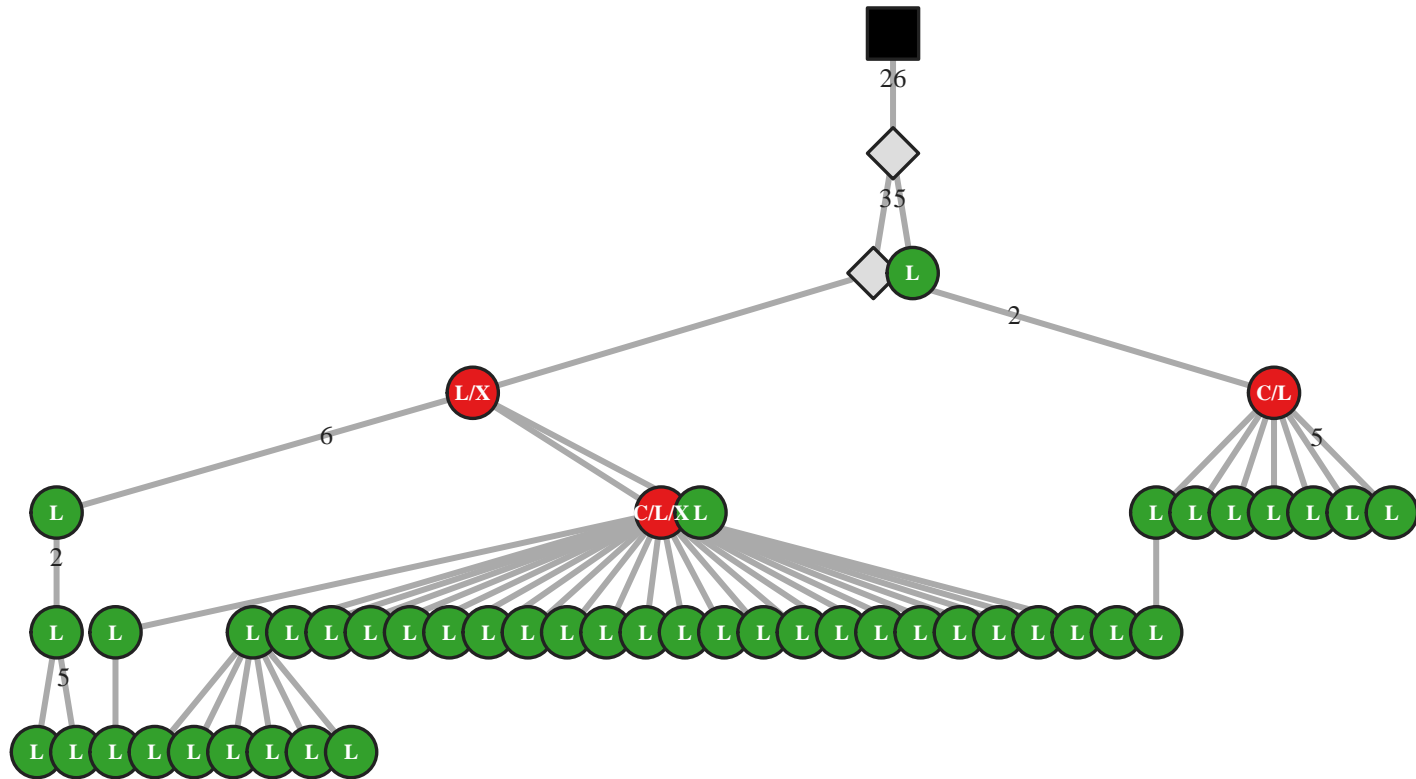

M5 IgG IGHV1-2/J4 66bp (23260)

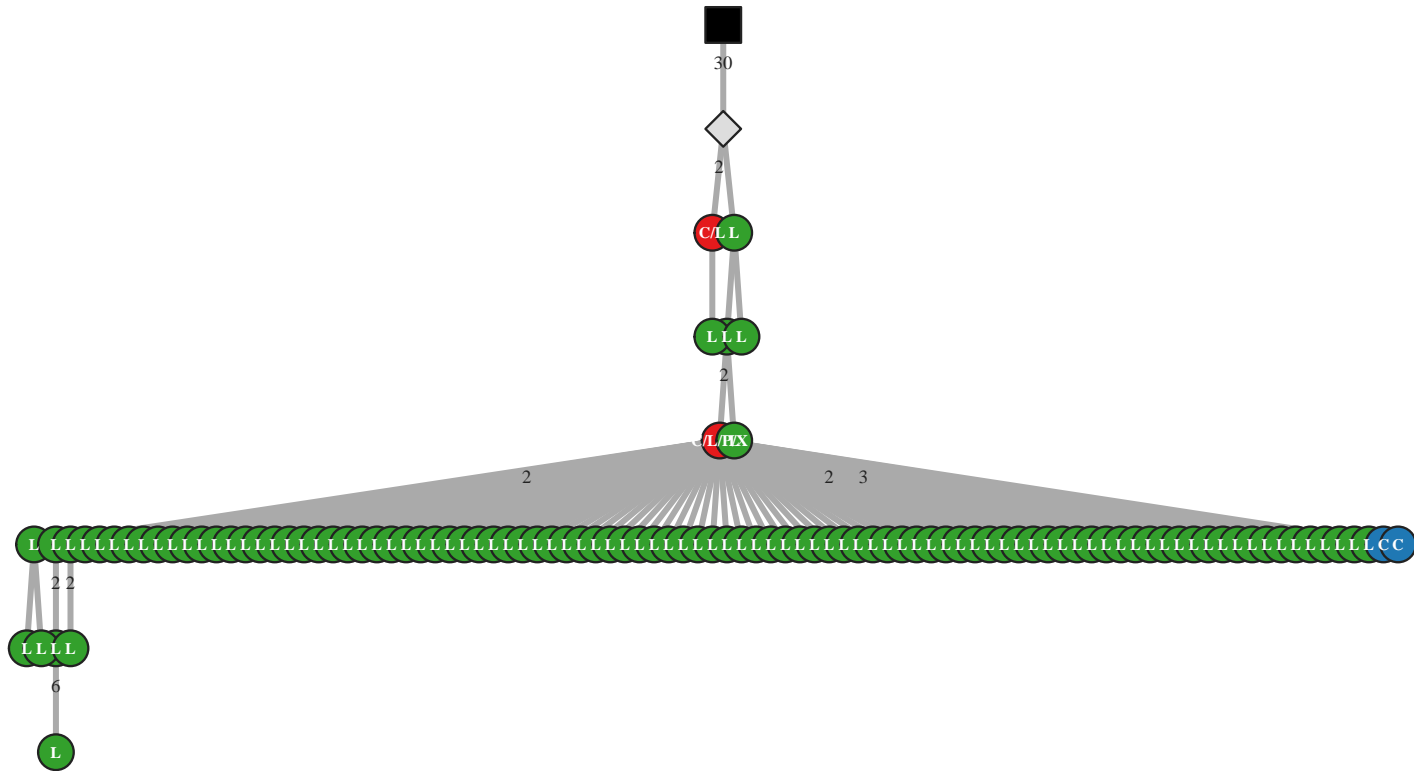

M5 IgG IGHV1-2/J5 33bp (31932)

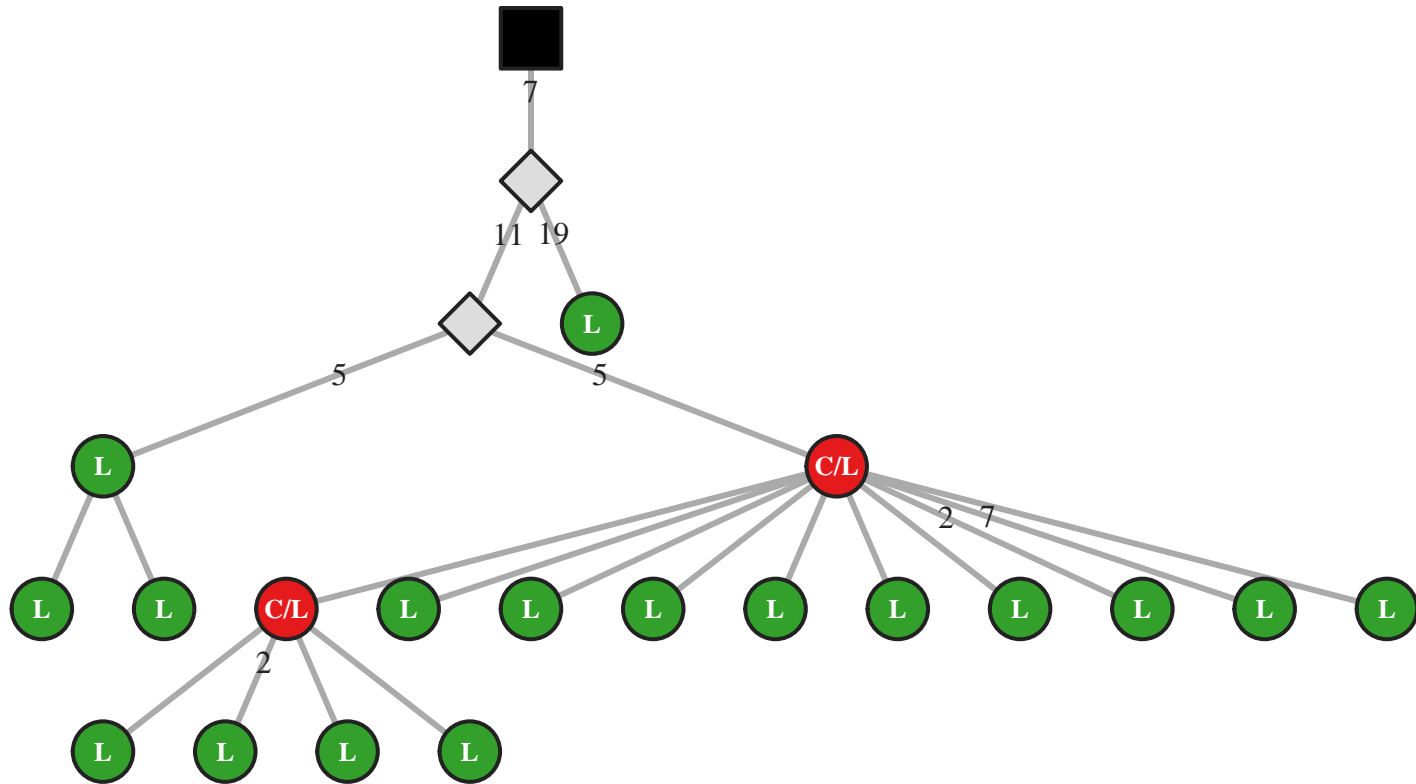

M5 IgG IGHV1-2/J5 39bp (40184)

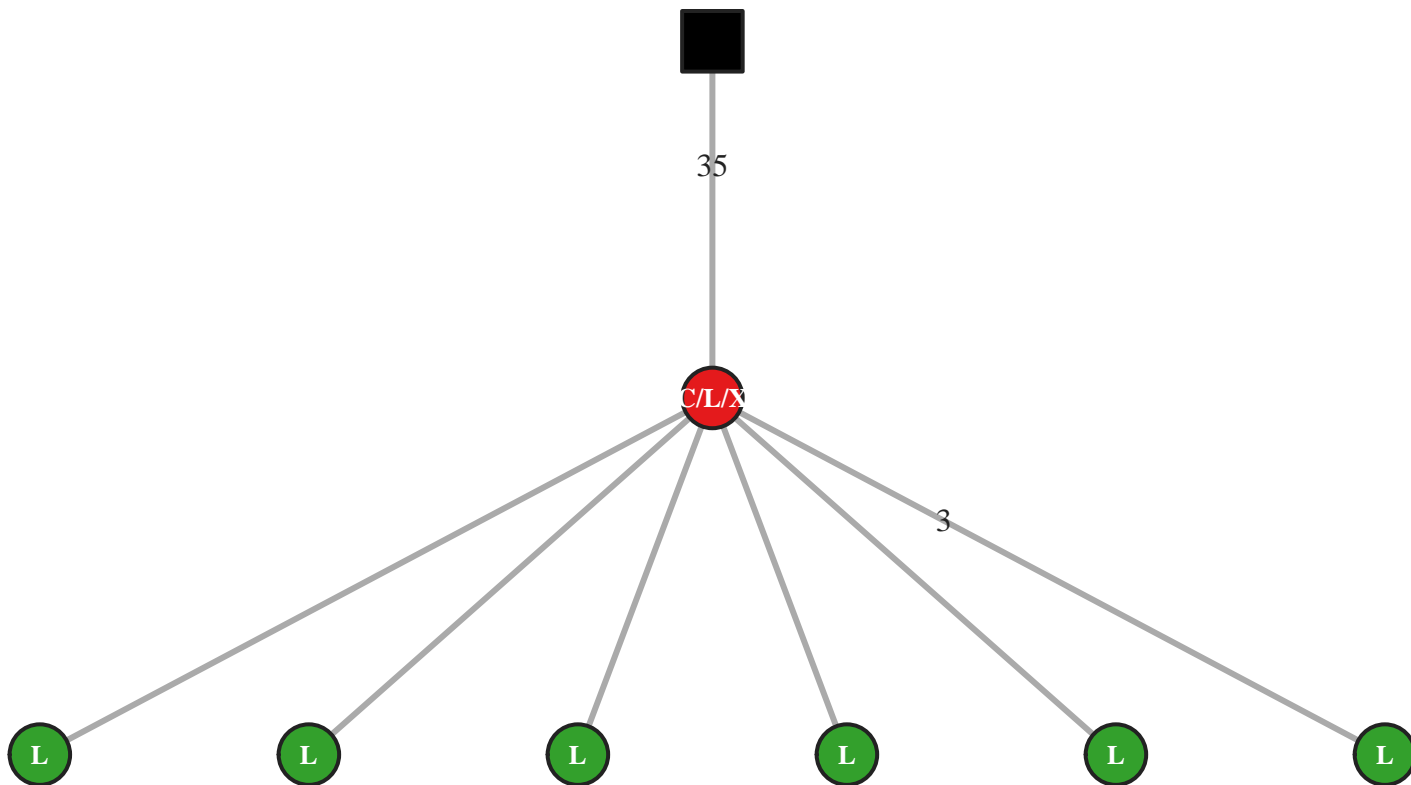

M5 IgG IGHV1-2/J5 39bp (40192)

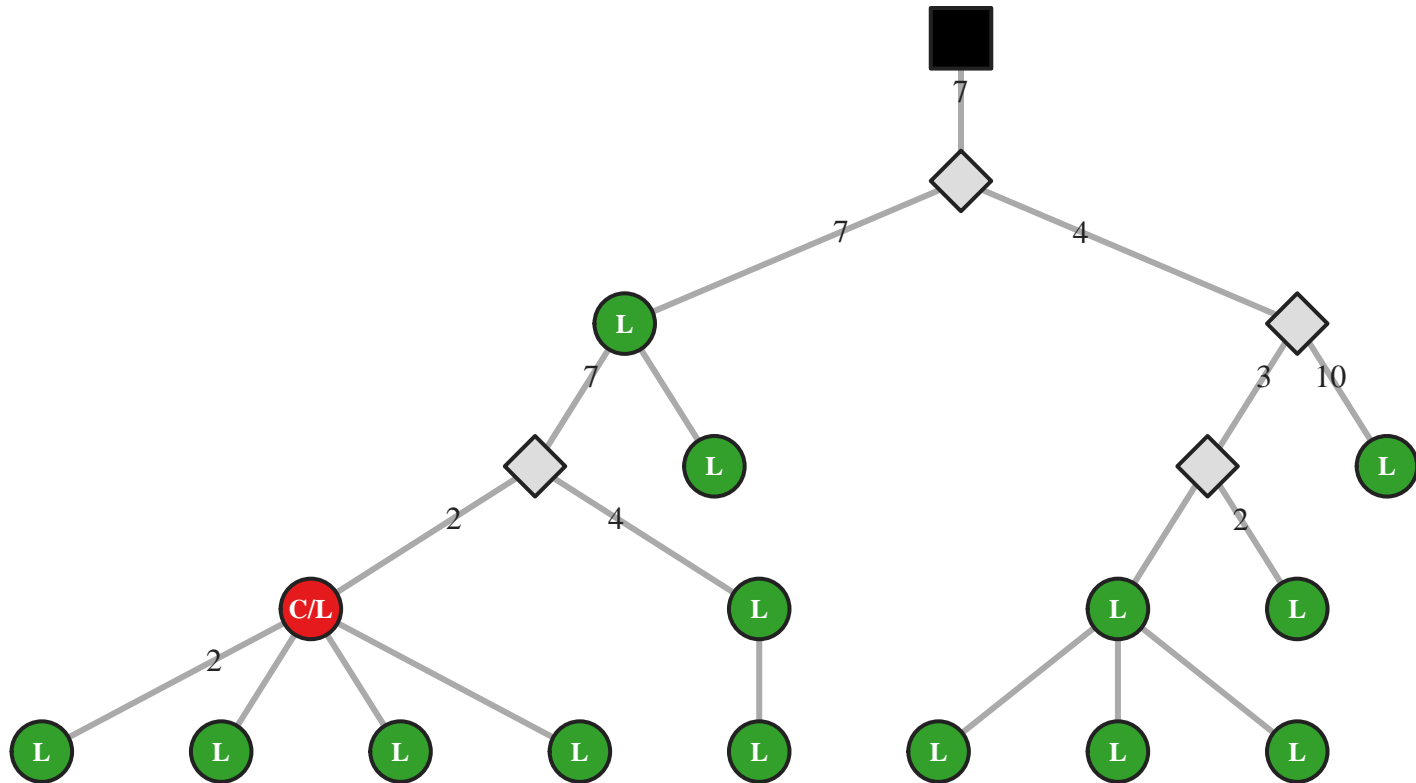

M5 IgG IGHV1-2/J5 42bp (14009)

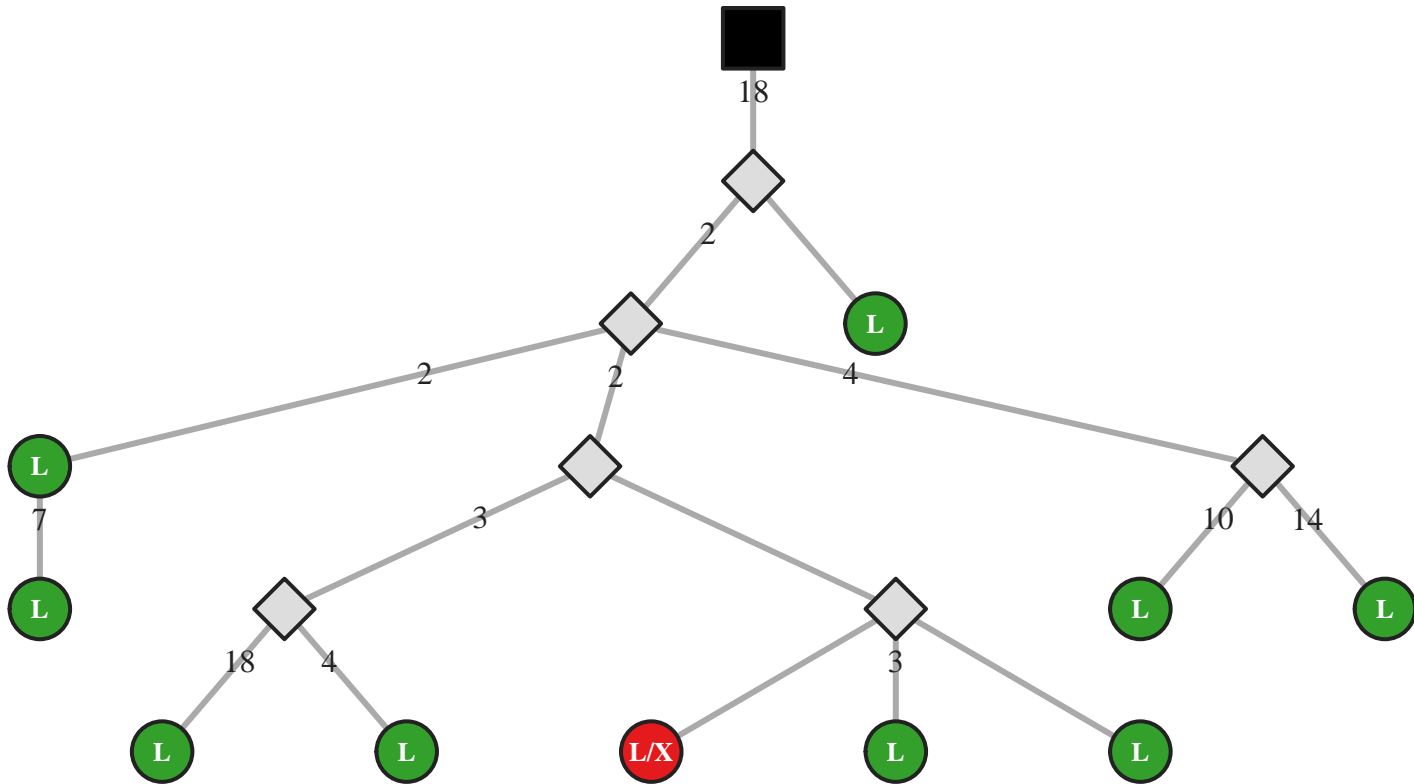

M5 IgA IGHV1-2/J5 48bp (2270)

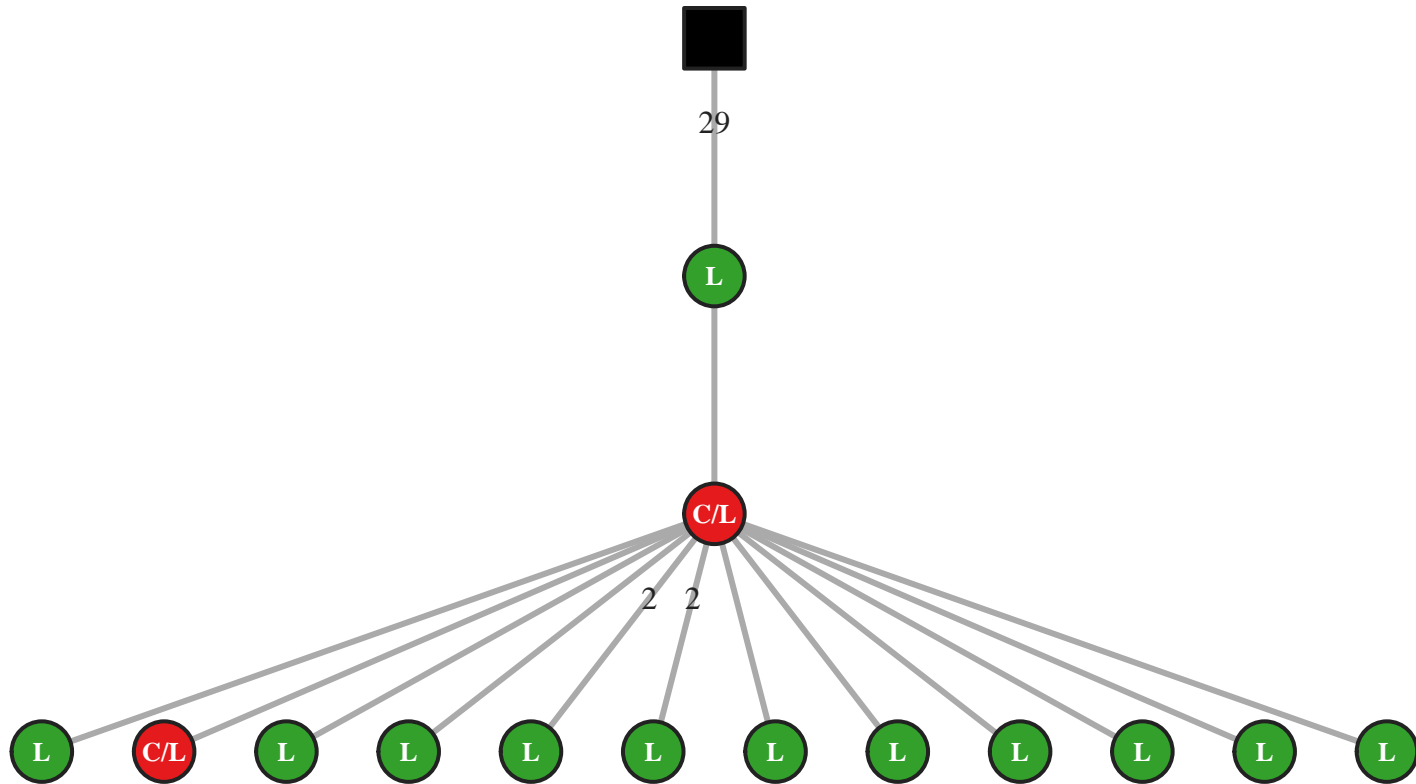

M5 IgG IGHV1-2/J5 48bp (23281)

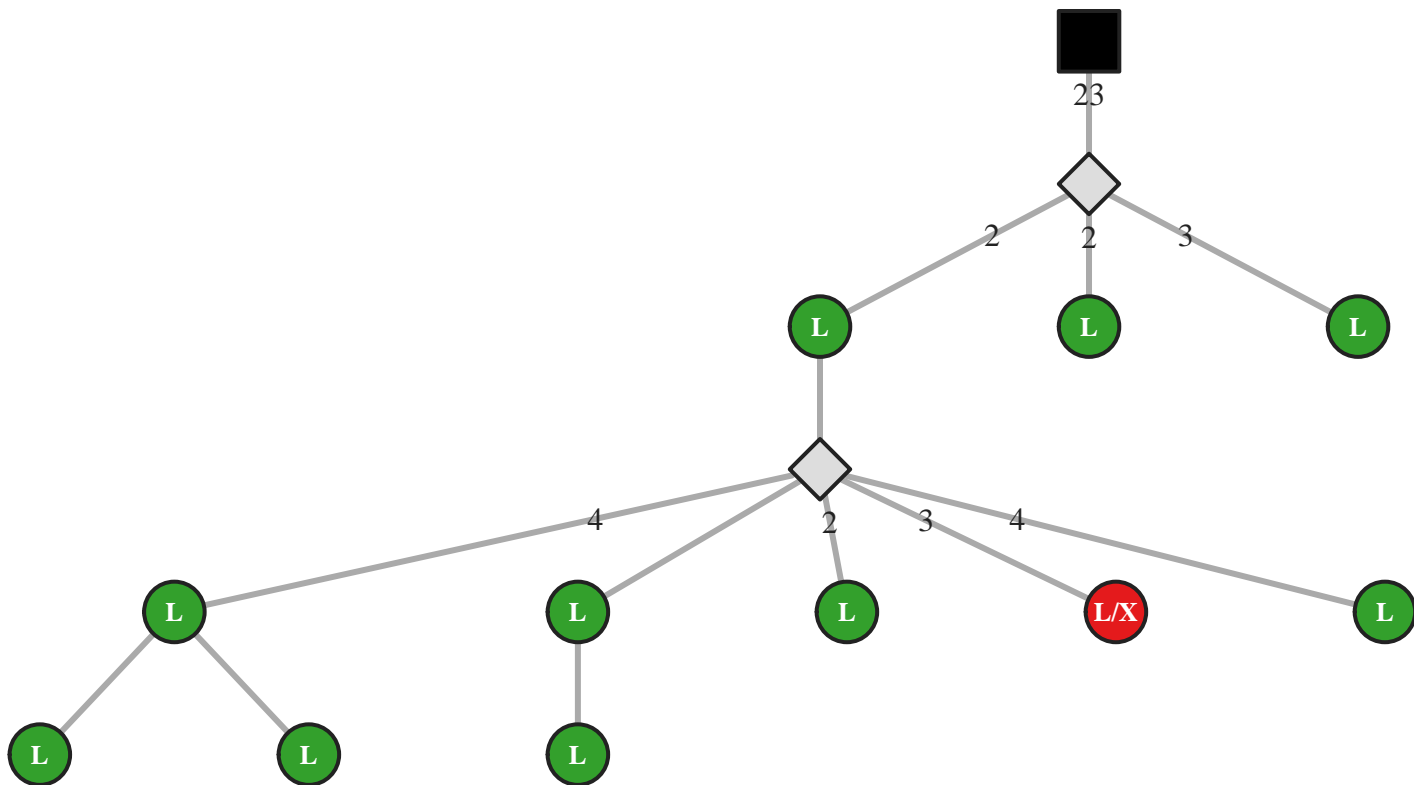

M5 IgG IGHV1-2/J5 48bp (23298)

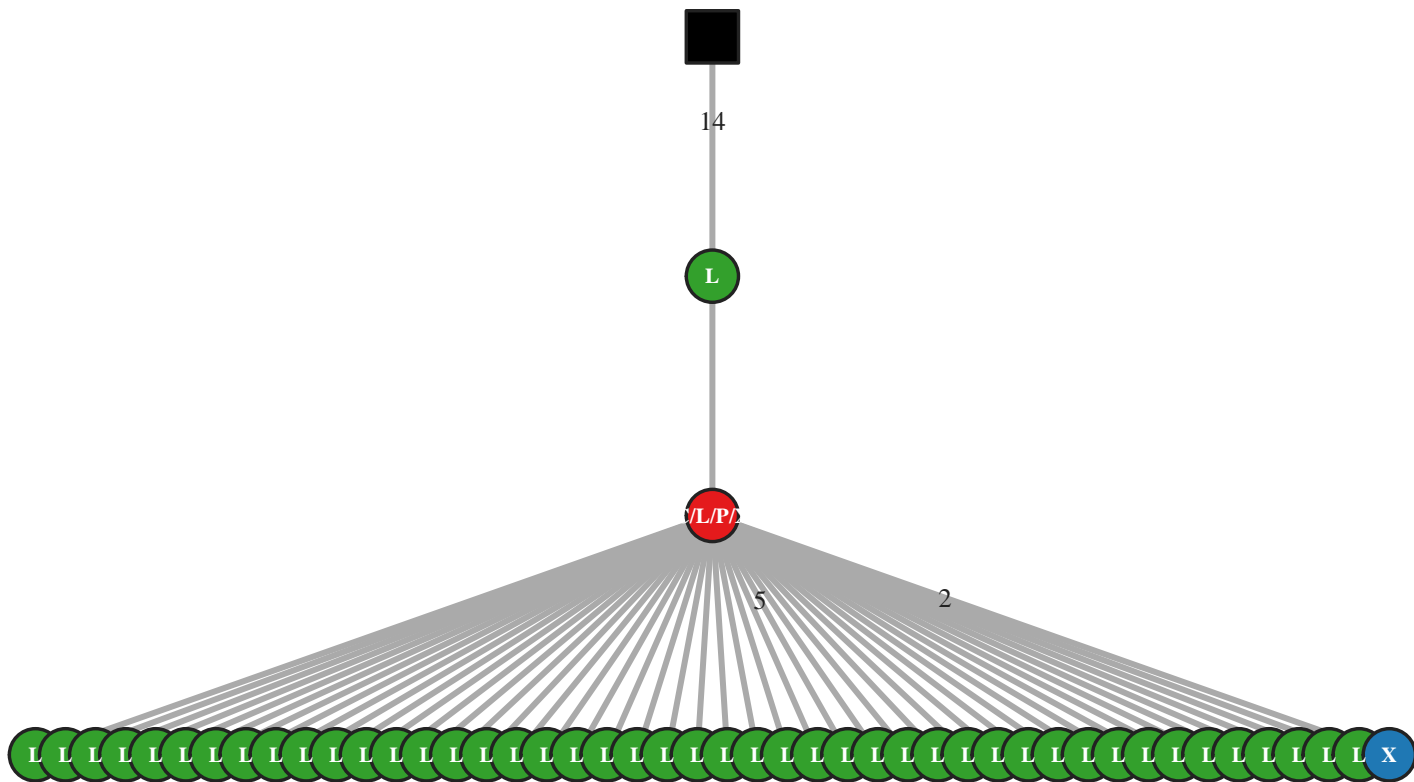

M5 IgG IGHV1-2/J5 54bp (40249)

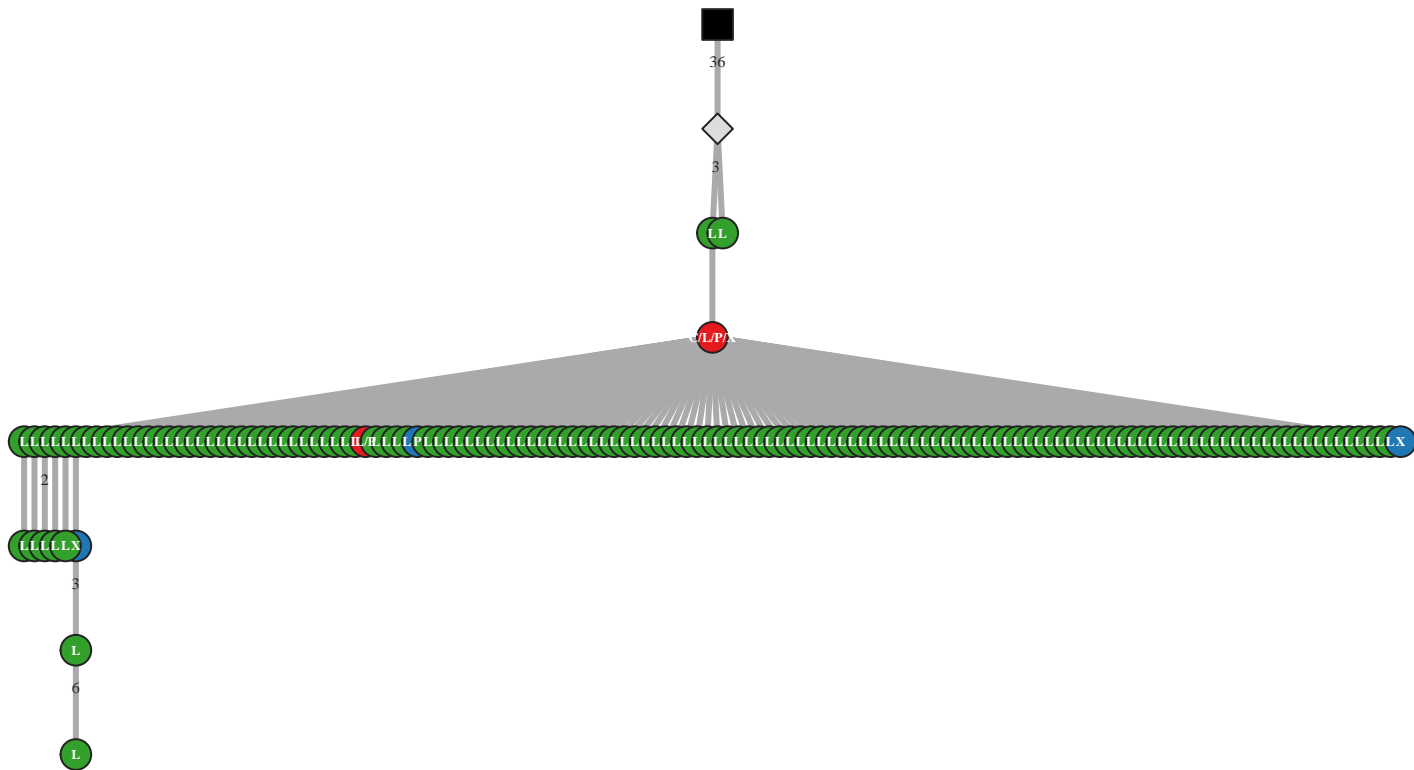

M5 IgG IGHV1-2/J5 57bp (31948)

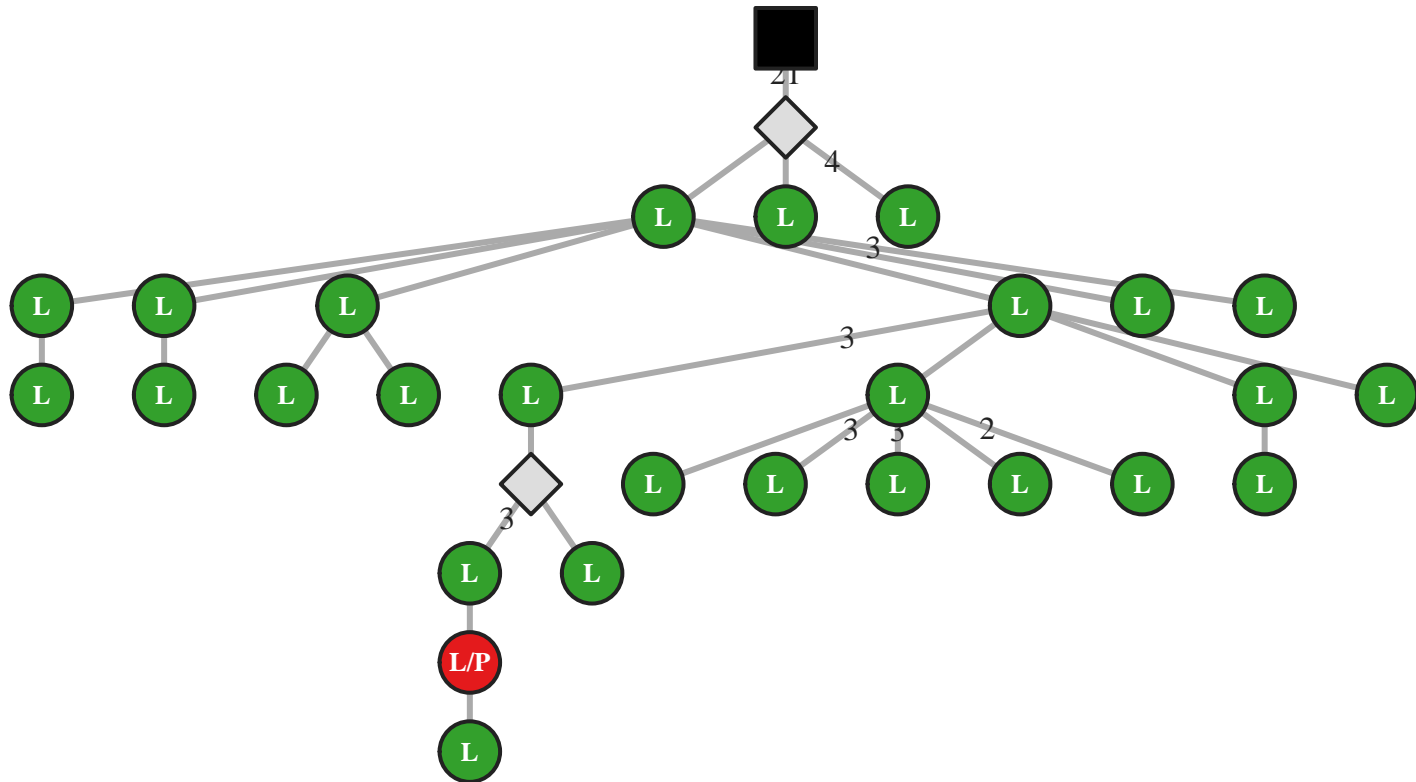

M5 IgA IGHV1-2/J5 60bp (2297)

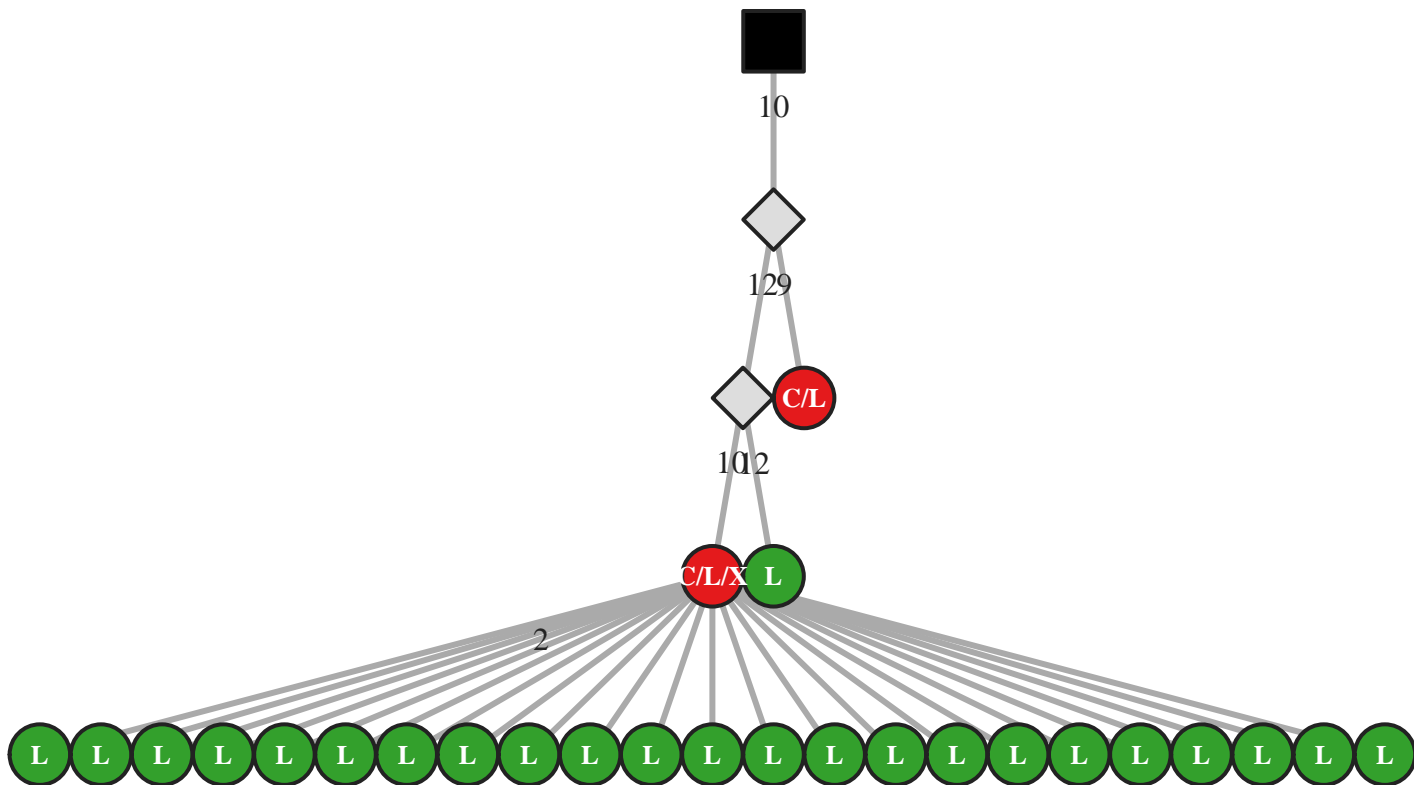

M5 IgG IGHV1-2/J5 63bp (14023)

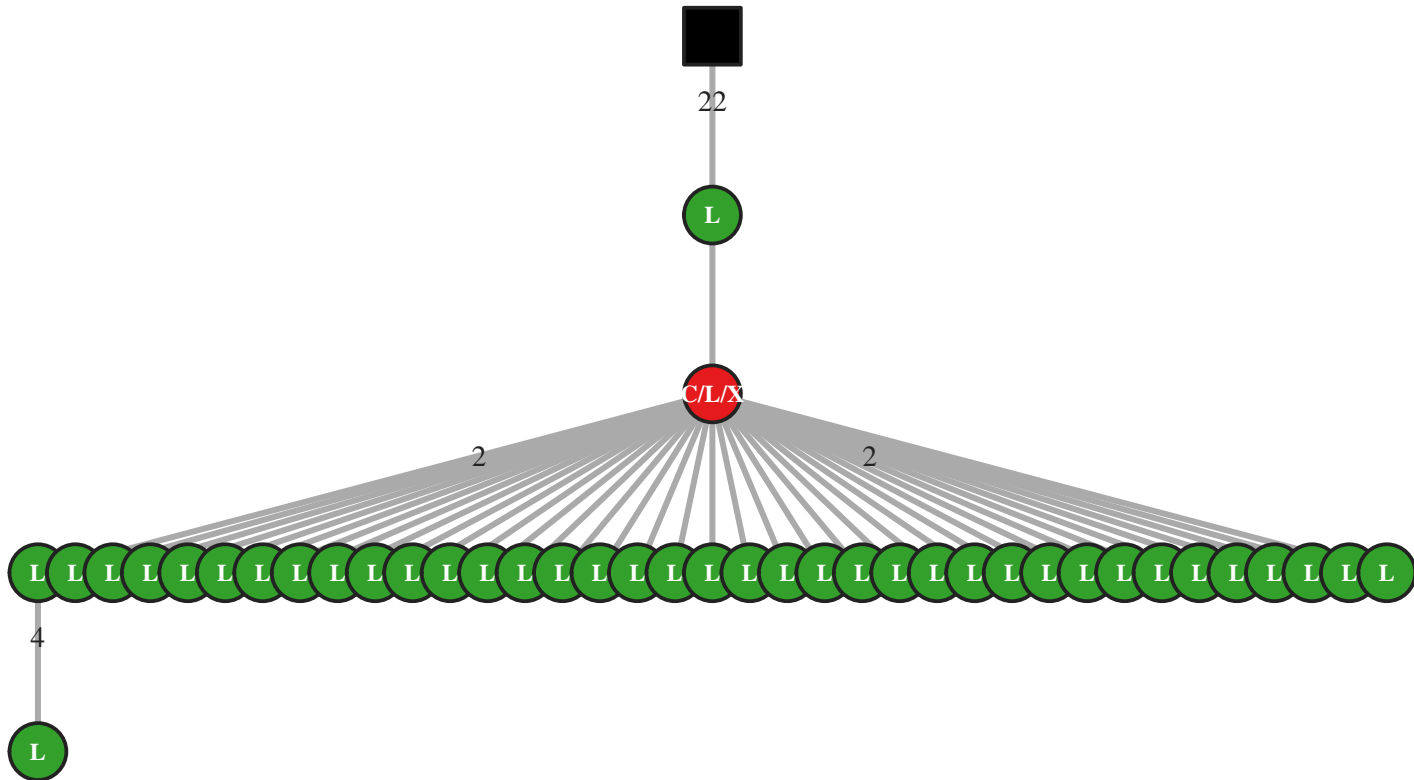

M5 IgA IGHV1-2/J6 33bp (38256)

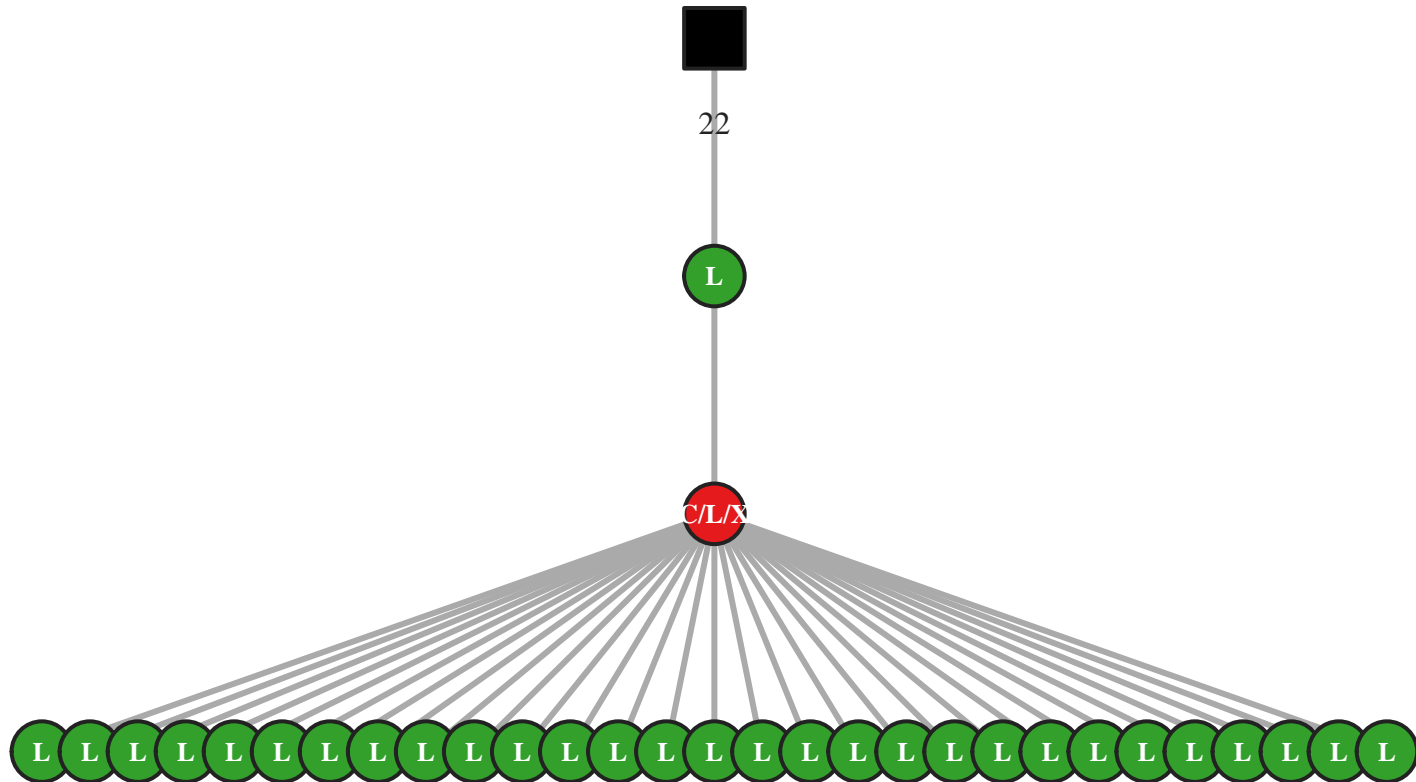

M5 IgG IGHV1-2/J6 42bp (23340)

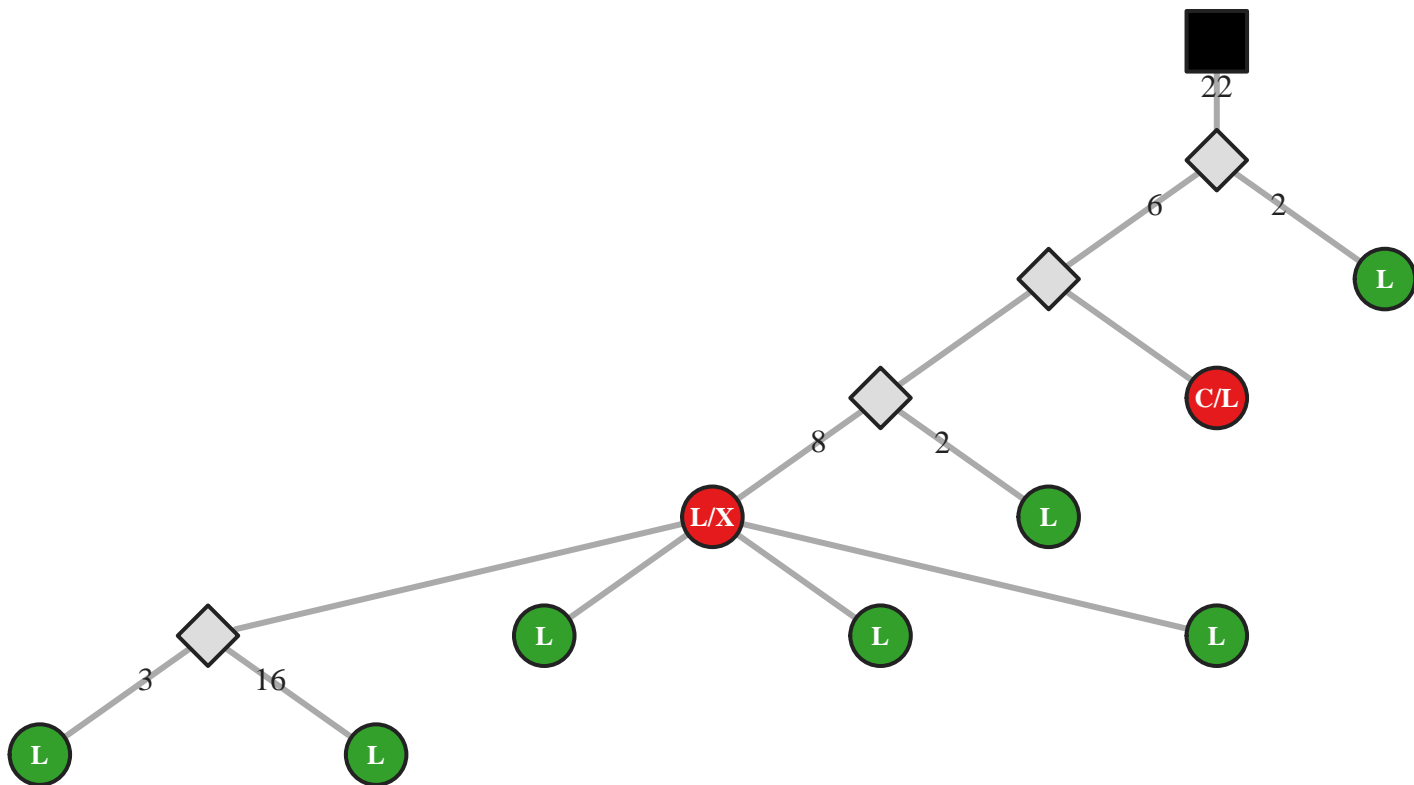

M5 IgG IGHV1-2/J6 45bp (4503)

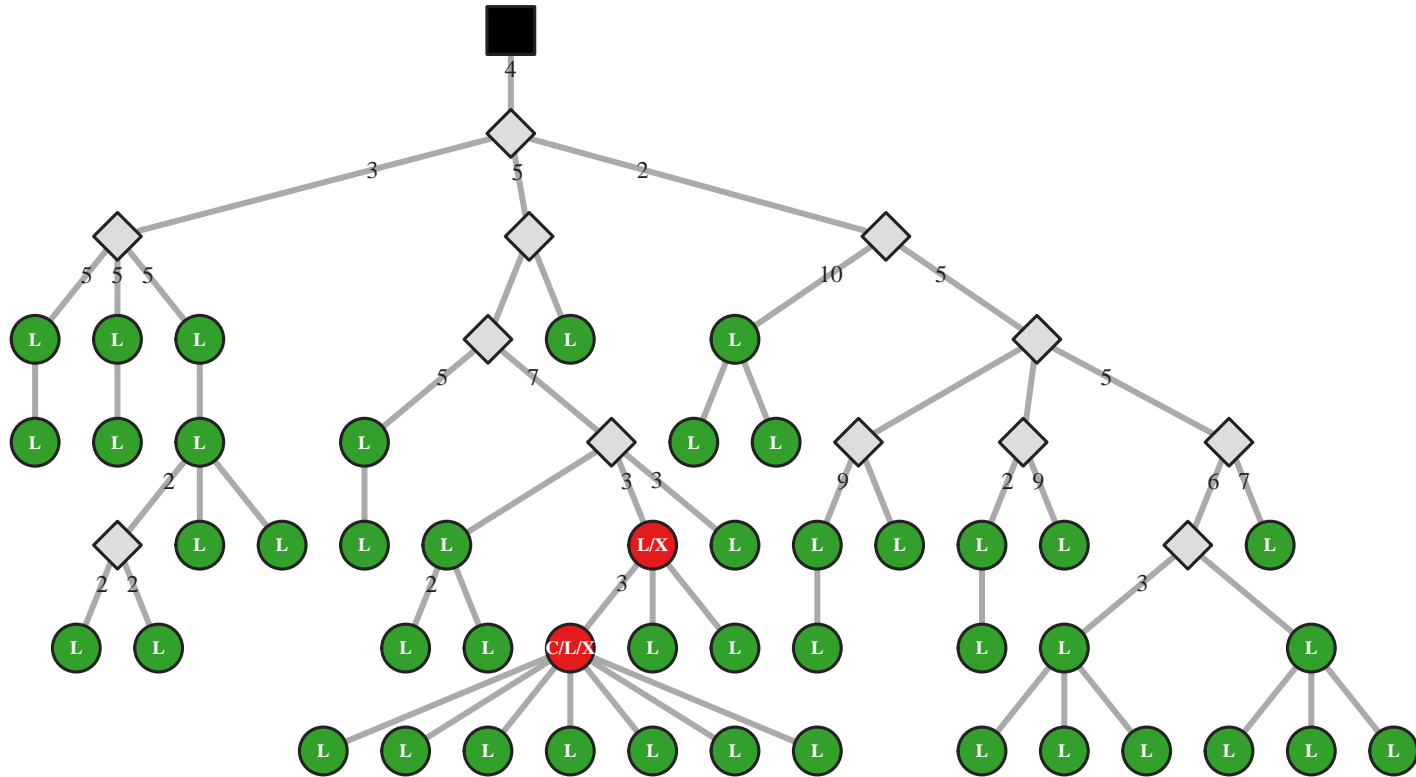

M5 IgA IGHV1-2/J6 48bp (38262)

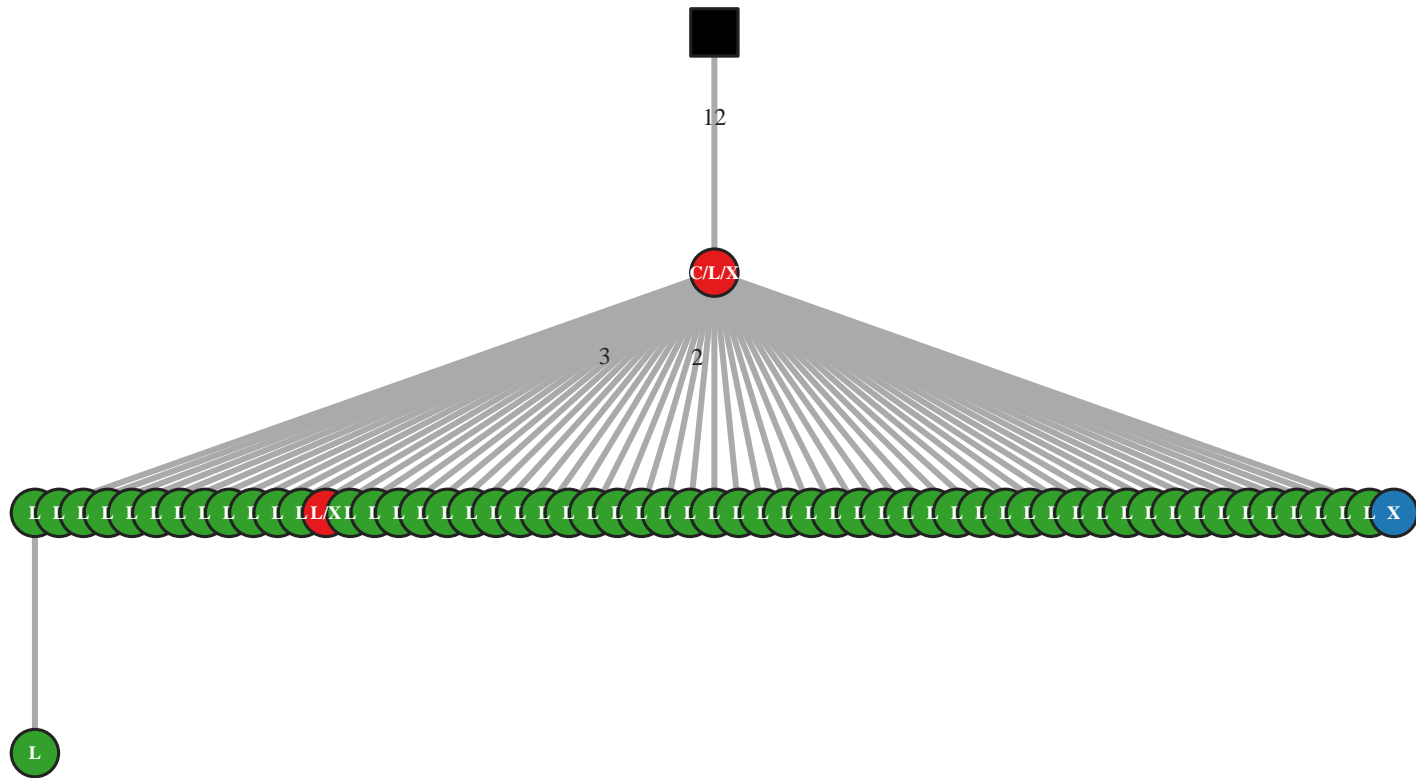

M5 IgG IGHV1-2/J6 51bp (32009)

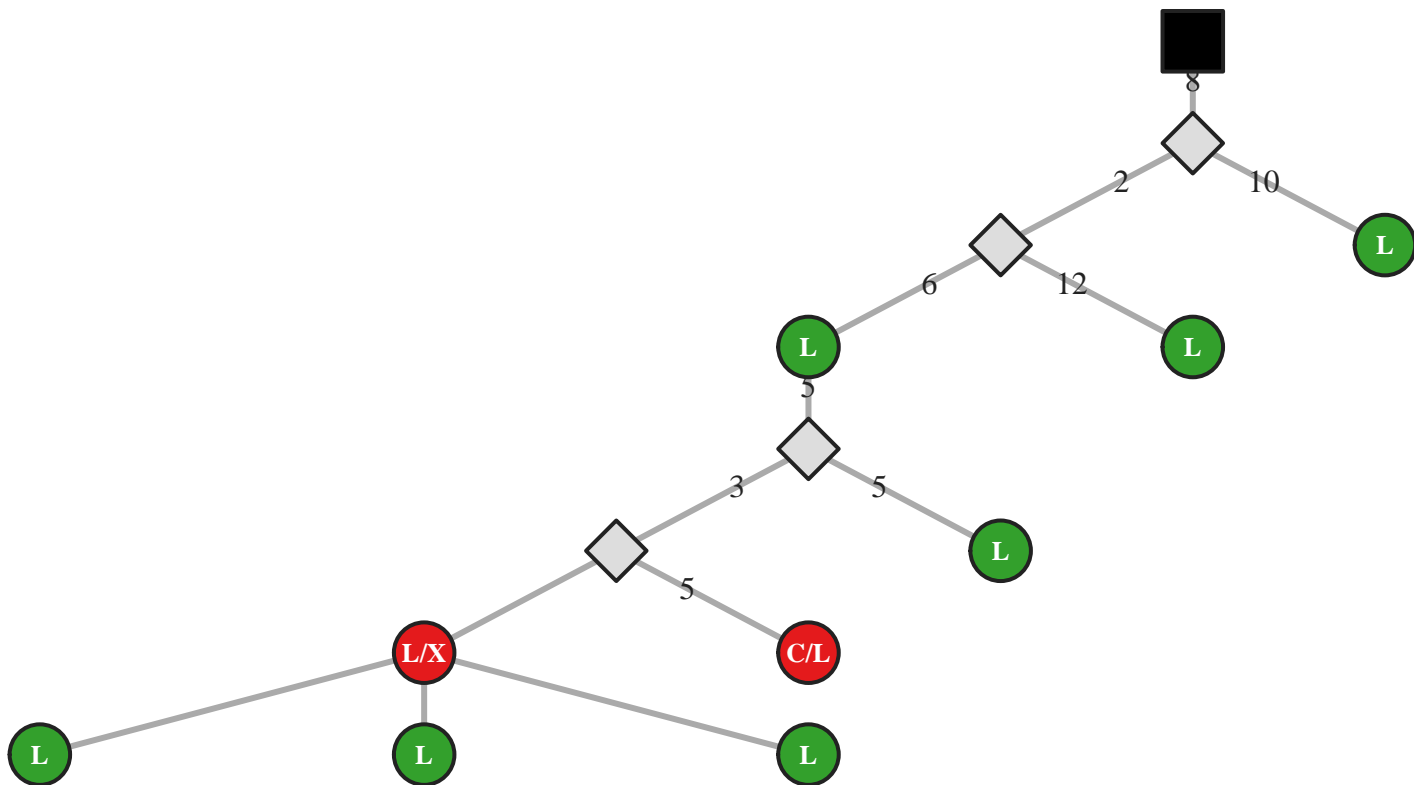

M5 IgA IGHV1-2/J6 54bp (21187)

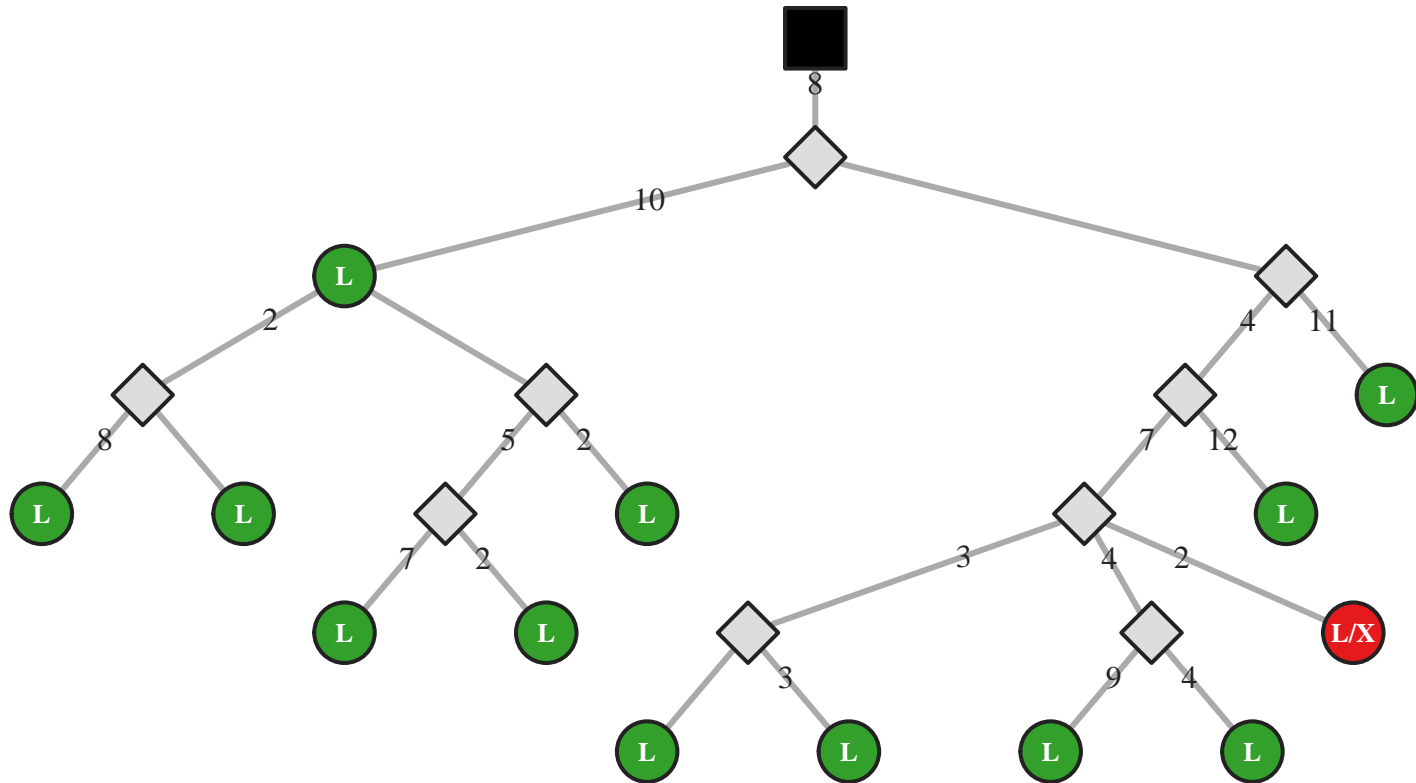

M5 IgM IGHV1-2/J6 54bp (47604)

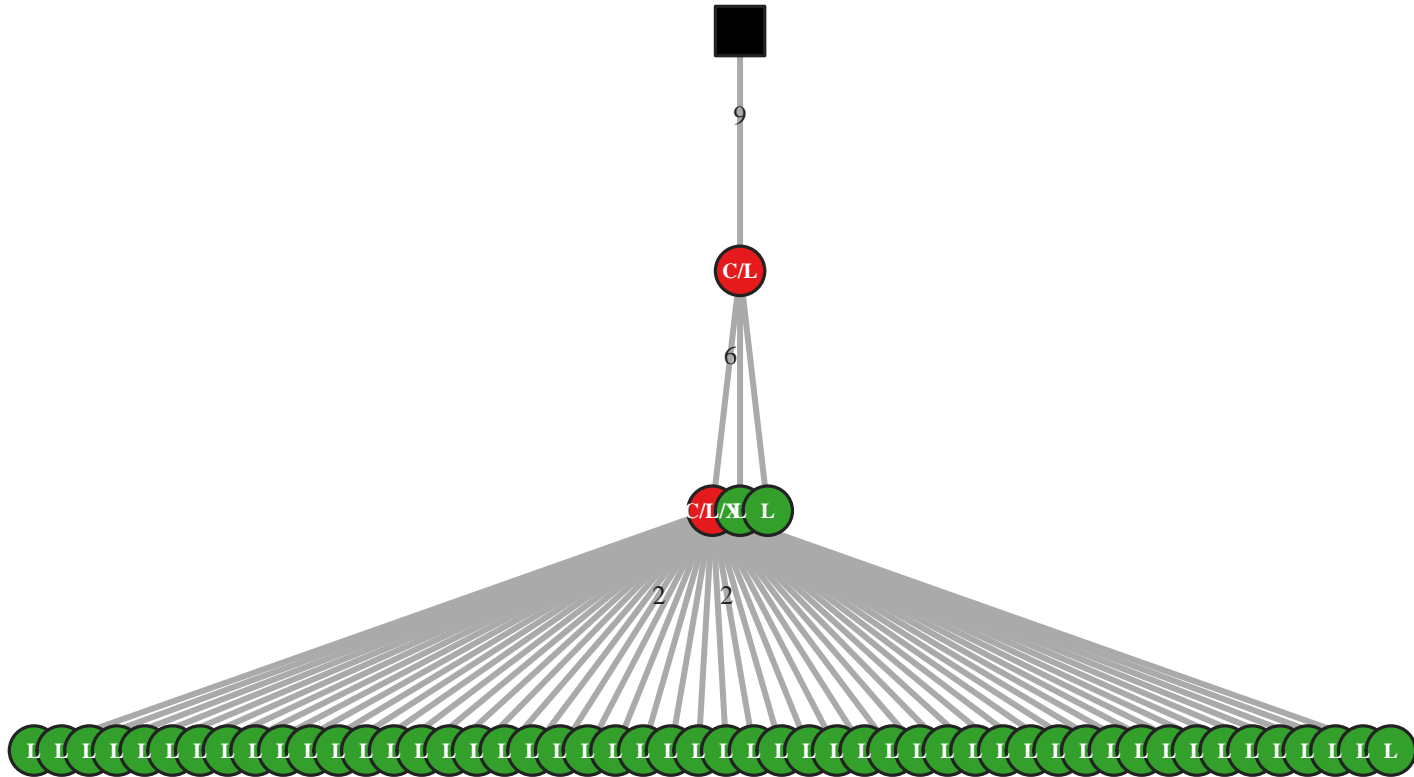

M5 IgA IGHV1-2/J6 57bp (2319)

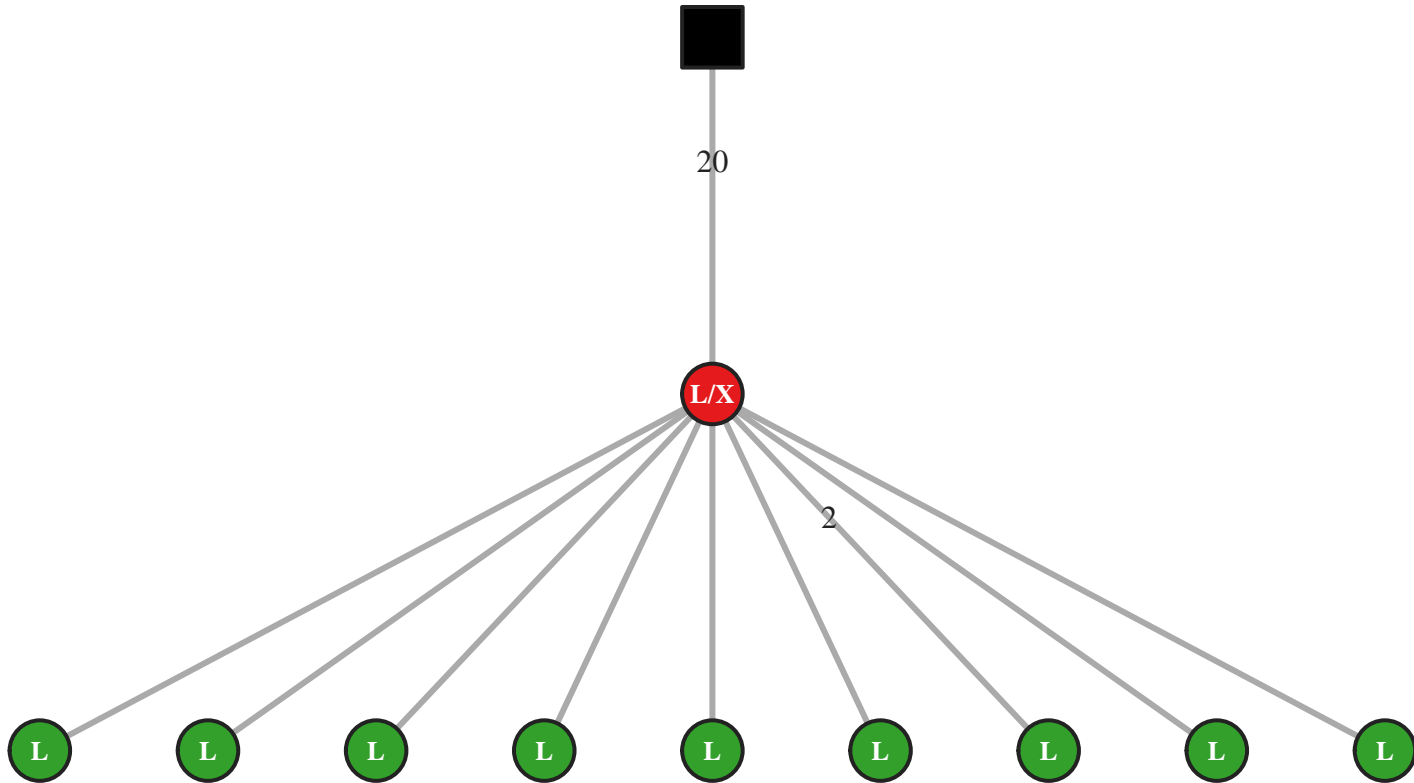

M5 IgG IGHV1-2/J6 63bp (23387)

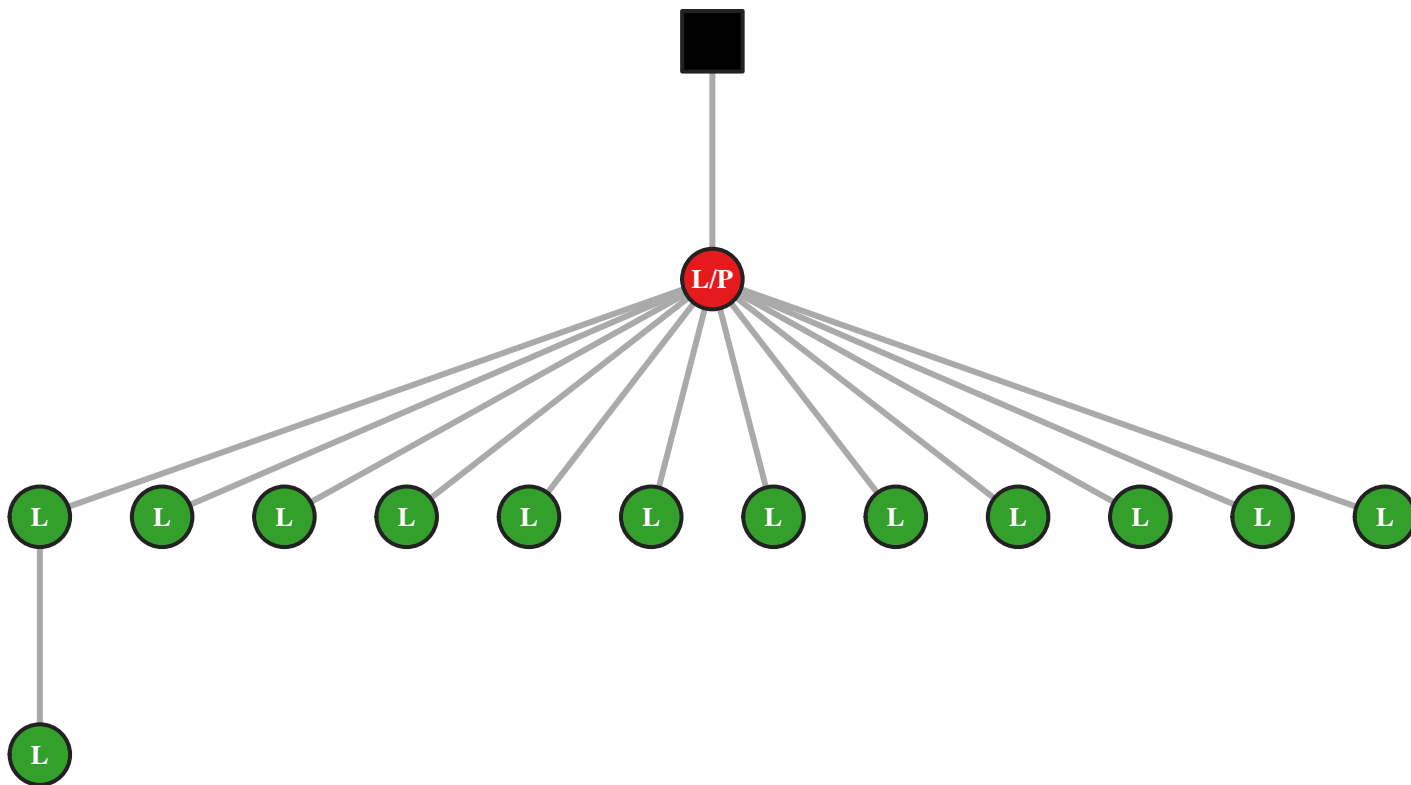

M5 IgG IGHV1-2/J6 72bp (32040)

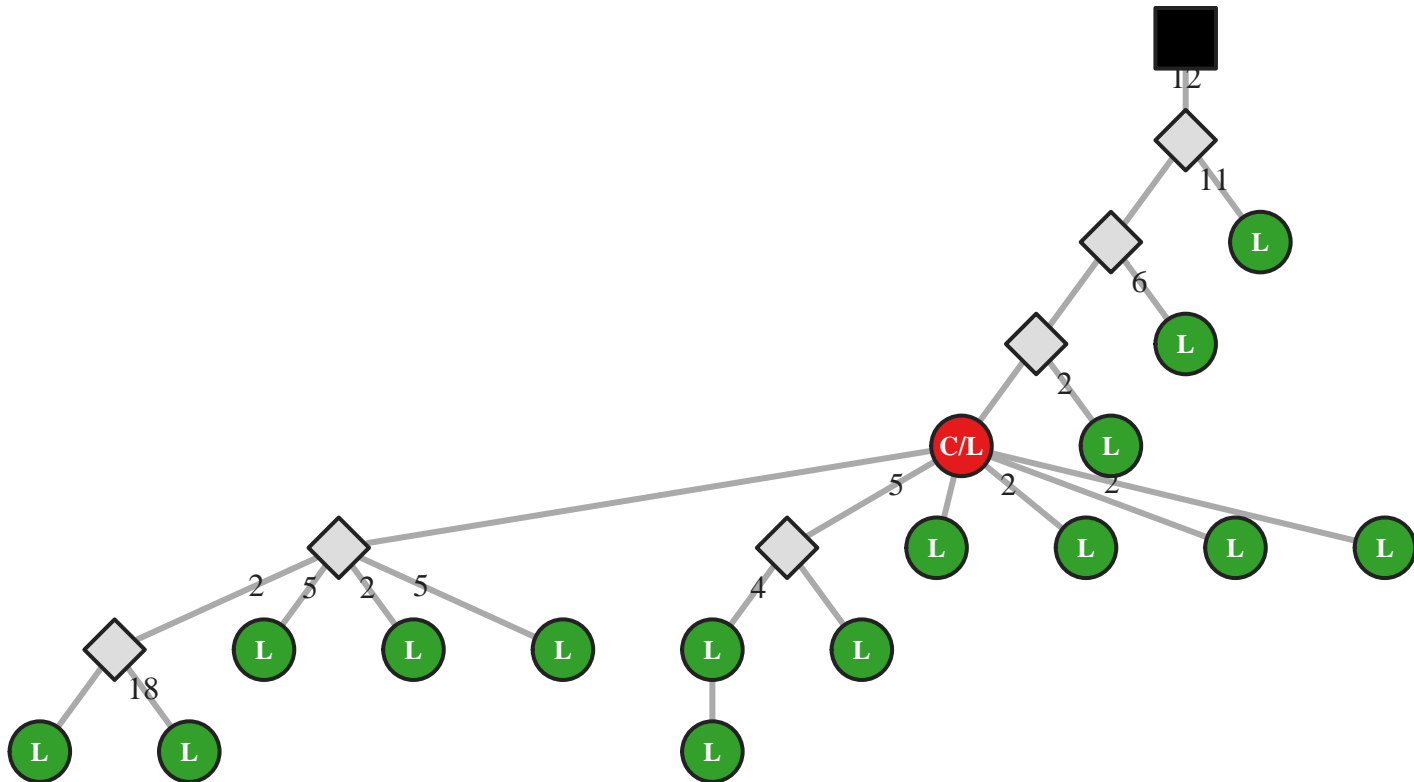

M5 IgG IGHV1-2/J6 72bp (32042)

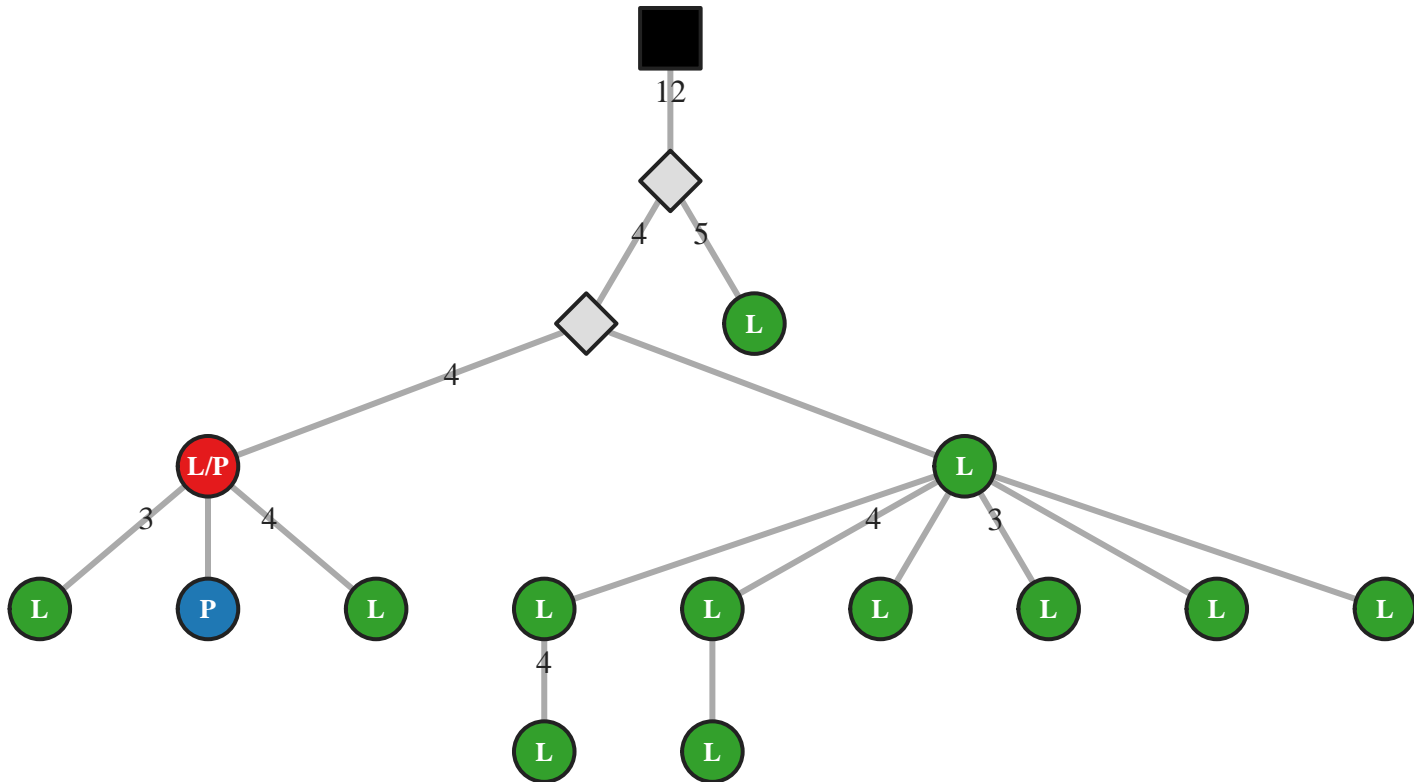

M5 IgG IGHV1-2/J6 75bp (23399)

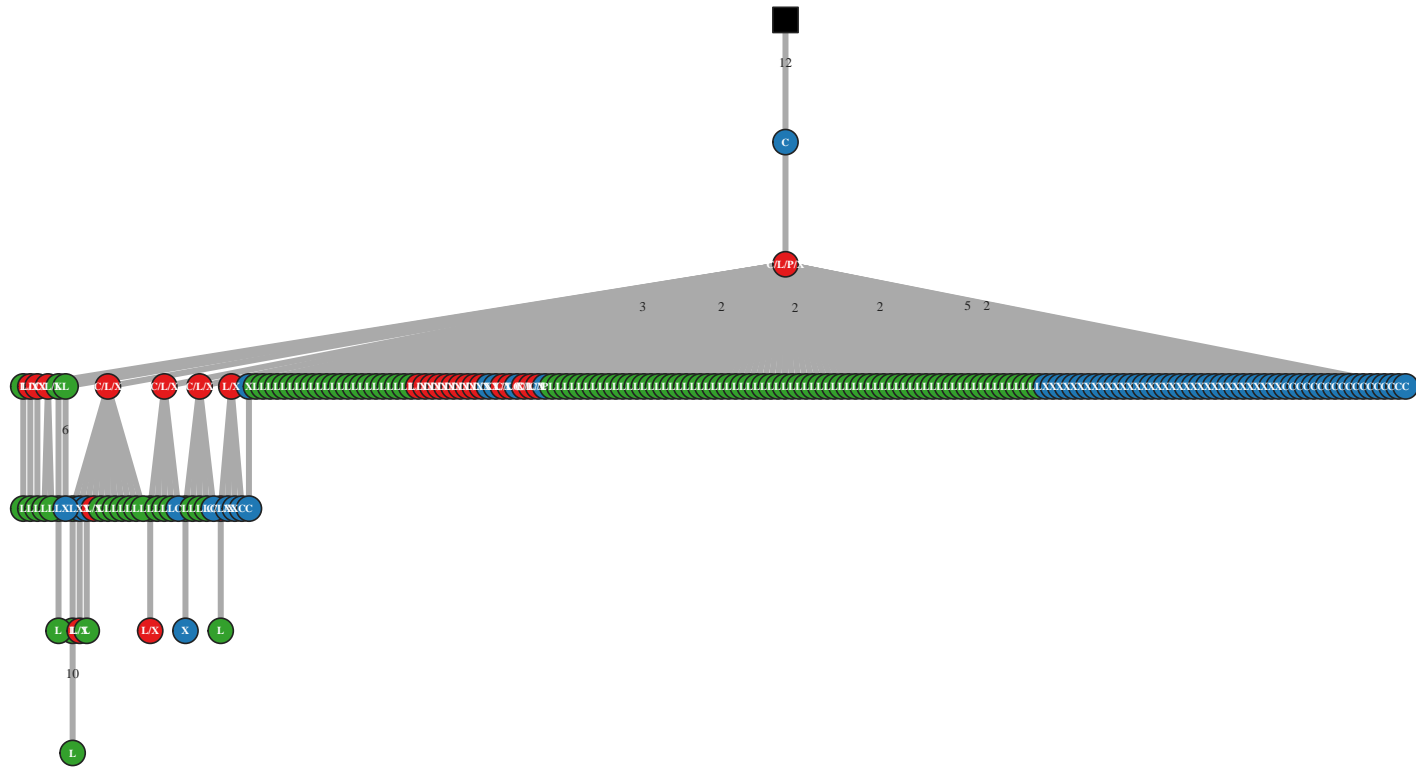

M5 IgG IGHV1-24/J2 42bp (13635)

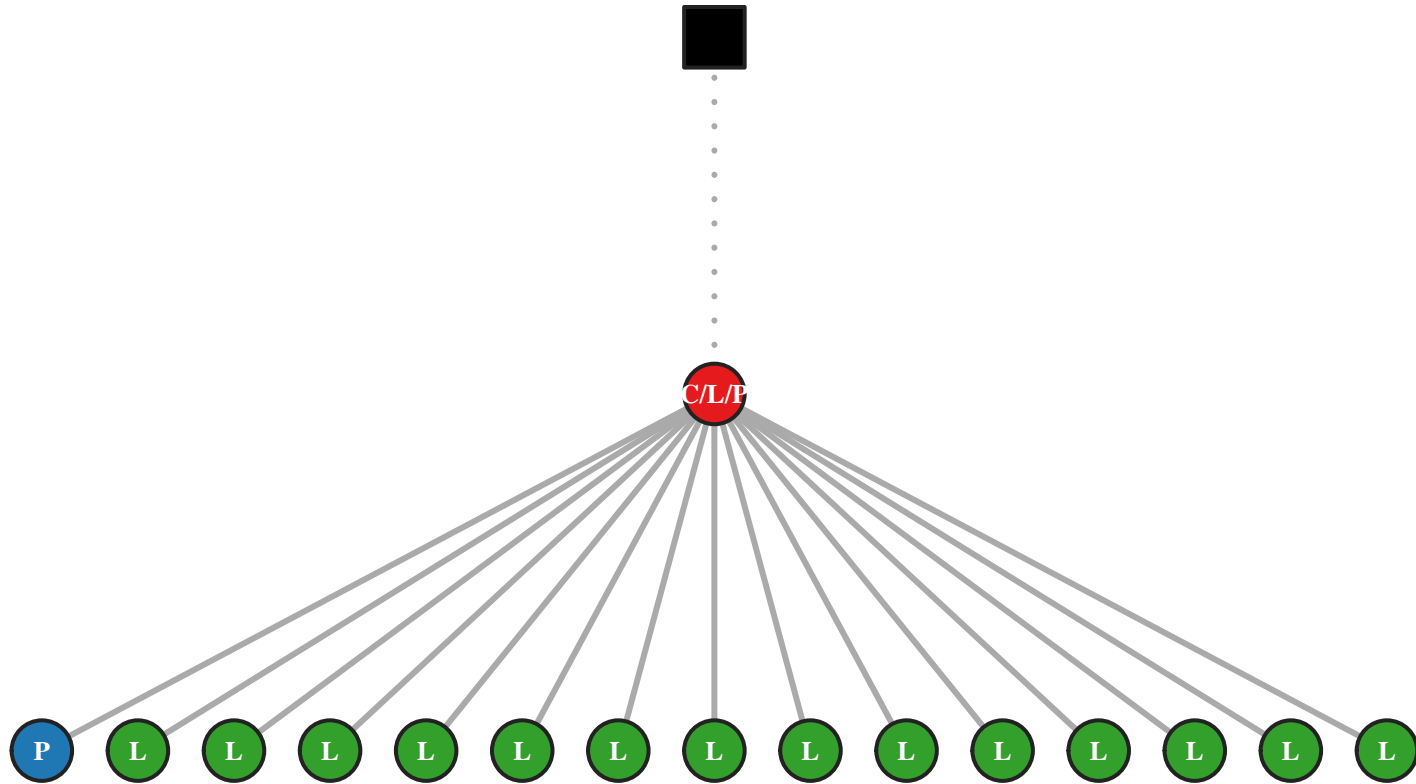

M5 IgG IGHV1-24/J3 33bp (39808)

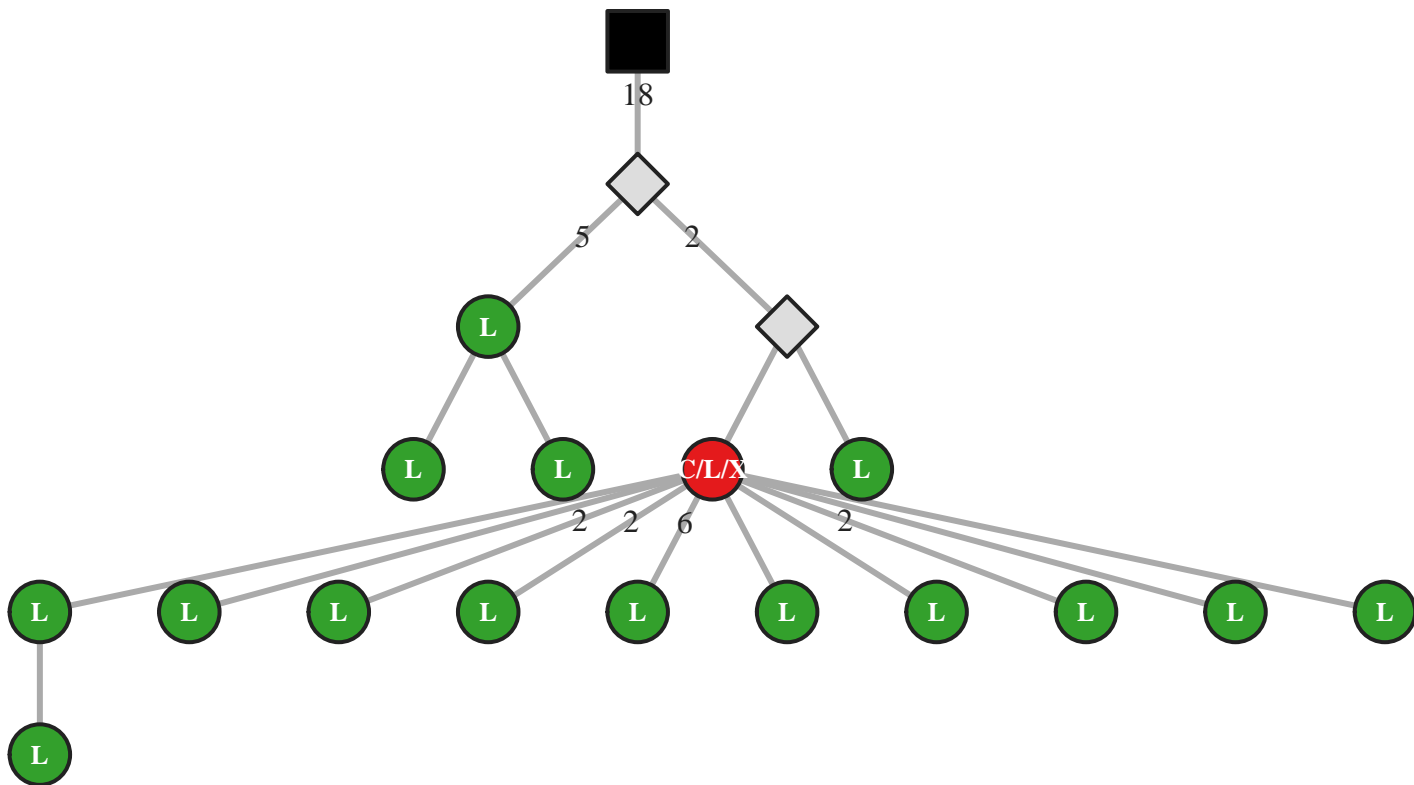

M5 IgG IGHV1-24/J3 42bp (23044)

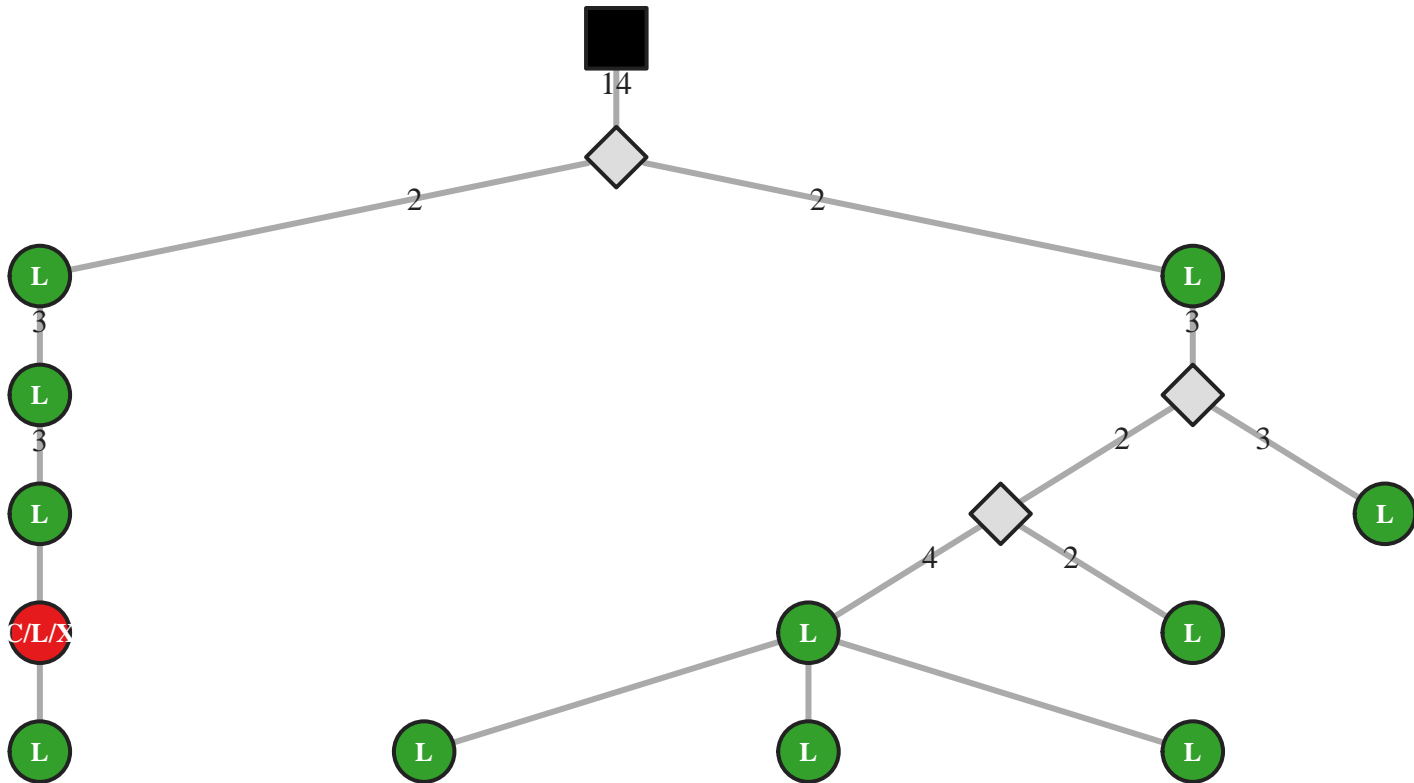

M5 IgG IGHV1-24/J4 24bp (13644)

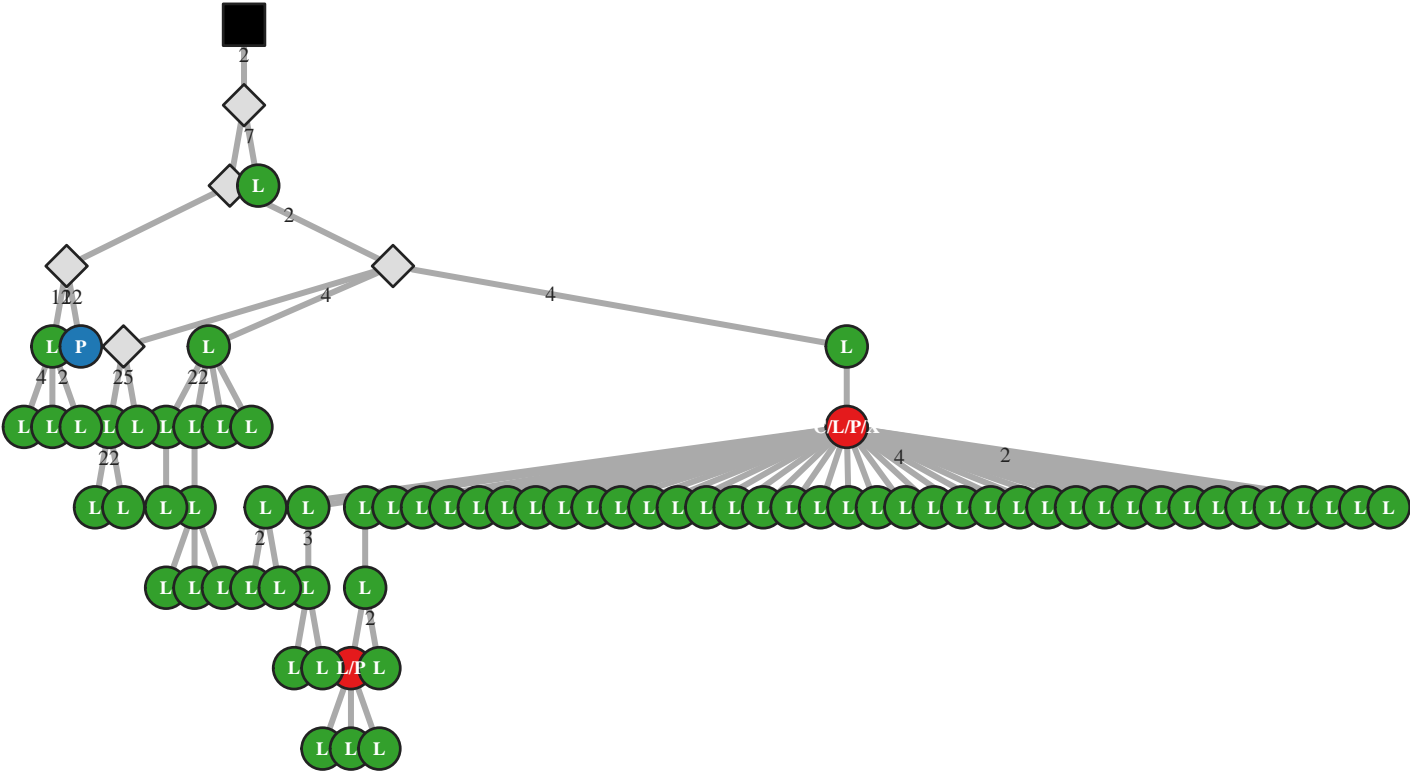

M5 IgG IGHV1-24/J4 39bp (49578)

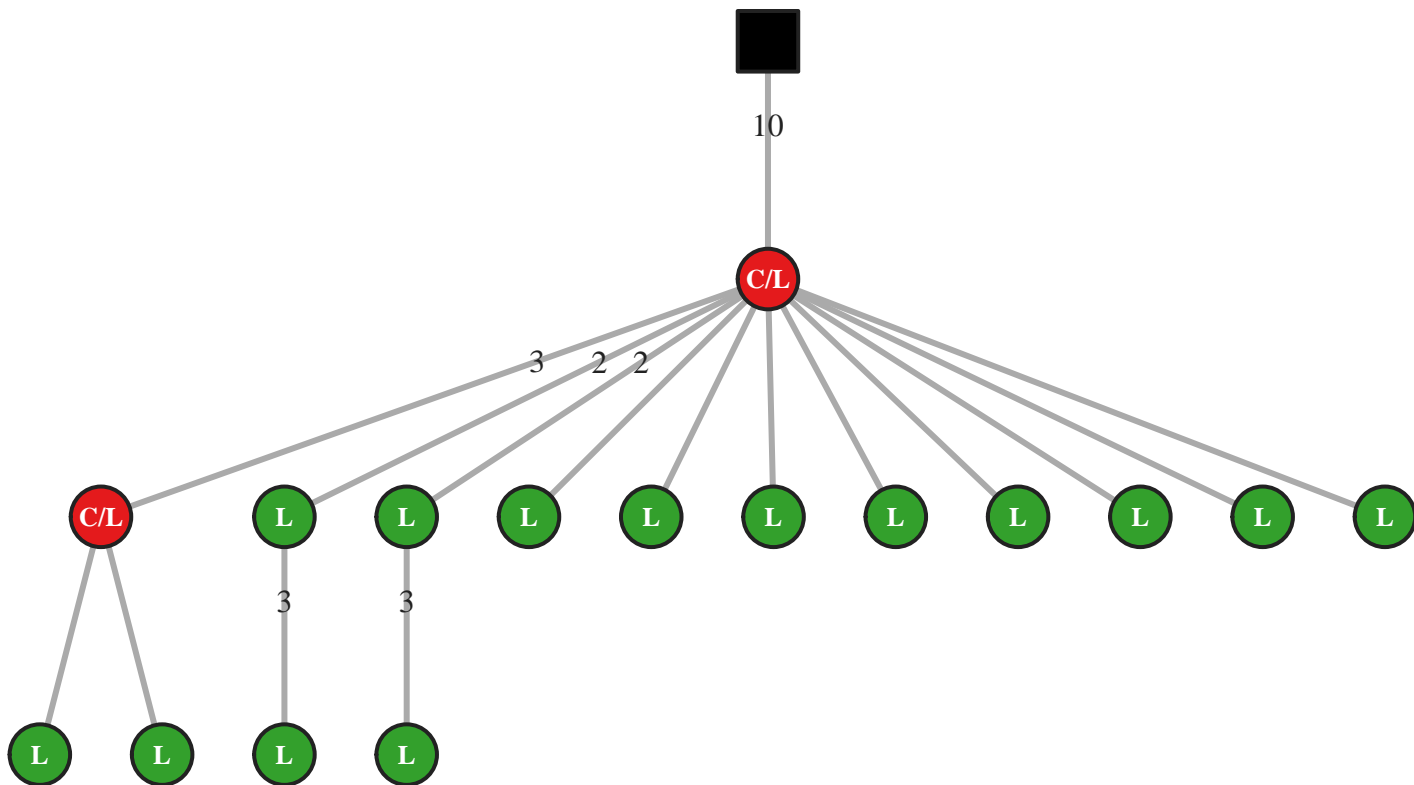

M5 IgG IGHV1-24/J4 39bp (49589)

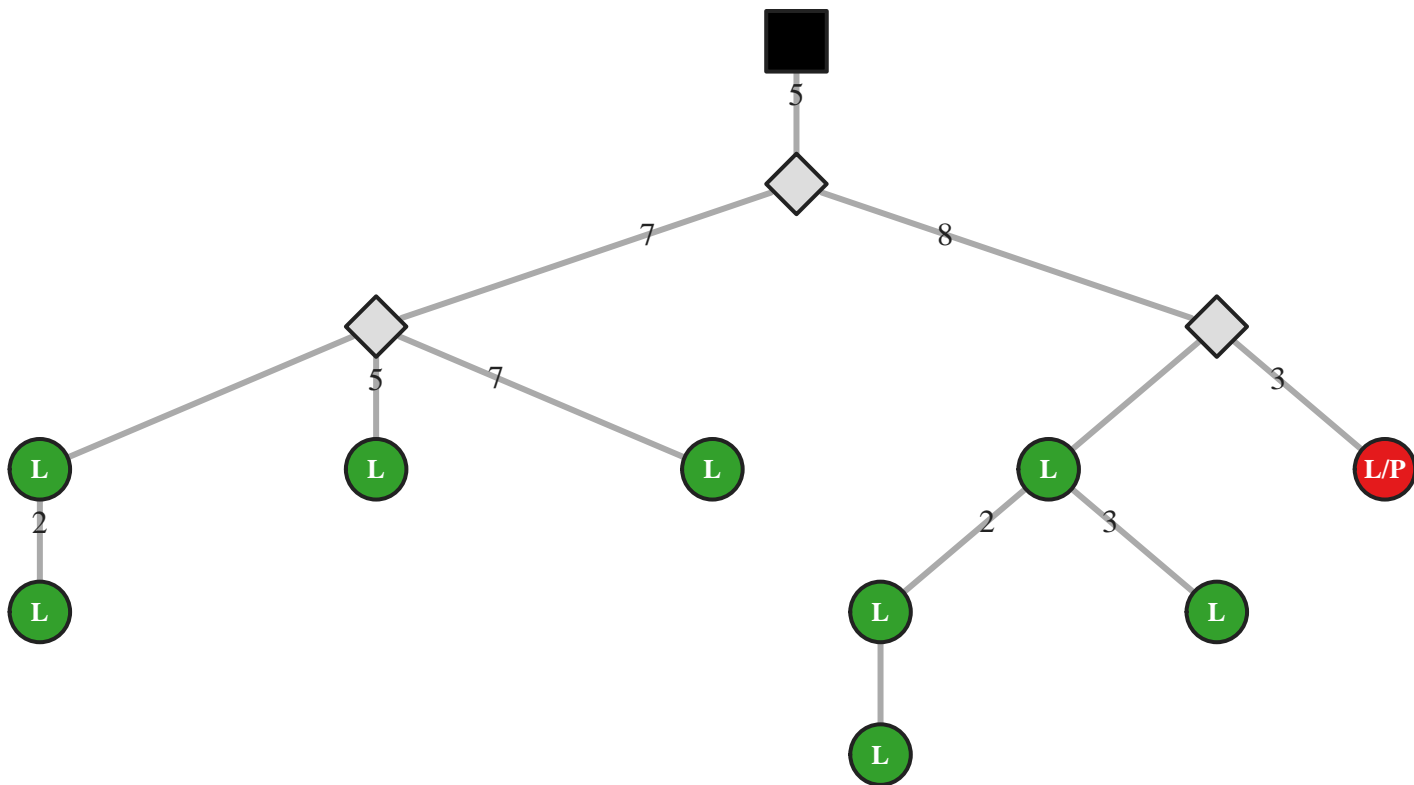

M5 IgG IGHV1-24/J4 45bp (4144)

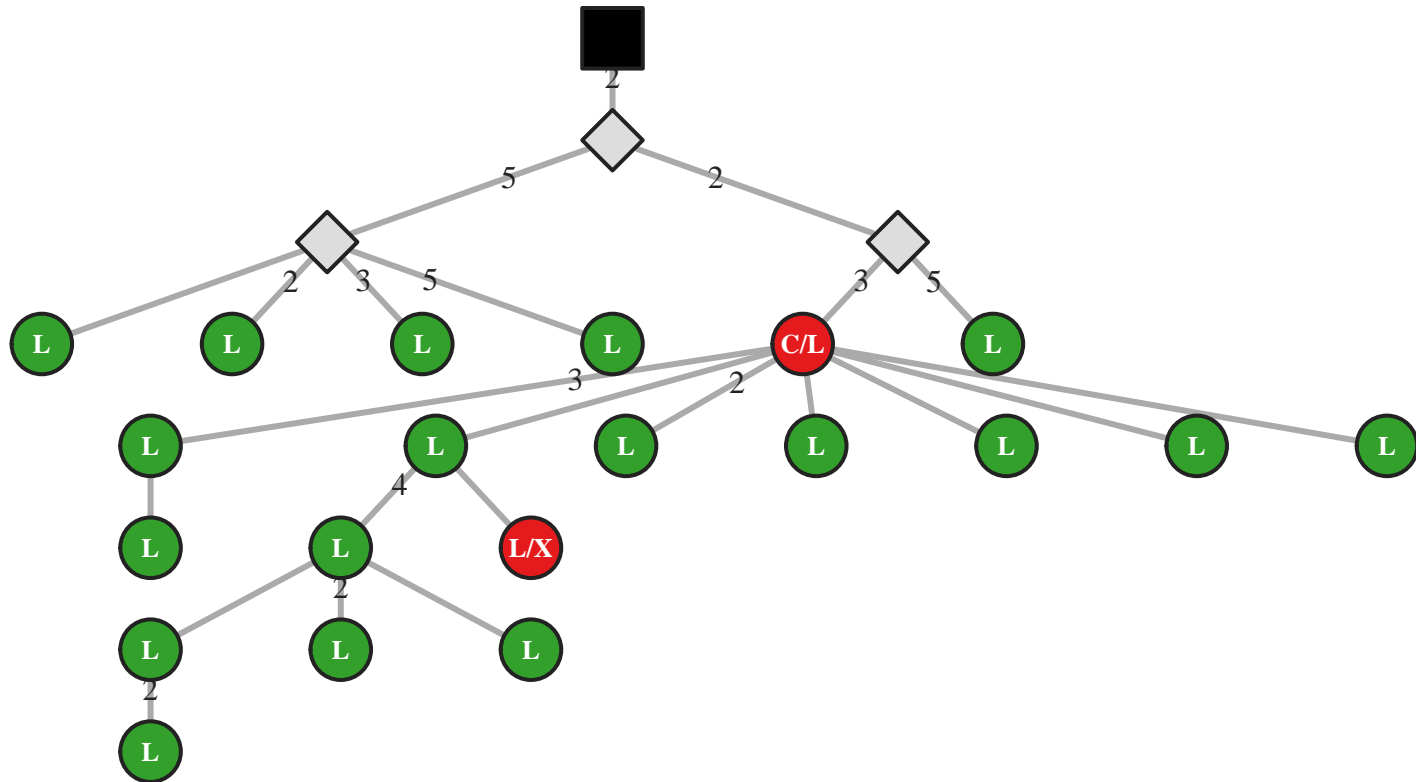

M5 IgG IGHV1-24/J4 45bp (4145)

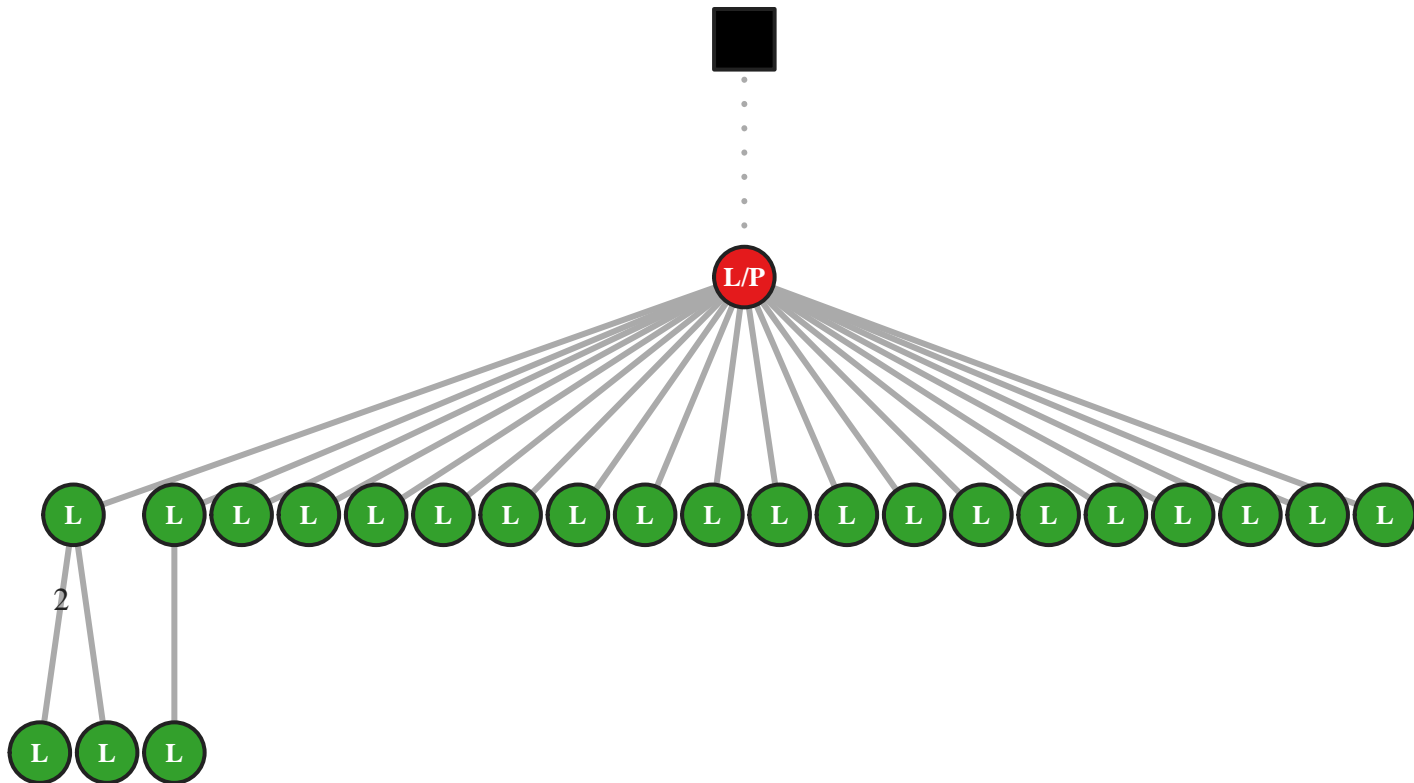

M5 IgG IGHV1-24/J4 48bp (39852)

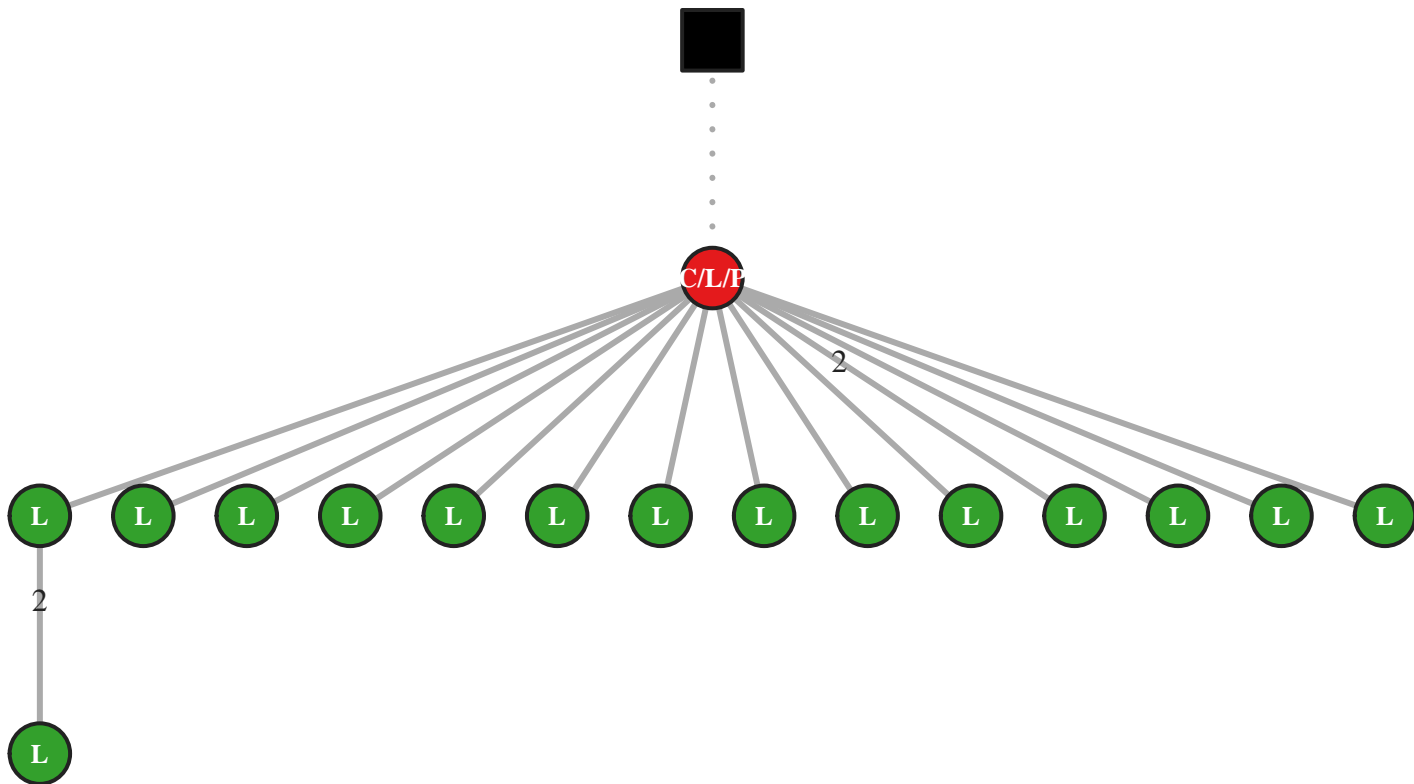

M5 IgG IGHV1-24/J4 57bp (23078)

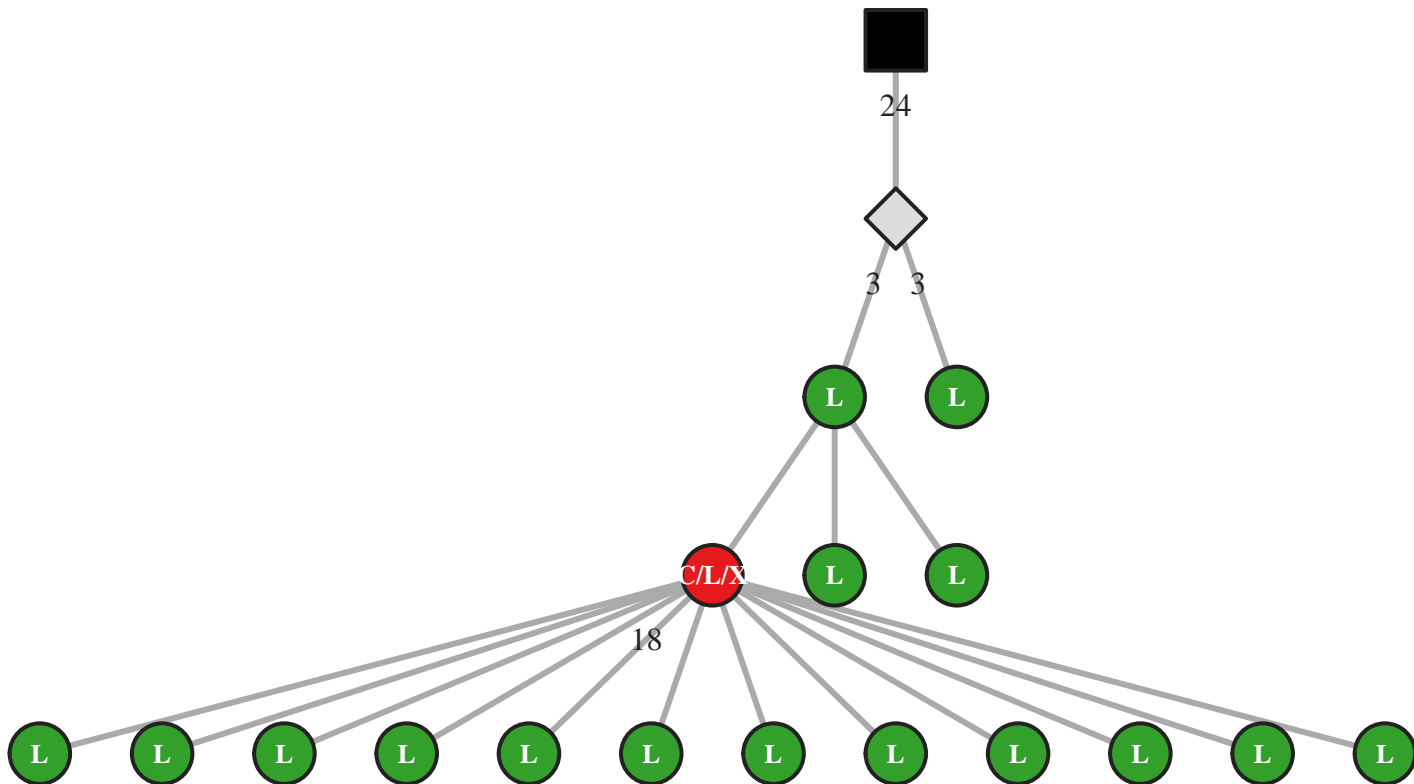

M5 IgG IGHV1-24/J4 60bp (13683)

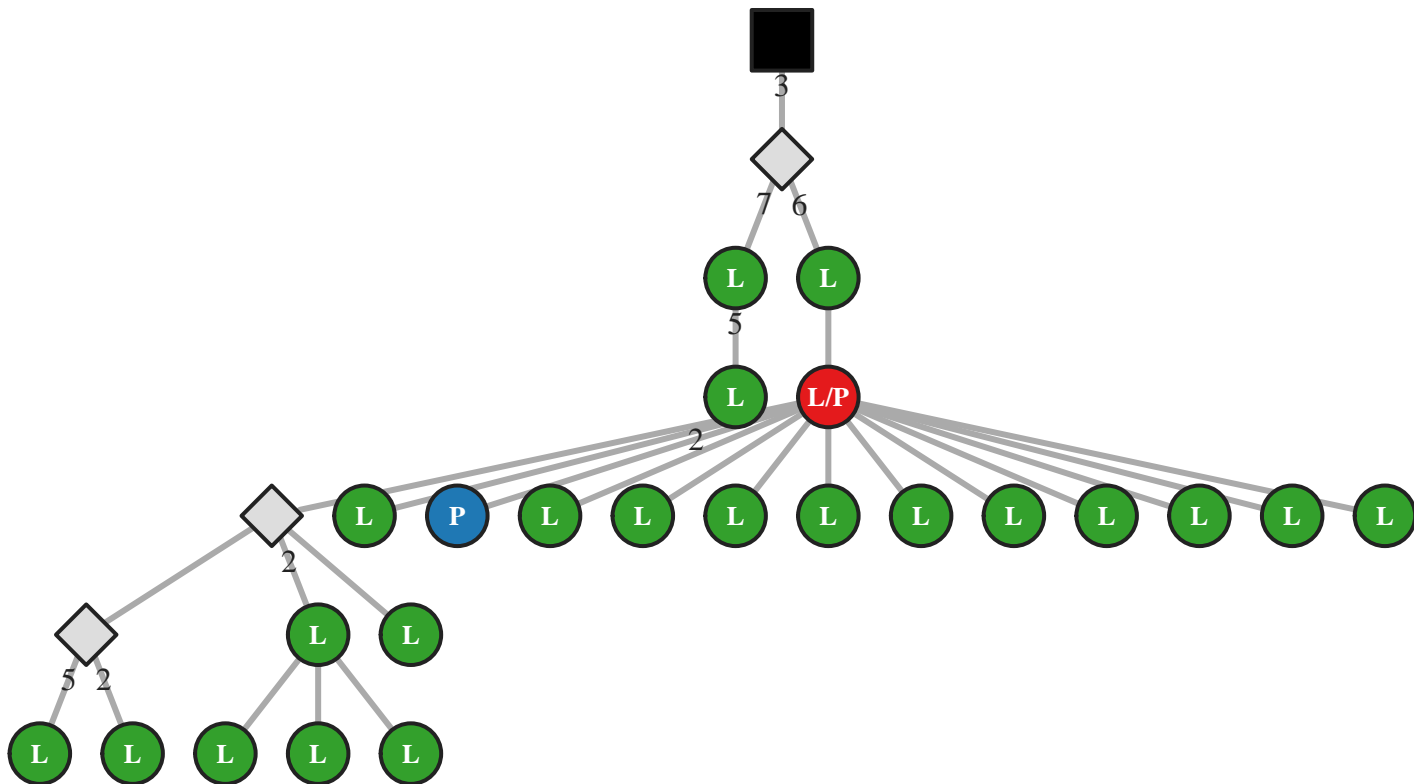

M5 IgG IGHV1-24/J4 63bp (39866)

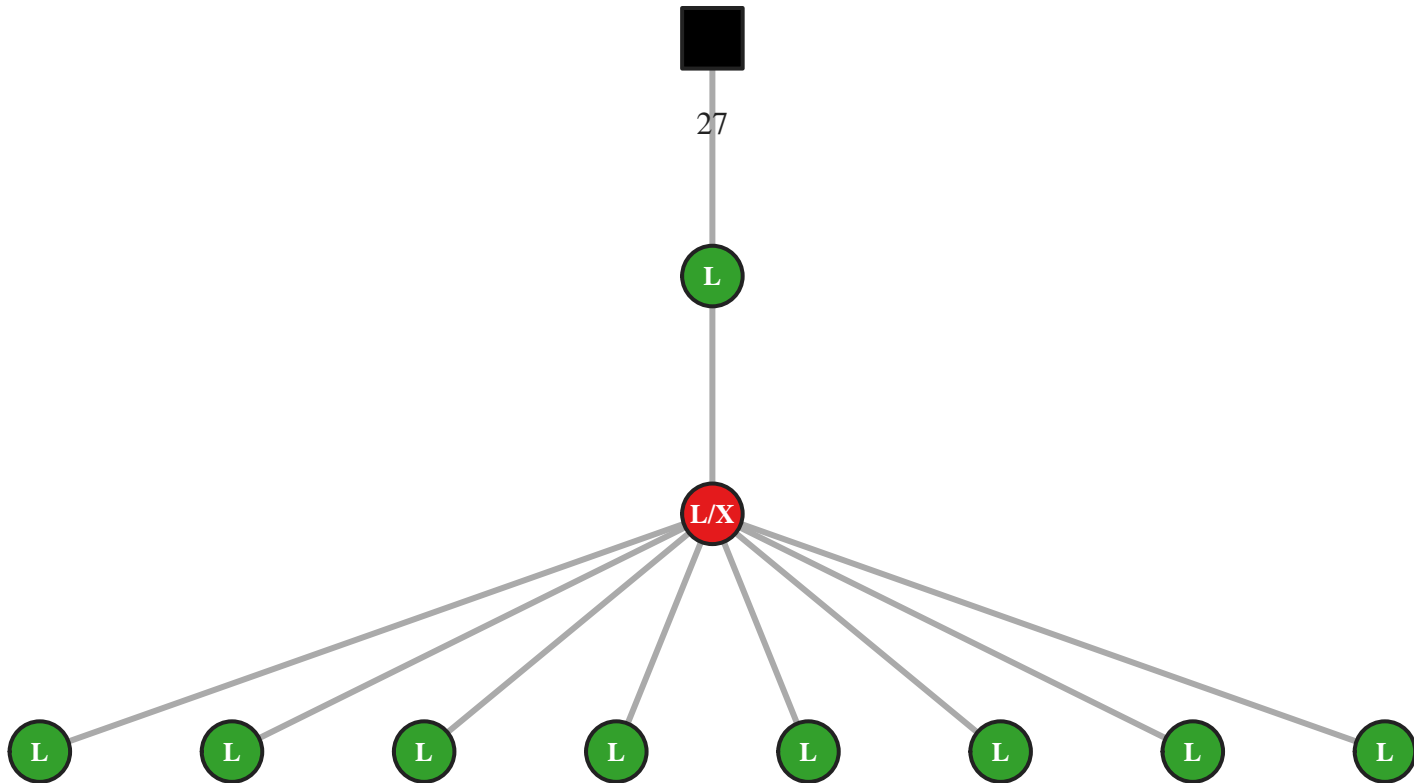

M5 IgG IGHV1-24/J5 42bp (49595)

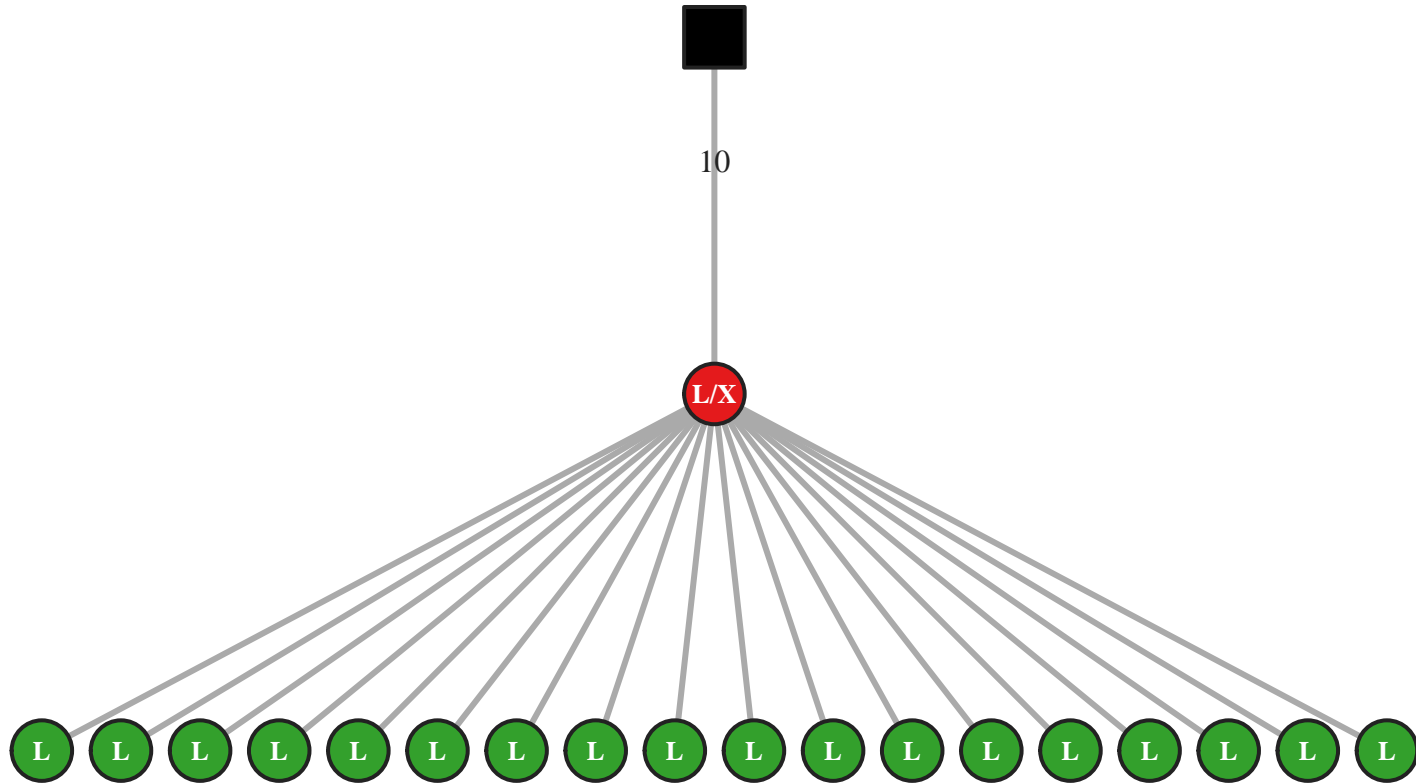

M5 IgG IGHV1-24/J5 63bp (39869)

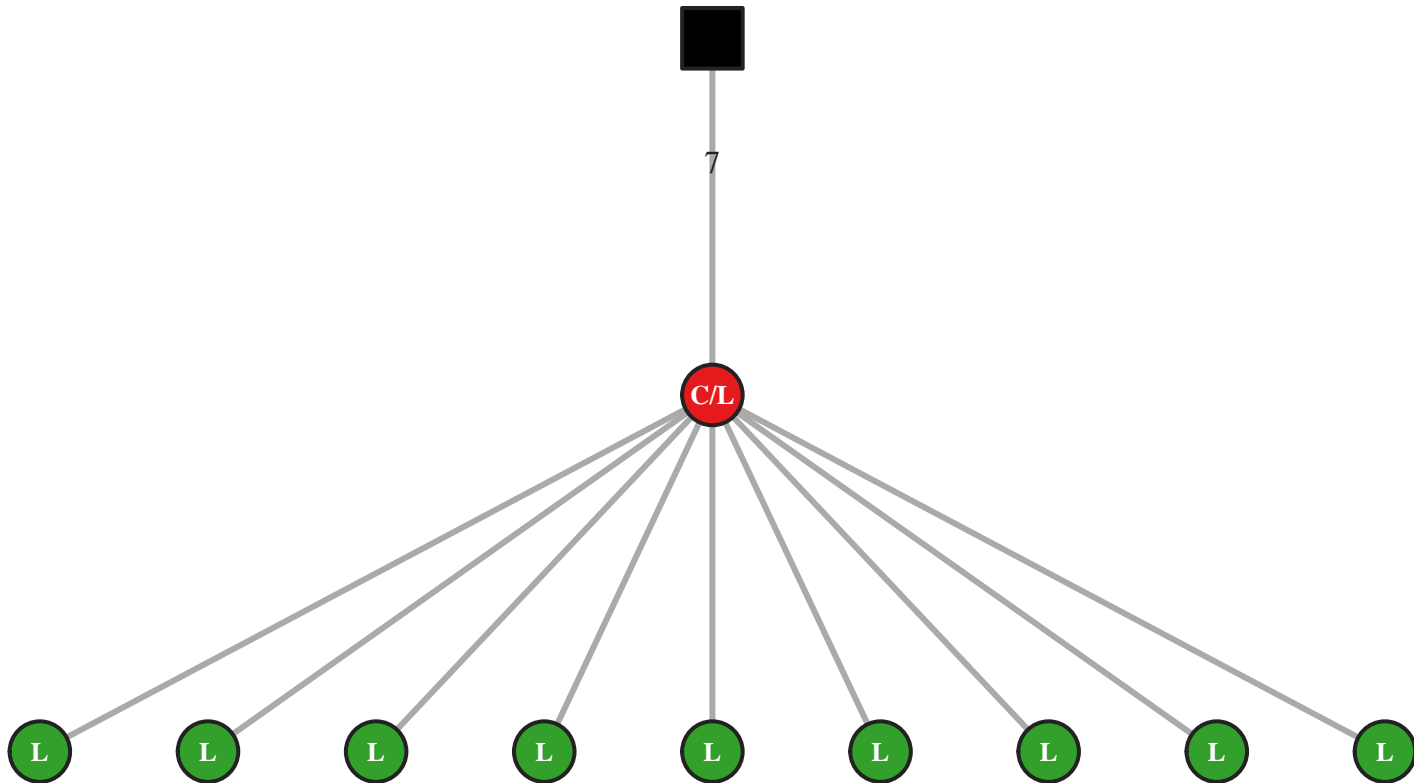

M5 IgG IGHV1-24/J5 66bp (4197)

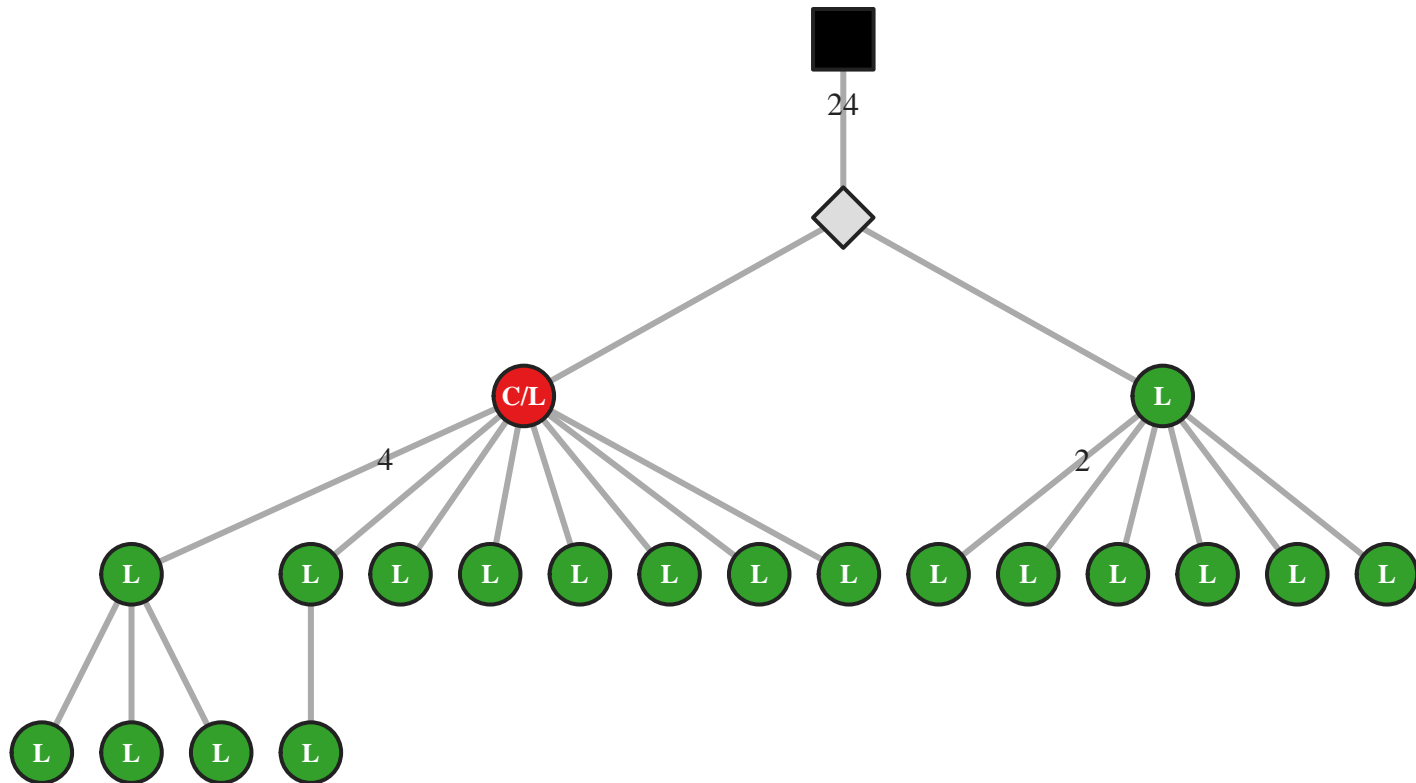

M5 IgG IGHV1-24/J6 39bp (39879)

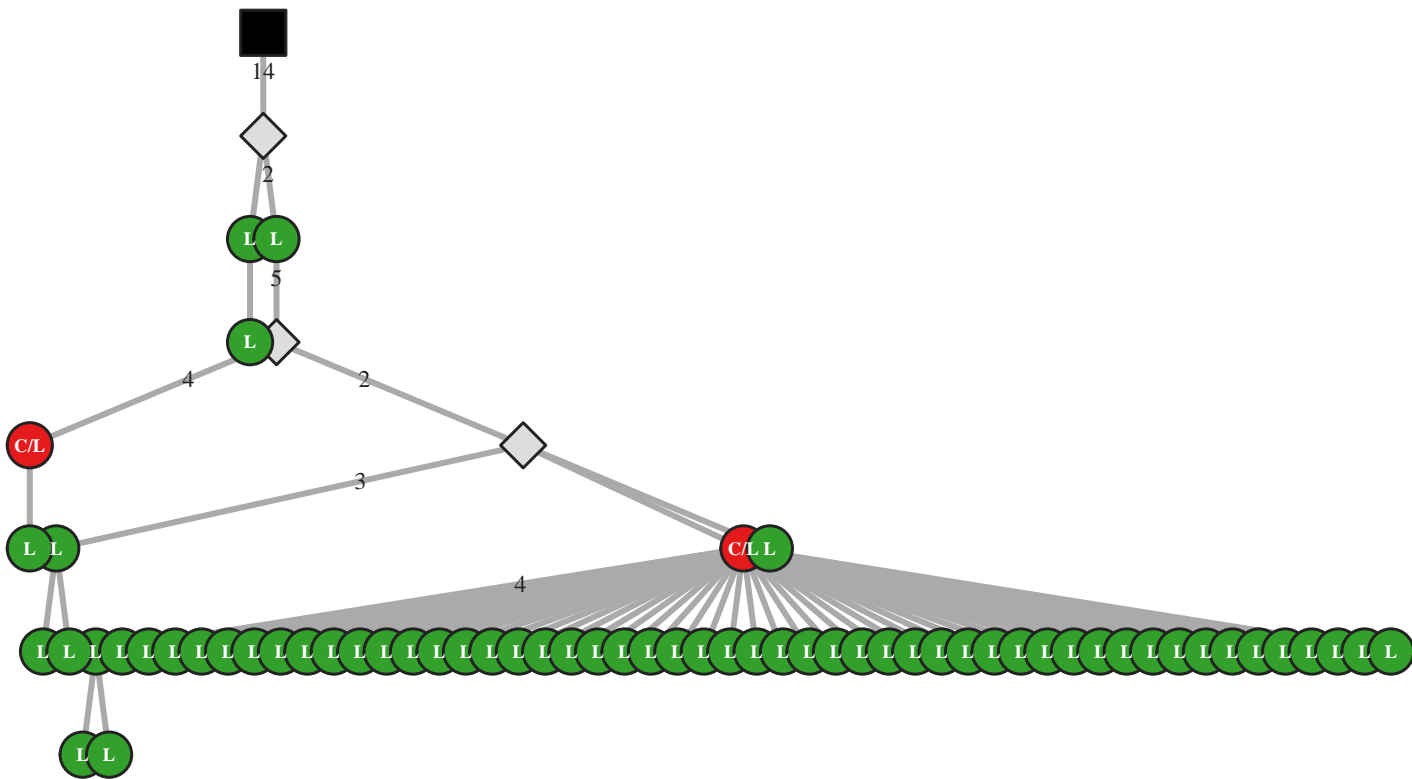

M5 IgG IGHV1-24/J6 45bp (31705)

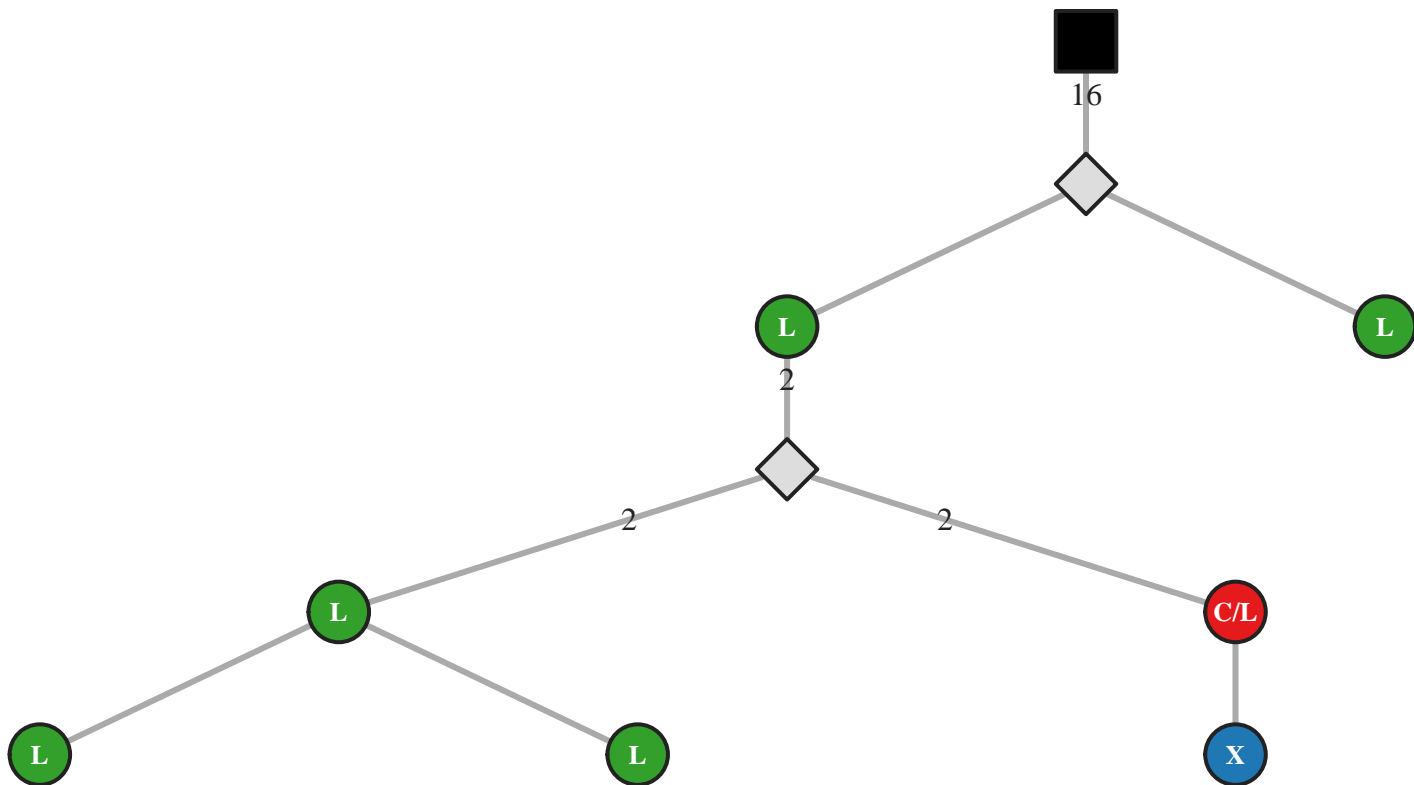

M5 IgG IGHV1-24/J6 51bp (31707)

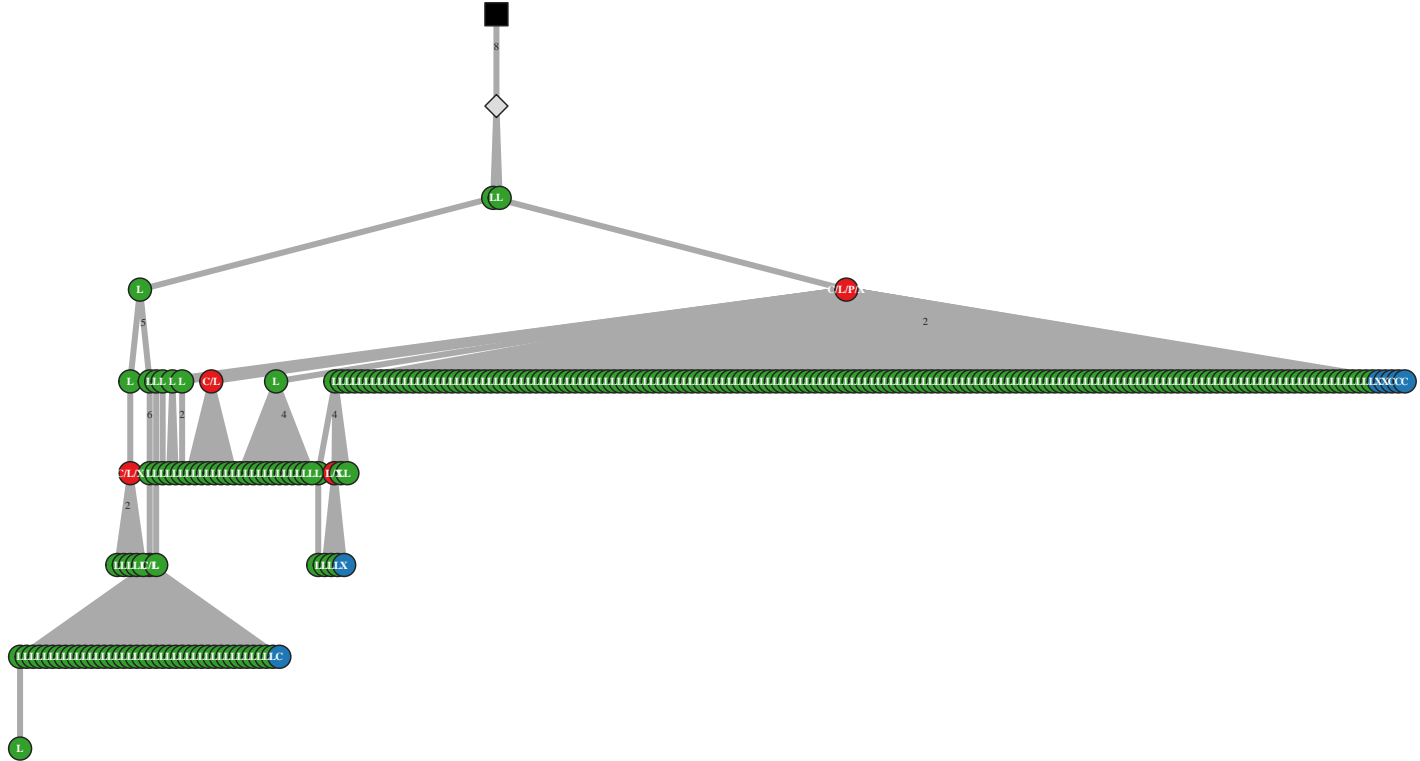

M5 IgA IGHV1-24/J6 66bp (2203)

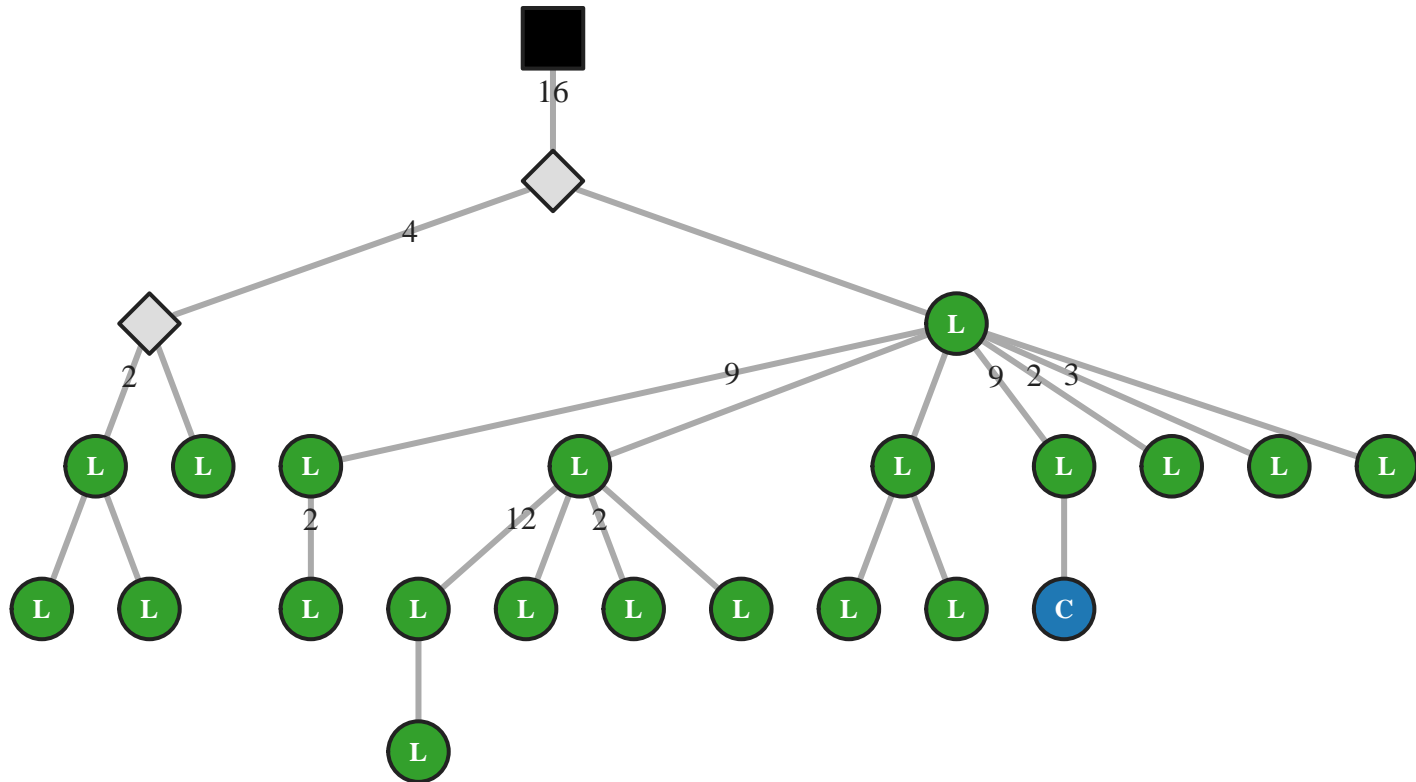

M5 IgG IGHV1-24/J6 72bp (31714)

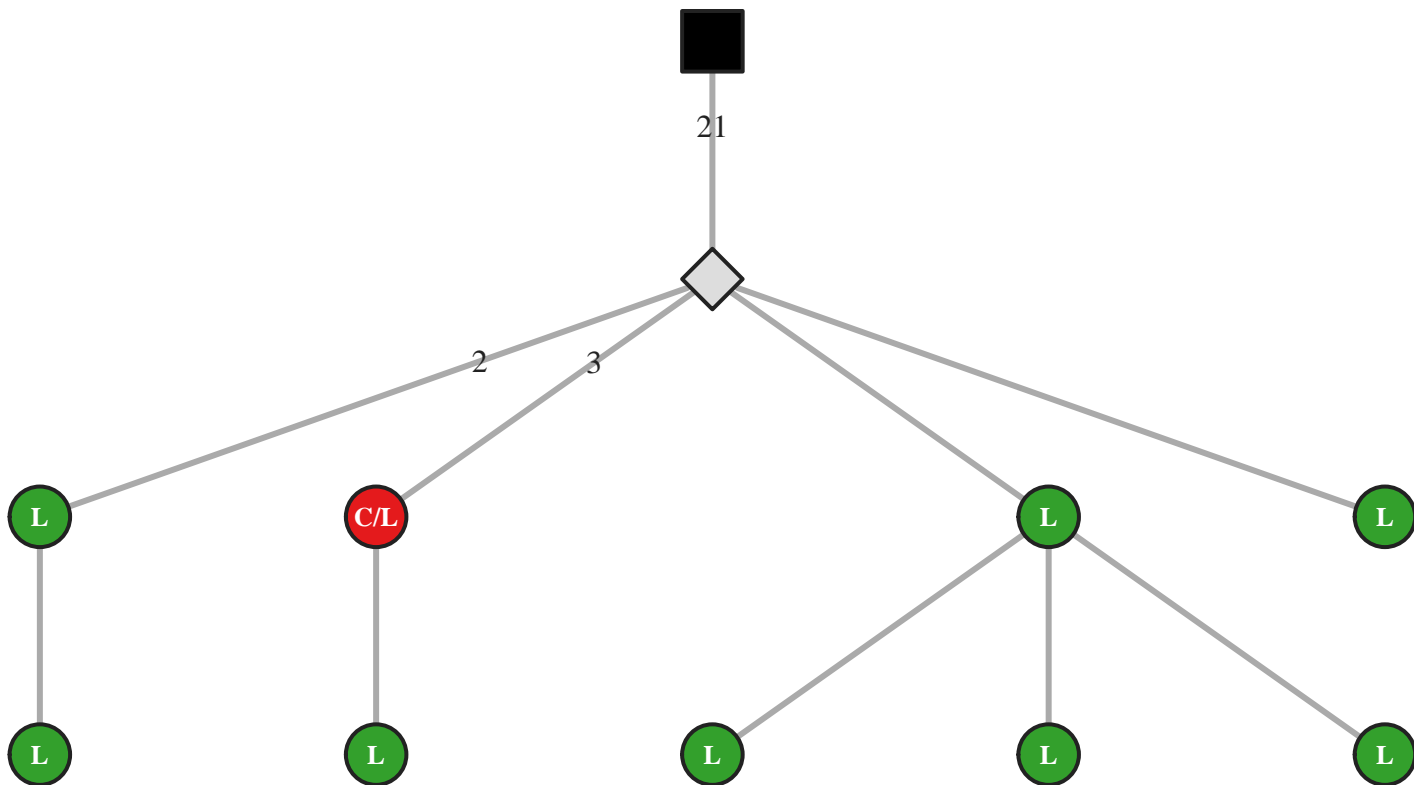

M5 IgG IGHV1-3/J1 45bp (49757)

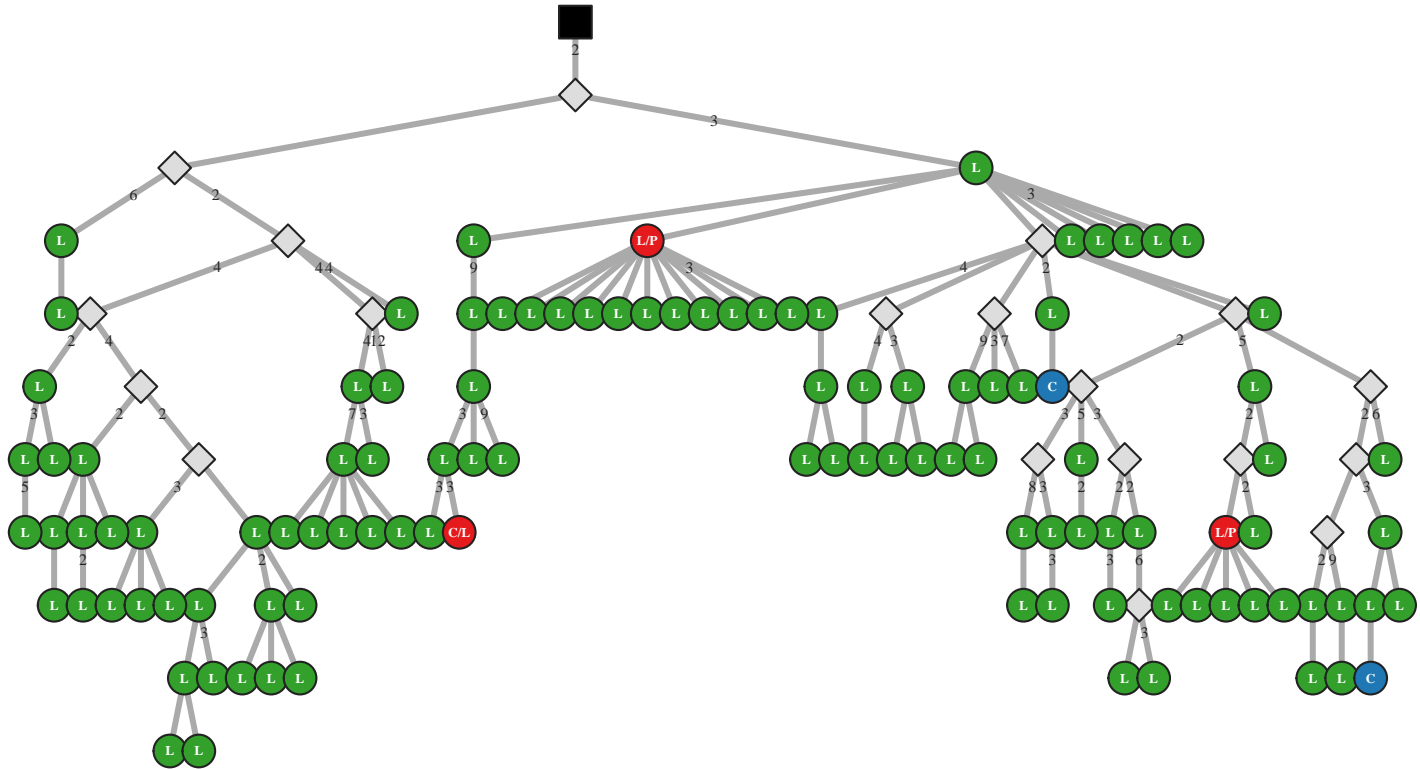

M5 IgG IGHV1-3/J1 57bp (32047)

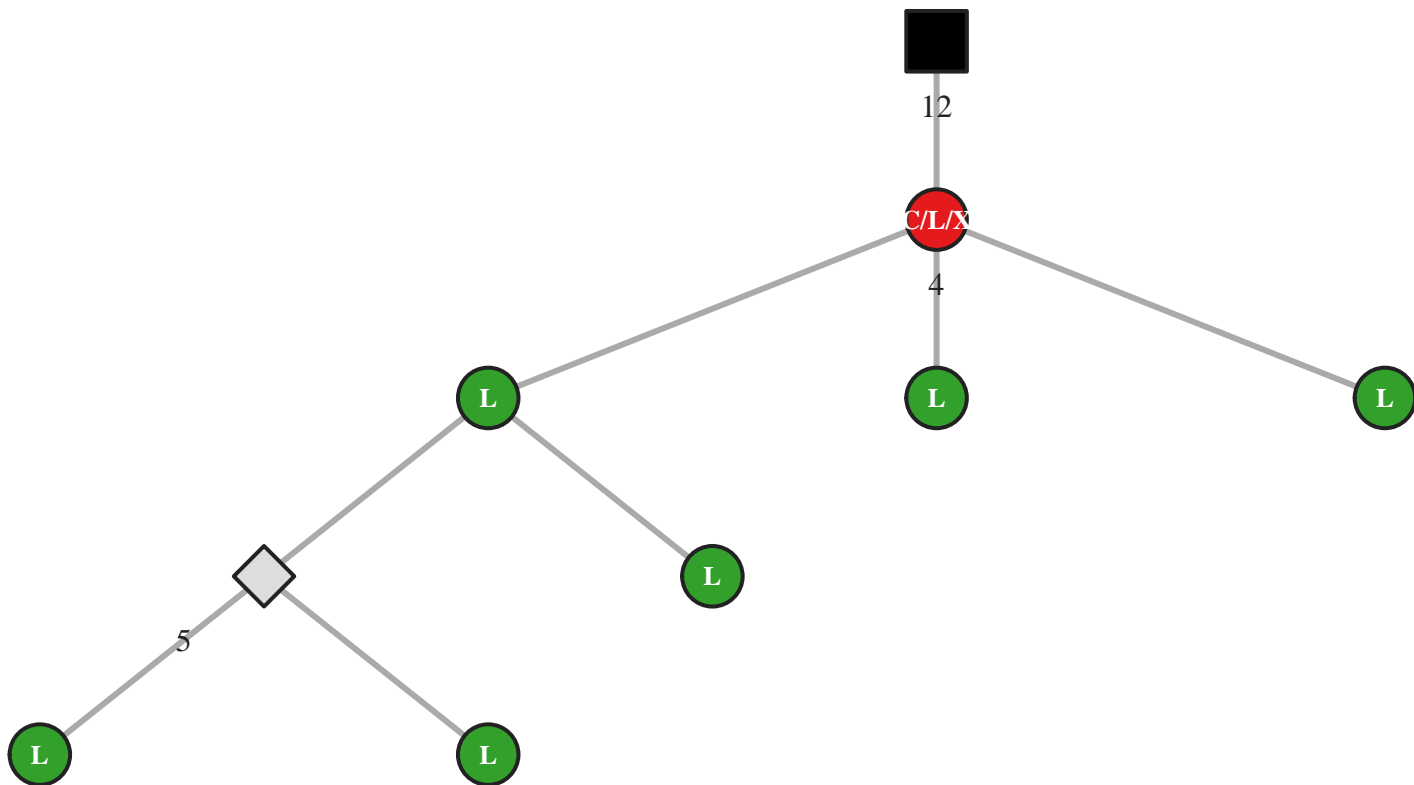

M5 IgA IGHV1-3/J3 30bp (30137)

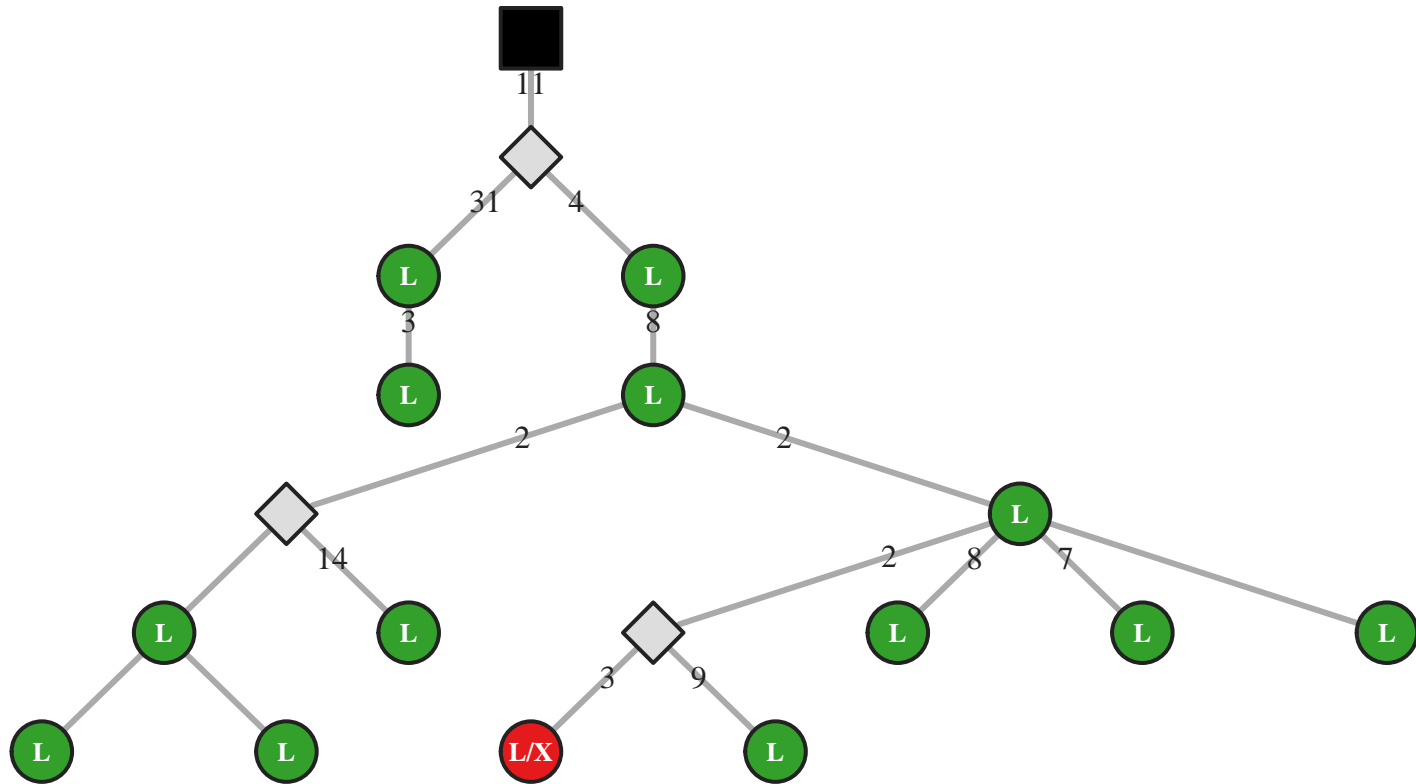

M5 IgG IGHV1-3/J4 24bp (23440)

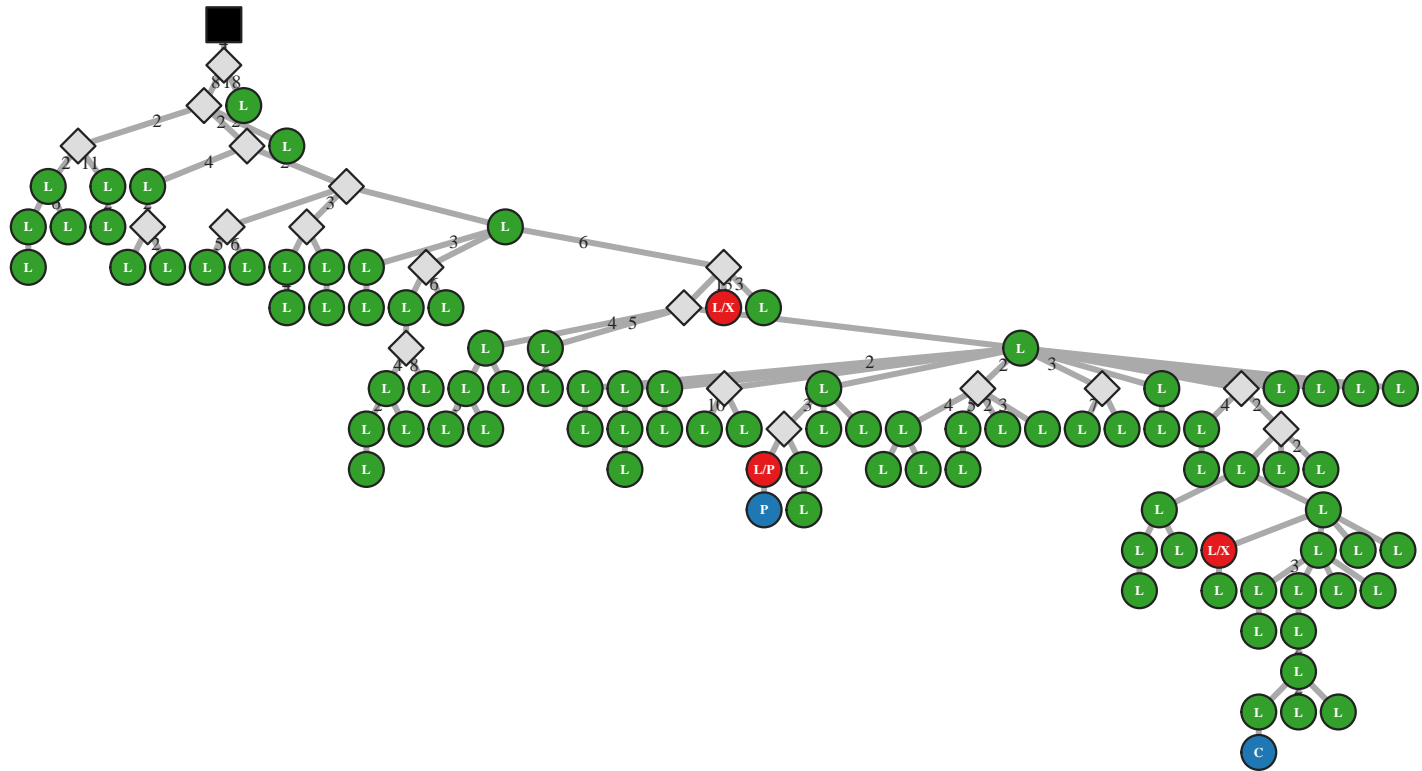

M5 IgG IGHV1-3/J4 27bp (23444)

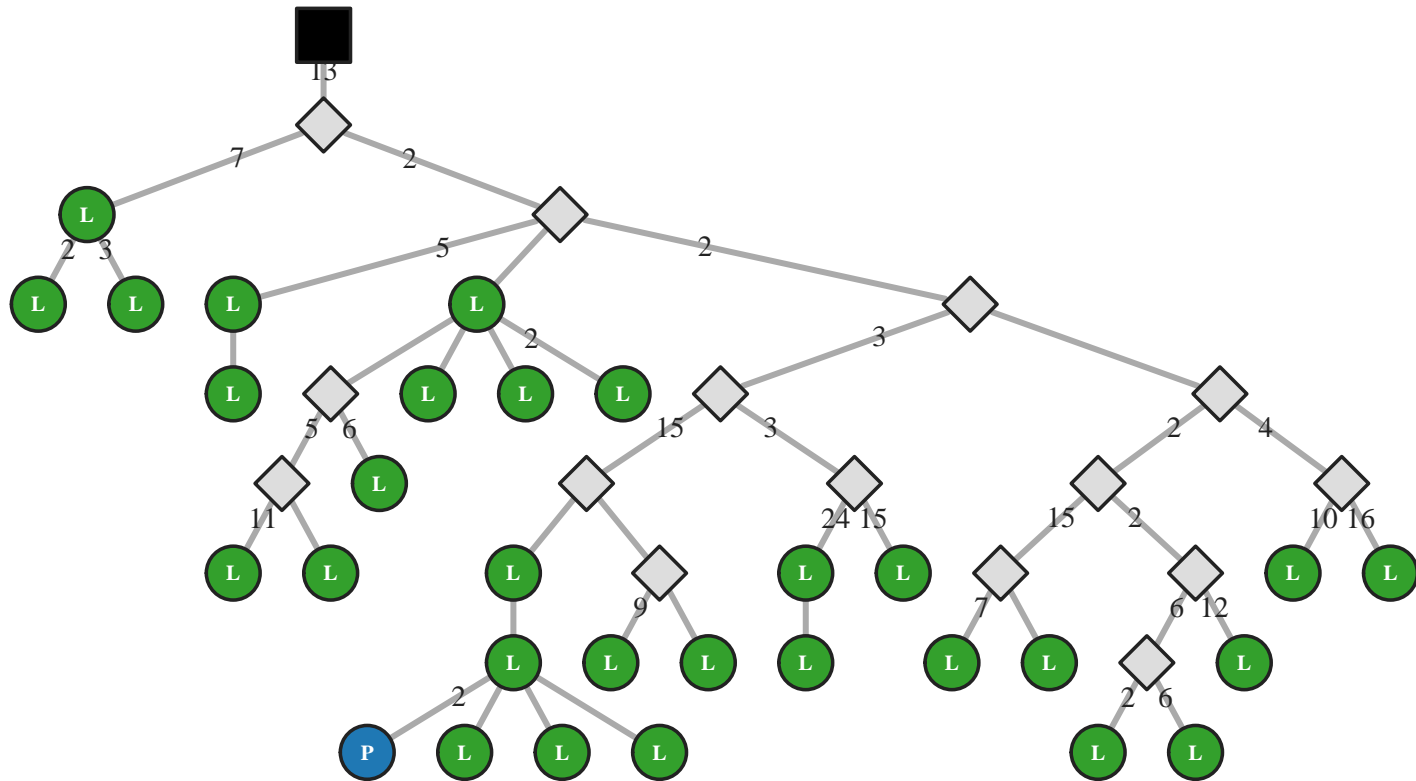

M5 IgG IGHV1-3/J4 33bp (14121)

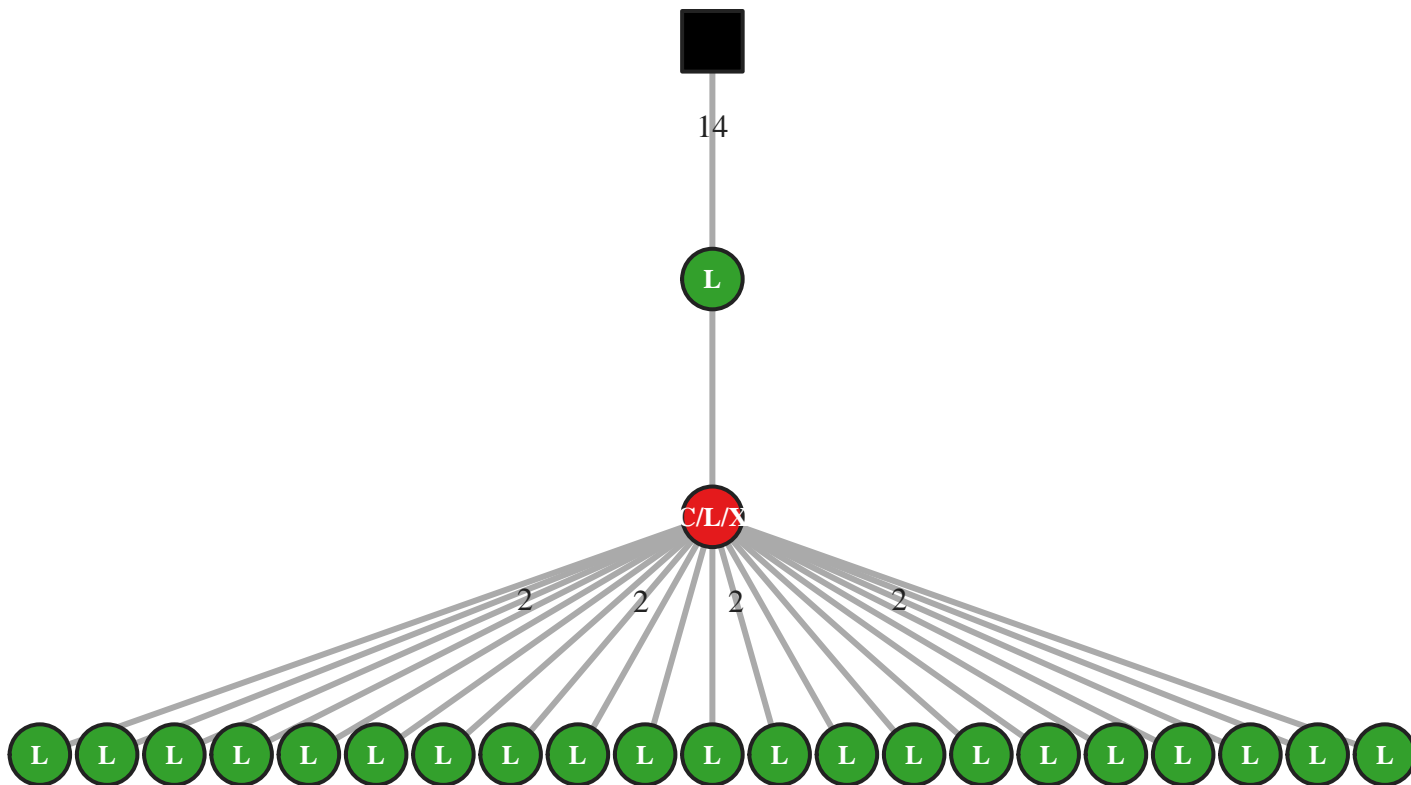

M5 IgG IGHV1-3/J4 39bp (40321)

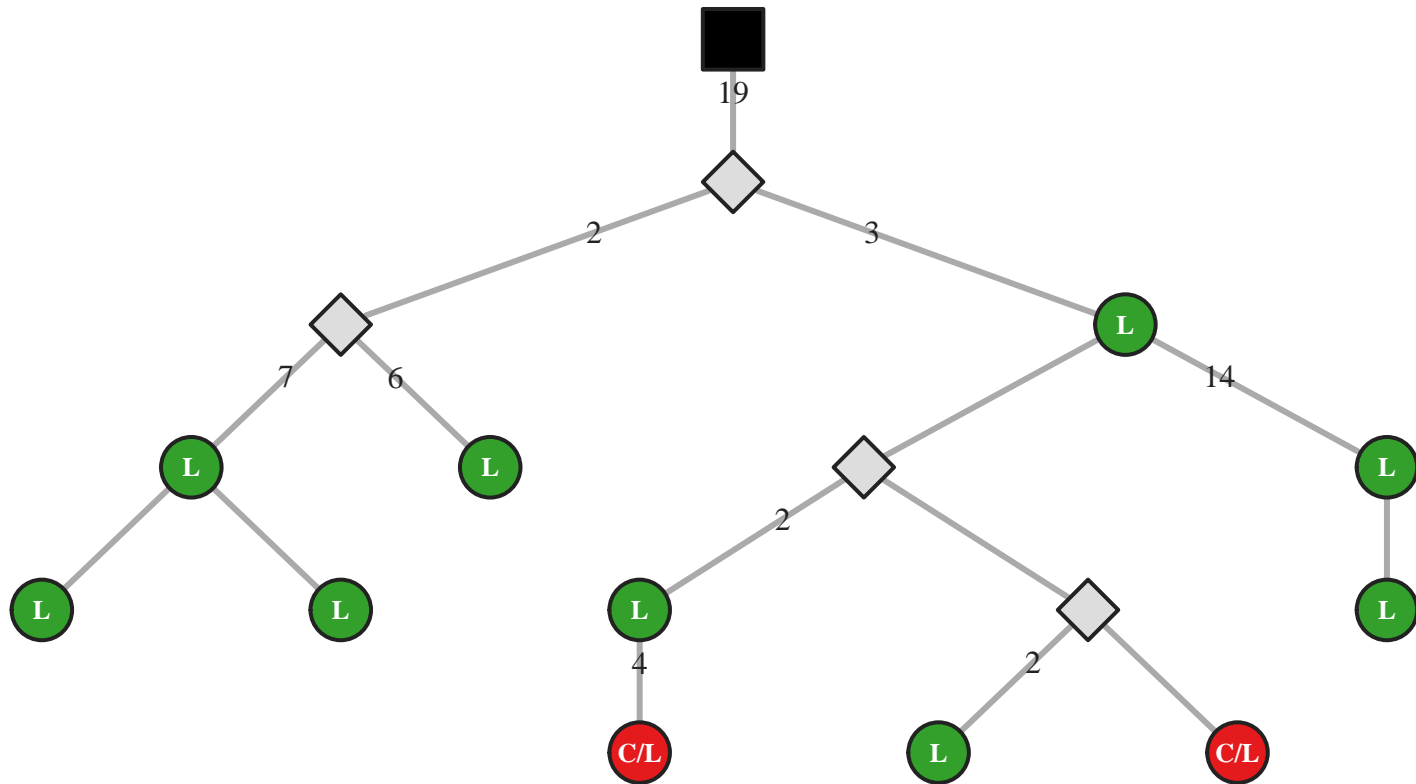

M5 IgG IGHV1-3/J4 39bp (40324)

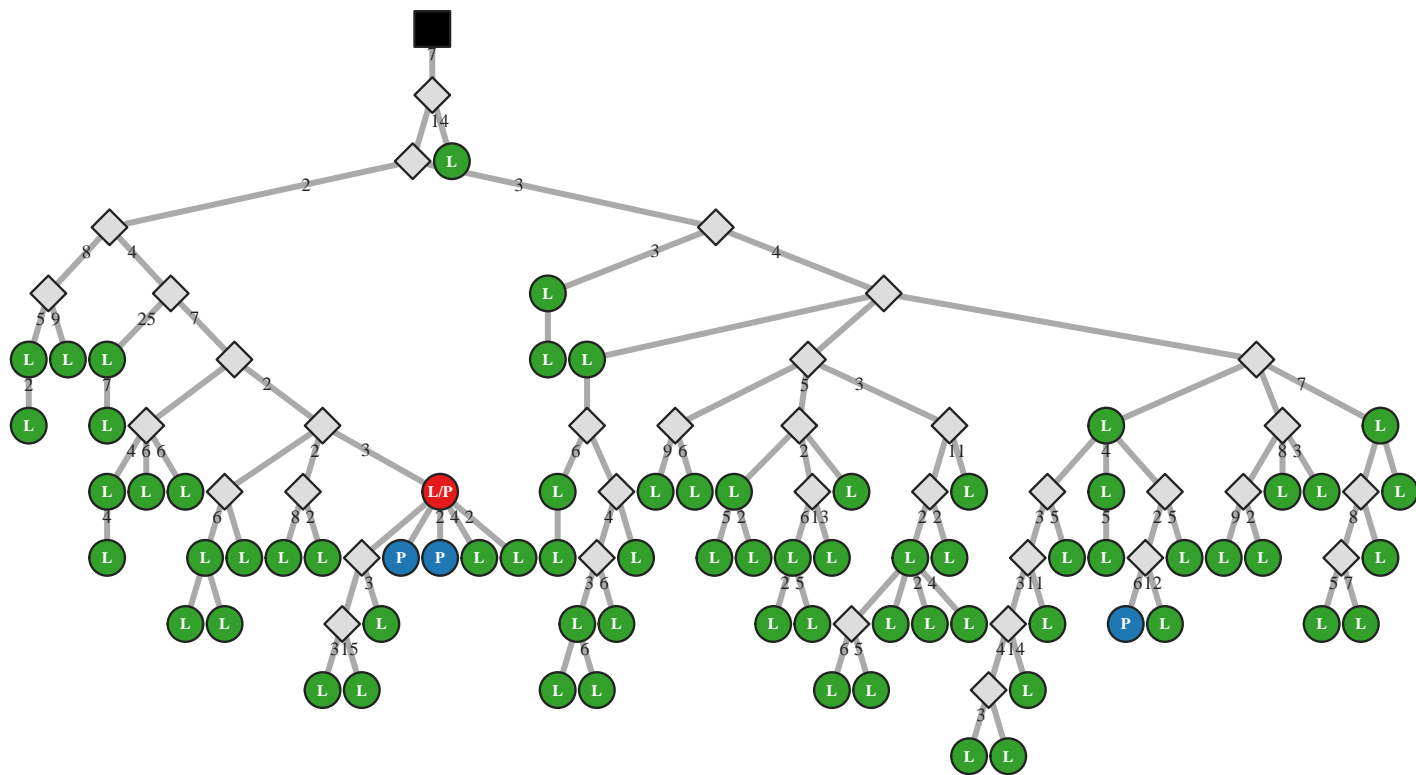

M5 IgG IGHV1-3/J4 39bp (40346)

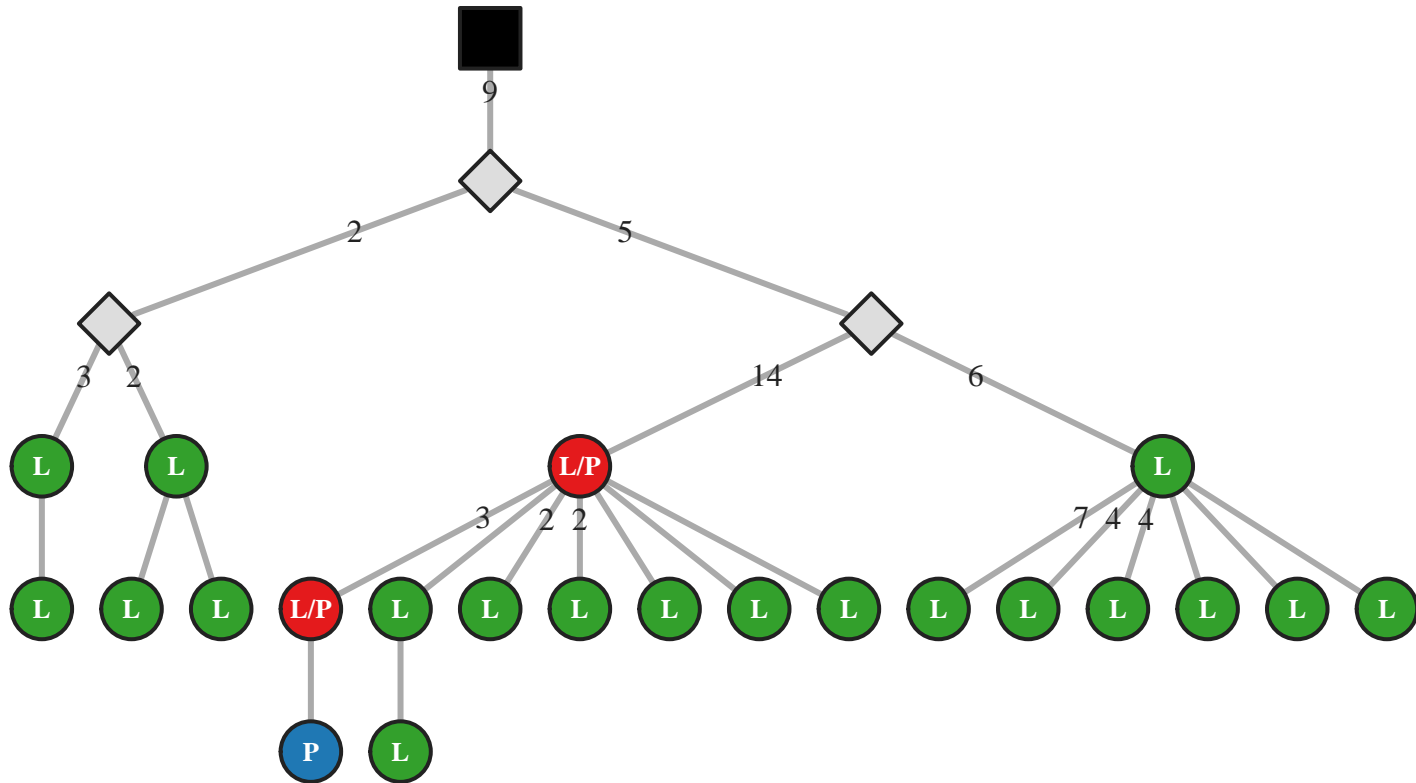

M5 IgG IGHV1-3/J4 39bp (40348)

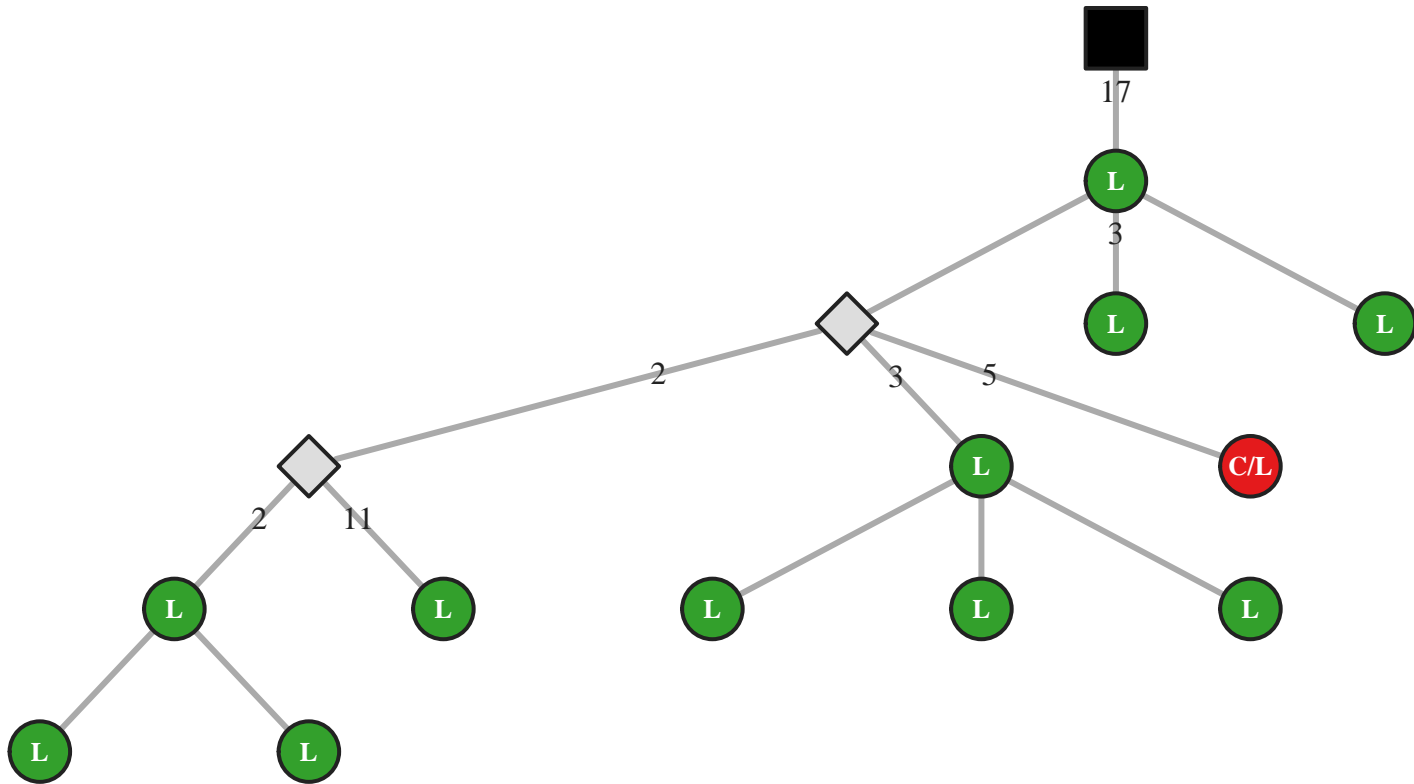

M5 IgG IGHV1-3/J4 42bp (32115)

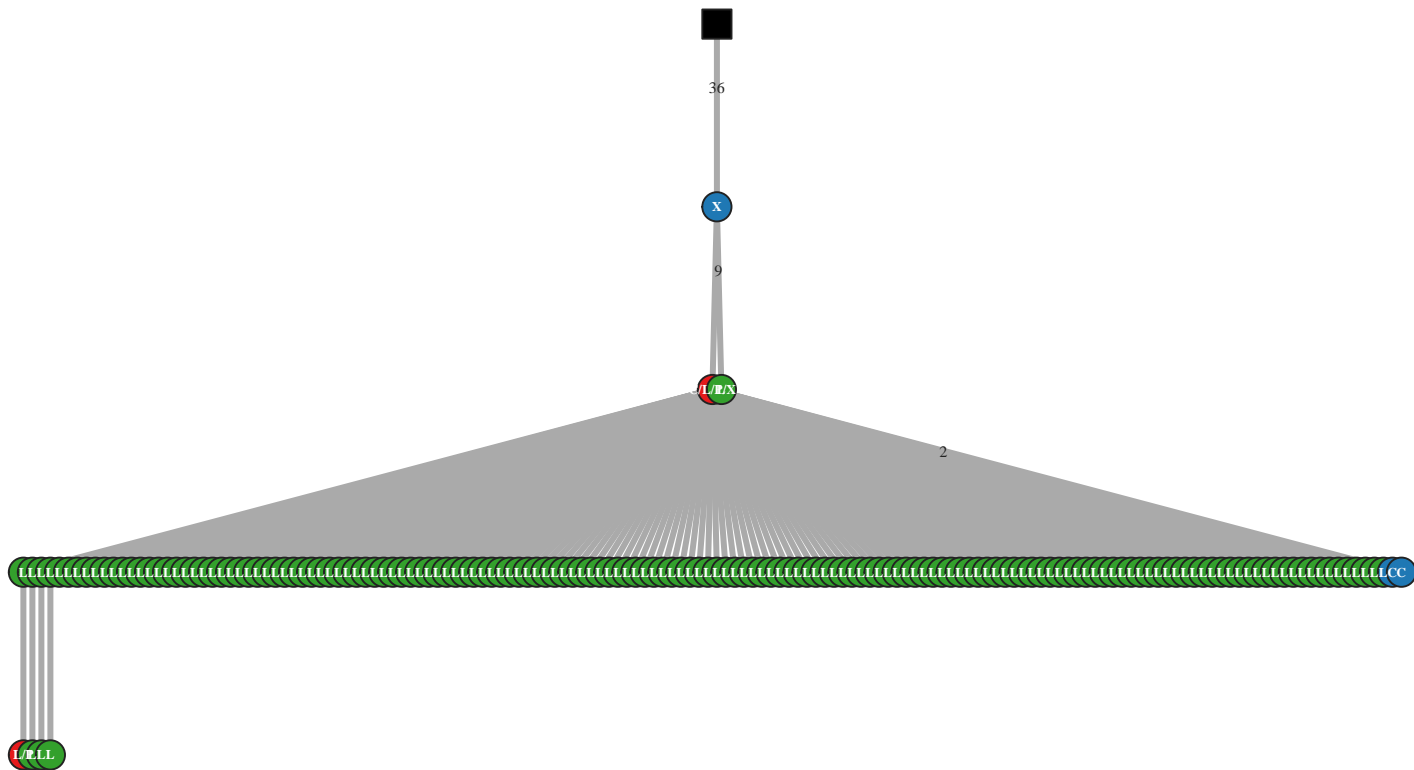

M5 IgG IGHV1-3/J4 45bp (49792)

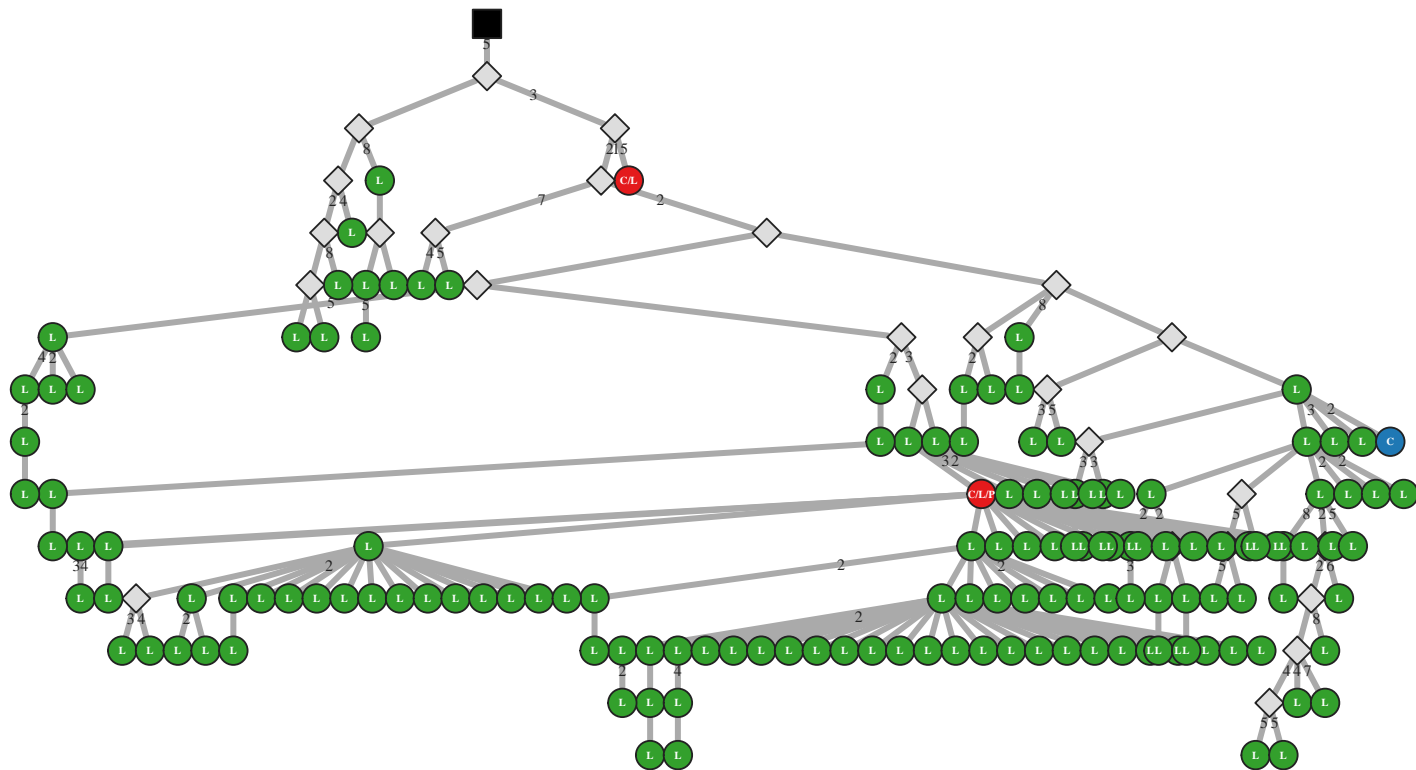

M5 IgG IGHV1-3/J4 45bp (49799)

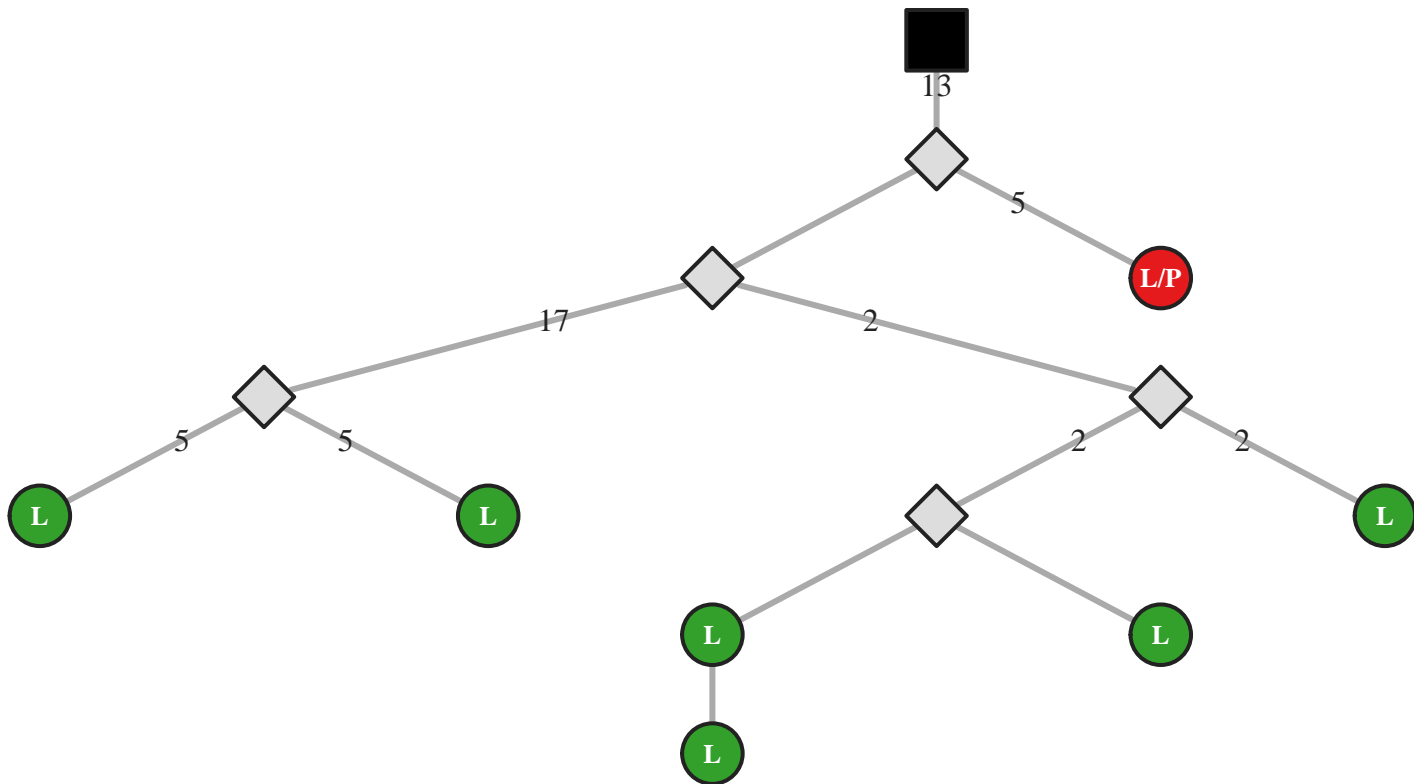

M5 IgG IGHV1-3/J4 45bp (49813)

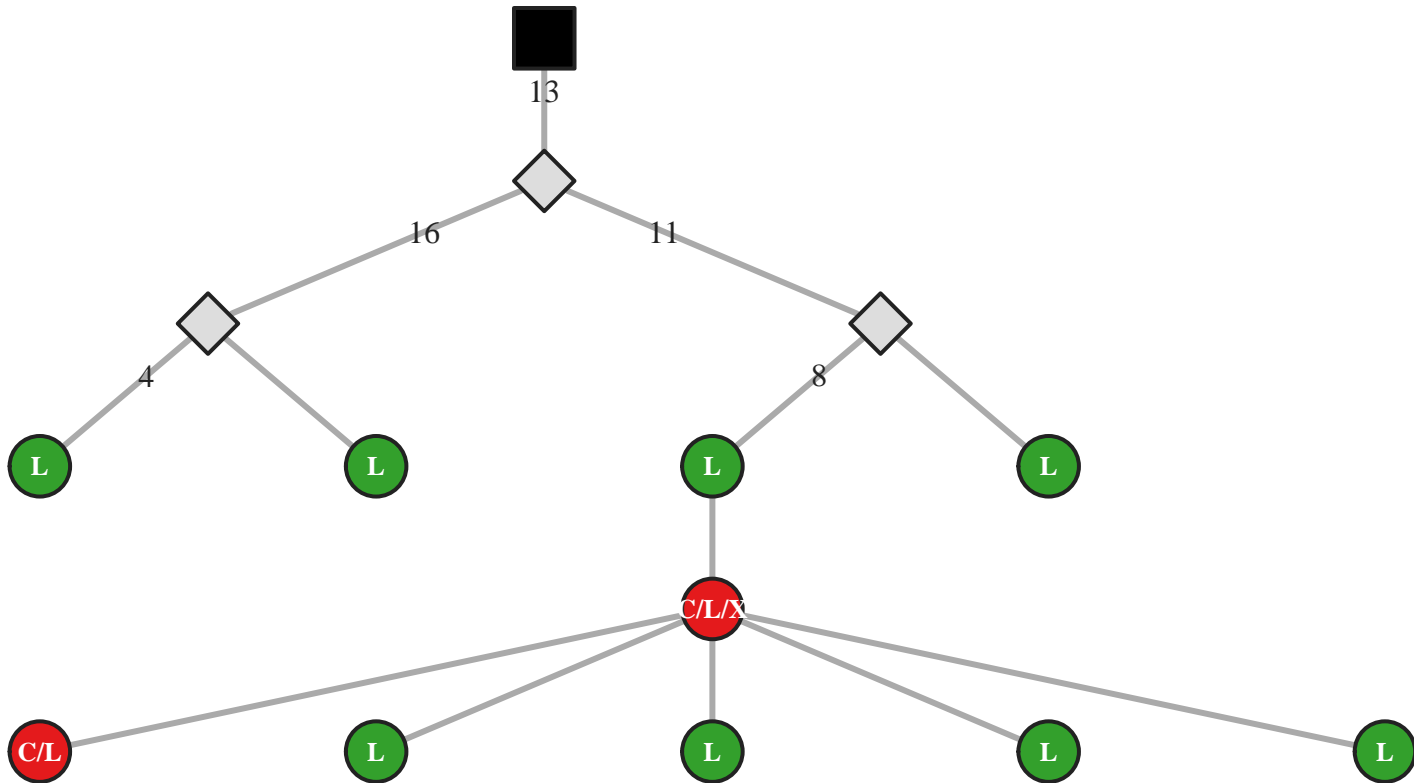

M5 IgG IGHV1-3/J4 45bp (49842)

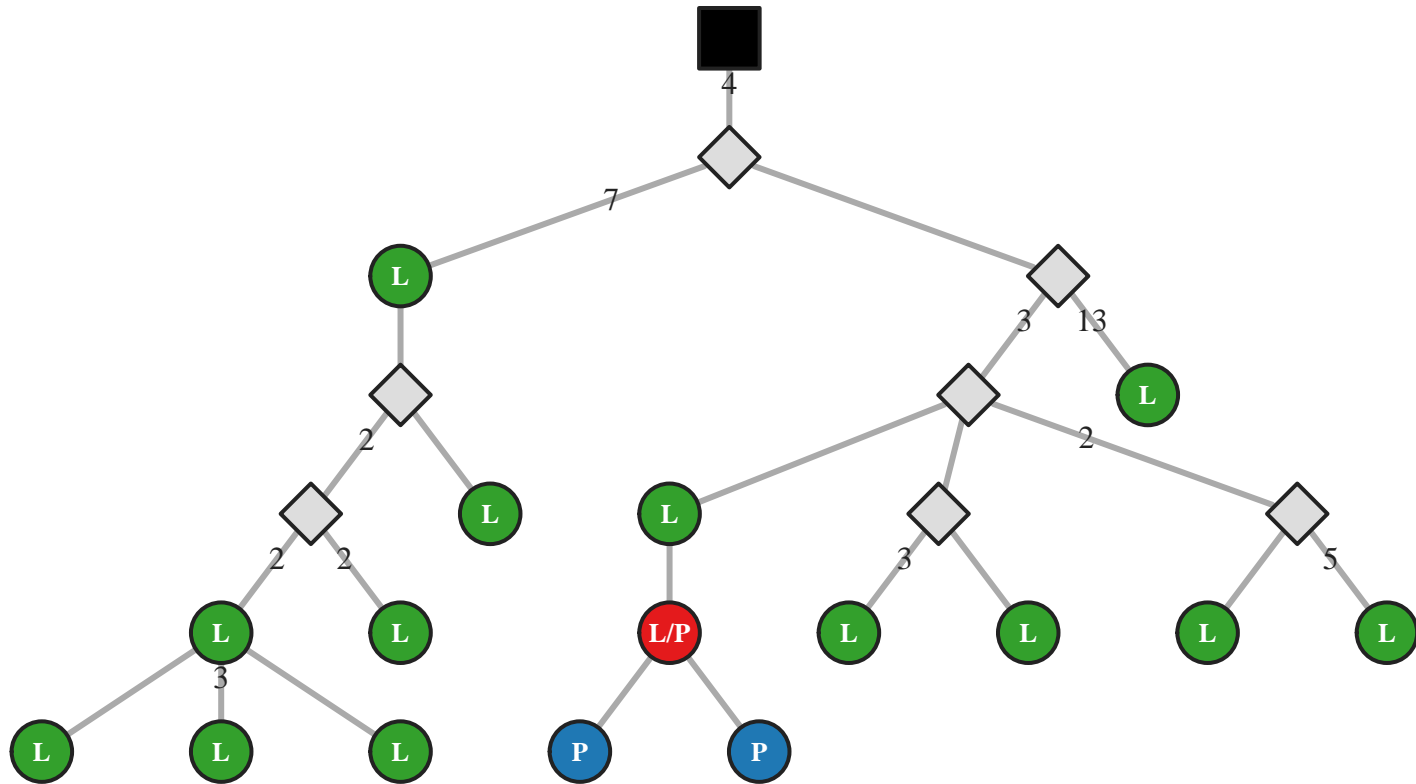

M5 IgG IGHV1-3/J4 48bp (4539)

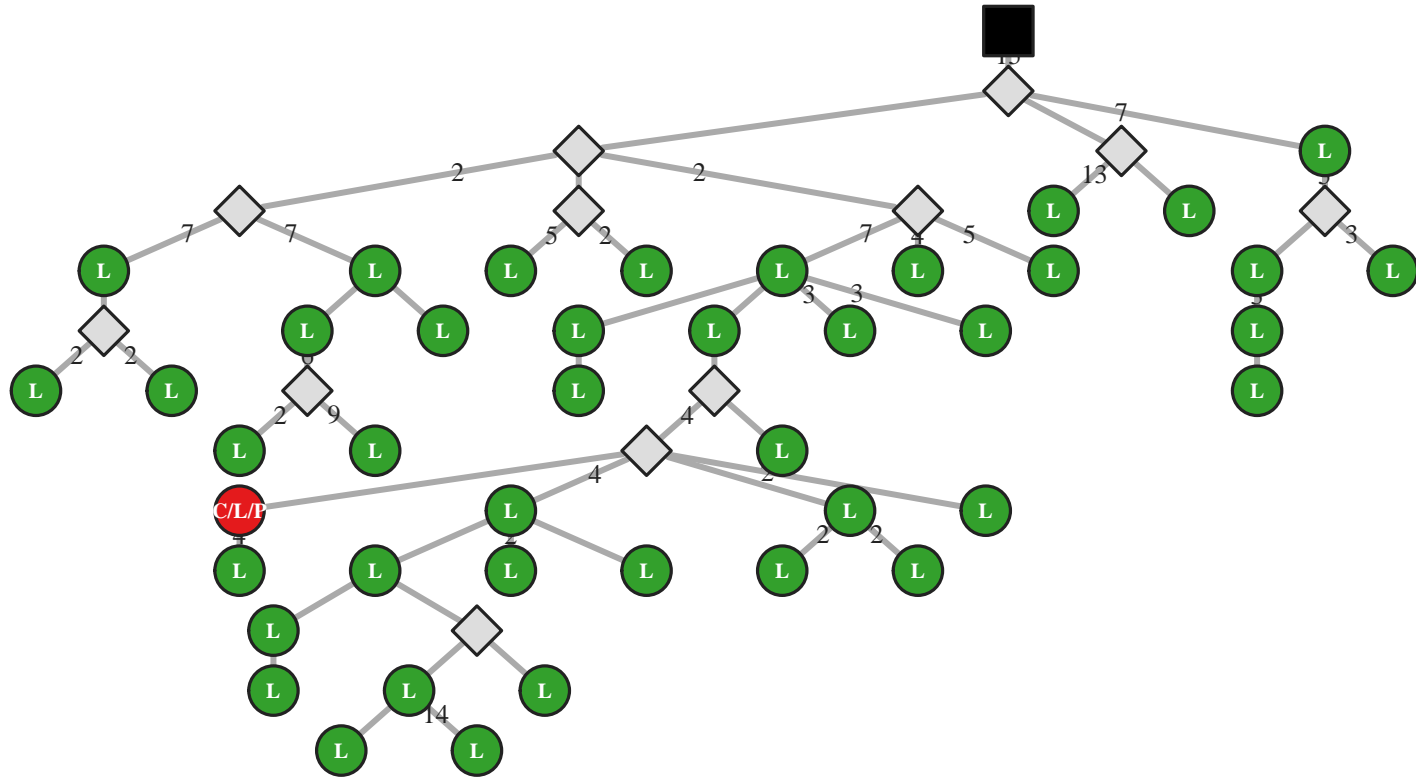

M5 IgG IGHV1-3/J4 48bp (4559)

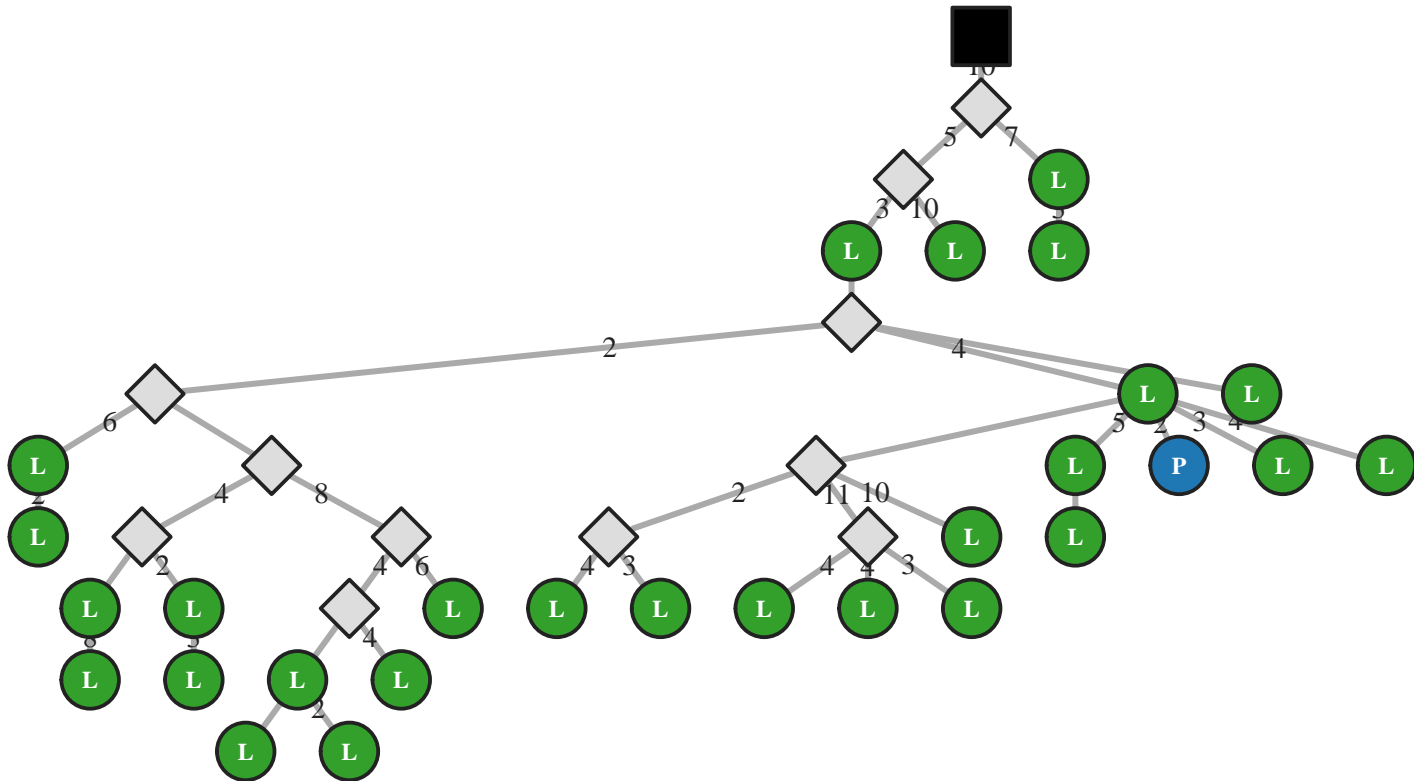

M5 IgG IGHV1-3/J4 51bp (40364)

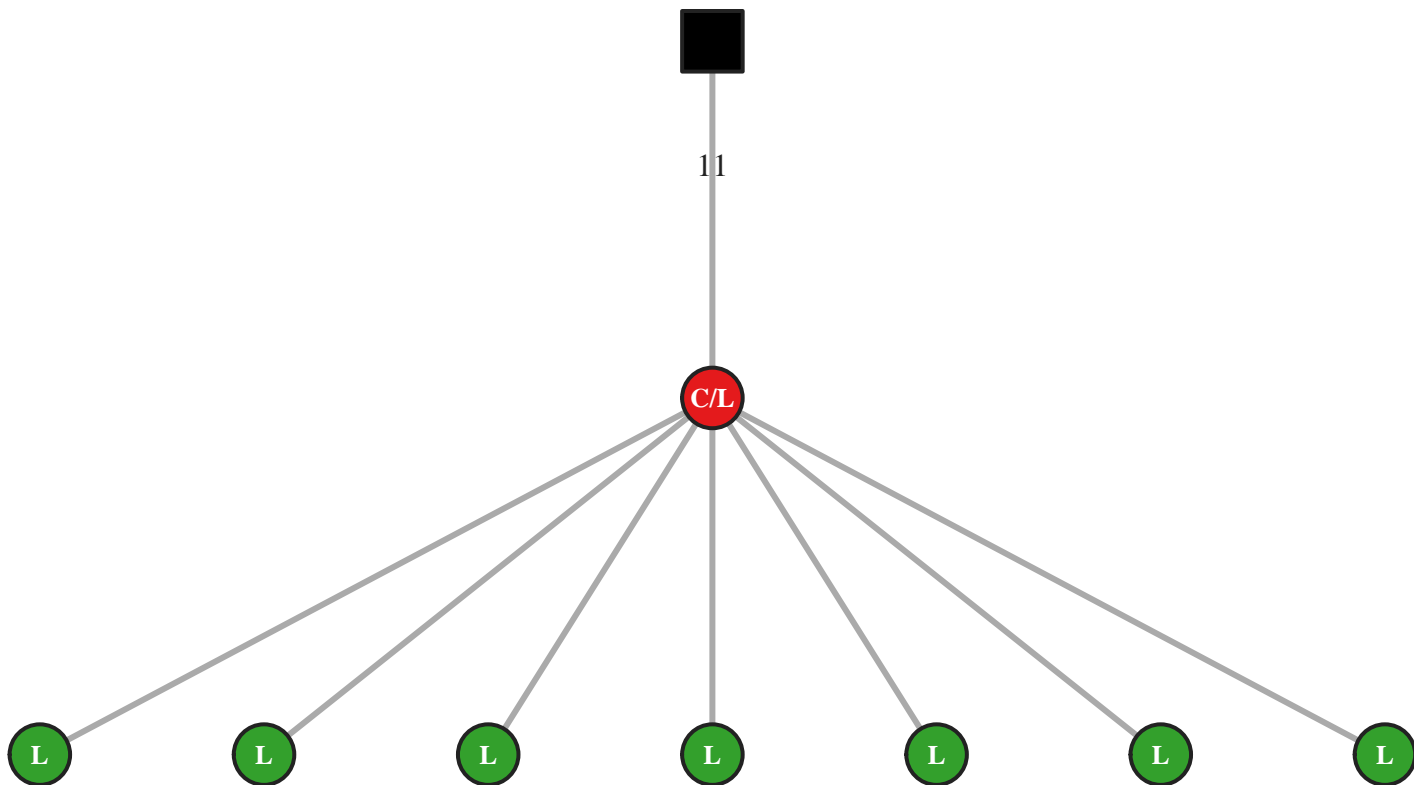

M5 IgG IGHV1-3/J4 51bp (40380)

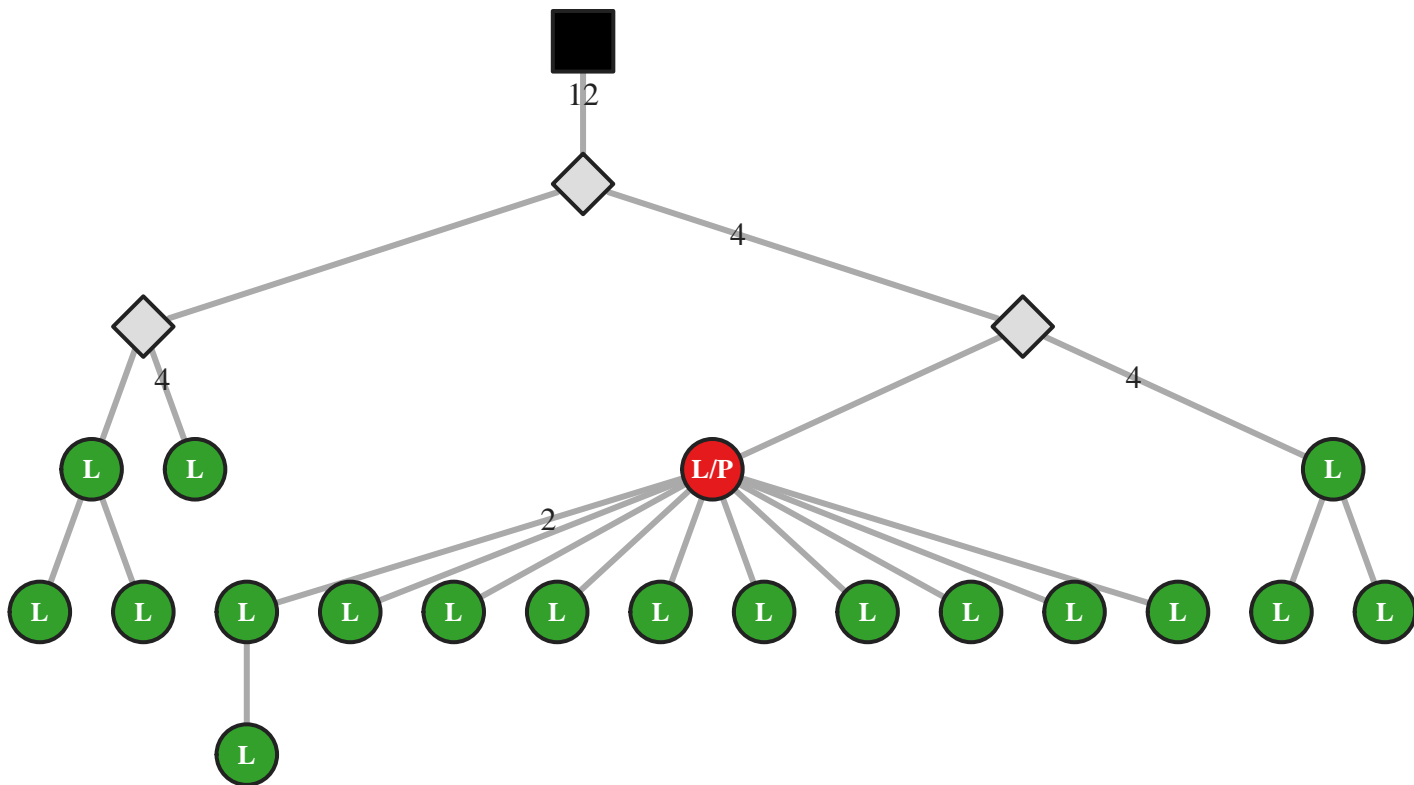

M5 IgG IGHV1-3/J4 57bp (14141)

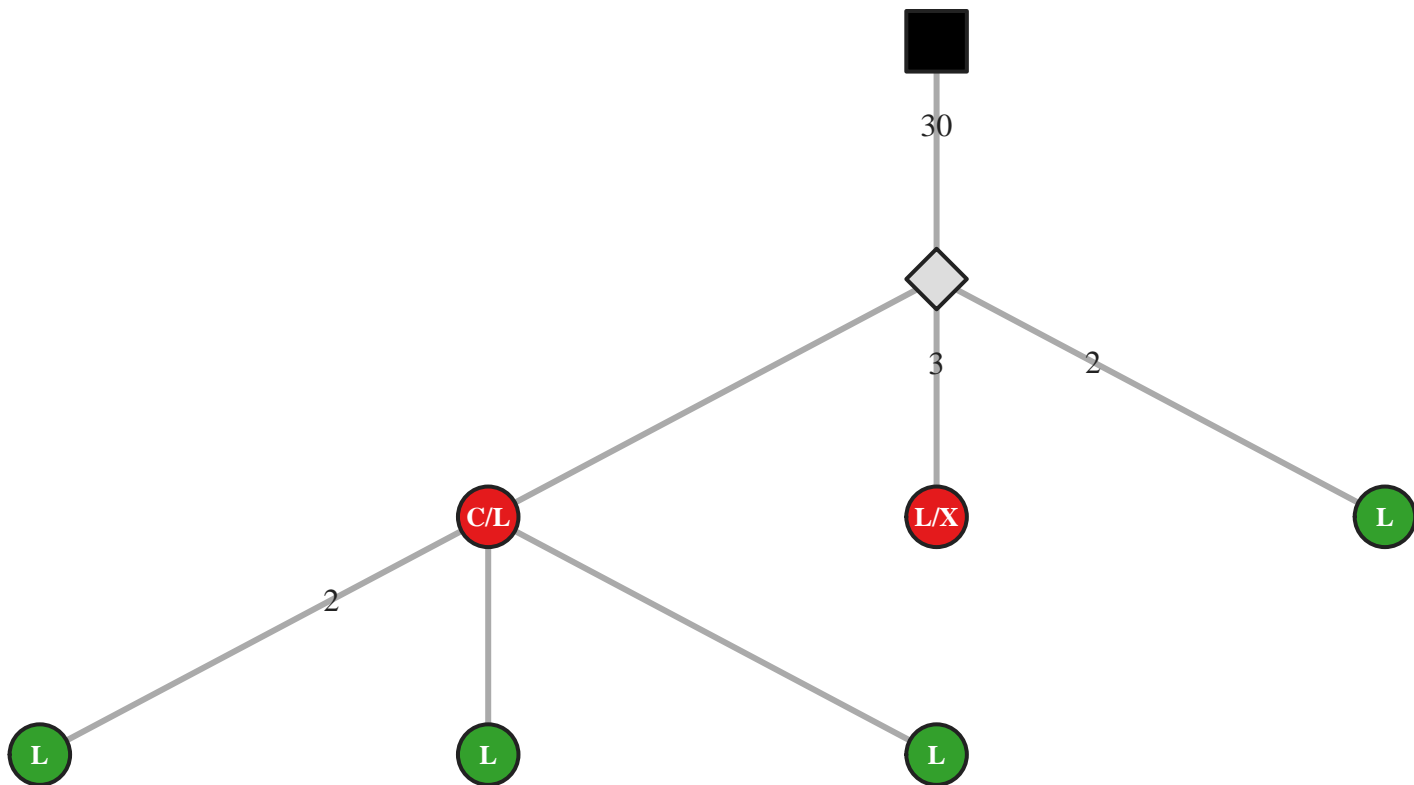

M5 IgG IGHV1-3/J4 57bp (14158)

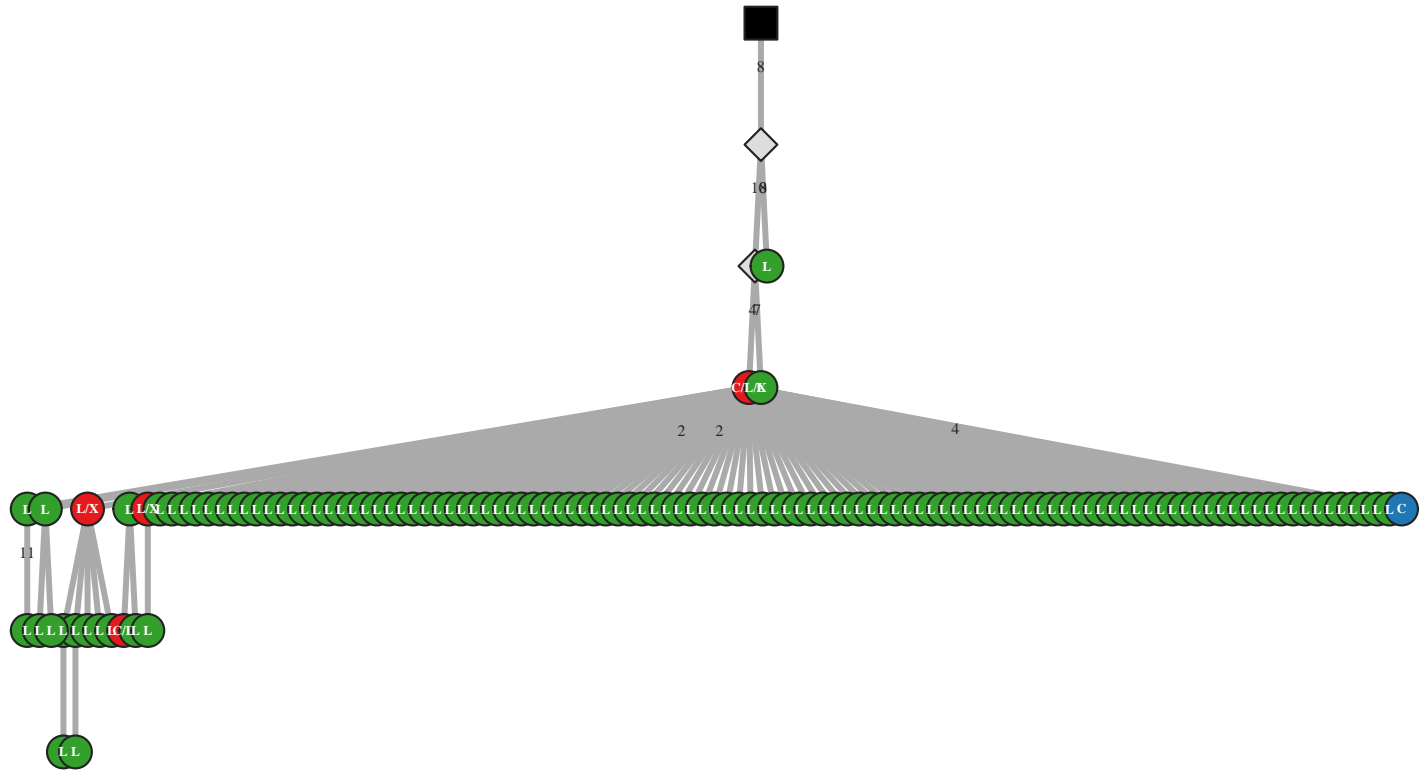

M5 IgG IGHV1-3/J5 42bp (32123)

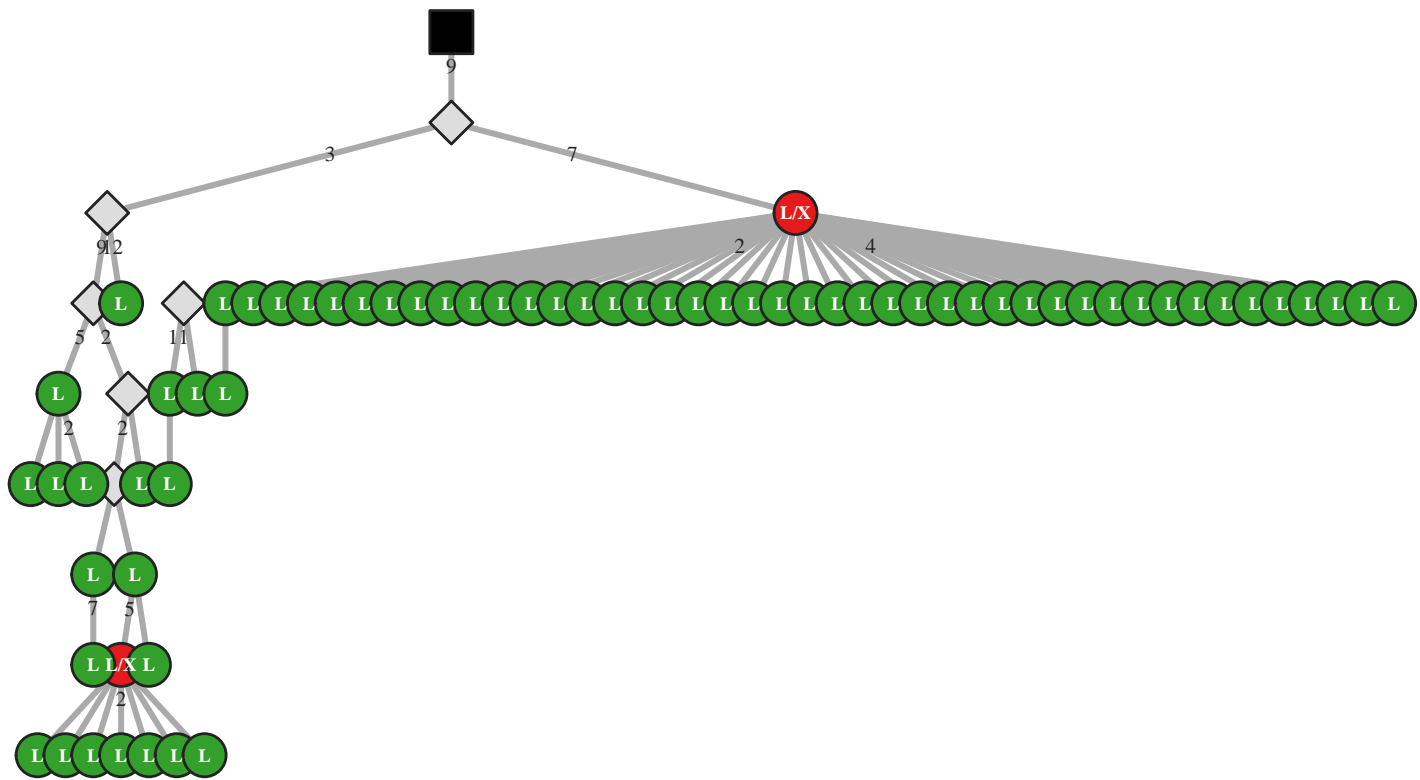

M5 IgG IGHV1-3/J5 45bp (4575)

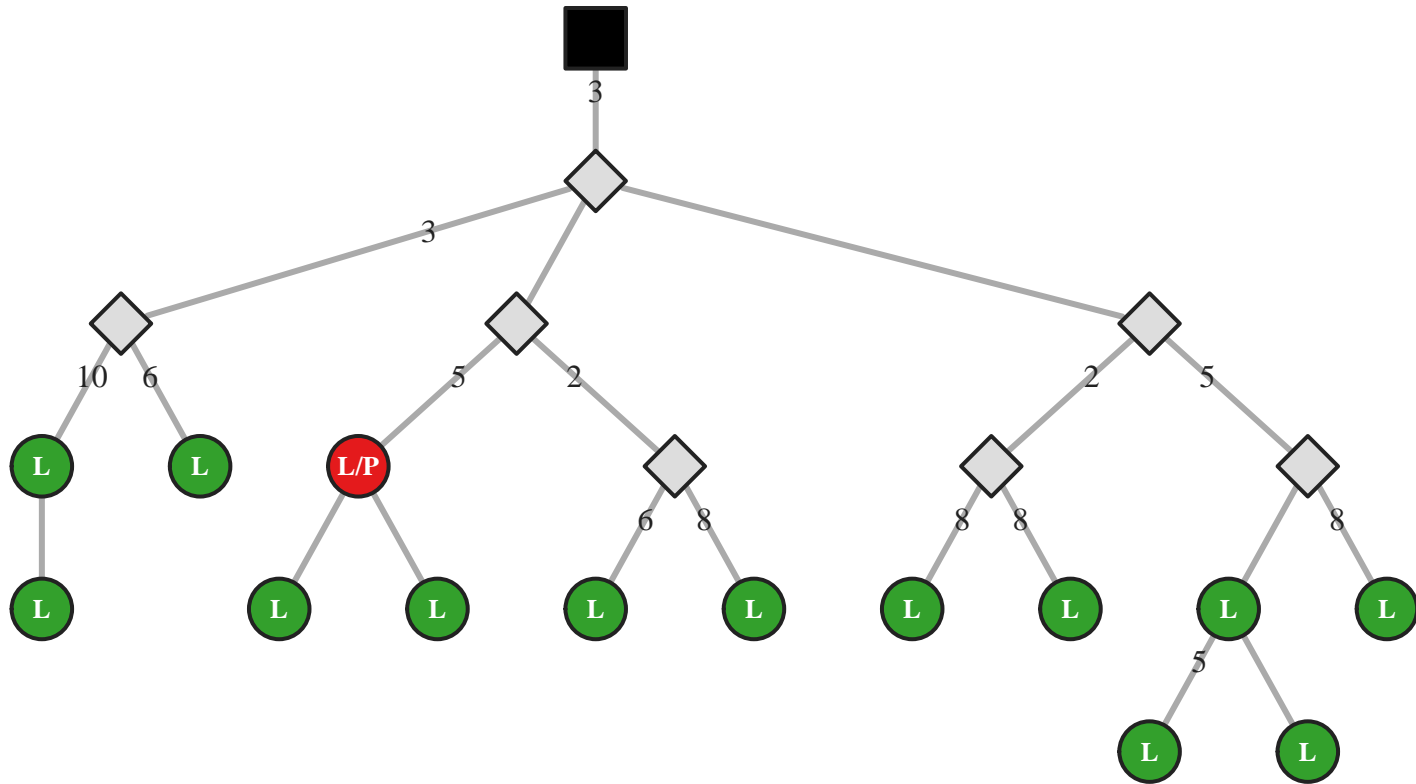

M5 IgG IGHV1-3/J5 54bp (4585)

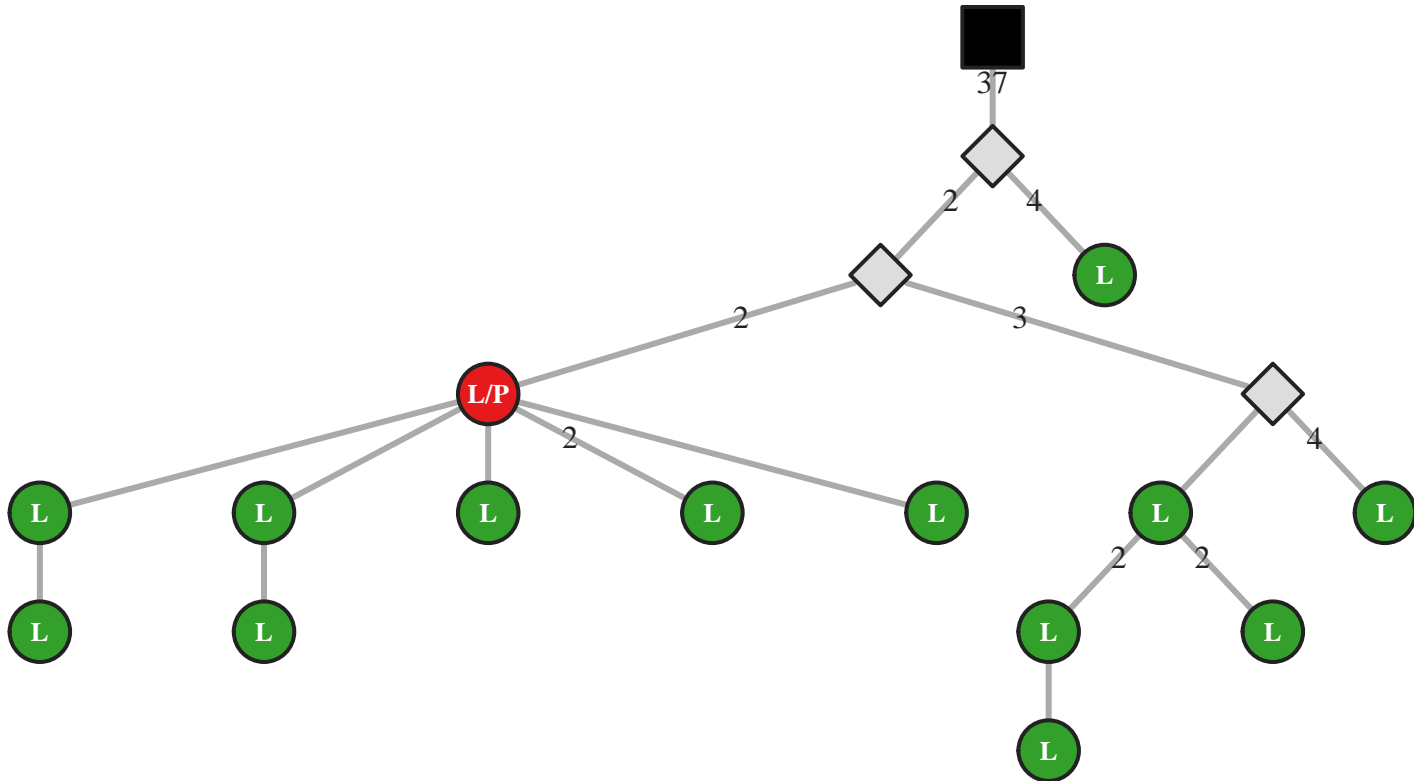

M5 IgG IGHV1-3/J5 60bp (32153)

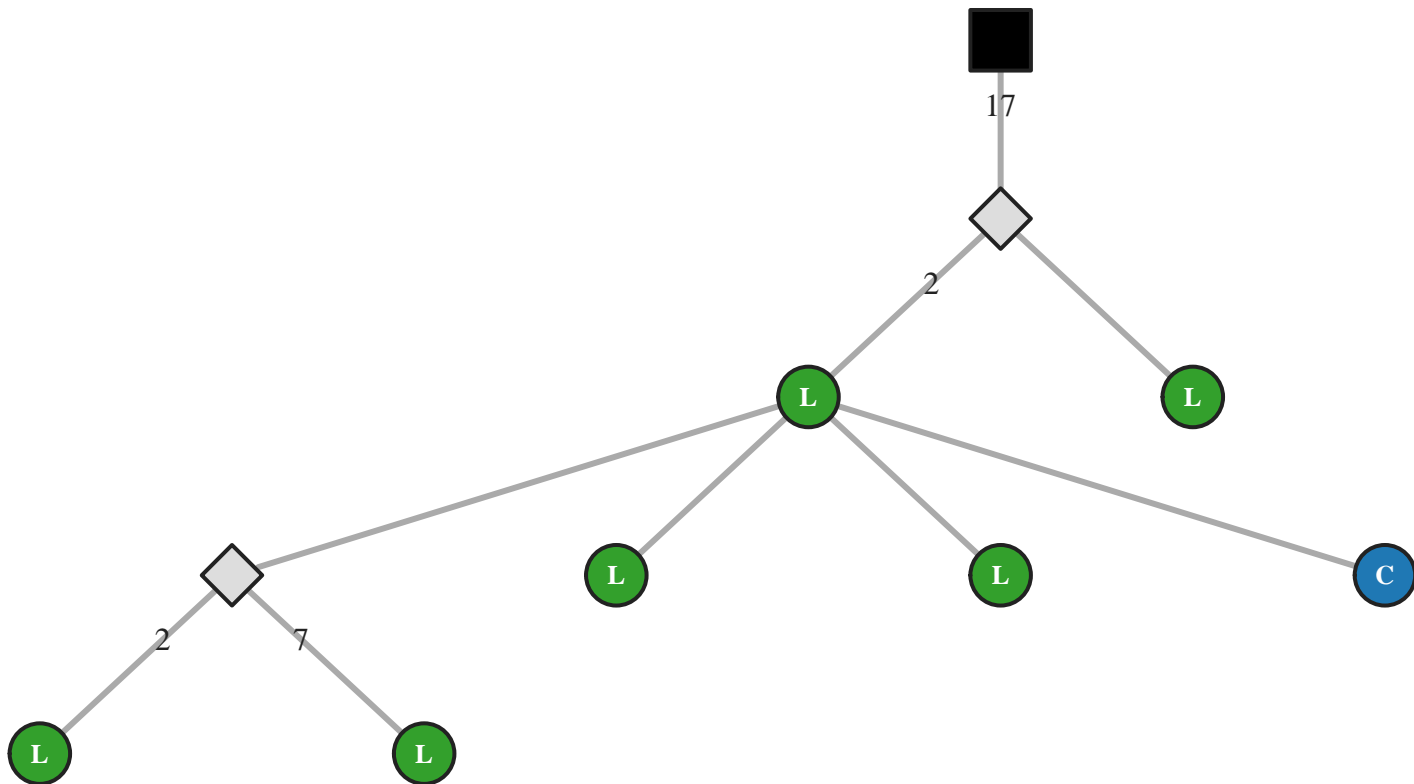

M5 IgG IGHV1-3/J6 51bp (23483)

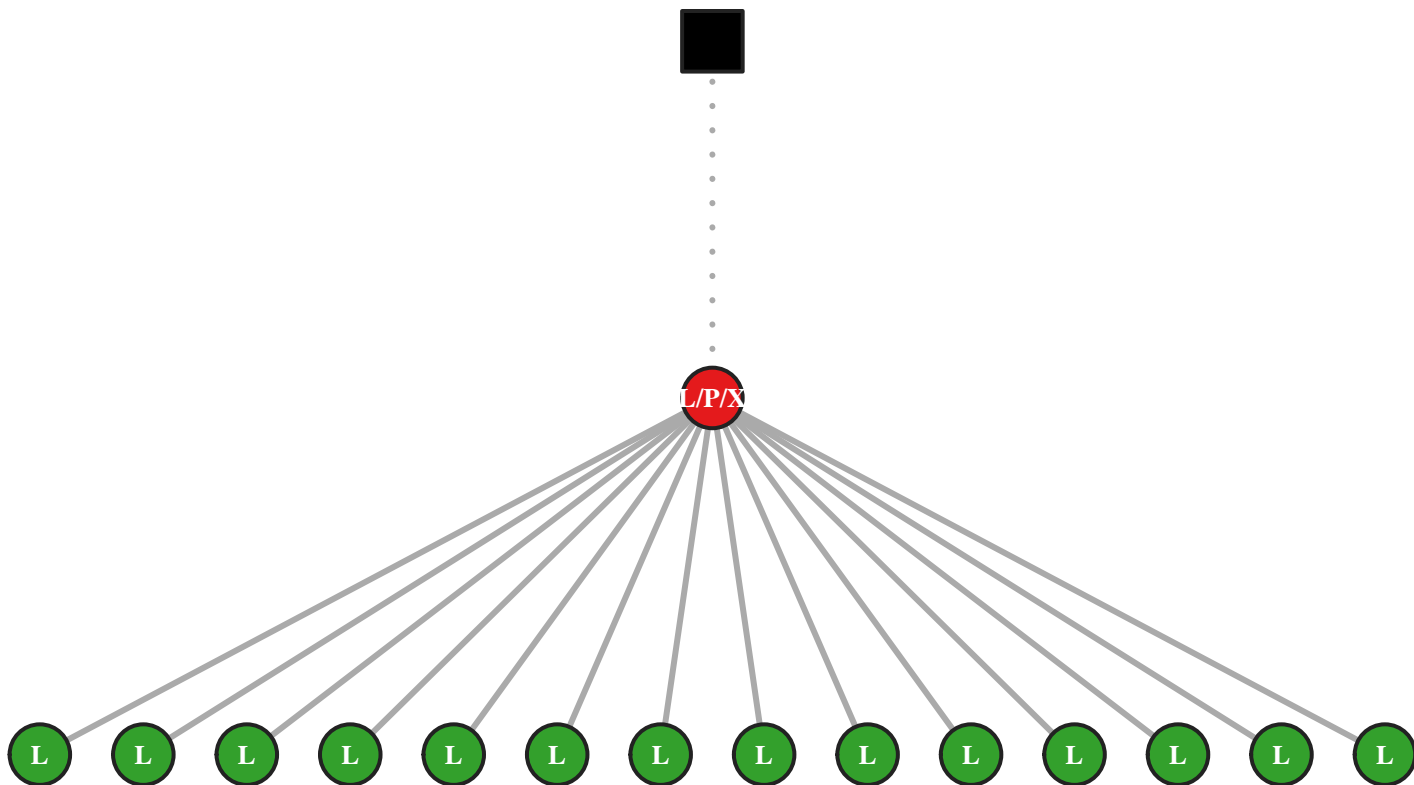

M5 IgG IGHV1-3/J6 57bp (14181)

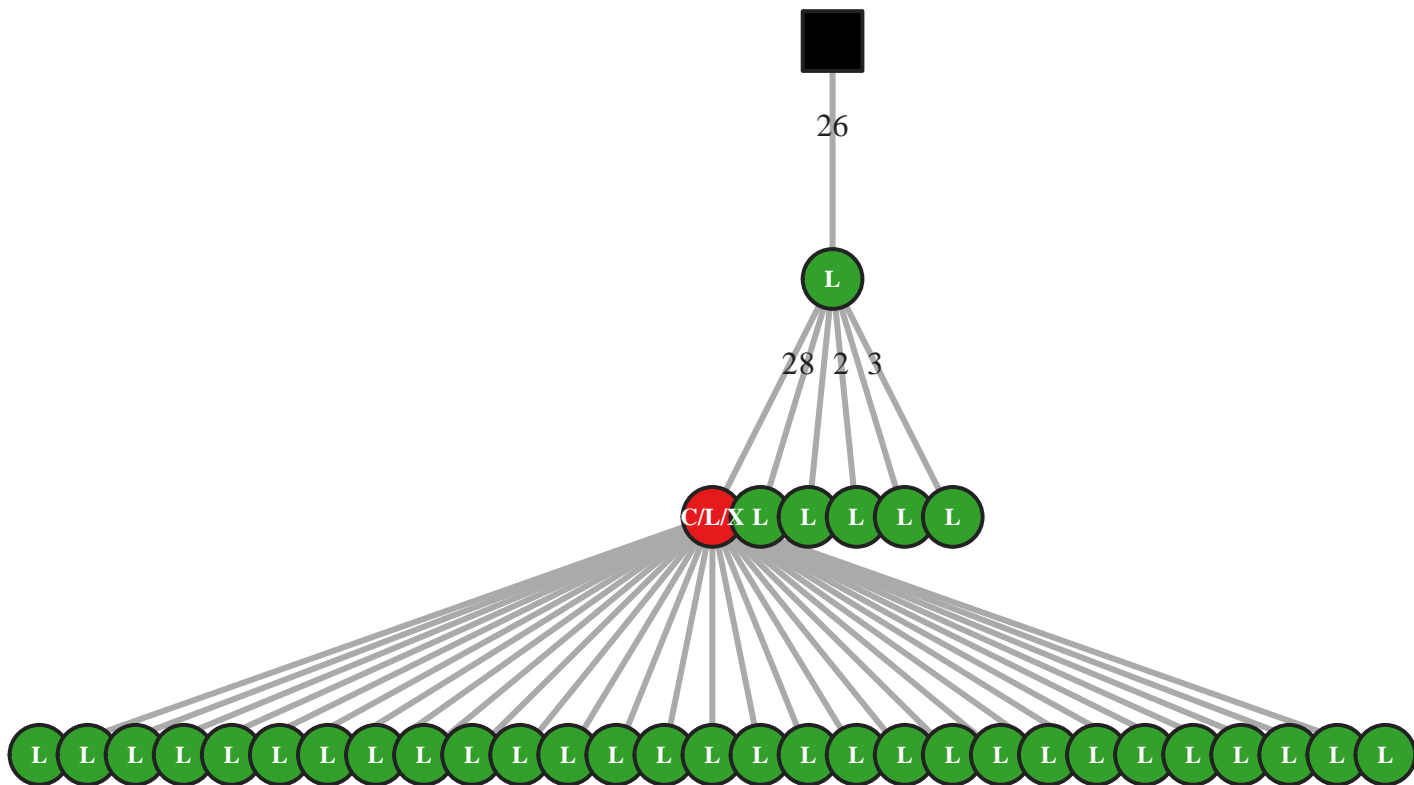

M5 IgG IGHV1-3/J6 57bp (14187)

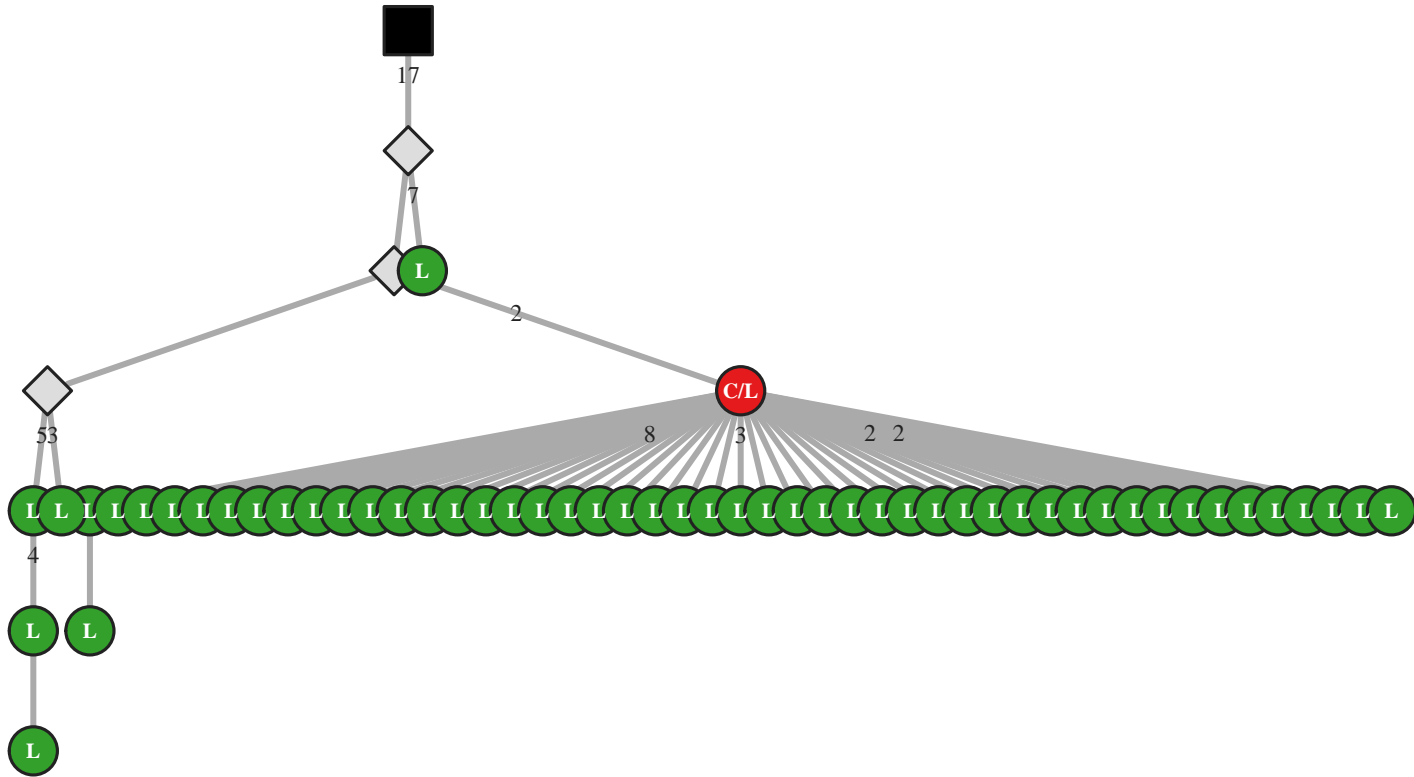

M5 IgG IGHV1-3/J6 57bp (14194)

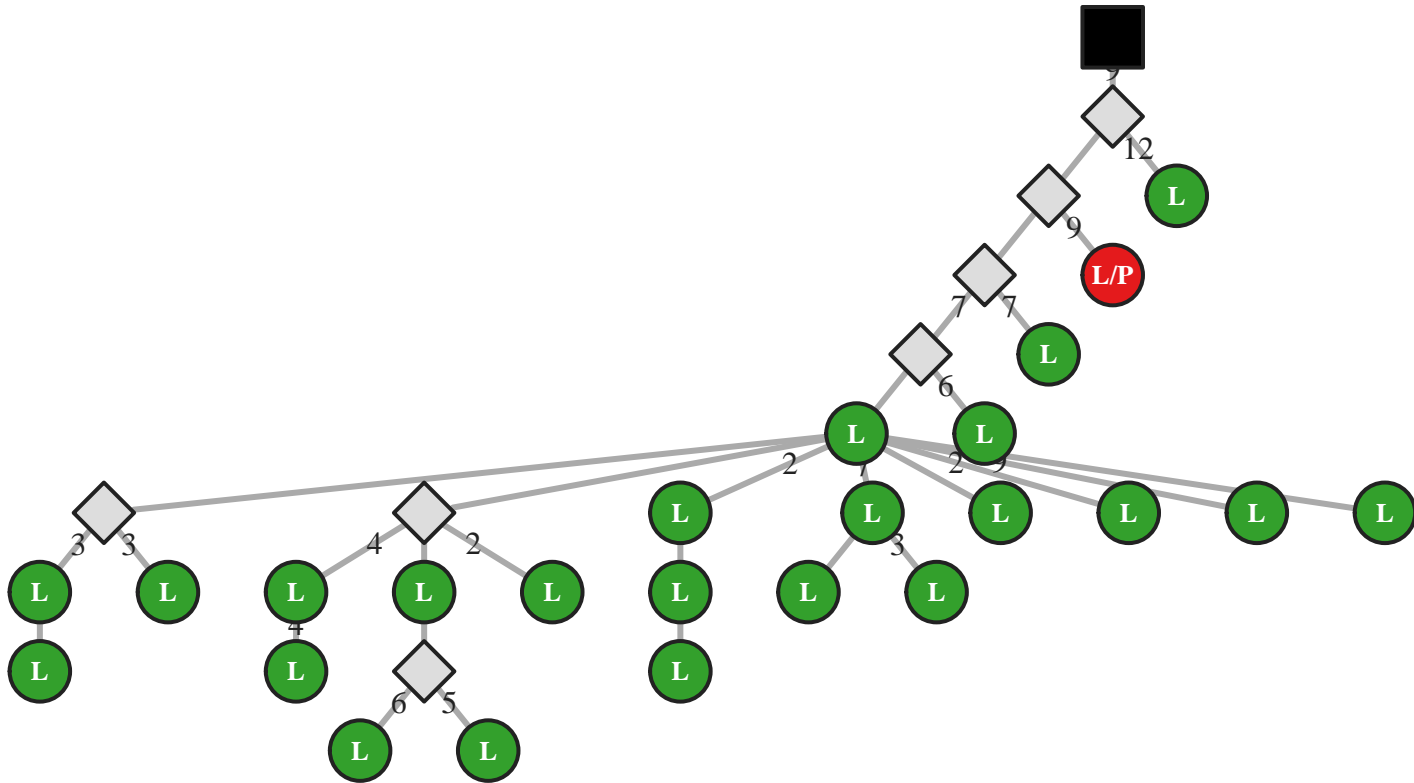

M5 IgG IGHV1-46/J3 45bp (49896)

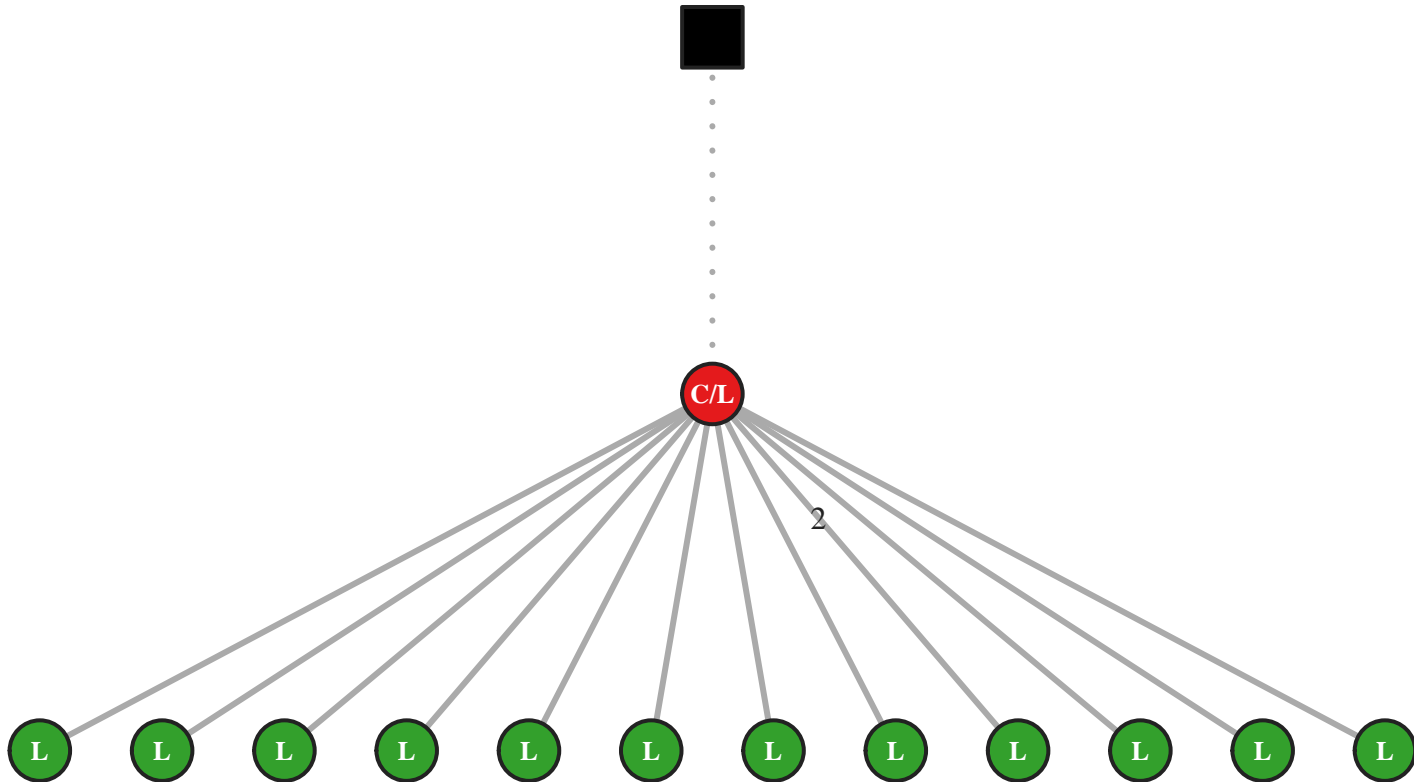

M5 IgG IGHV1-46/J3 51bp (49914)

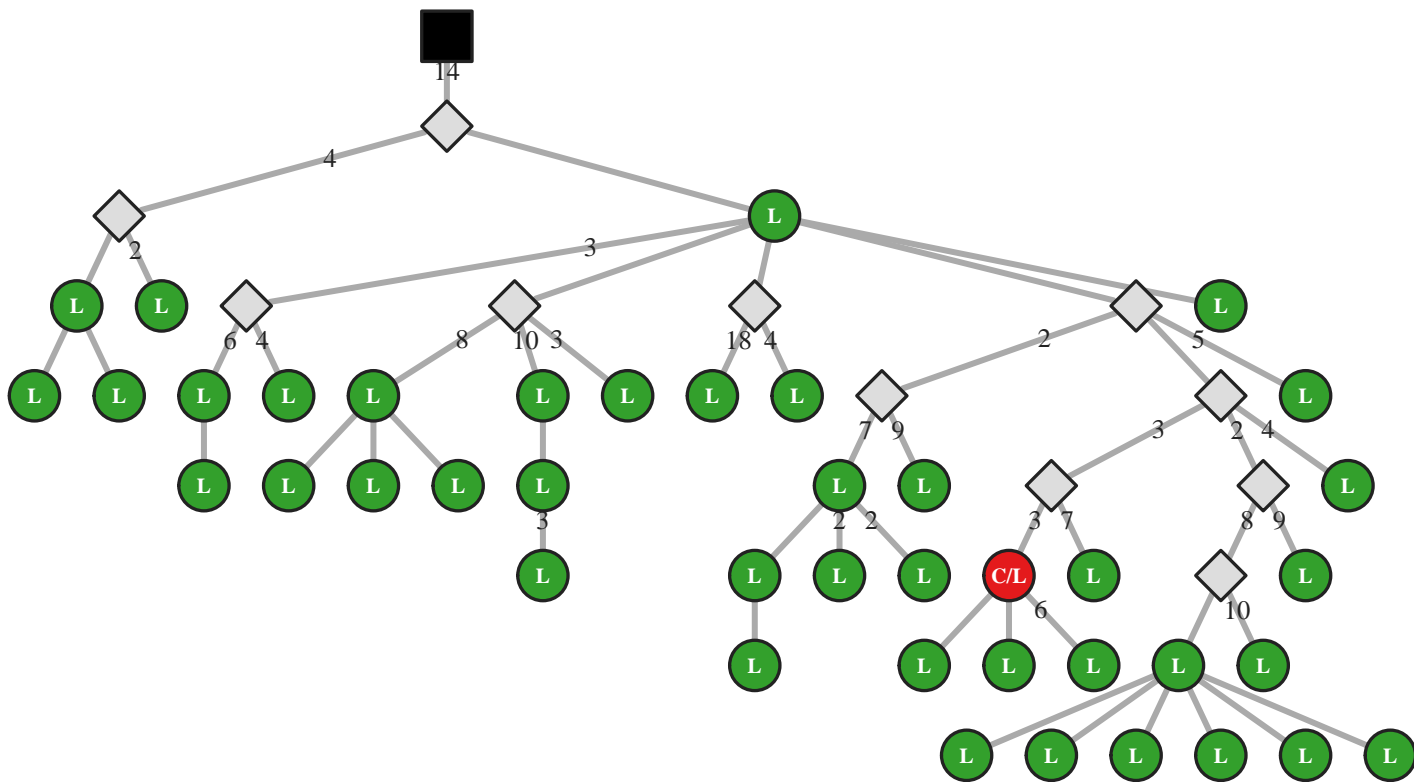

M5 IgA IGHV1-46/J3 54bp (2346)

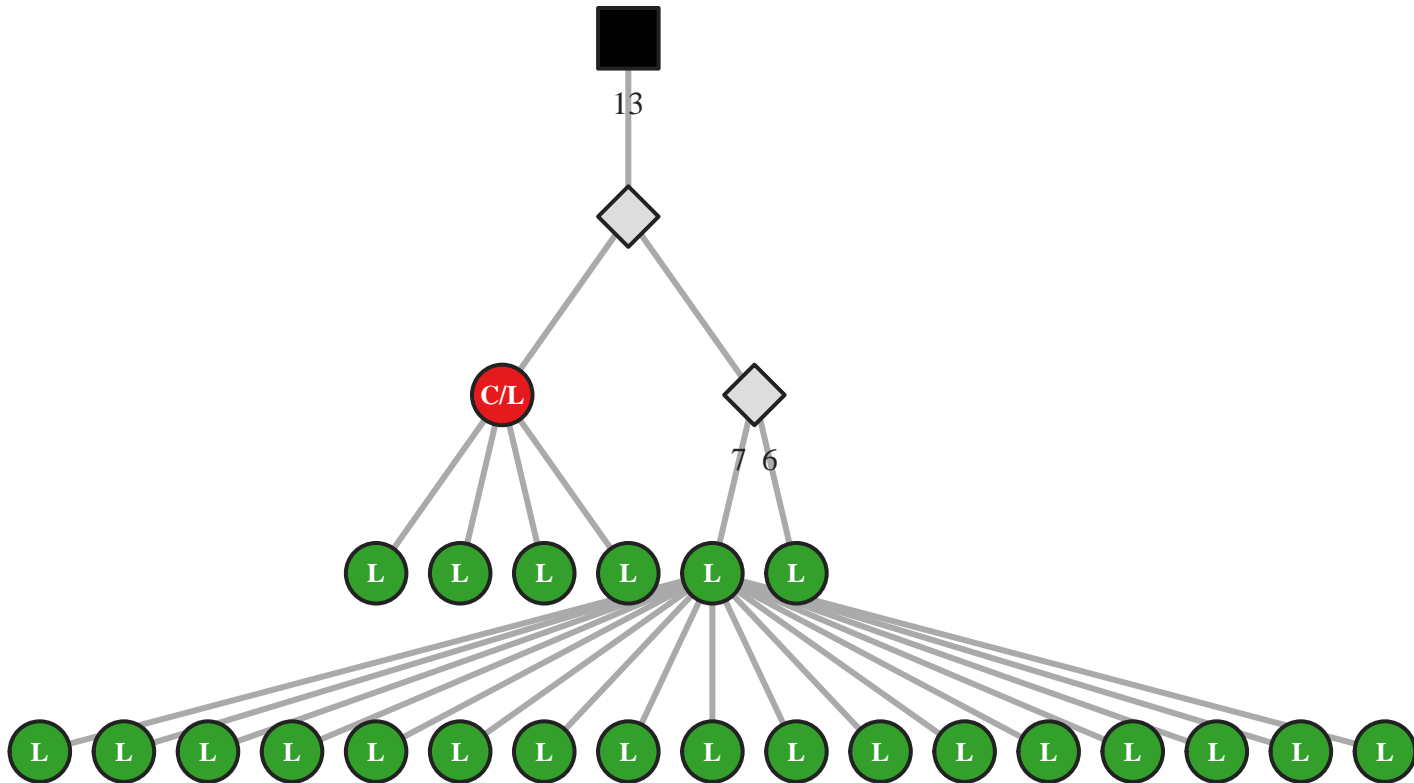

M5 IgG IGHV1-46/J4 30bp (23016)

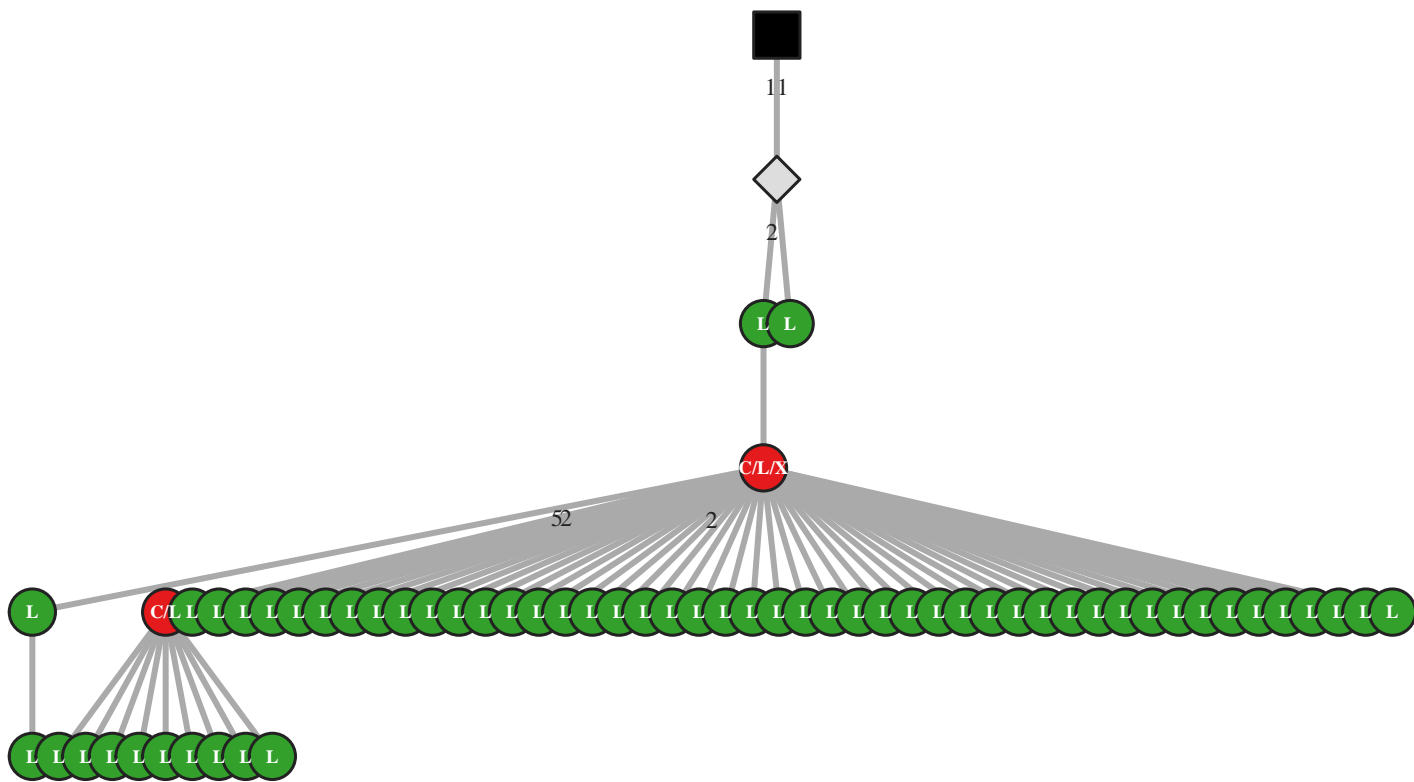

M5 IgG IGHV1-46/J4 30bp (23027)

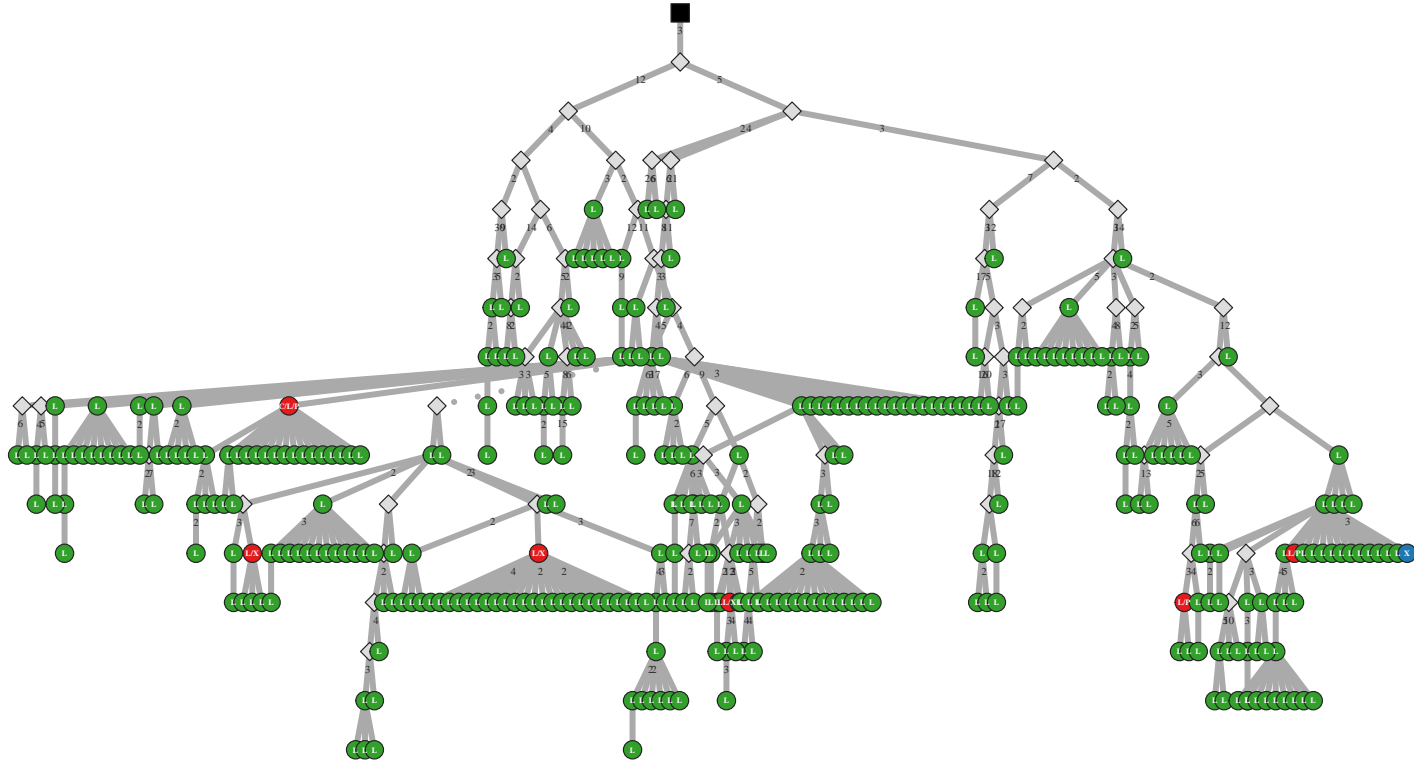

M5 IgG IGHV1-46/J4 36bp (40450)

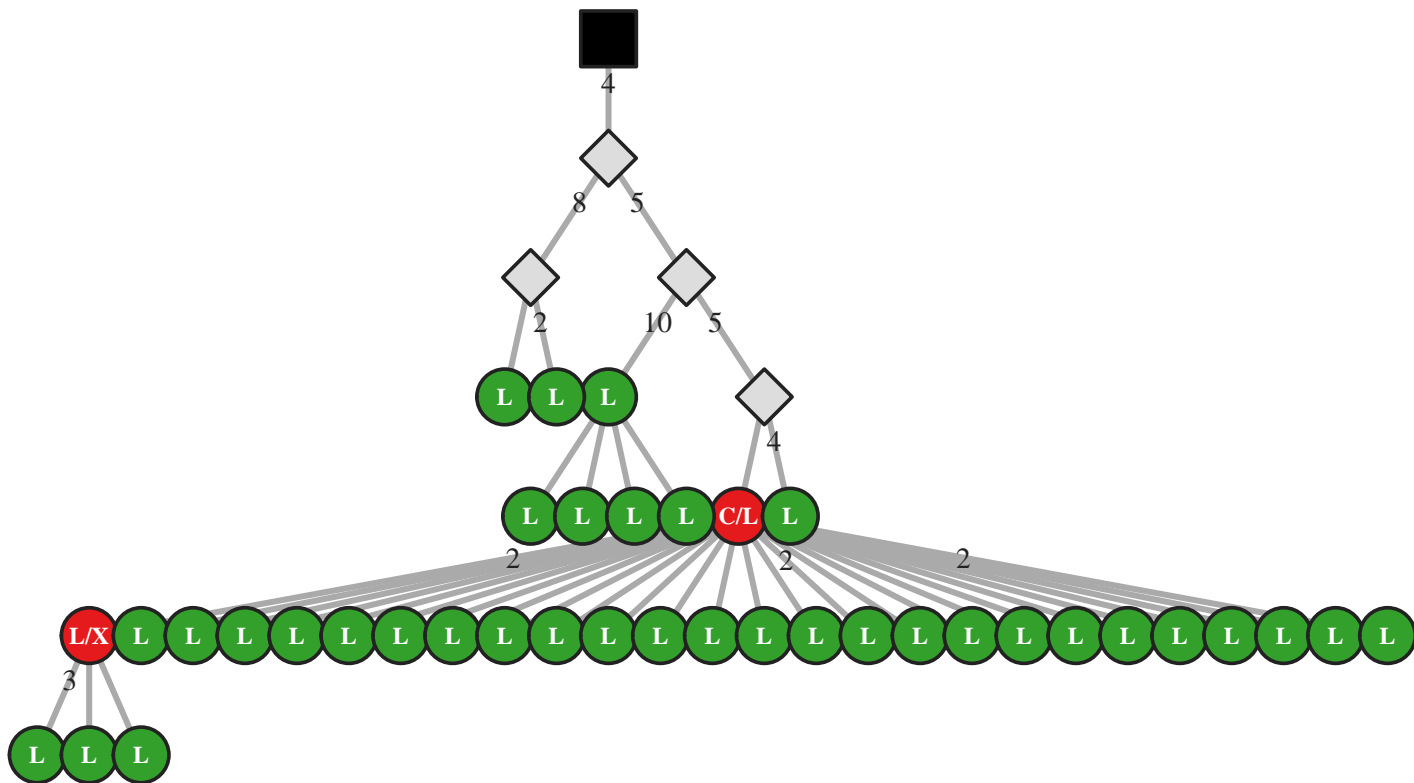

M5 IgG IGHV1-46/J4 39bp (32257)

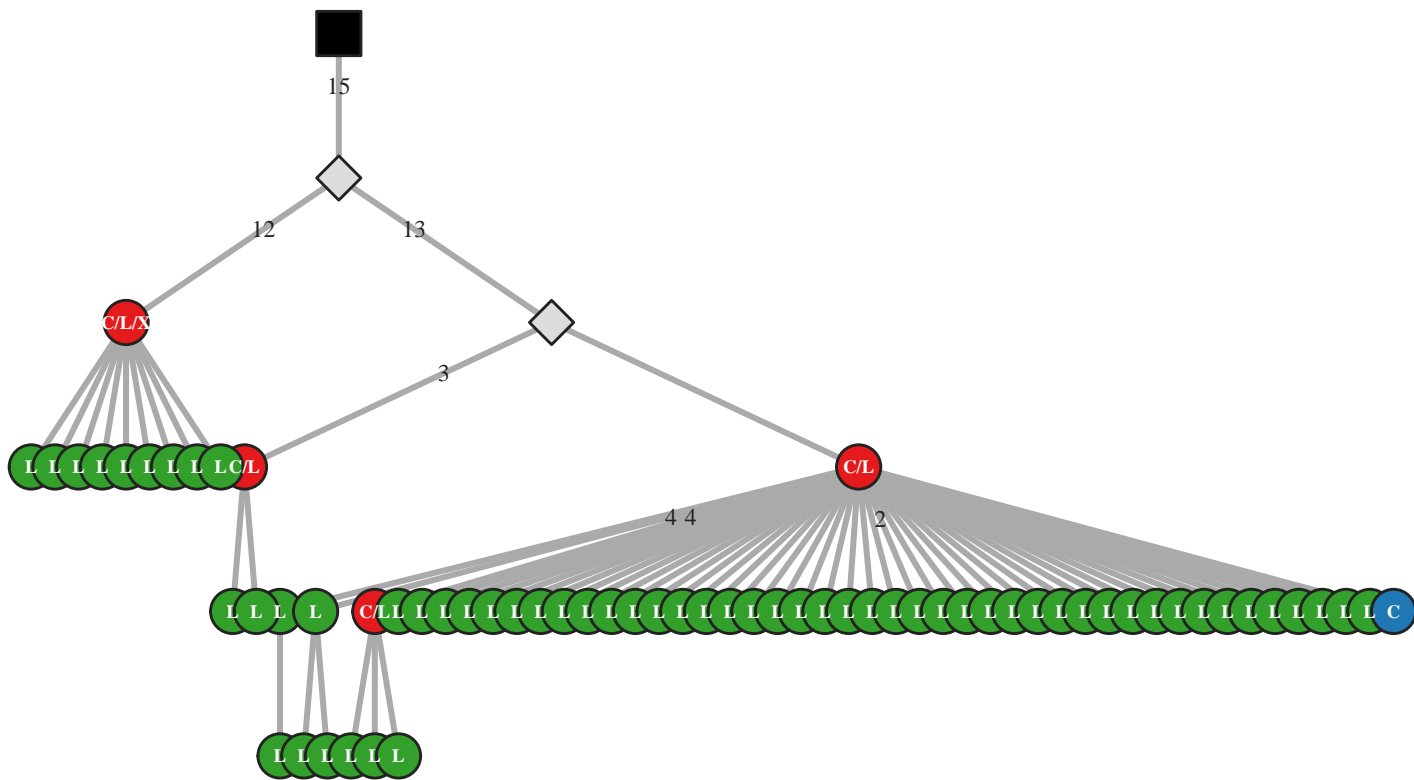

M5 IgG IGHV1-46/J4 39bp (32273)

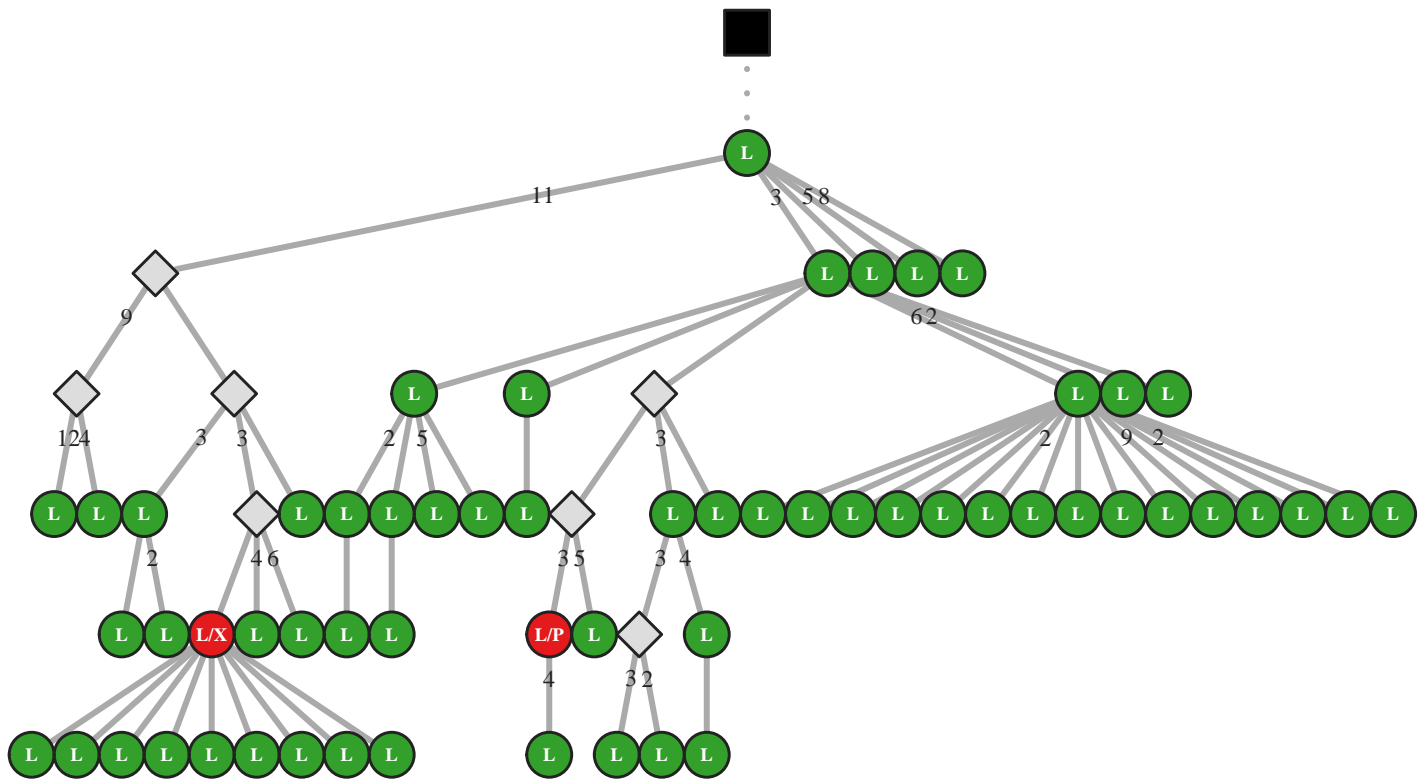

M5 IgG IGHV1-46/J4 39bp (32283)

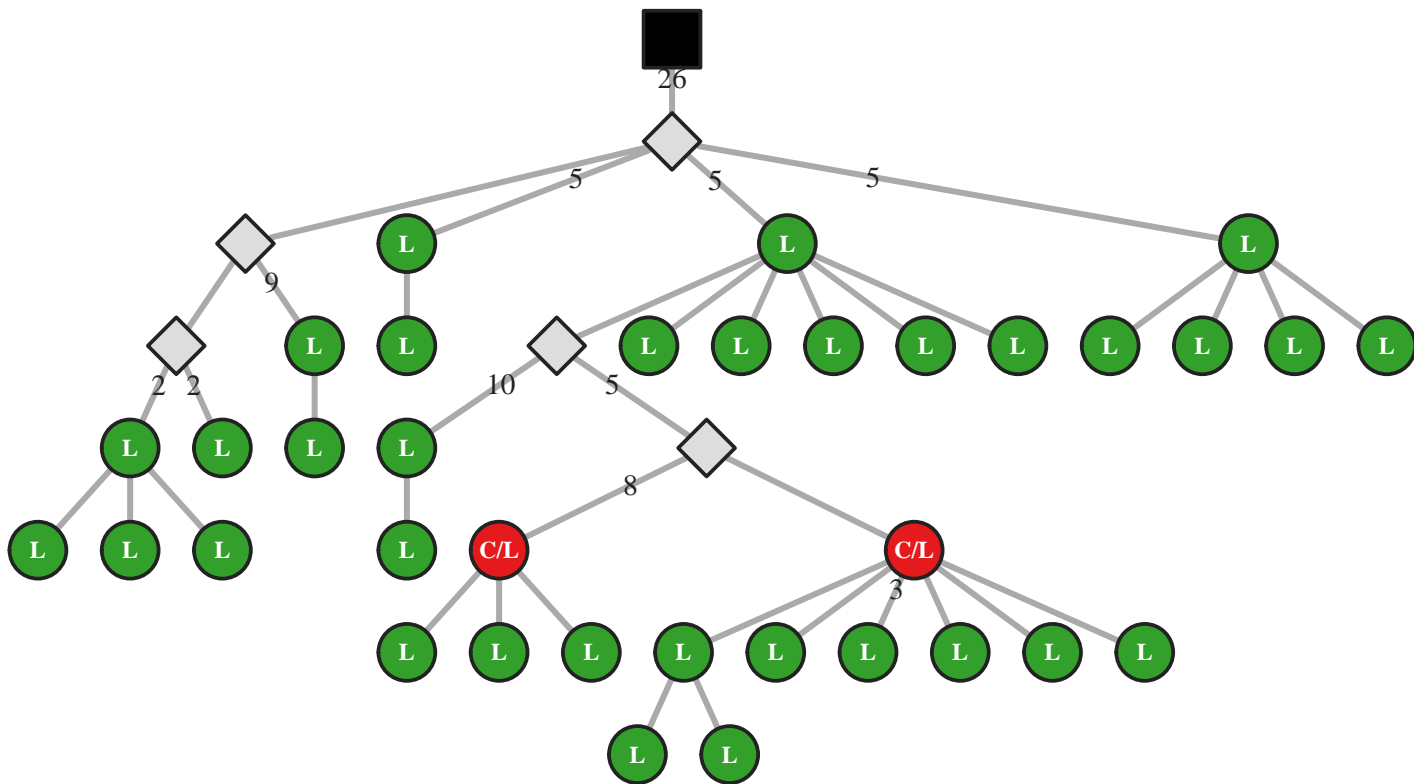

M5 IgG IGHV1-46/J4 39bp (32306)

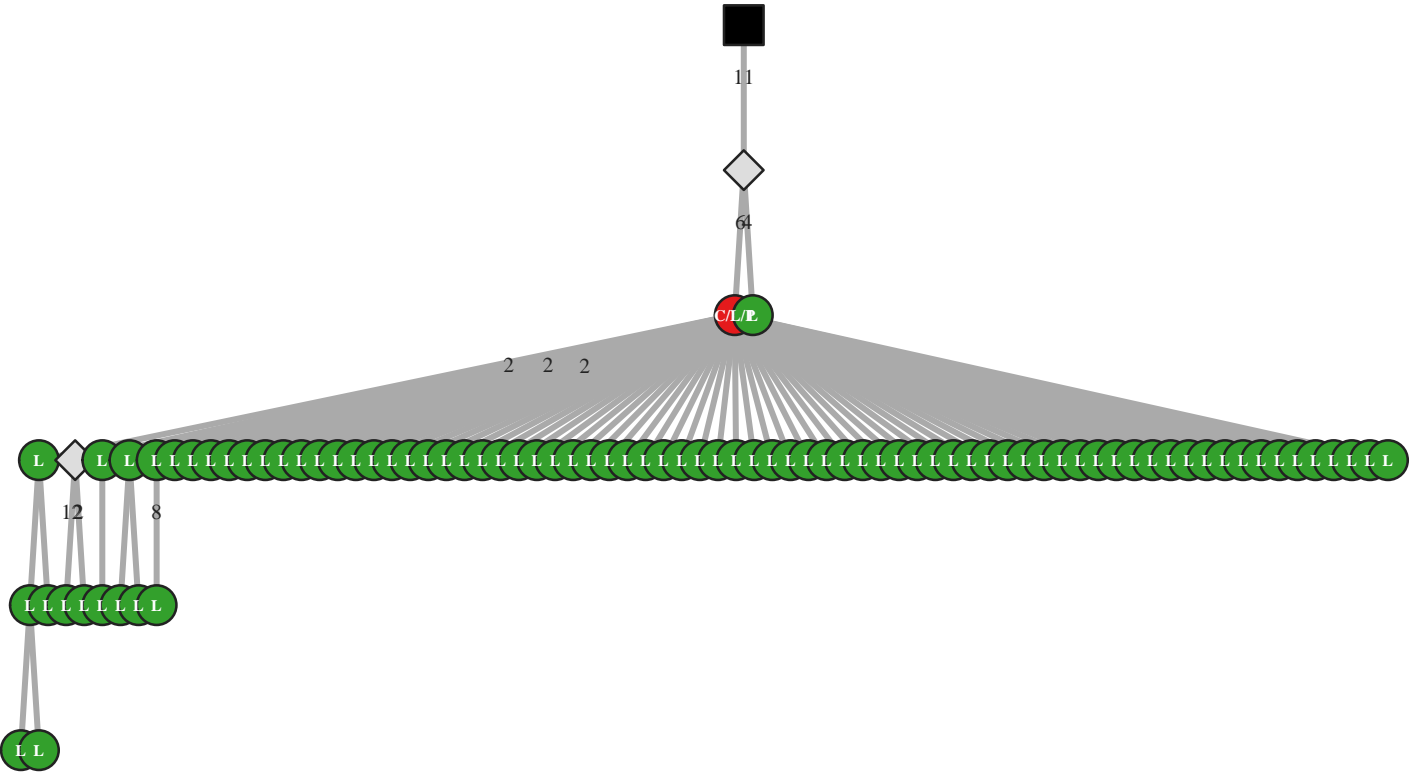

M5 IgM IGHV1-46/J4 39bp (37423)

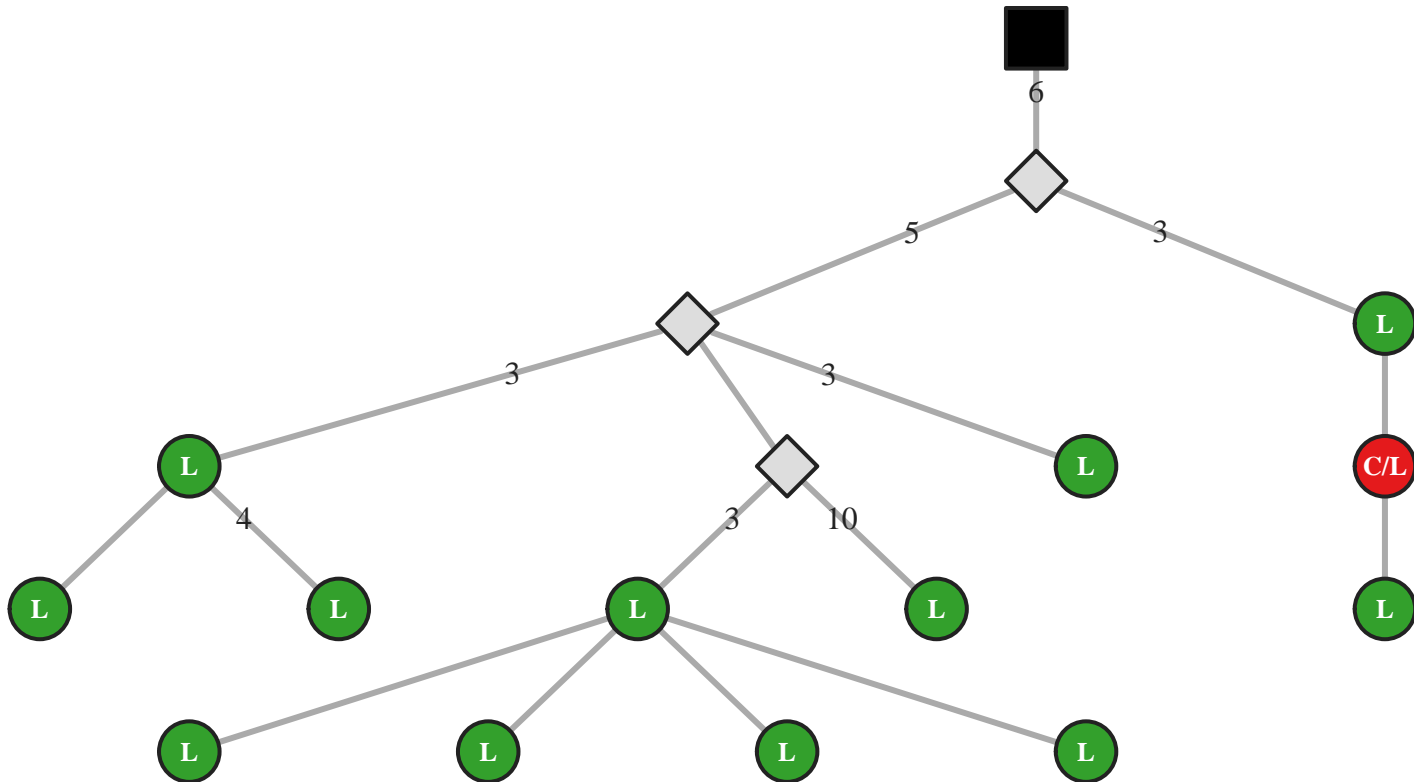

M5 IgG IGHV1-46/J4 42bp (40502)

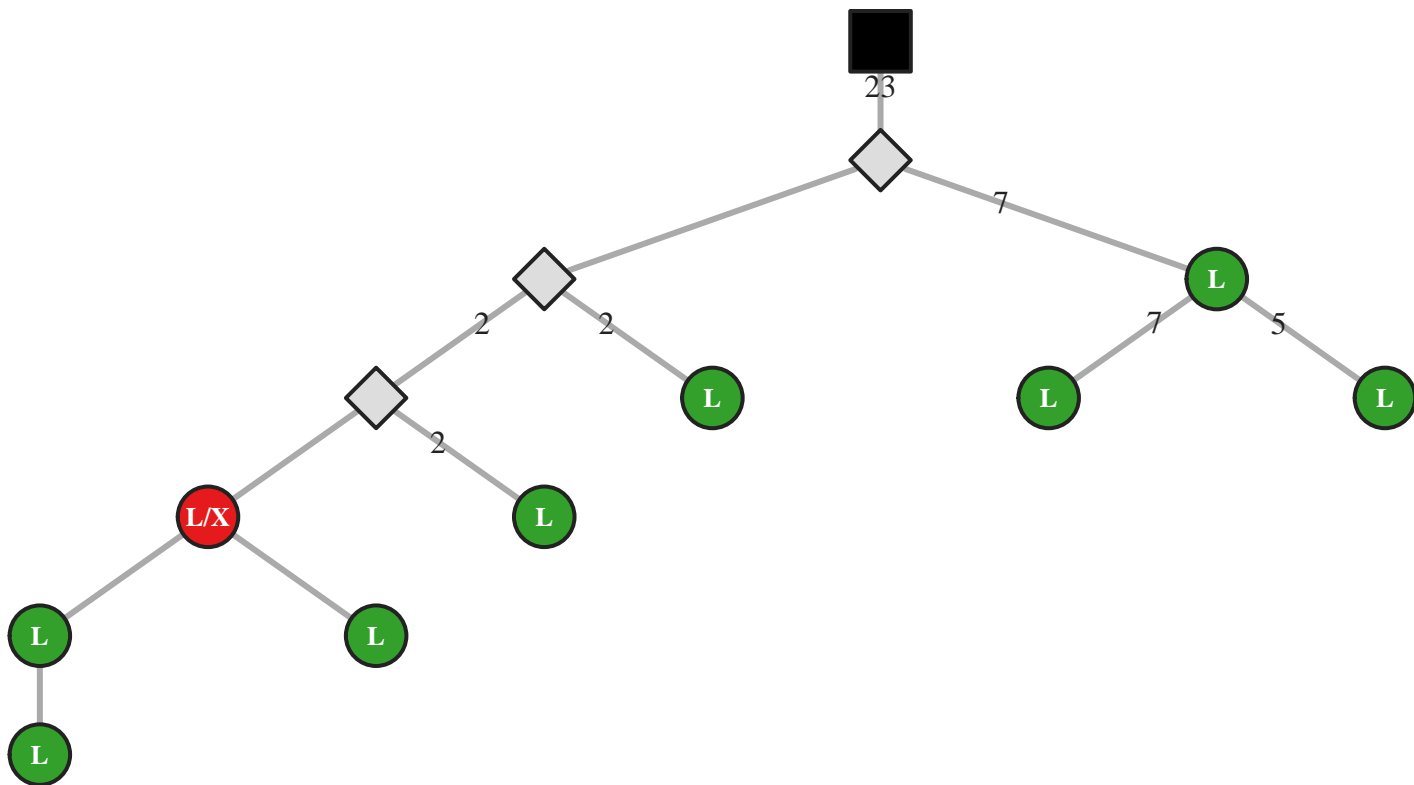

M5 IgG IGHV1-46/J4 42bp (40515)

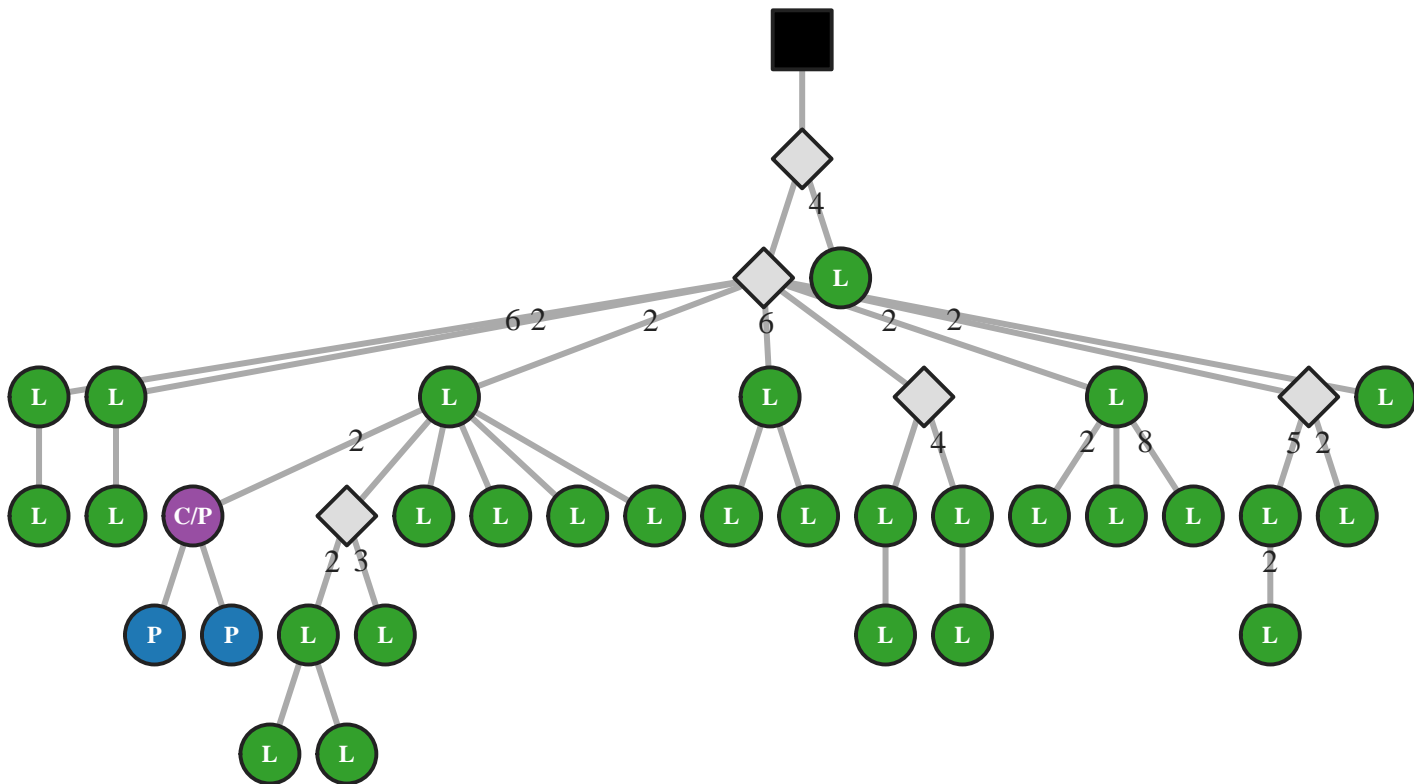

M5 IgG IGHV1-46/J4 42bp (40516)

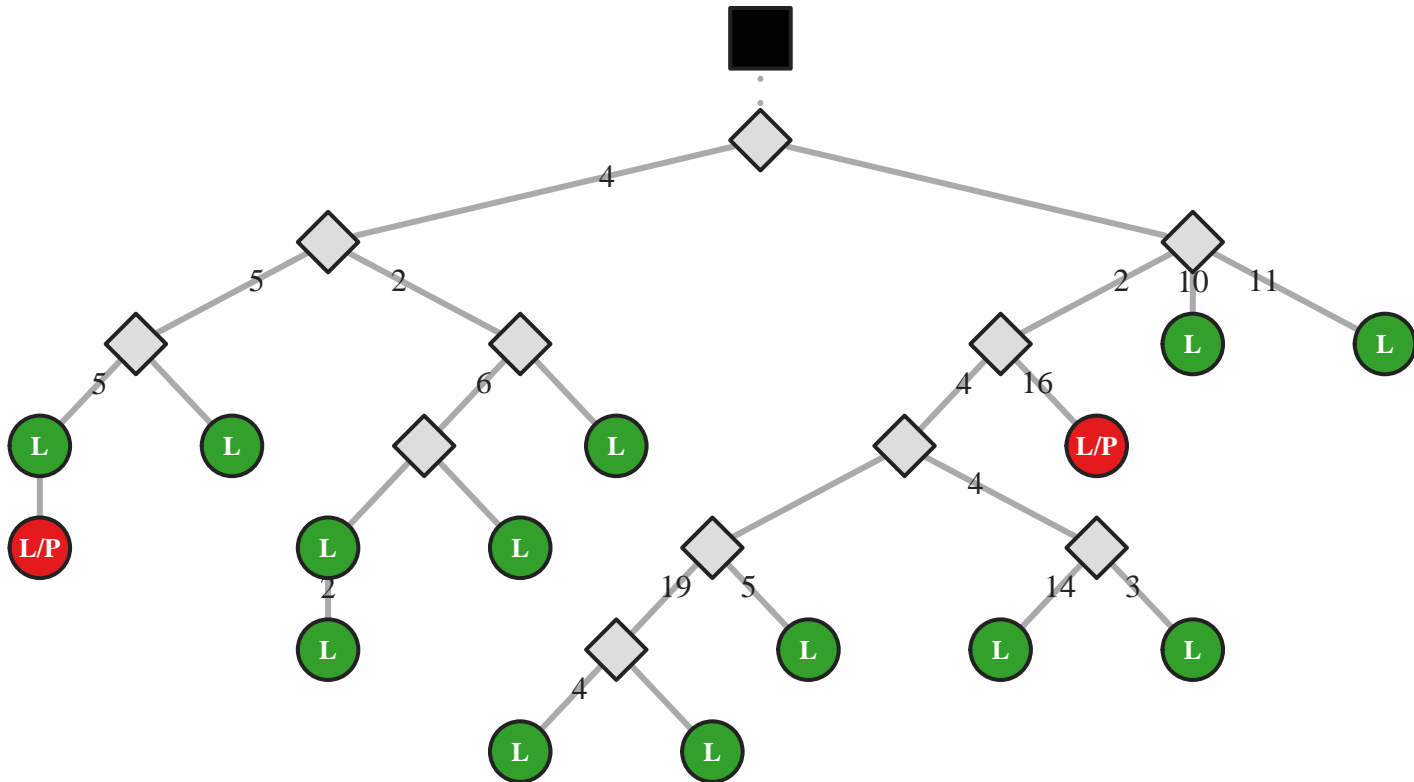

M5 IgG IGHV1-46/J4 42bp (40530)

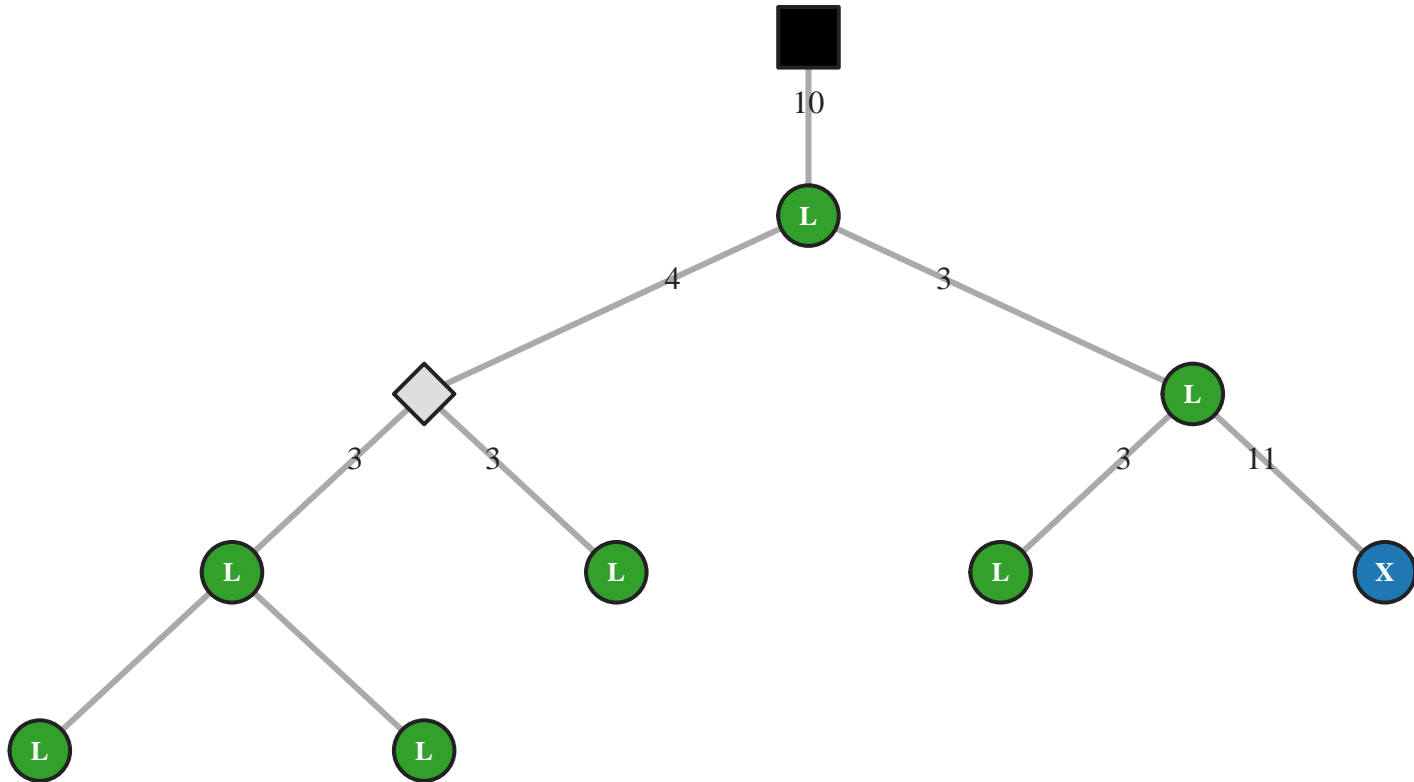

M5 IgG IGHV1-46/J4 42bp (40531)

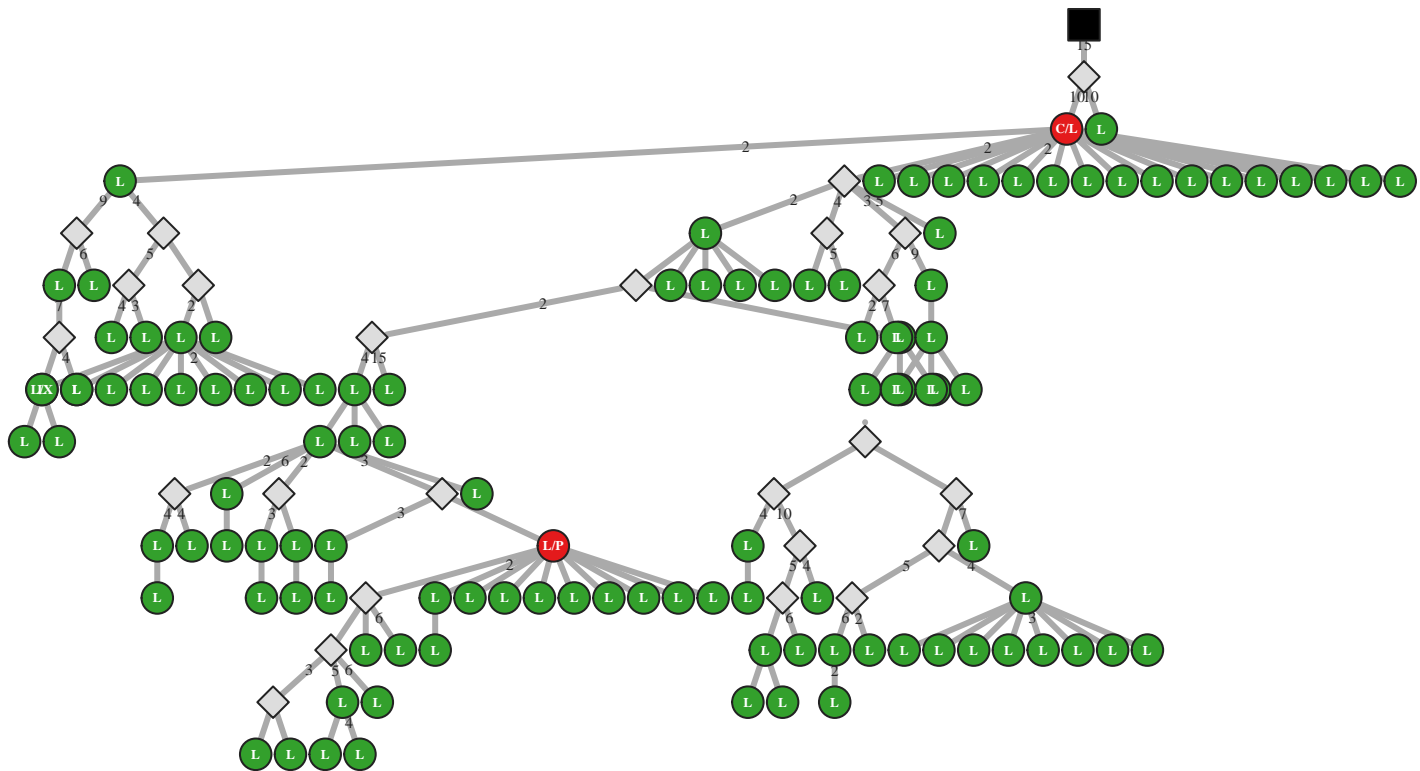

M5 IgG IGHV1-46/J4 42bp (40564)

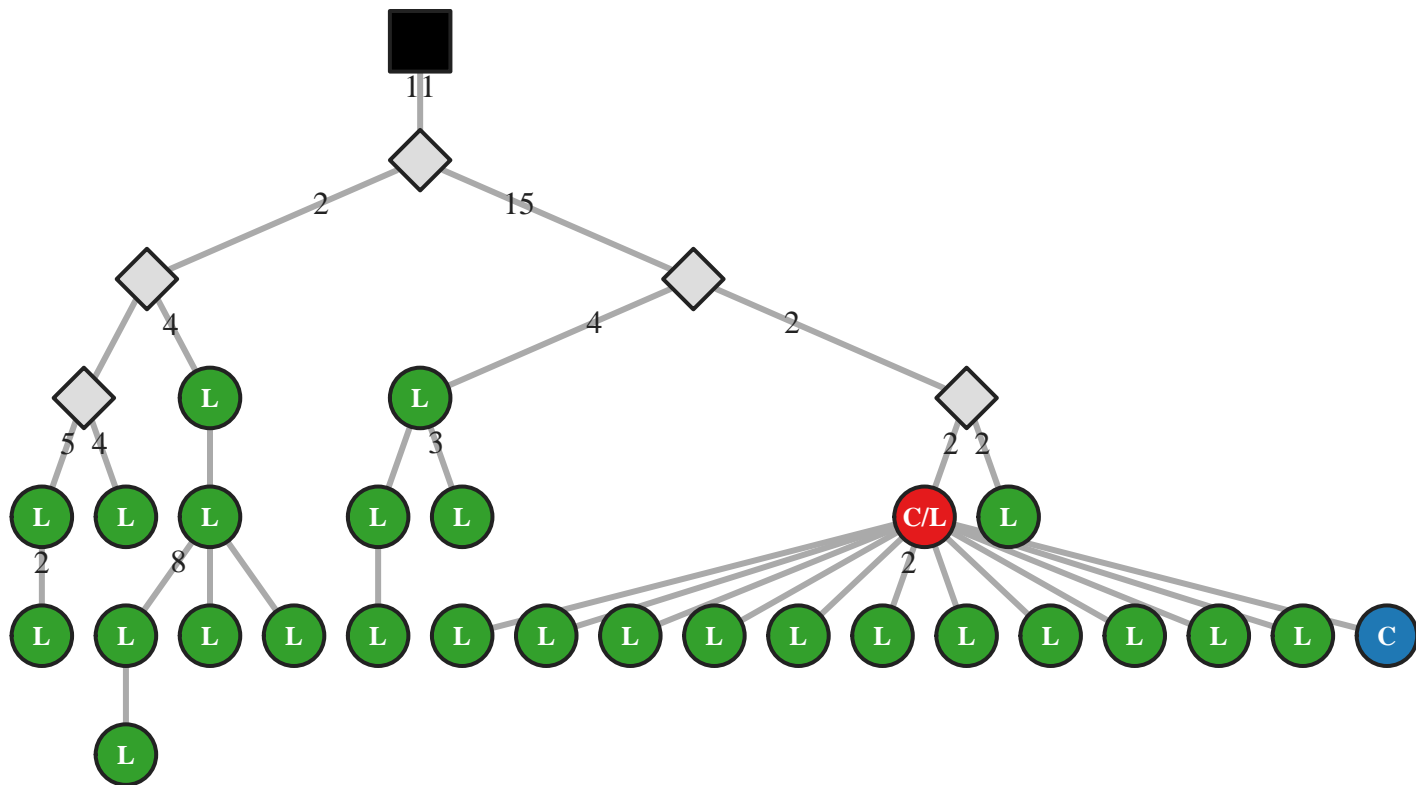

M5 IgG IGHV1-46/J4 45bp (14238)

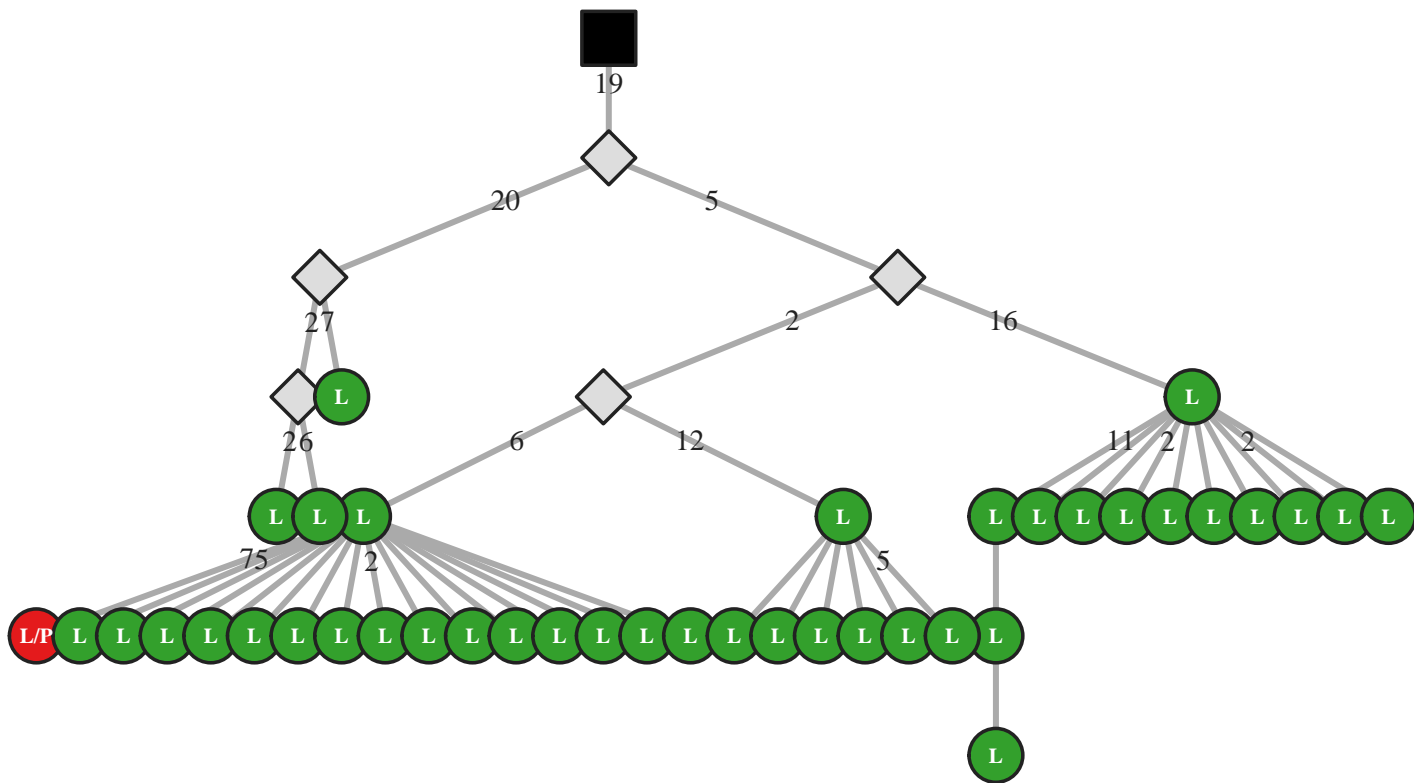

M5 IgG IGHV1-46/J4 45bp (14244)

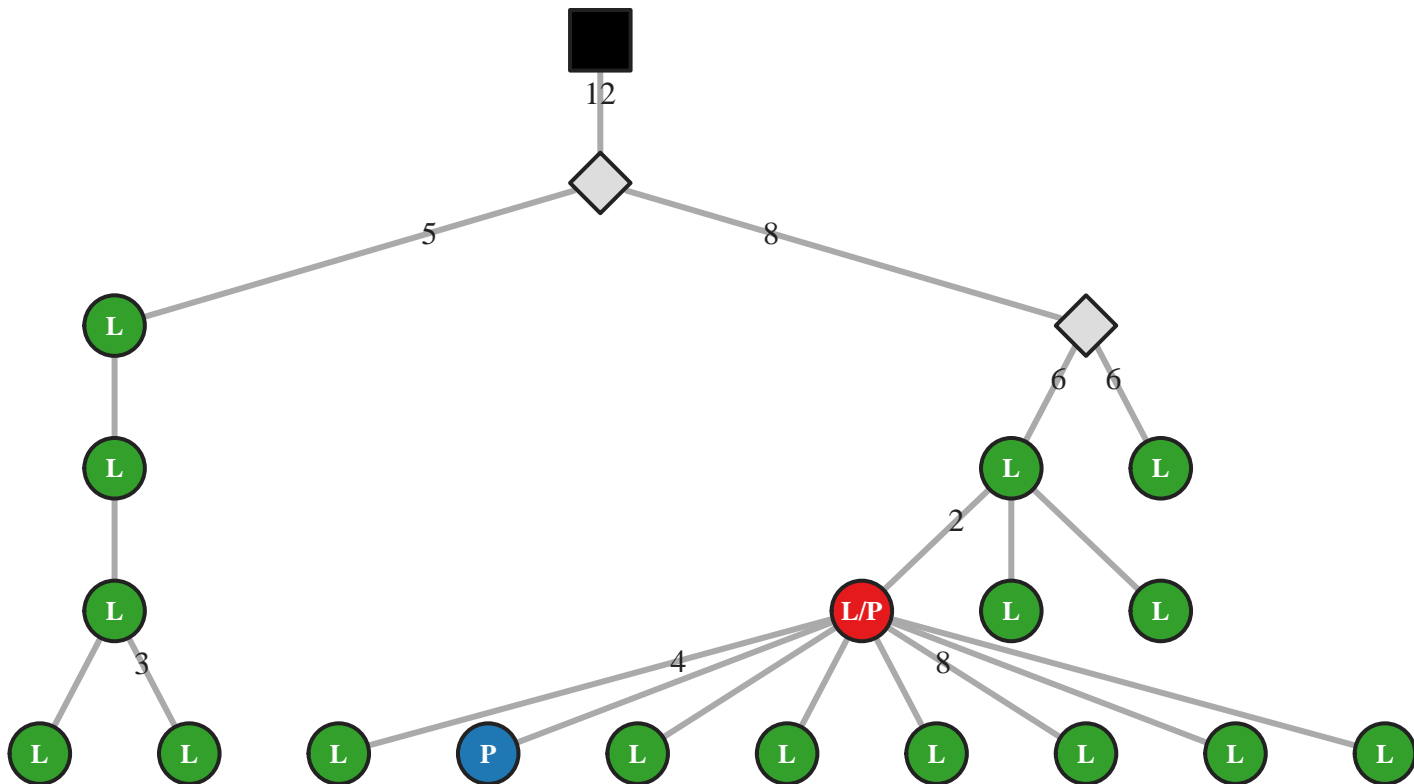

M5 IgG IGHV1-46/J4 45bp (14246)

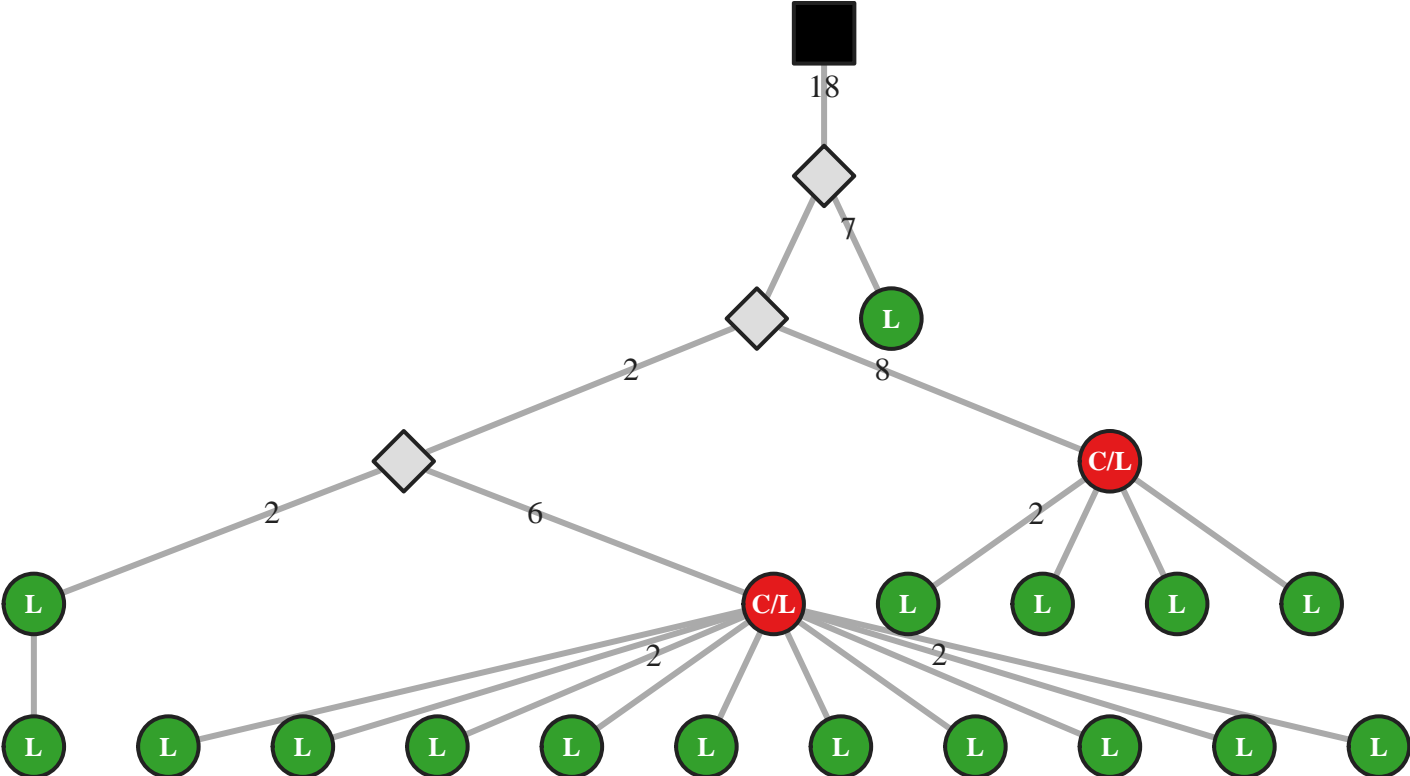

M5 IgG IGHV1-46/J4 45bp (14251)

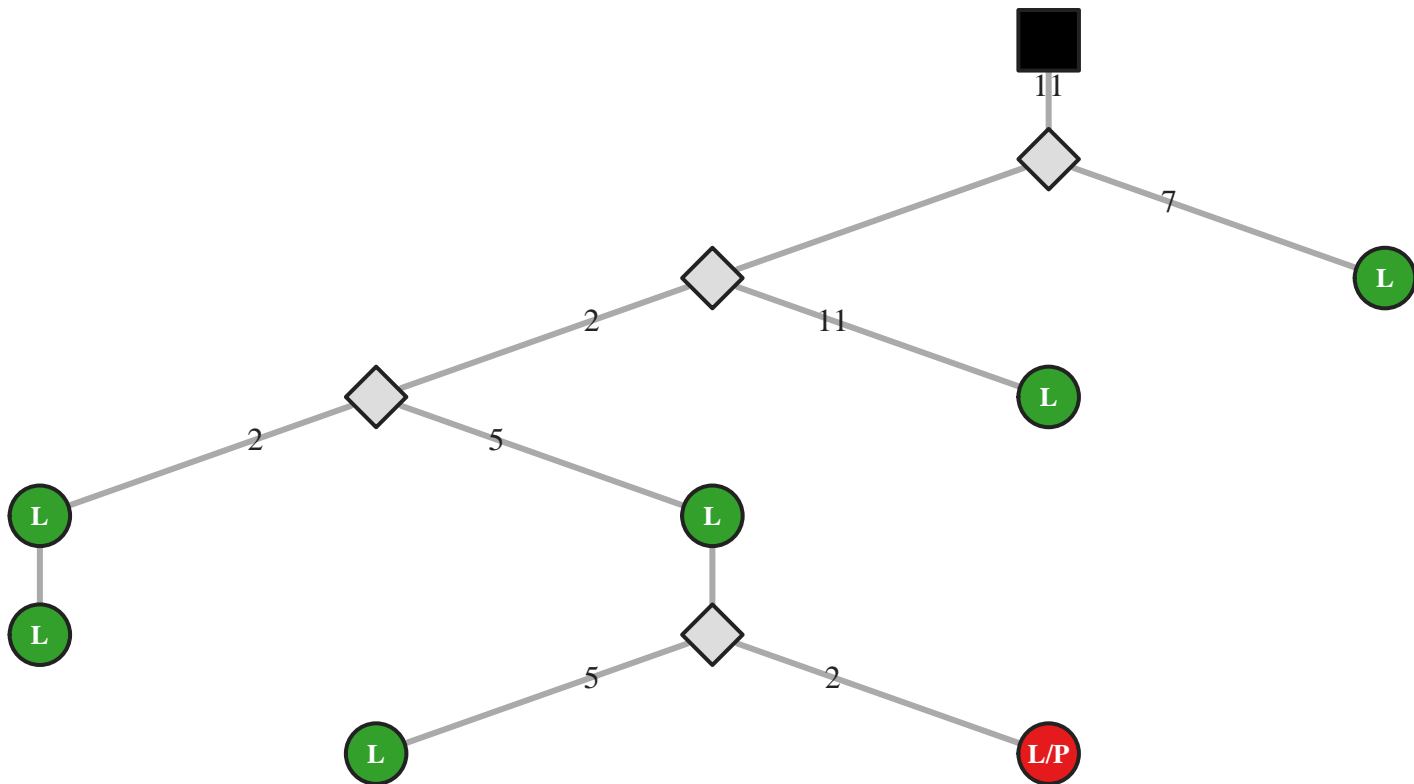

M5 IgG IGHV1-46/J4 45bp (14312)

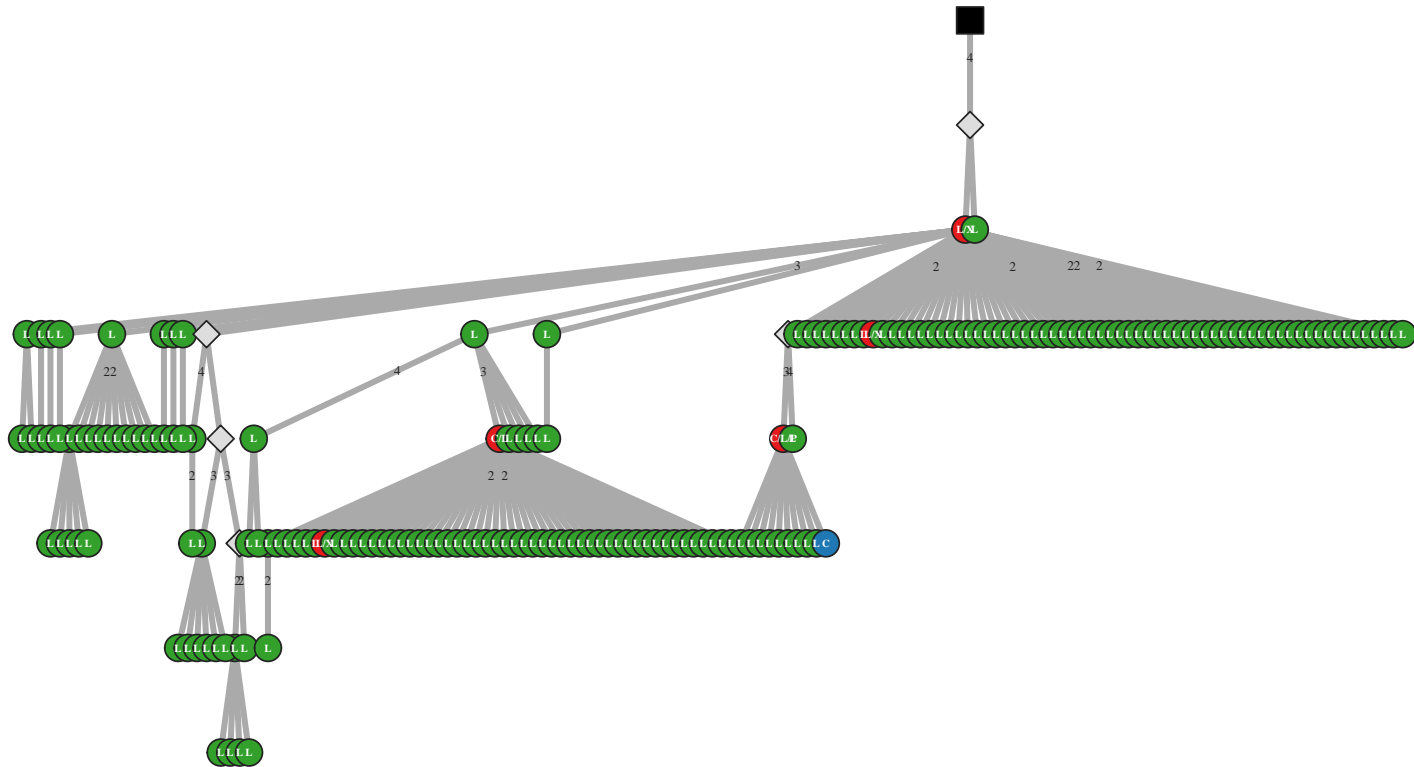

M5 IgA IGHV1-46/J4 48bp (30178)

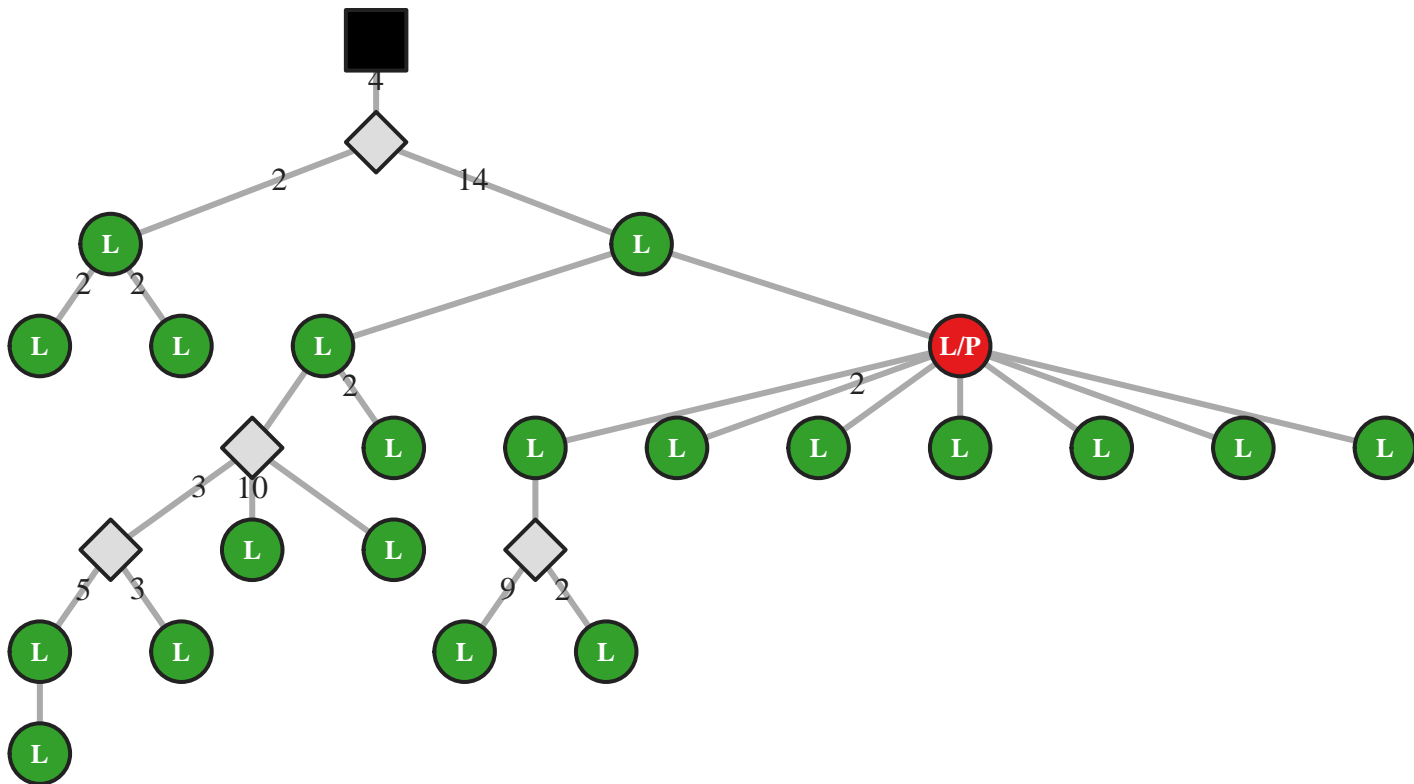

M5 IgG IGHV1-46/J4 48bp (49942)

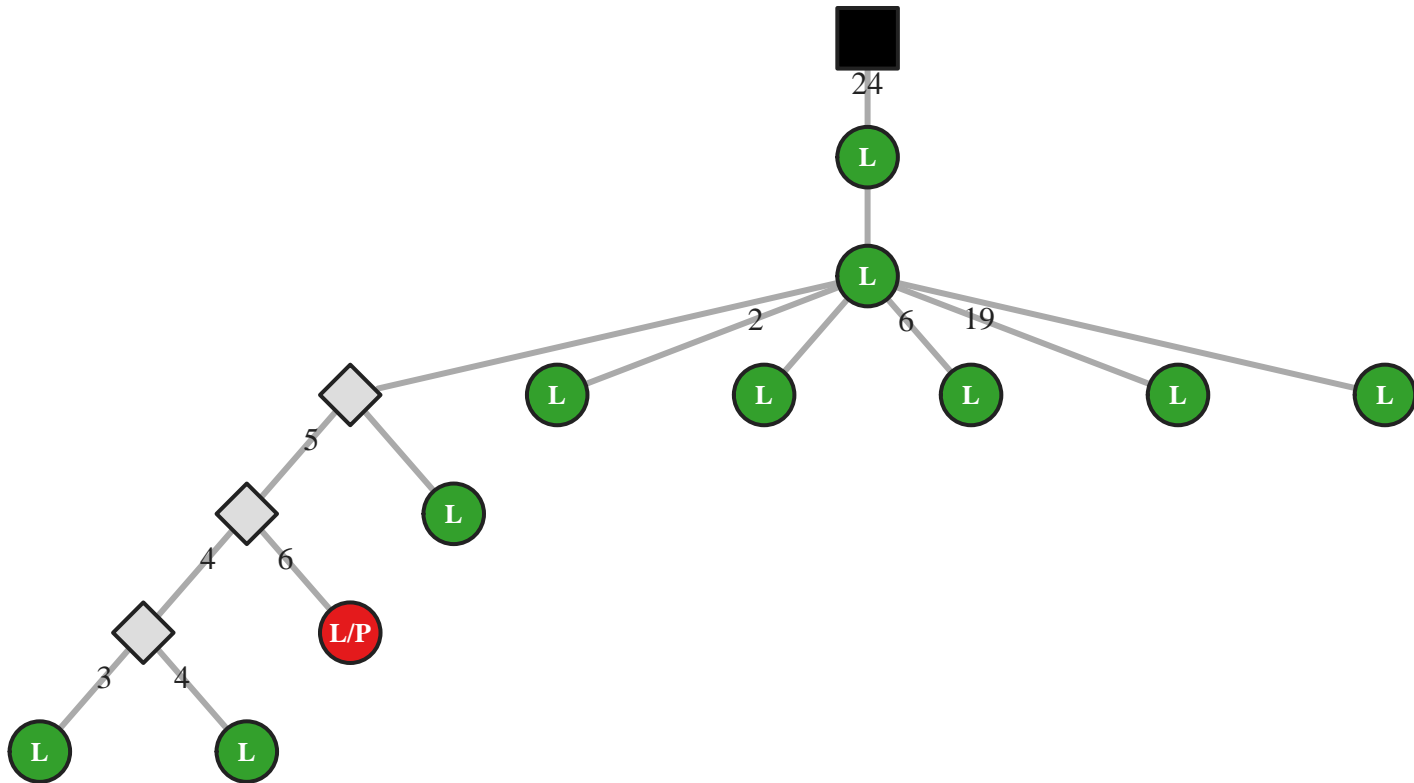

M5 IgG IGHV1-46/J4 48bp (49946)

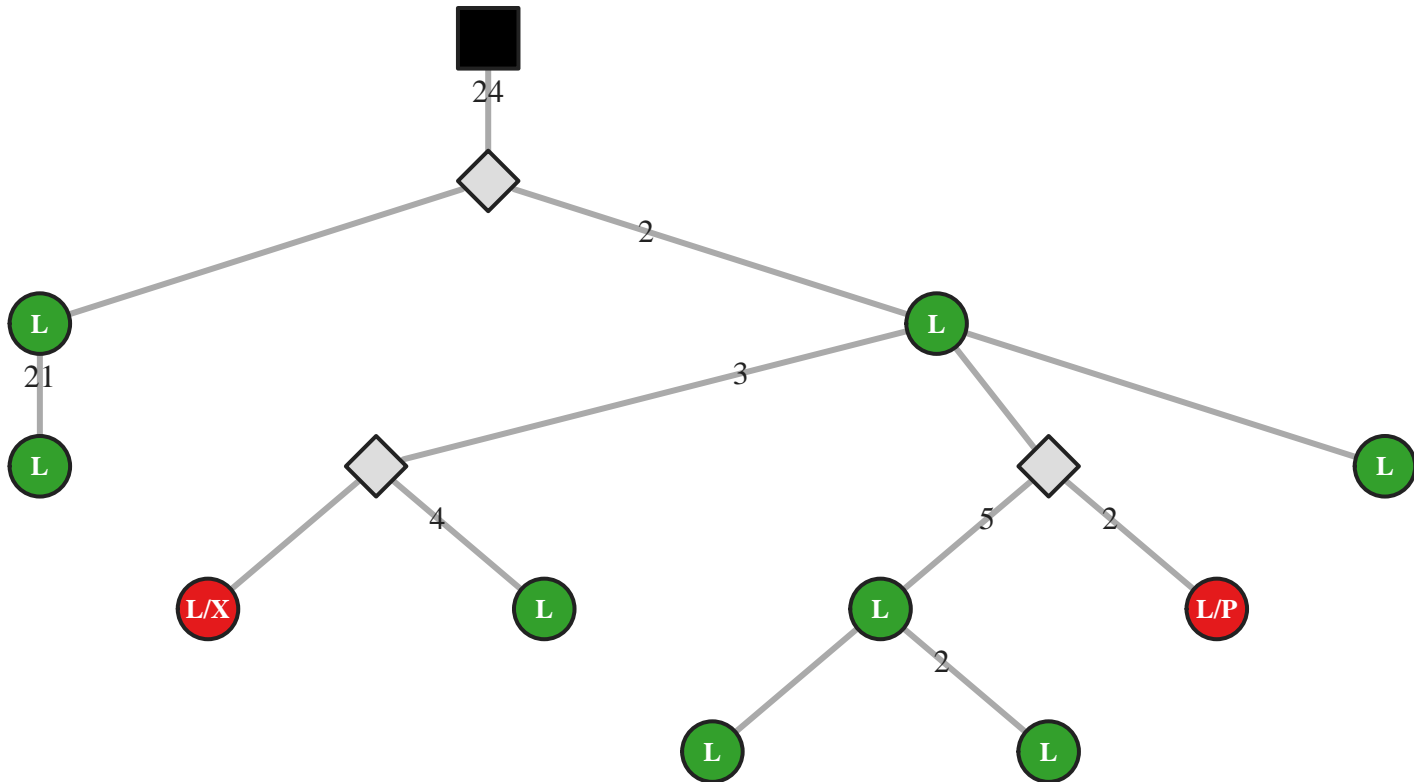

M5 IgG IGHV1-46/J4 48bp (49947)

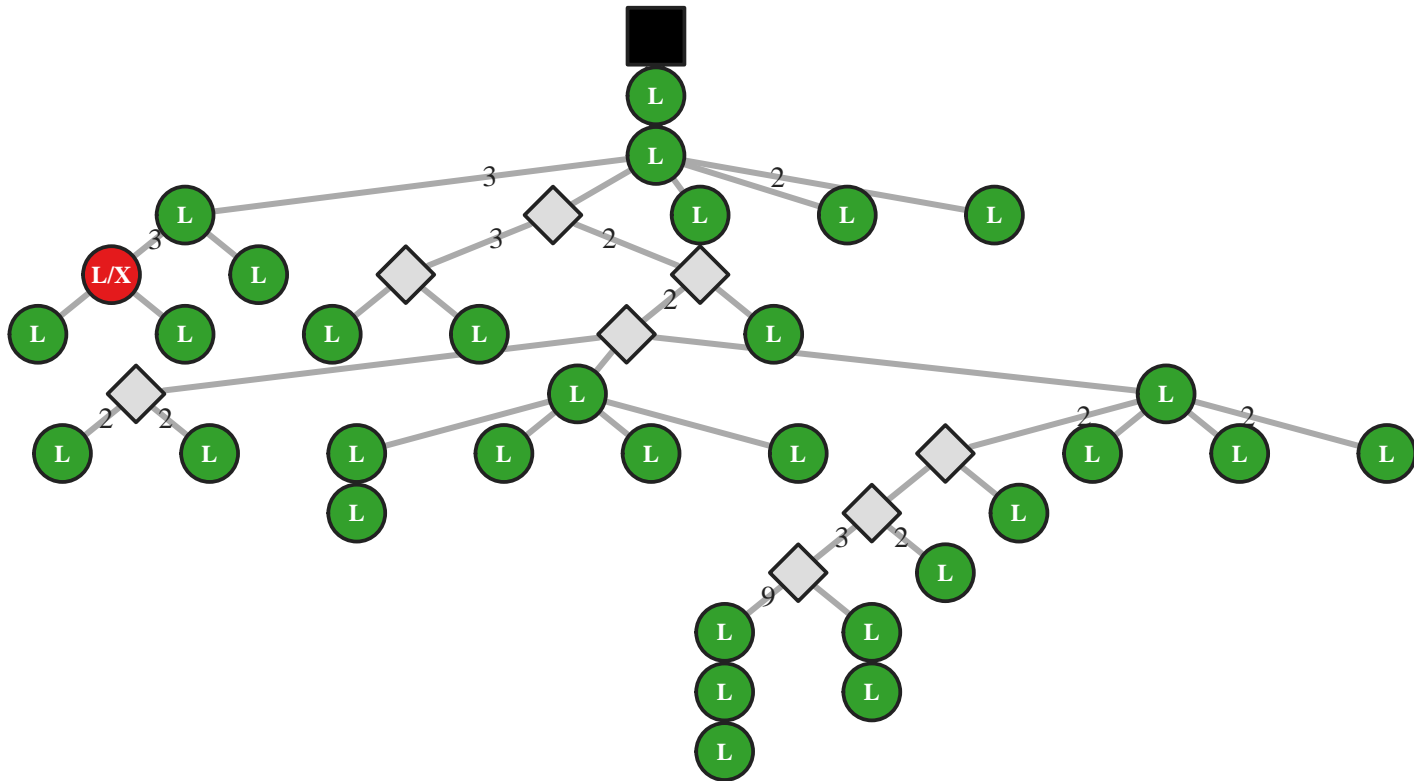

M5 IgG IGHV1-46/J4 48bp (49949)

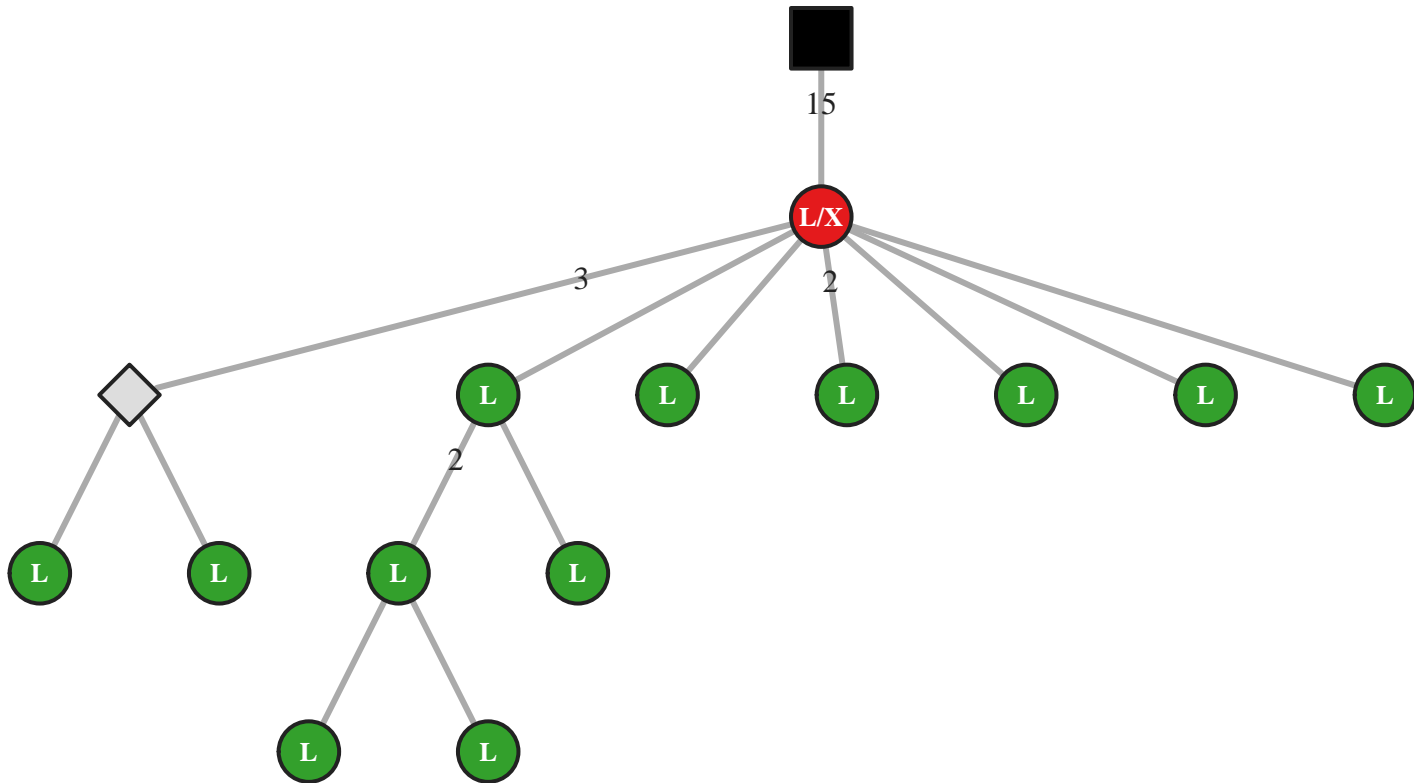

M5 IgG IGHV1-46/J4 48bp (49961)

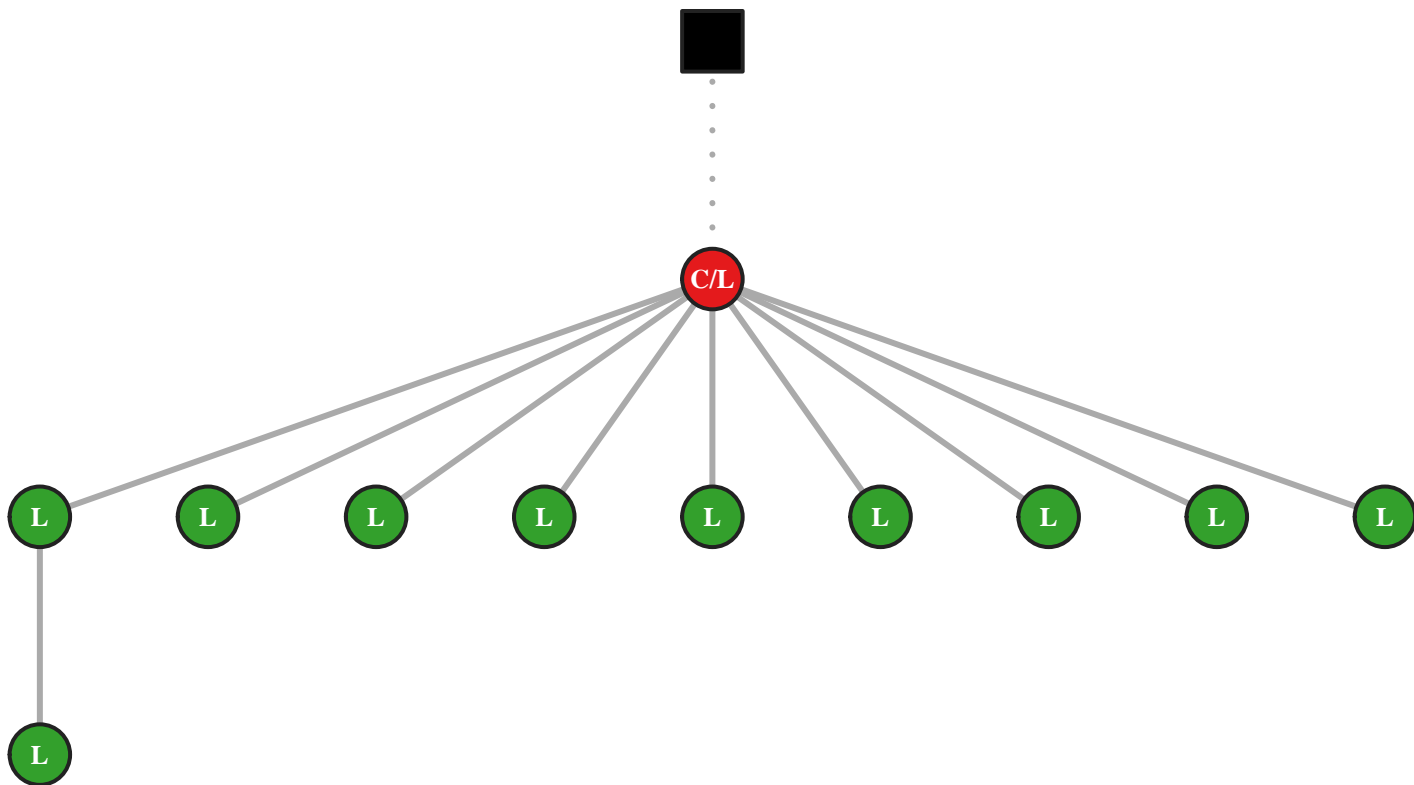

M5 IgG IGHV1-46/J4 48bp (49983)

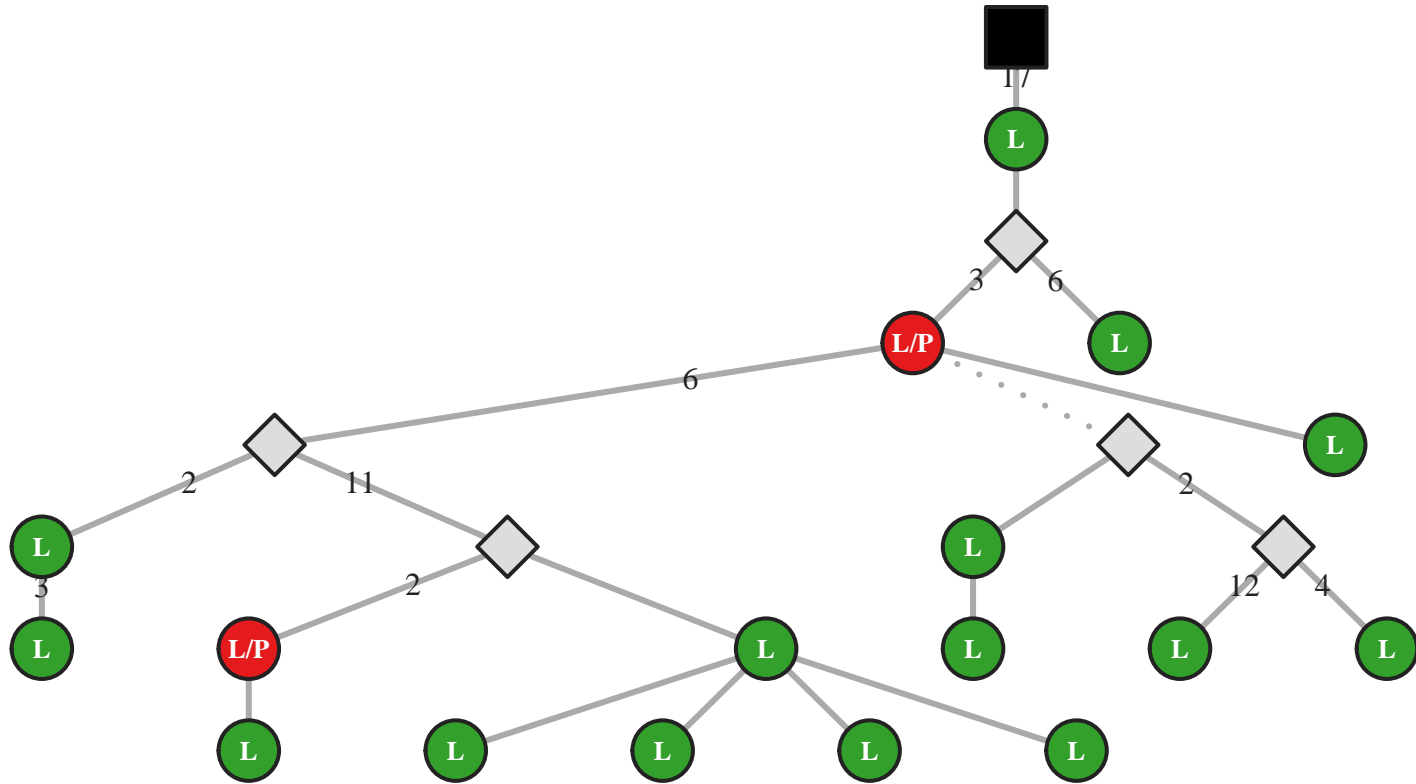

M5 IgG IGHV1-46/J4 48bp (49994)

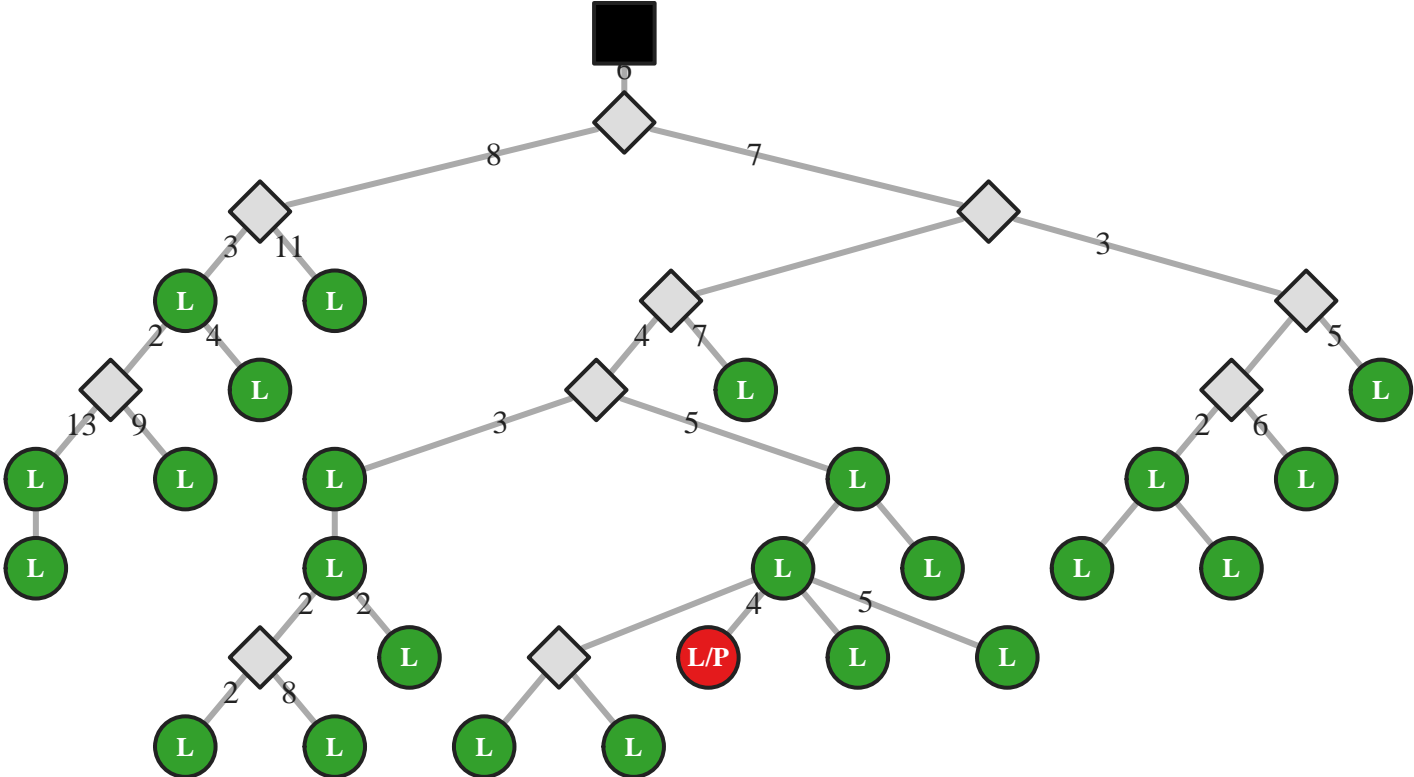

M5 IgA IGHV1-46/J4 51bp (48509)

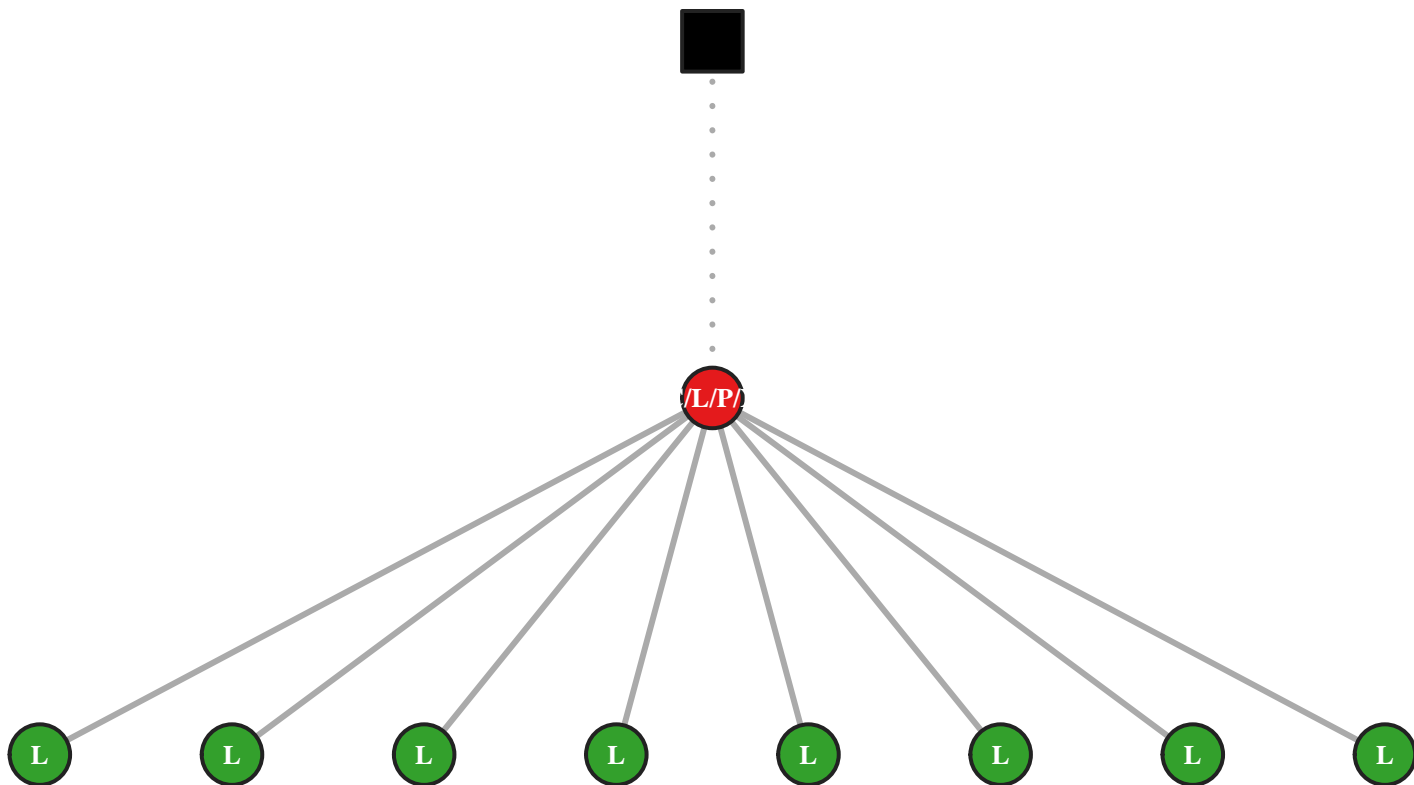

M5 IgG IGHV1-46/J4 51bp (4667)

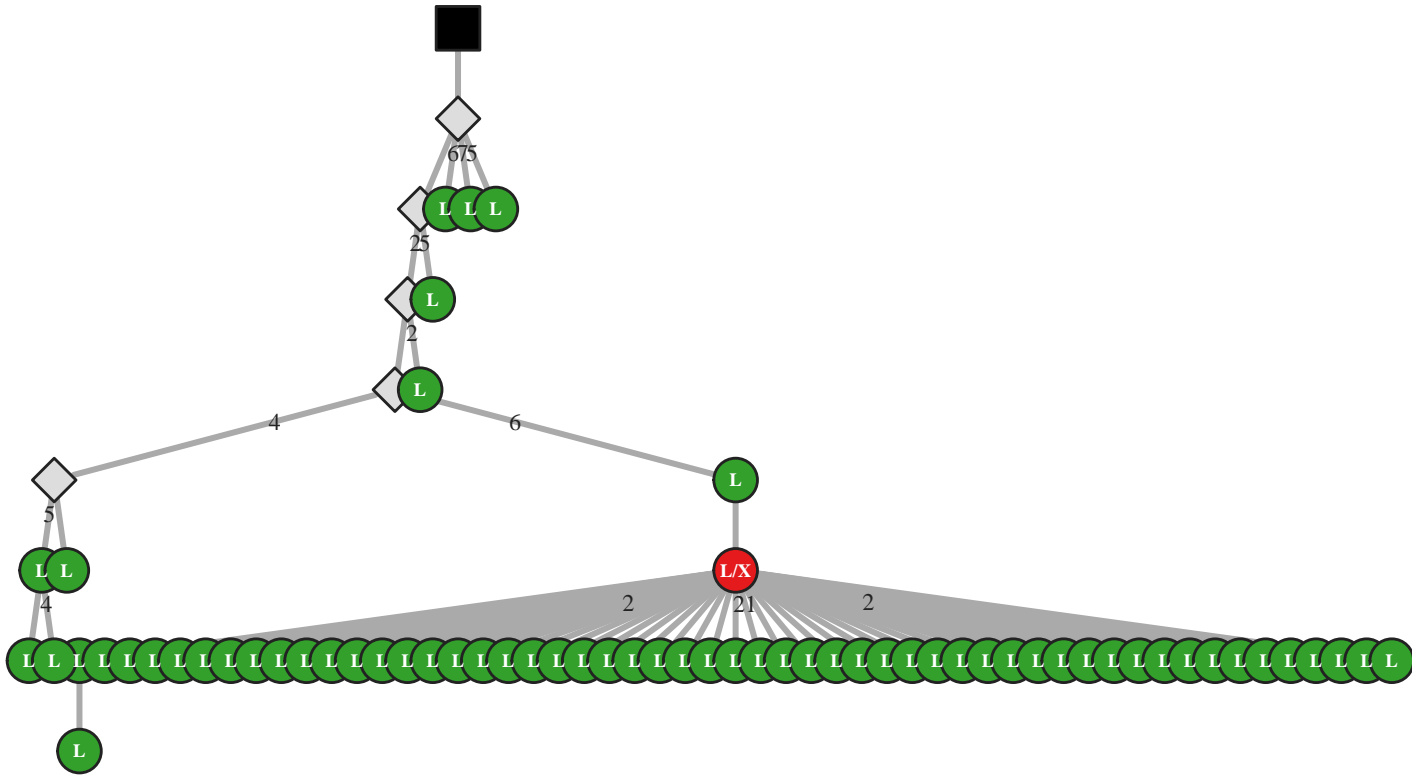

M5 IgG IGHV1-46/J4 51bp (4671)

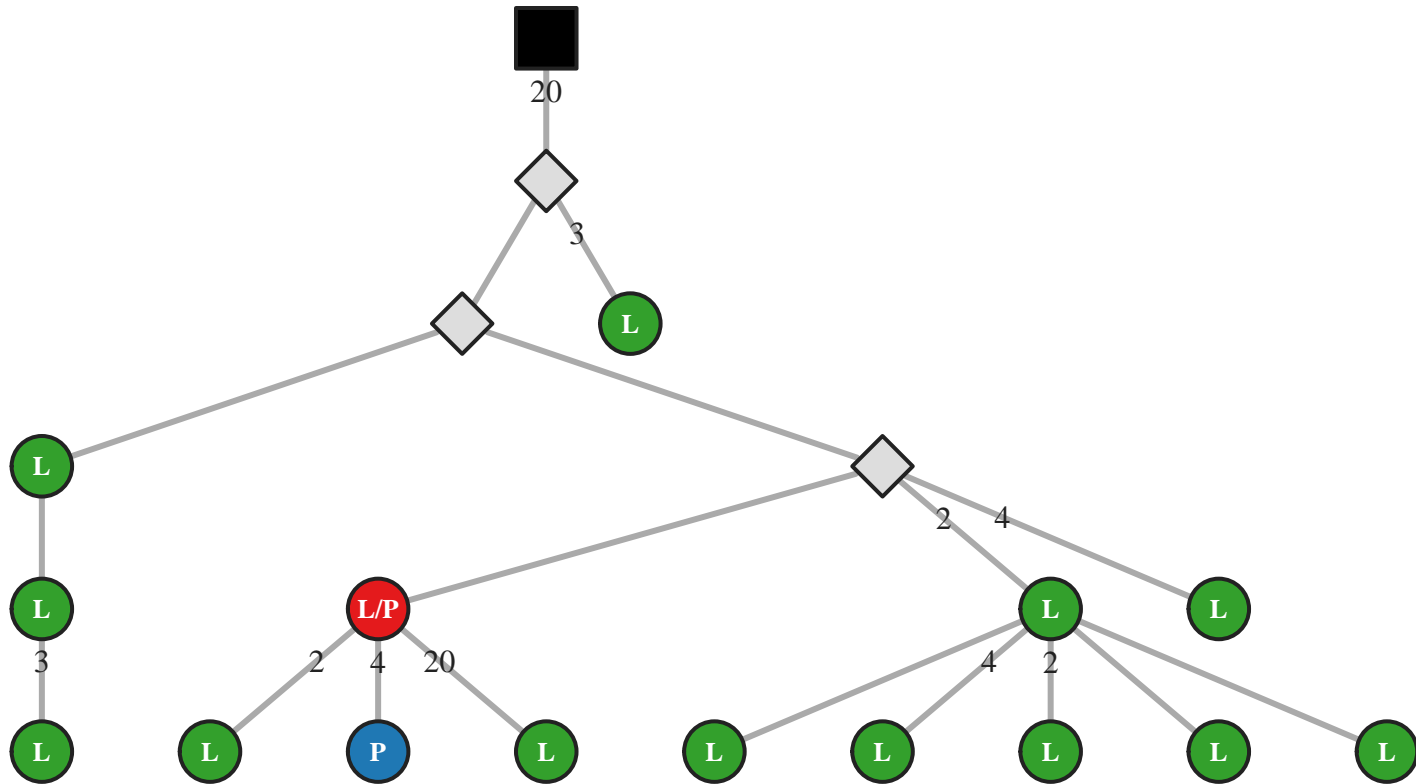

M5 IgG IGHV1-46/J4 51bp (4691)

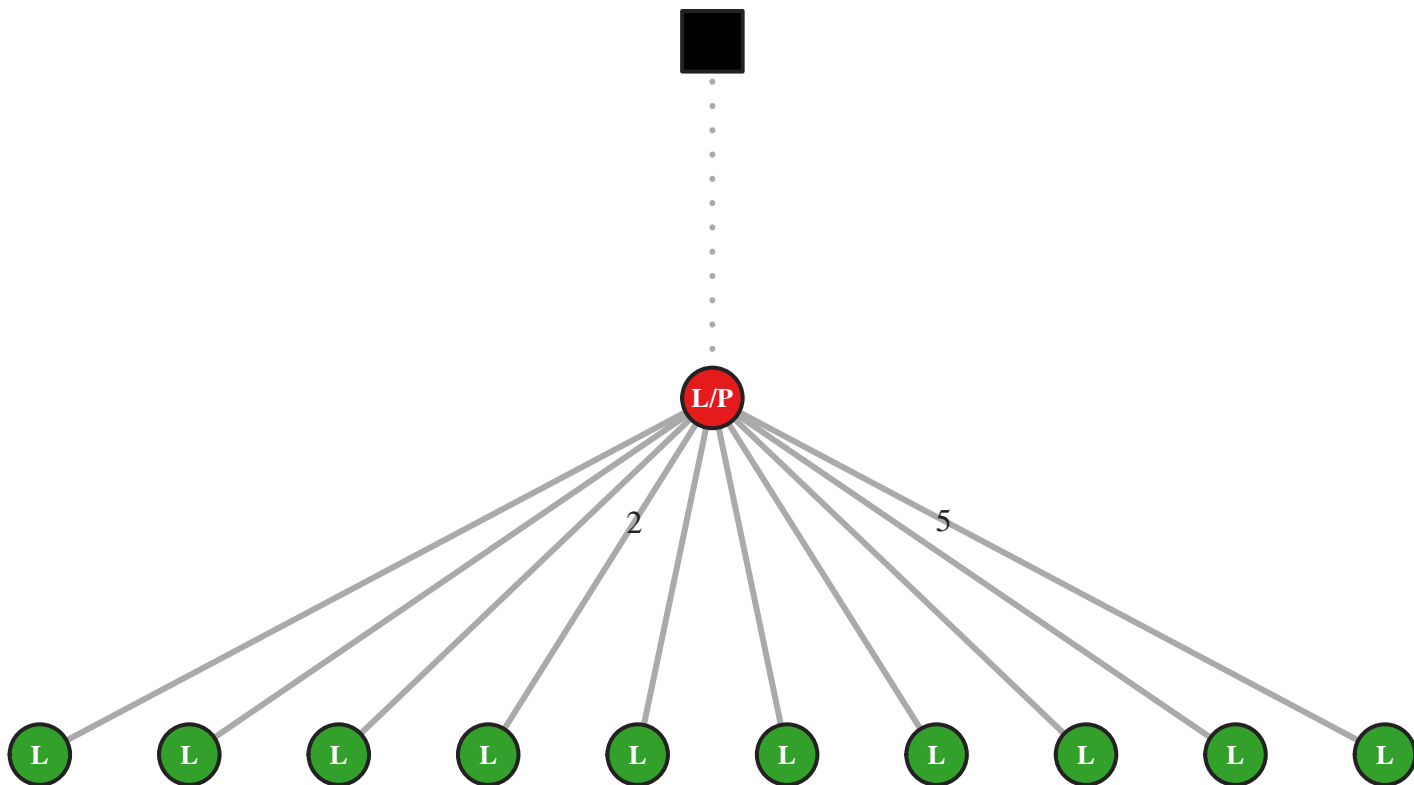

M5 IgG IGHV1-46/J4 51bp (4697)

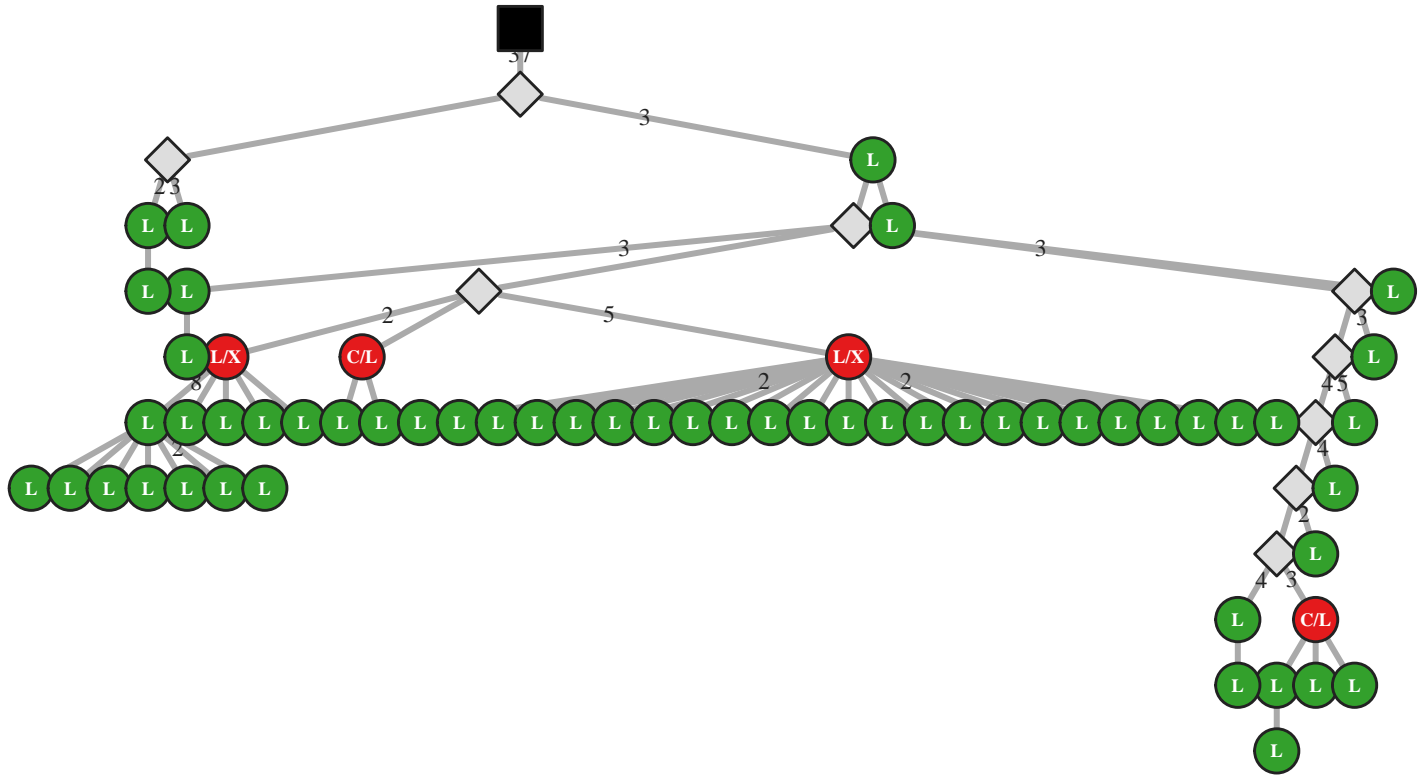

M5 IgG IGHV1-46/J4 51bp (4717)

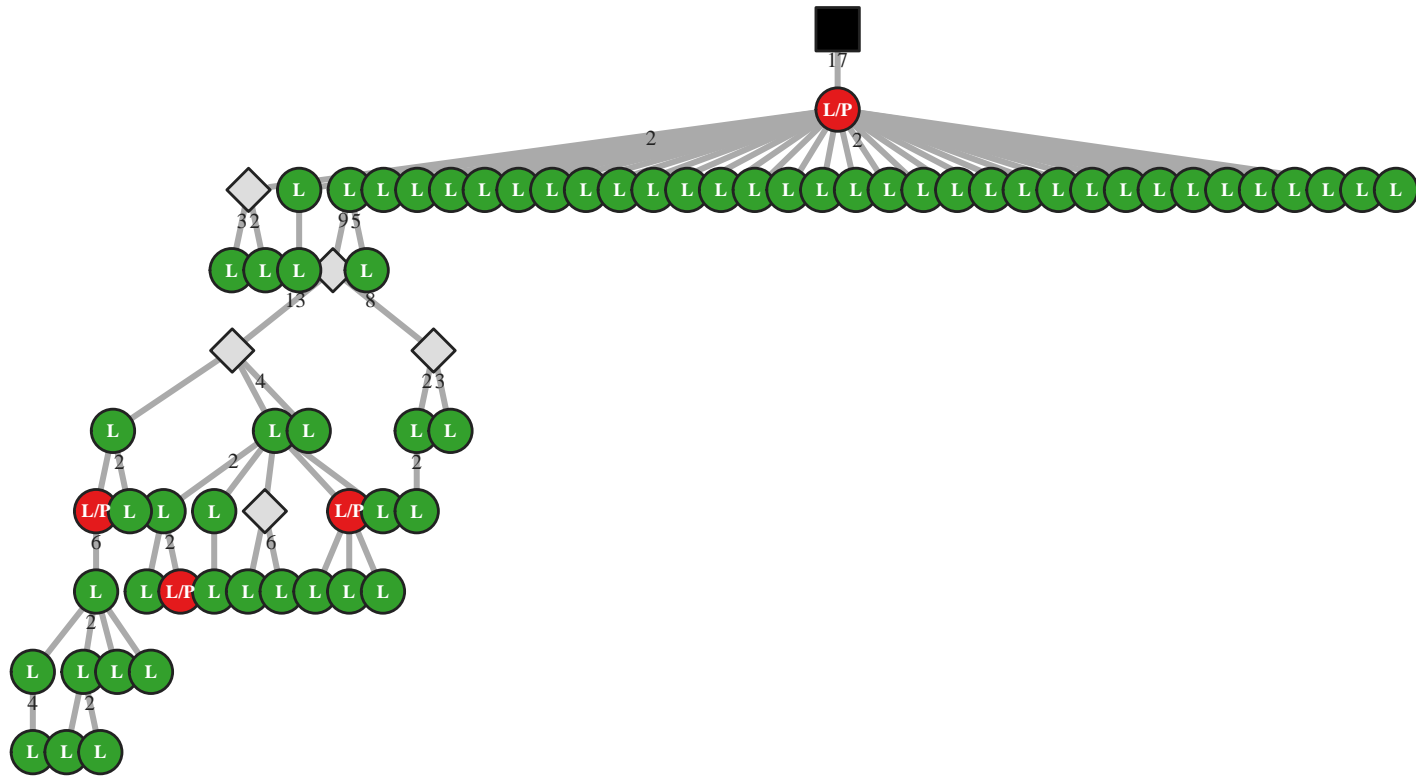

M5 IgG IGHV1-46/J4 54bp (50050)

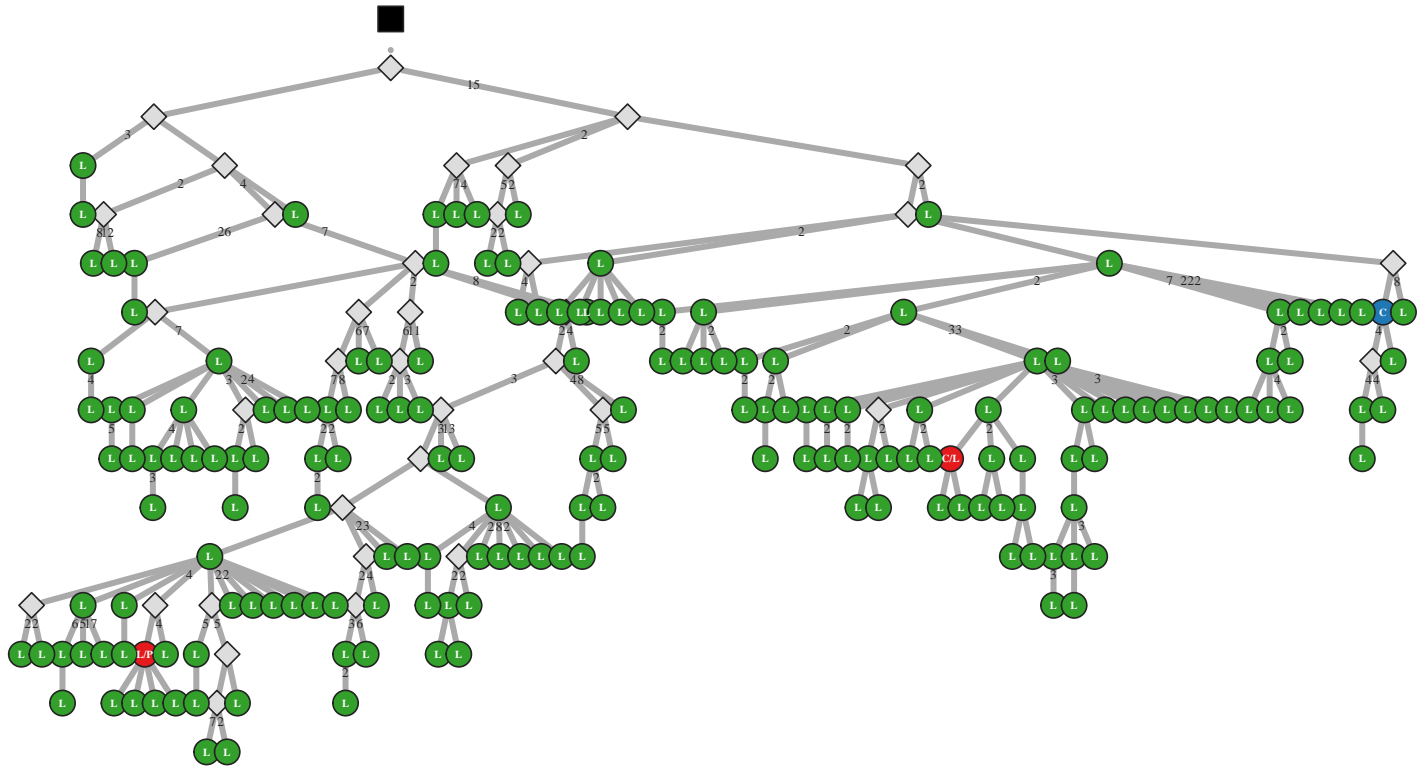

M5 IgA IGHV1-46/J4 57bp (38359)

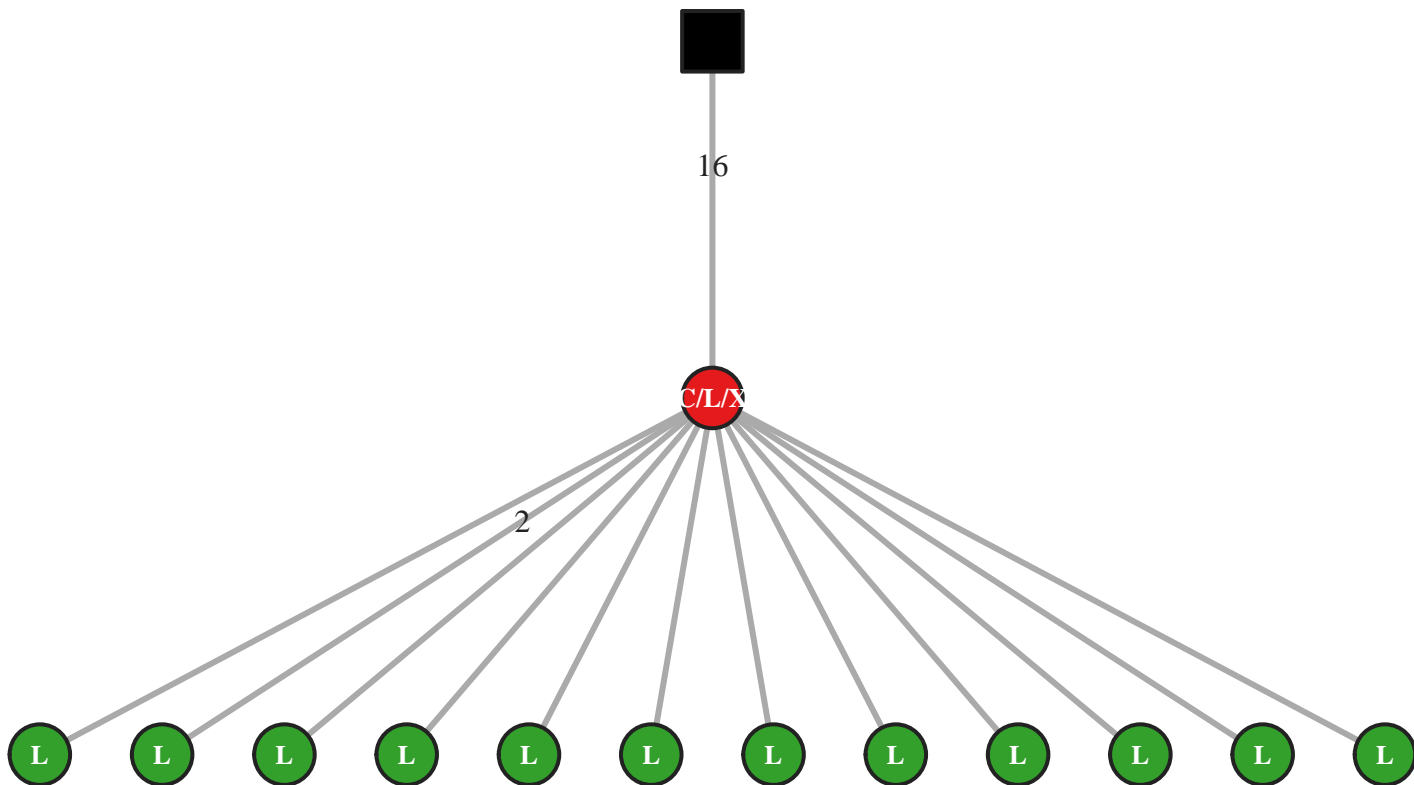

M5 IgG IGHV1-46/J4 57bp (40606)

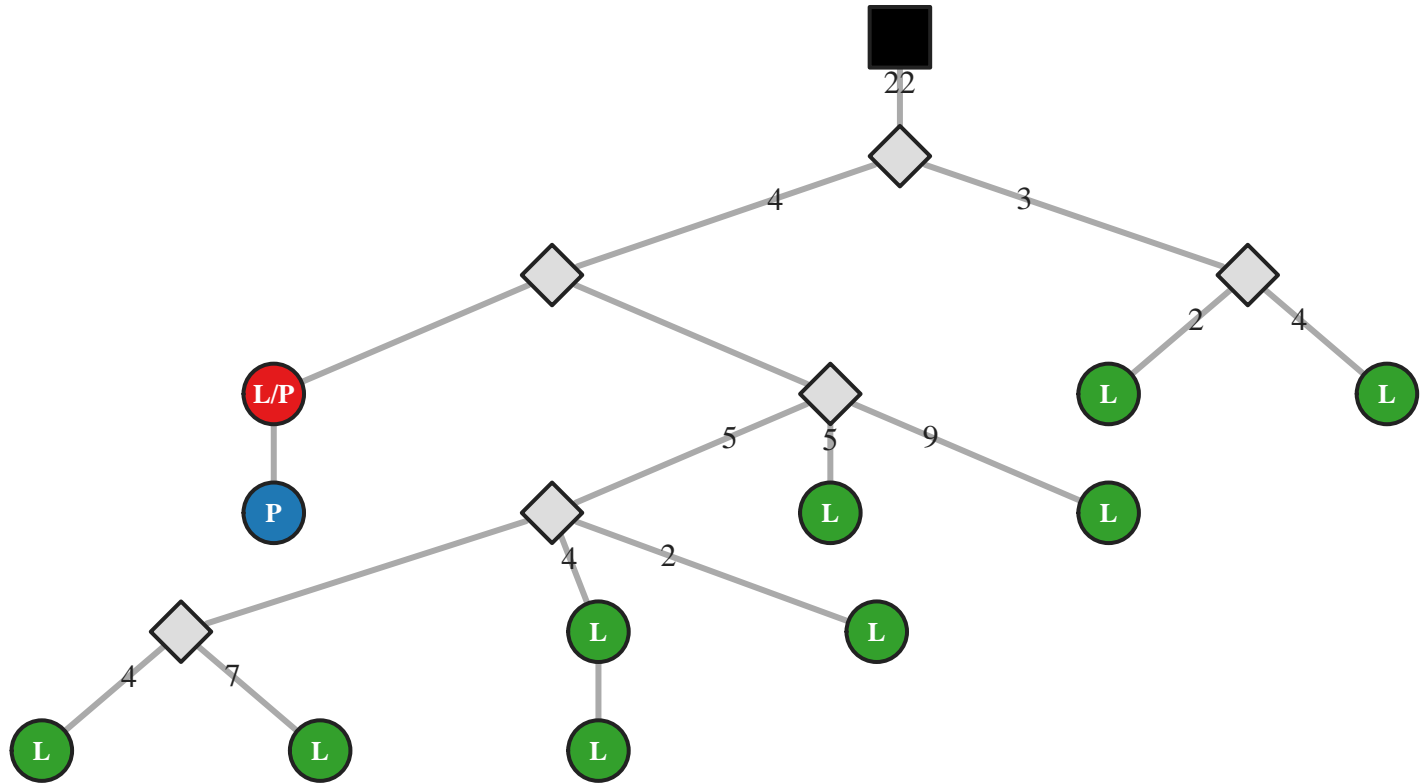

M5 IgG IGHV1-46/J4 60bp (32320)

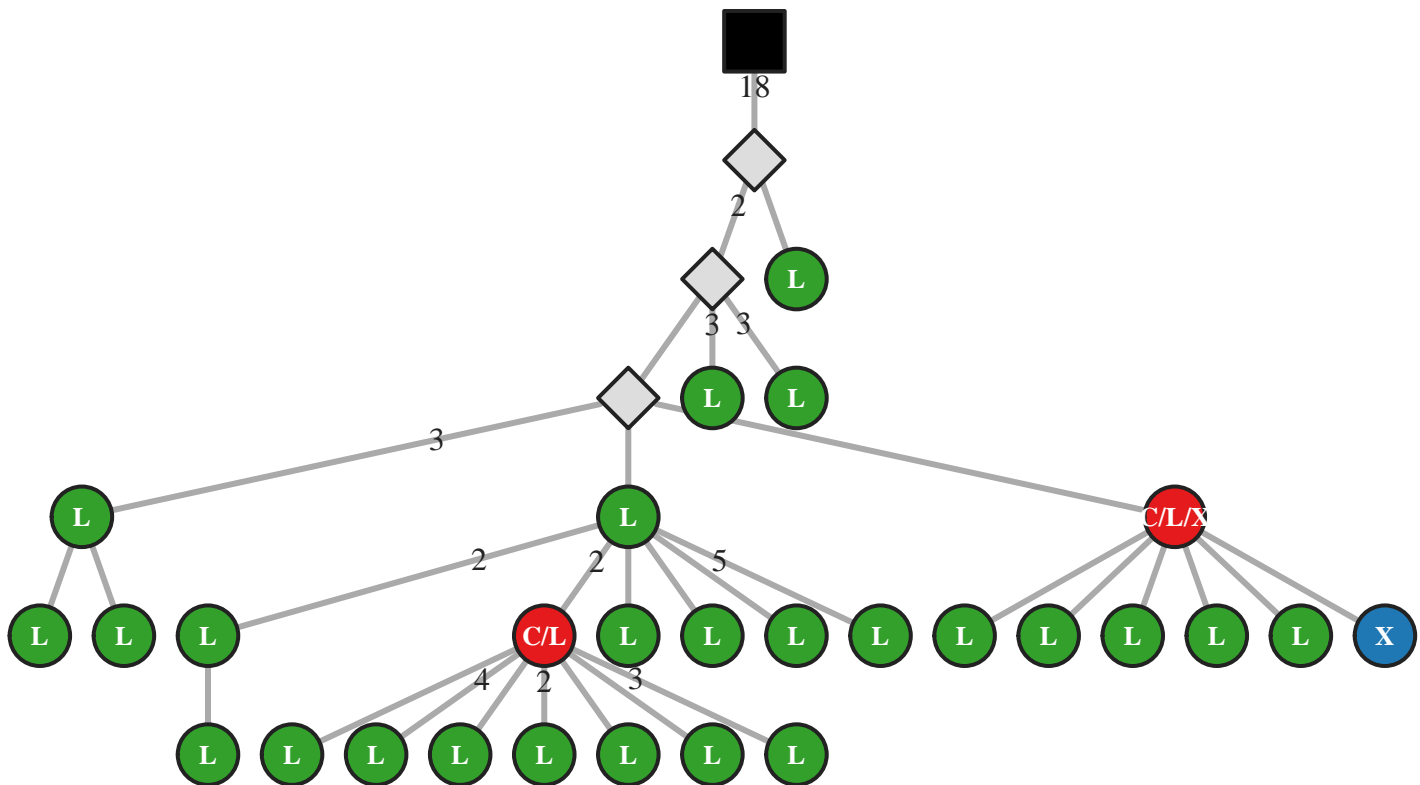

M5 IgG IGHV1-46/J4 69bp (14341)

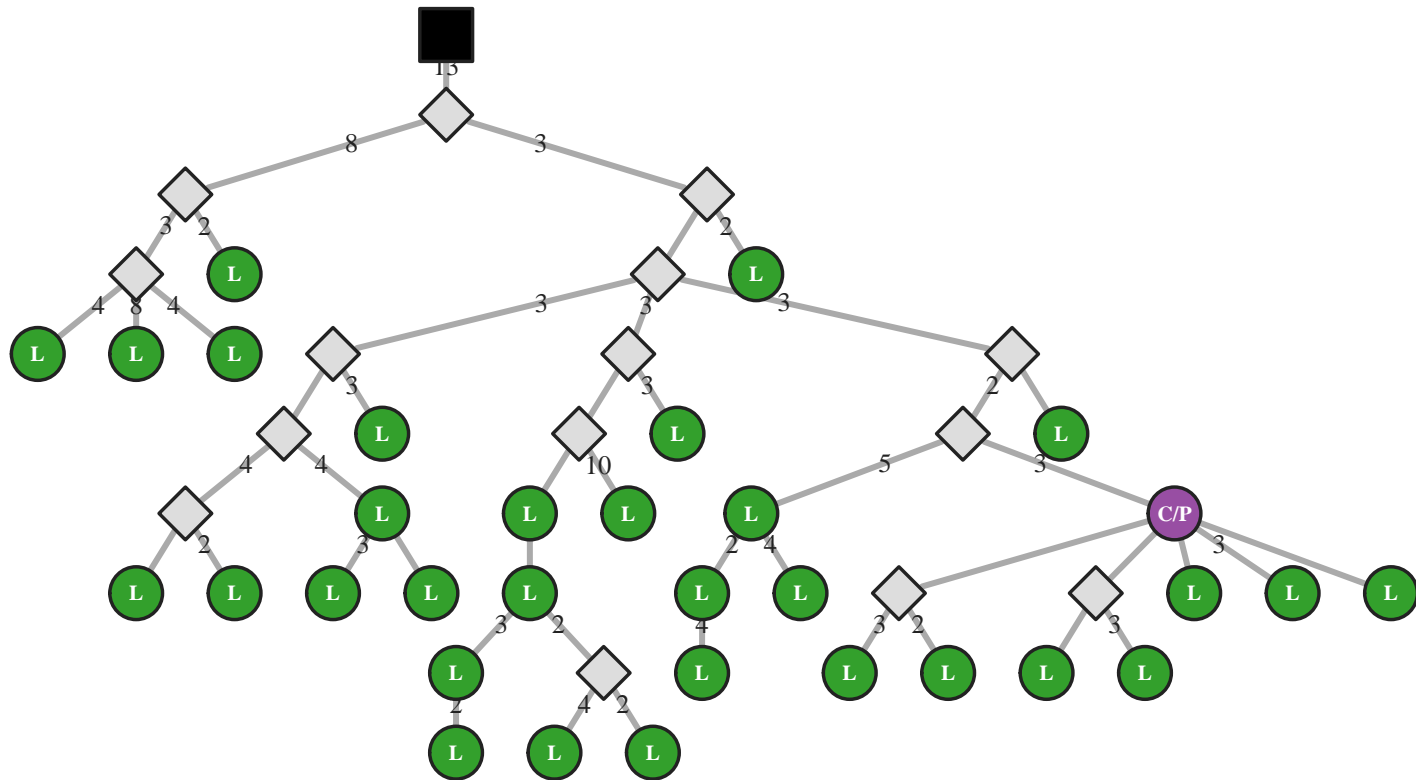

M5 IgG IGHV1-46/J4 75bp (40633)

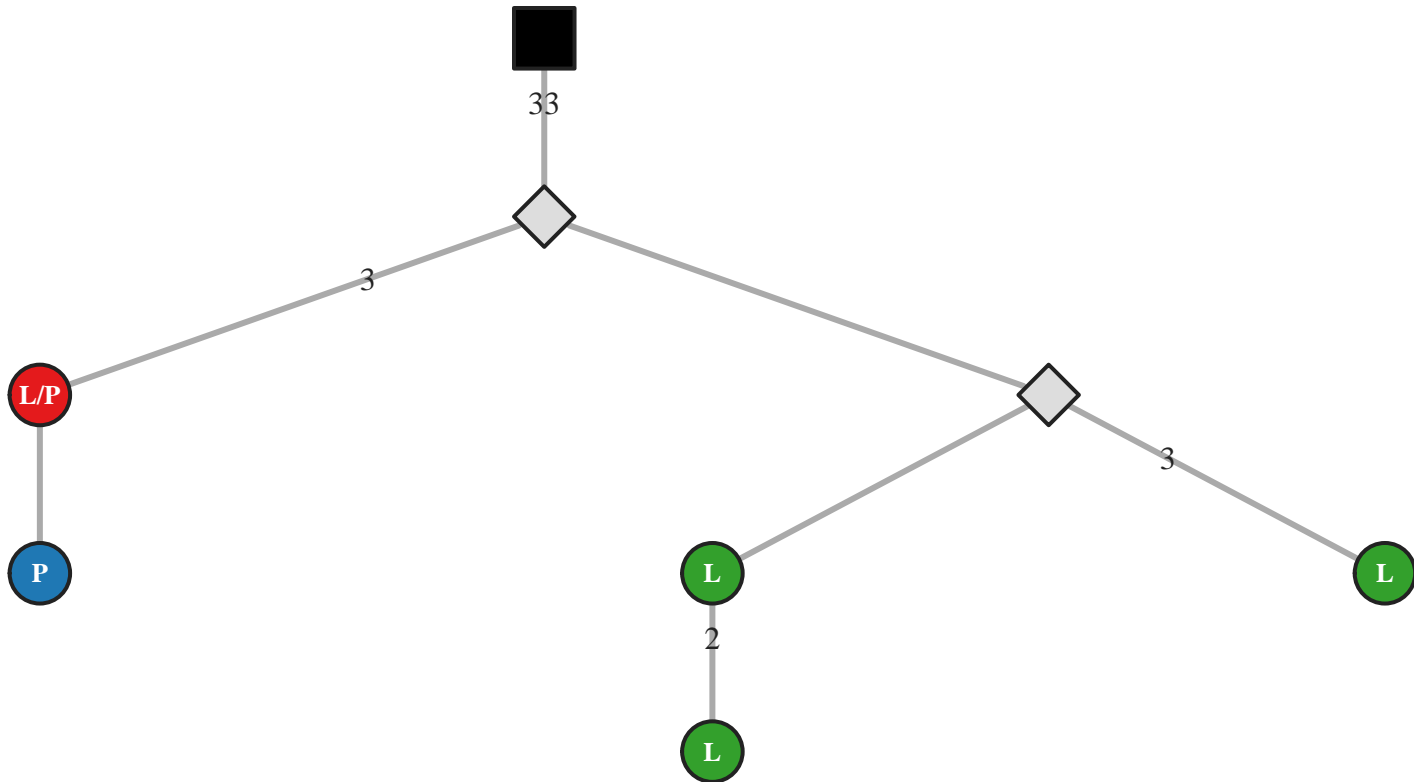

M5 IgG IGHV1-46/J5 30bp (14358)

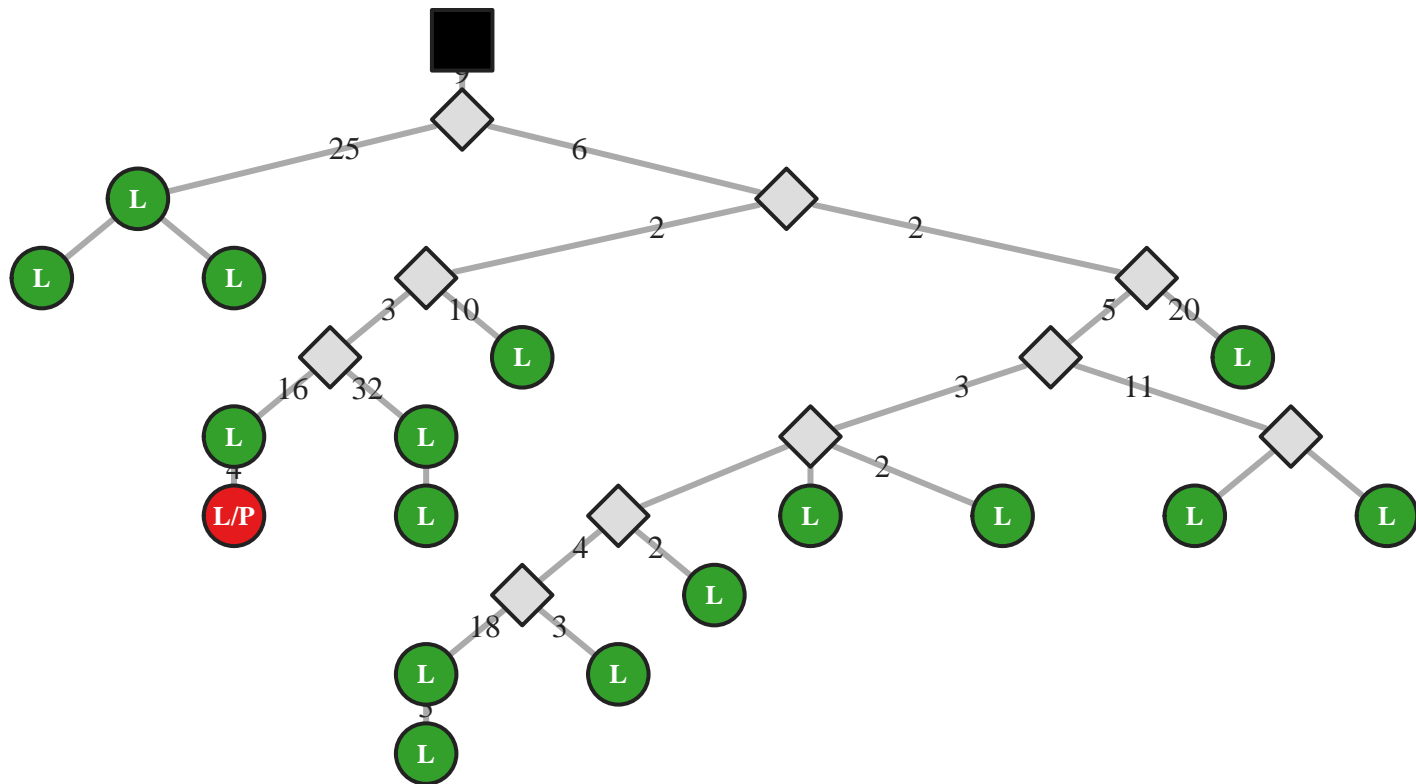

M5 IgA IGHV1-46/J5 45bp (48536)

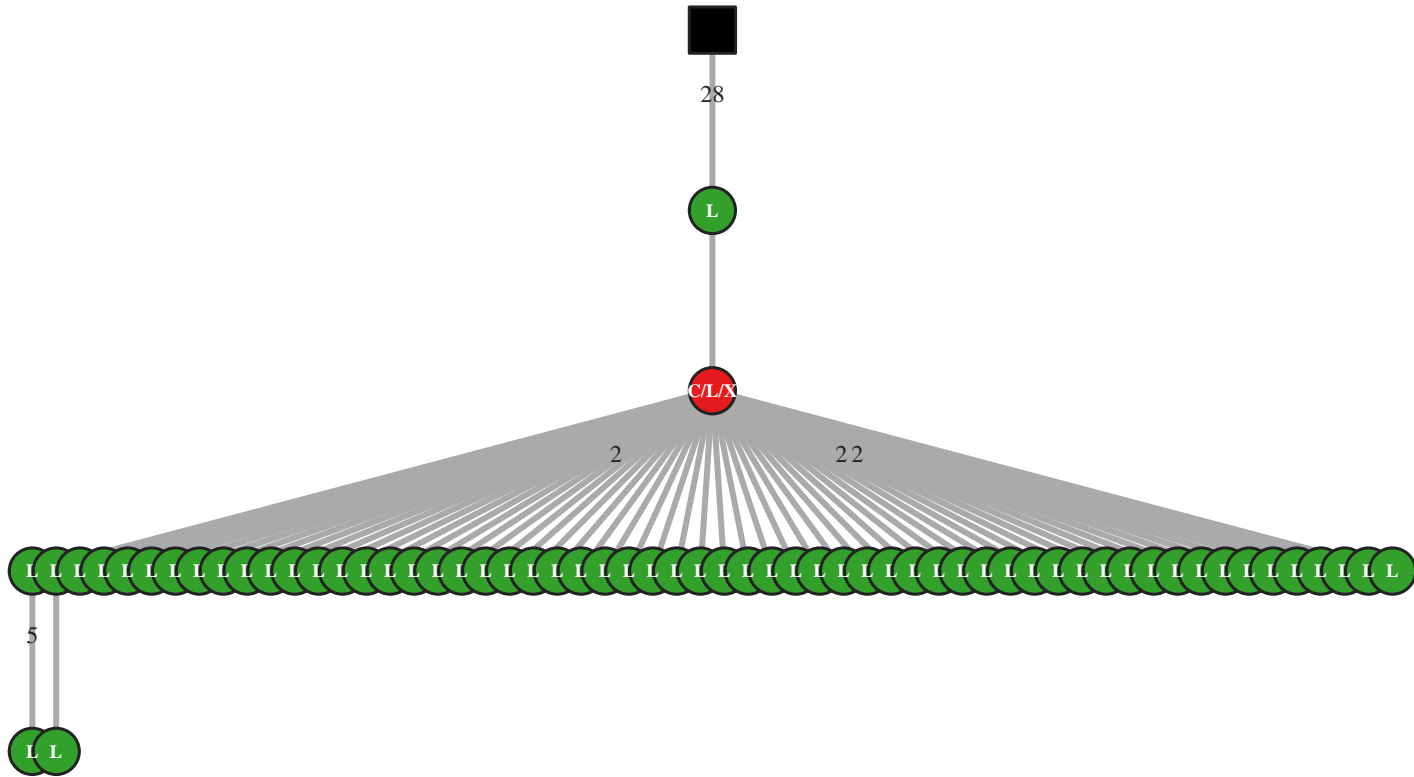

M5 IgA IGHV1-46/J5 45bp (48537)

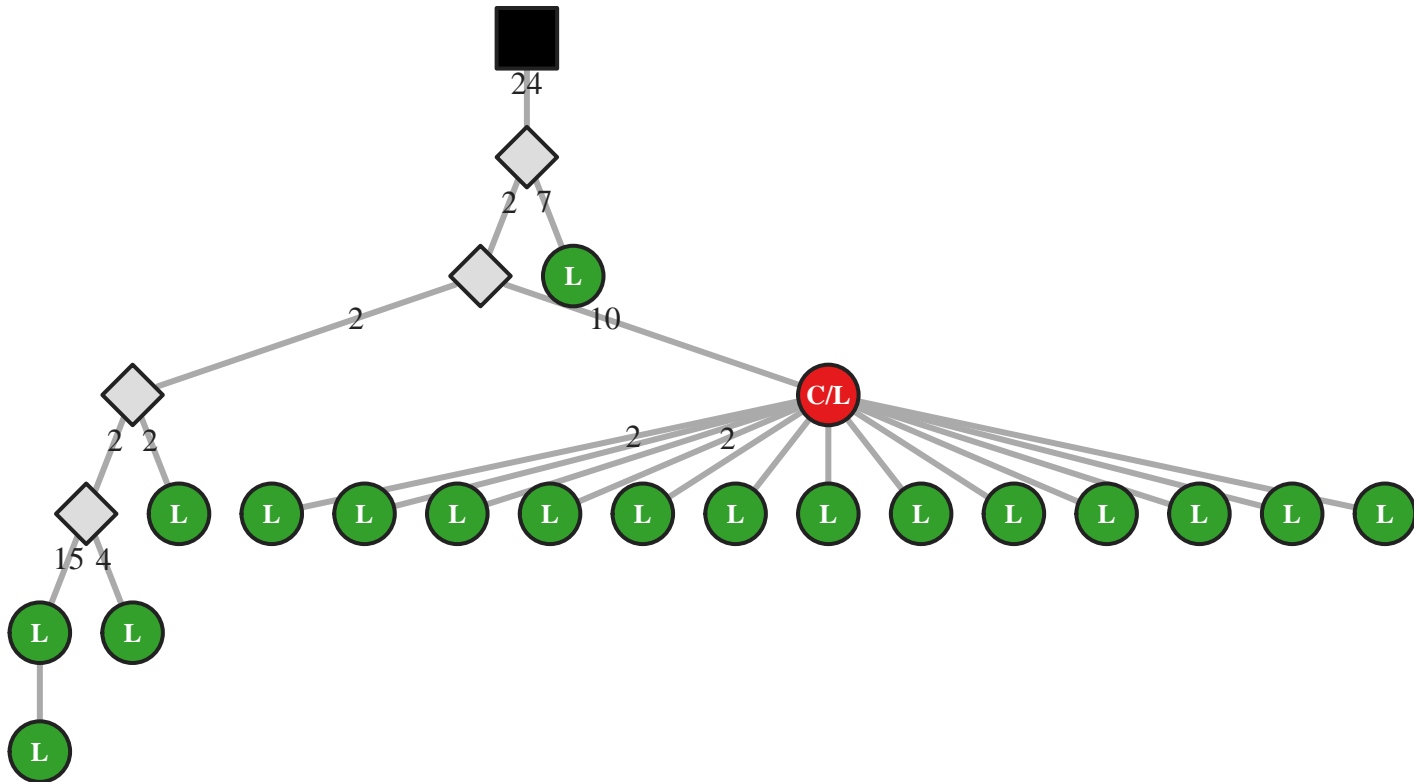

M5 IgA IGHV1-46/J5 45bp (48538)

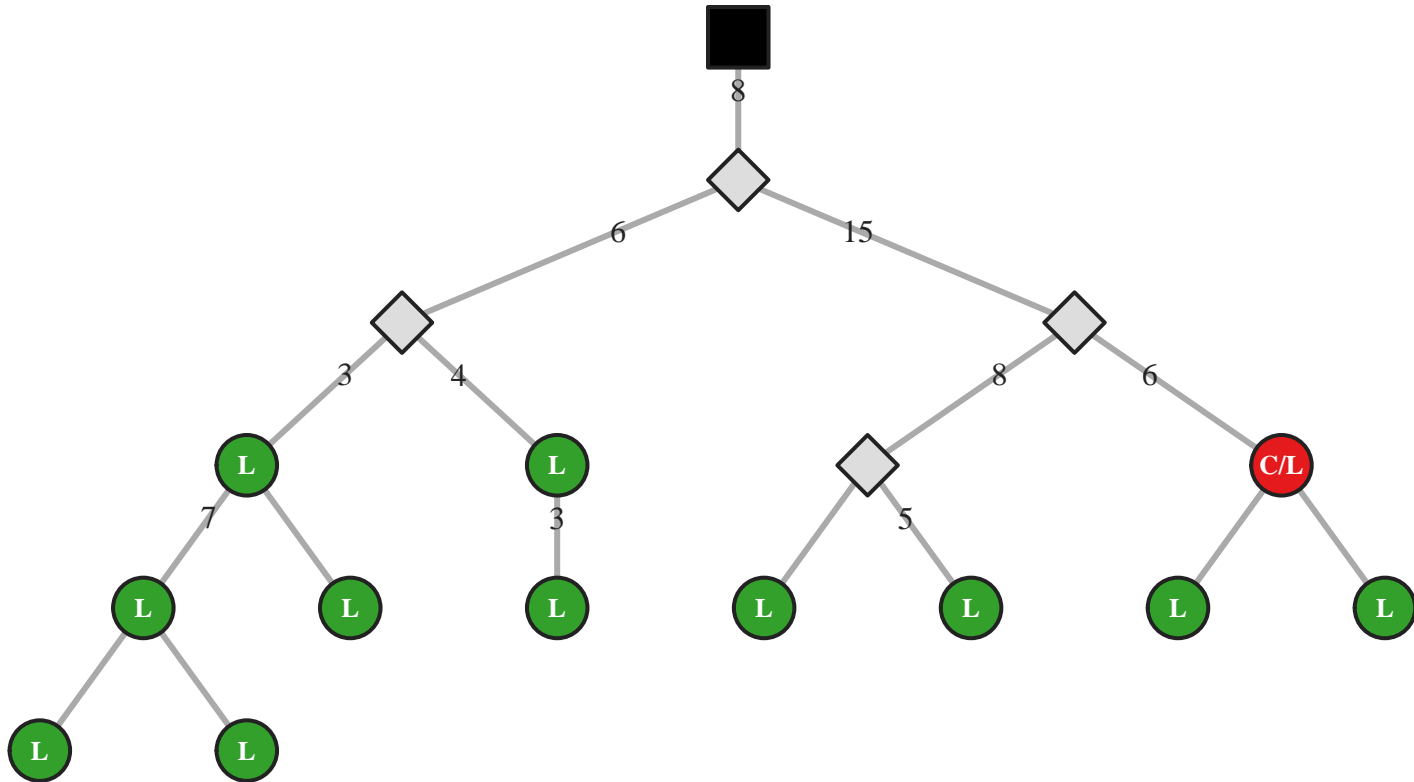

M5 IgG IGHV1-46/J5 54bp (14372)

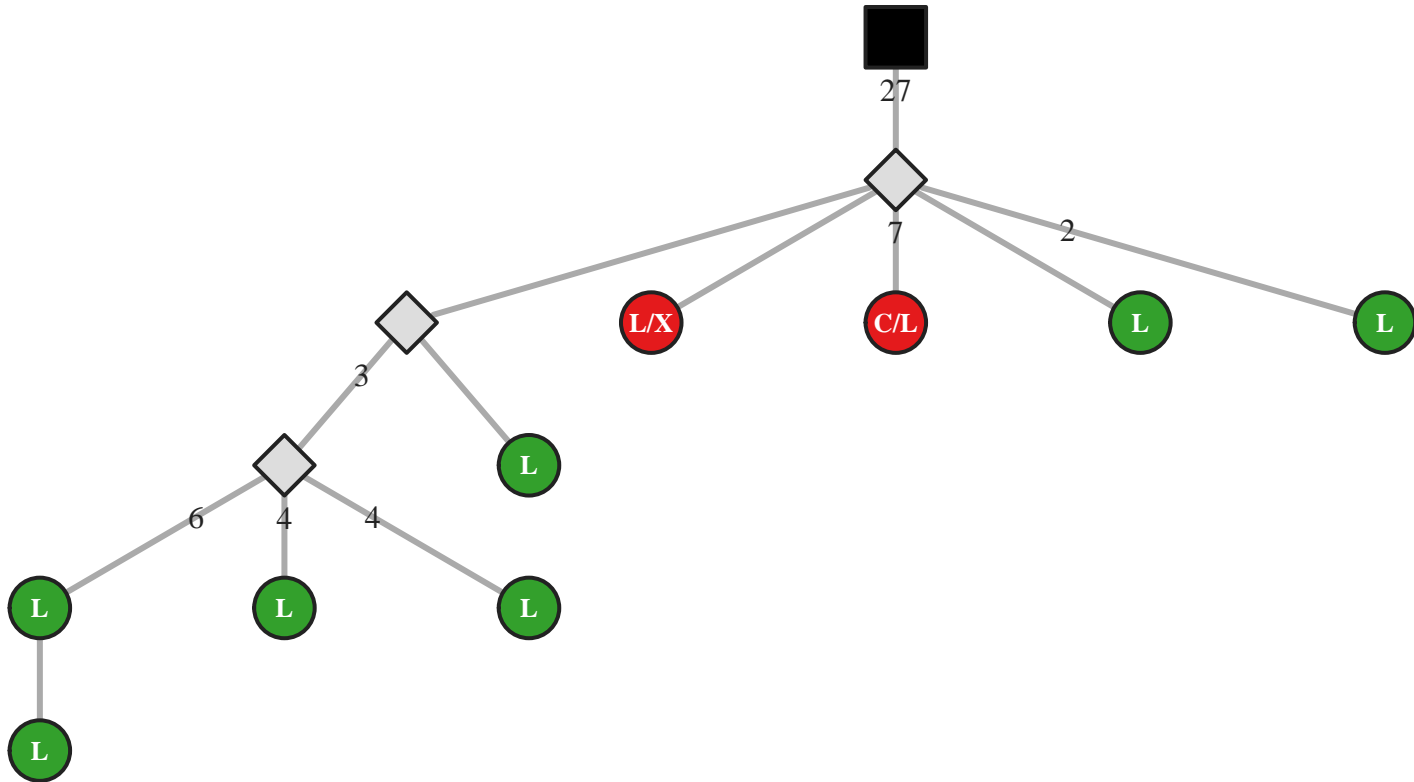

M5 IgG IGHV1-46/J5 57bp (4723)

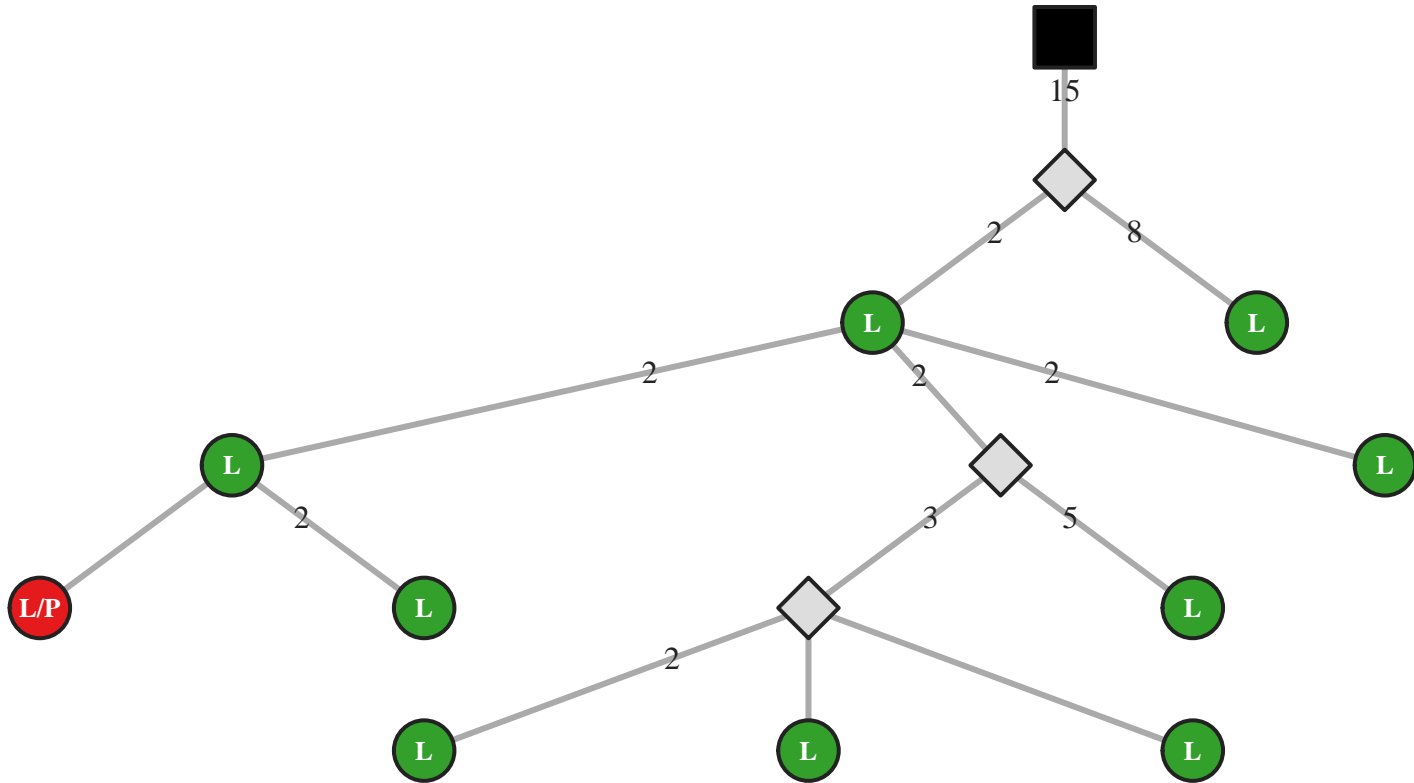

M5 IgG IGHV1-46/J5 57bp (4730)

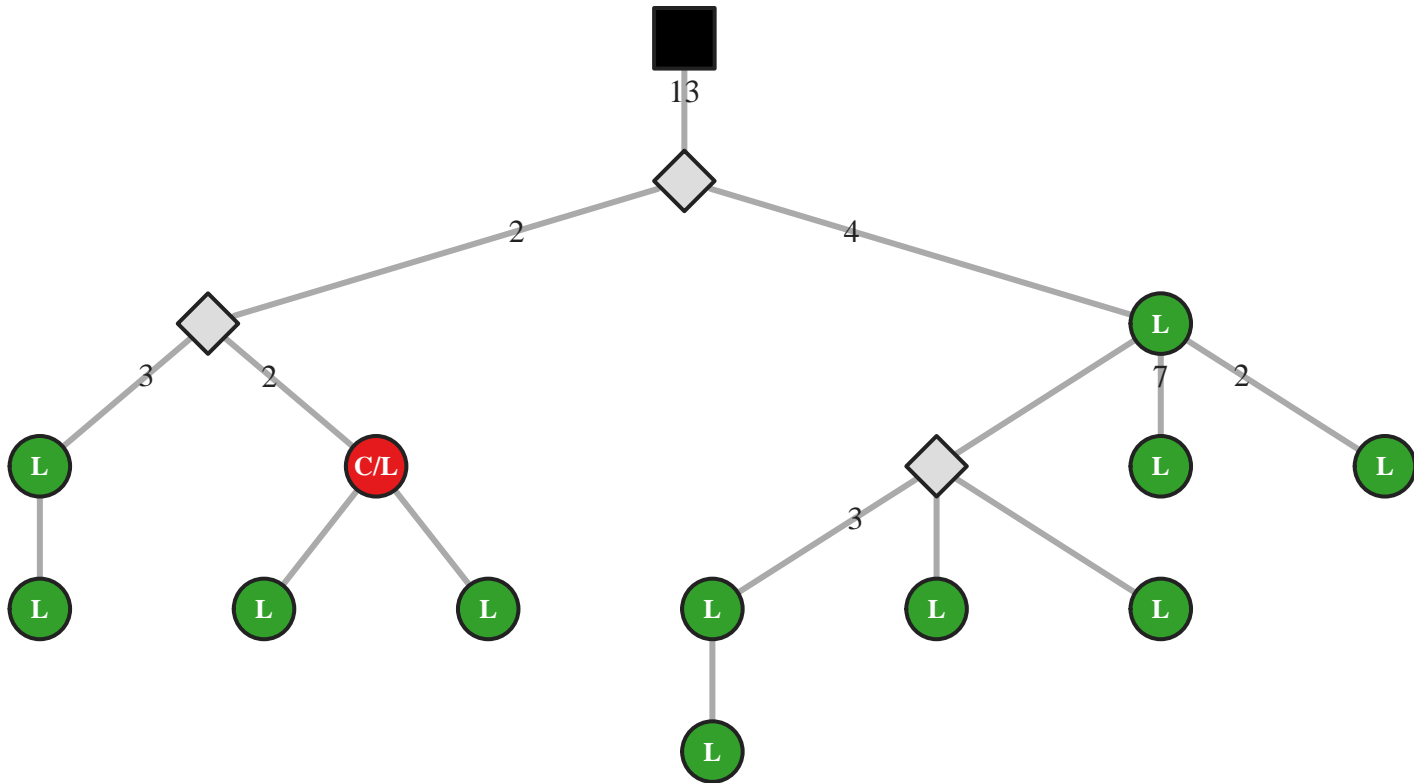

M5 IgG IGHV1-46/J6 39bp (32411)

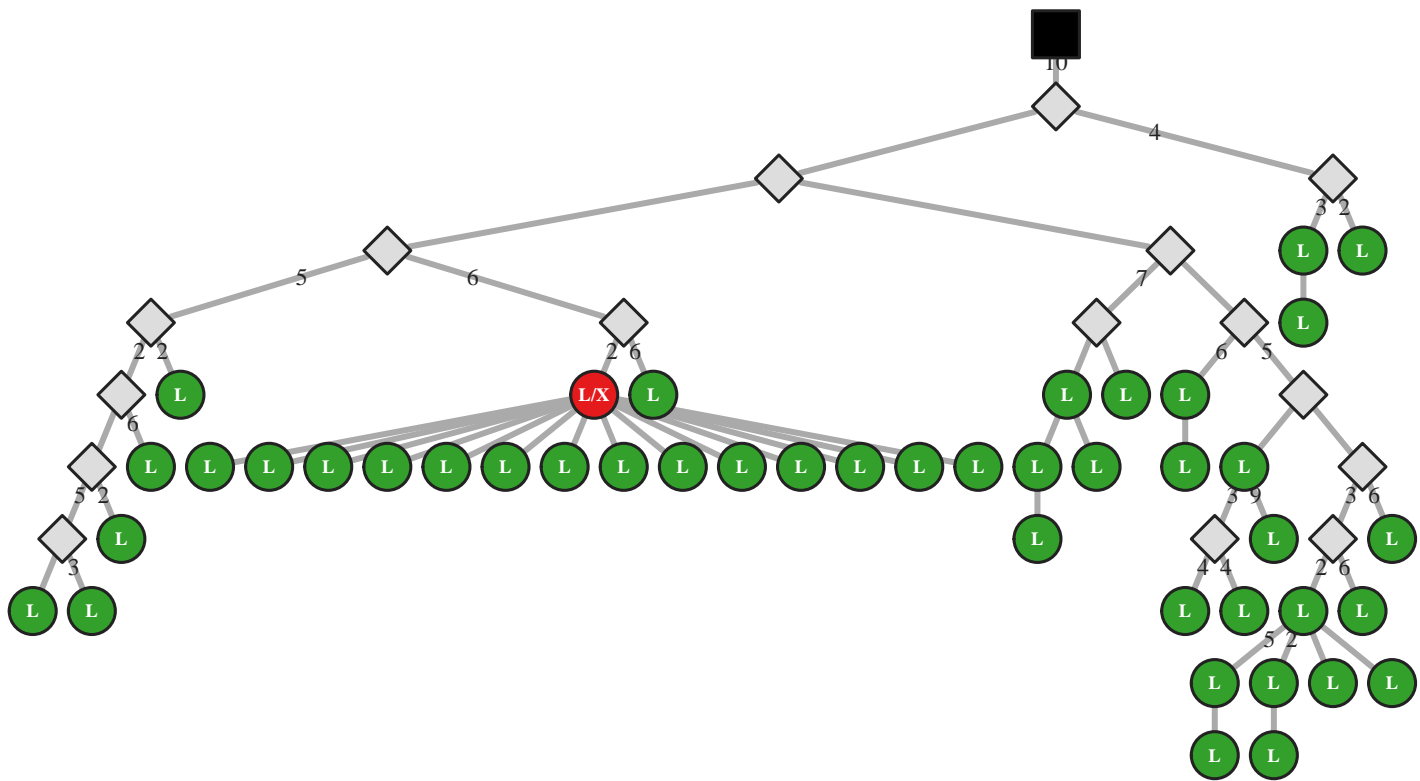

M5 IgG IGHV1-46/J6 48bp (4760)

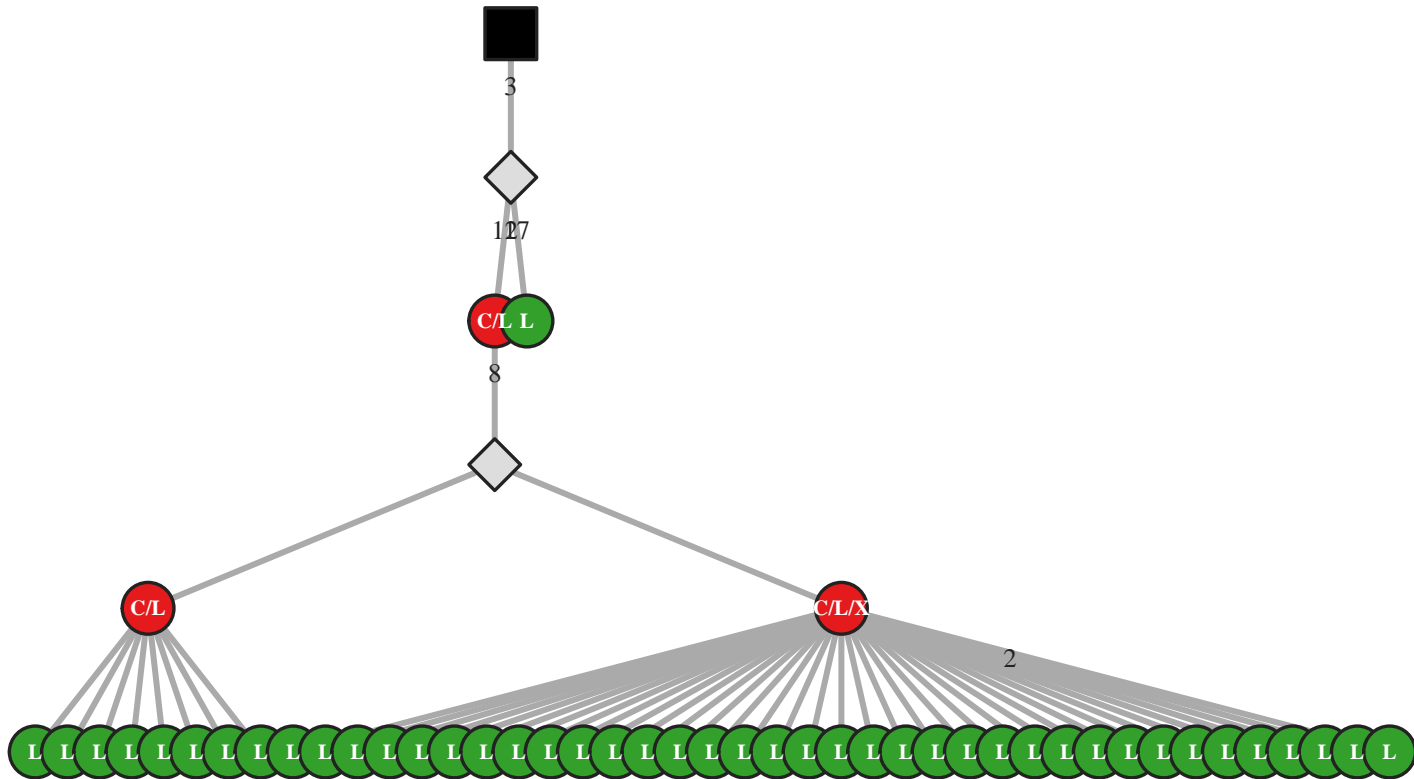

M5 IgG IGHV1-46/J6 54bp (23615)

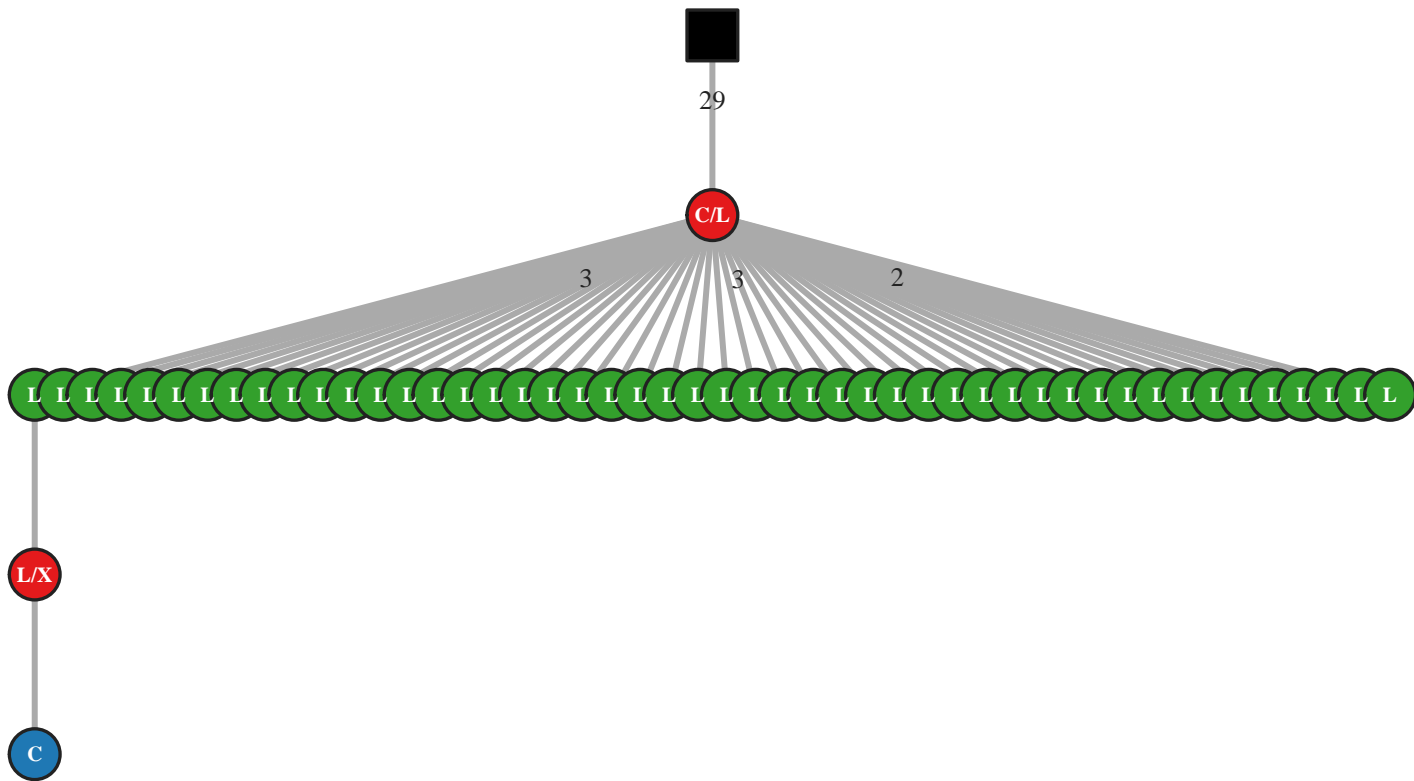

M5 IgG IGHV1-46/J6 57bp (23655)

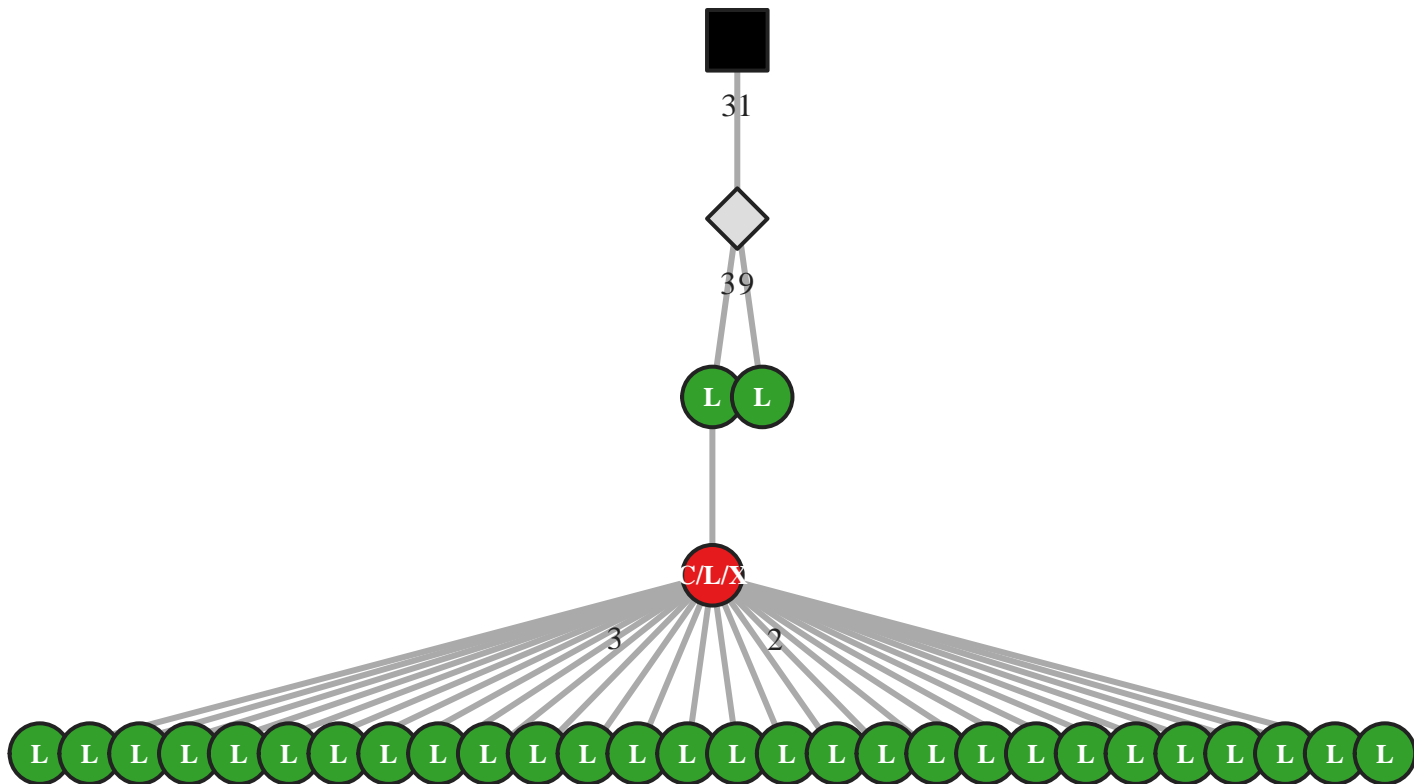

M5 IgG IGHV1-46/J6 60bp (4783)

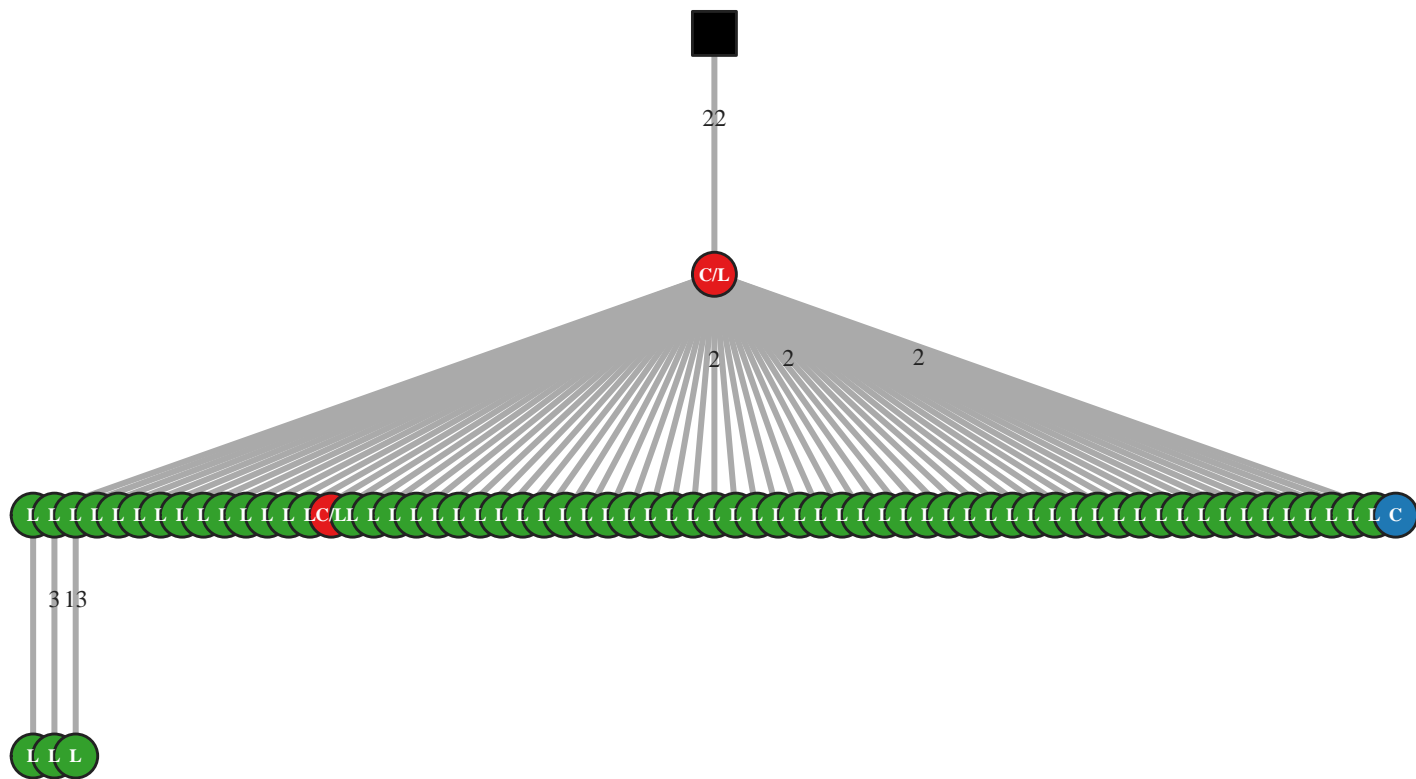

M5 IgG IGHV1-46/J6 66bp (23665)

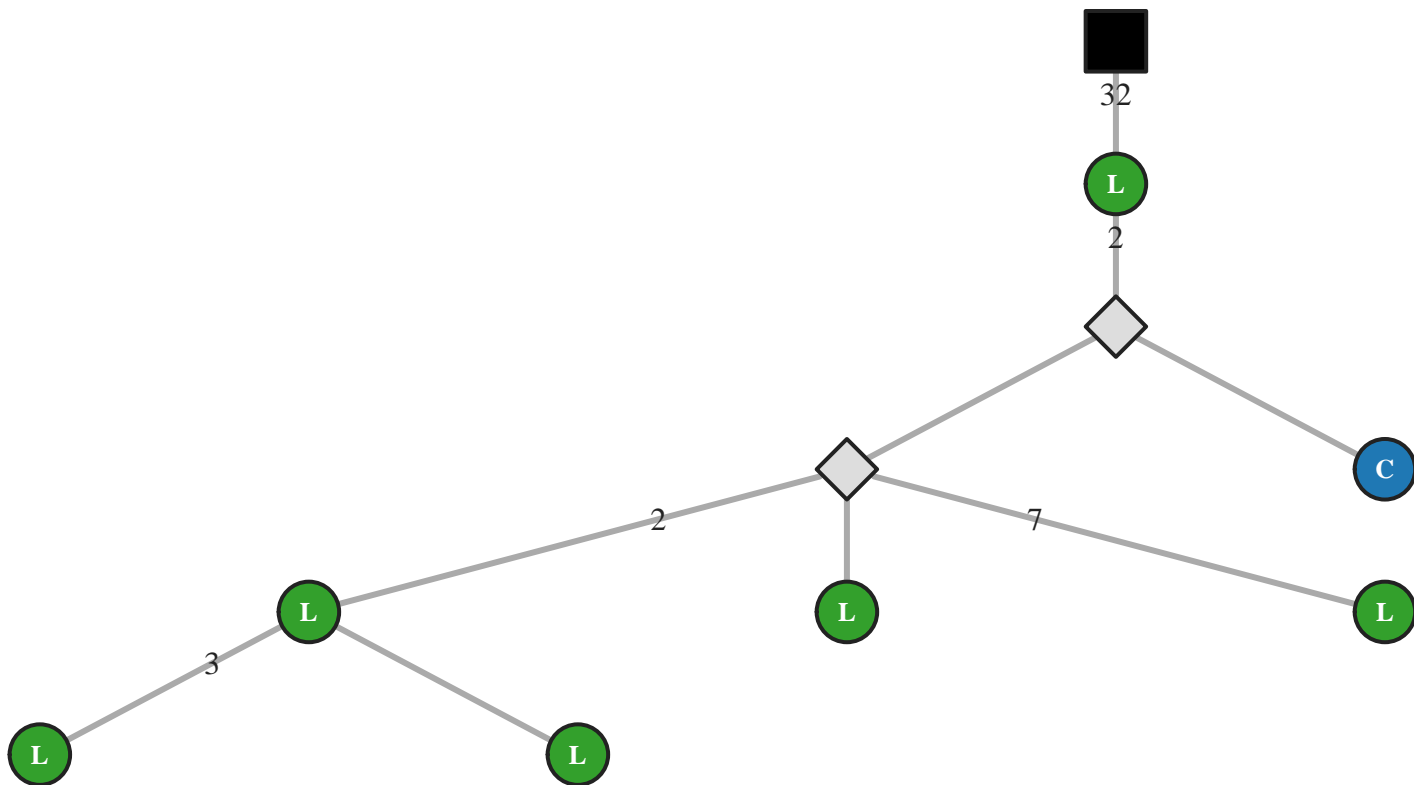

M5 IgG IGHV1-46/J6 69bp (14429)

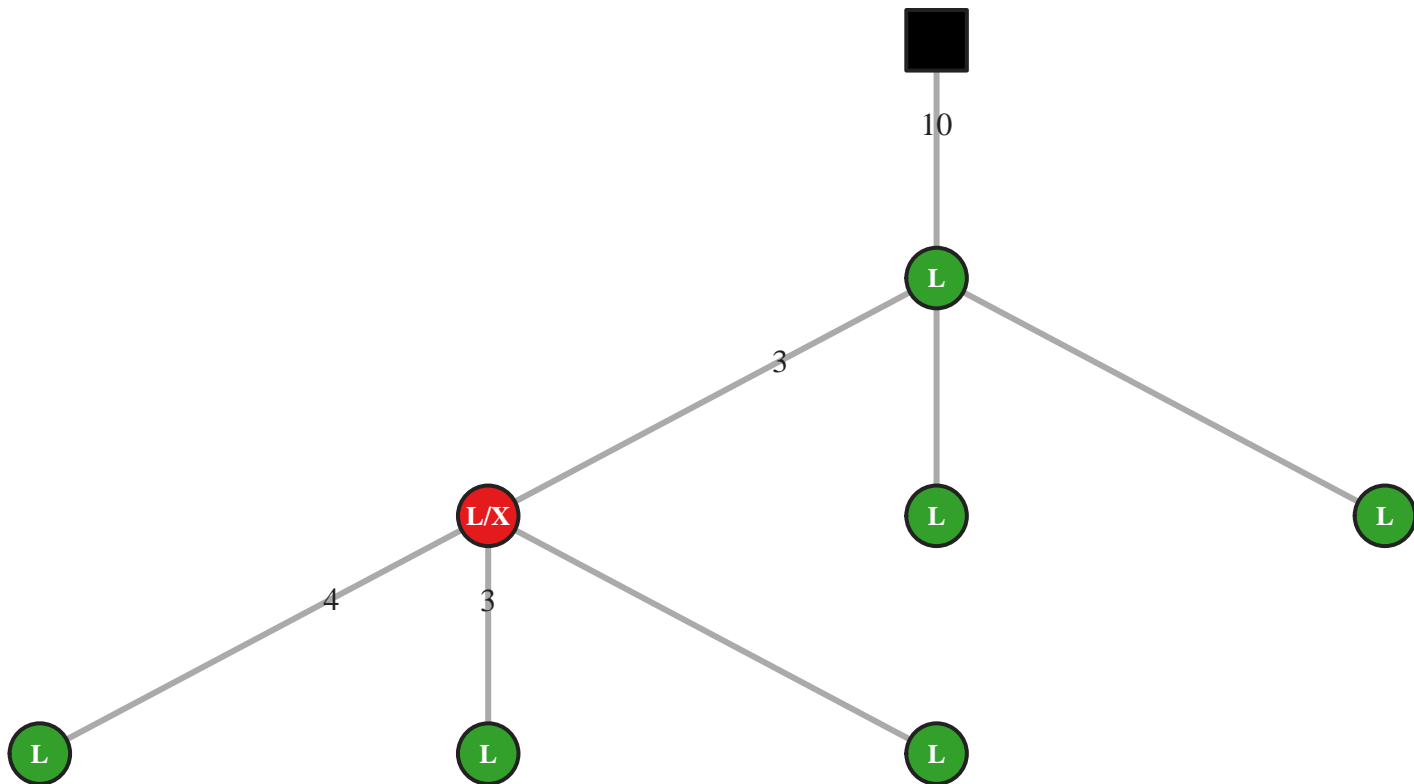

M5 IgA IGHV1-46/J6 72bp (2368)

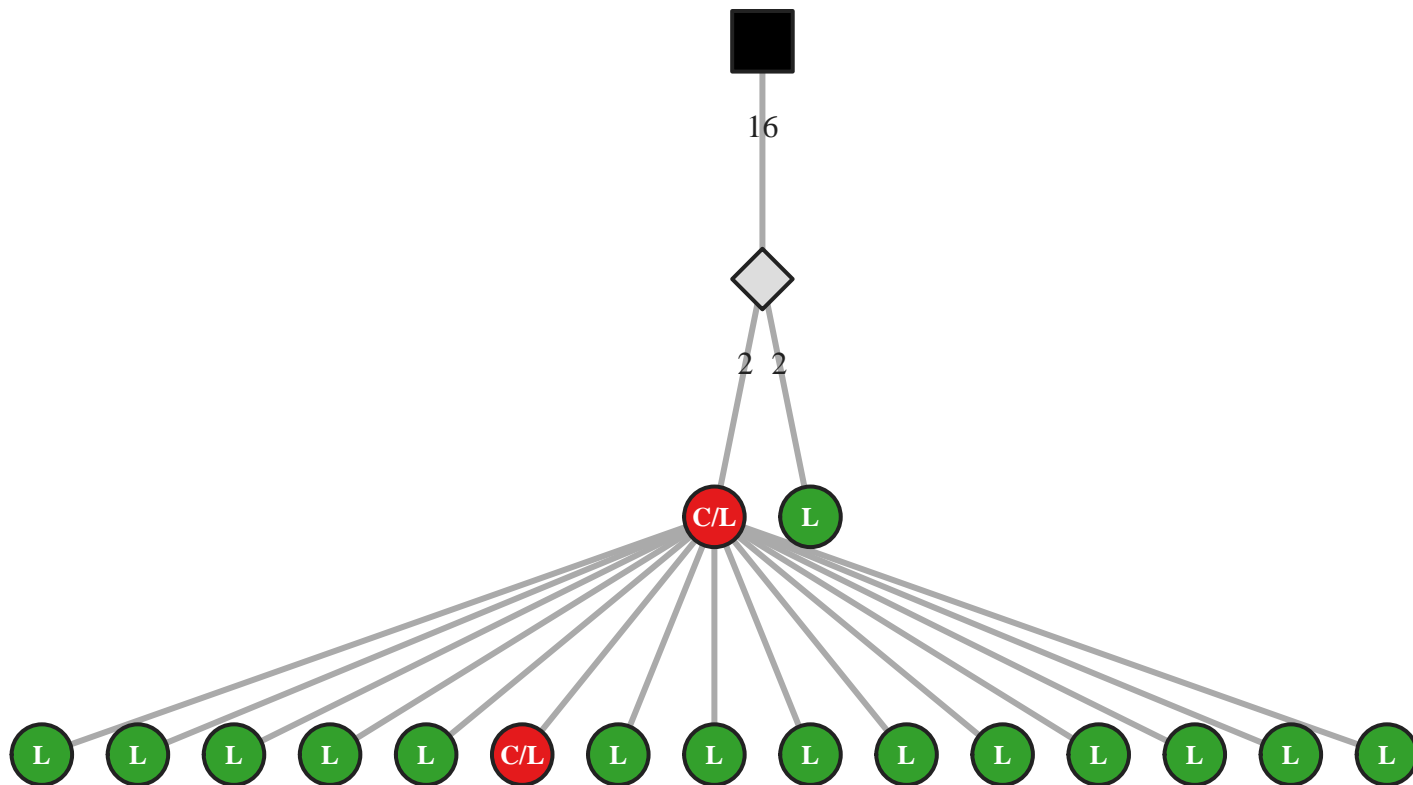

M5 IgA IGHV1-46/J6 75bp (21284)

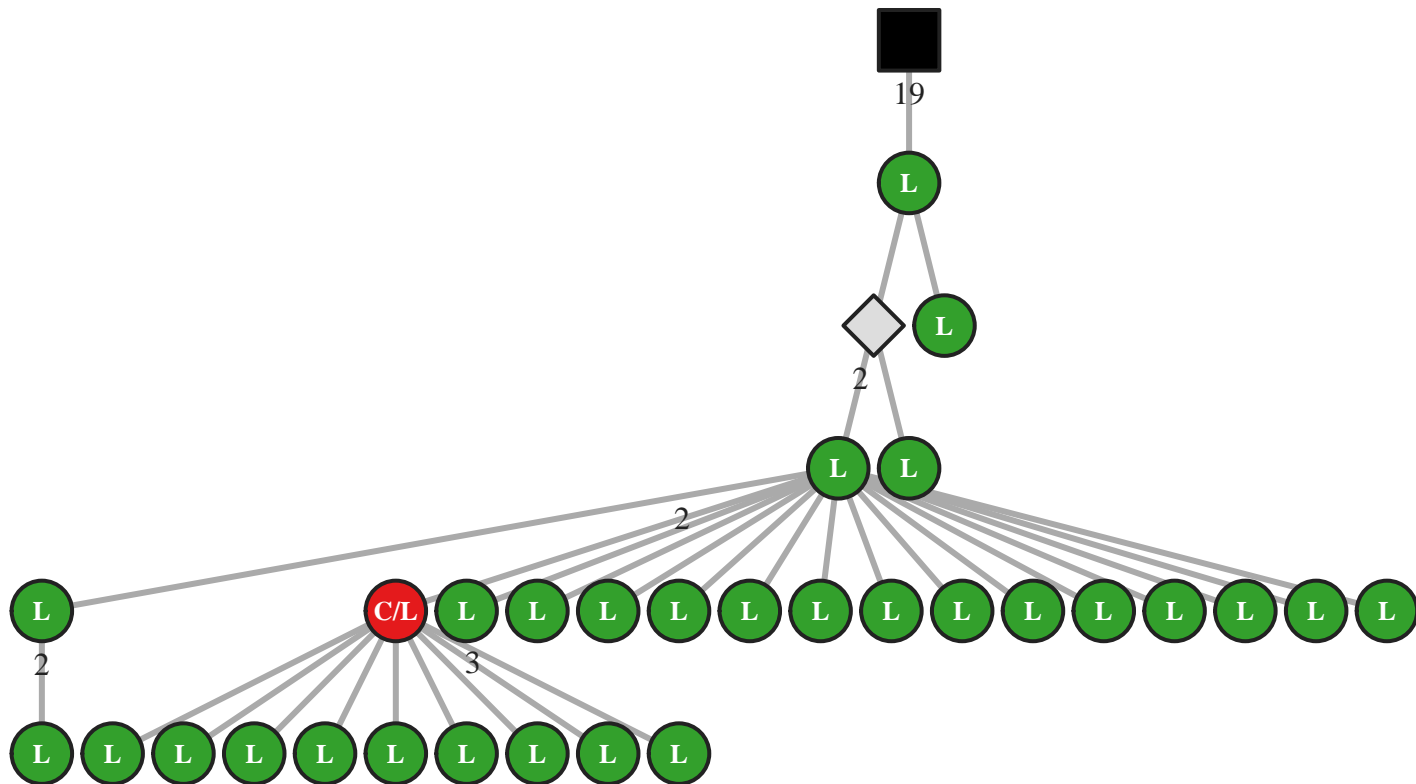

M5 IgG IGHV1-46/J6 78bp (50118)

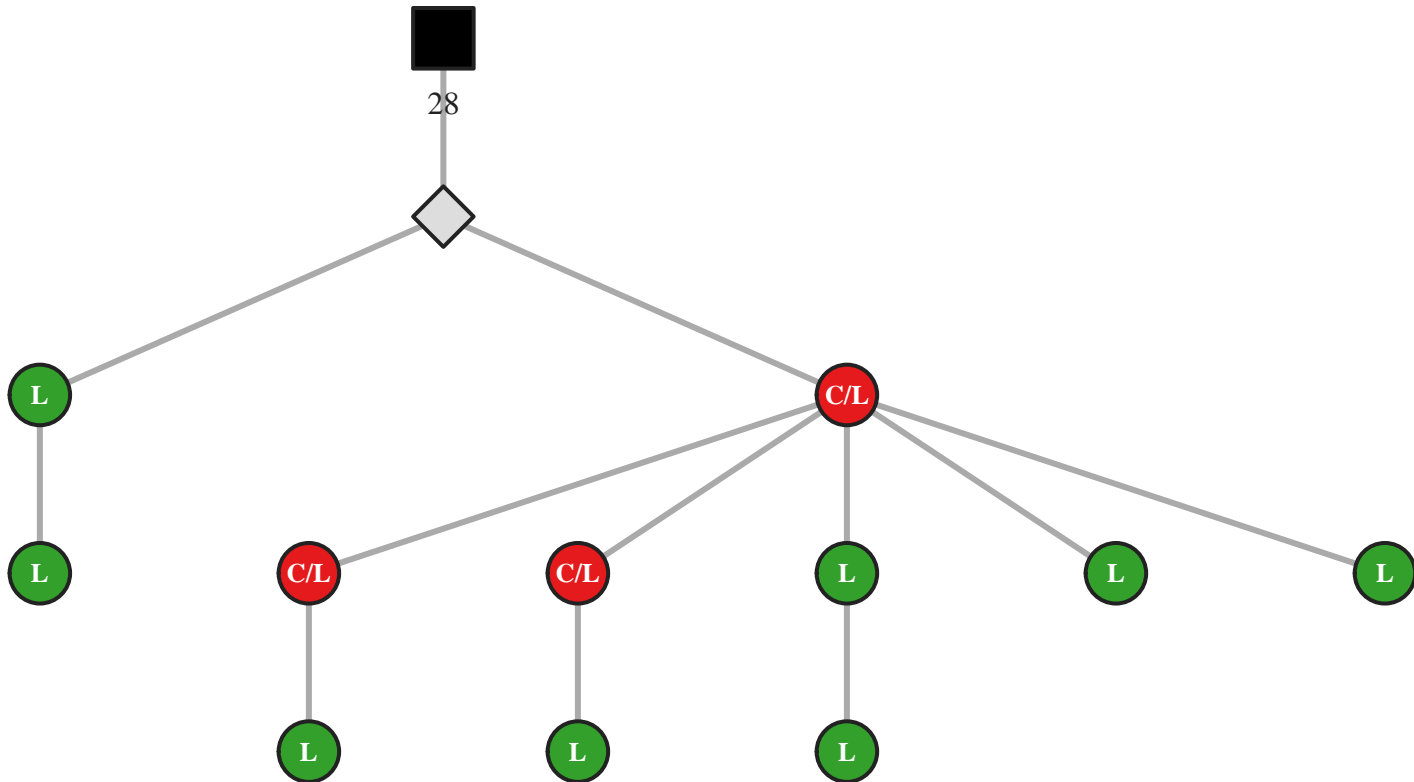

M5 IgG IGHV1-58/J3 45bp (23686)

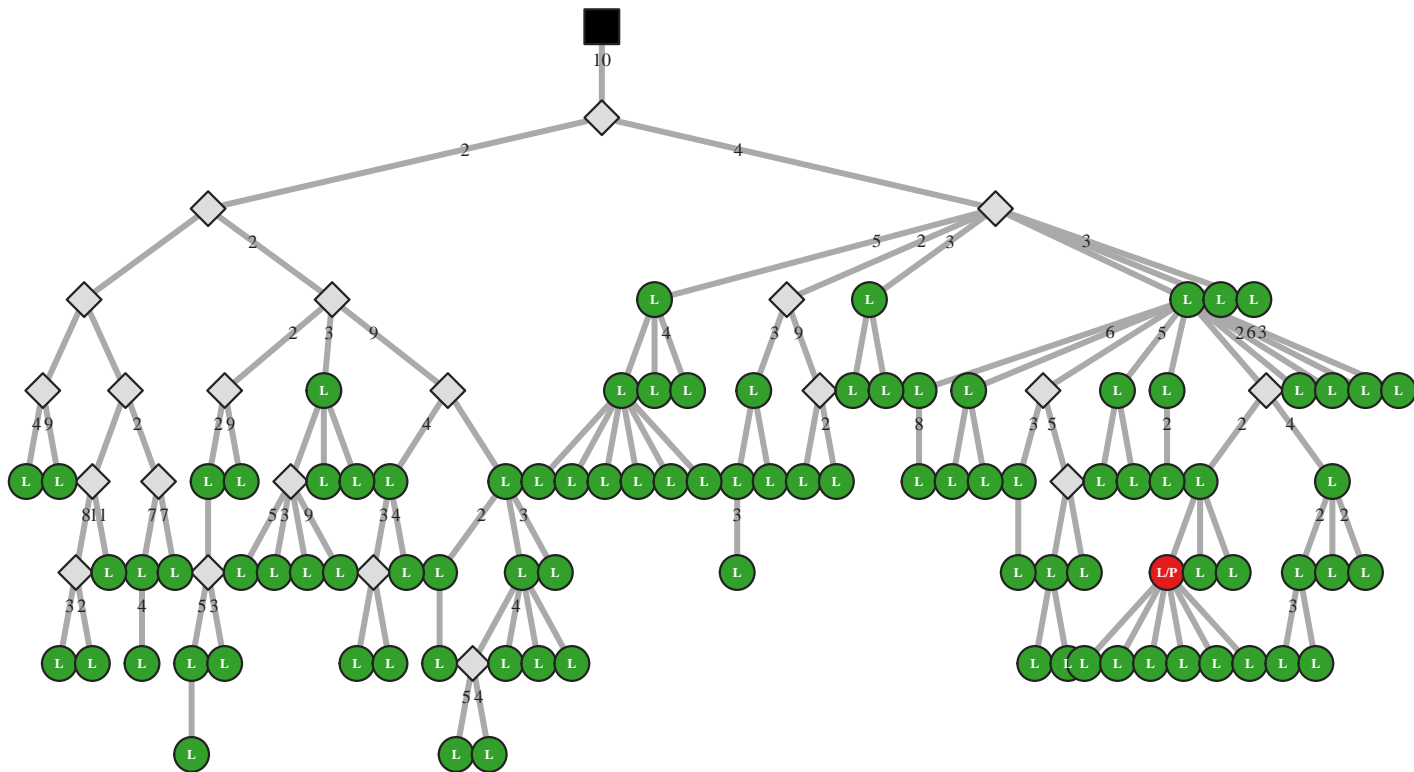

M5 IgG IGHV1-58/J3 54bp (14434)

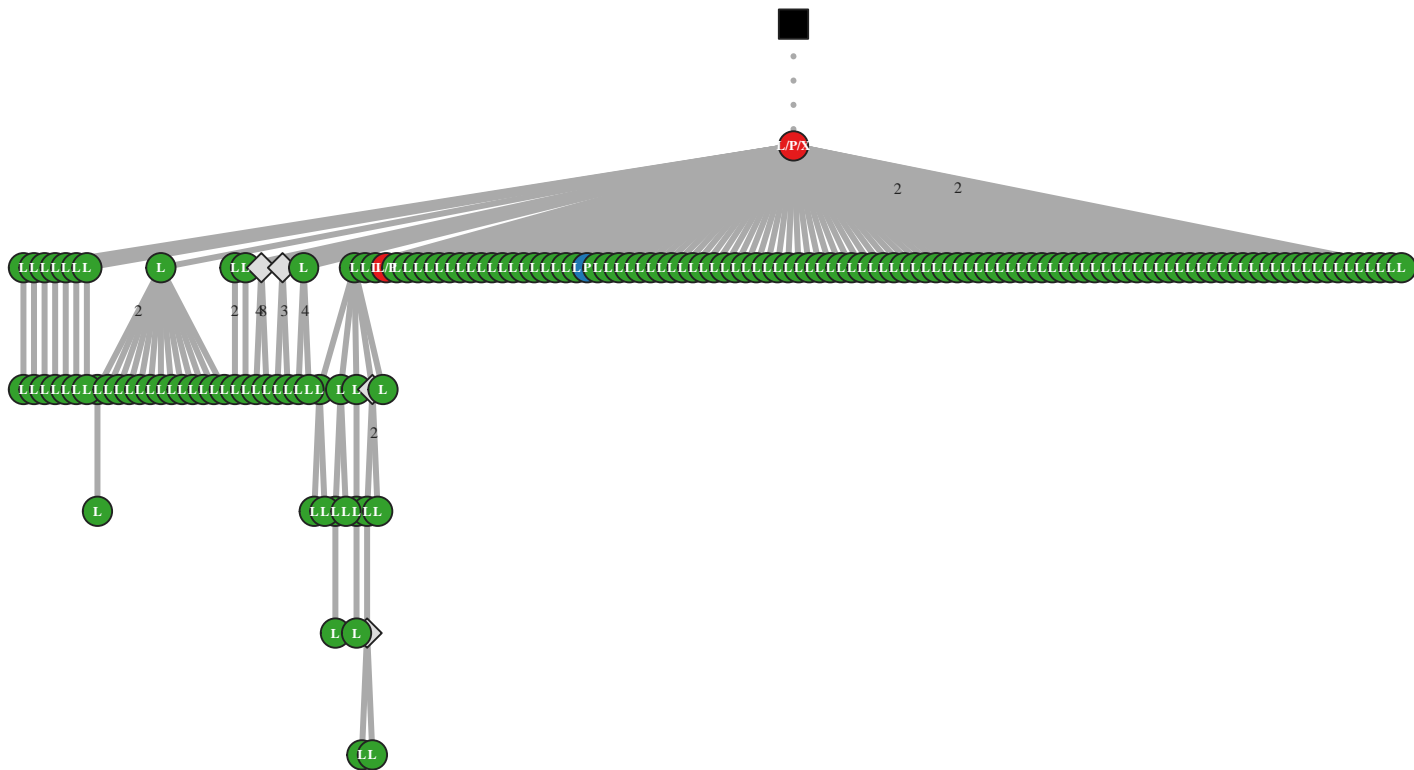

M5 IgG IGHV1-58/J3 60bp (4820)

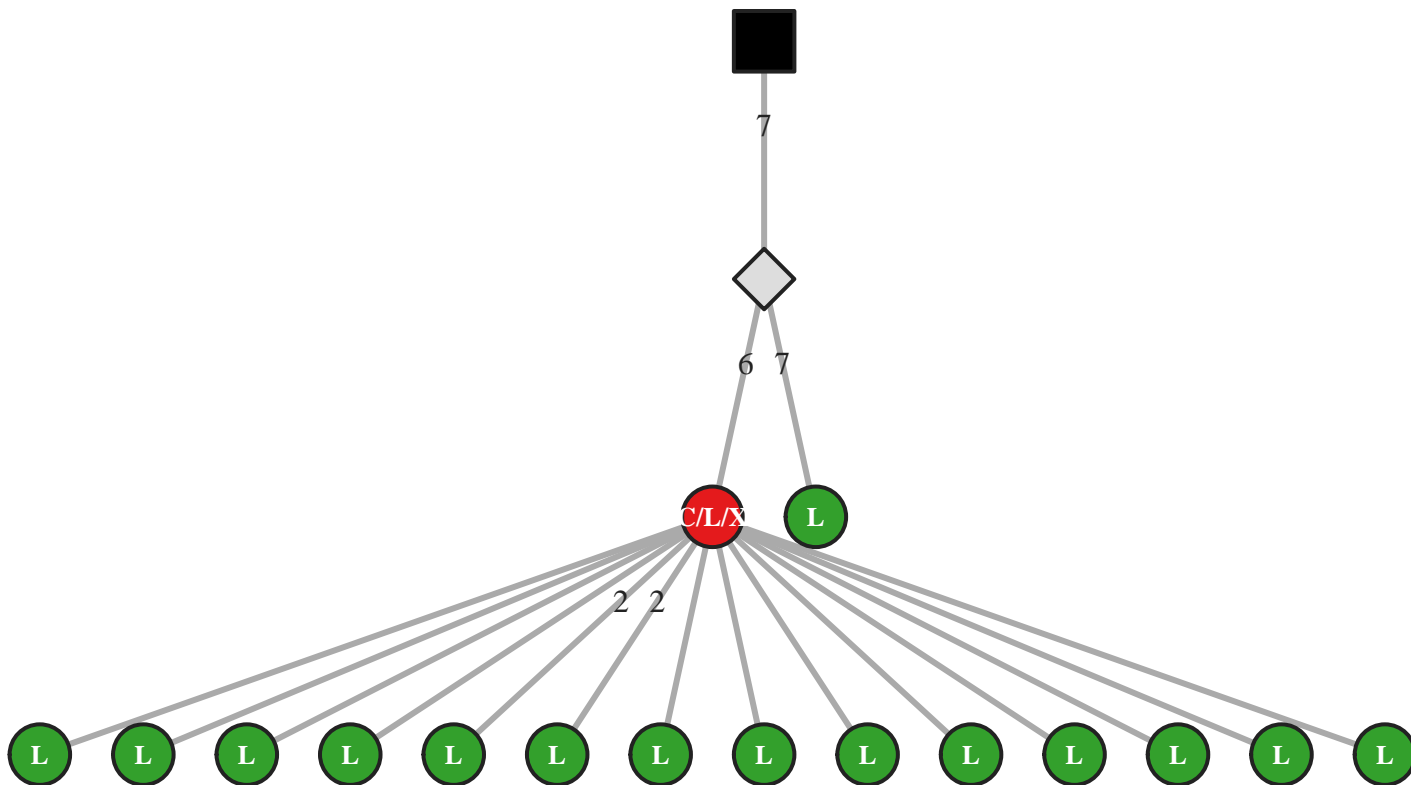

M5 IgG IGHV1-58/J4 42bp (14464)

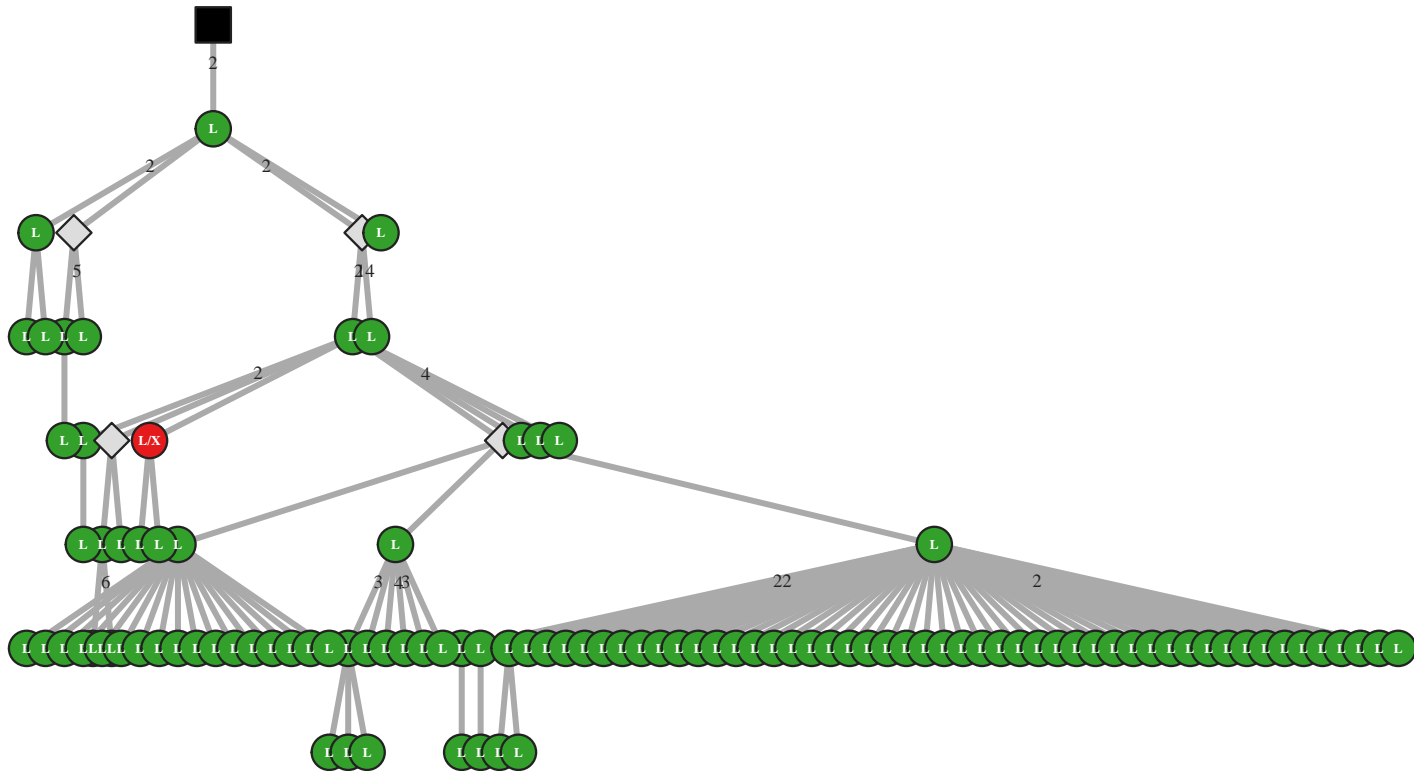

M5 IgG IGHV1-58/J4 45bp (23698)

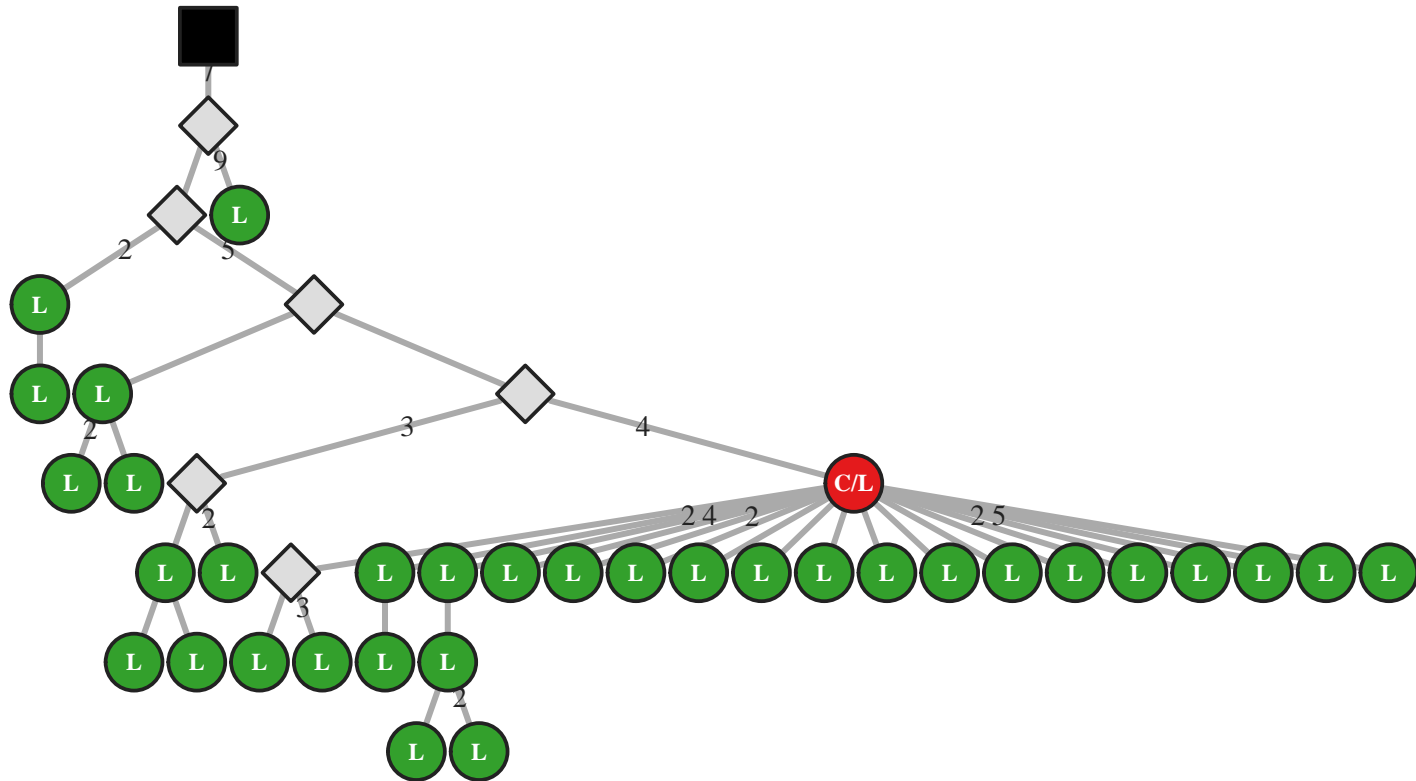

M5 IgG IGHV1-58/J4 72bp (4835)

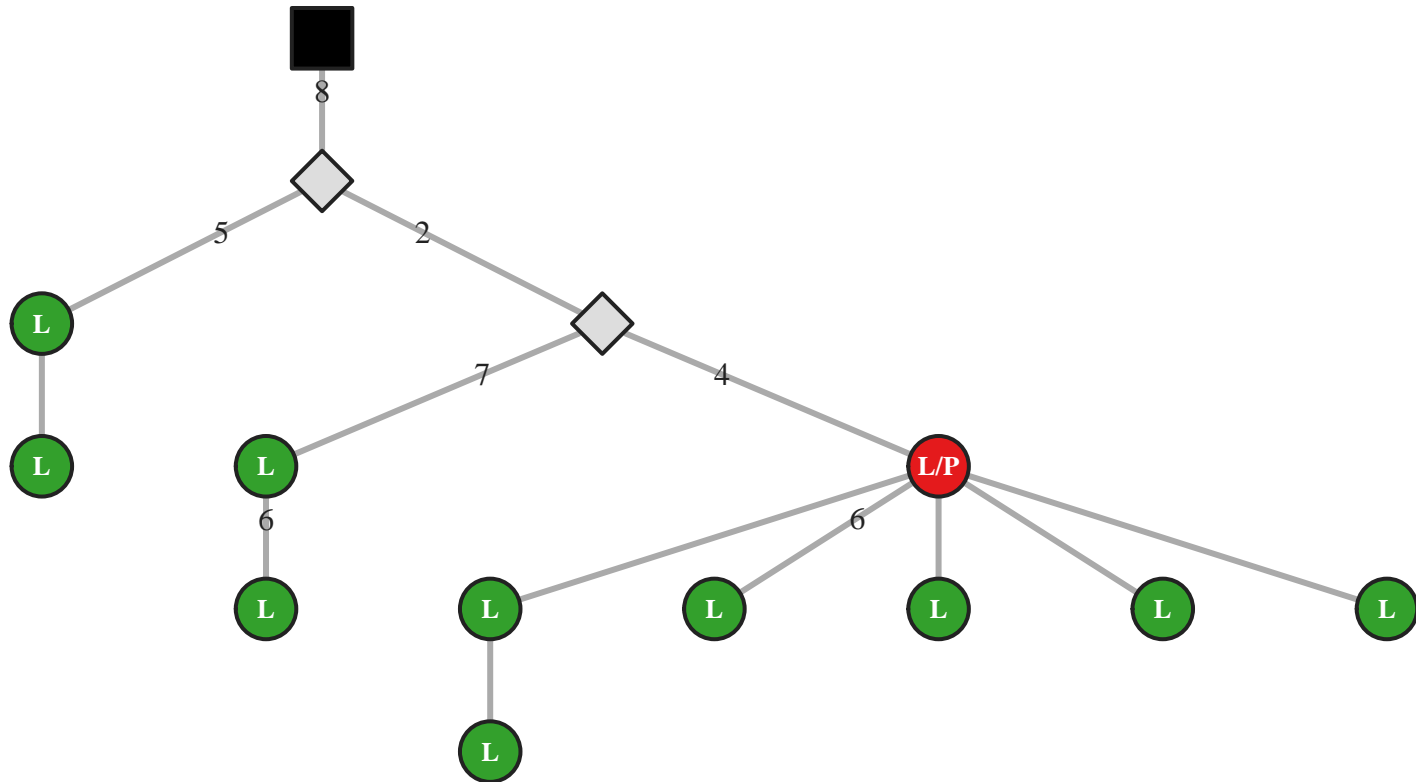

M5 IgG IGHV1-58/J5 63bp (4839)

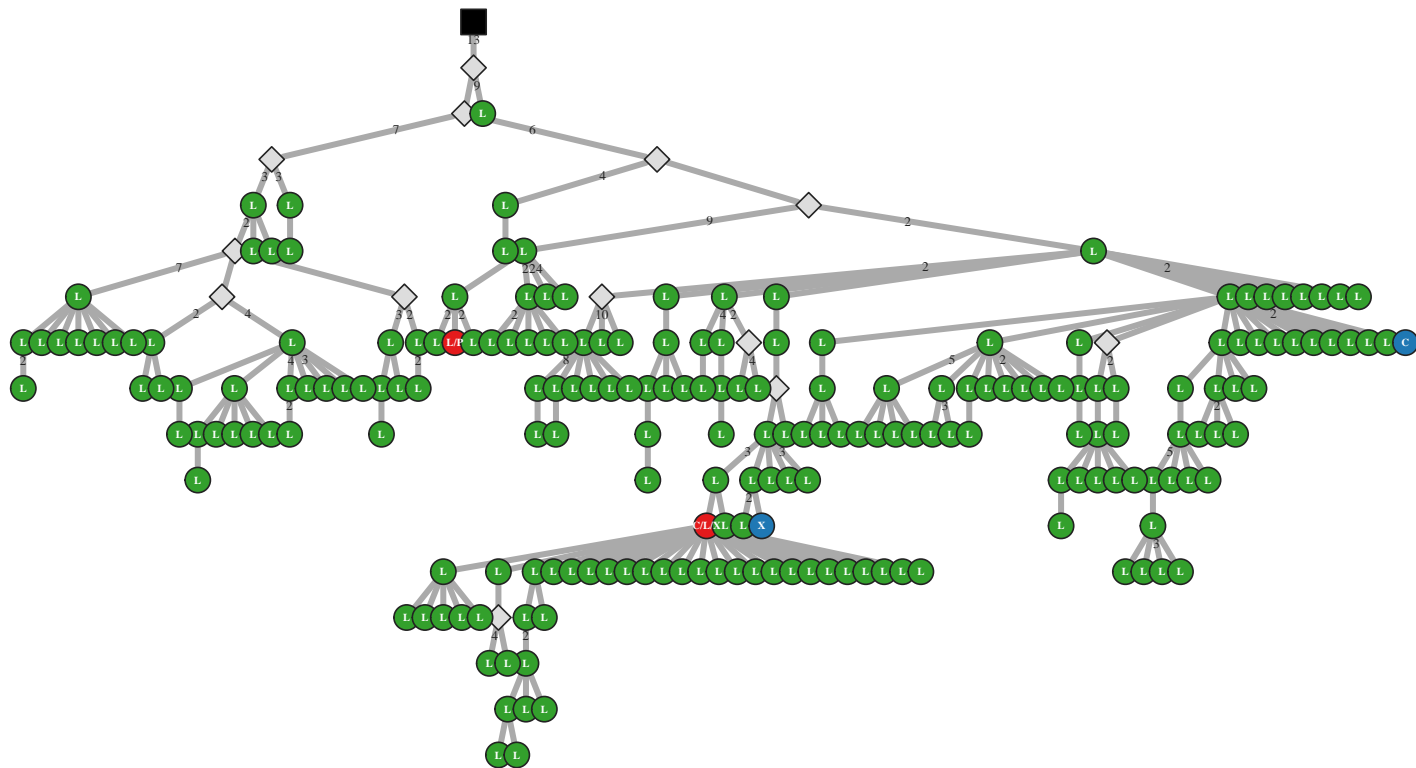

M5 IgG IGHV1-58/J6 69bp (14478)

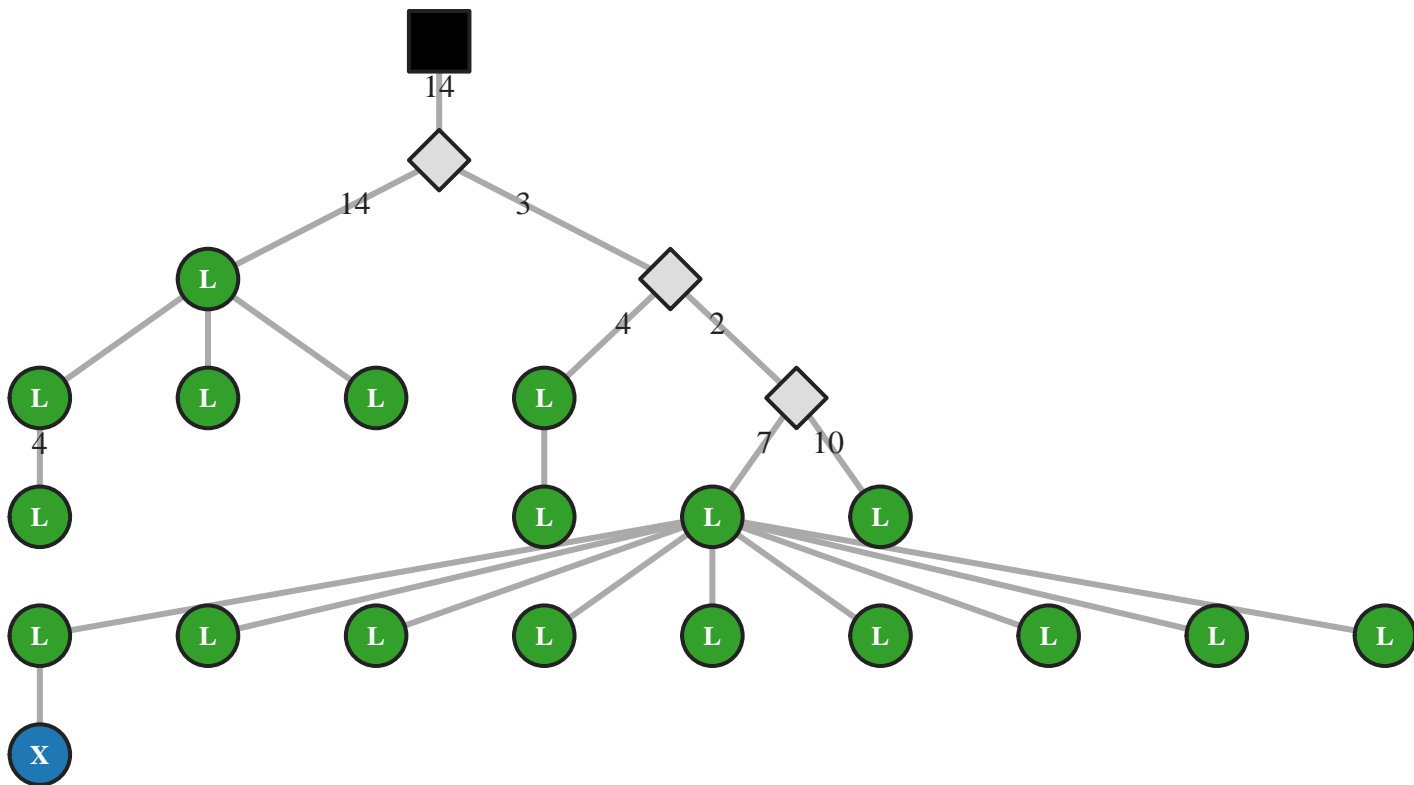

M5 IgG IGHV1-69/J1 39bp (40675)

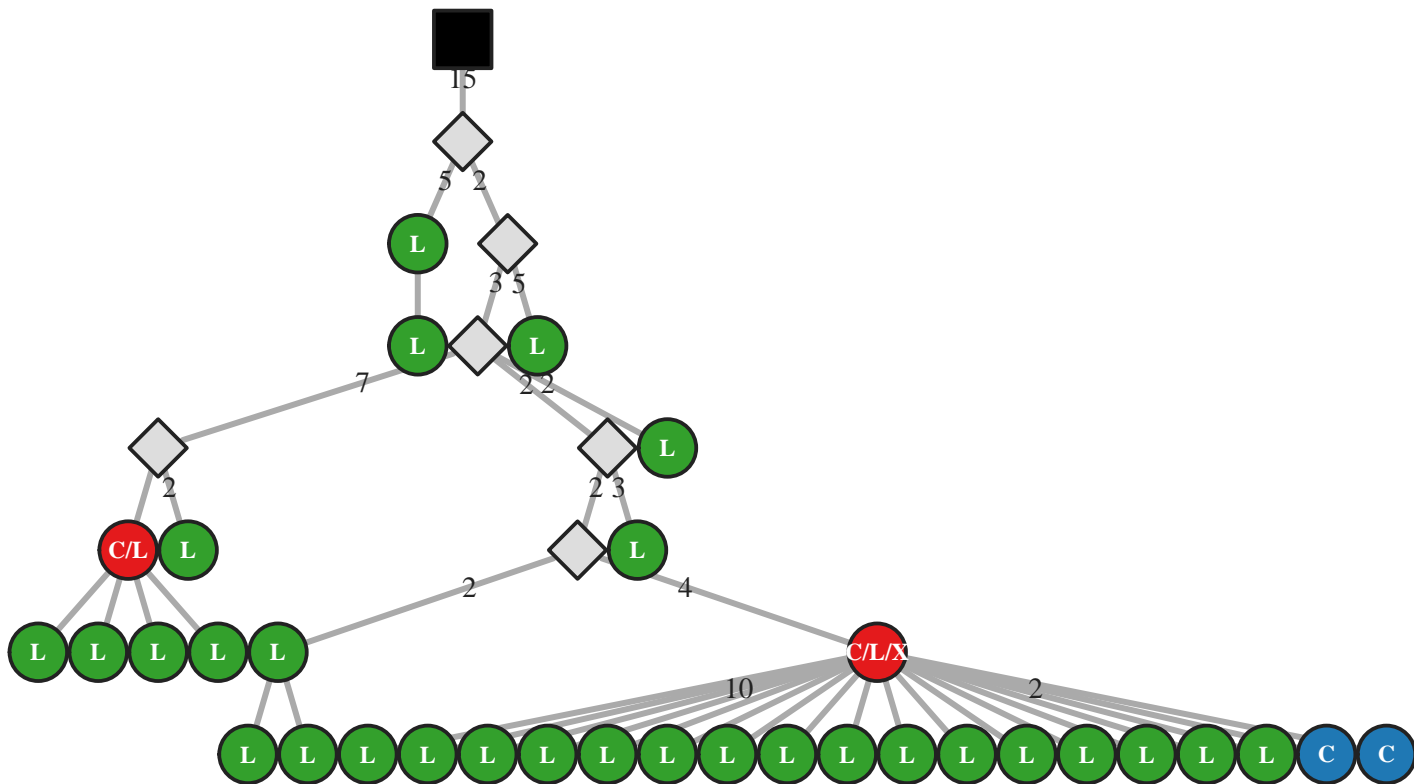

M5 IgG IGHV1-69/J1 42bp (4857)

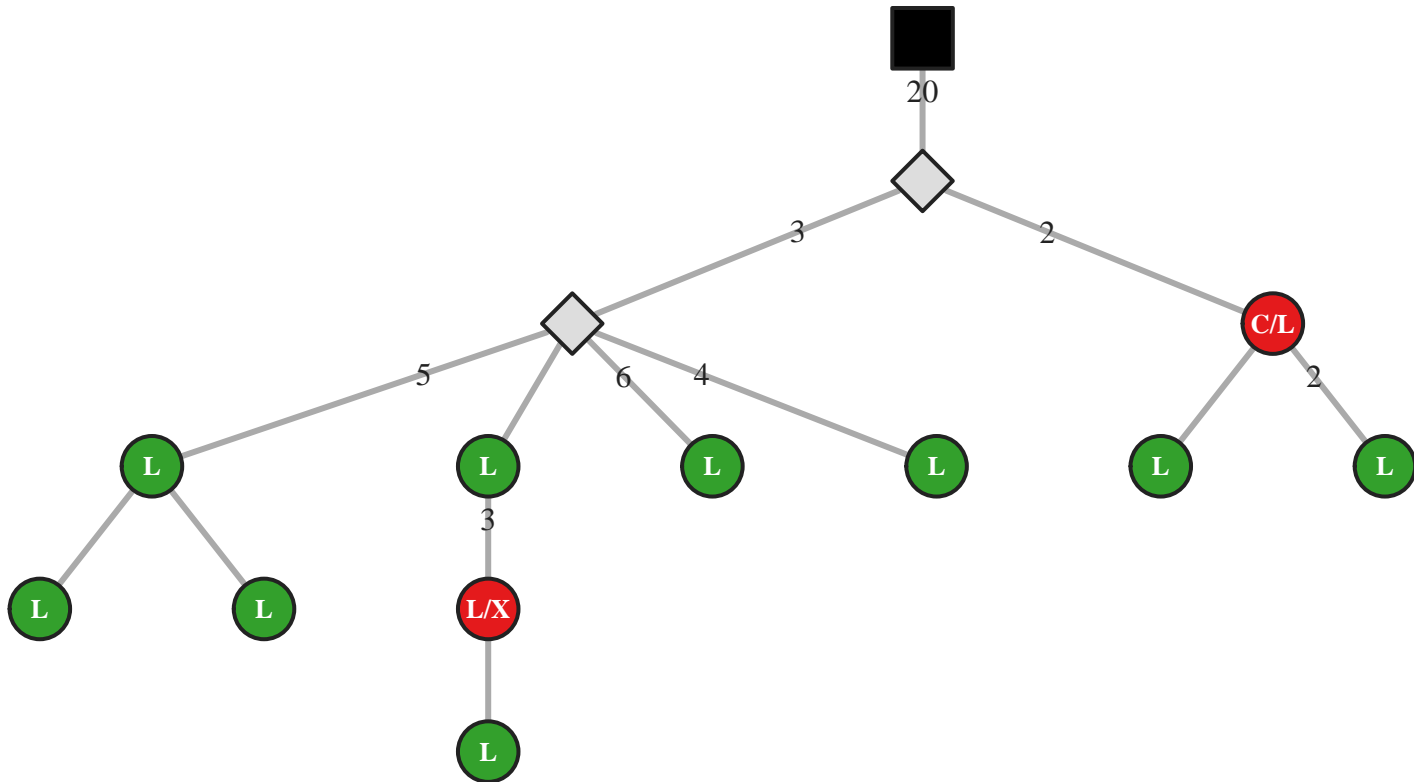

M5 IgG IGHV1-69/J1 51bp (50145)

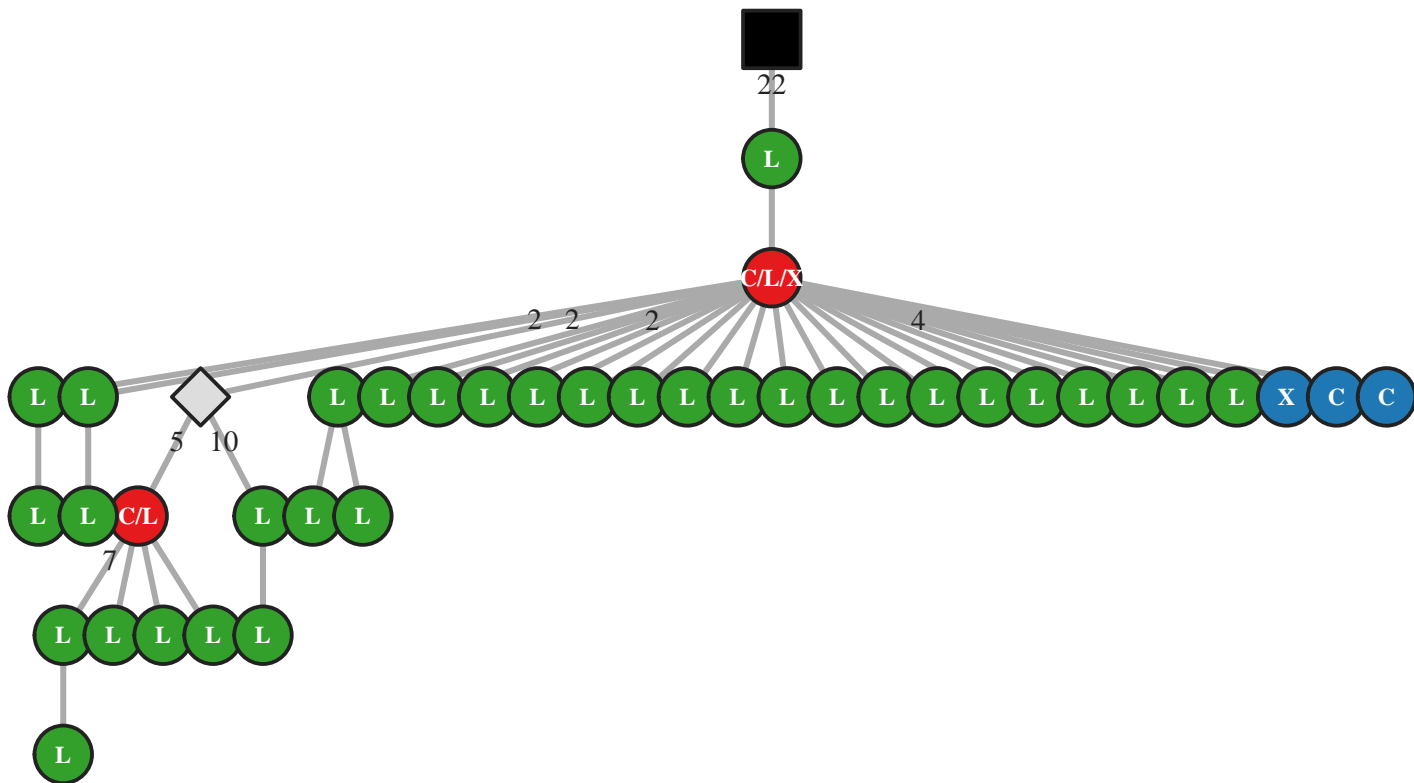

M5 IgG IGHV1-69/J1 54bp (14506)

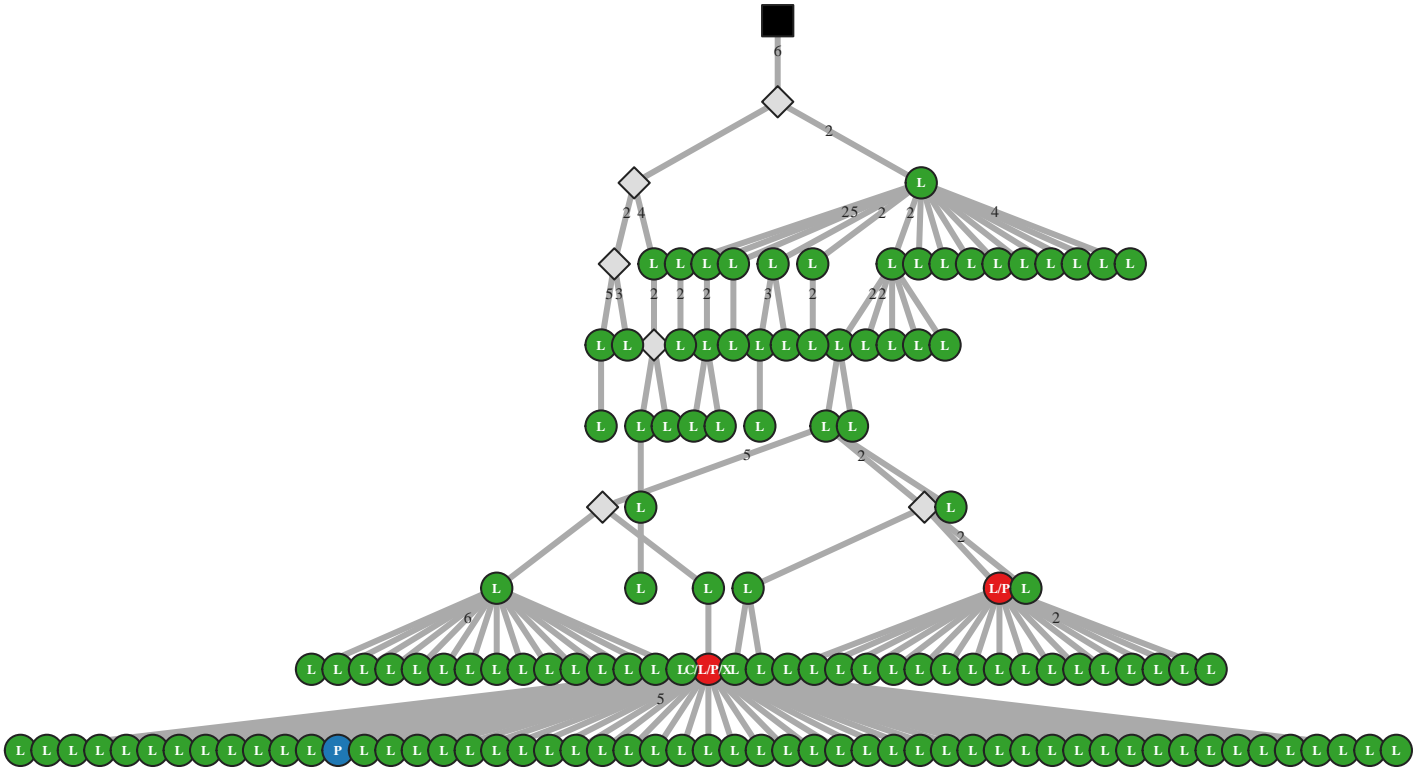

M5 IgG IGHV1-69/J2 36bp (23733)

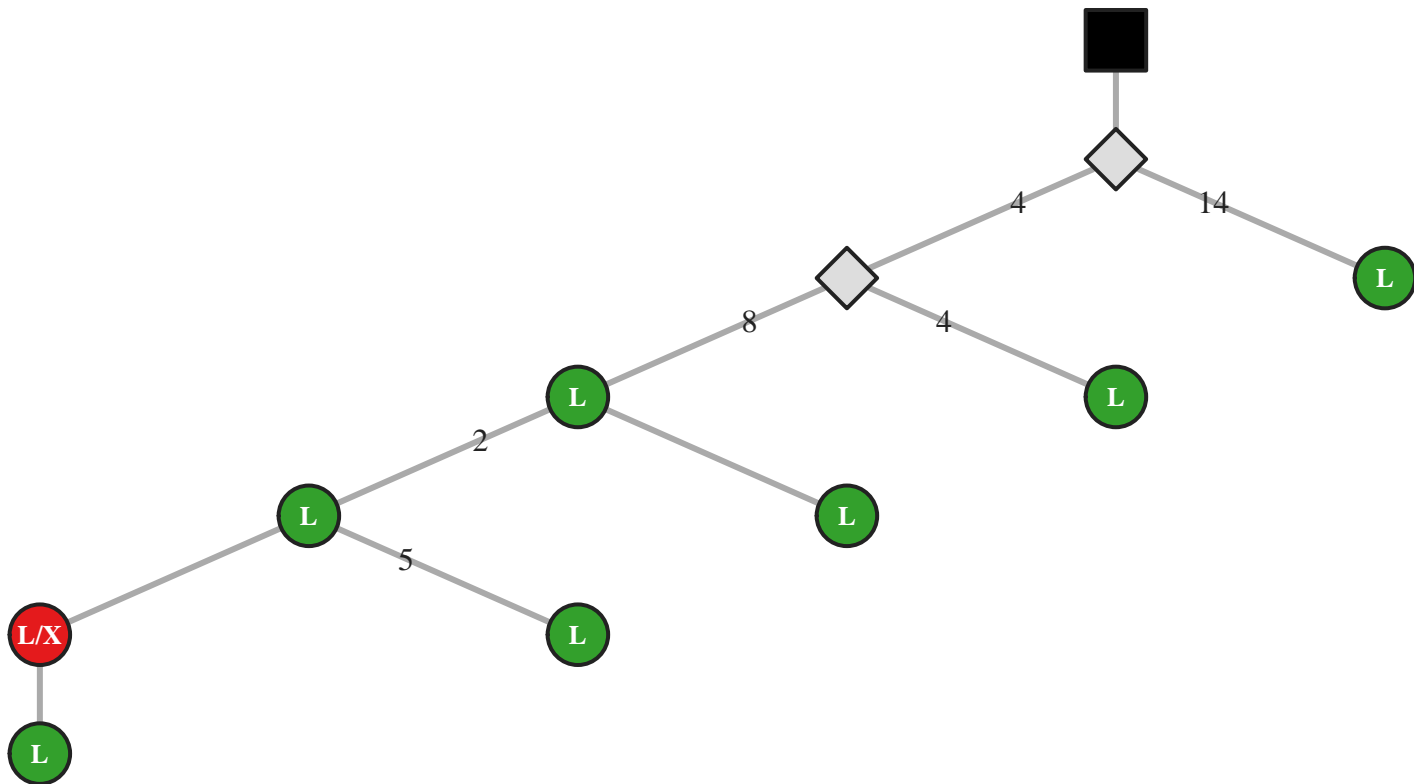

M5 IgG IGHV1-69/J2 45bp (32475)

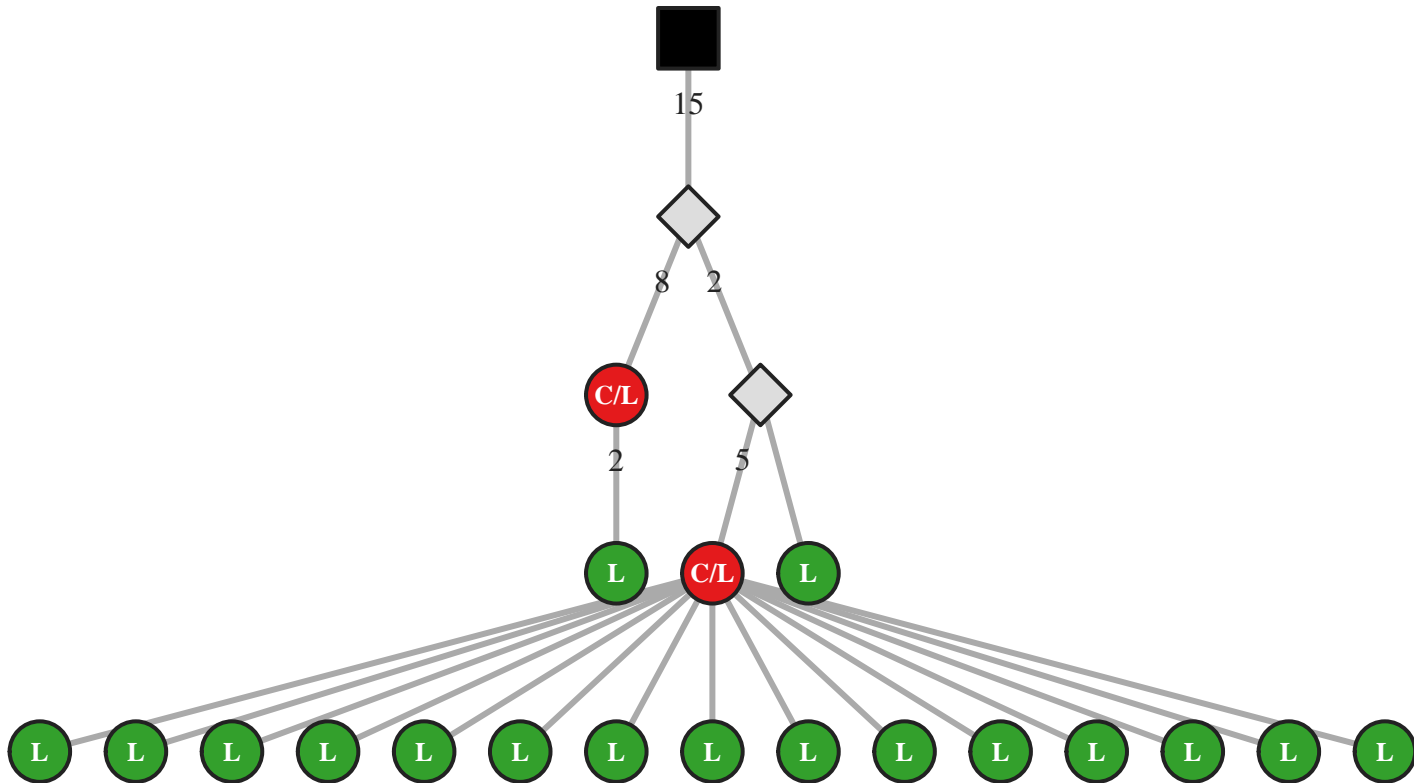

M5 IgG IGHV1-69/J2 45bp (32478)

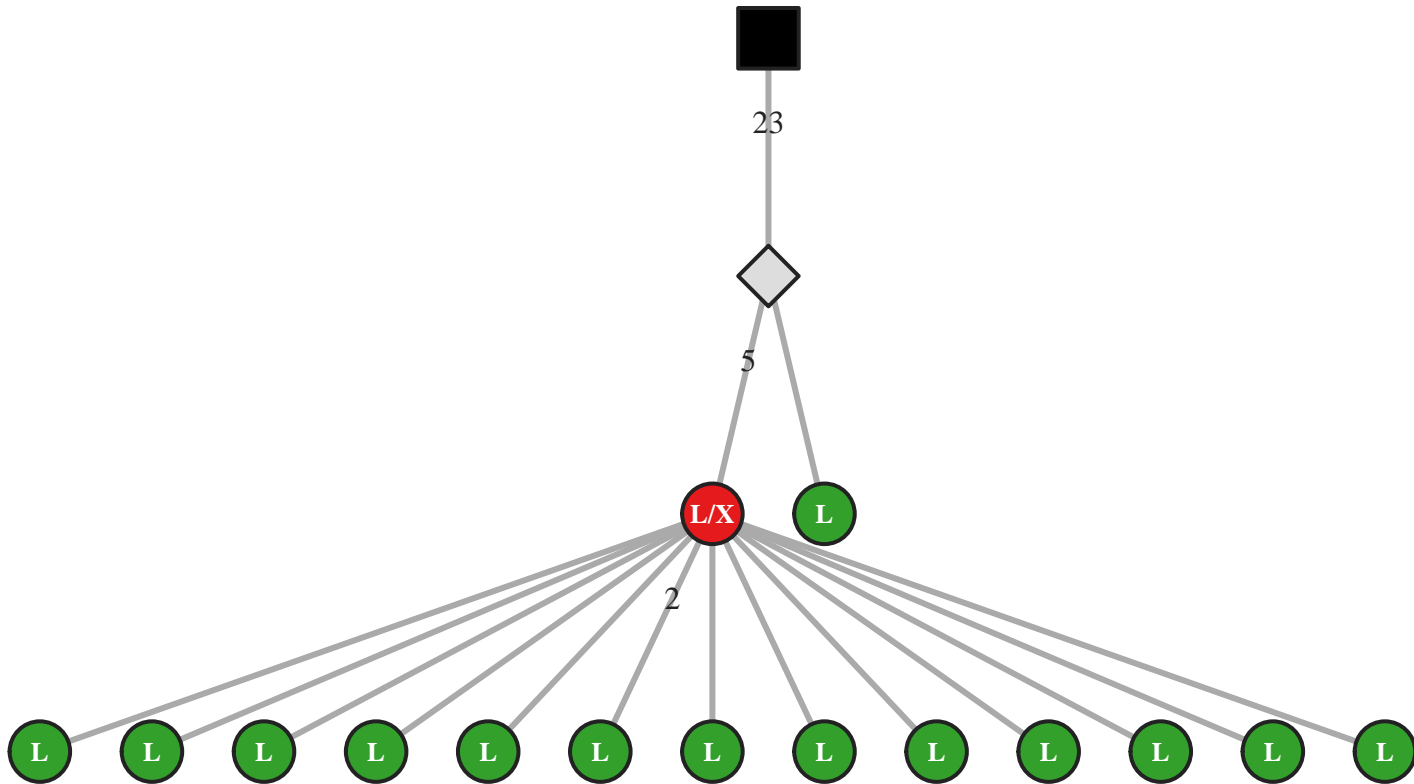

M5 IgG IGHV1-69/J2 48bp (50158)

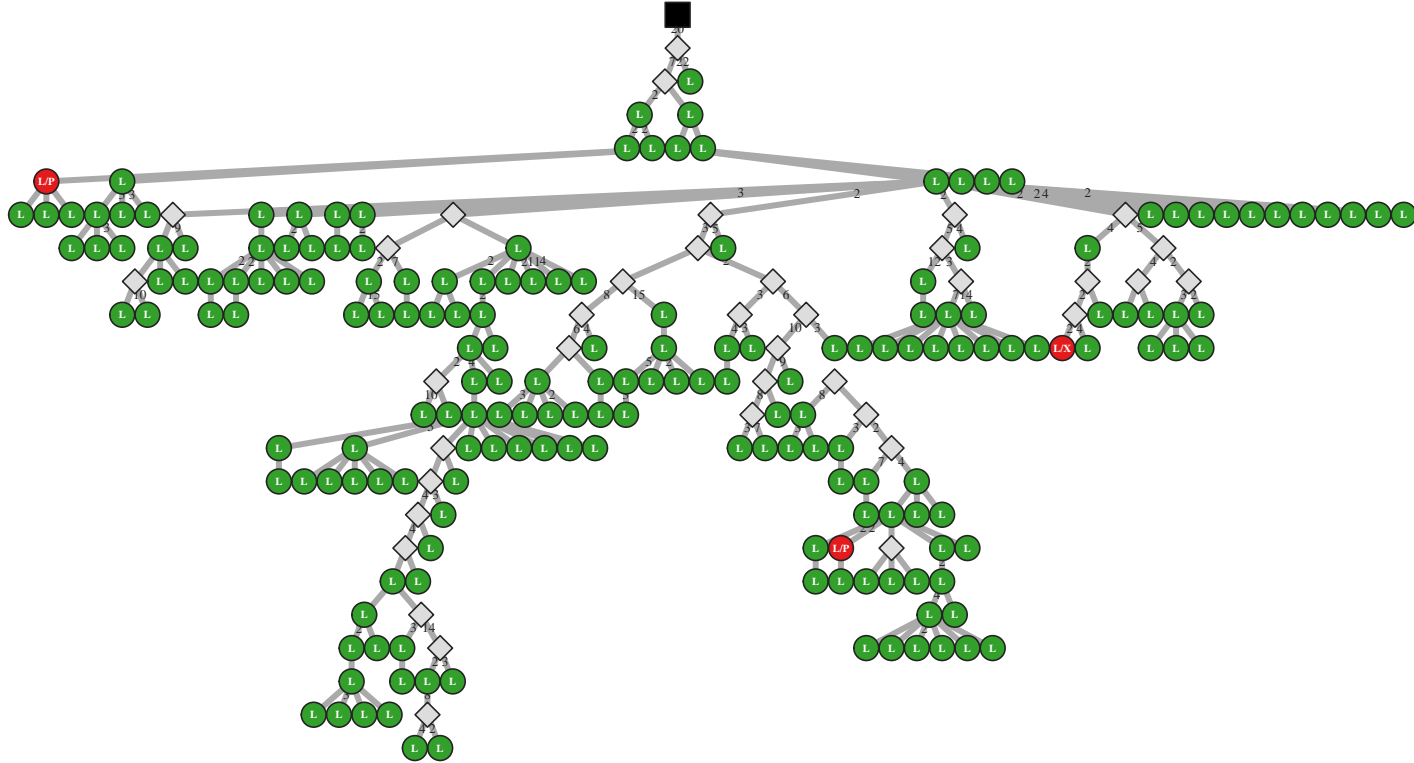

M5 IgG IGHV1-69/J2 51bp (4887)

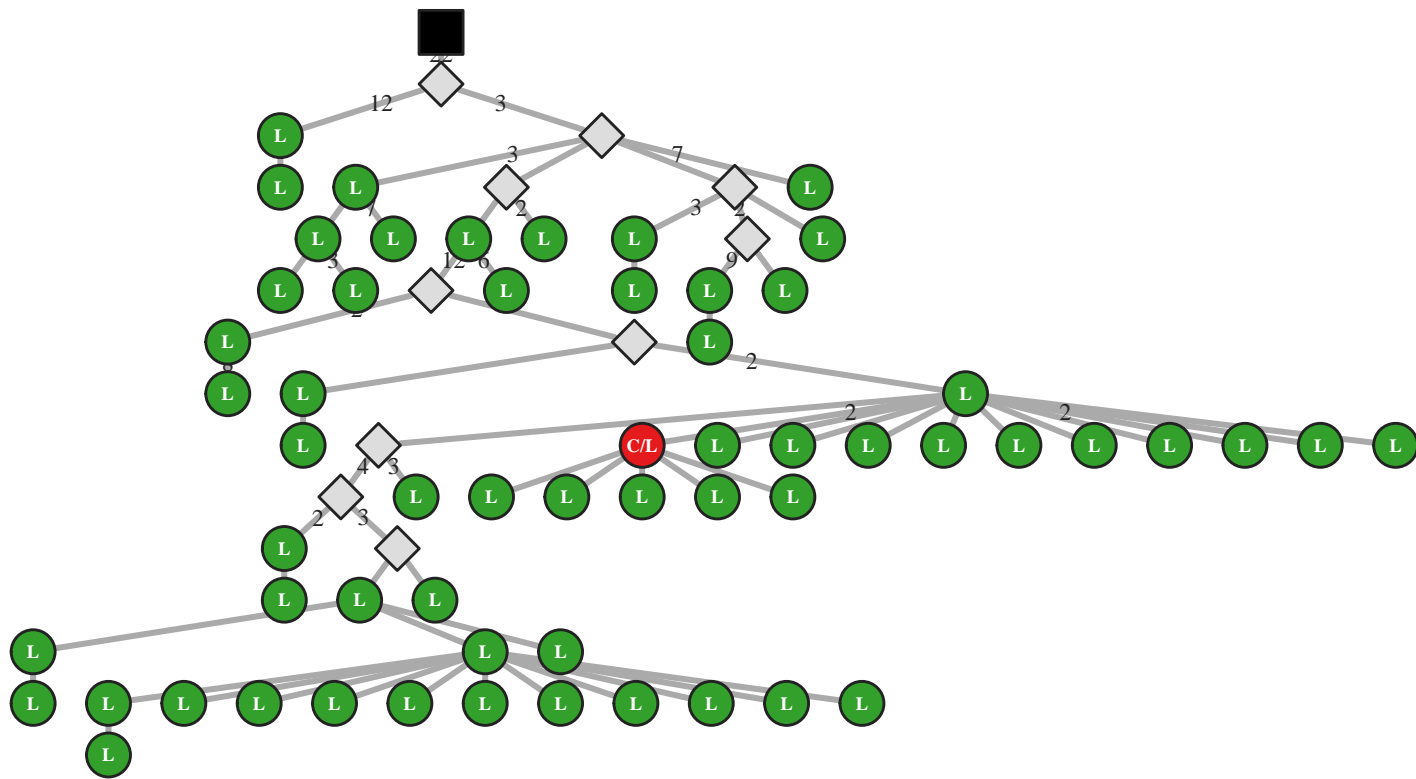

M5 IgG IGHV1-69/J2 60bp (50169)

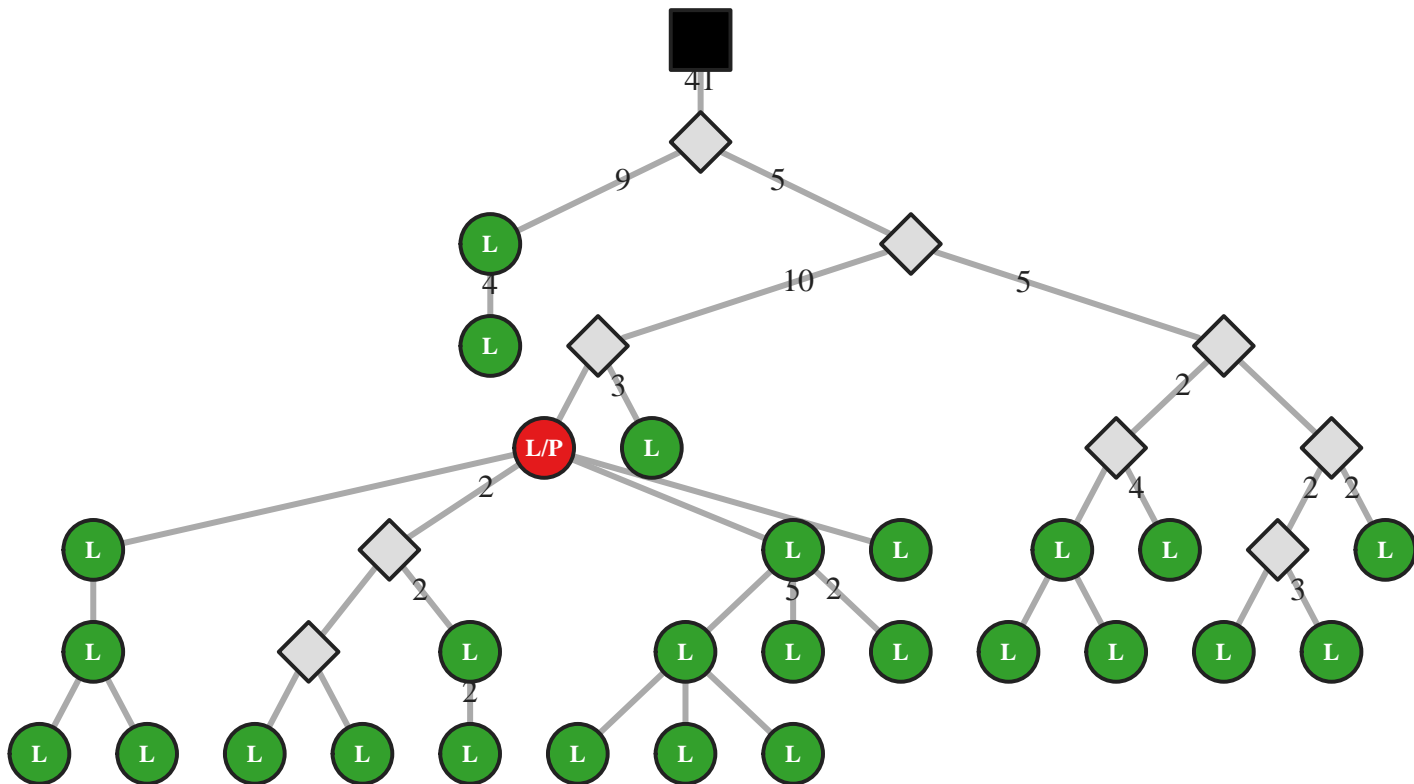

M5 IgG IGHV1-69/J3 33bp (50184)

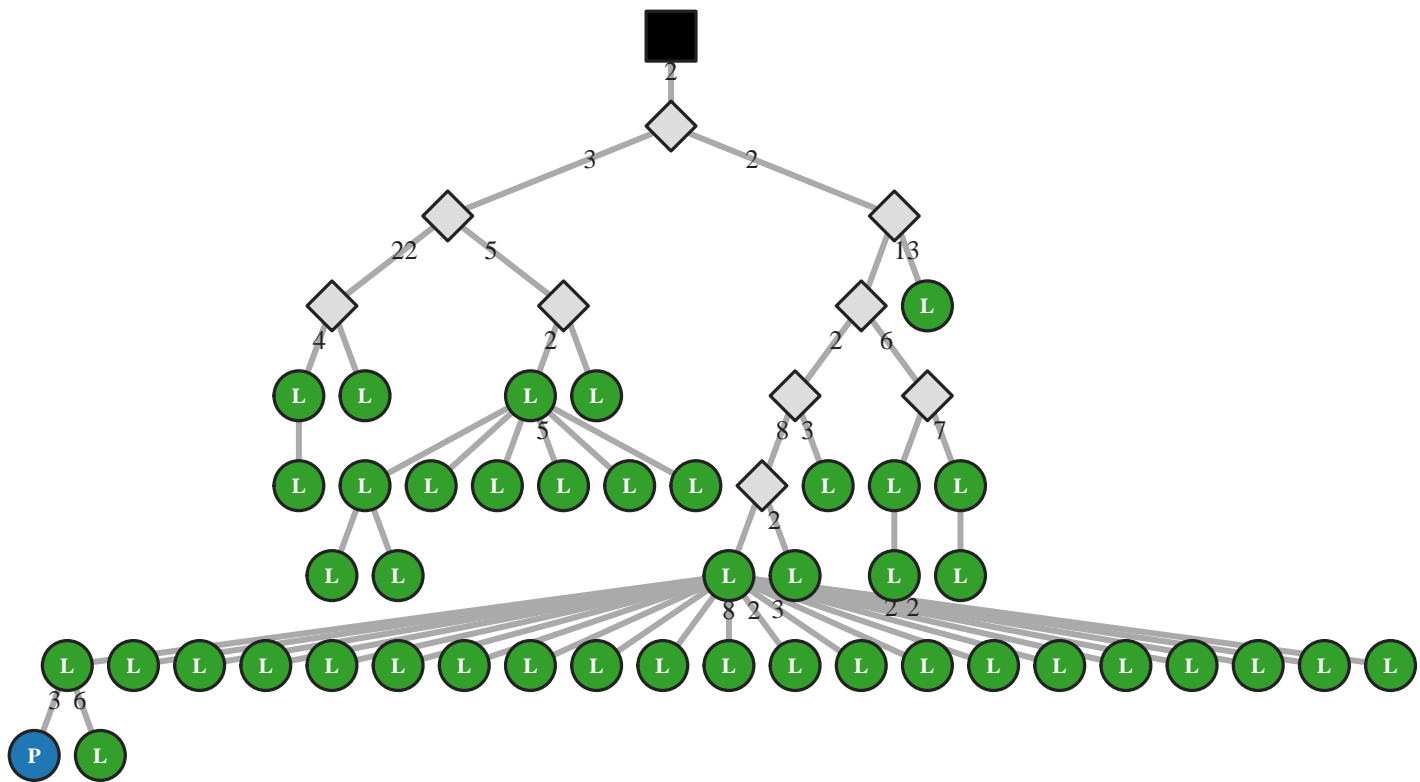

M5 IgG IGHV1-69/J3 36bp (40698)

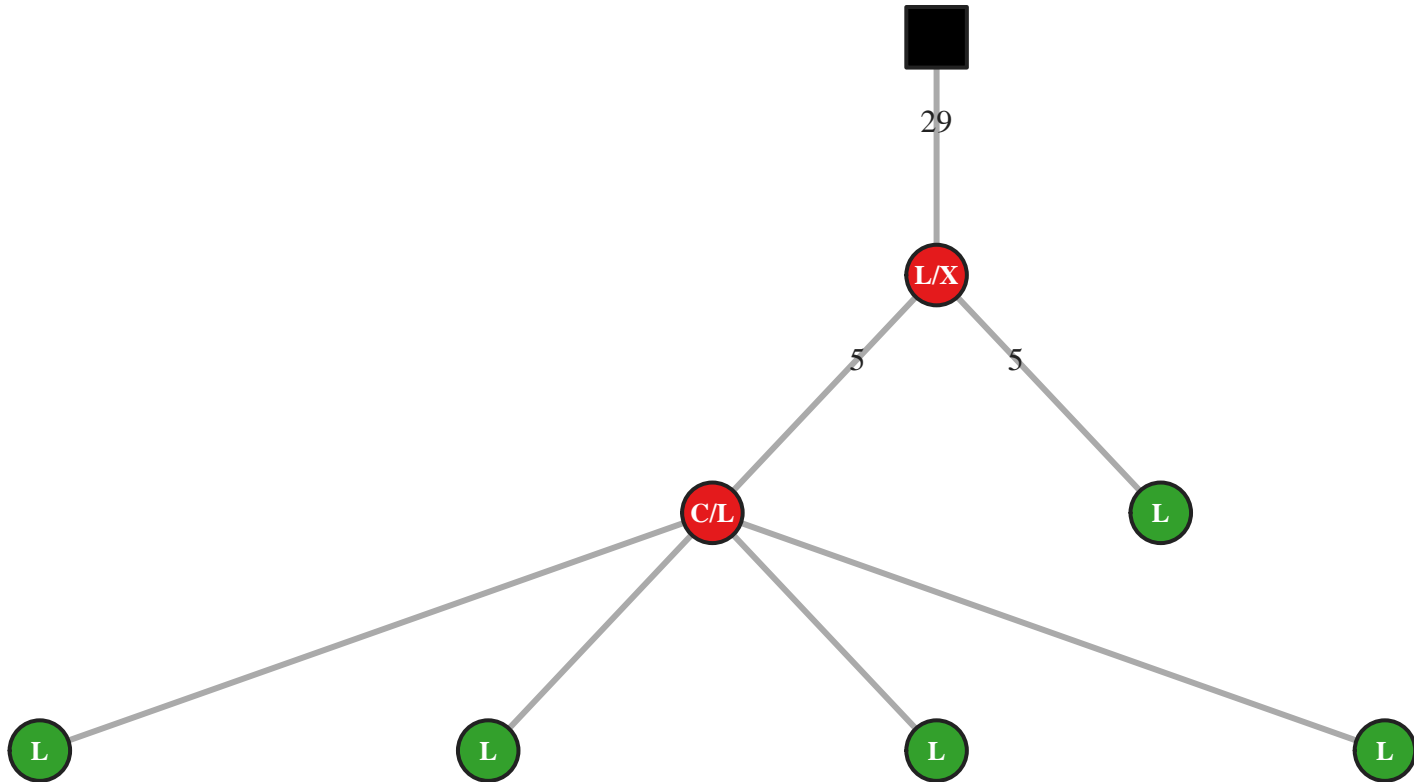

M5 IgG IGHV1-69/J3 42bp (4931)

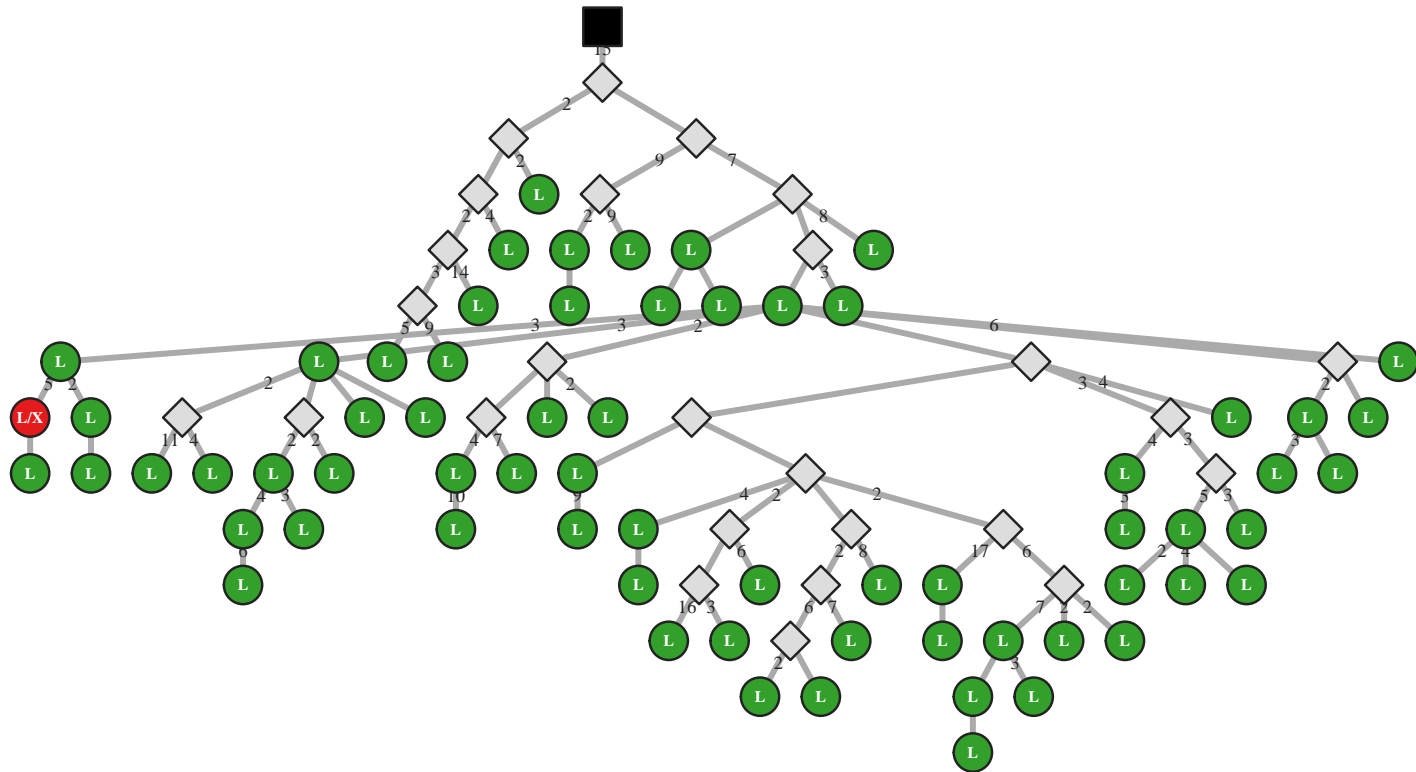

M5 IgG IGHV1-69/J3 42bp (4964)

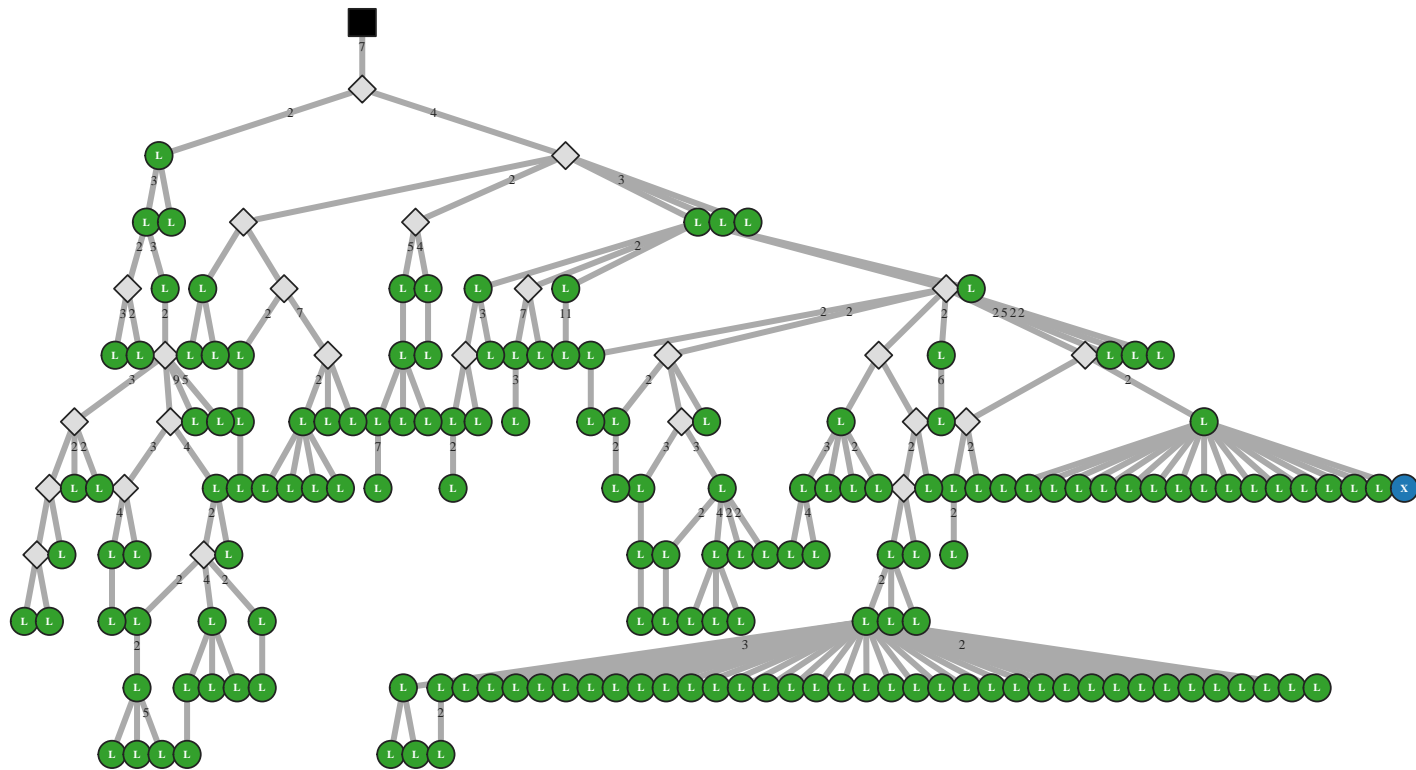

M5 IgG IGHV1-69/J3 42bp (4966)

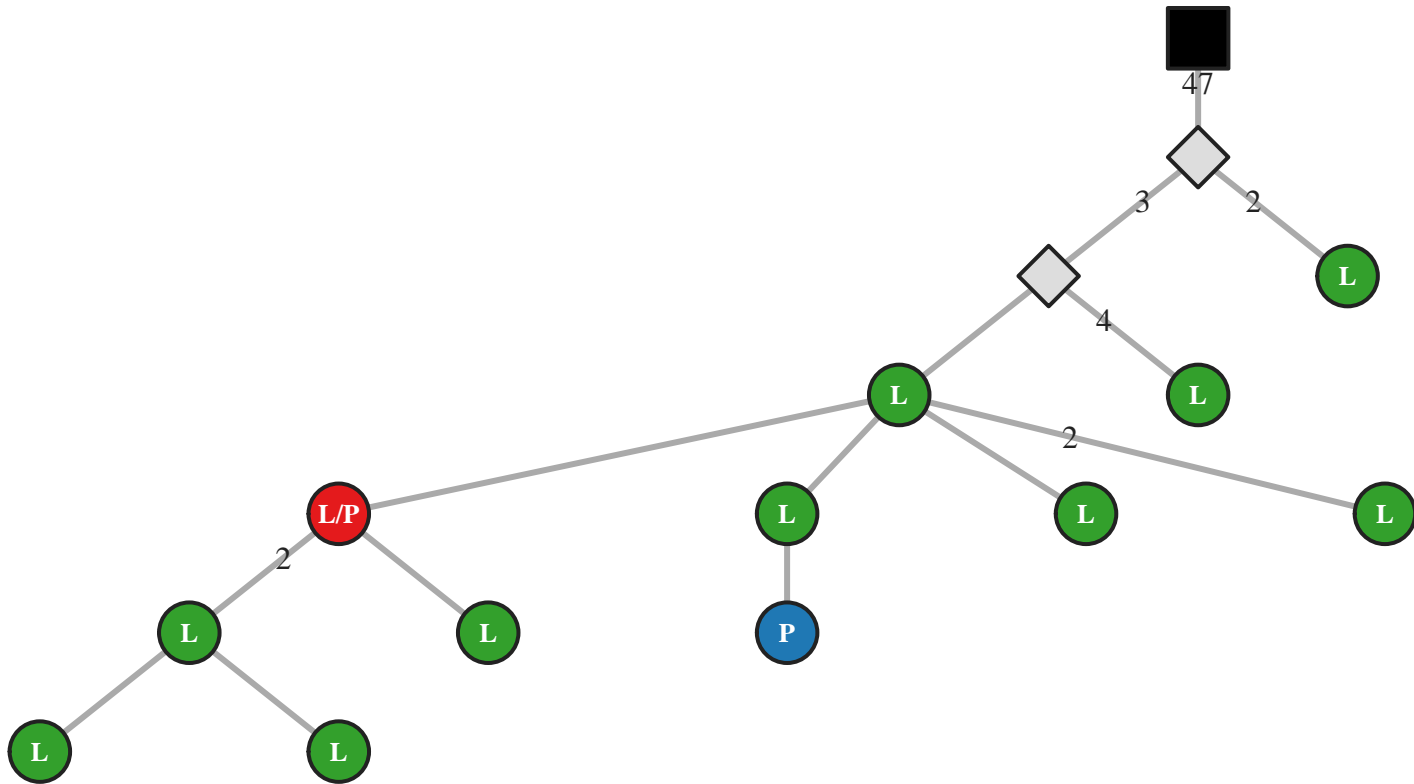

M5 IgG IGHV1-69/J3 45bp (23753)

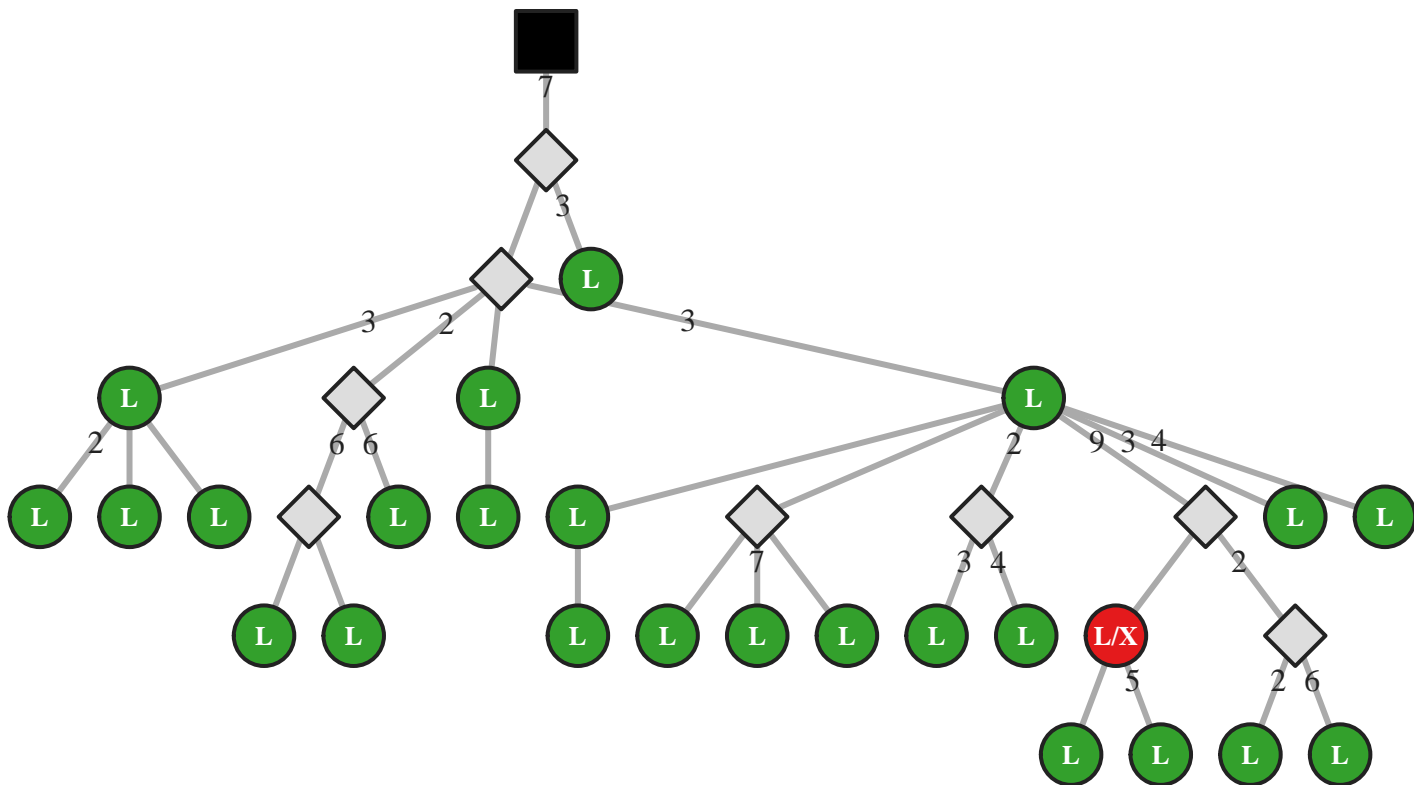

M5 IgG IGHV1-69/J3 45bp (23781)

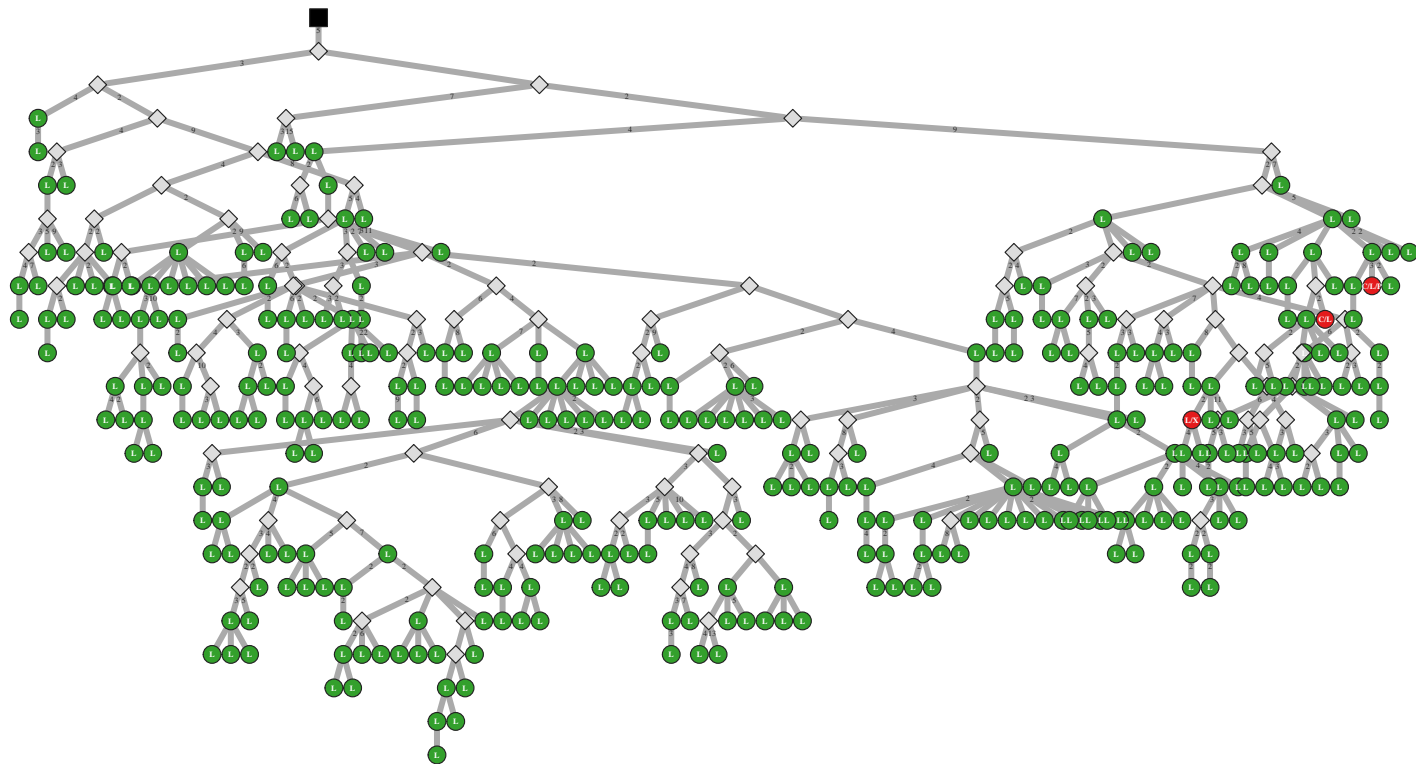

M5 IgG IGHV1-69/J3 51bp (40761)

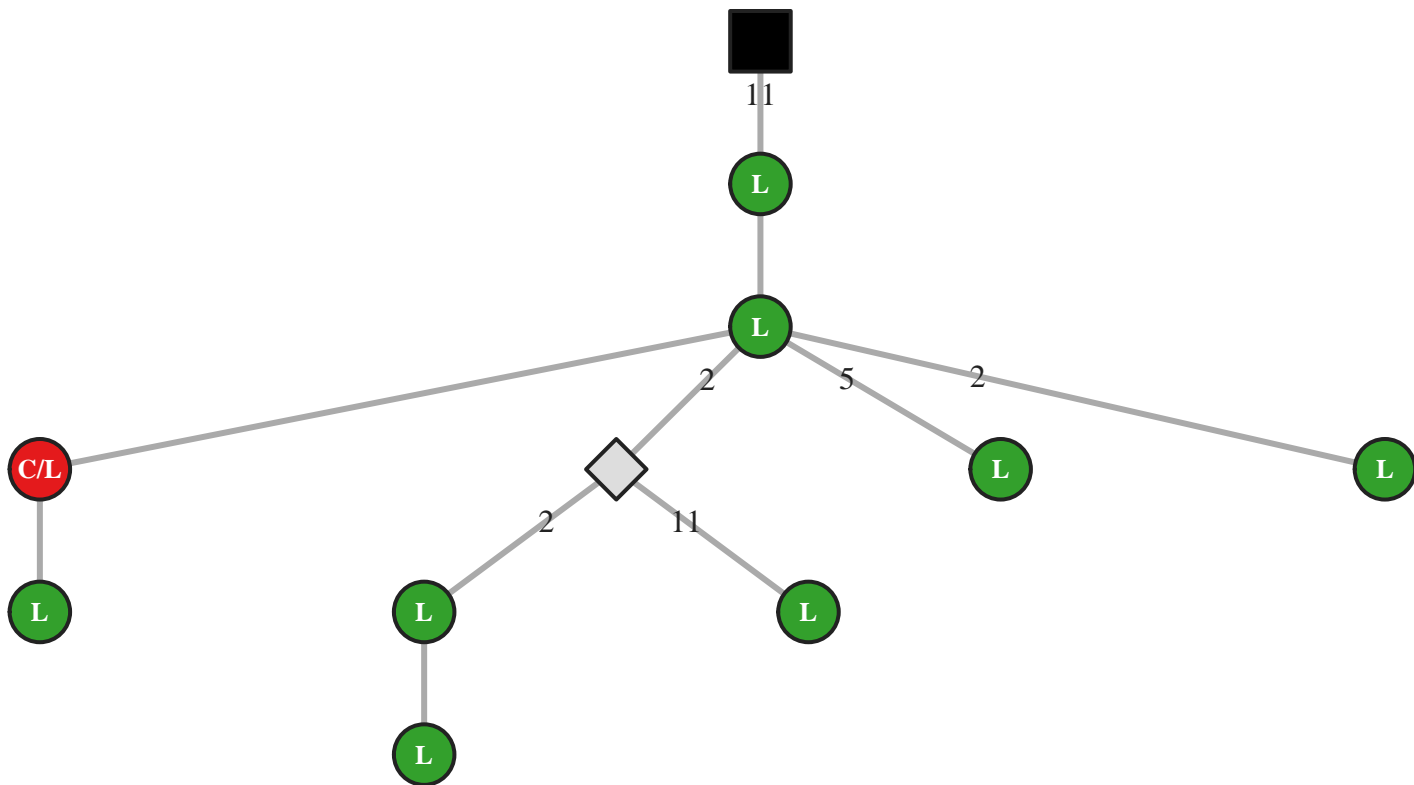

M5 IgG IGHV1-69/J3 51bp (40784)

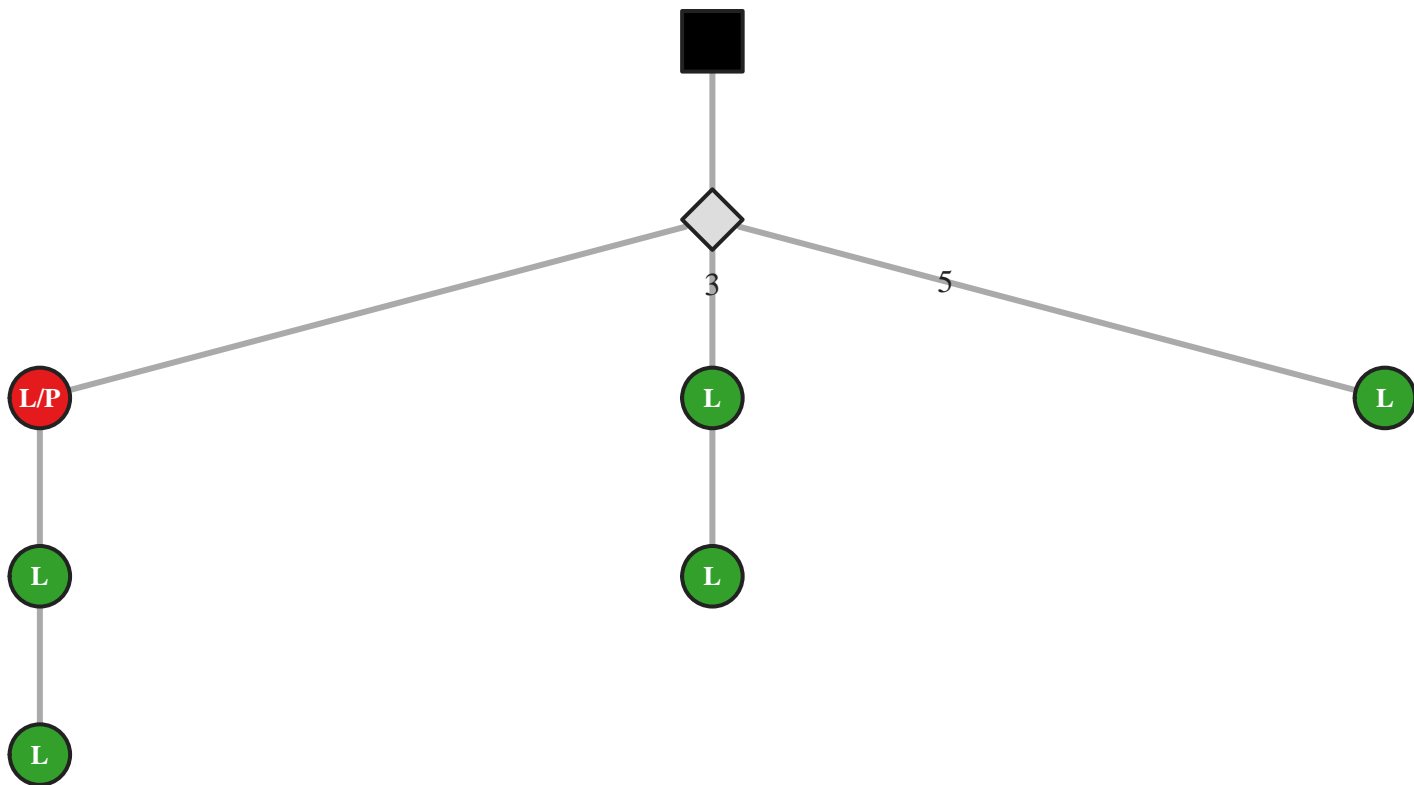

M5 IgA IGHV1-69/J3 54bp (48561)

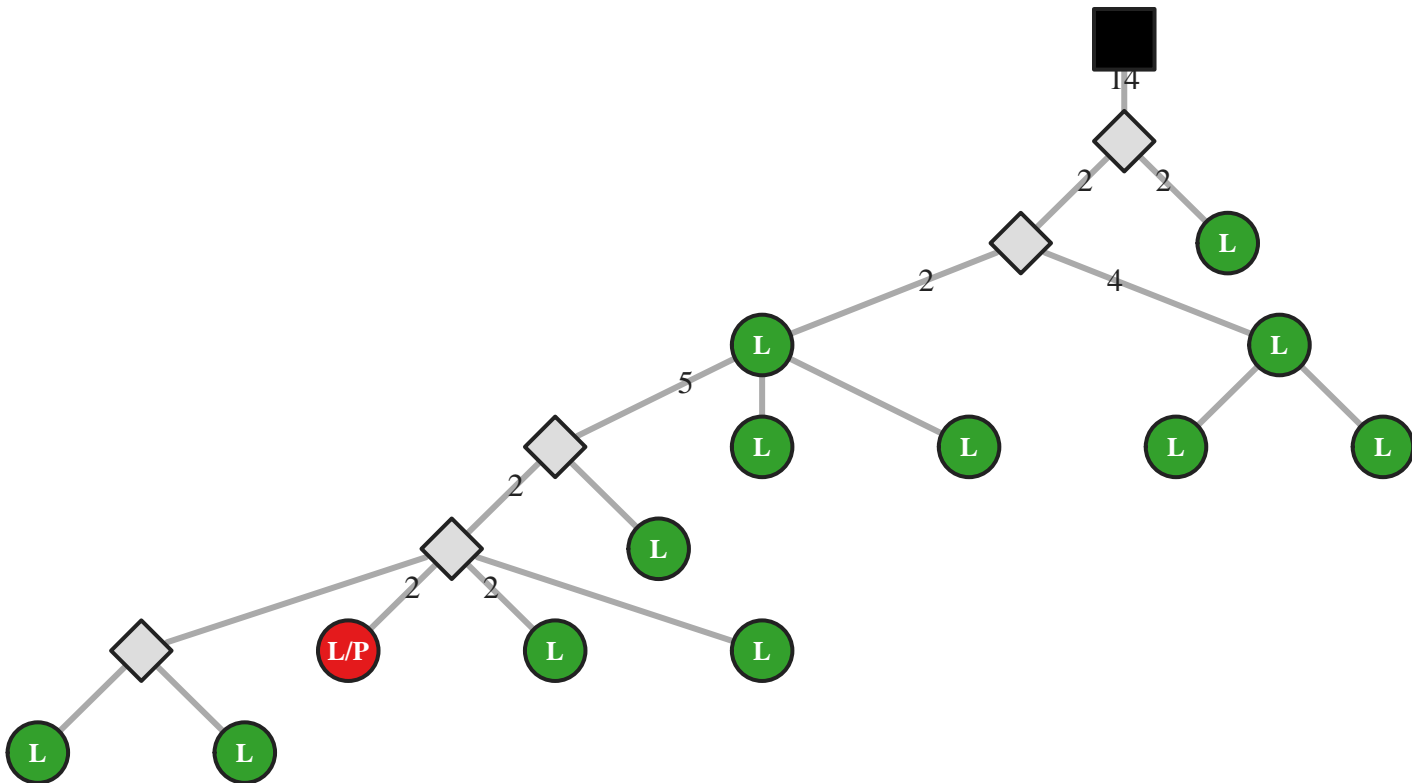

M5 IgG IGHV1-69/J3 54bp (4970)

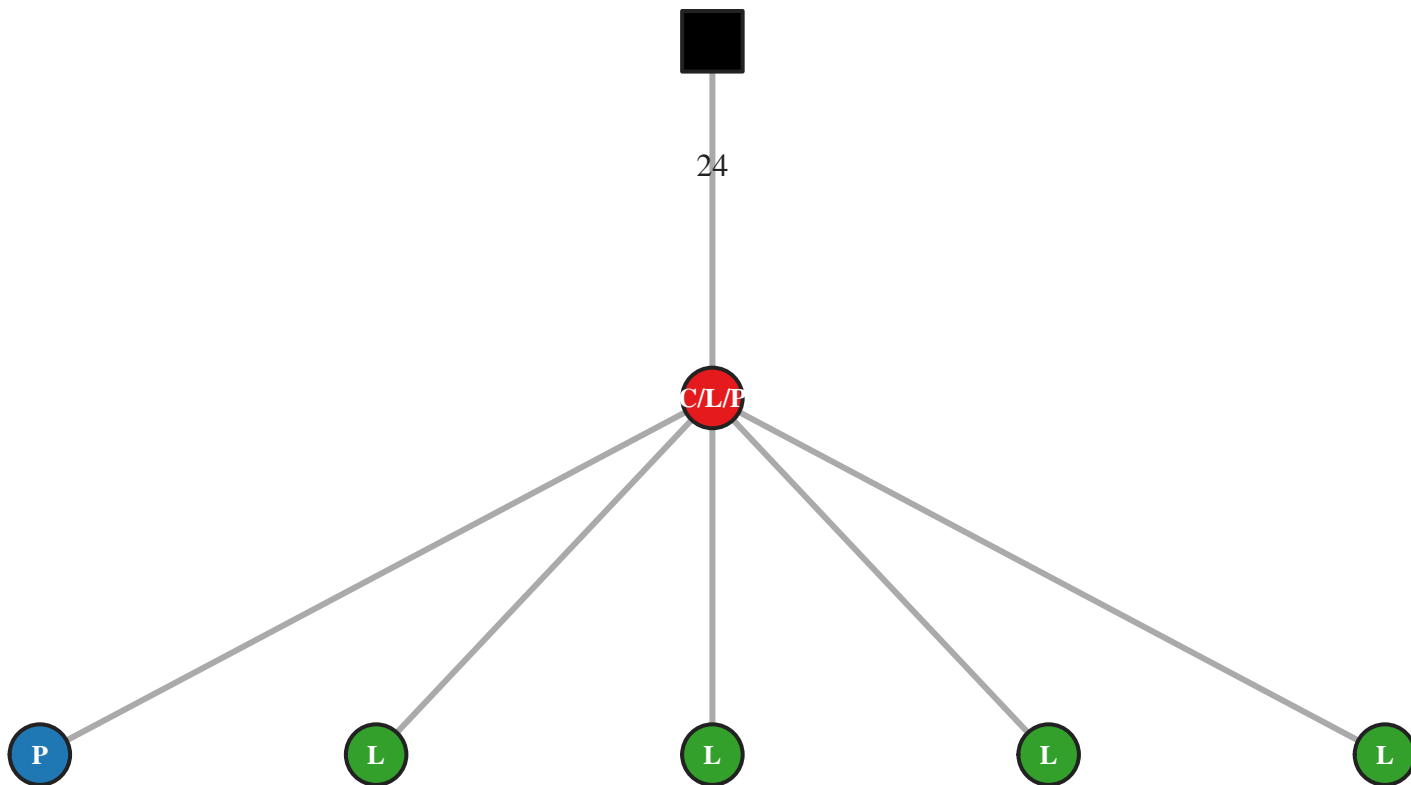

M5 IgG IGHV1-69/J3 54bp (4971)

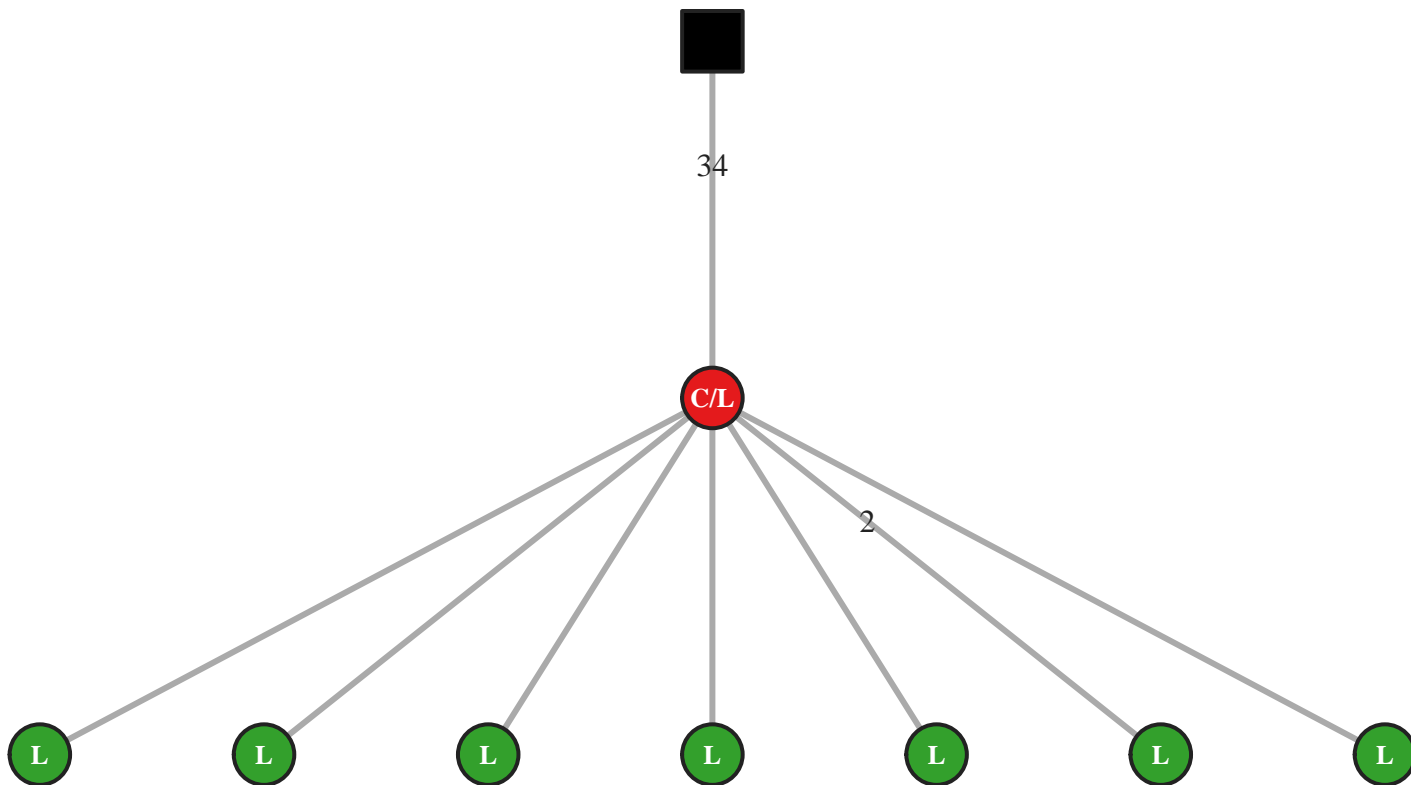

M5 IgG IGHV1-69/J3 54bp (4980)

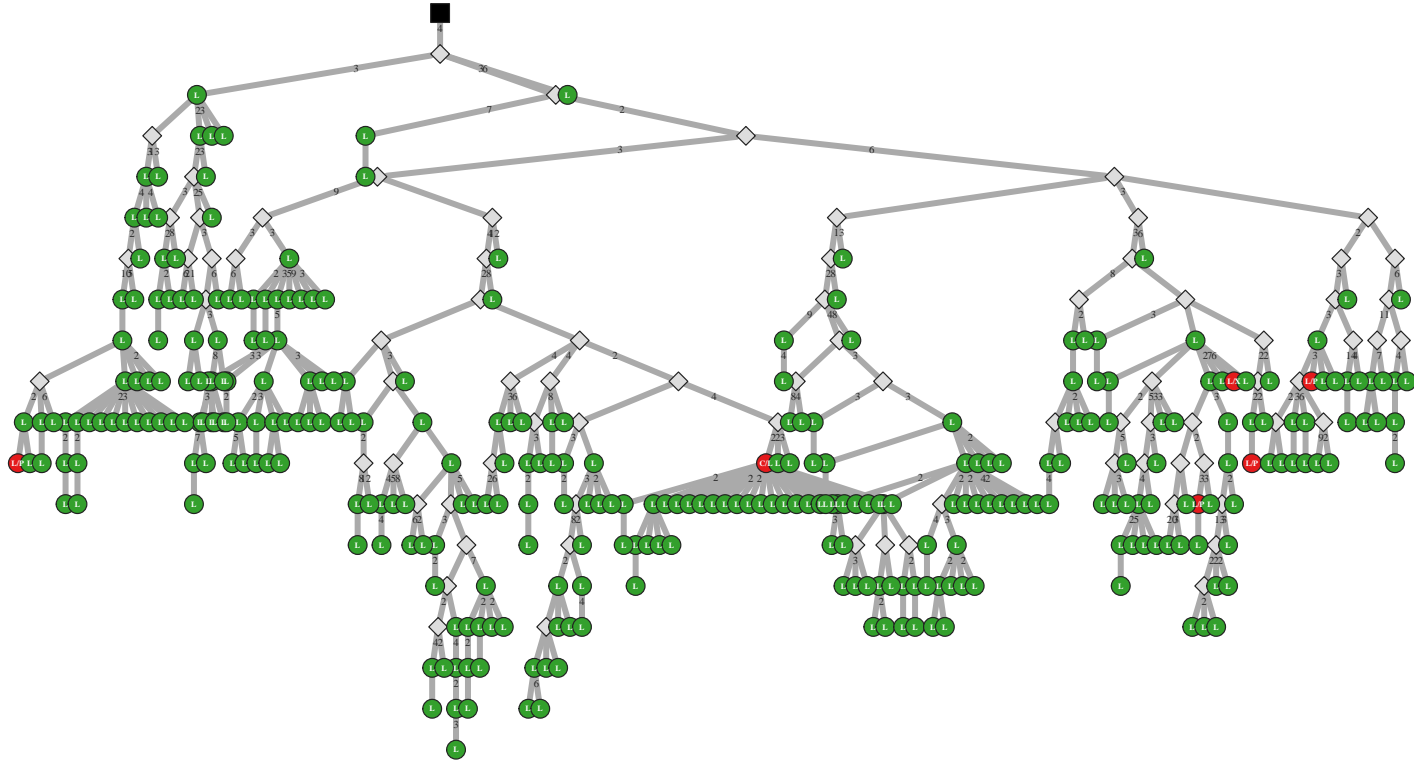

M5 IgG IGHV1-69/J3 54bp (4991)

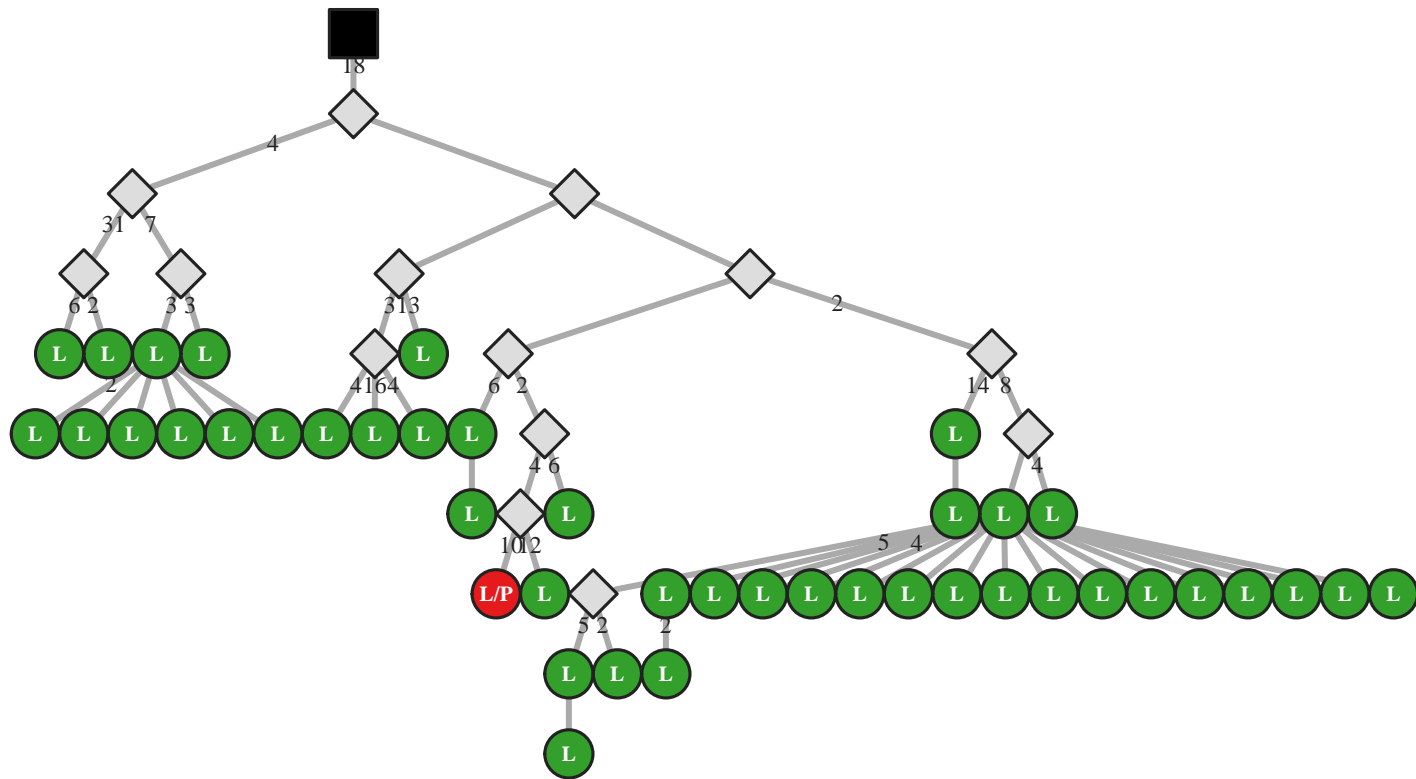

M5 IgG IGHV1-69/J3 54bp (4995)

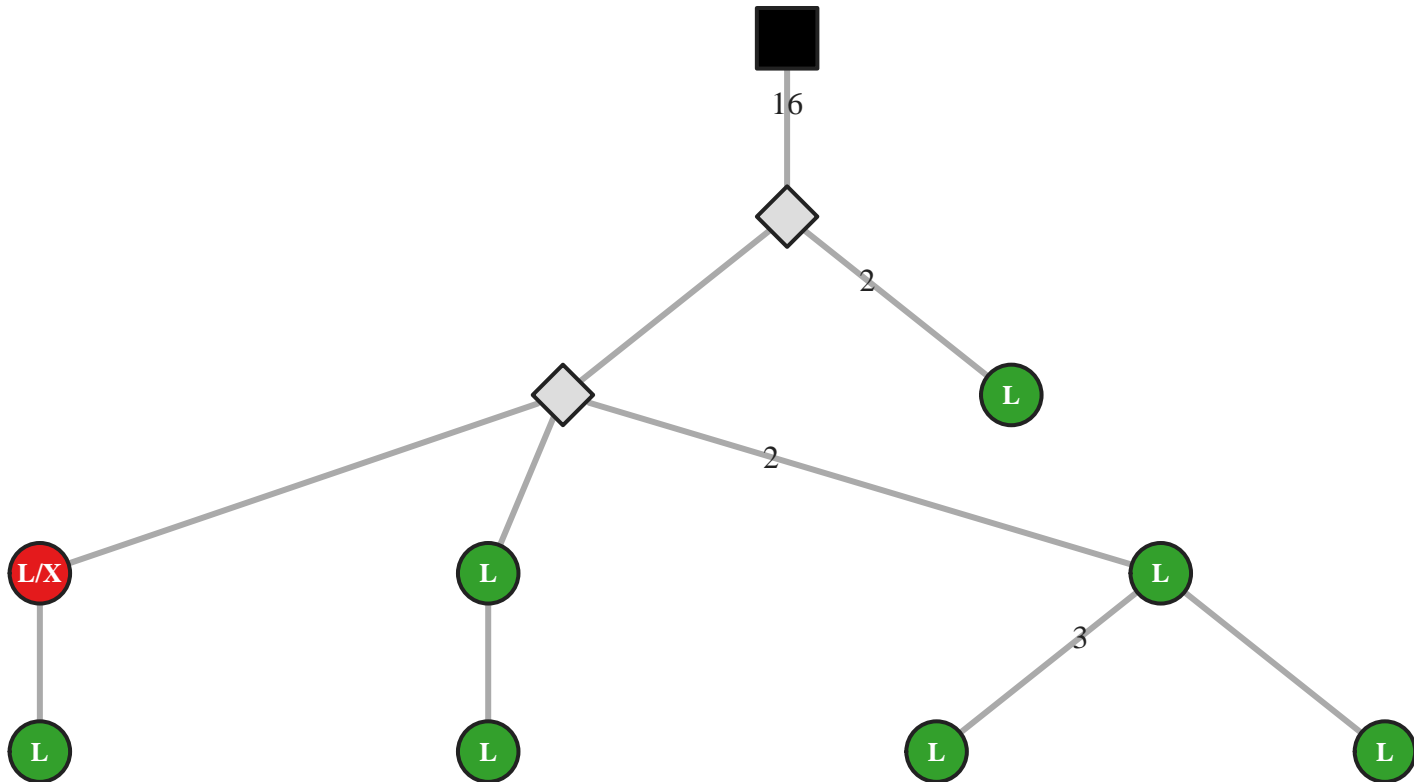

M5 IgG IGHV1-69/J3 54bp (5022)

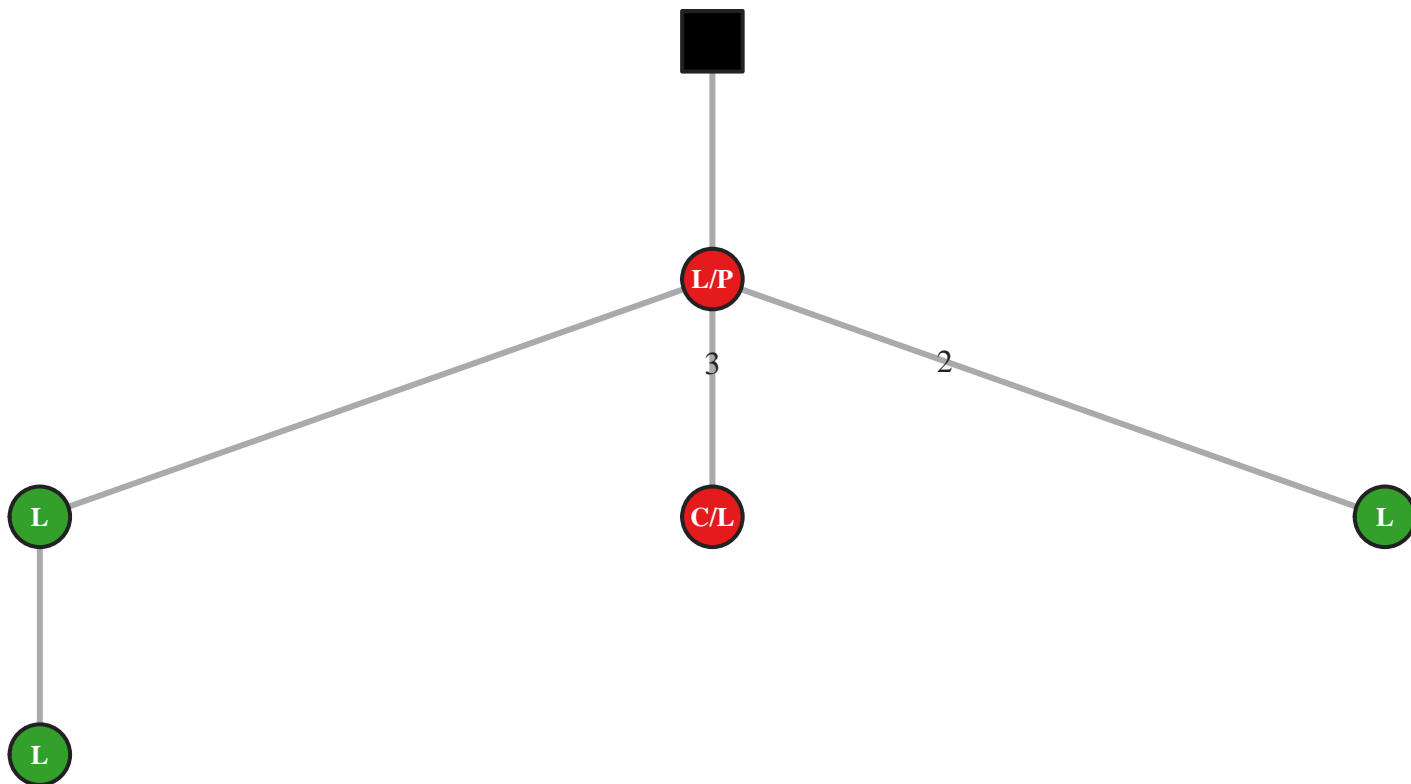

M5 IgG IGHV1-69/J3 54bp (5024)

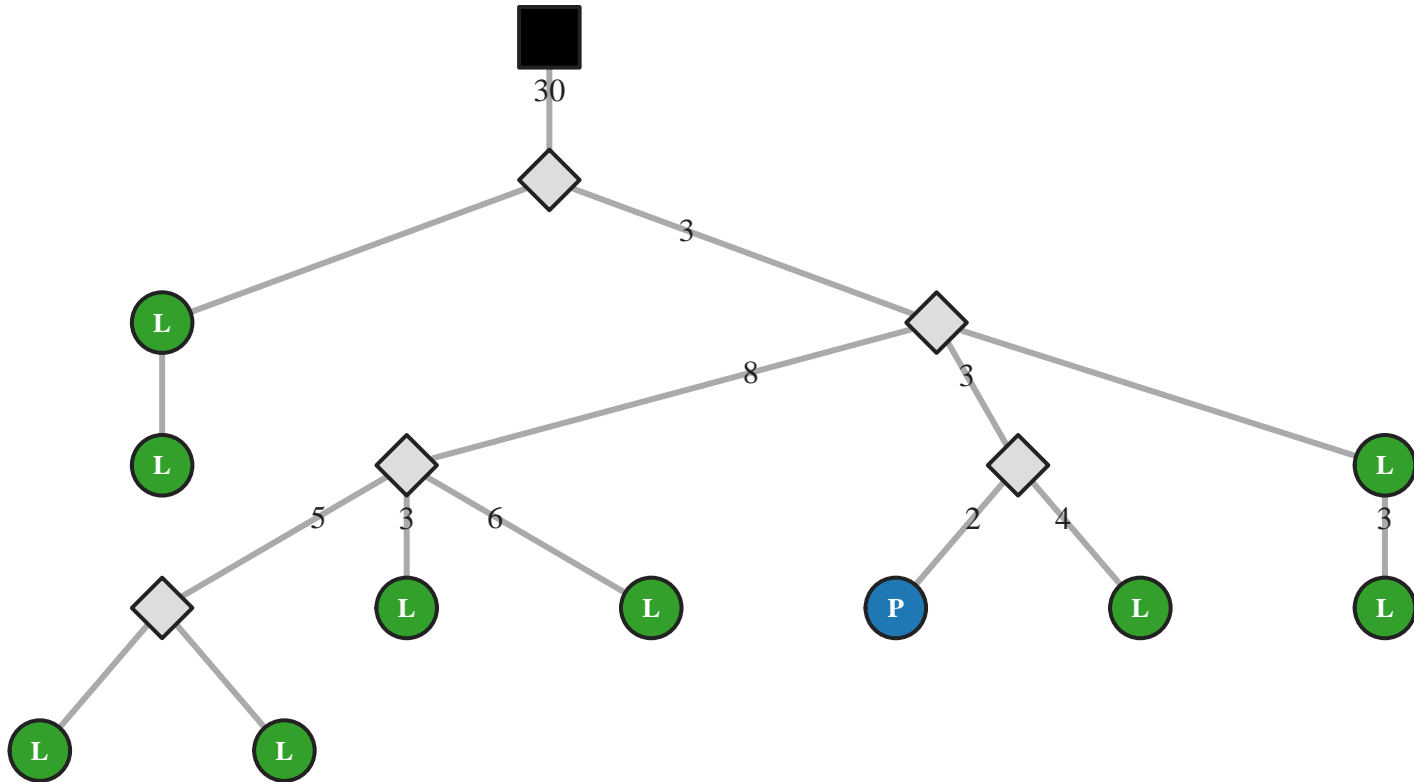

M5 IgG IGHV1-69/J3 54bp (5026)

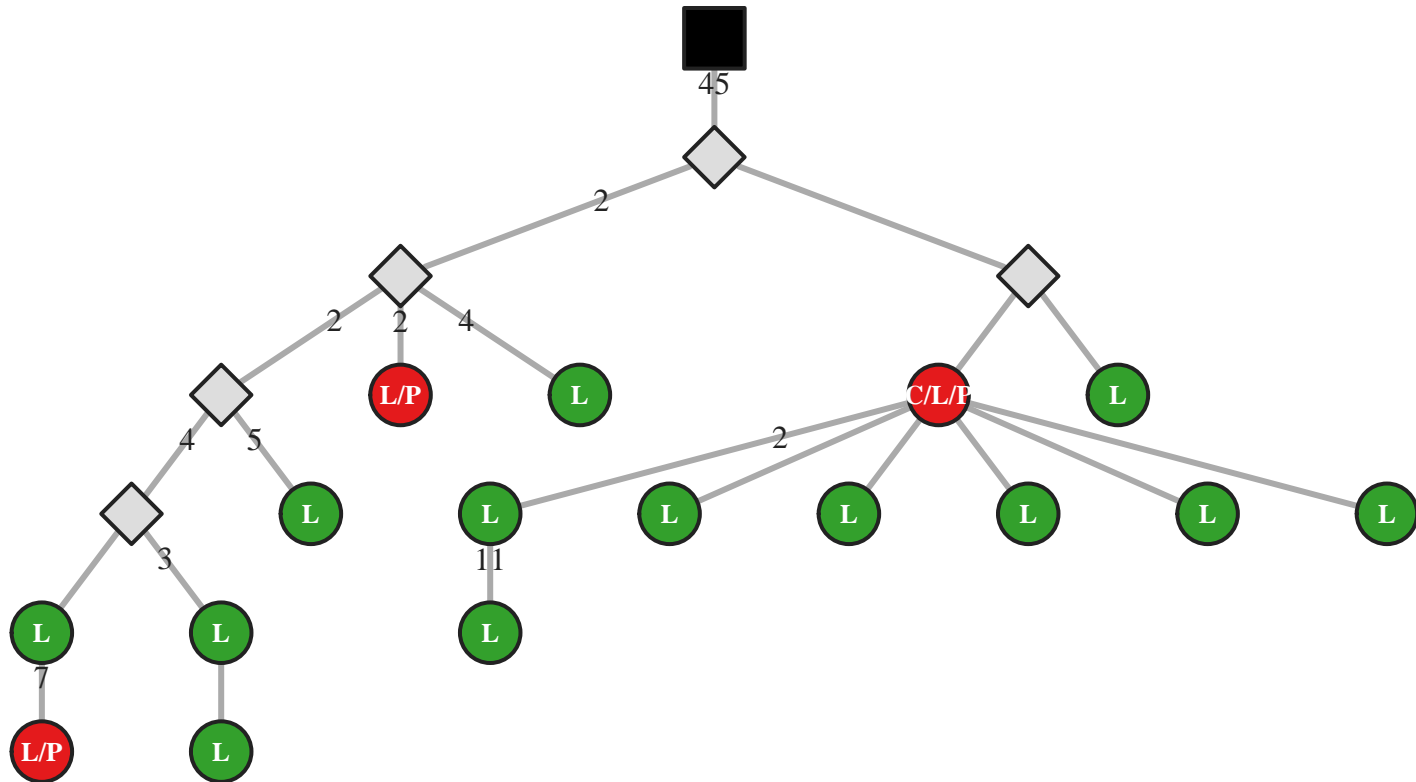

M5 IgG IGHV1-69/J3 57bp (14589)

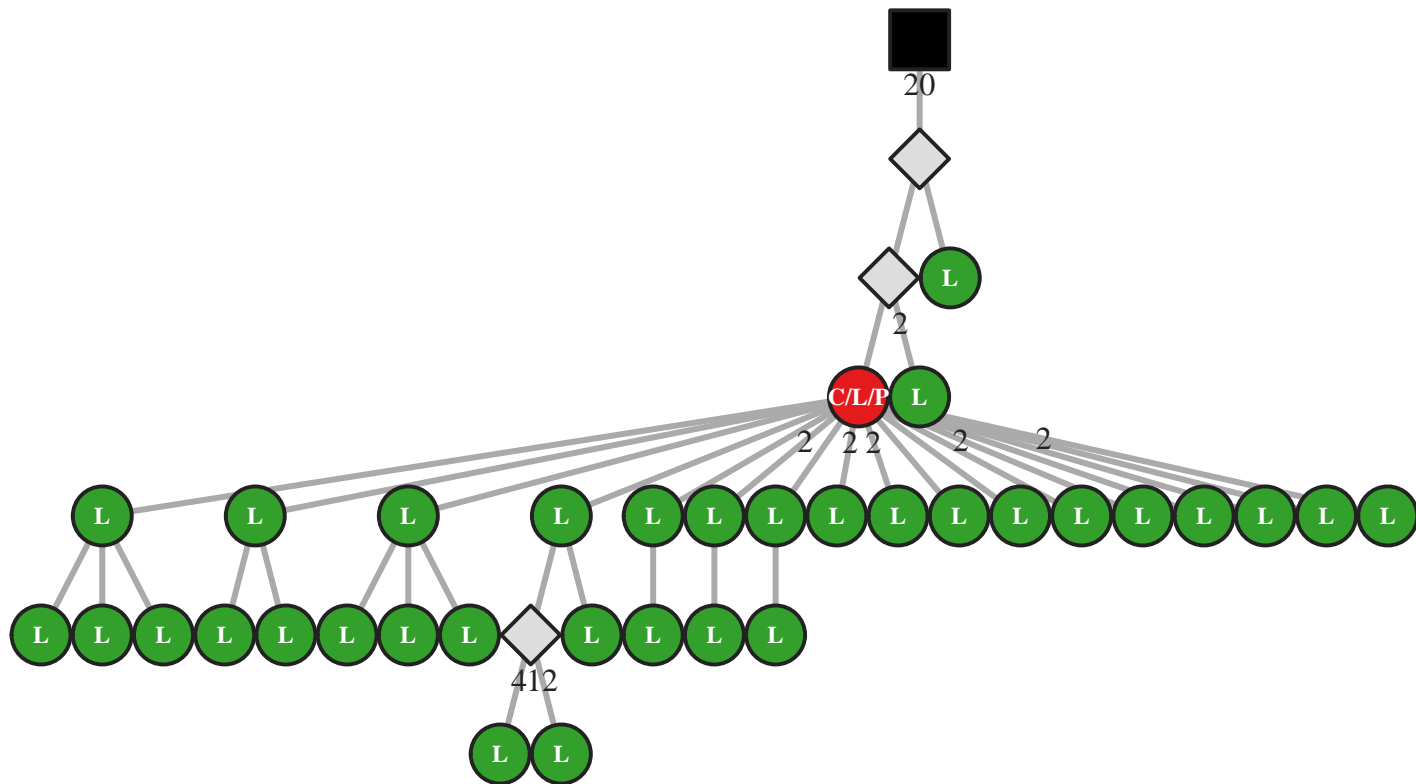

M5 IgG IGHV1-69/J3 57bp (14591)

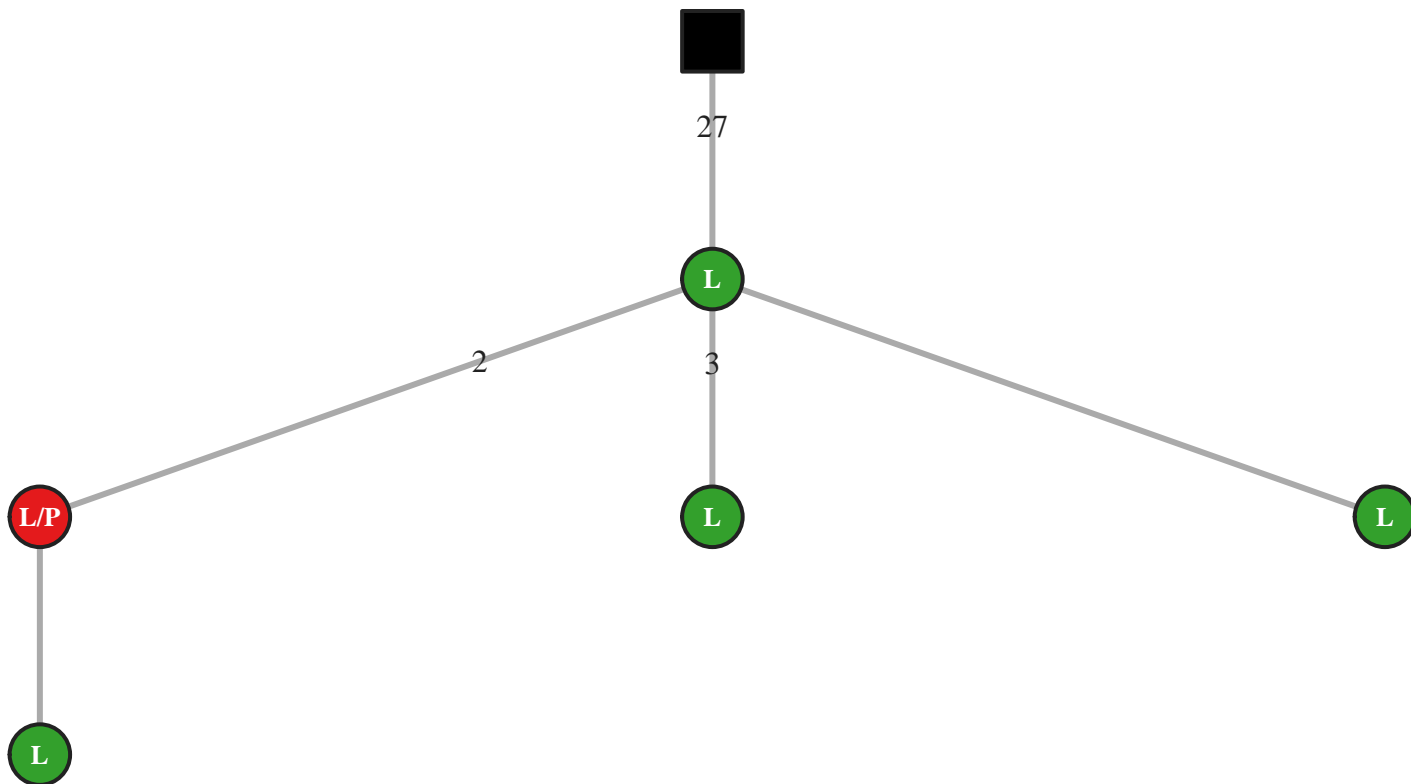

M5 IgG IGHV1-69/J3 57bp (14593)

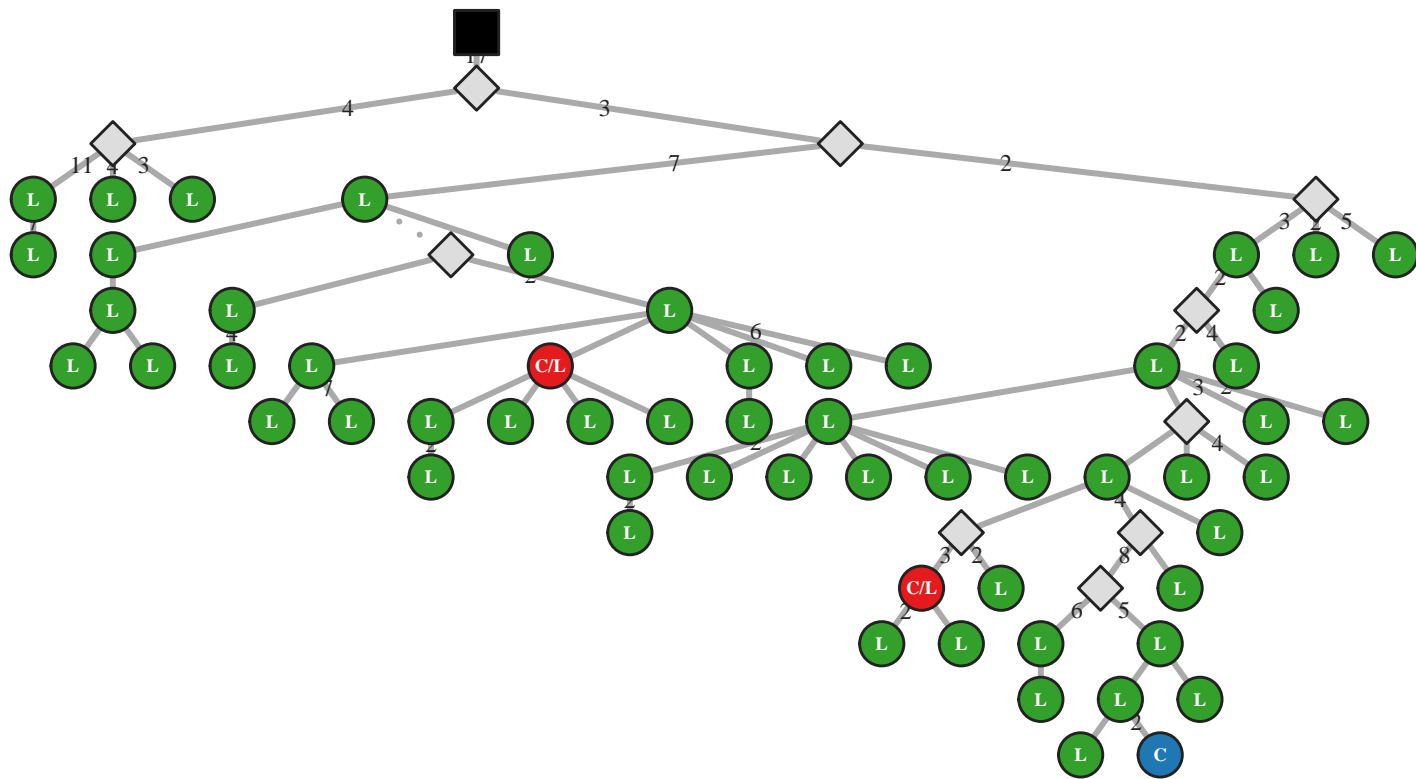

M5 IgG IGHV1-69/J3 60bp (14636)

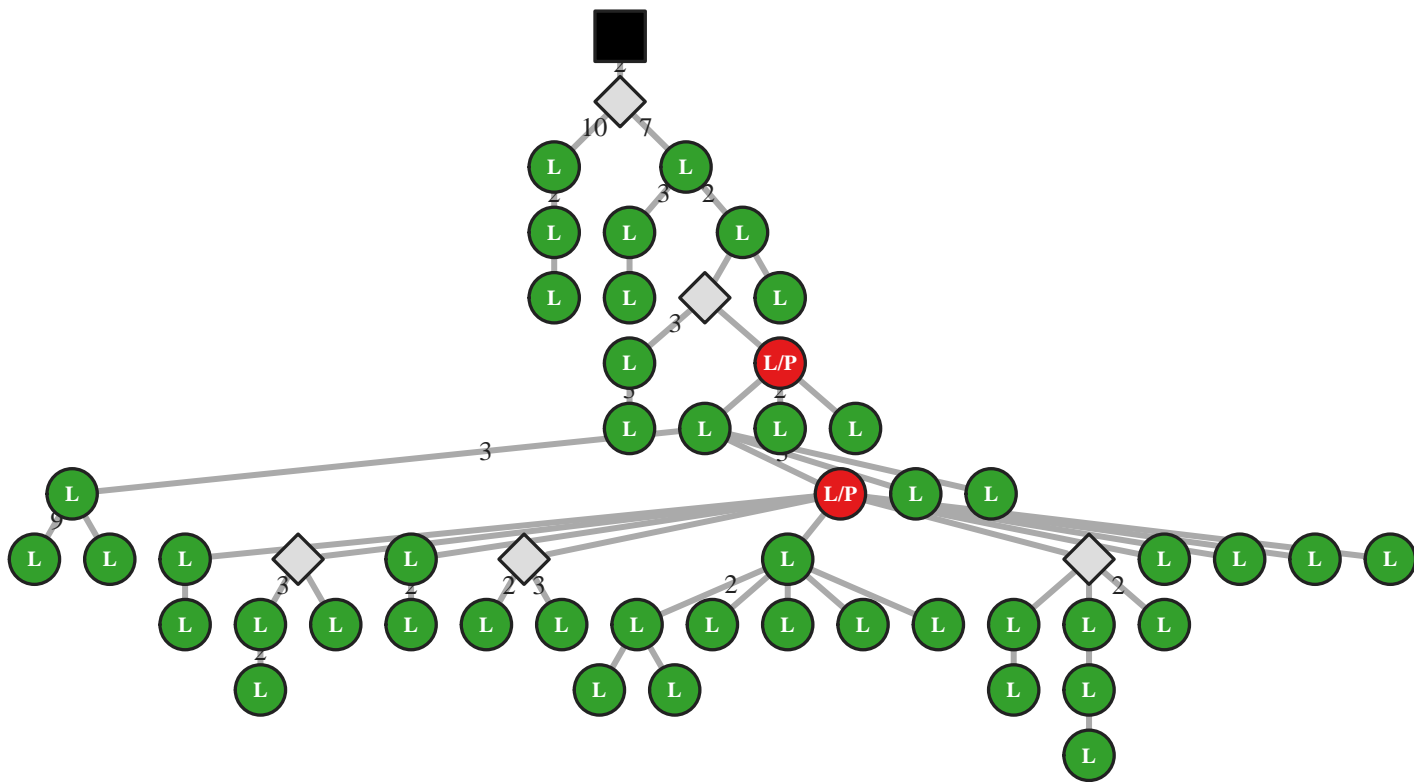

M5 IgG IGHV1-69/J3 63bp (23823)

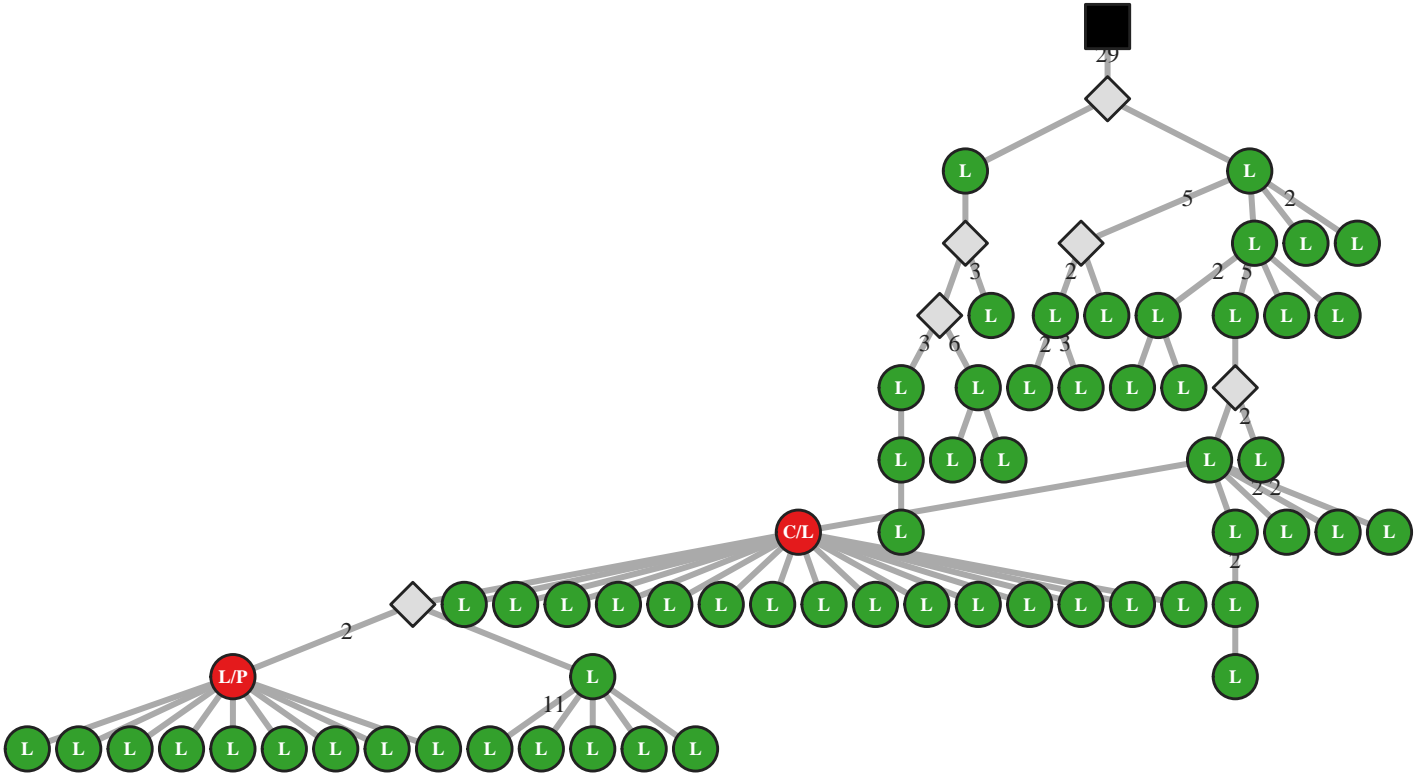

M5 IgG IGHV1-69/J3 63bp (23834)

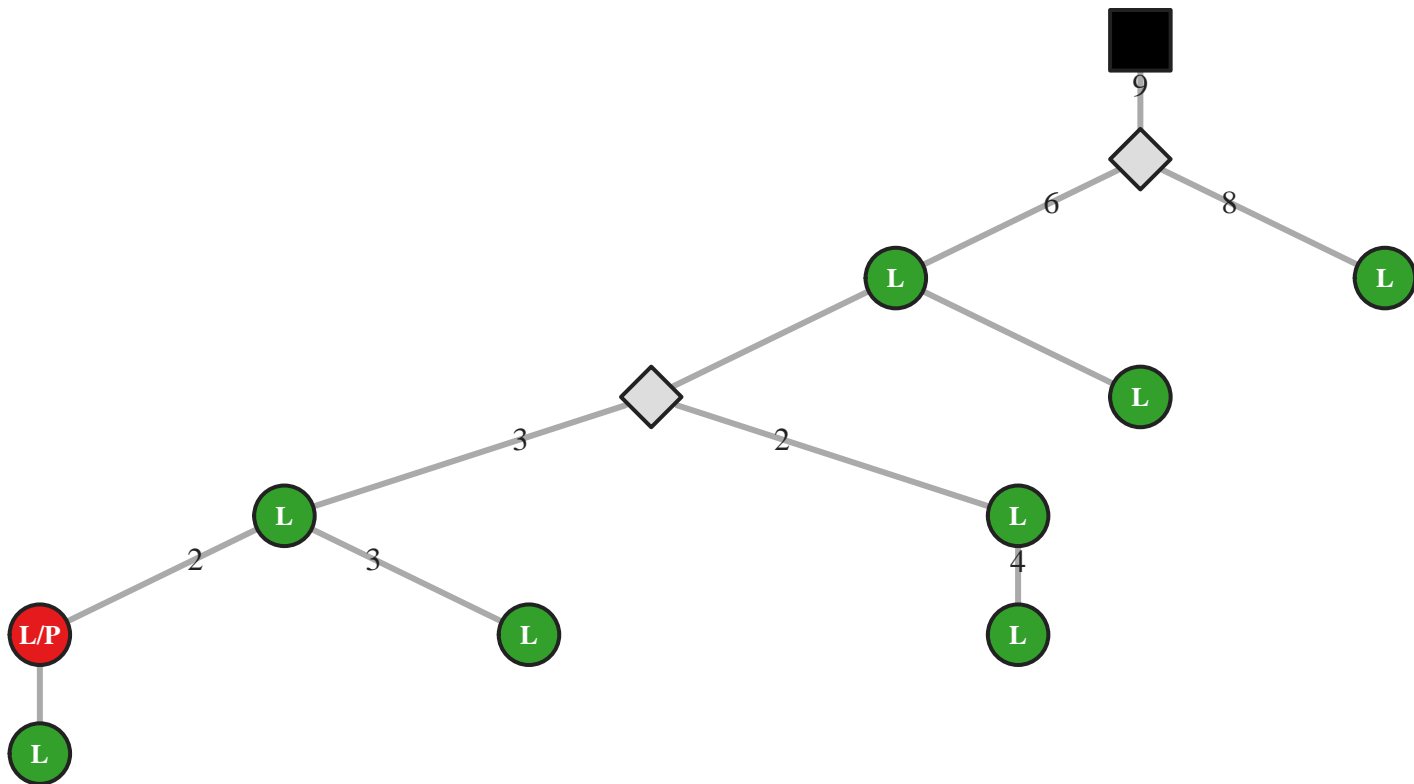

M5 IgG IGHV1-69/J4 21bp (14642)

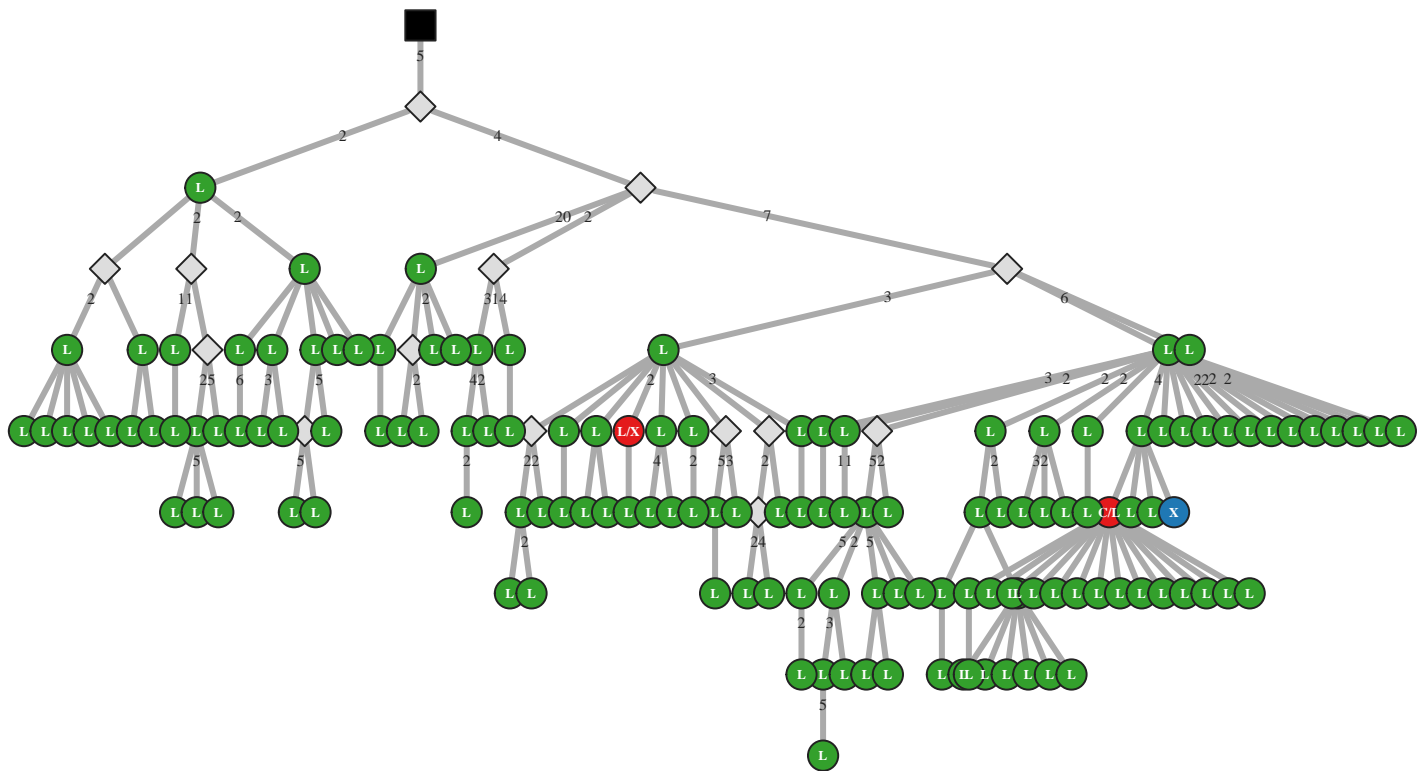

M5 IgG IGHV1-69/J4 27bp (32512)

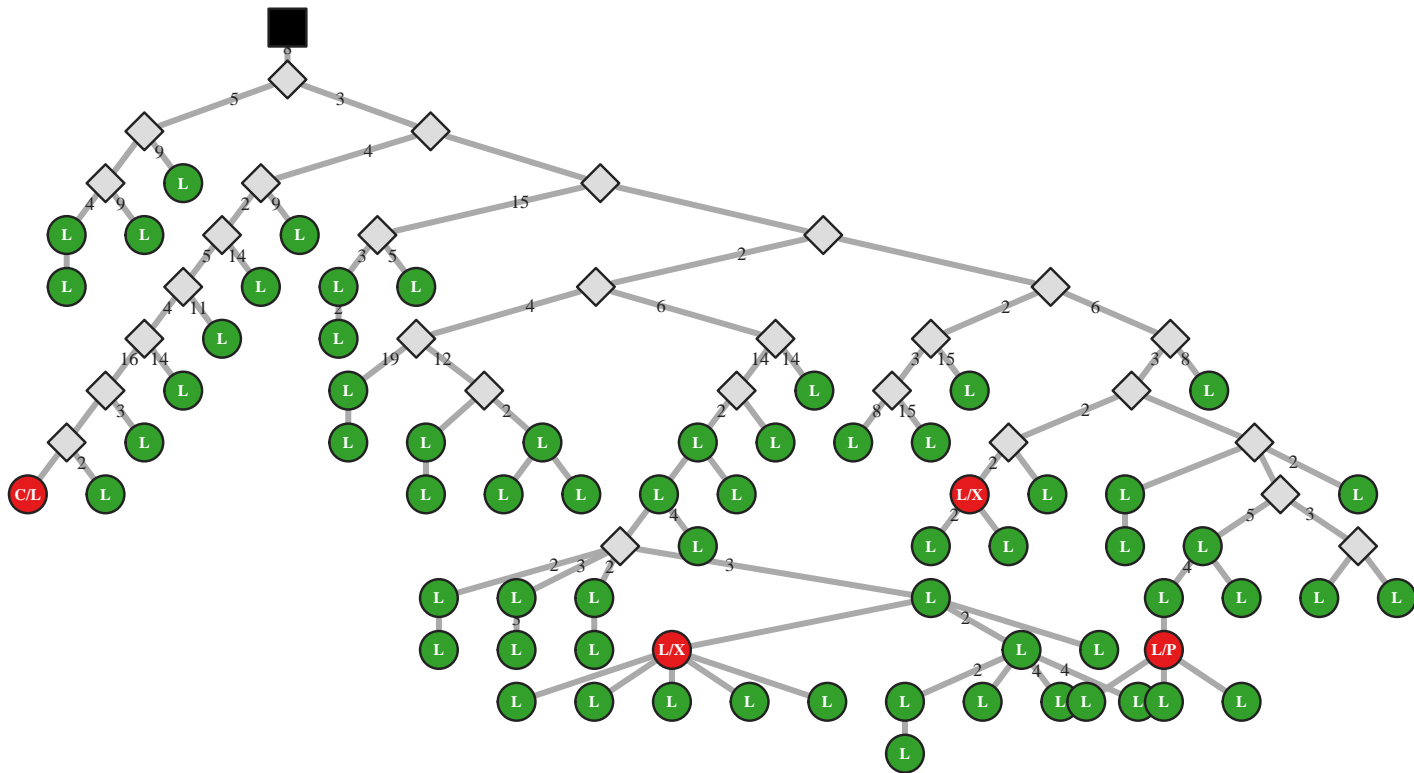

M5 IgG IGHV1-69/J4 33bp (32535)

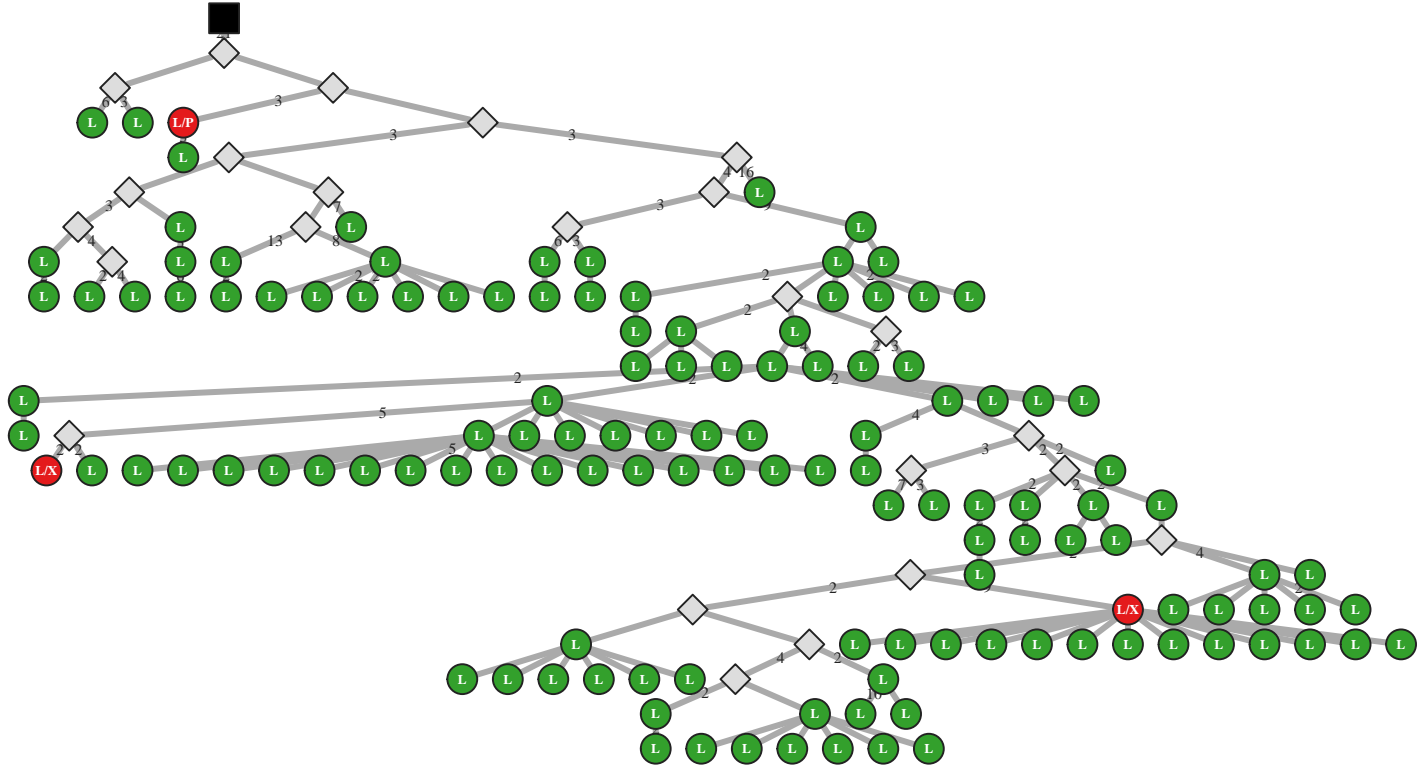

M5 IgG IGHV1-69/J4 33bp (32537)

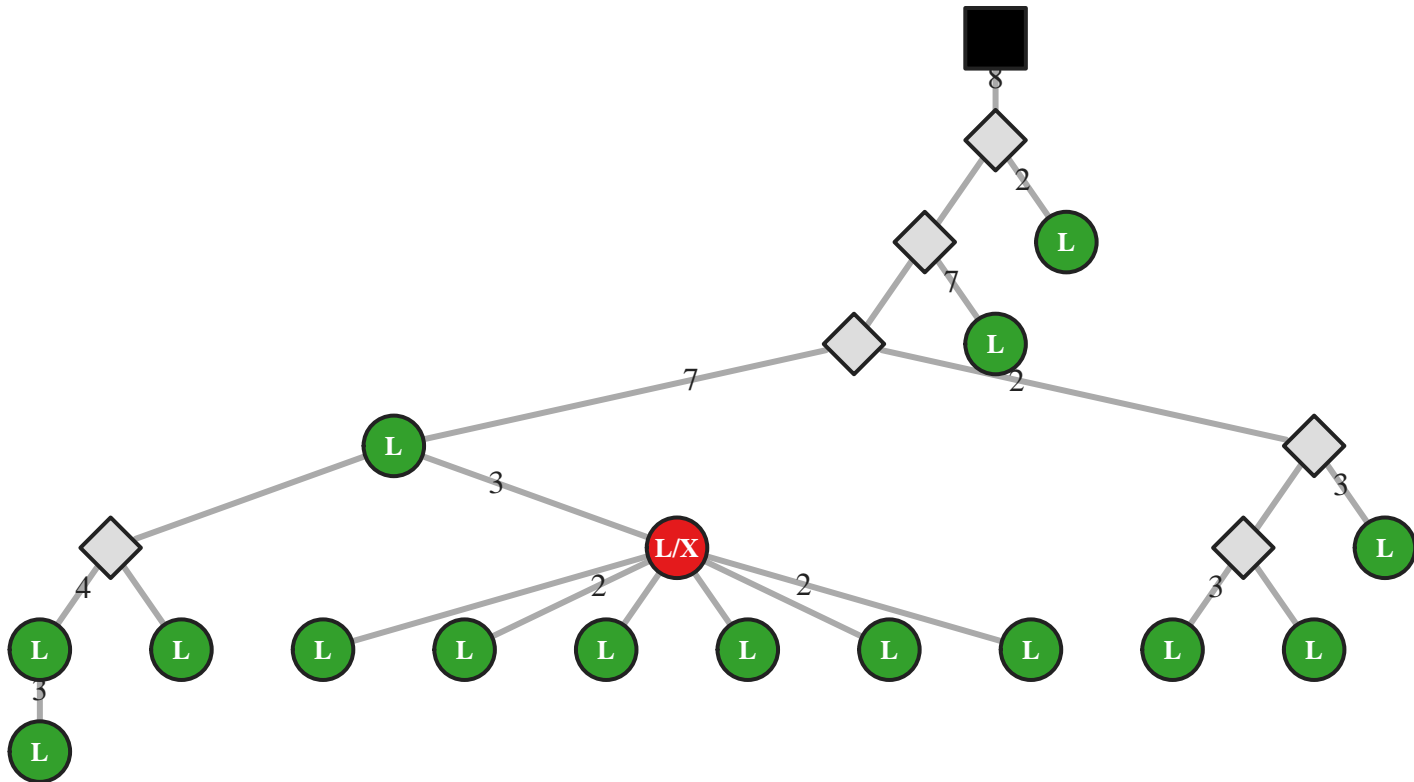

M5 IgG IGHV1-69/J4 33bp (32545)

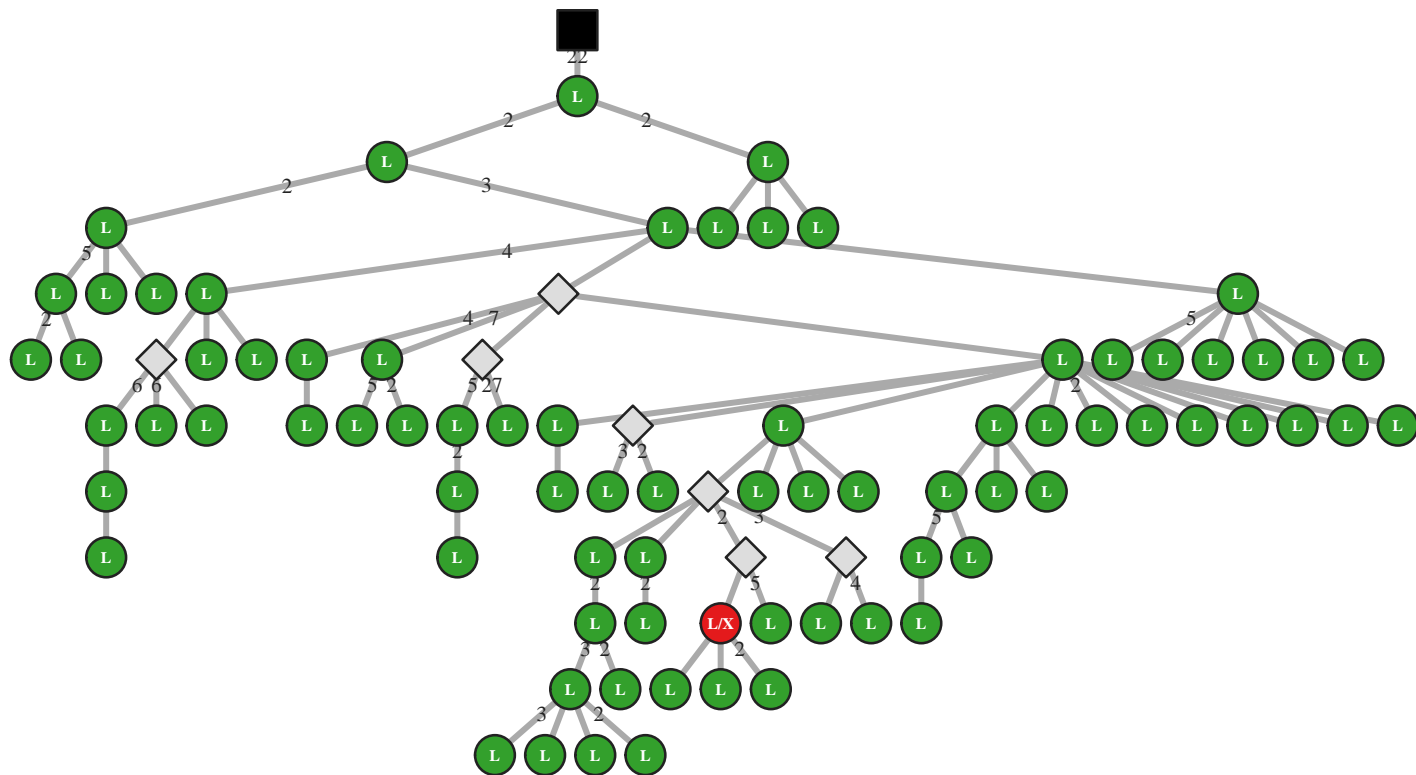

M5 IgG IGHV1-69/J4 33bp (32546)

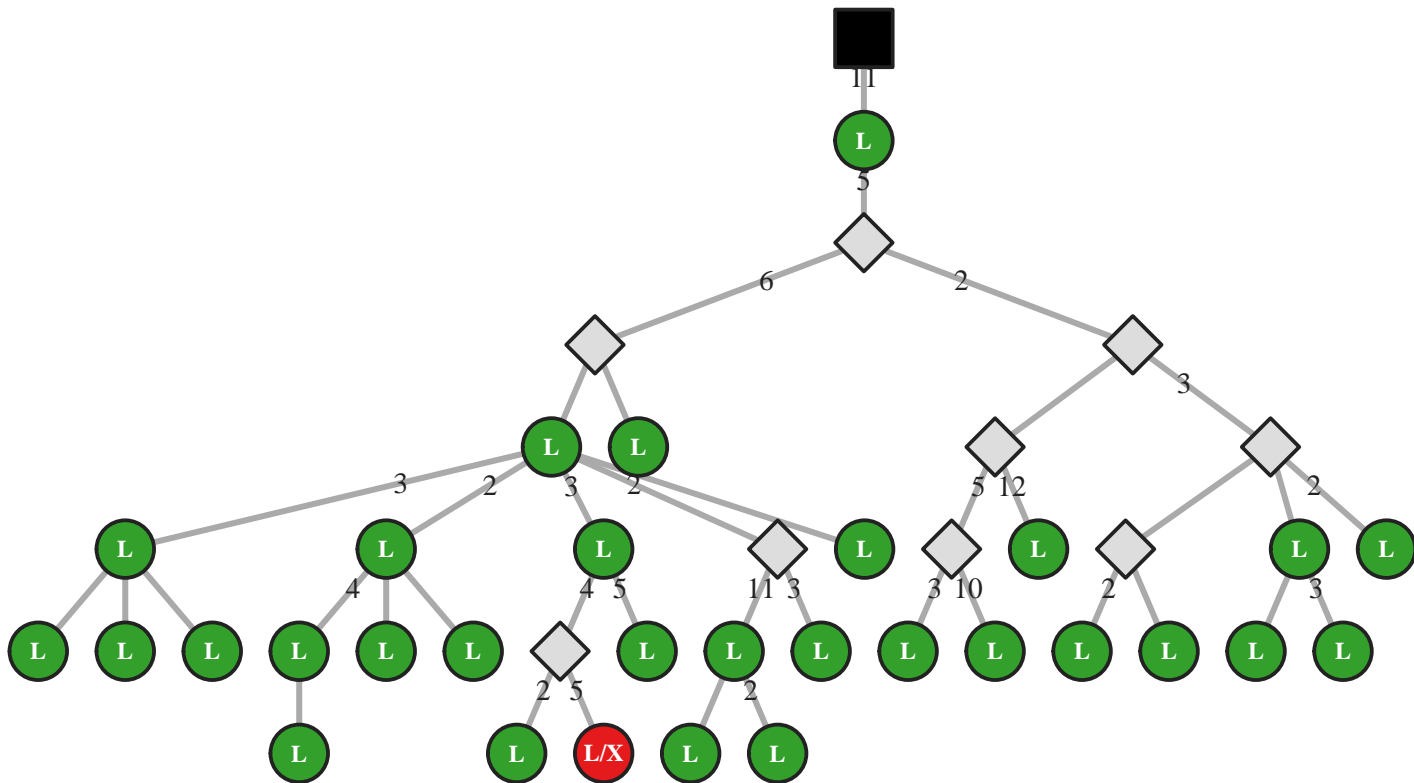

M5 IgG IGHV1-69/J4 33bp (32547)

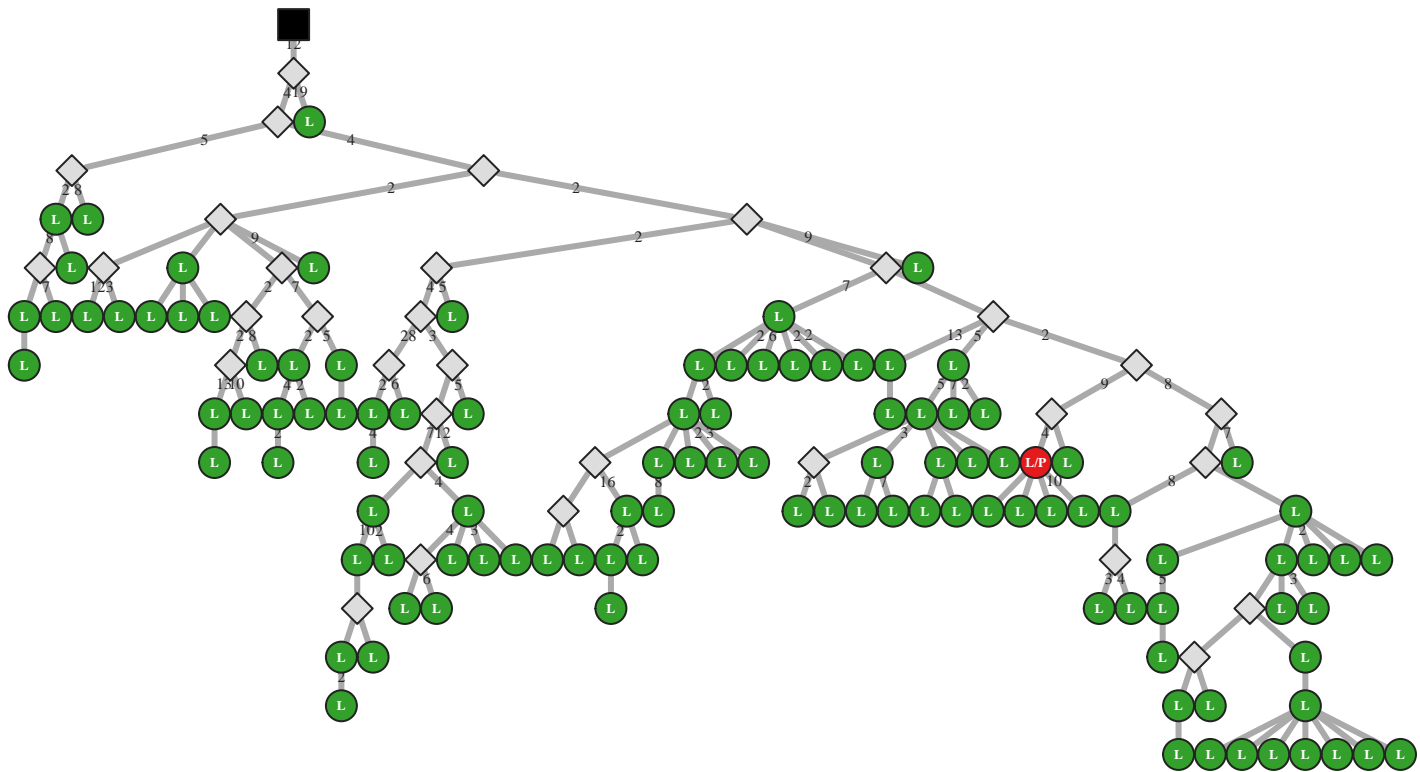

M5 IgG IGHV1-69/J4 36bp (50225)

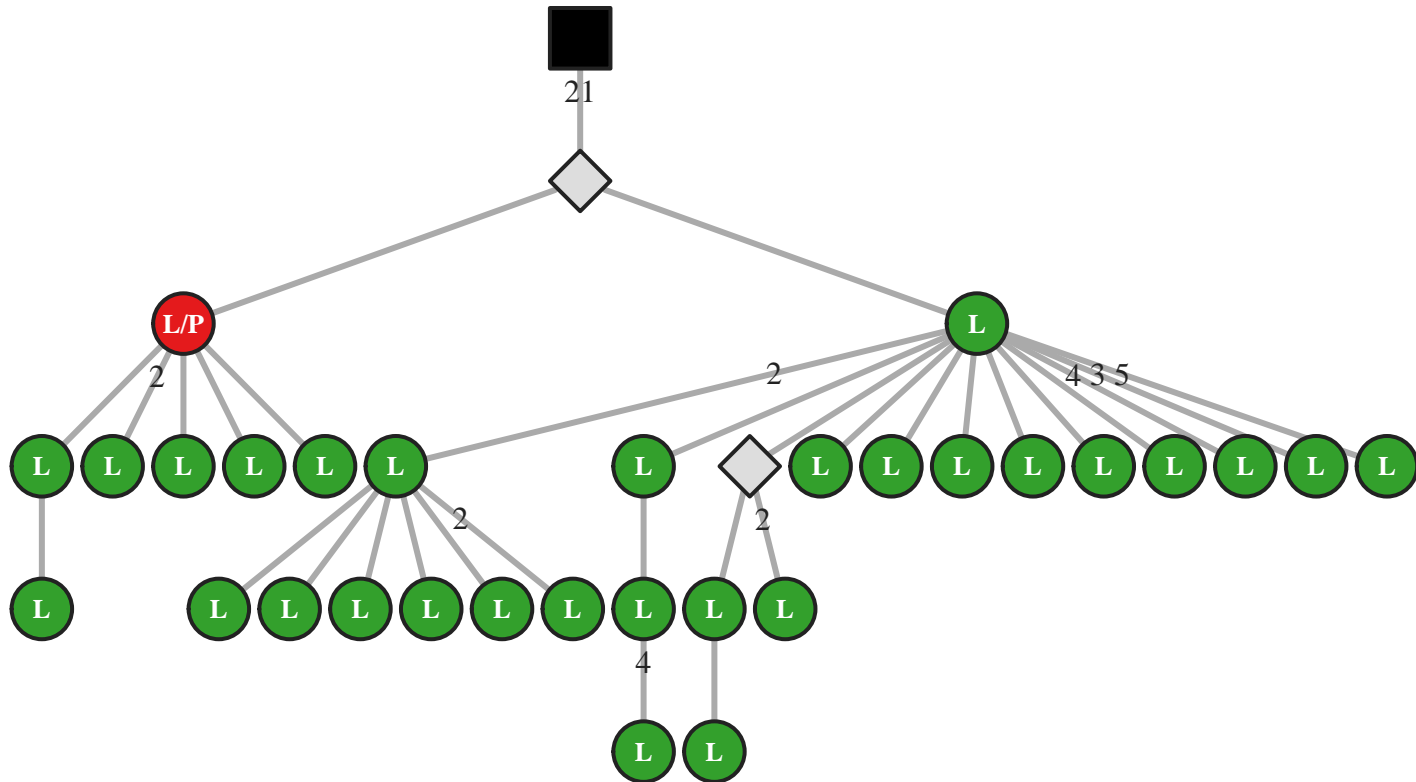

M5 IgG IGHV1-69/J4 39bp (40884)

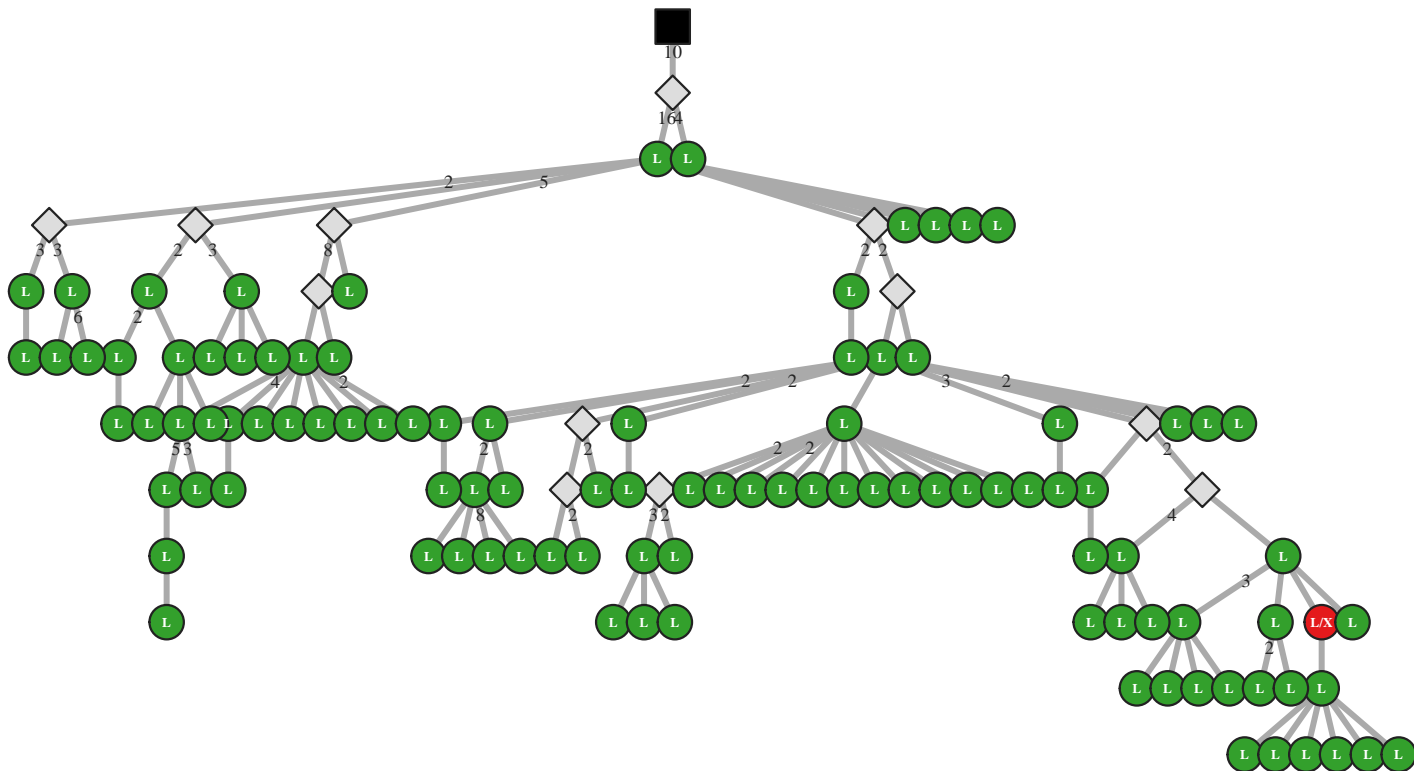

M5 IgG IGHV1-69/J4 39bp (40896)

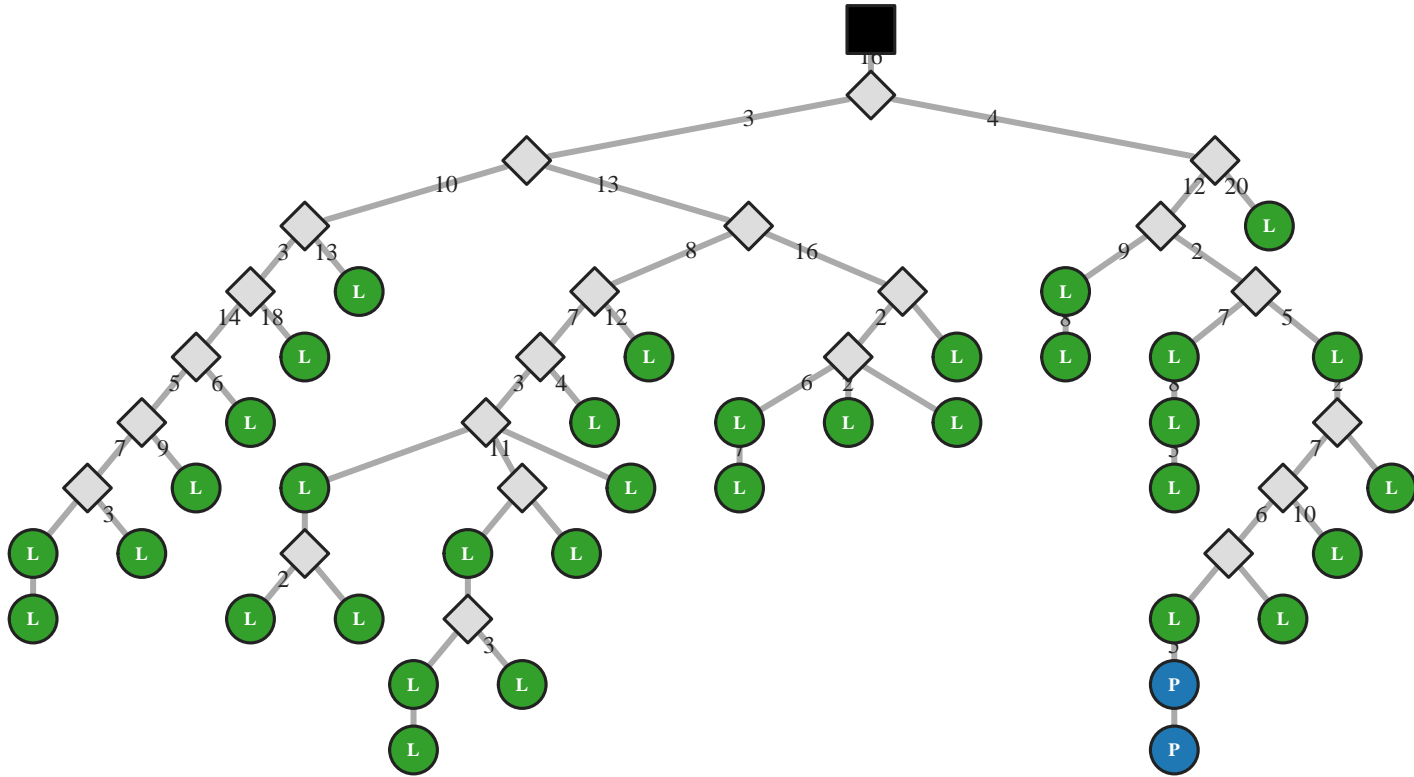

M5 IgG IGHV1-69/J4 39bp (40910)

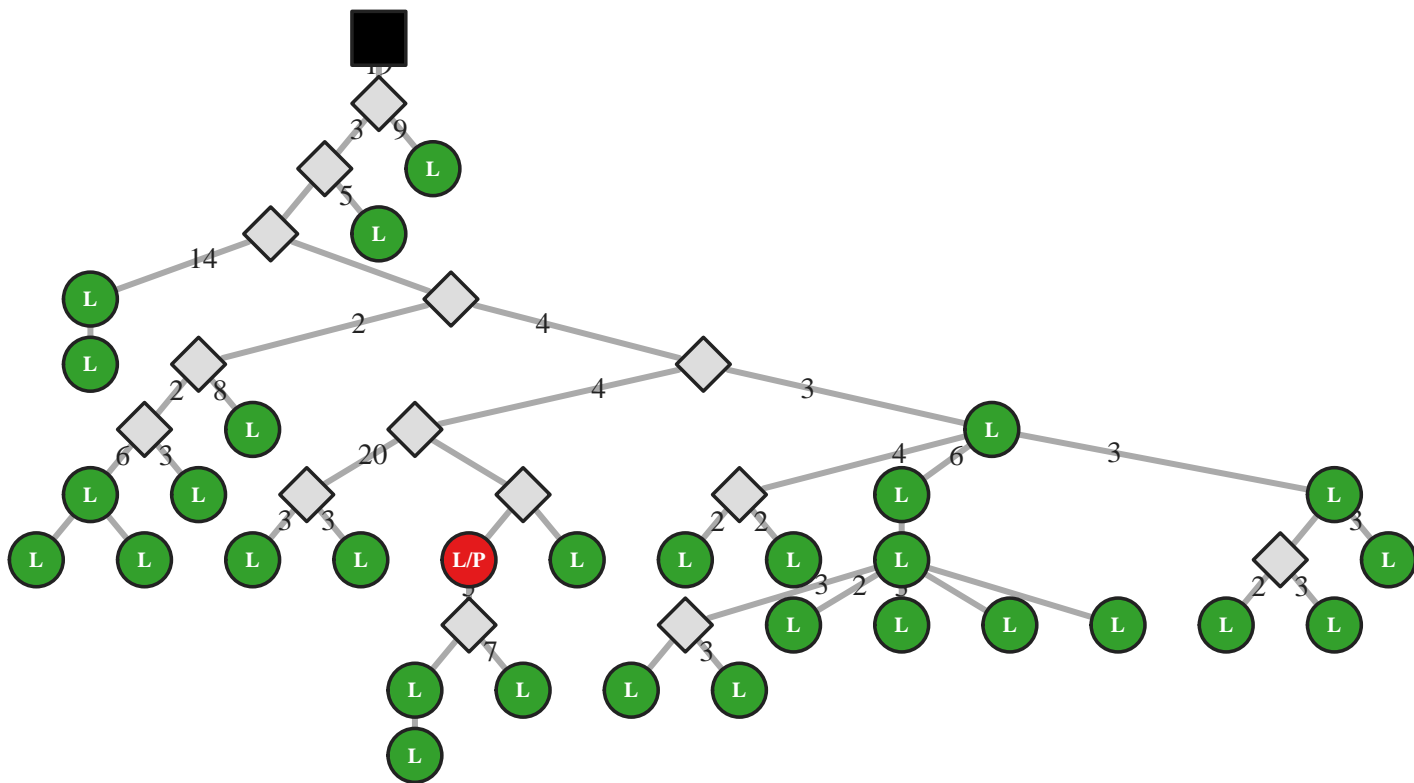

M5 IgG IGHV1-69/J4 39bp (40912)

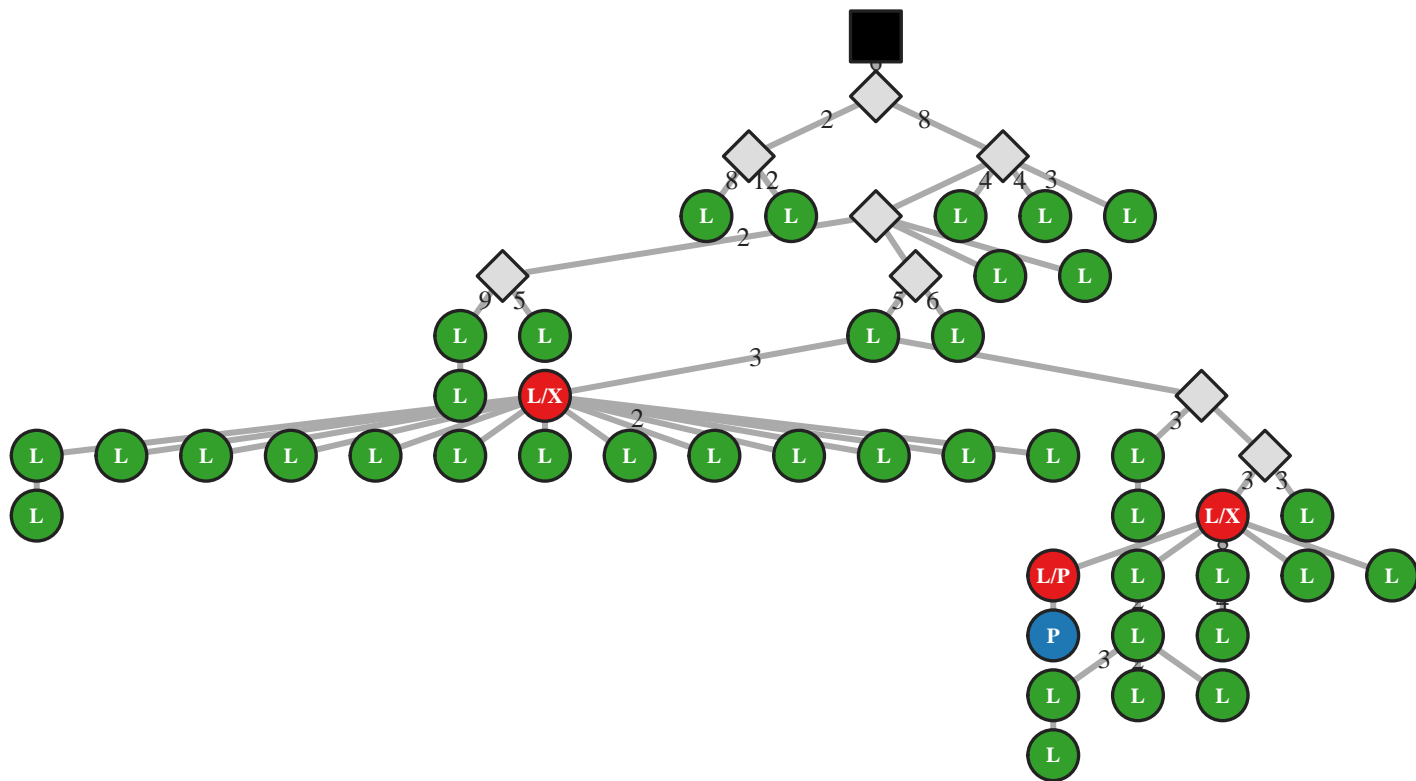

M5 IgG IGHV1-69/J4 39bp (40921)

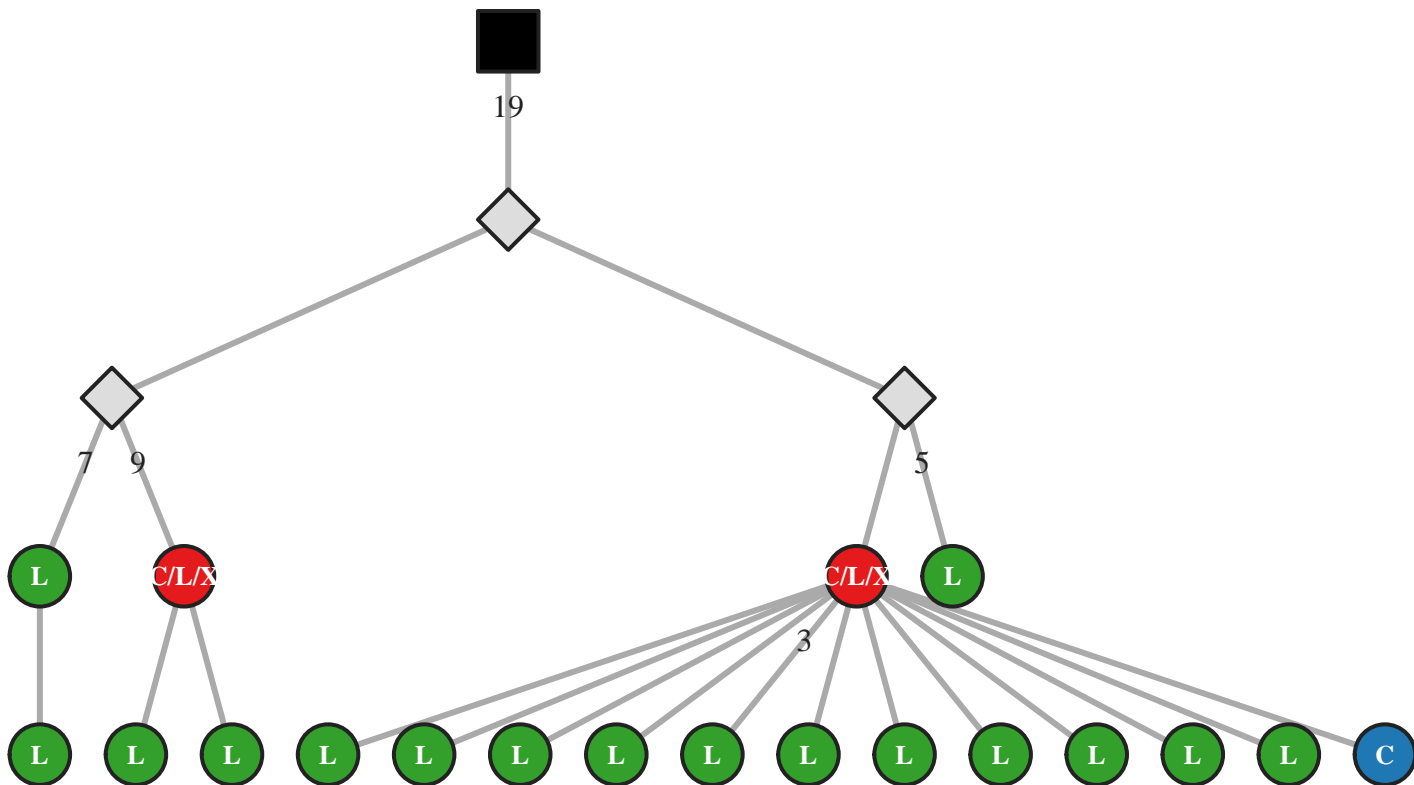

M5 IgG IGHV1-69/J4 39bp (40923)

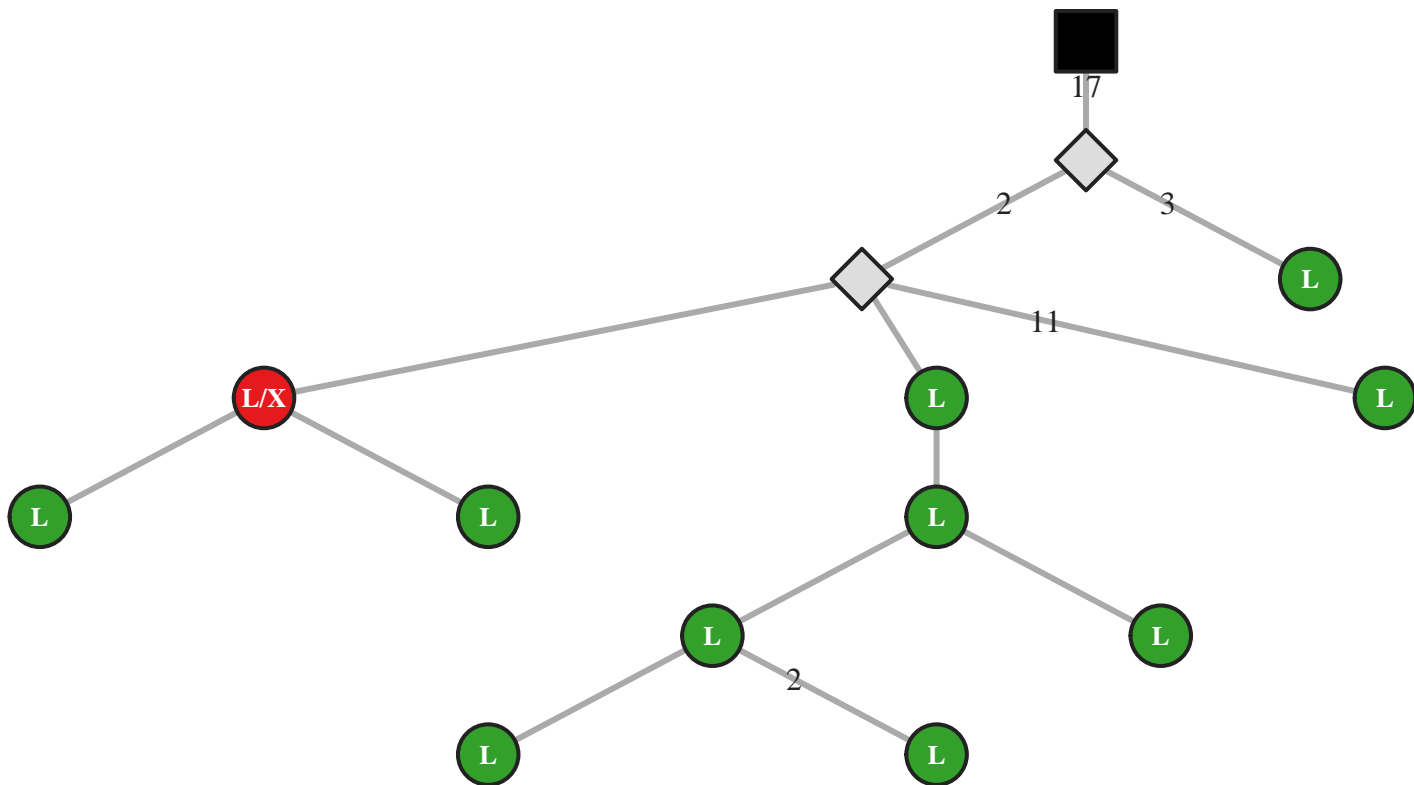

M5 IgG IGHV1-69/J4 39bp (40924)

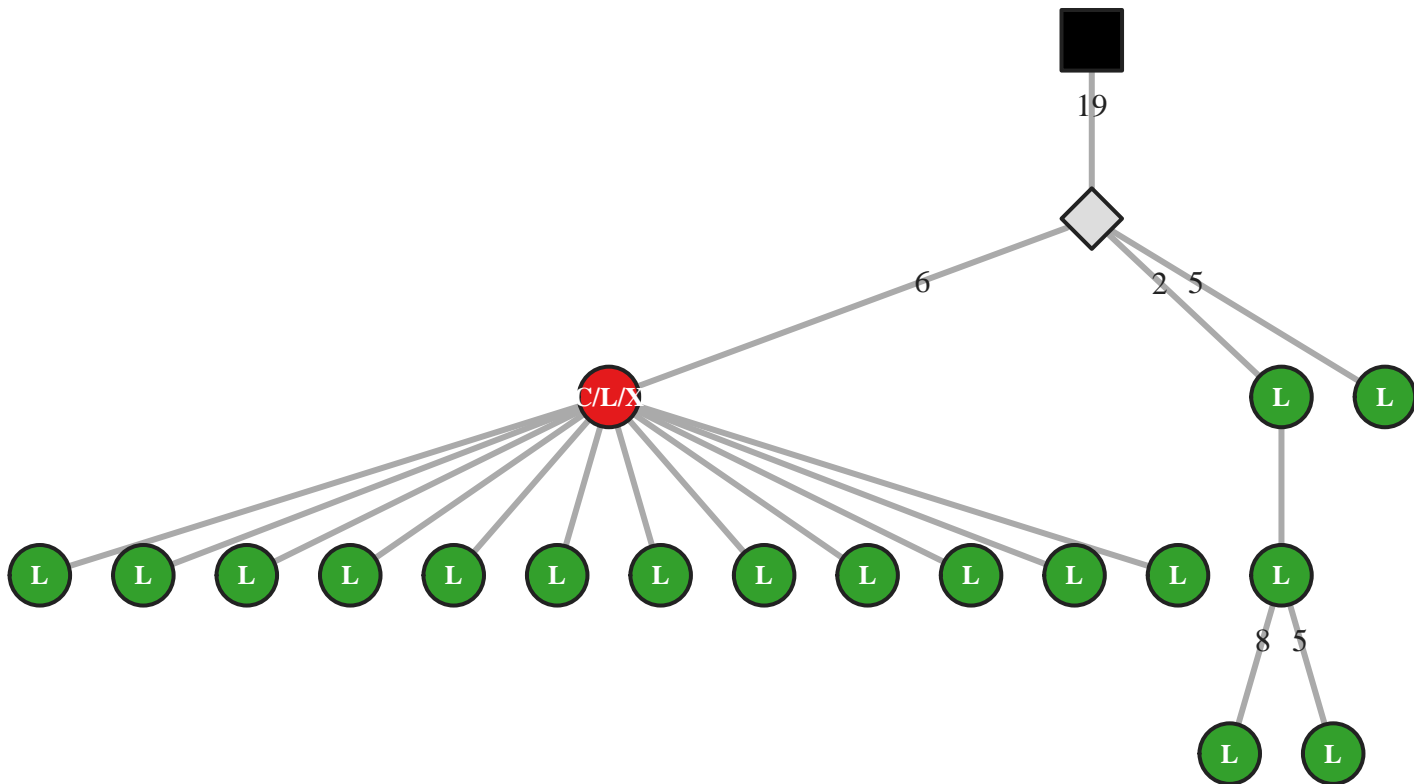

M5 IgG IGHV1-69/J4 39bp (40932)

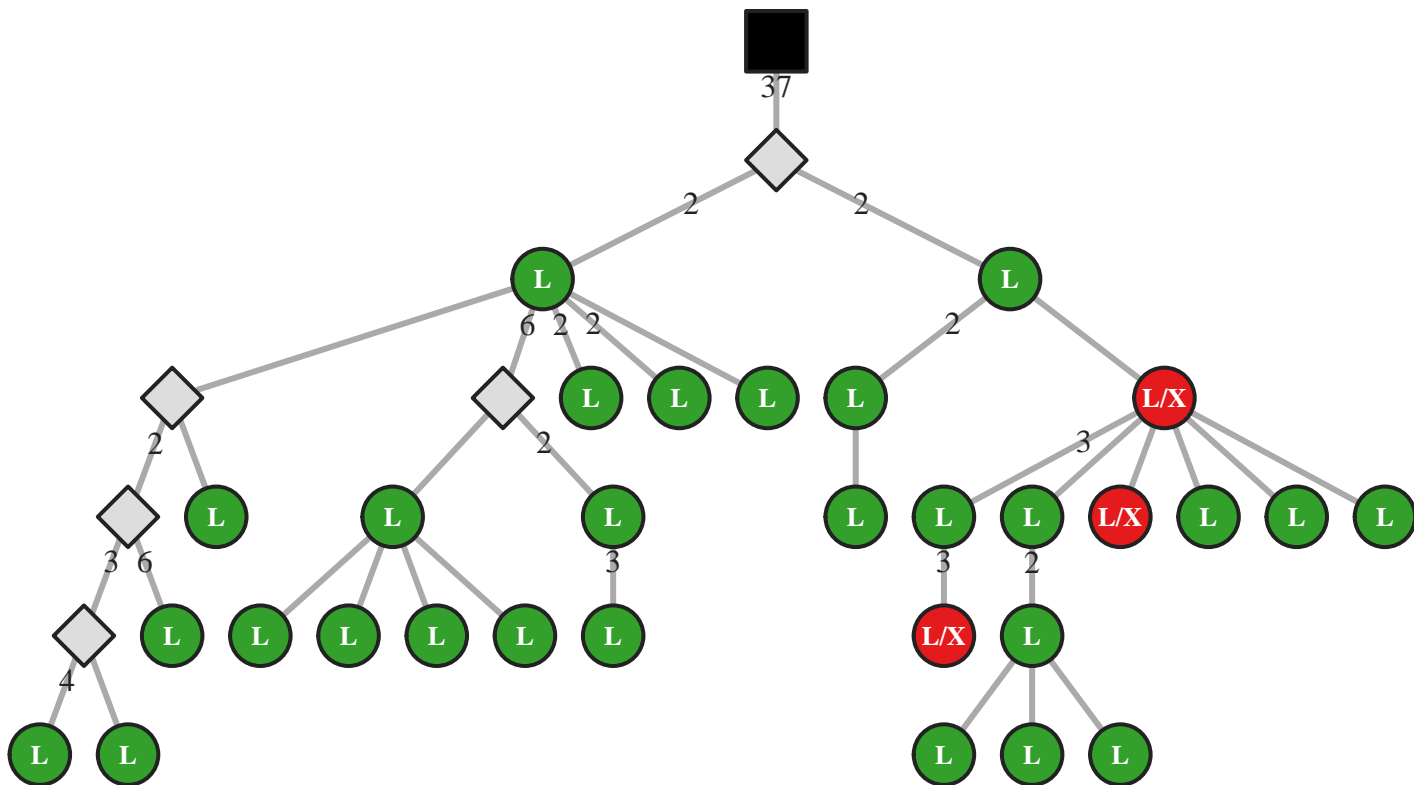

M5 IgG IGHV1-69/J4 39bp (40943)

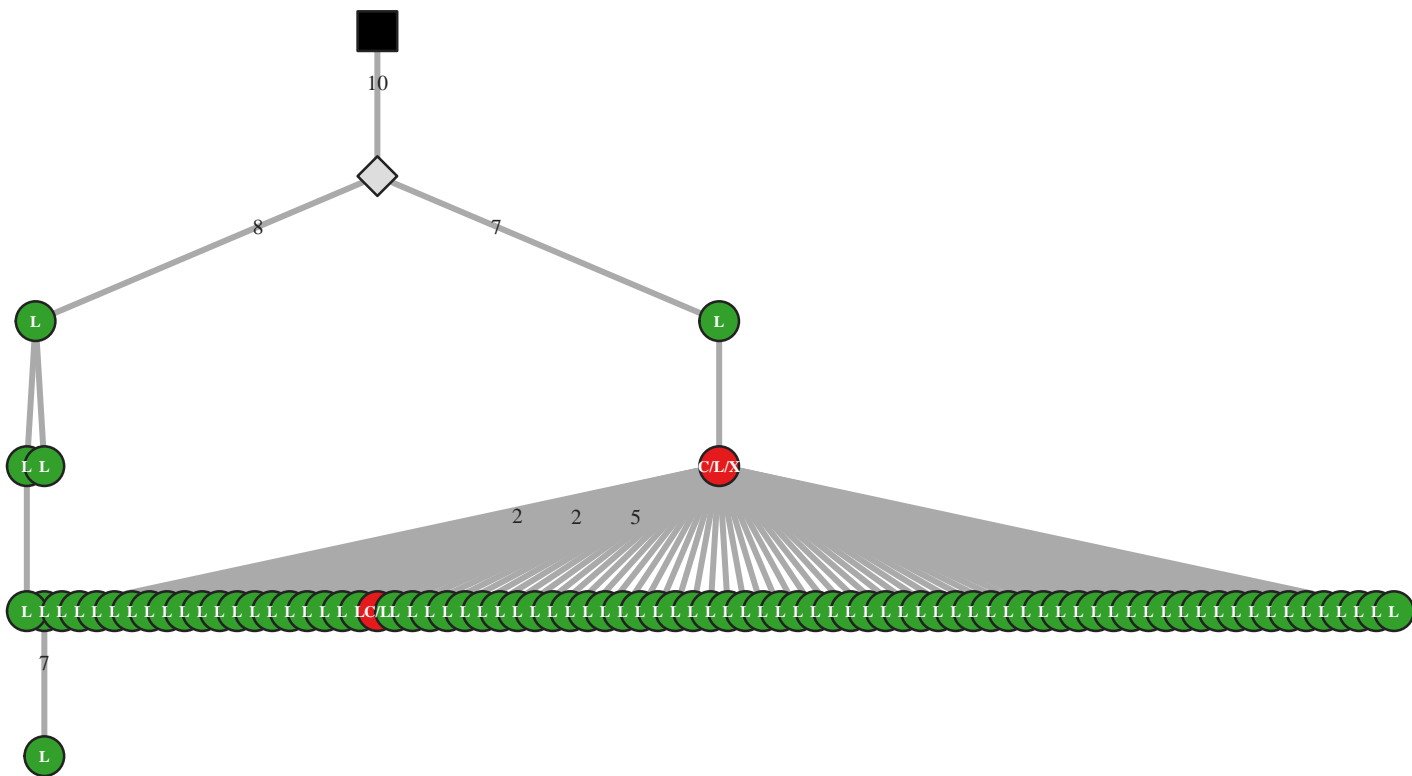

M5 IgG IGHV1-69/J4 39bp (40953)

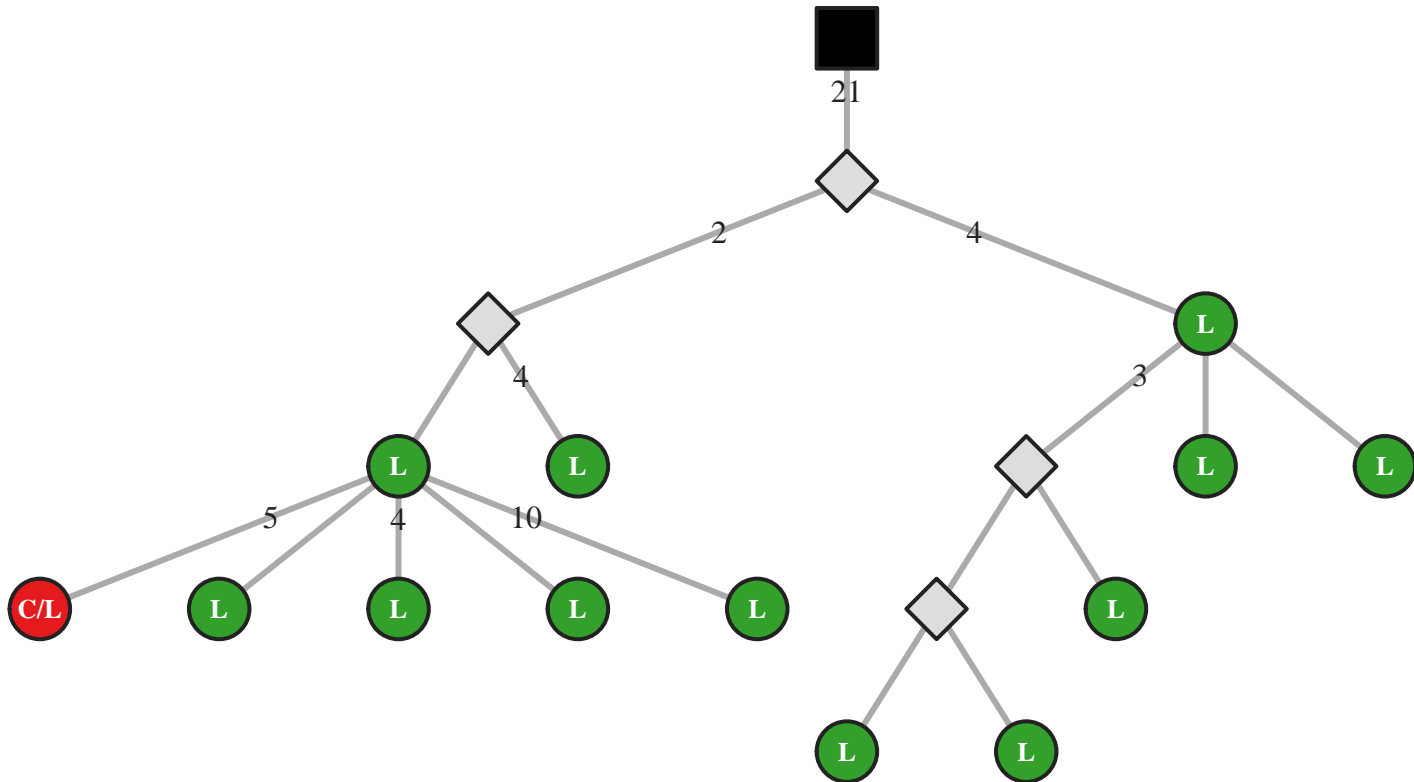

M5 IgG IGHV1-69/J4 39bp (40962)

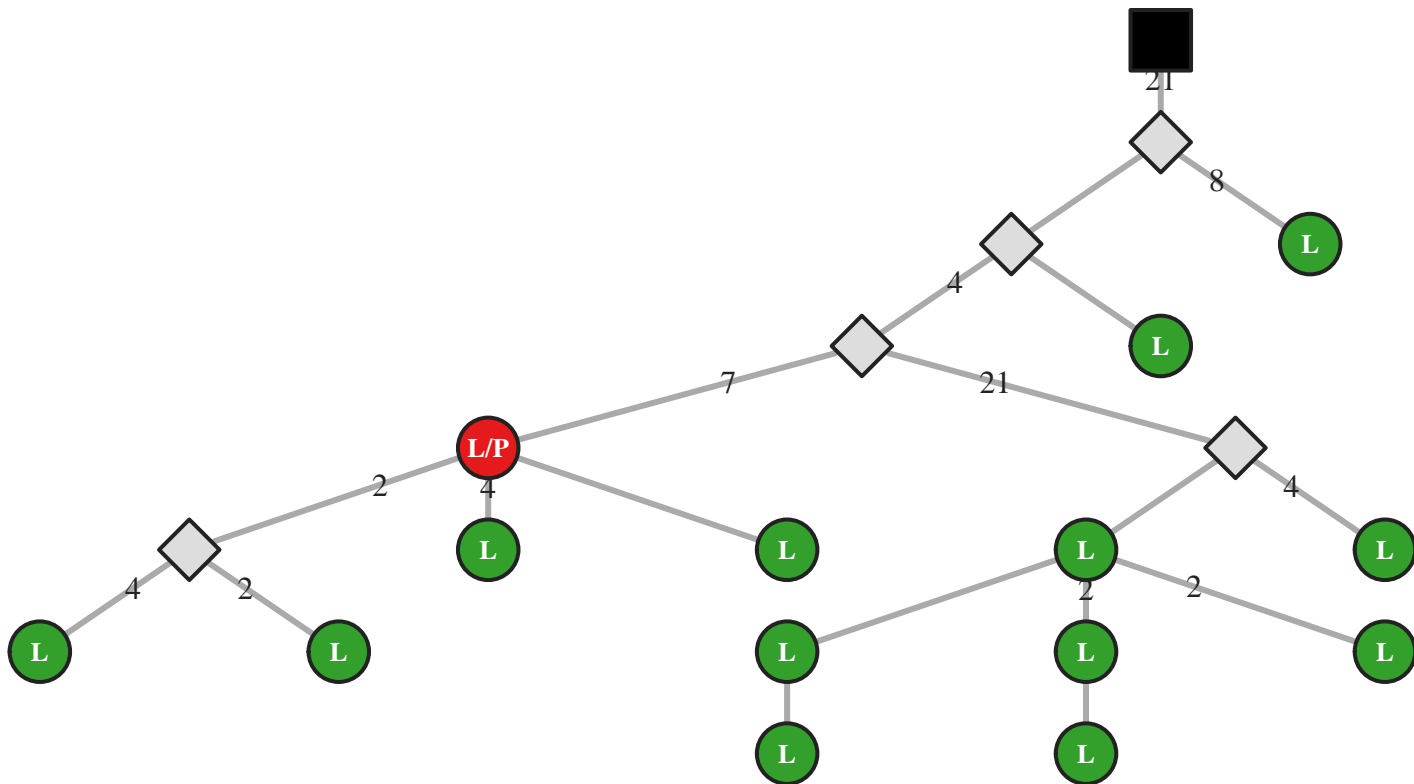

M5 IgG IGHV1-69/J4 39bp (40987)

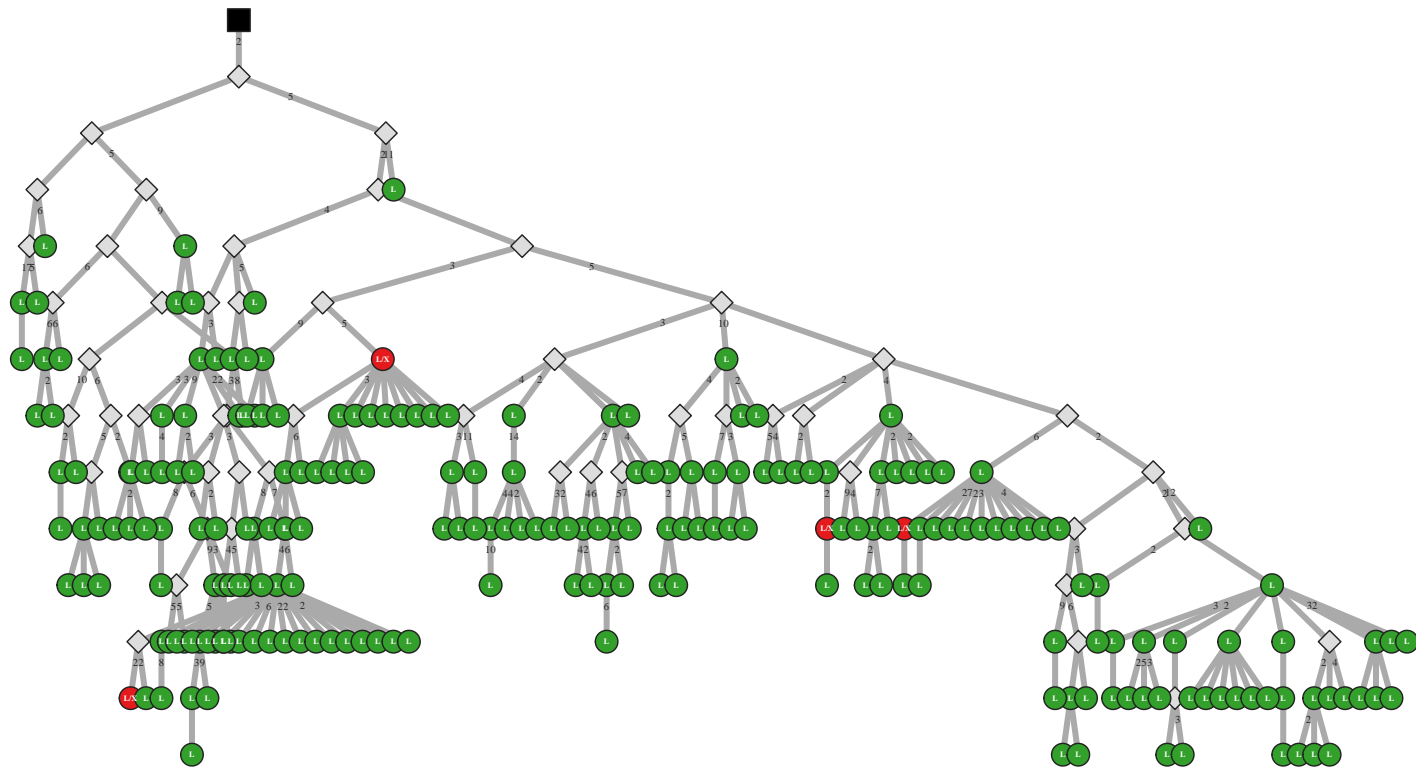

M5 IgA IGHV1-69/J4 42bp (12010)

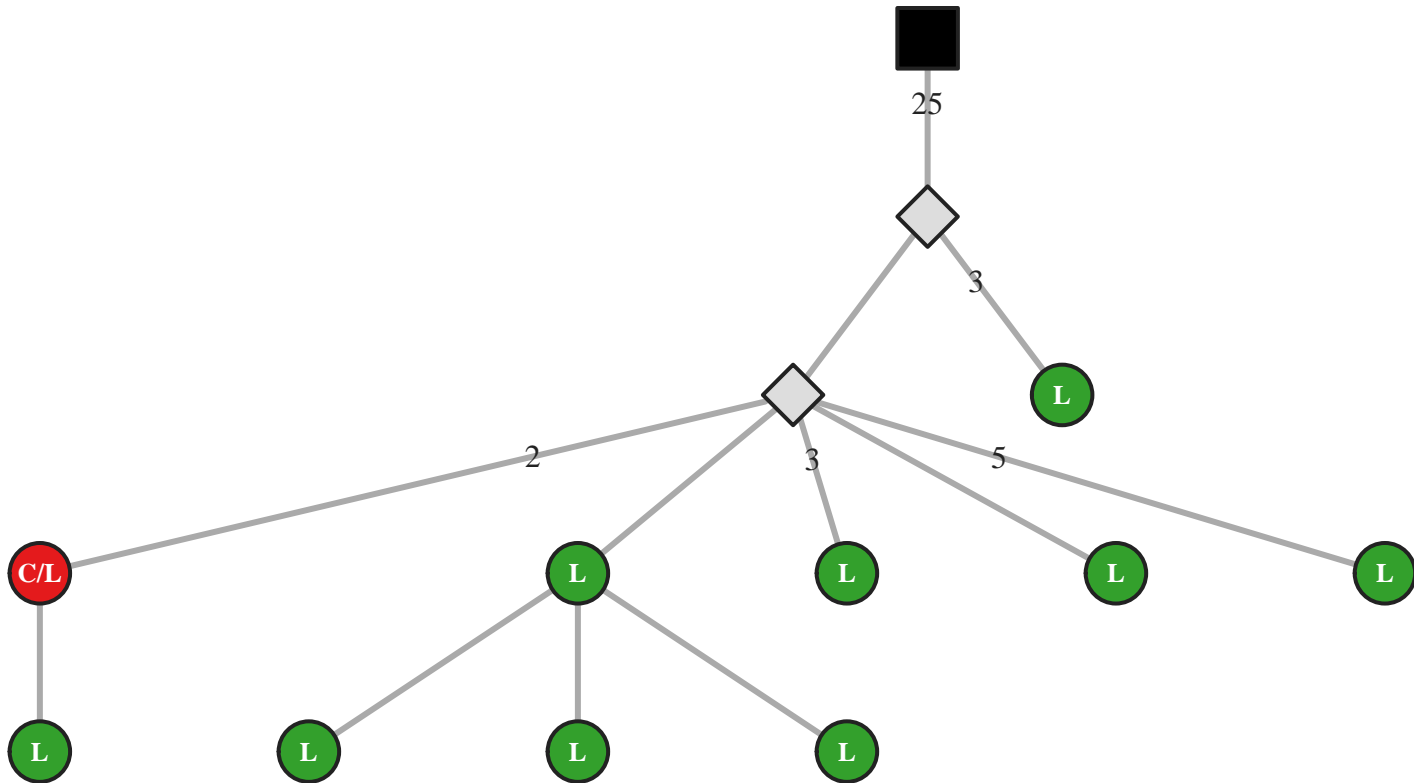

M5 IgG IGHV1-69/J4 42bp (14649)

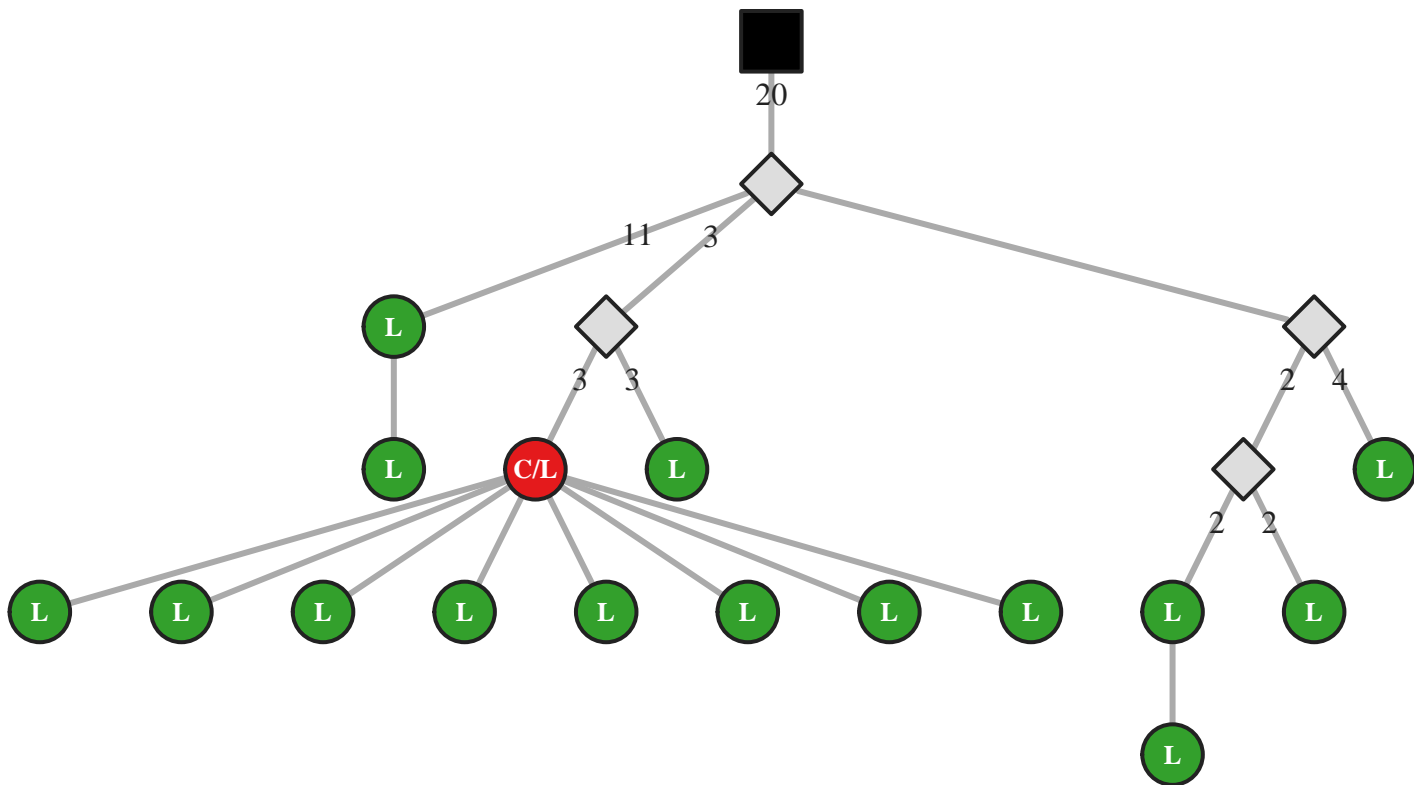

M5 IgG IGHV1-69/J4 42bp (14668)

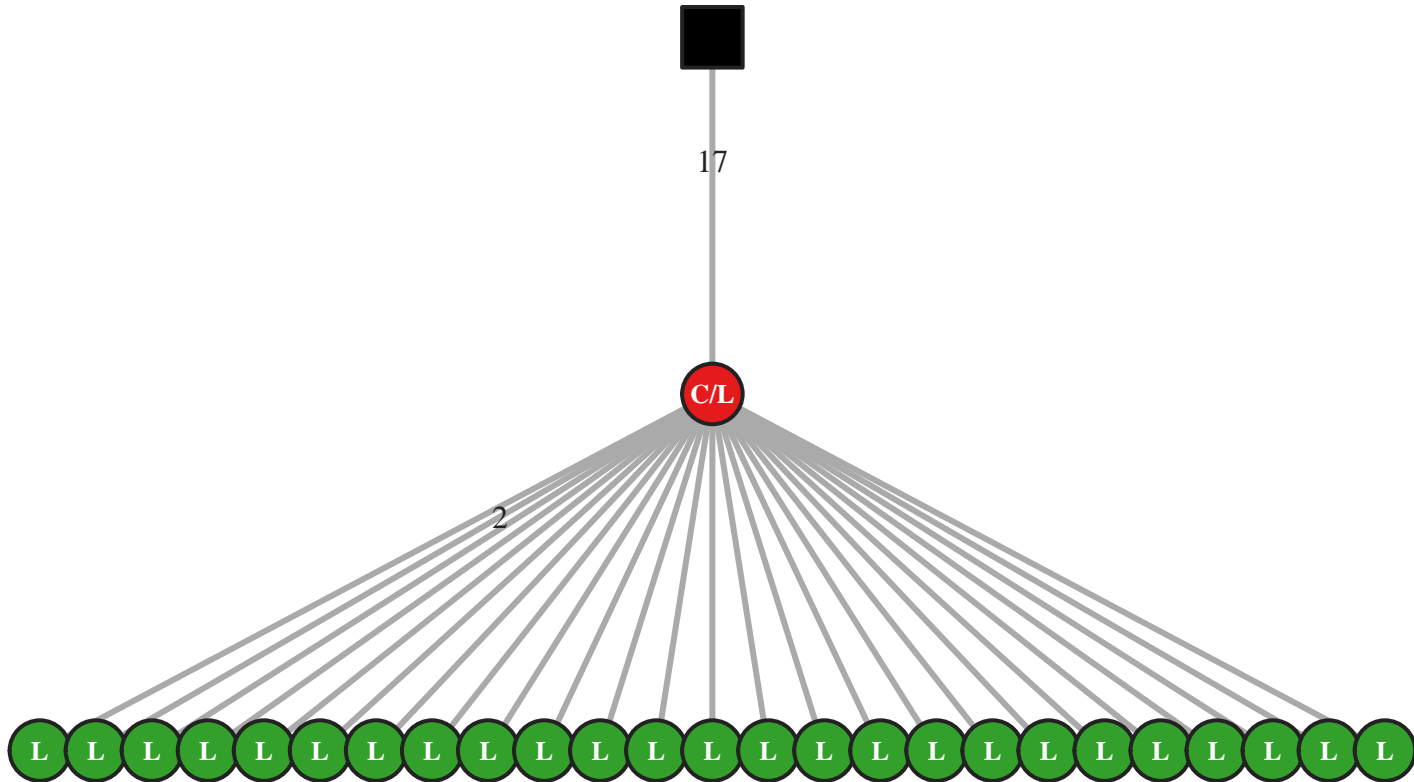

M5 IgG IGHV1-69/J4 42bp (14712)

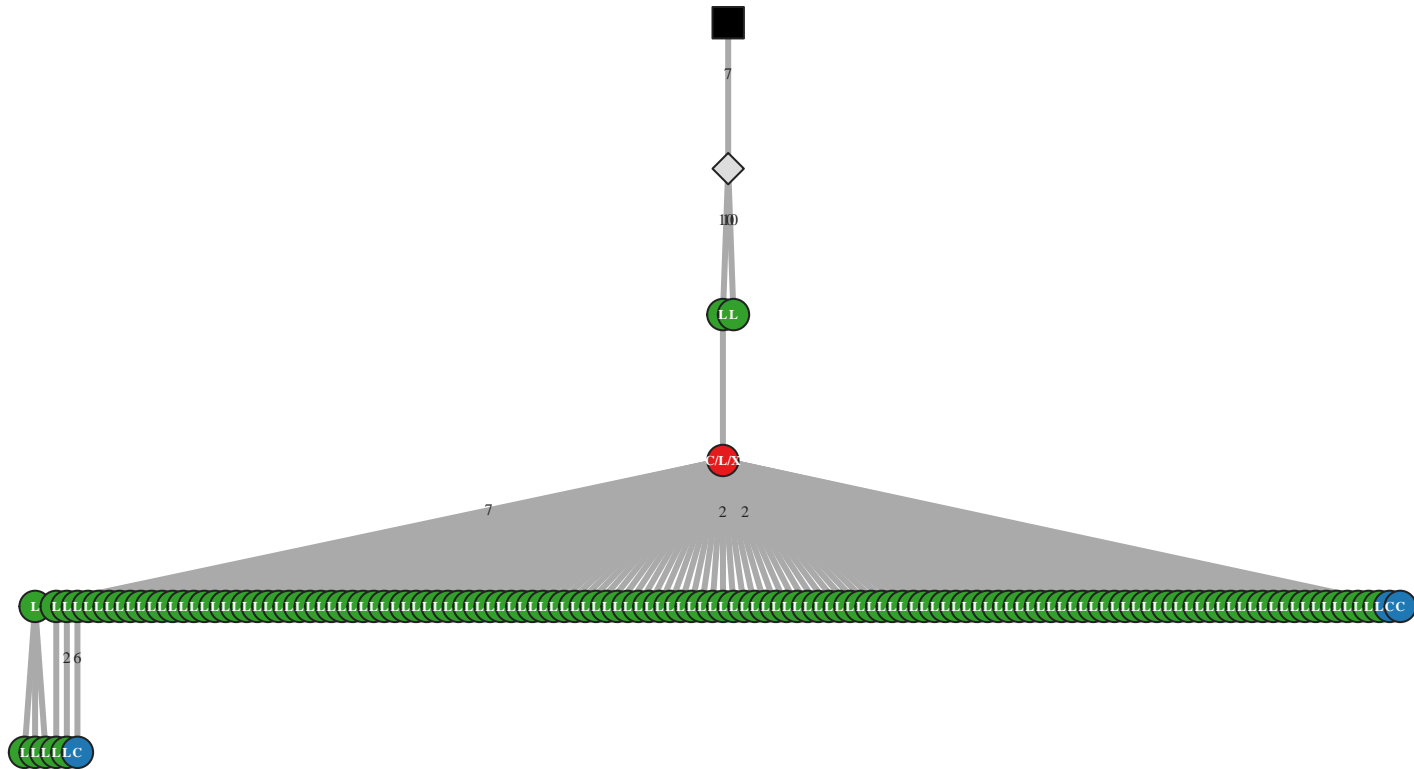

M5 IgG IGHV1-69/J4 42bp (14723)

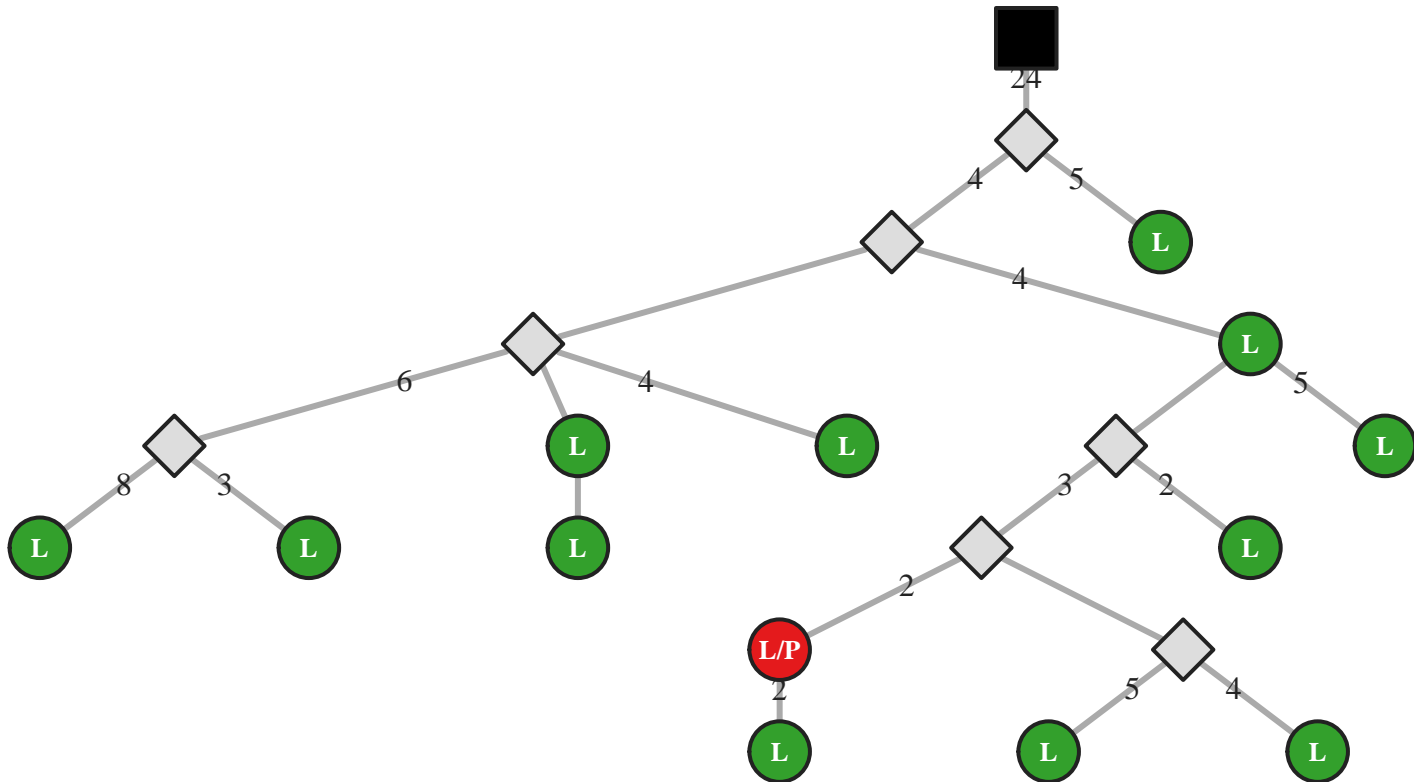

M5 IgG IGHV1-69/J4 42bp (14732)

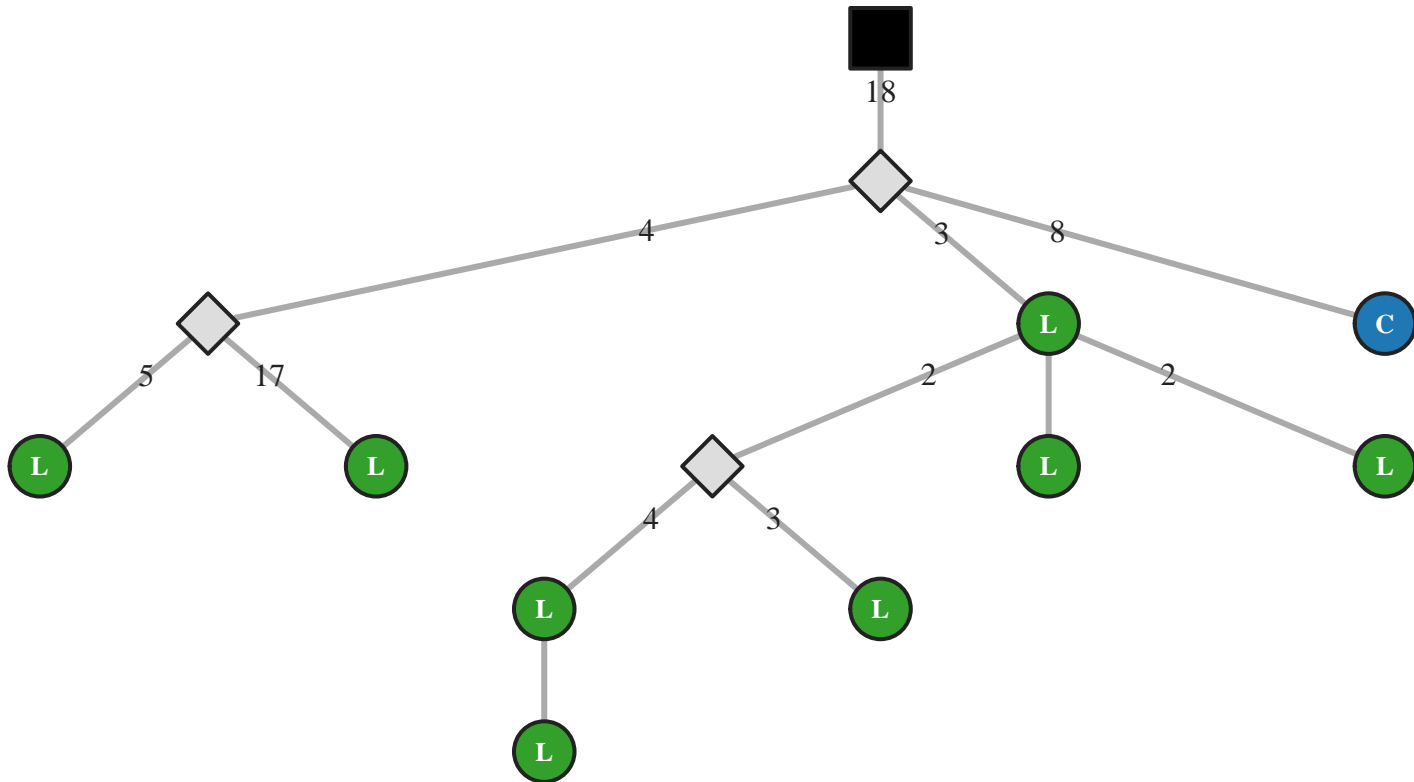

M5 IgG IGHV1-69/J4 42bp (14777)

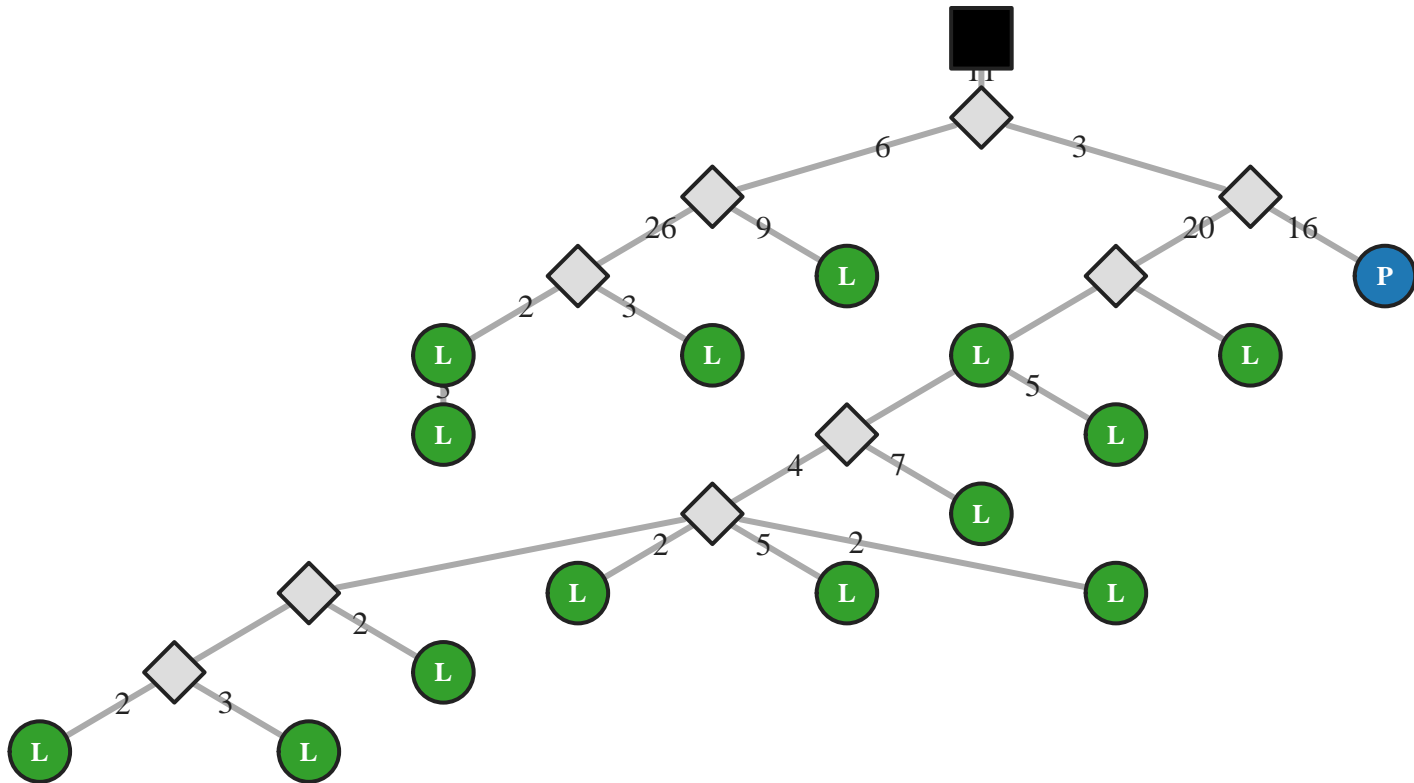

M5 IgA IGHV1-69/J4 45bp (2409)

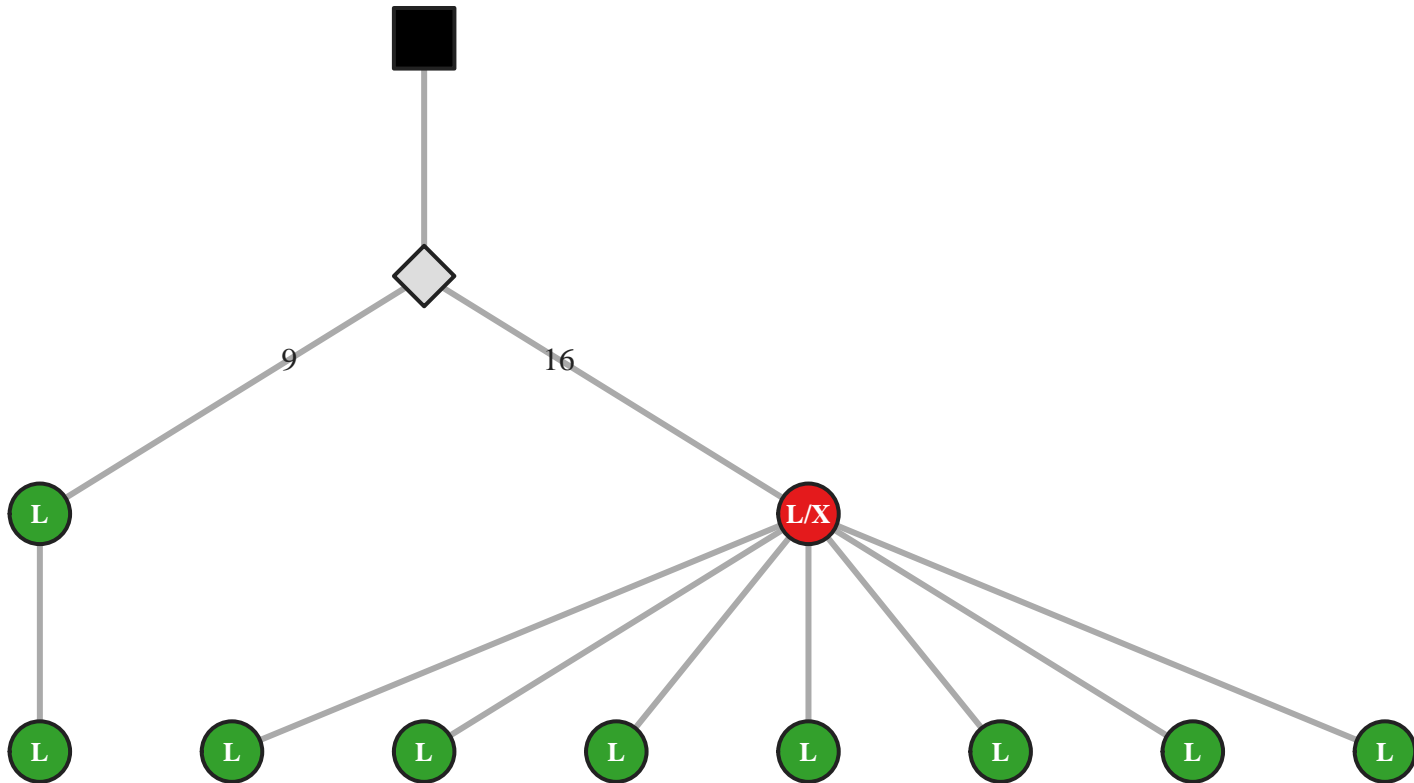

M5 IgG IGHV1-69/J4 45bp (41000)

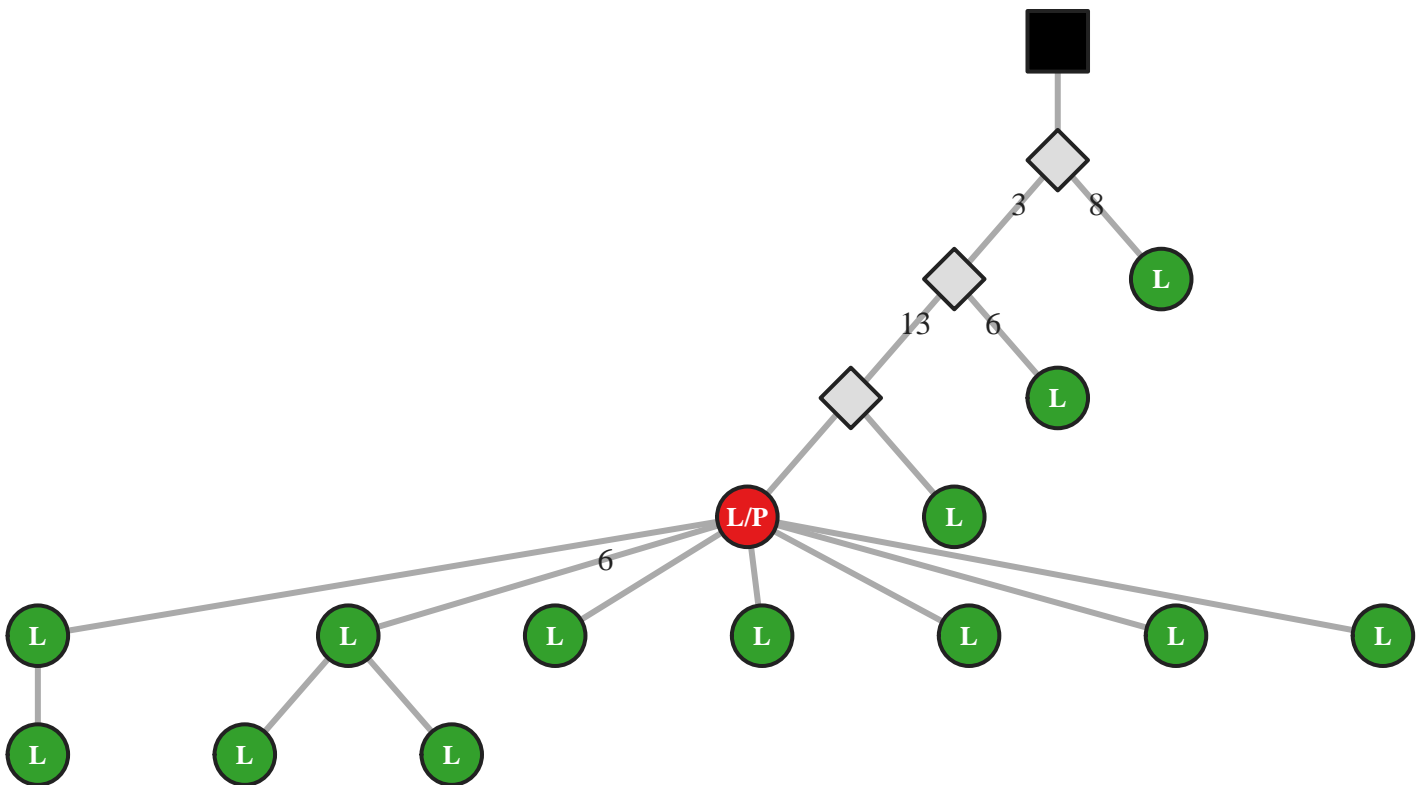

M5 IgG IGHV1-69/J4 45bp (41023)

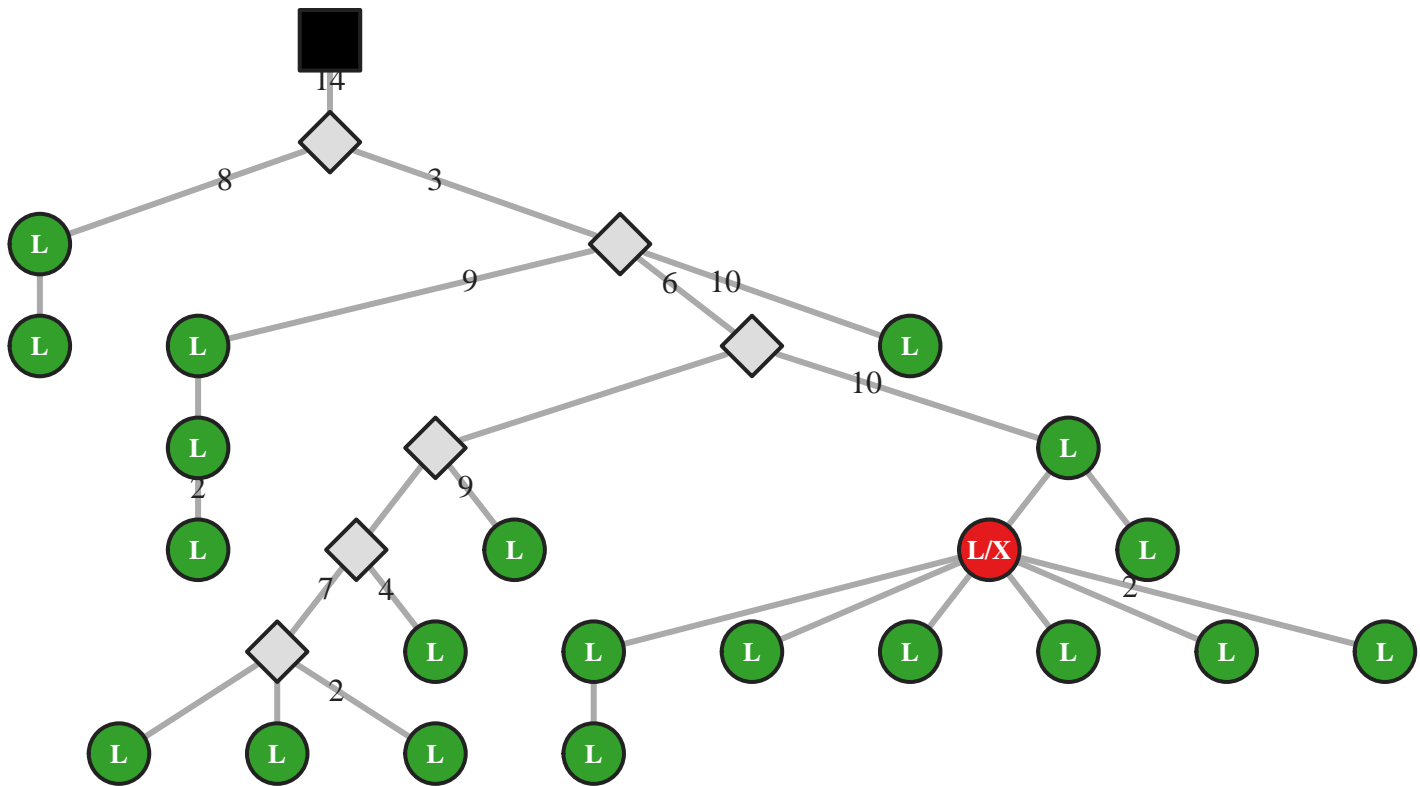

M5 IgG IGHV1-69/J4 45bp (41024)

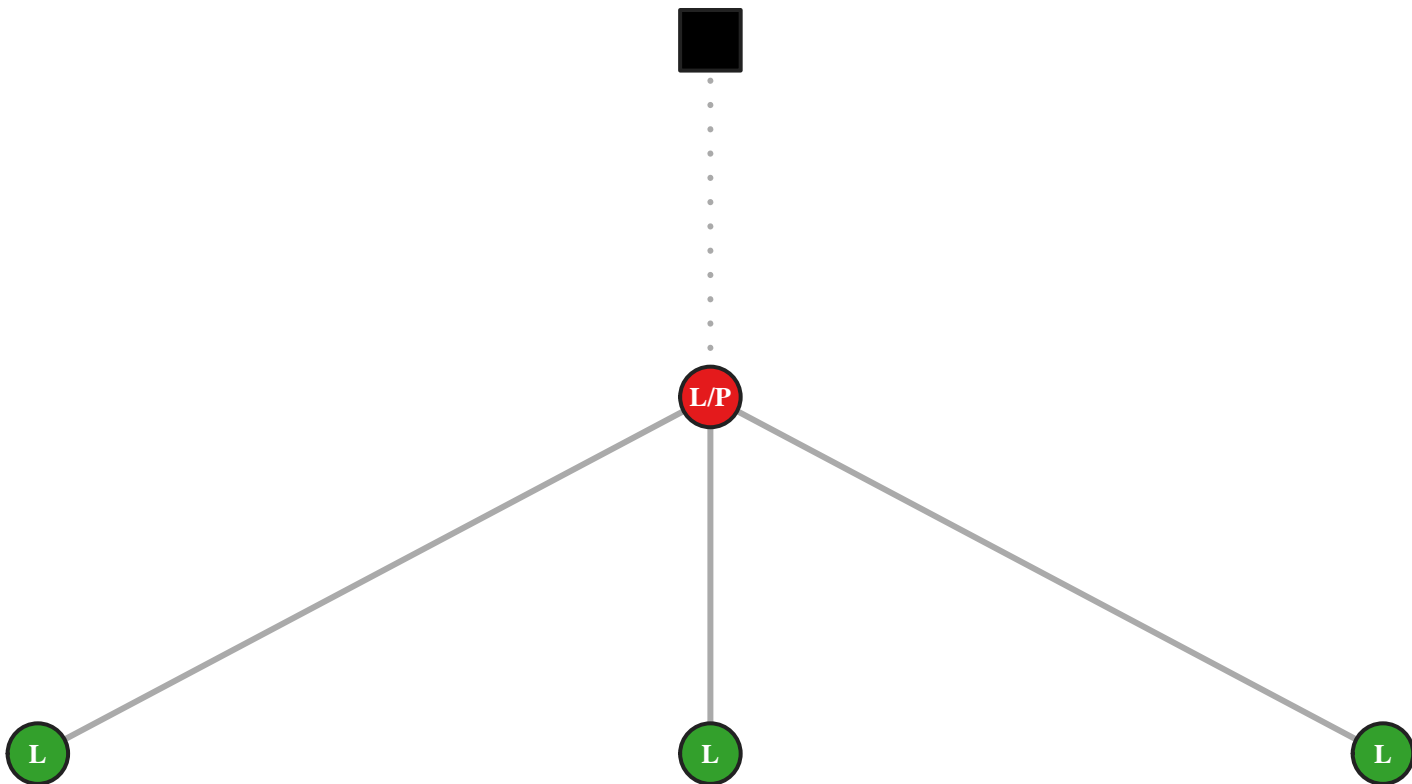

M5 IgG IGHV1-69/J4 45bp (41111)

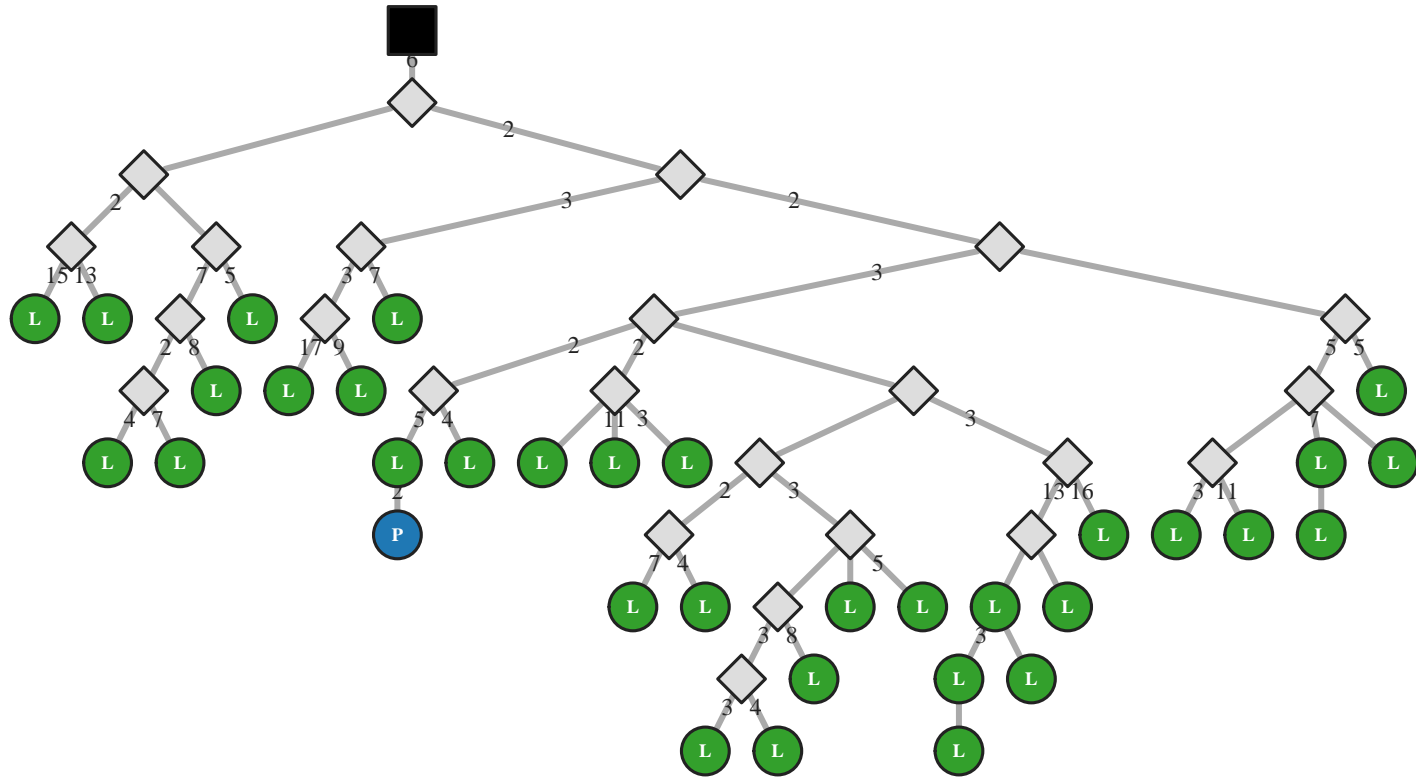

M5 IgG IGHV1-69/J4 45bp (41128)

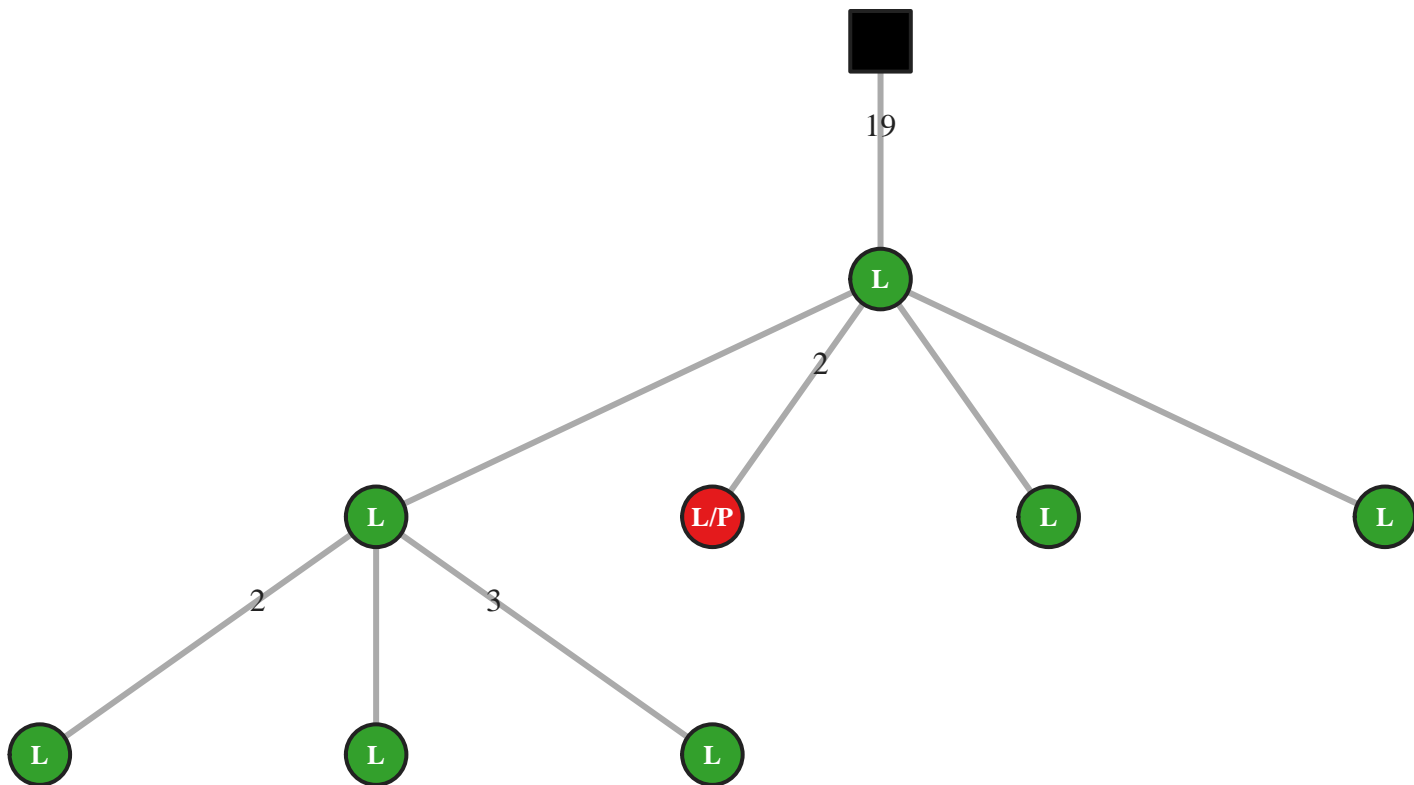

M5 IgG IGHV1-69/J4 45bp (41130)

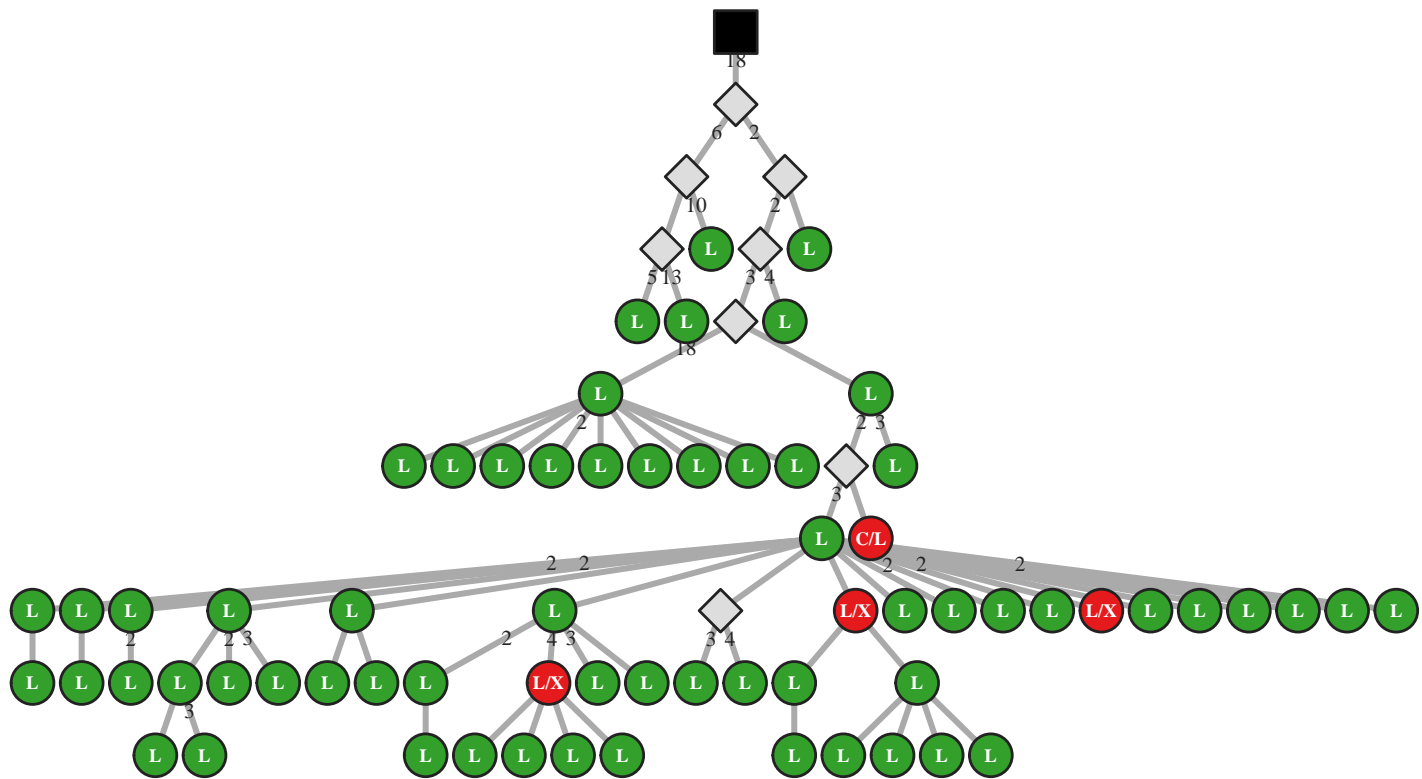

M5 IgG IGHV1-69/J4 45bp (41133)

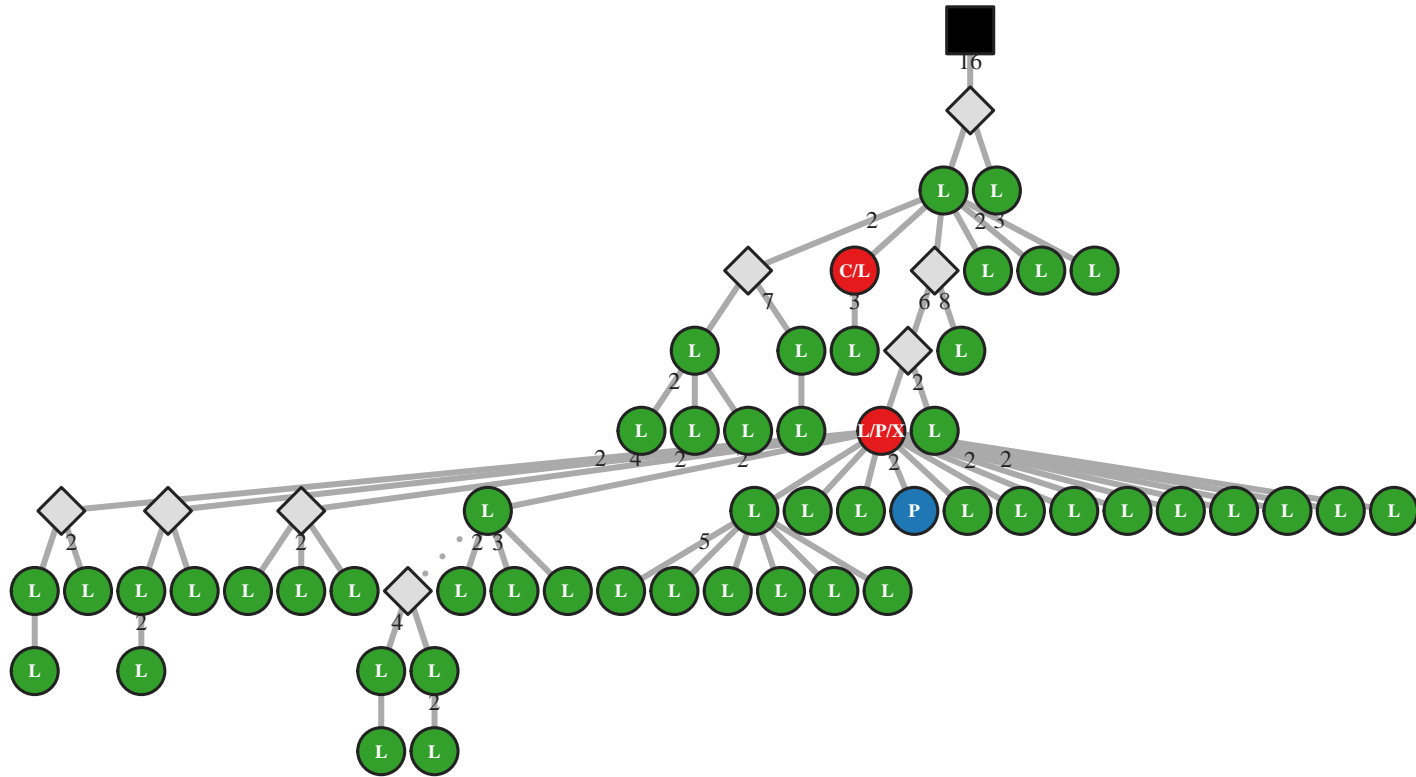

M5 IgG IGHV1-69/J4 45bp (41149)

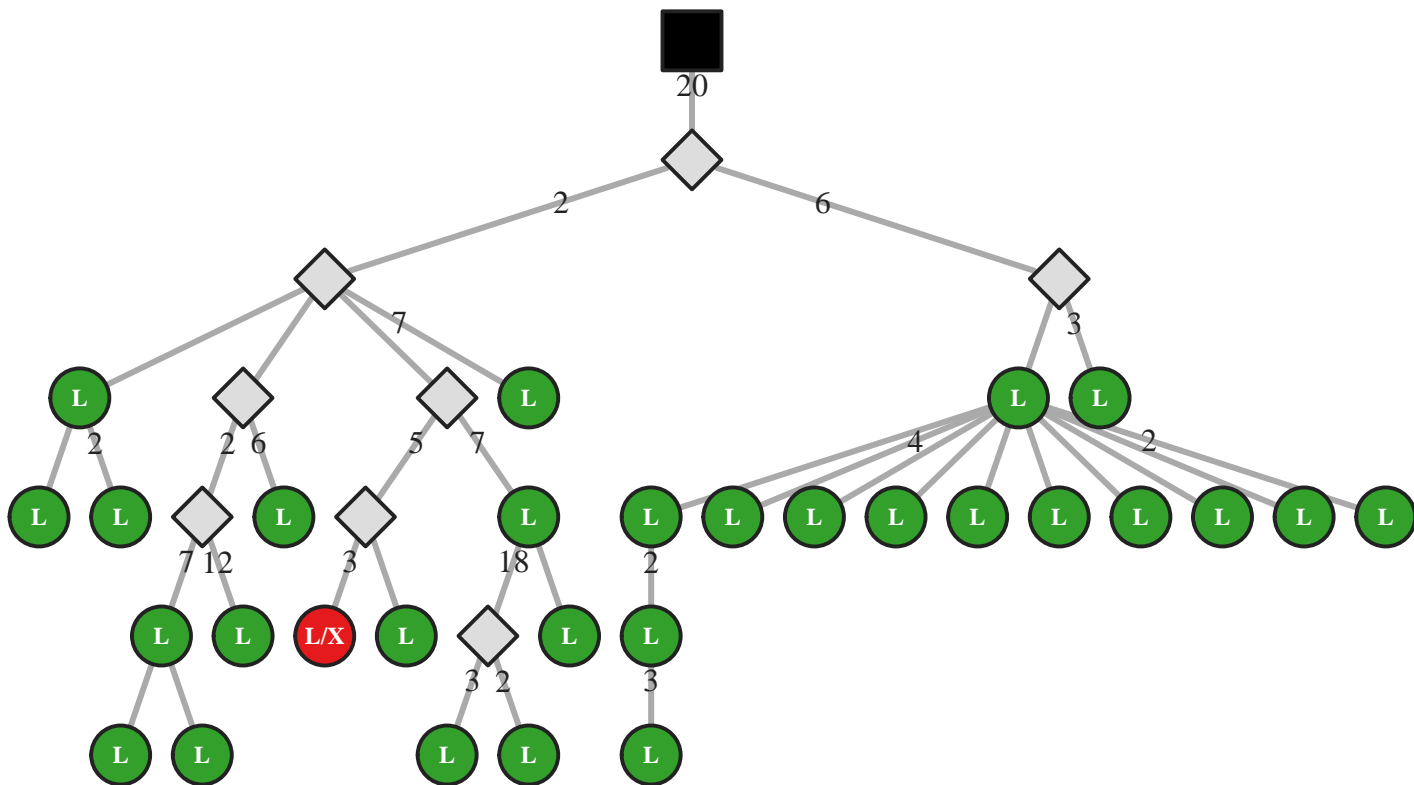

M5 IgG IGHV1-69/J4 45bp (41157)

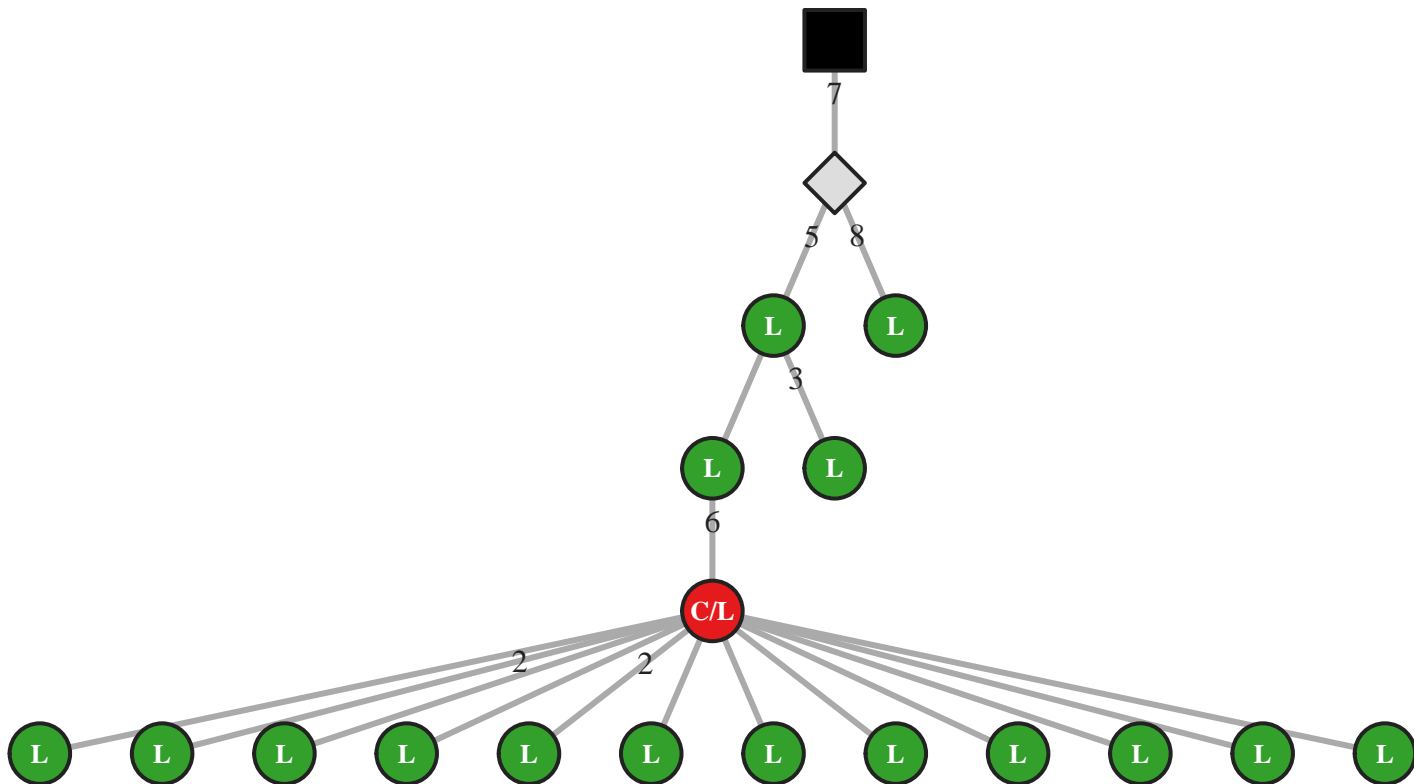

M5 IgG IGHV1-69/J4 45bp (41174)

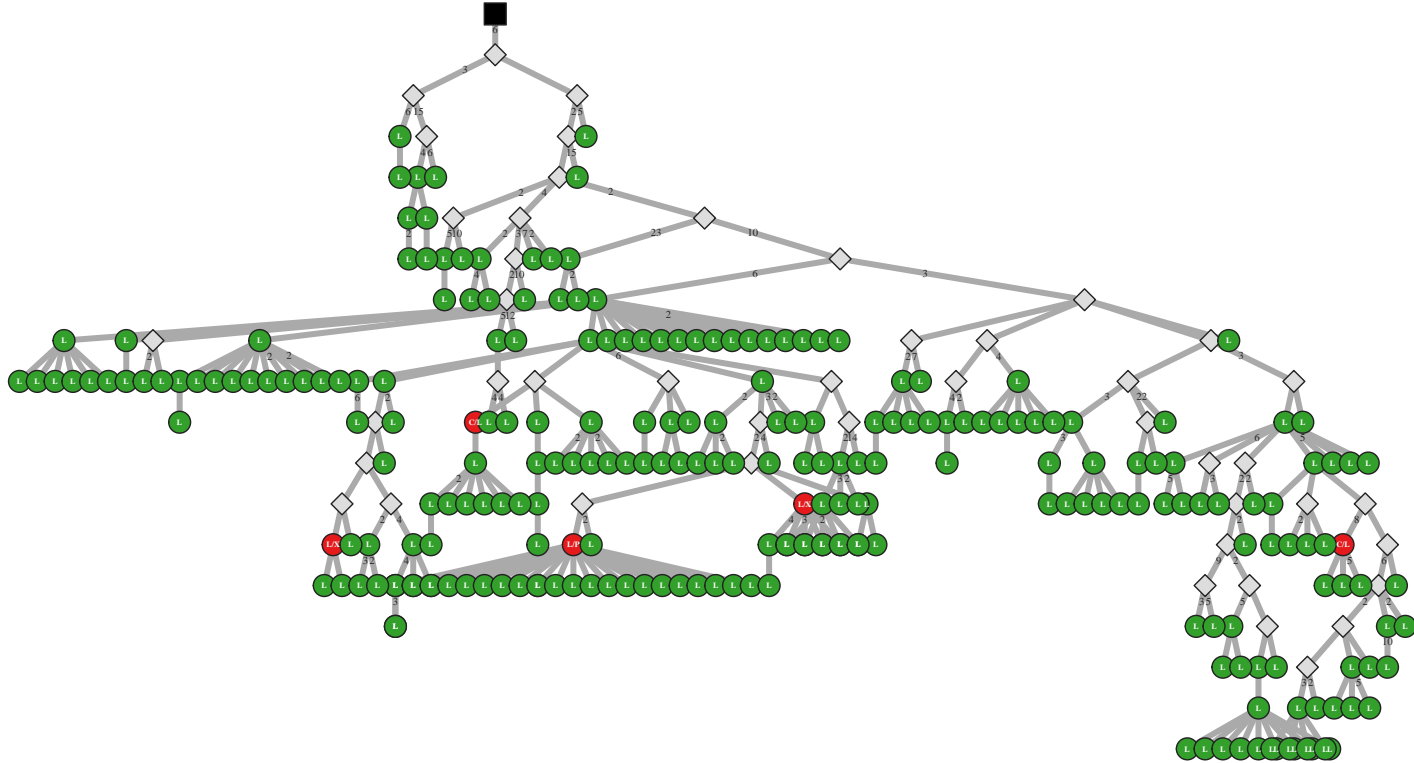

M5 IgG IGHV1-69/J4 45bp (41182)

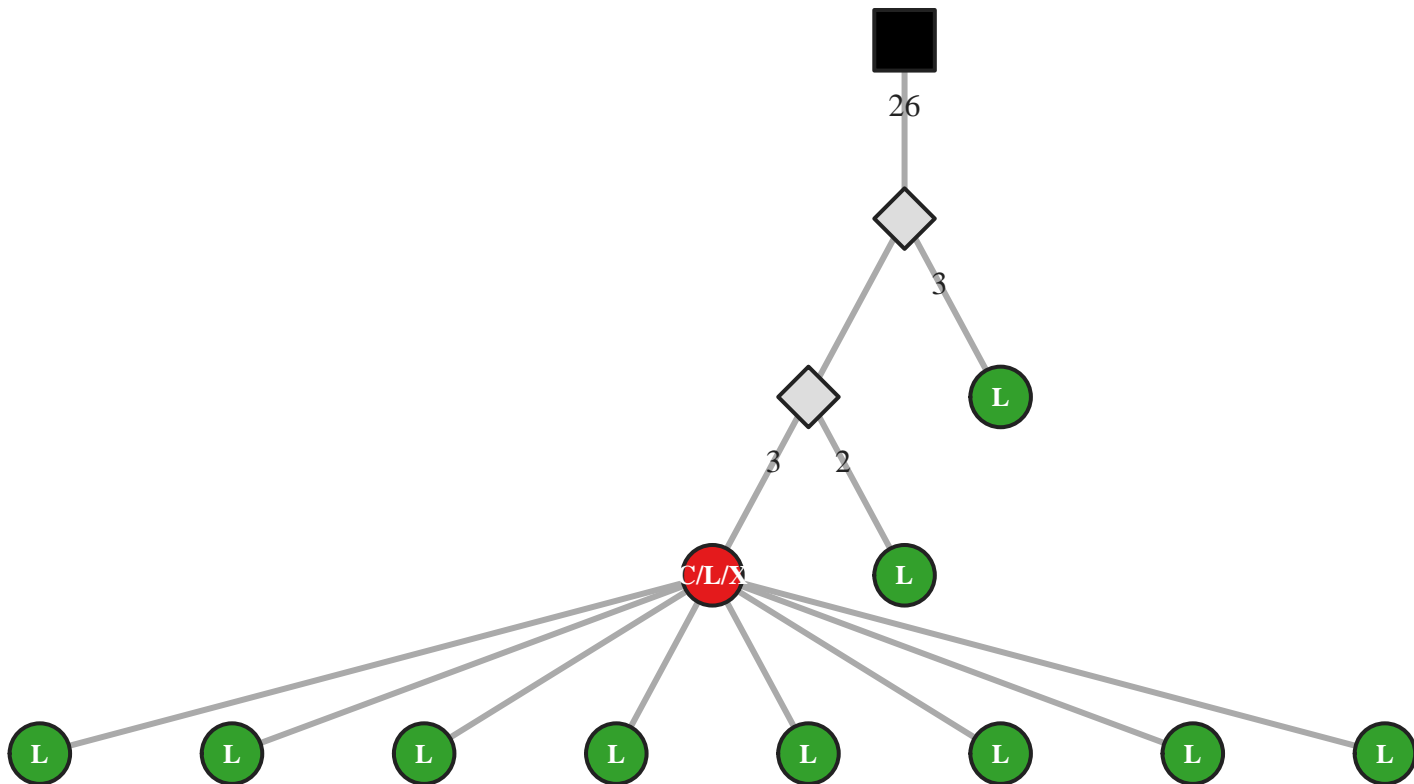

M5 IgG IGHV1-69/J4 48bp (41237)

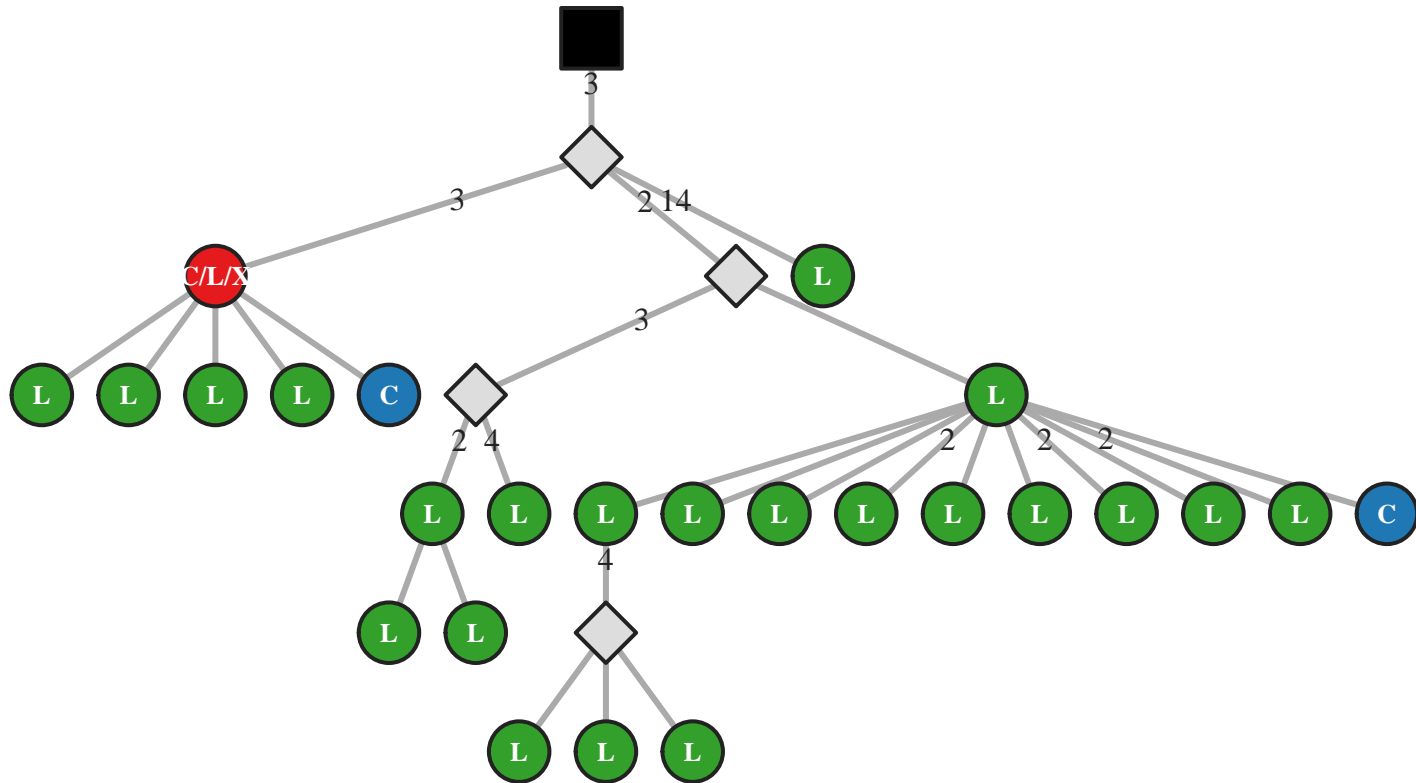

M5 IgG IGHV1-69/J4 48bp (41259)

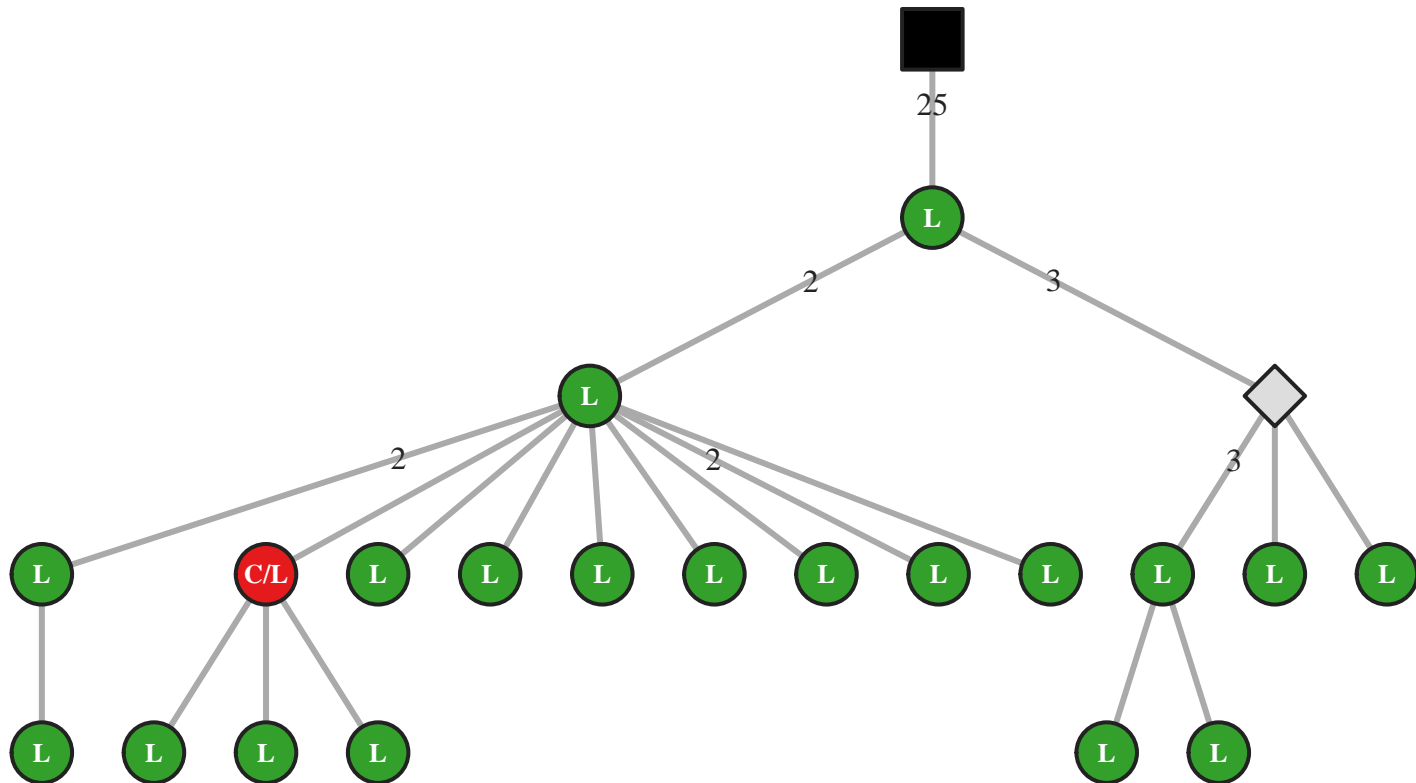

M5 IgG IGHV1-69/J4 48bp (41273)

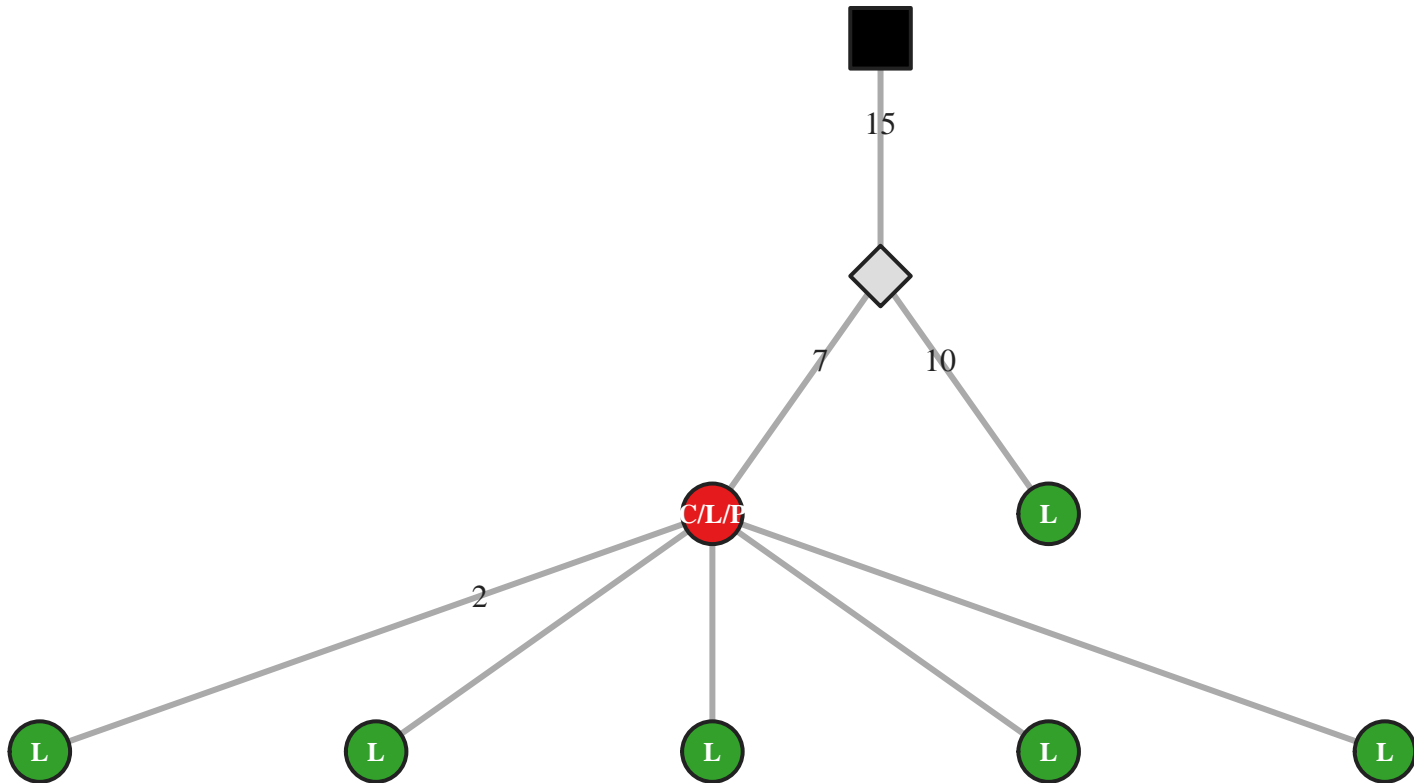

M5 IgG IGHV1-69/J4 48bp (41334)

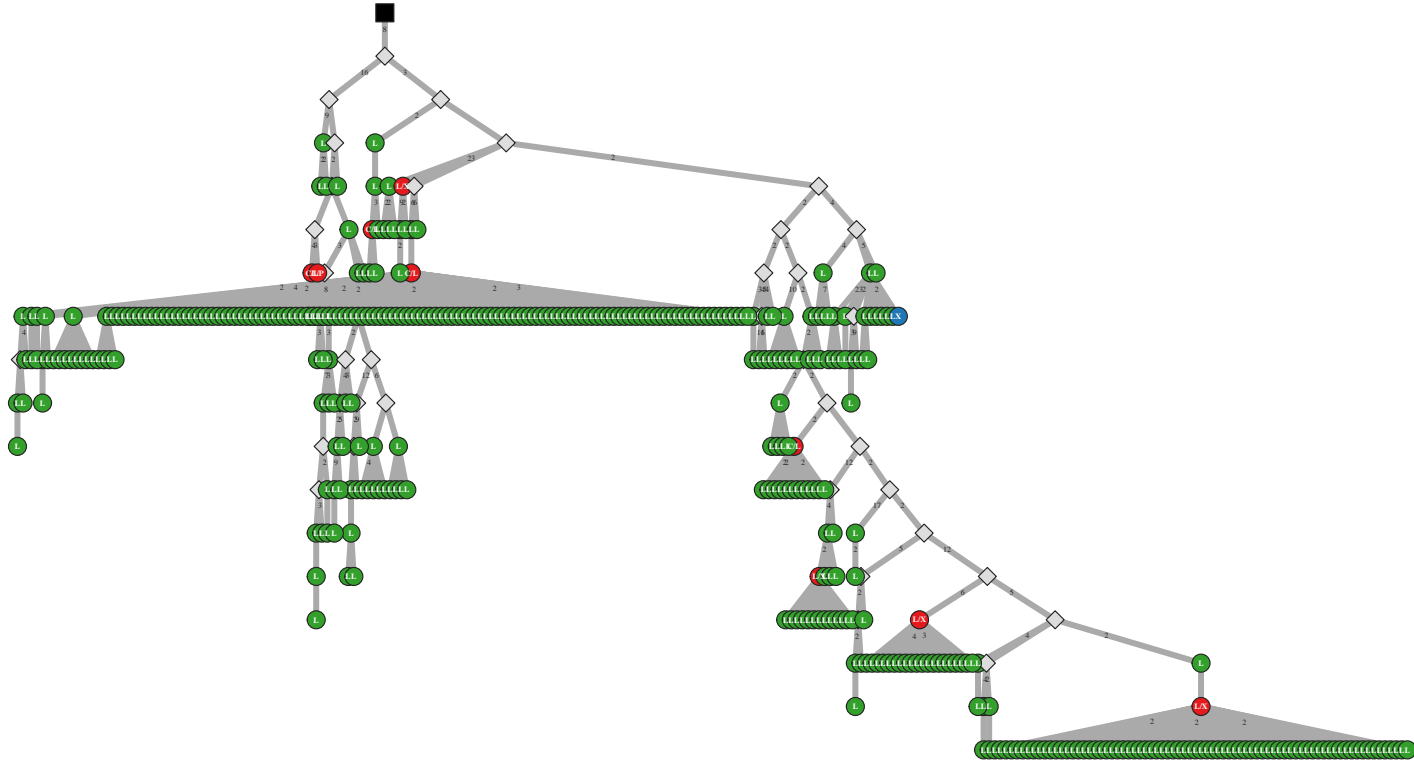

M5 IgG IGHV1-69/J4 48bp (41338)

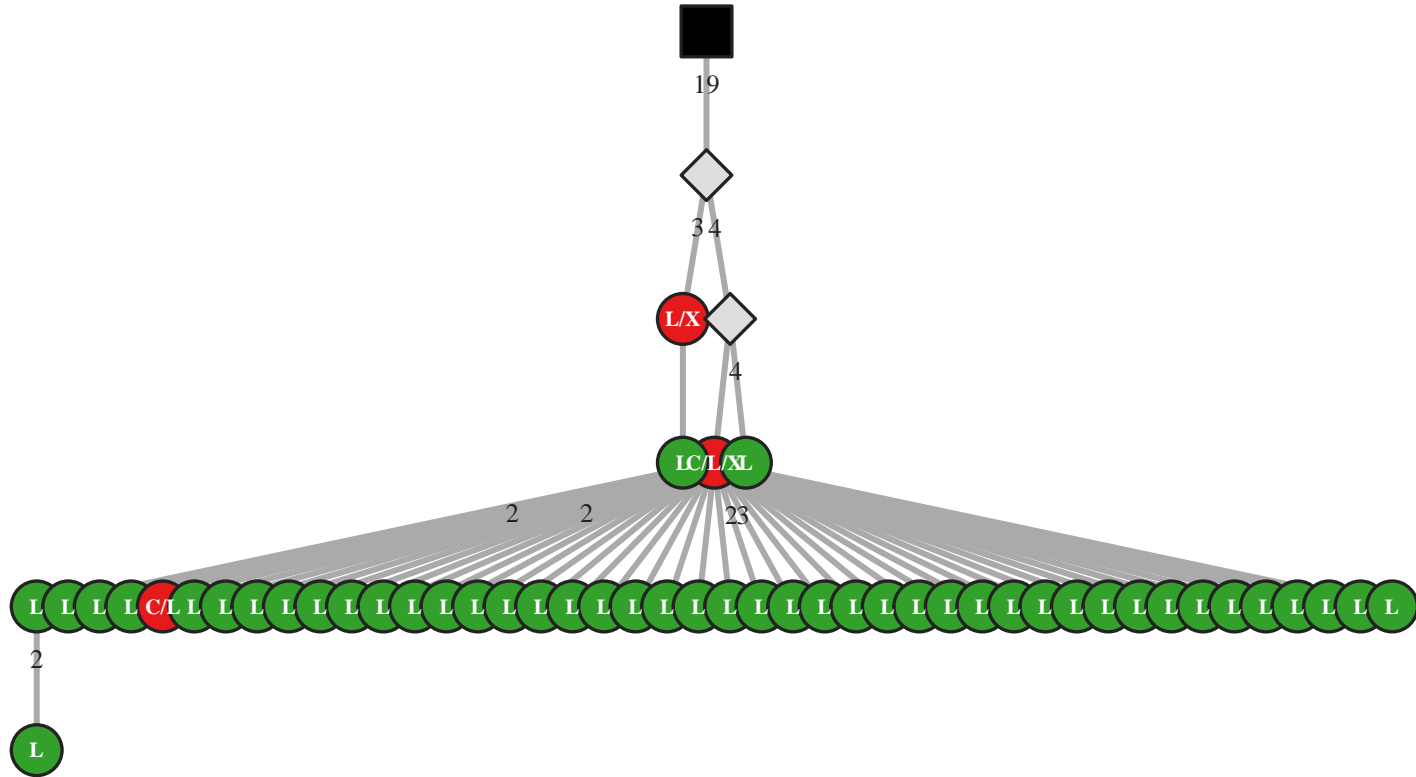

M5 IgG IGHV1-69/J4 48bp (41340)

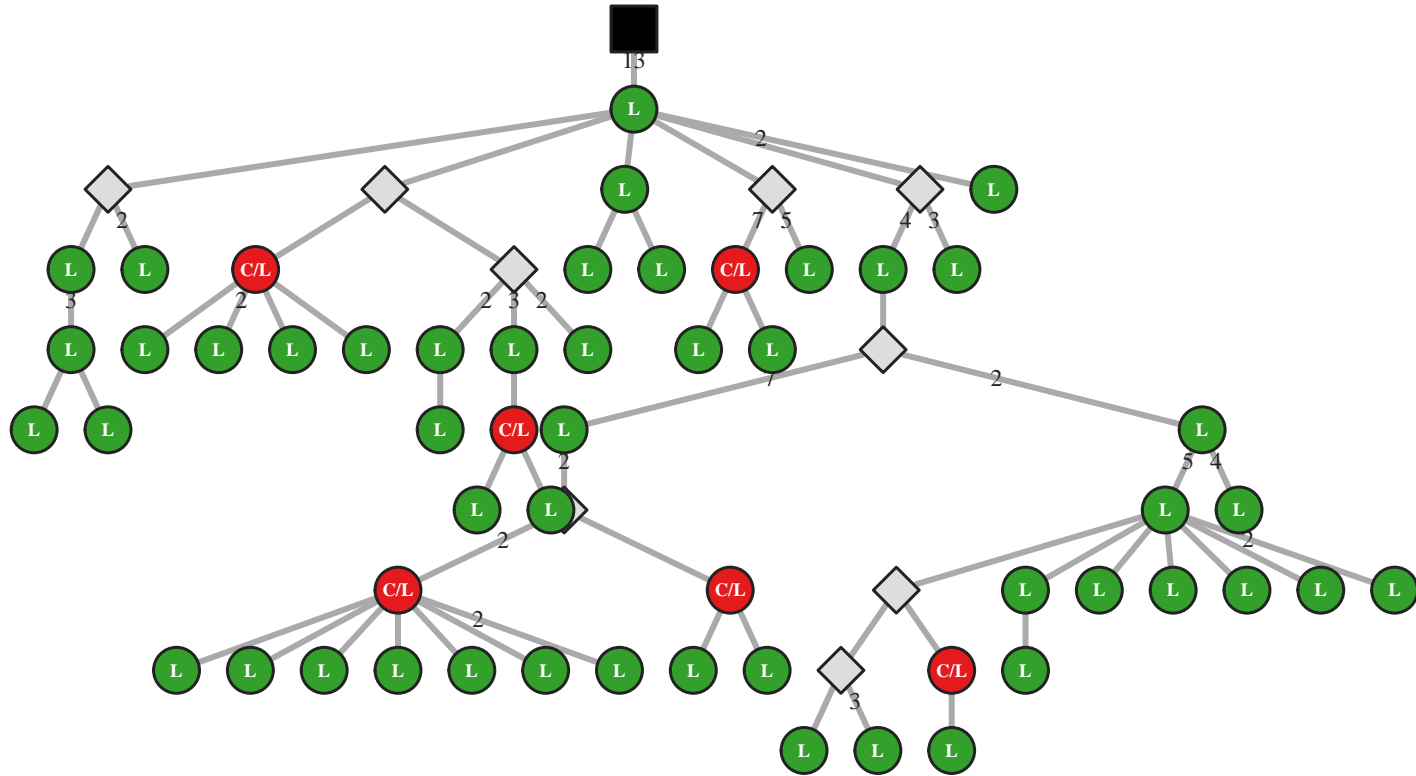

M5 IgG IGHV1-69/J4 48bp (41343)

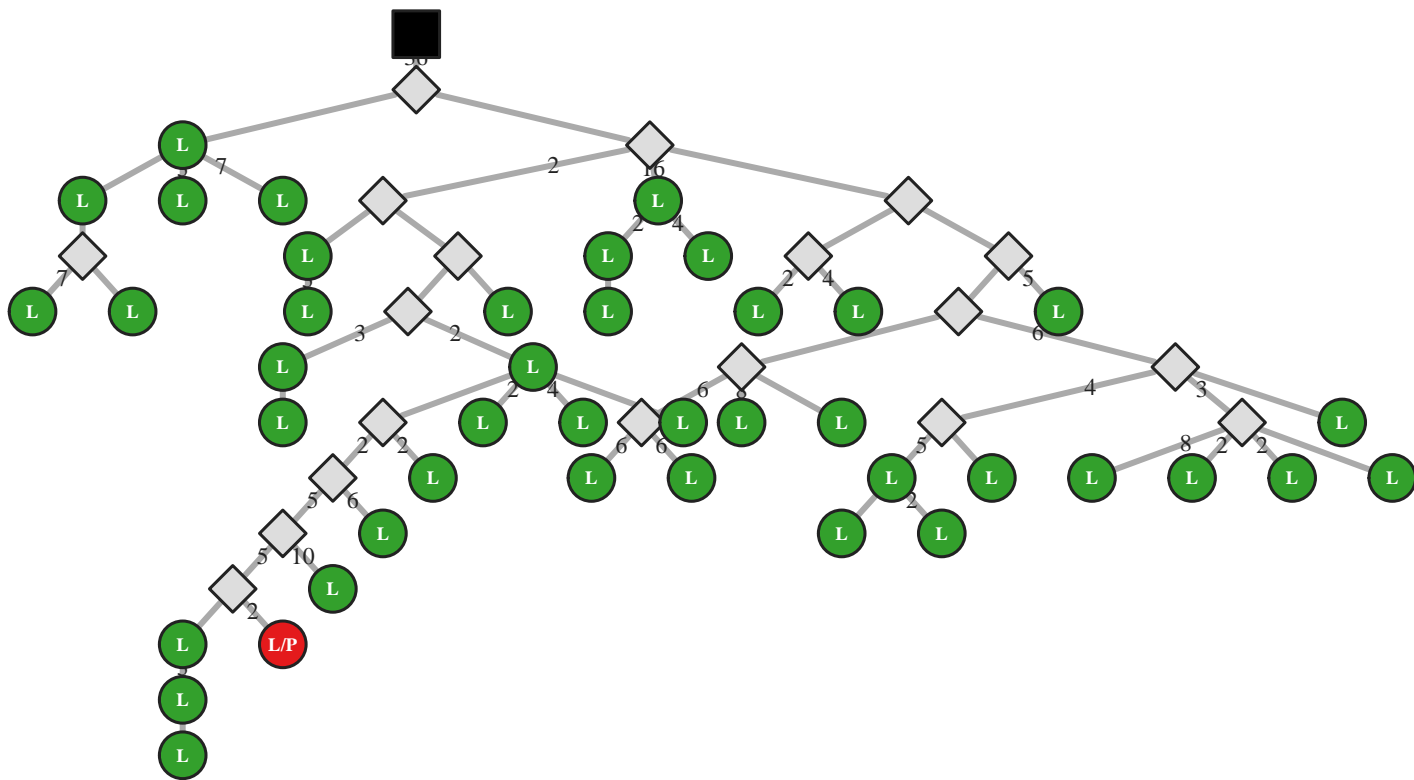

M5 IgG IGHV1-69/J4 48bp (41344)

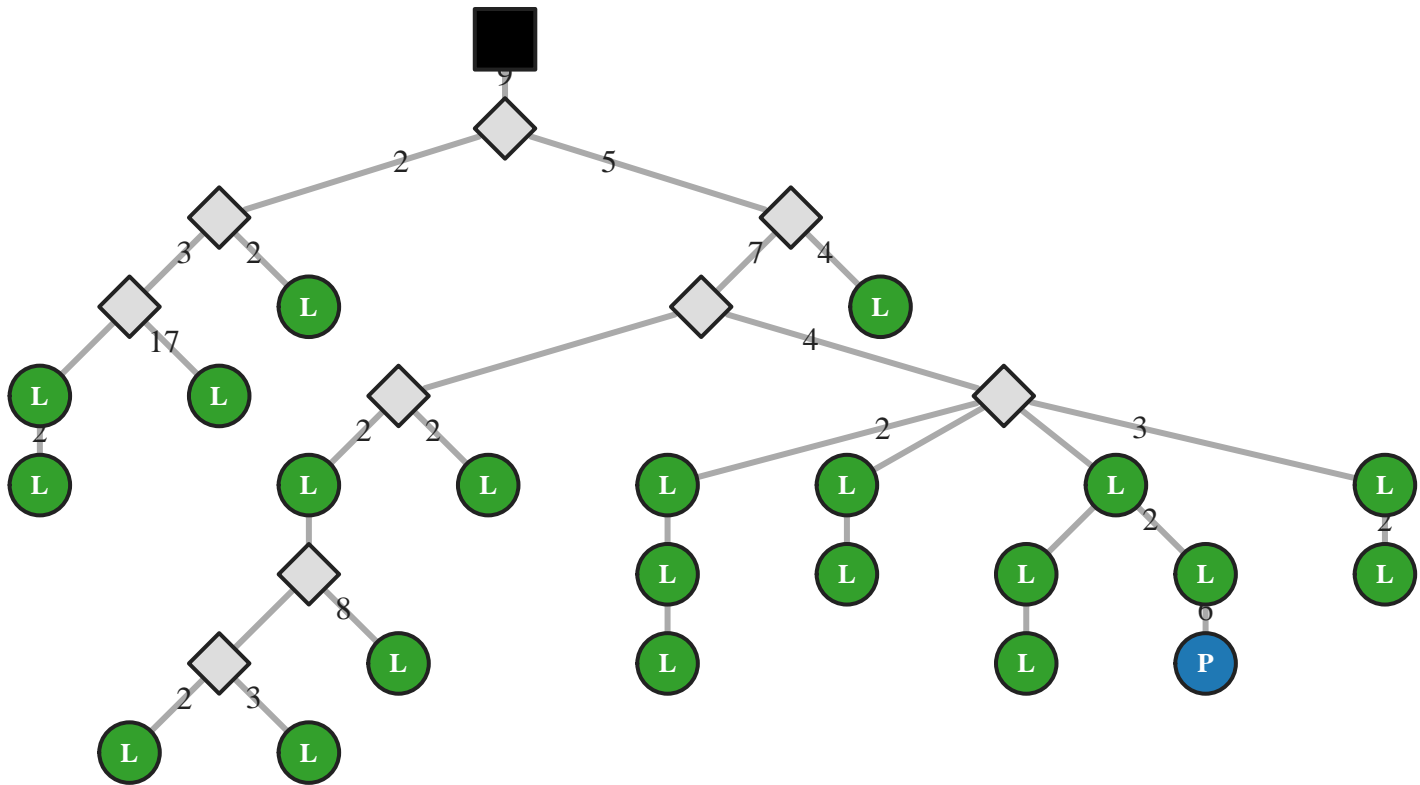

M5 IgG IGHV1-69/J4 48bp (41362)

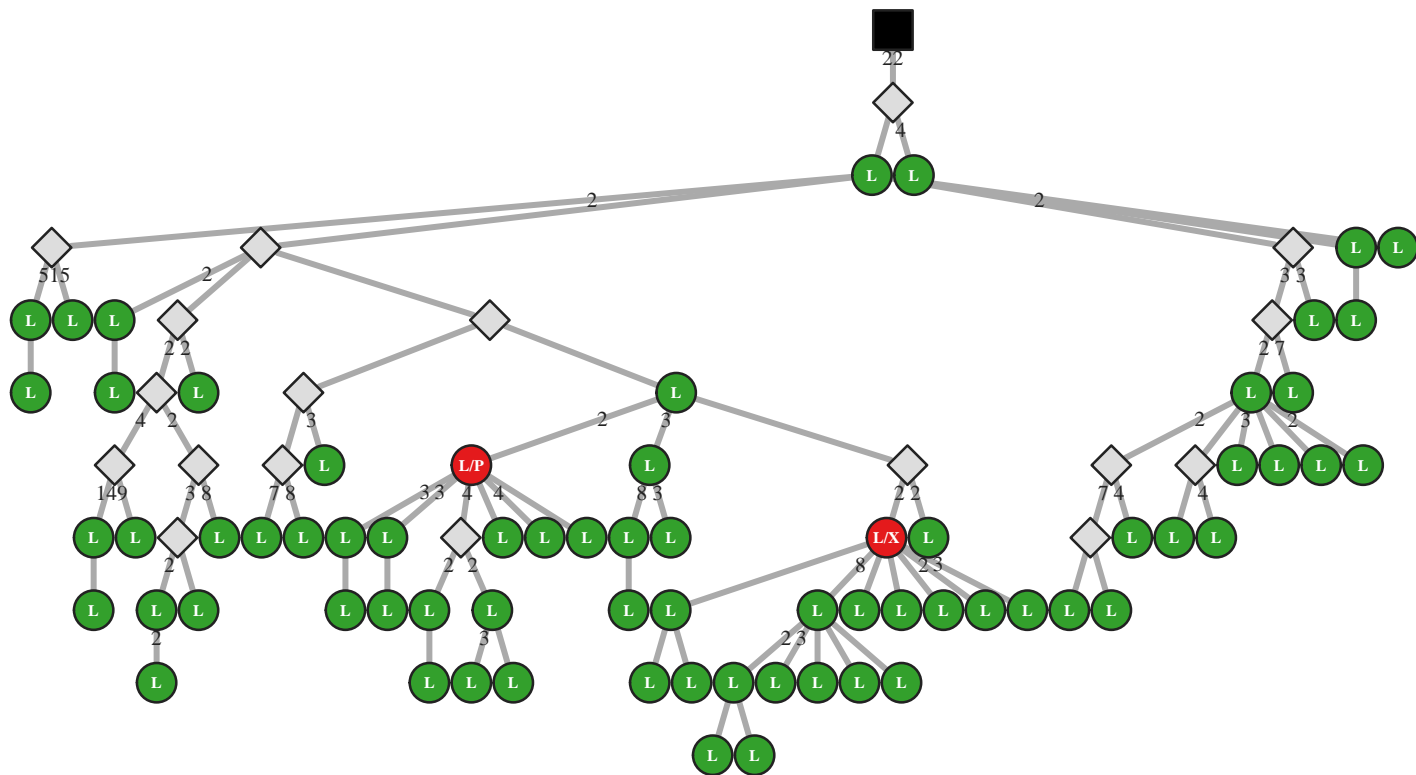

M5 IgG IGHV1-69/J4 48bp (41383)

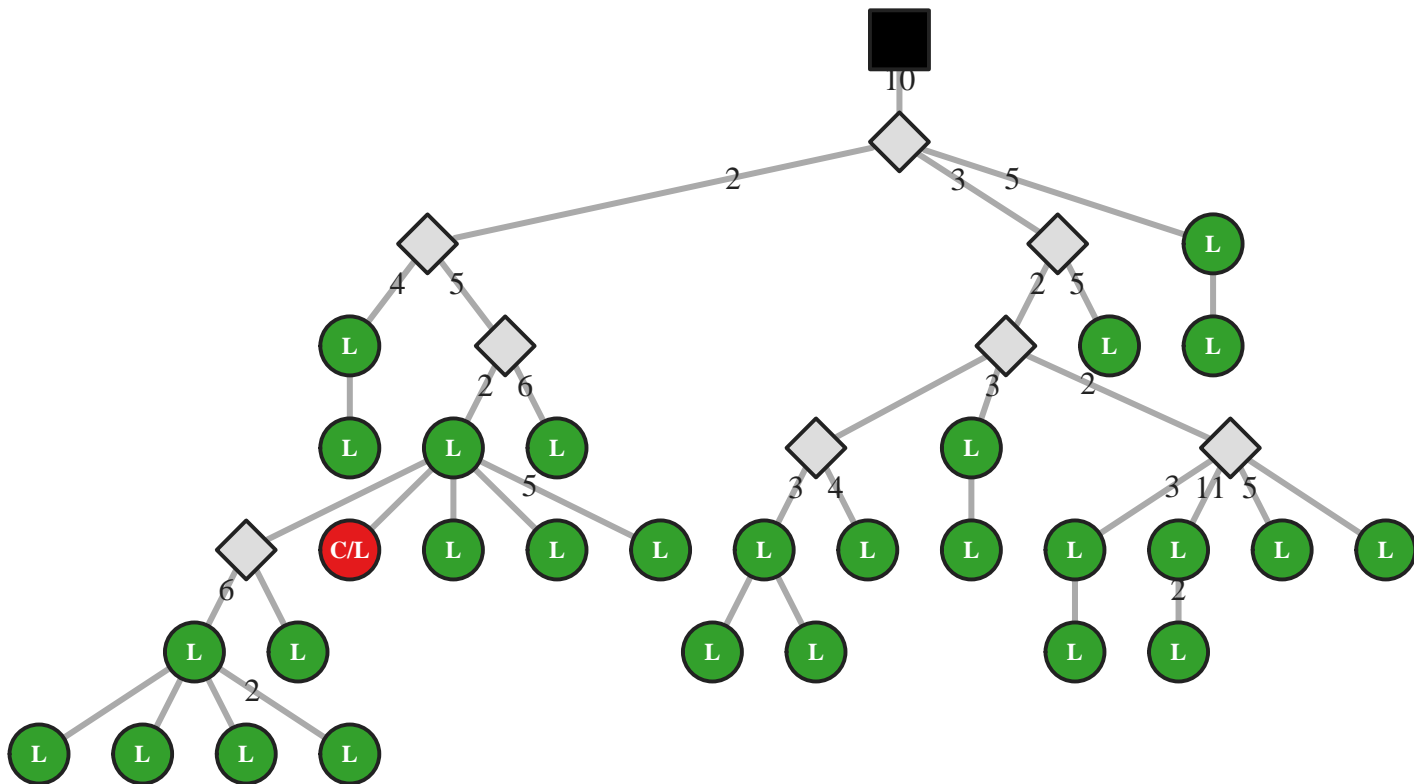

M5 IgG IGHV1-69/J4 48bp (41384)

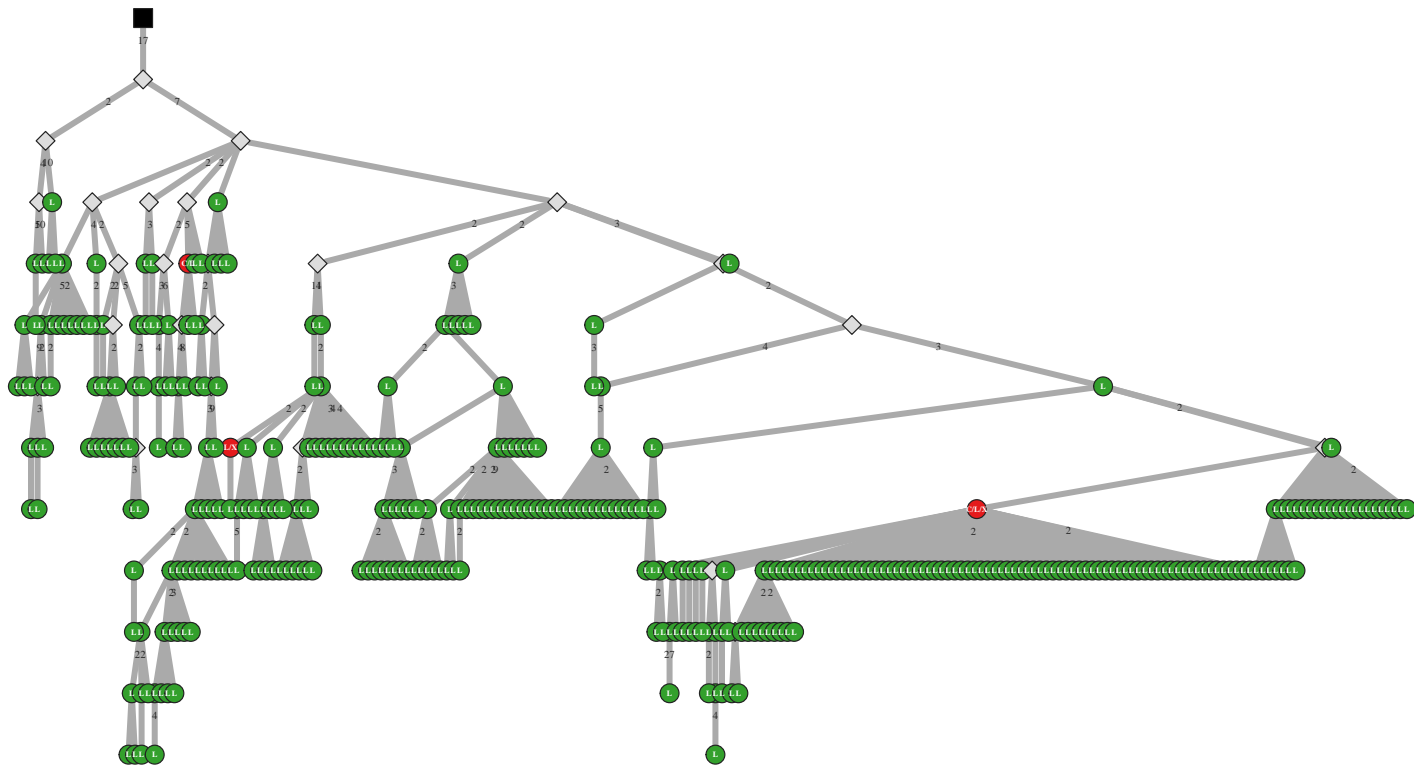

M5 IgG IGHV1-69/J4 48bp (41413)

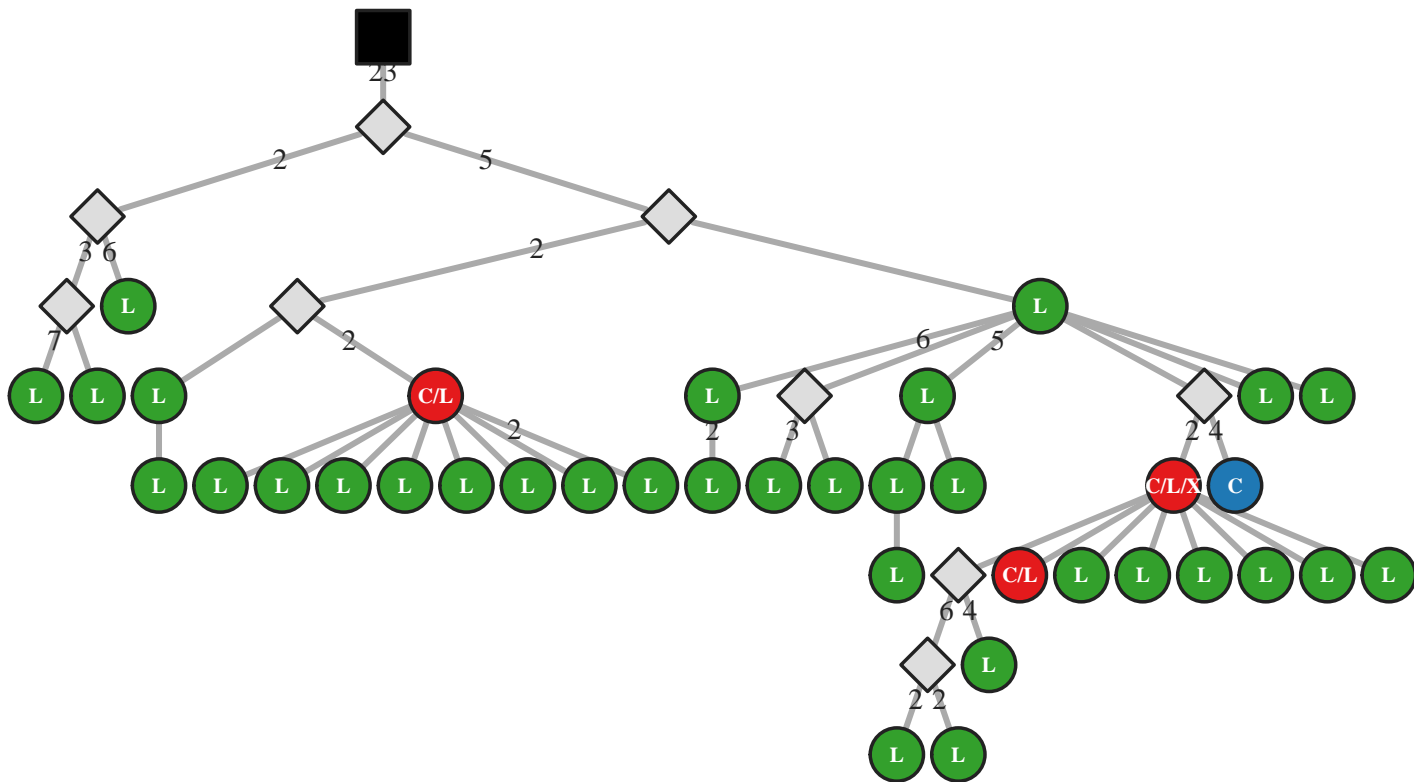

M5 IgA IGHV1-69/J4 51bp (38409)

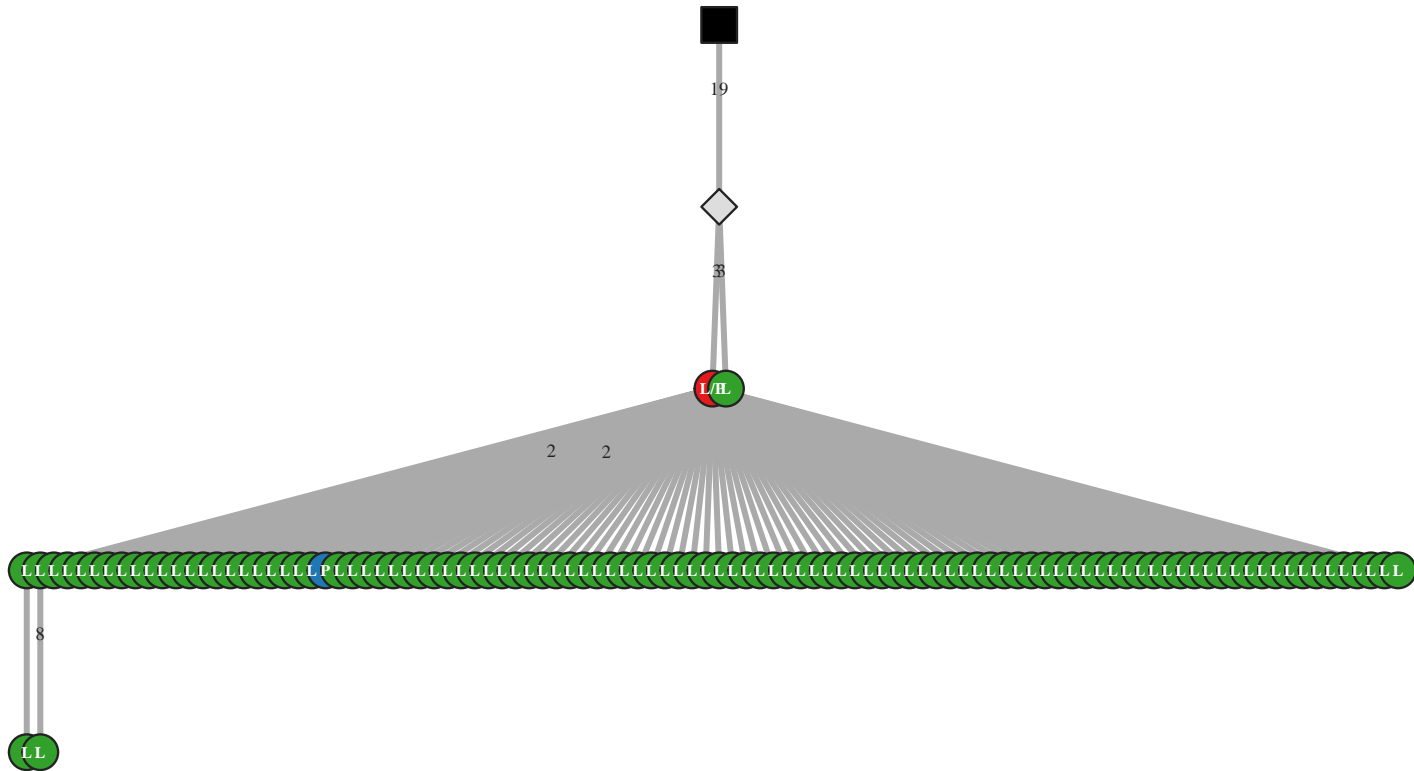

M5 IgA IGHV1-69/J4 51bp (38418)

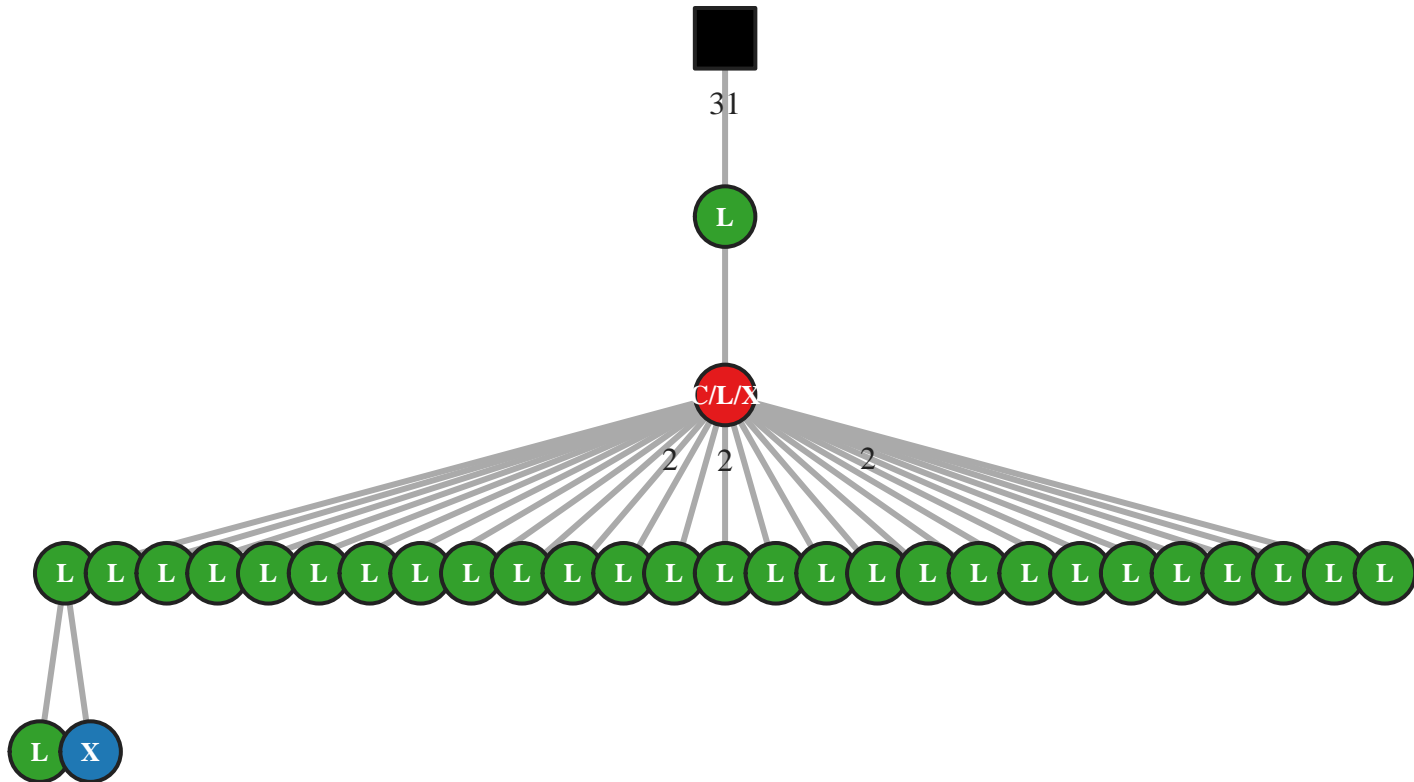

M5 IgG IGHV1-69/J4 51bp (5064)

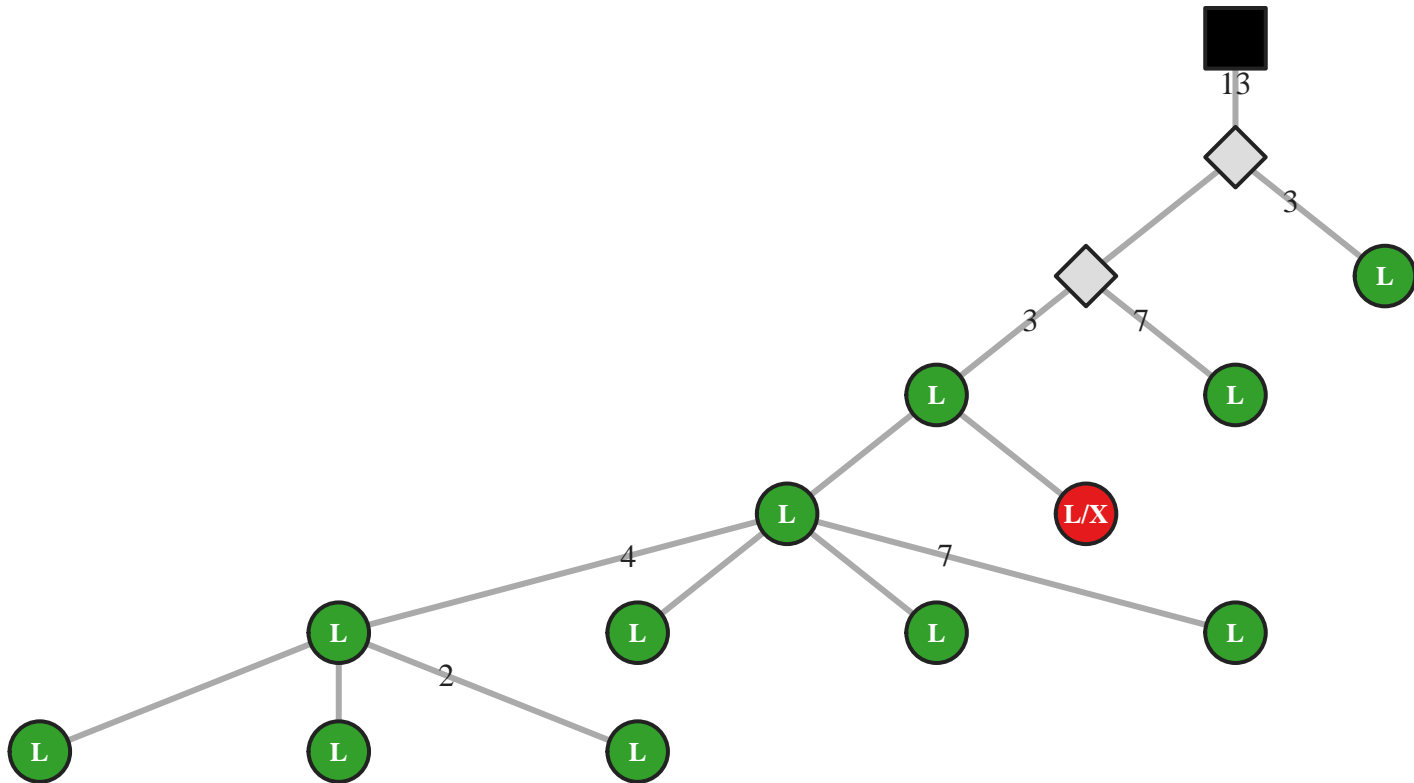

M5 IgG IGHV1-69/J4 51bp (5080)

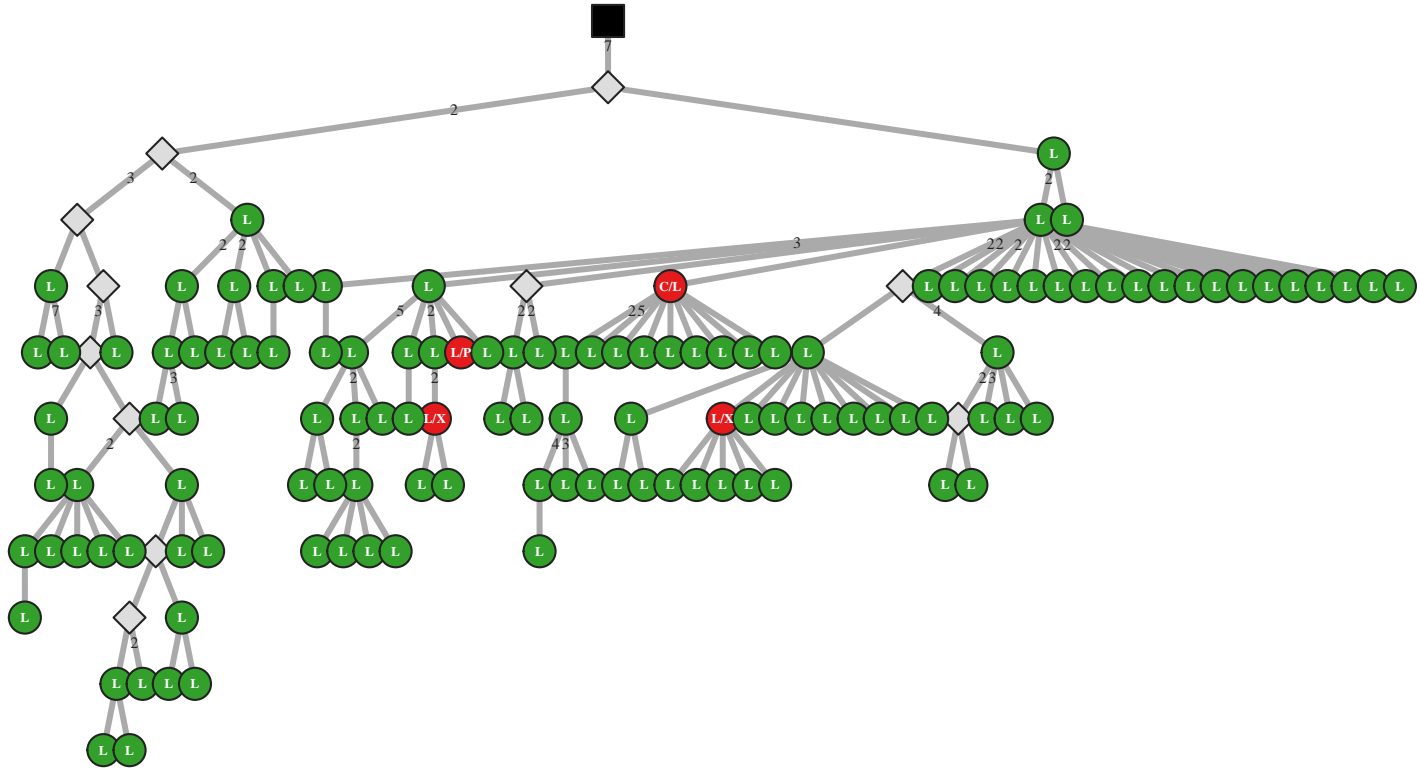

M5 IgG IGHV1-69/J4 51bp (5102)

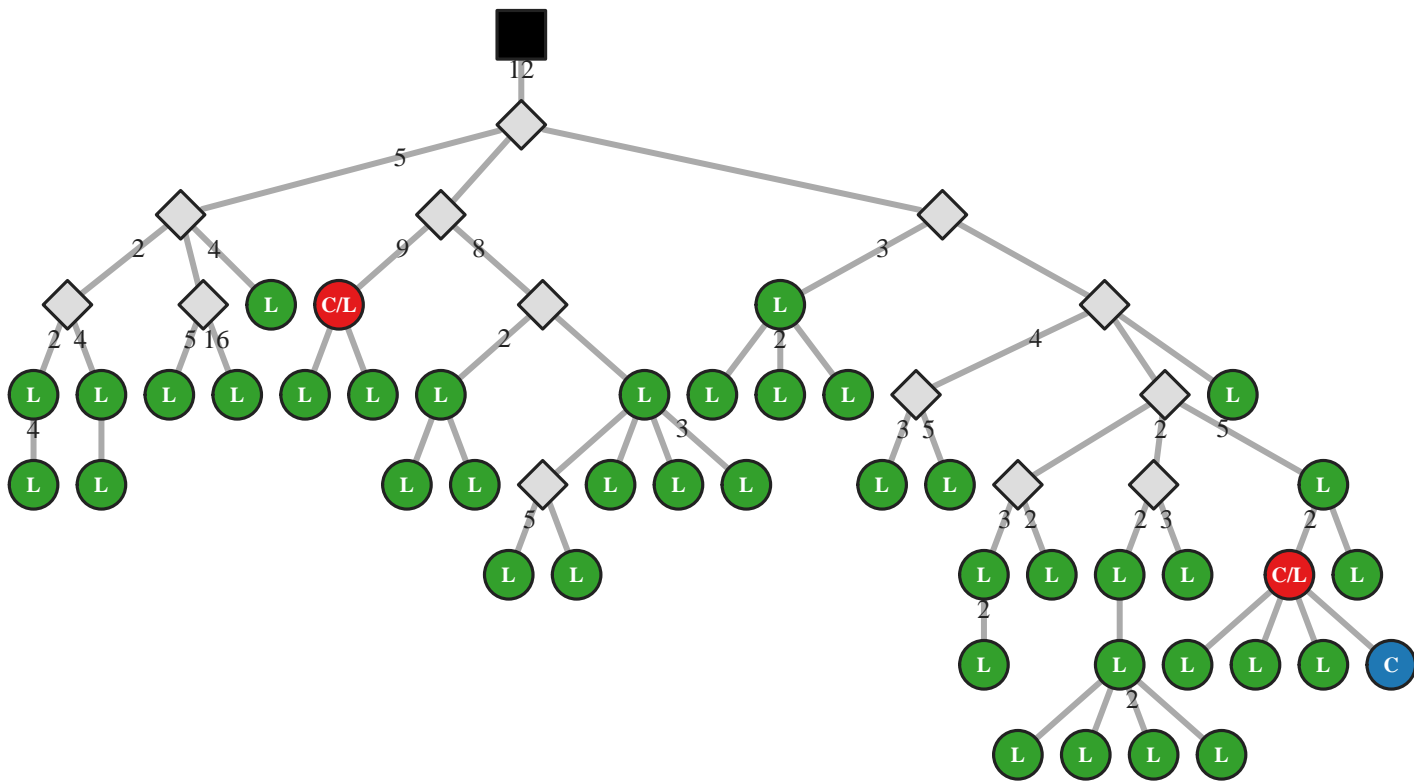

M5 IgG IGHV1-69/J4 51bp (5165)

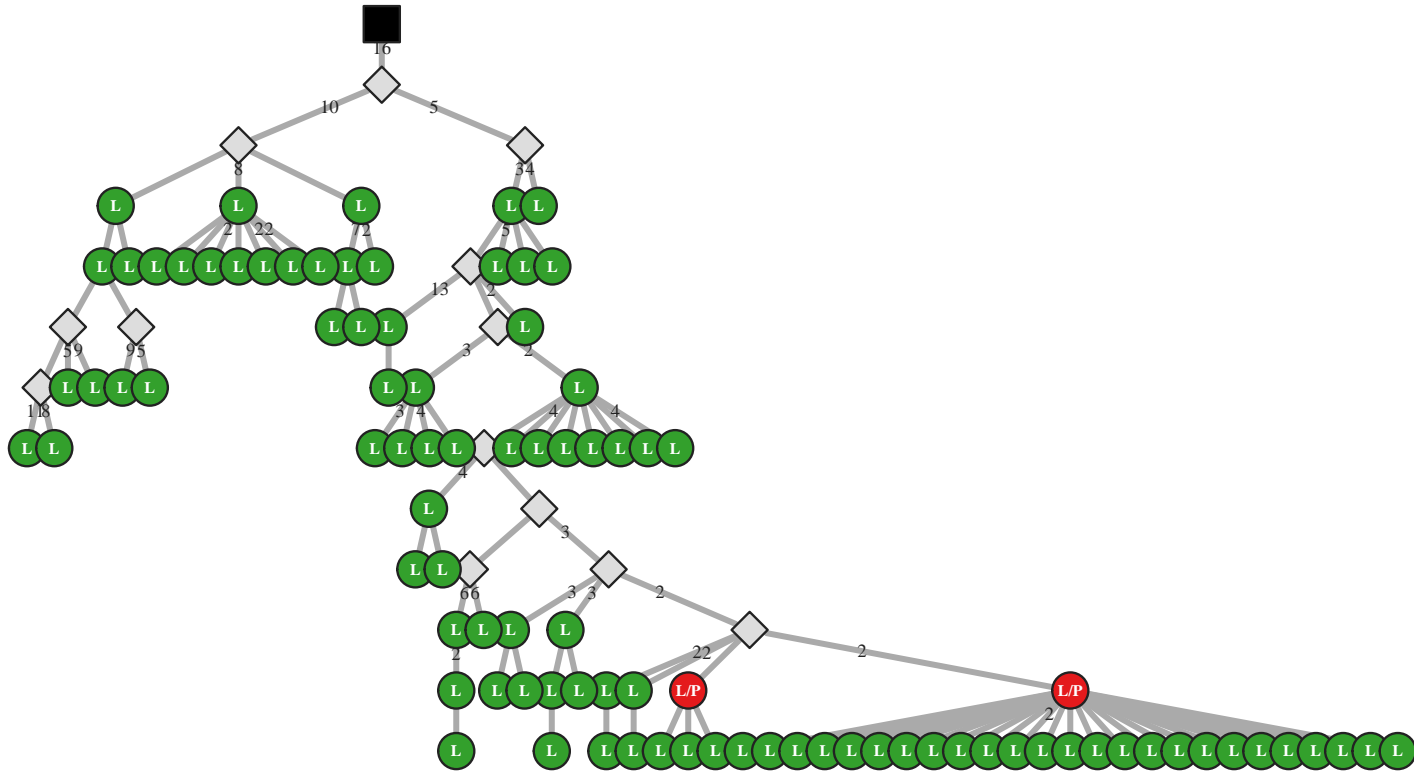

M5 IgG IGHV1-69/J4 51bp (5179)

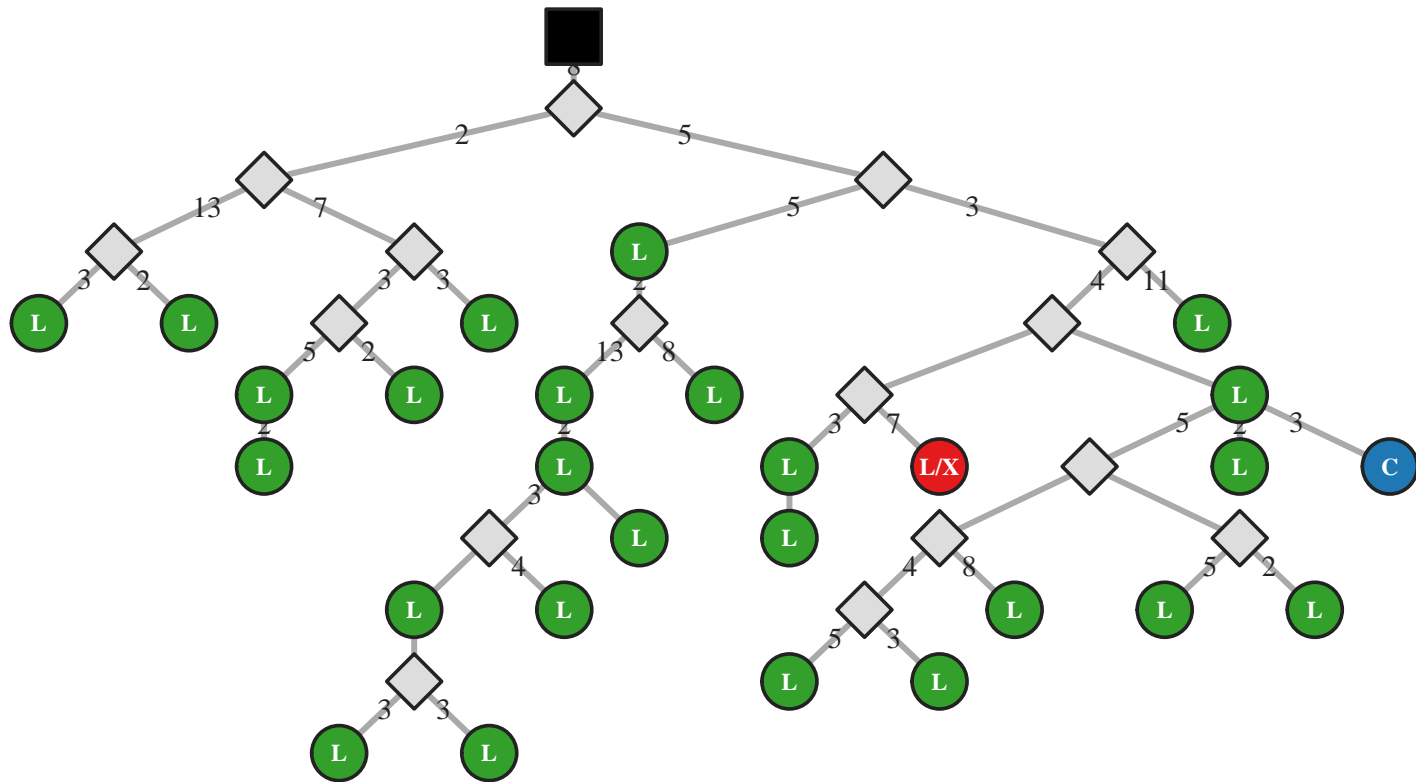

M5 IgG IGHV1-69/J4 51bp (5201)

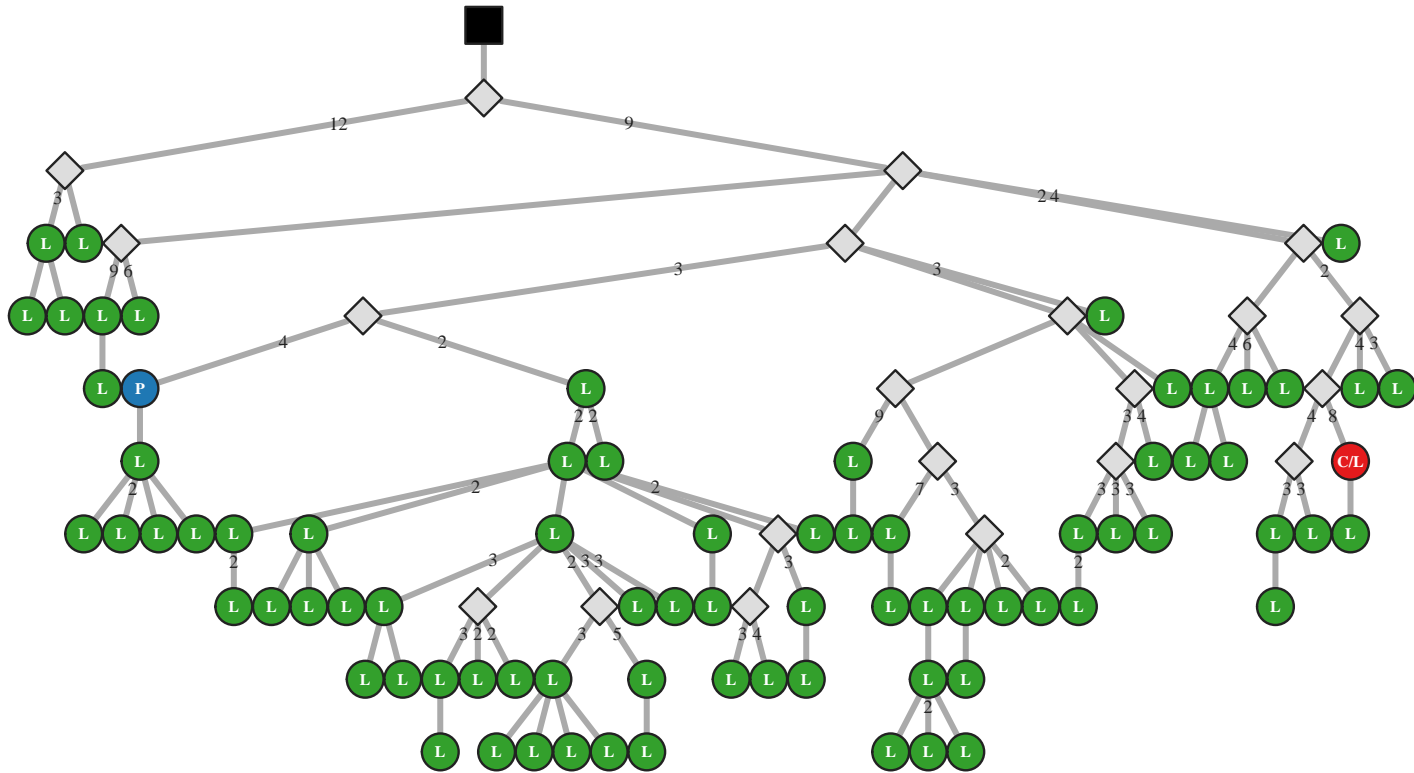

M5 IgG IGHV1-69/J4 51bp (5232)

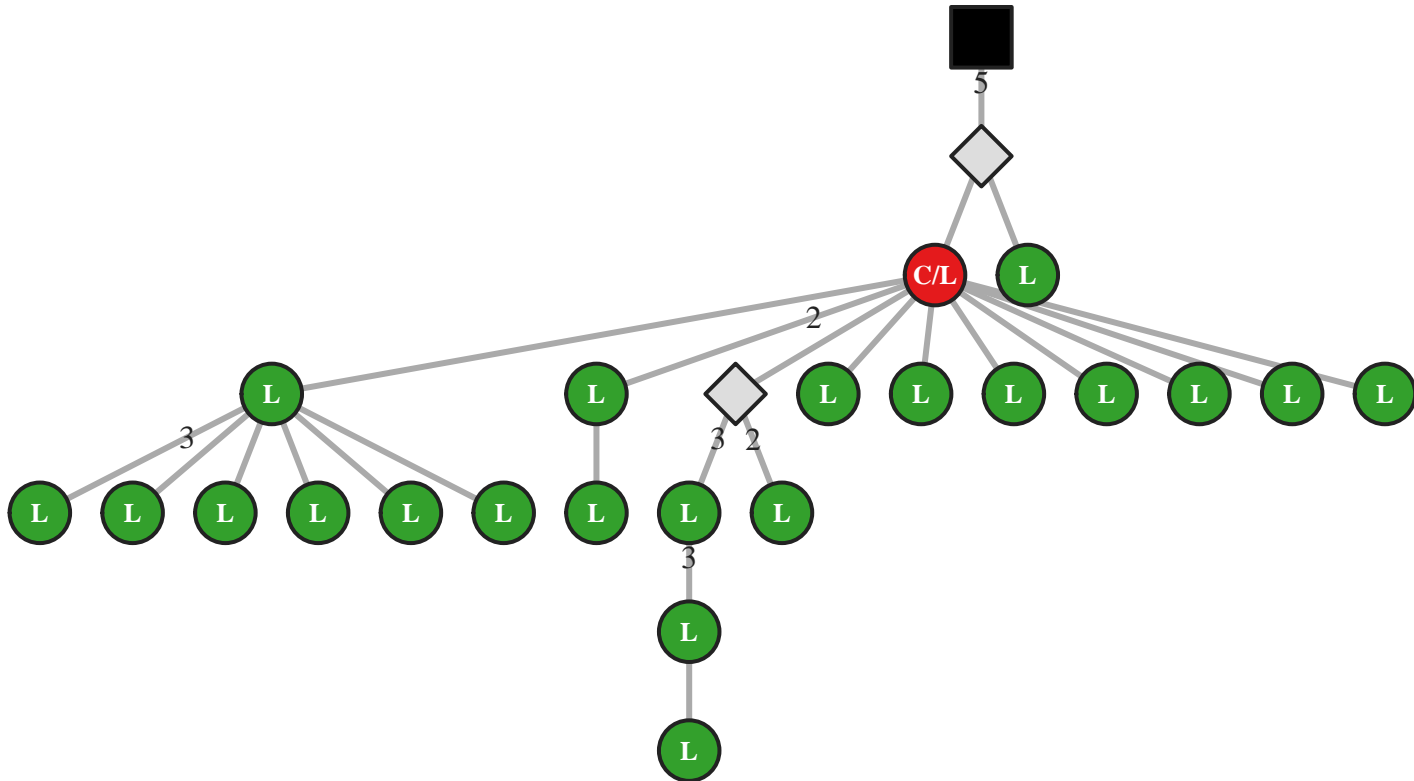

M5 IgG IGHV1-69/J4 51bp (5245)

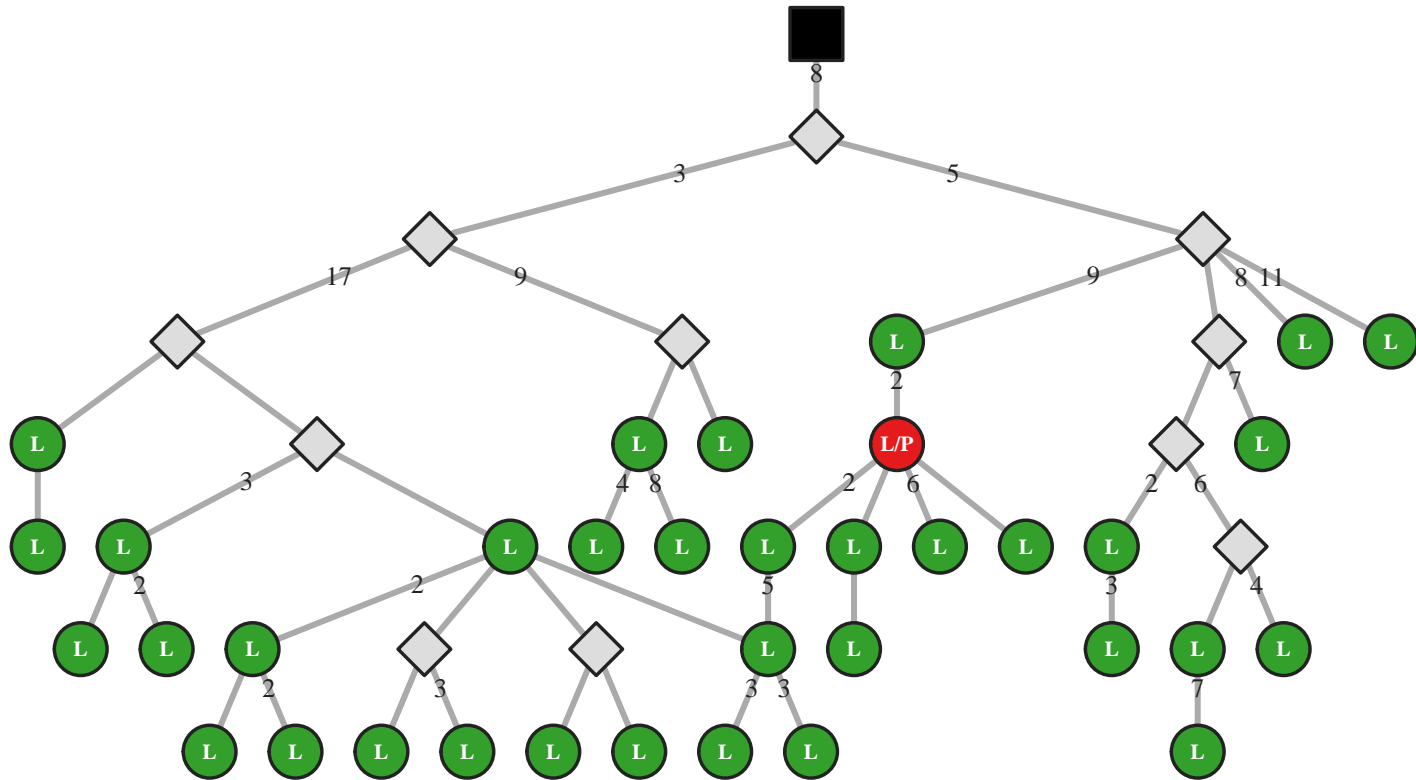

M5 IgG IGHV1-69/J4 54bp (41439)

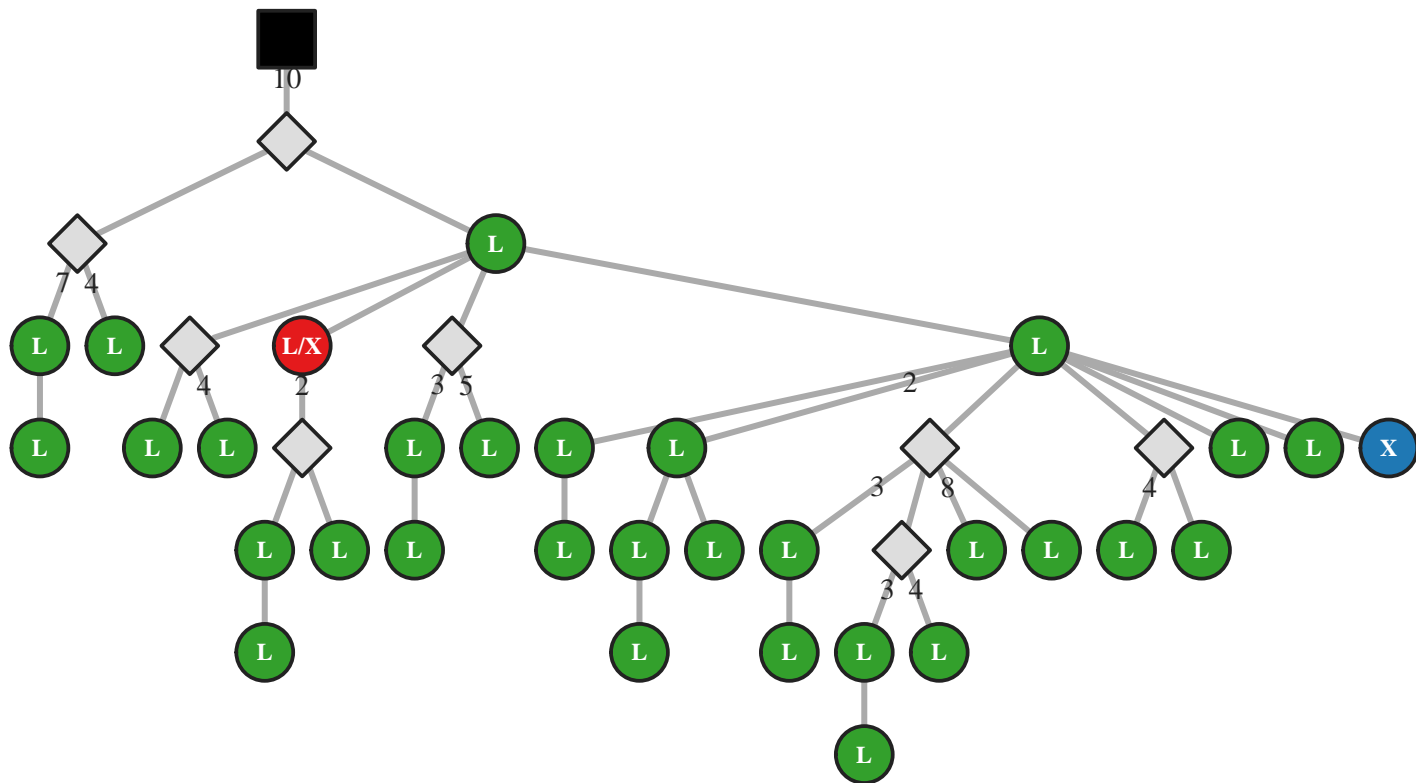

M5 IgG IGHV1-69/J4 54bp (41483)

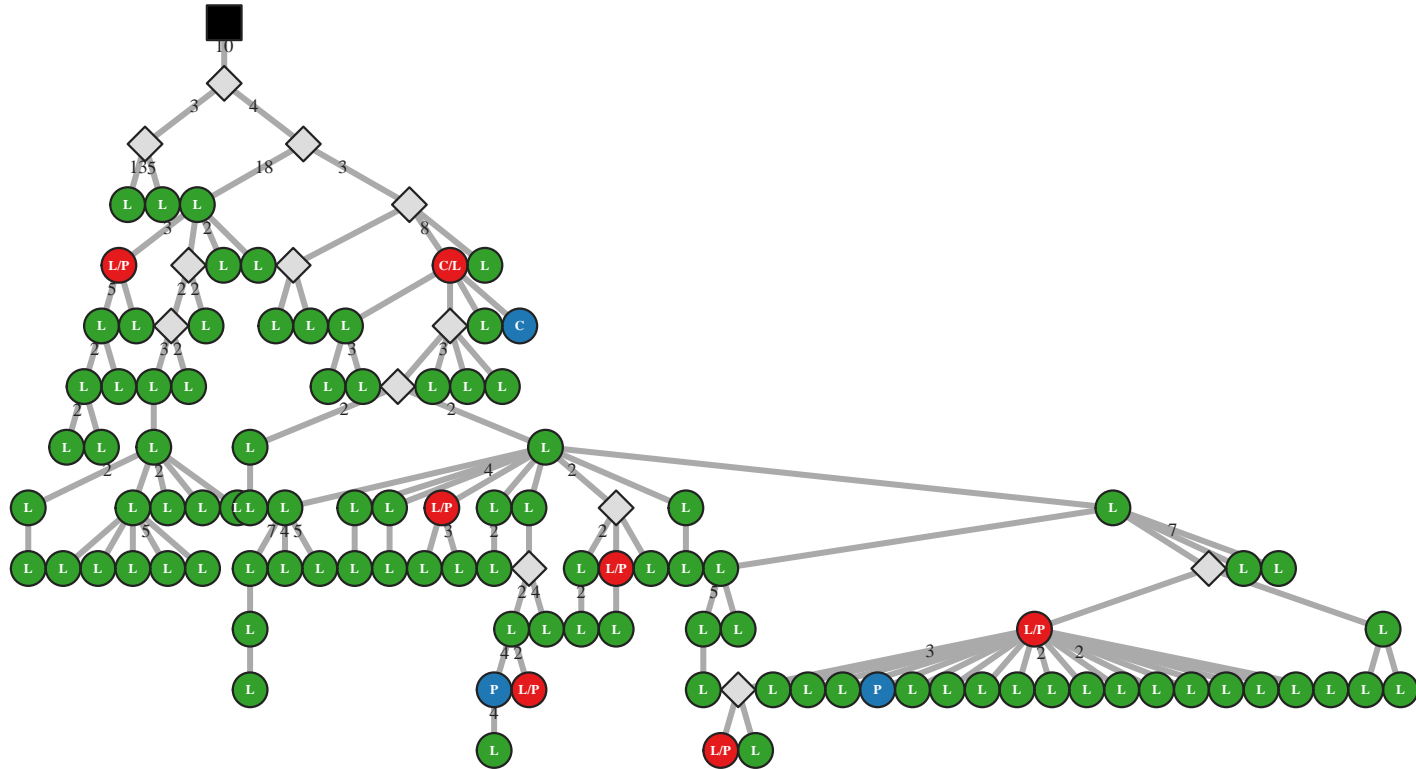

M5 IgG IGHV1-69/J4 54bp (41498)

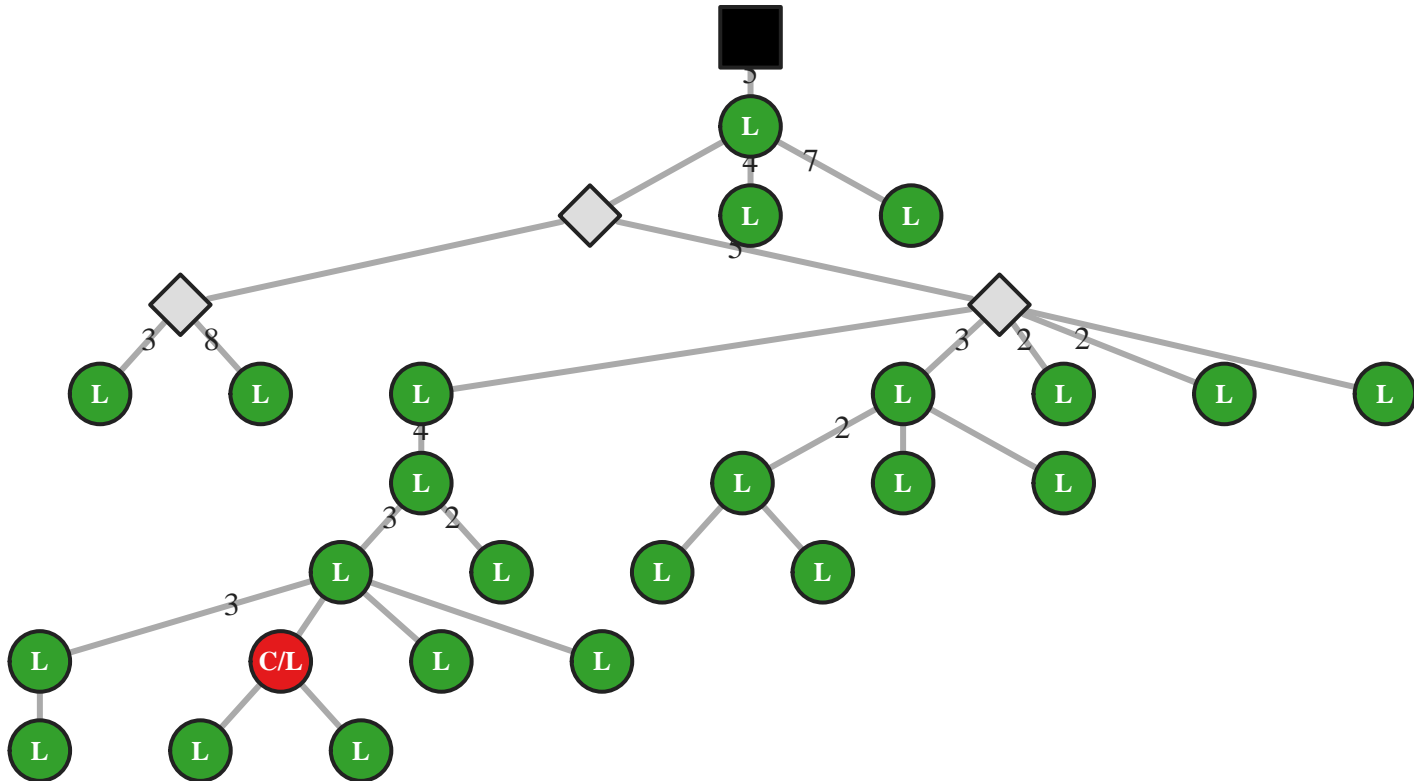

M5 IgG IGHV1-69/J4 54bp (41501)

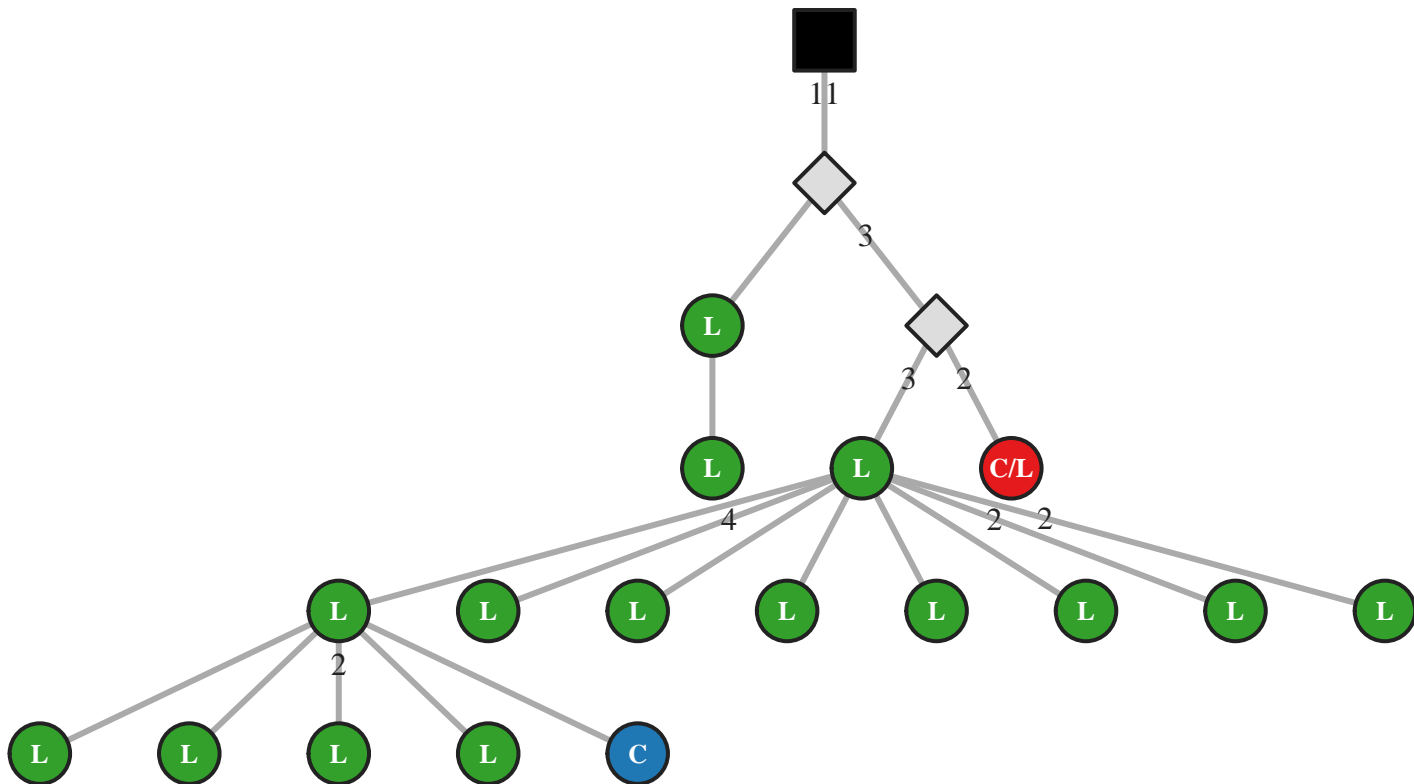

M5 IgG IGHV1-69/J4 54bp (41507)

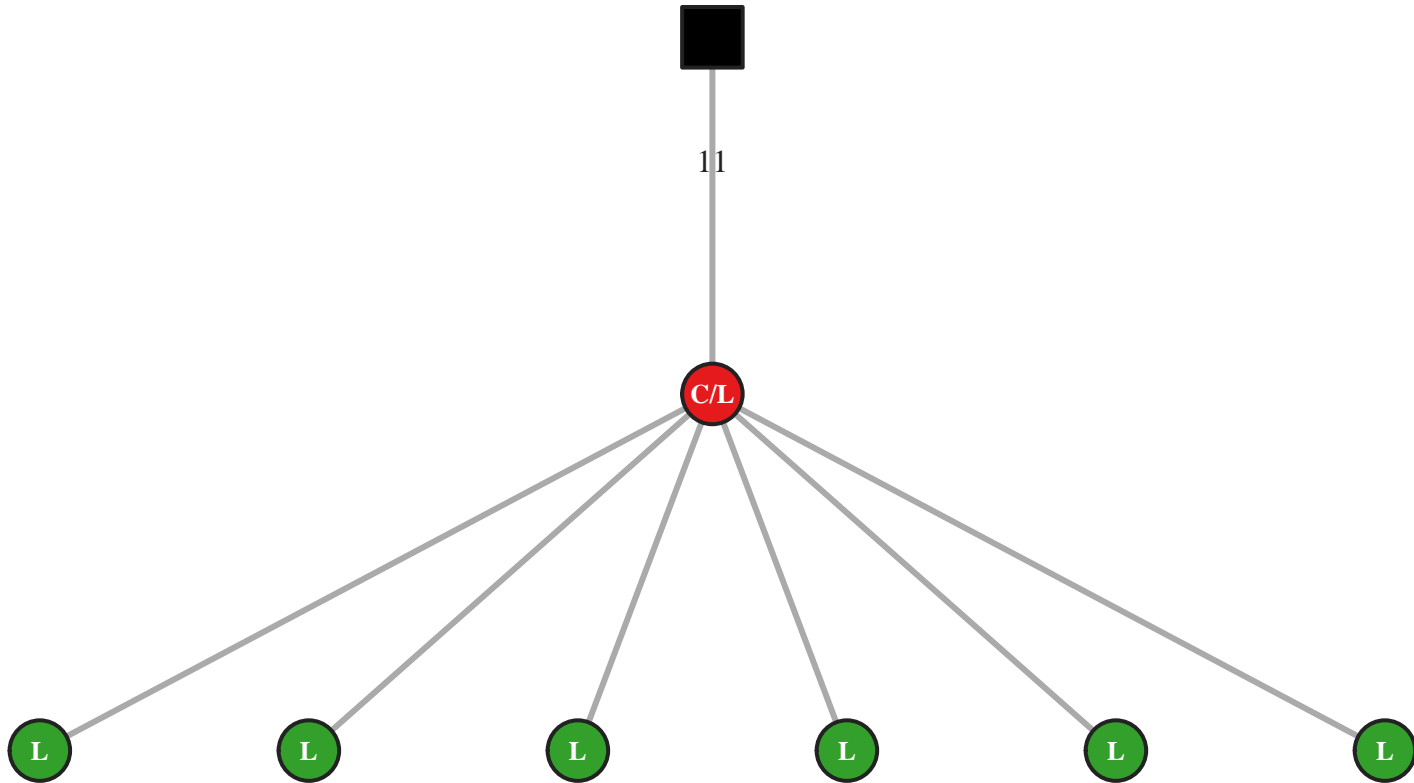

M5 IgG IGHV1-69/J4 54bp (41520)

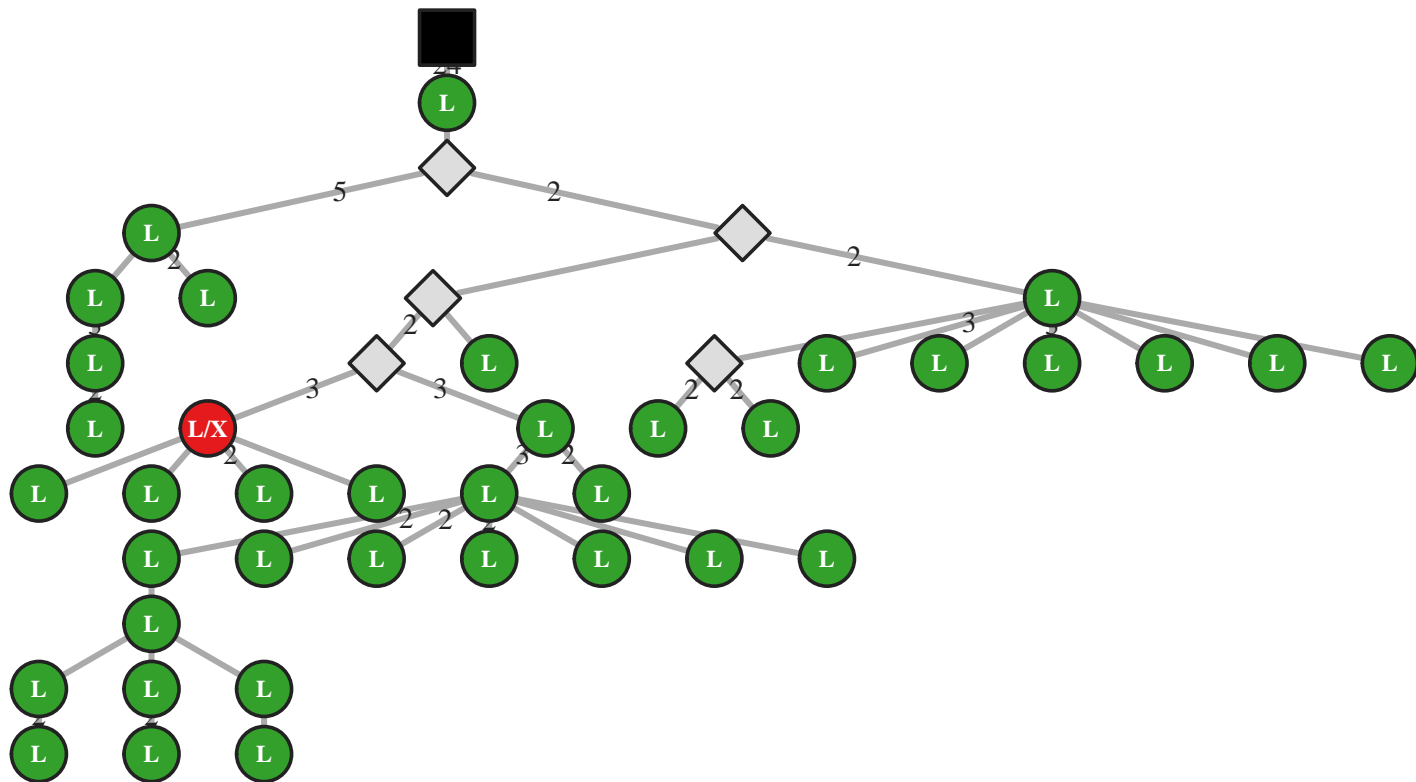

M5 IgG IGHV1-69/J4 54bp (41526)

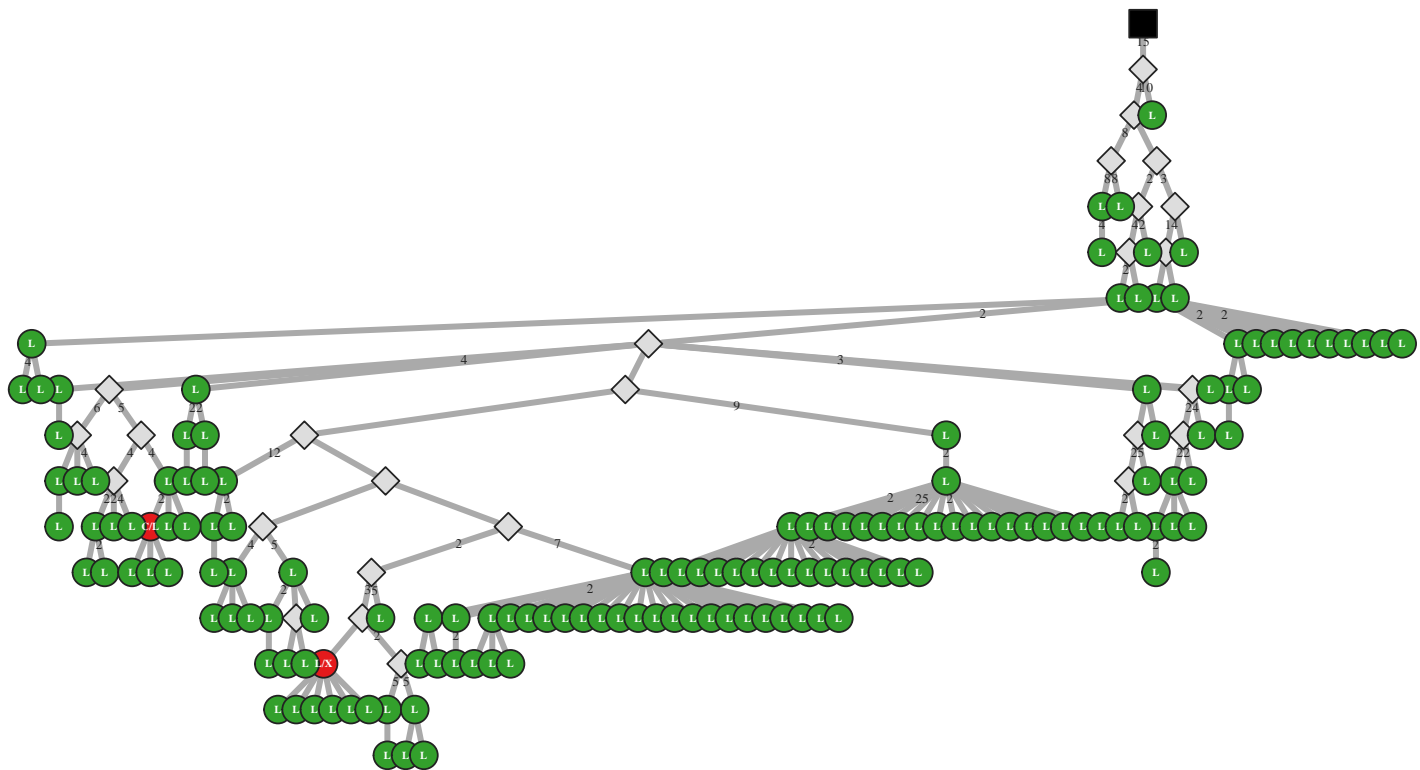

M5 IgG IGHV1-69/J4 54bp (41530)

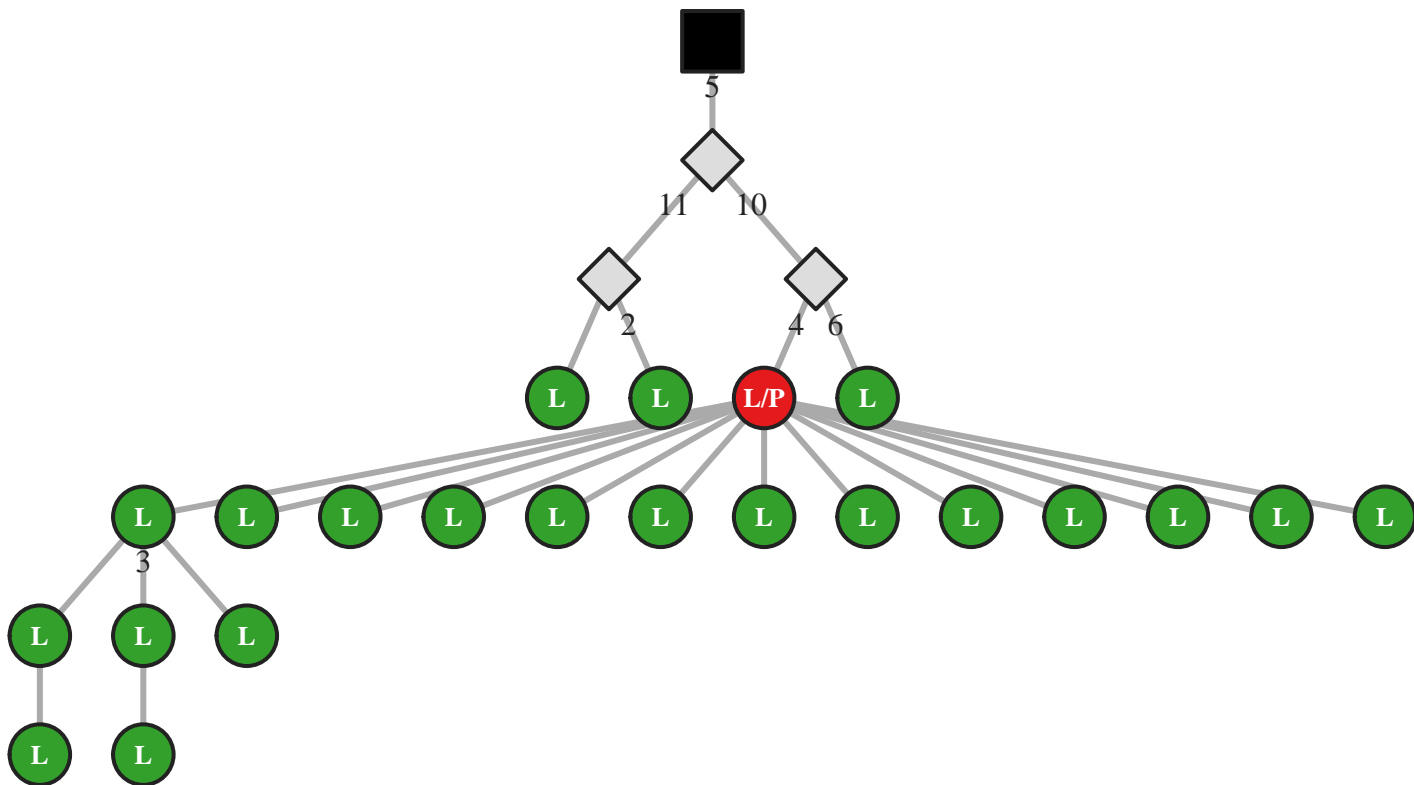

M5 IgG IGHV1-69/J4 54bp (41539)

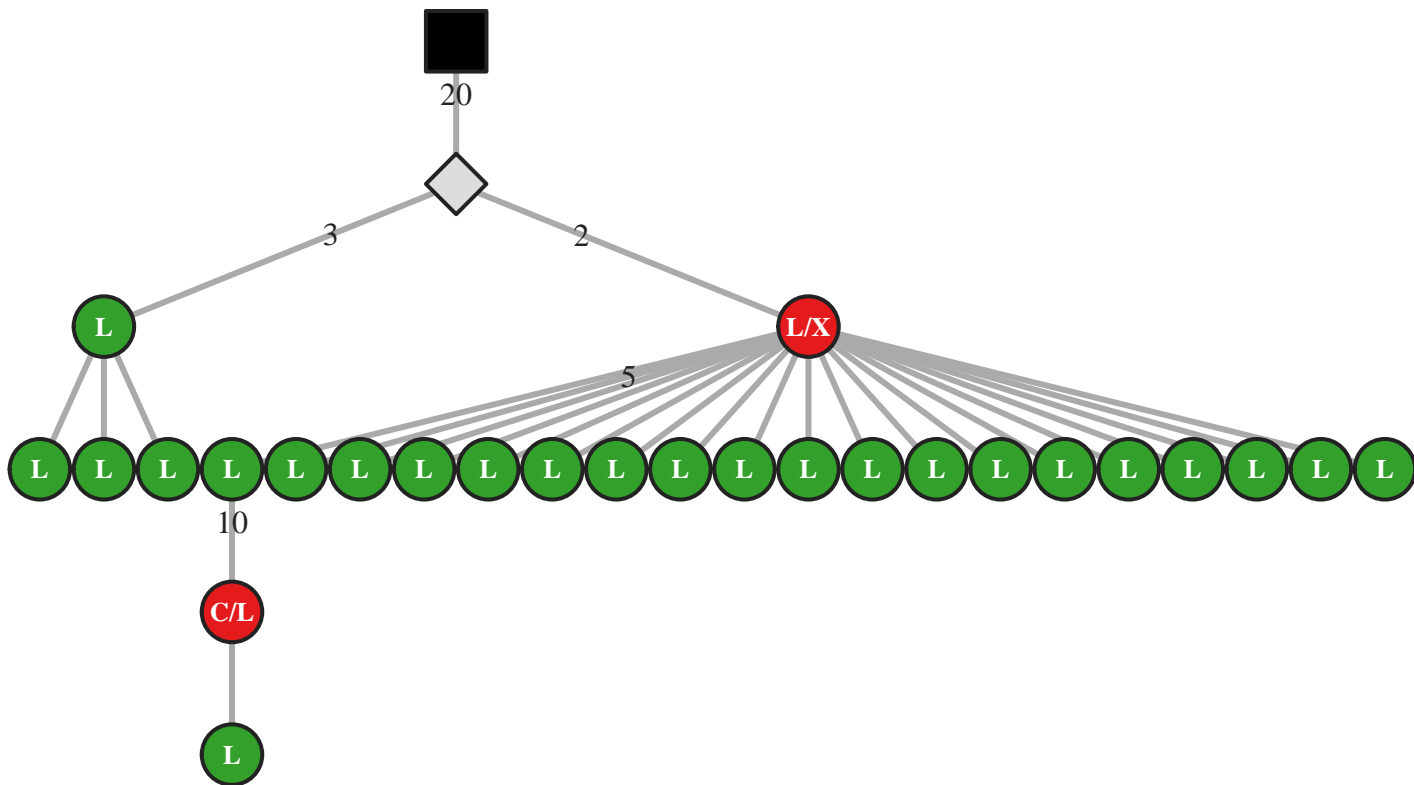

M5 IgG IGHV1-69/J4 57bp (41591)

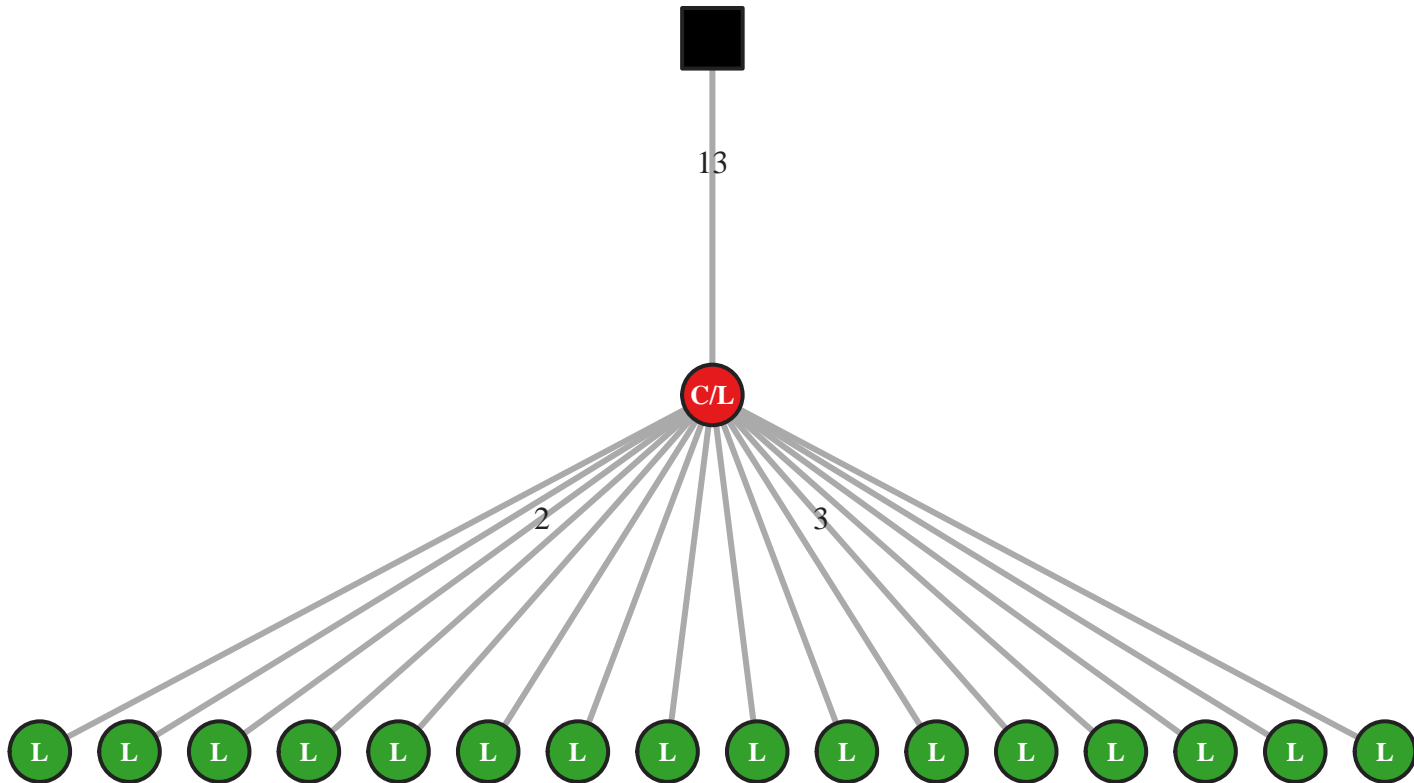

M5 IgG IGHV1-69/J4 57bp (41620)

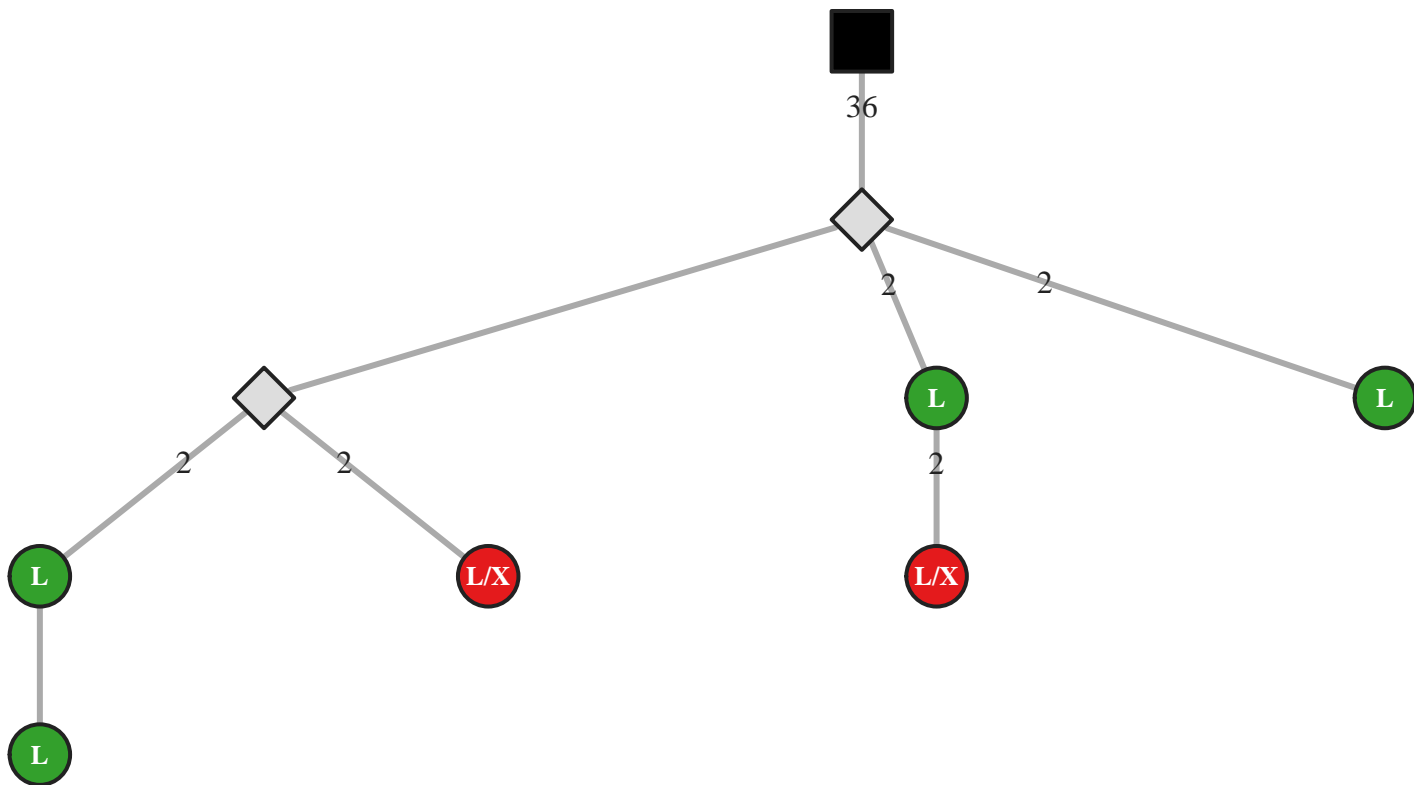

M5 IgG IGHV1-69/J4 57bp (41624)

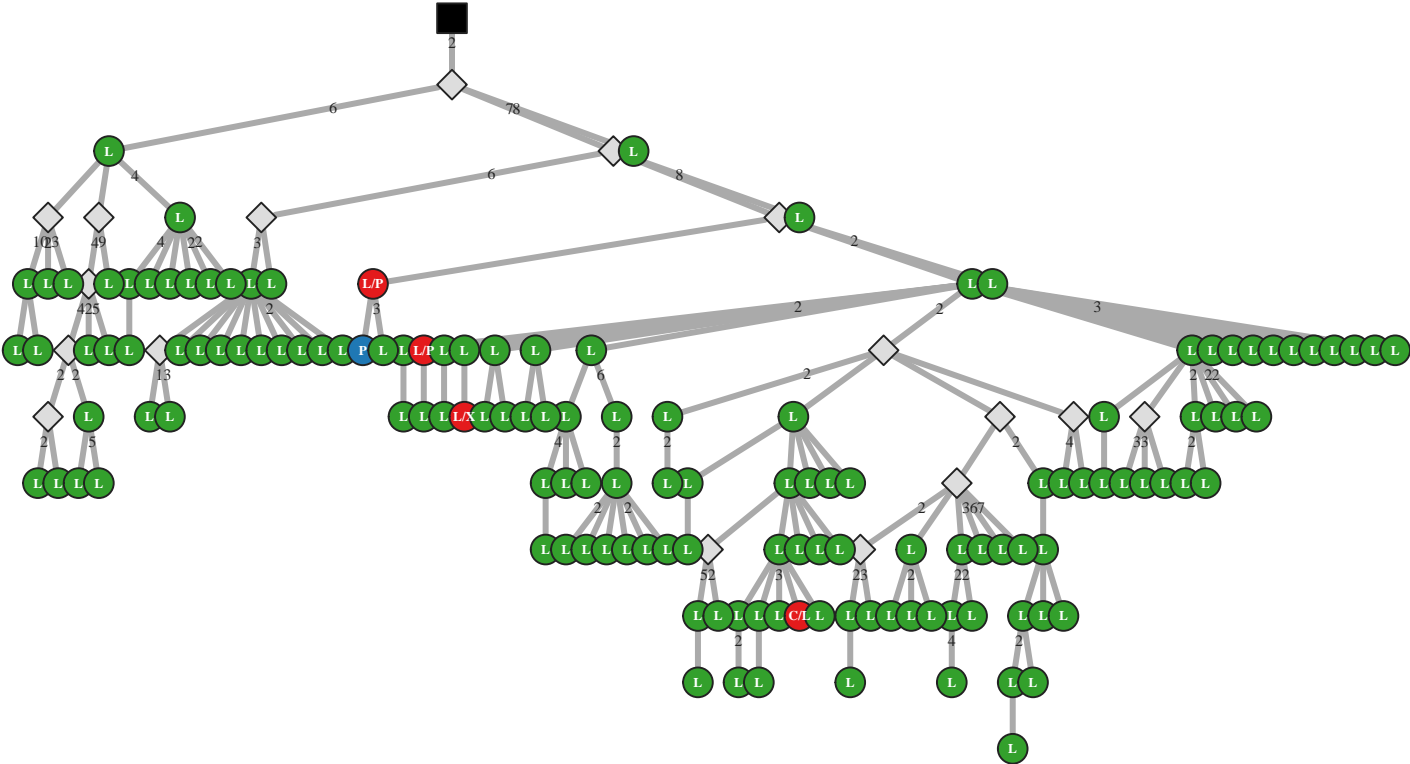

M5 IgG IGHV1-69/J4 57bp (41632)

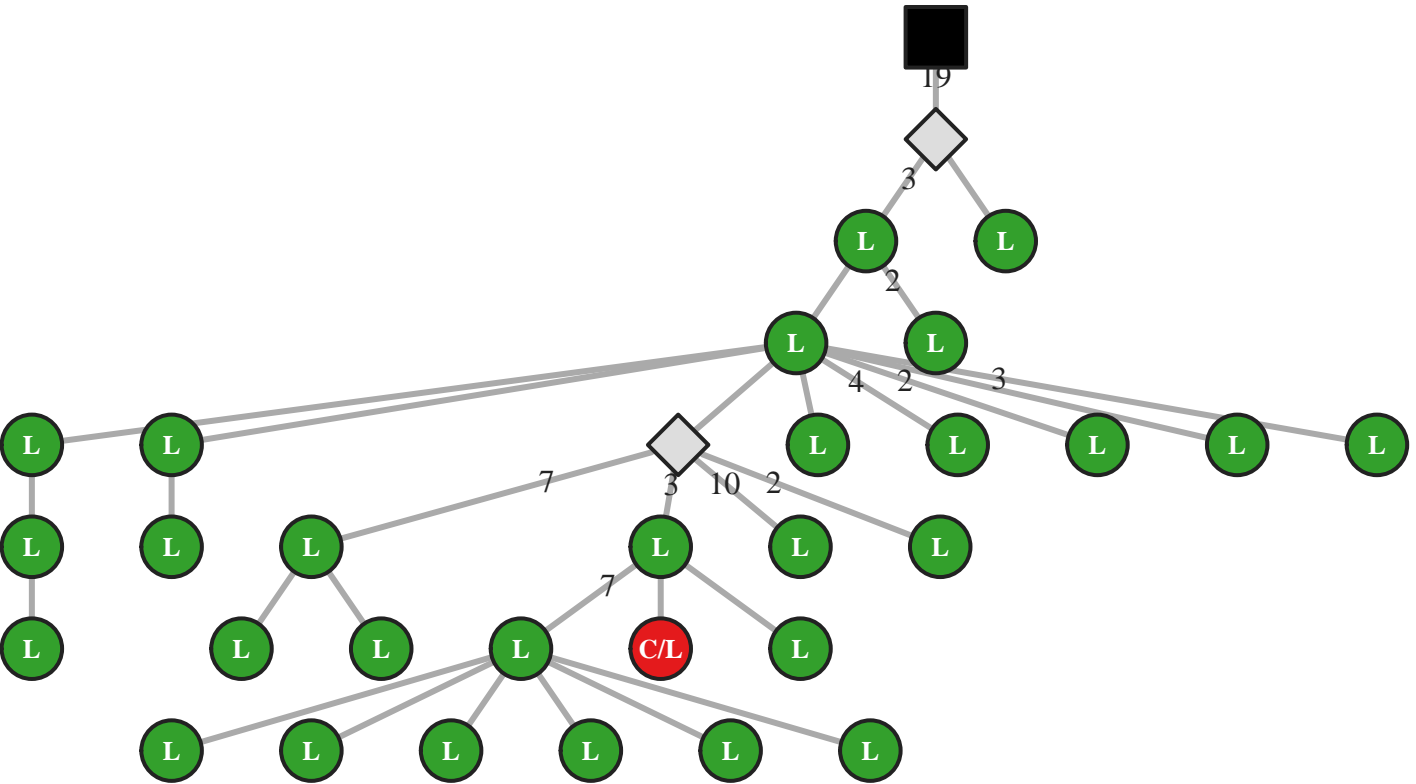

M5 IgG IGHV1-69/J4 57bp (41633)

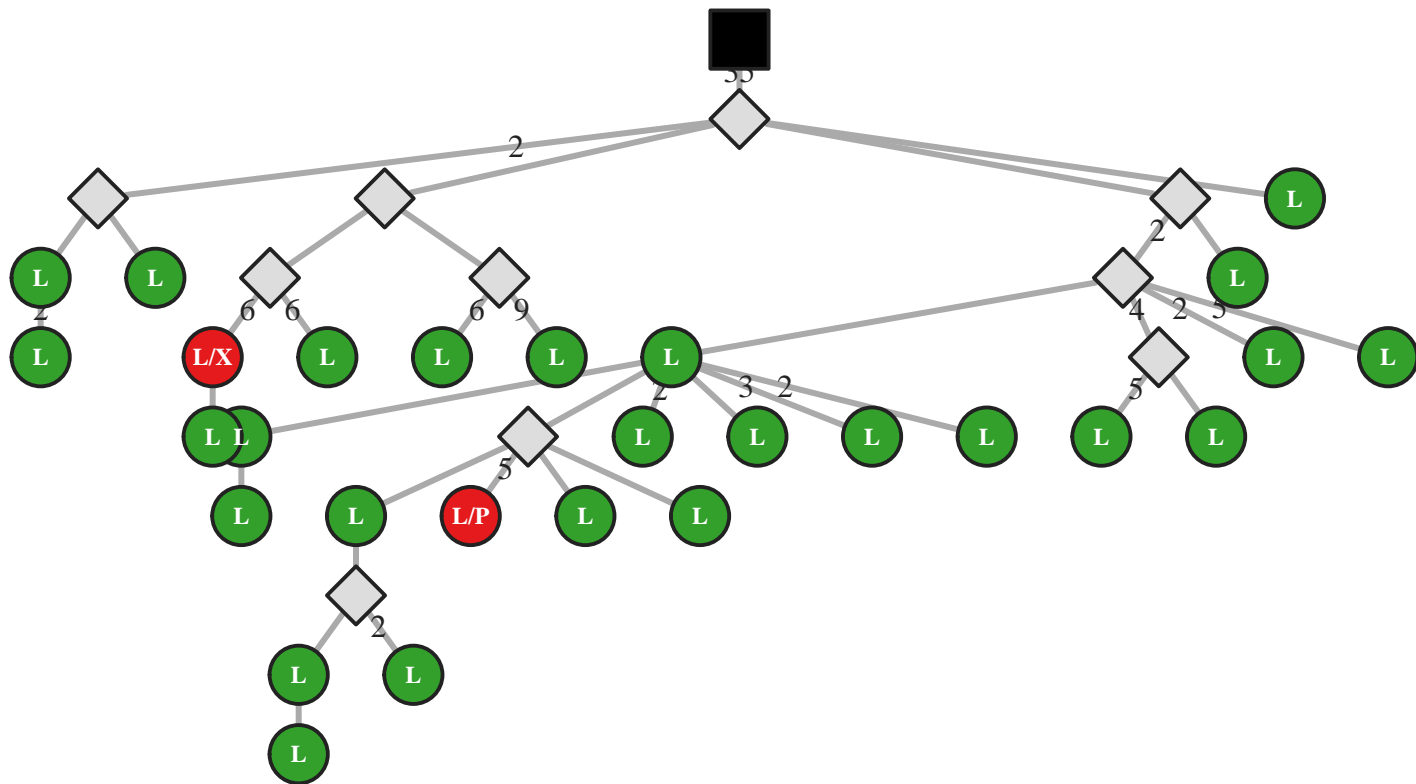

M5 IgG IGHV1-69/J4 57bp (41652)

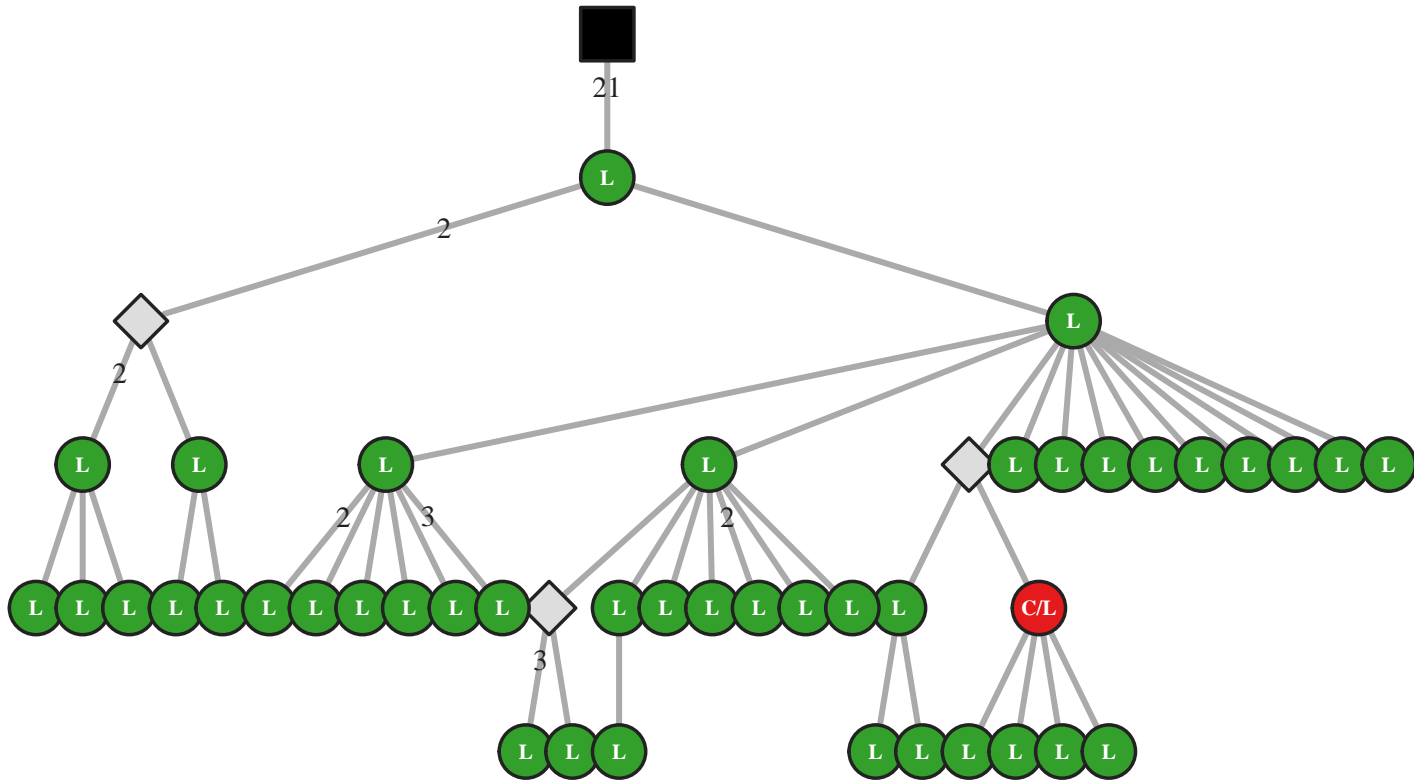

M5 IgG IGHV1-69/J4 57bp (41655)

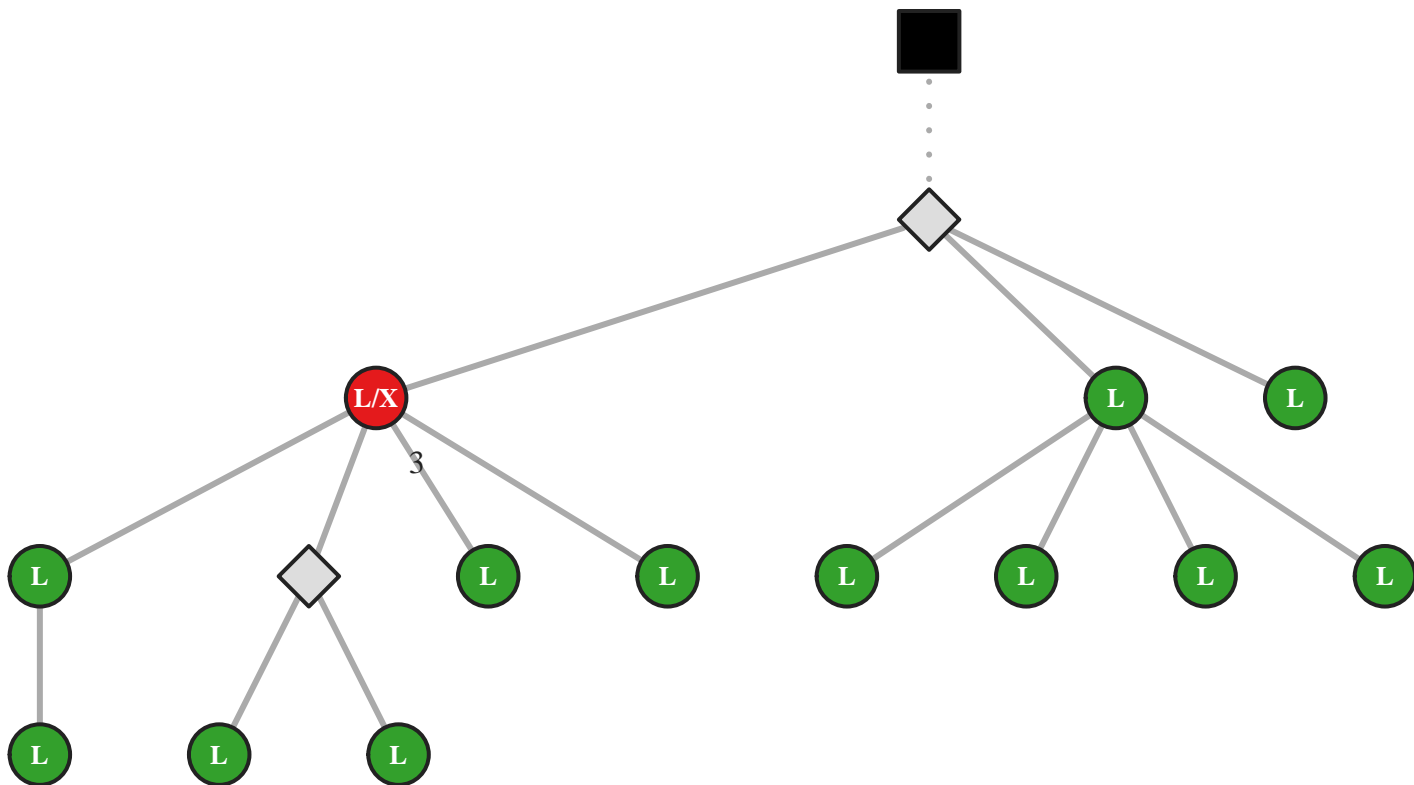

M5 IgG IGHV1-69/J4 57bp (41672)

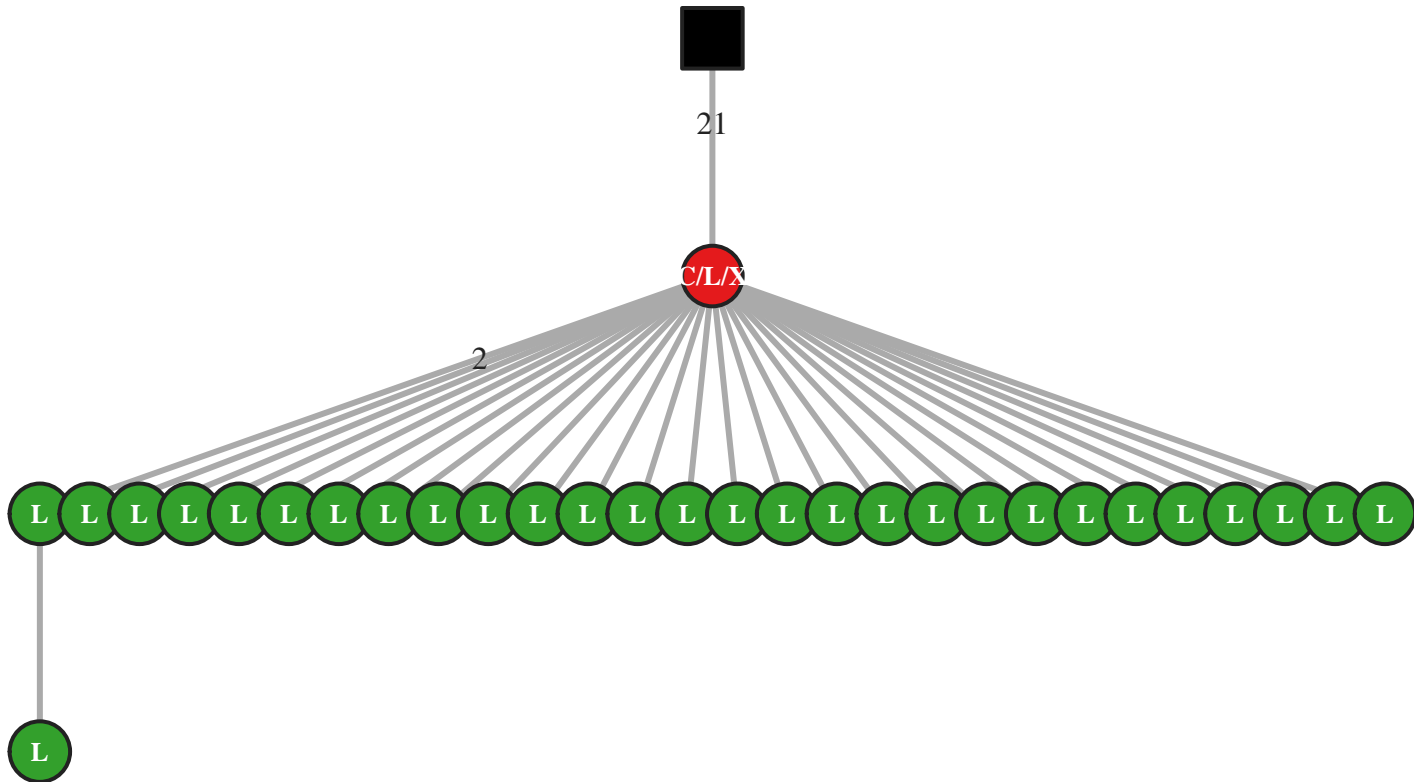

M5 IgG IGHV1-69/J4 57bp (41679)

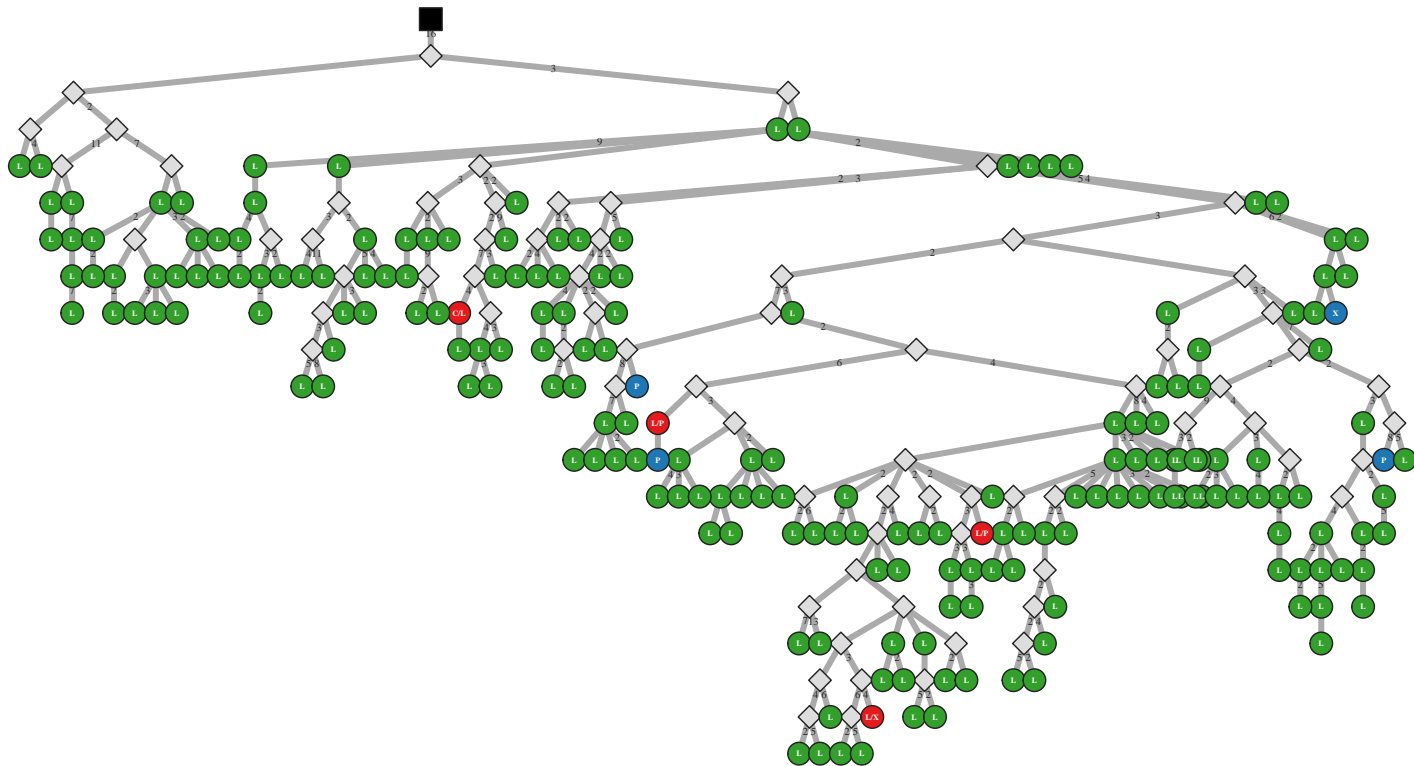

M5 IgG IGHV1-69/J4 60bp (32562)

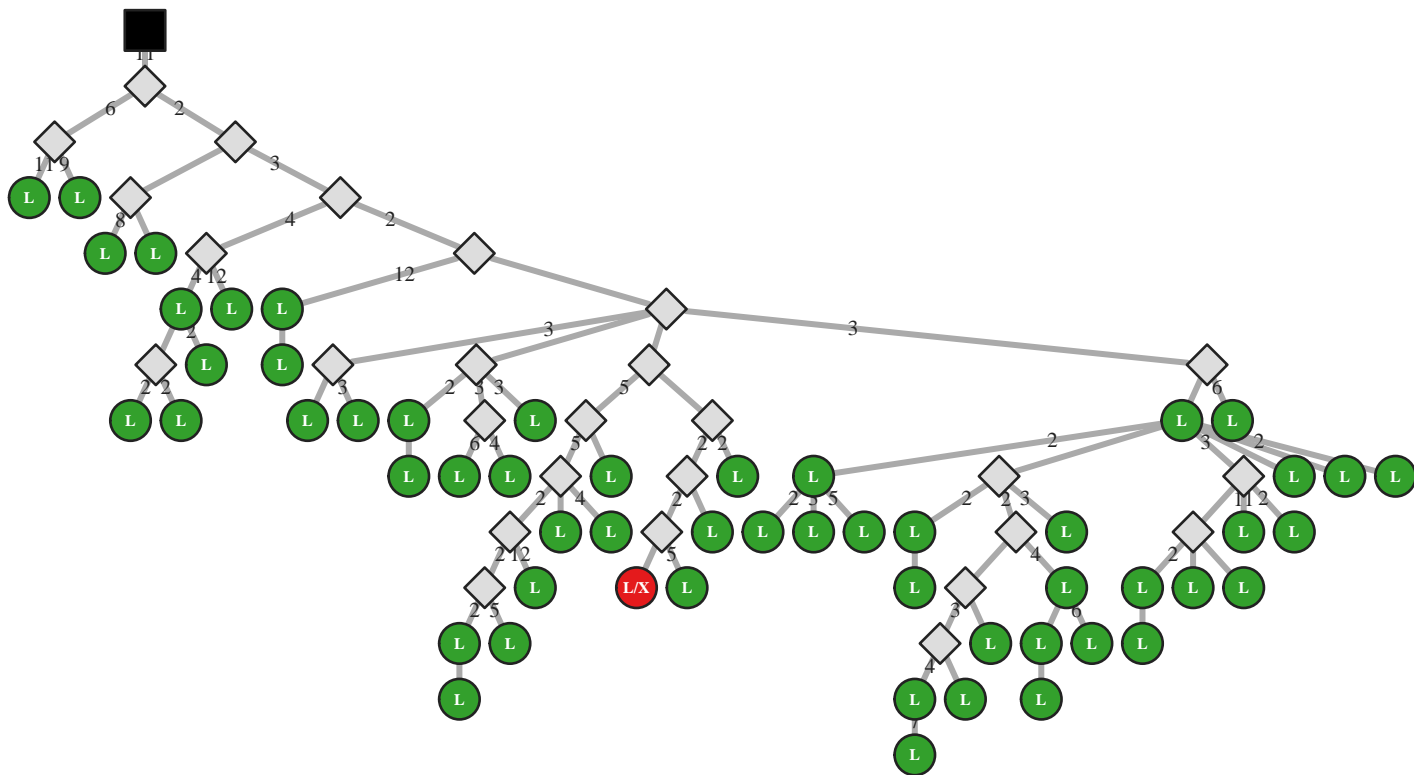

M5 IgG IGHV1-69/J4 60bp (32639)

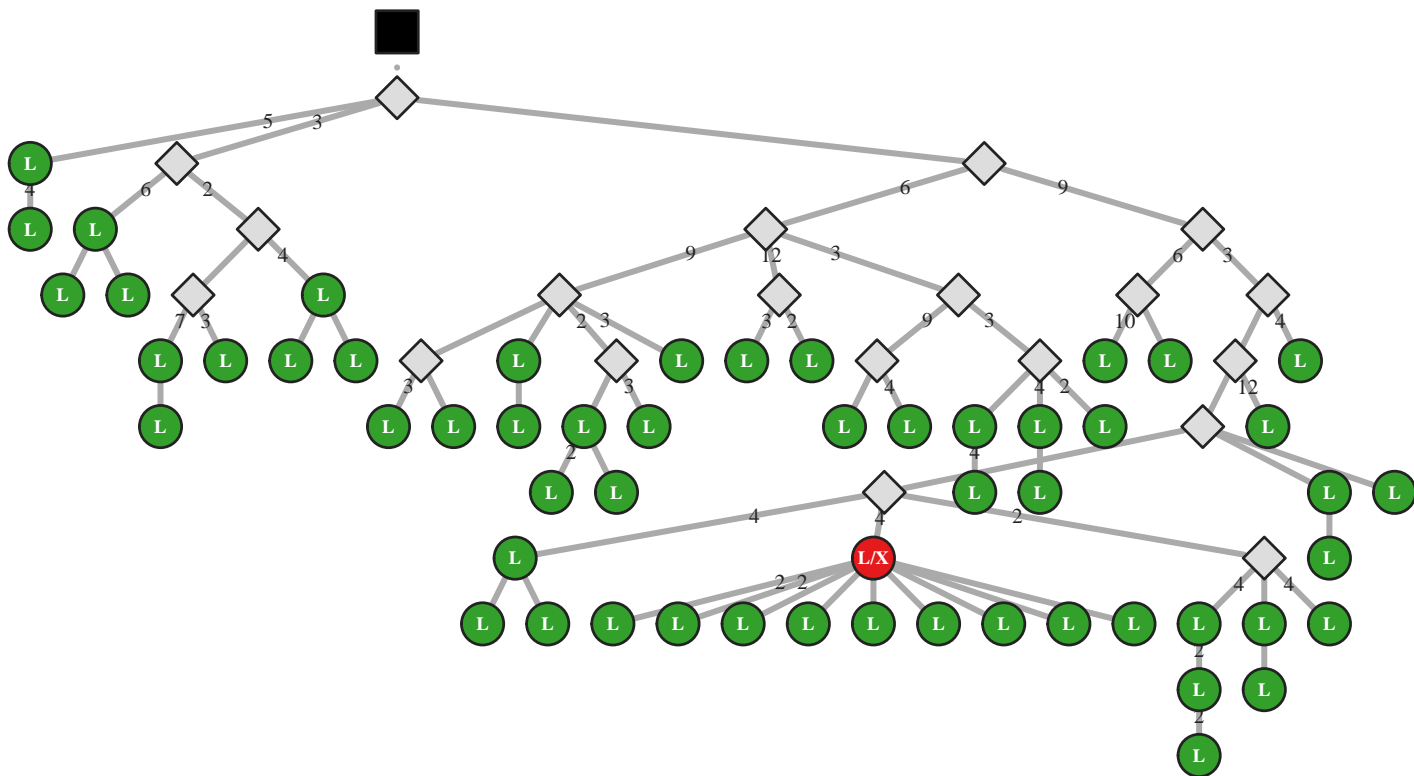

M5 IgG IGHV1-69/J4 63bp (41719)

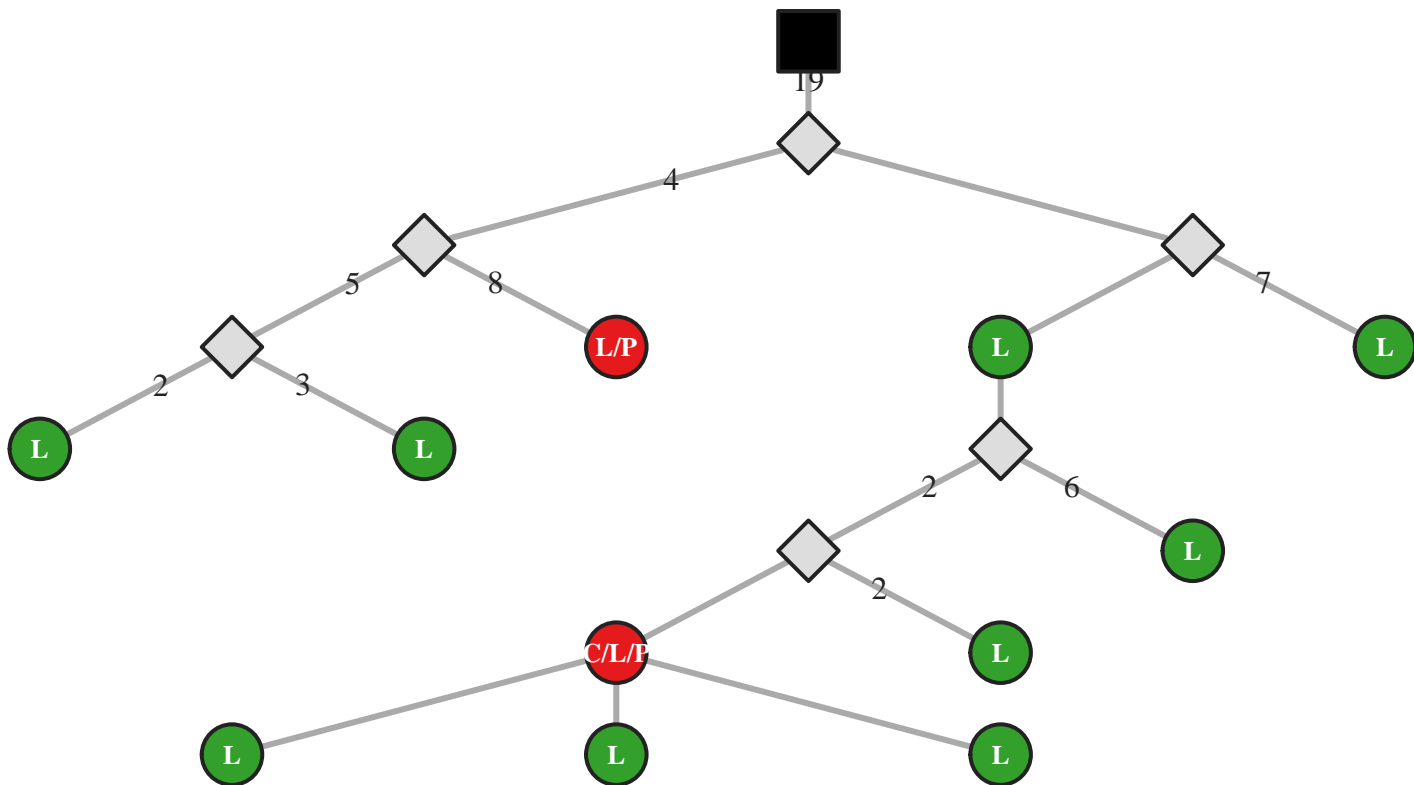

M5 IgG IGHV1-69/J4 63bp (41723)

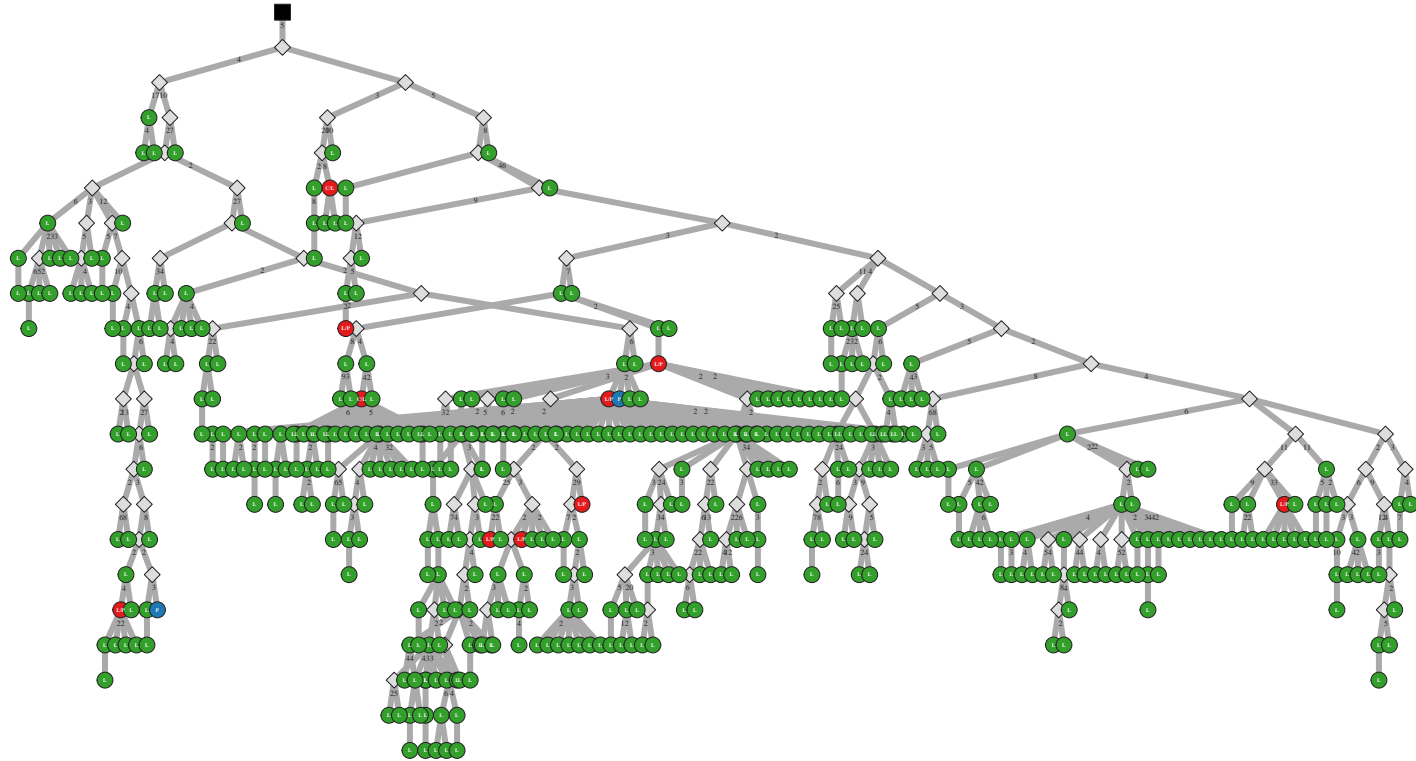

M5 IgG IGHV1-69/J4 63bp (41727)

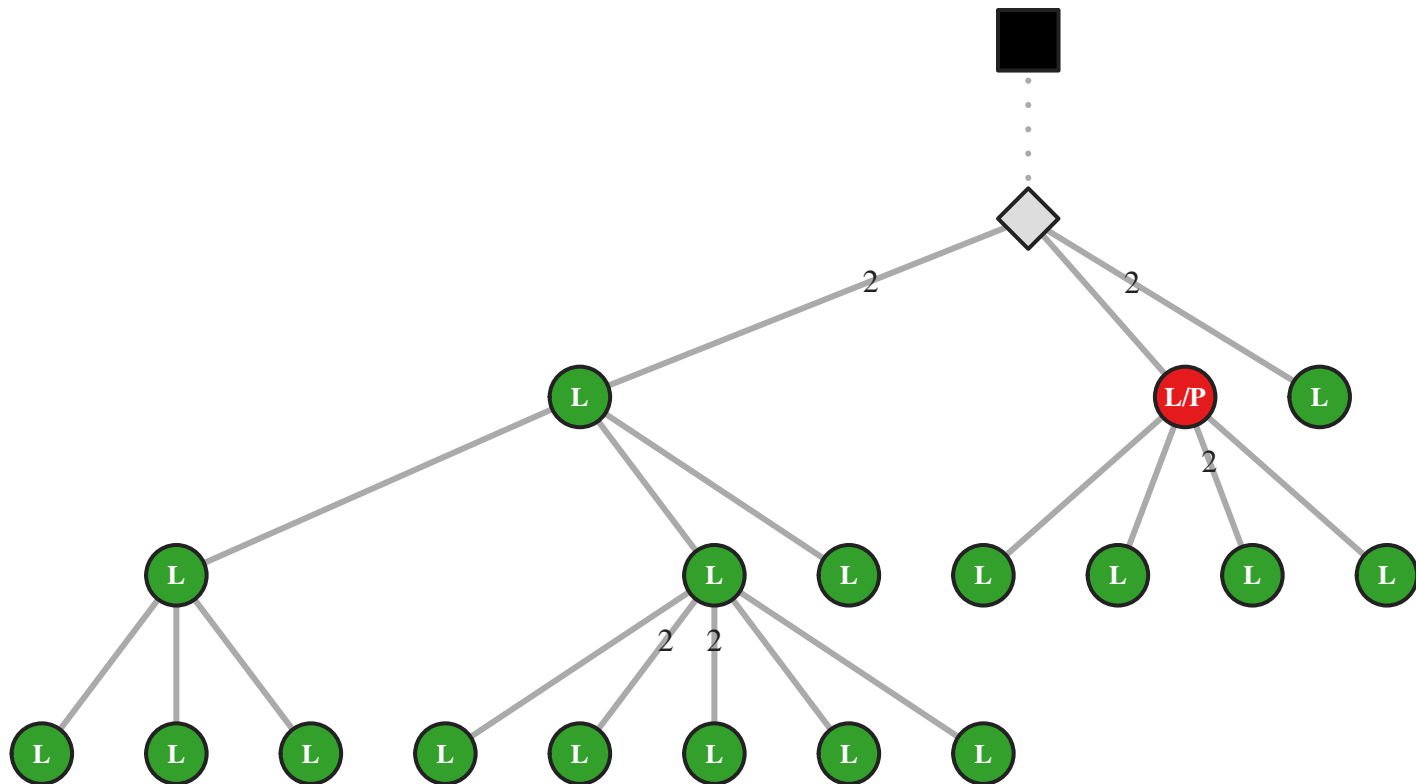

M5 IgG IGHV1-69/J4 63bp (41728)

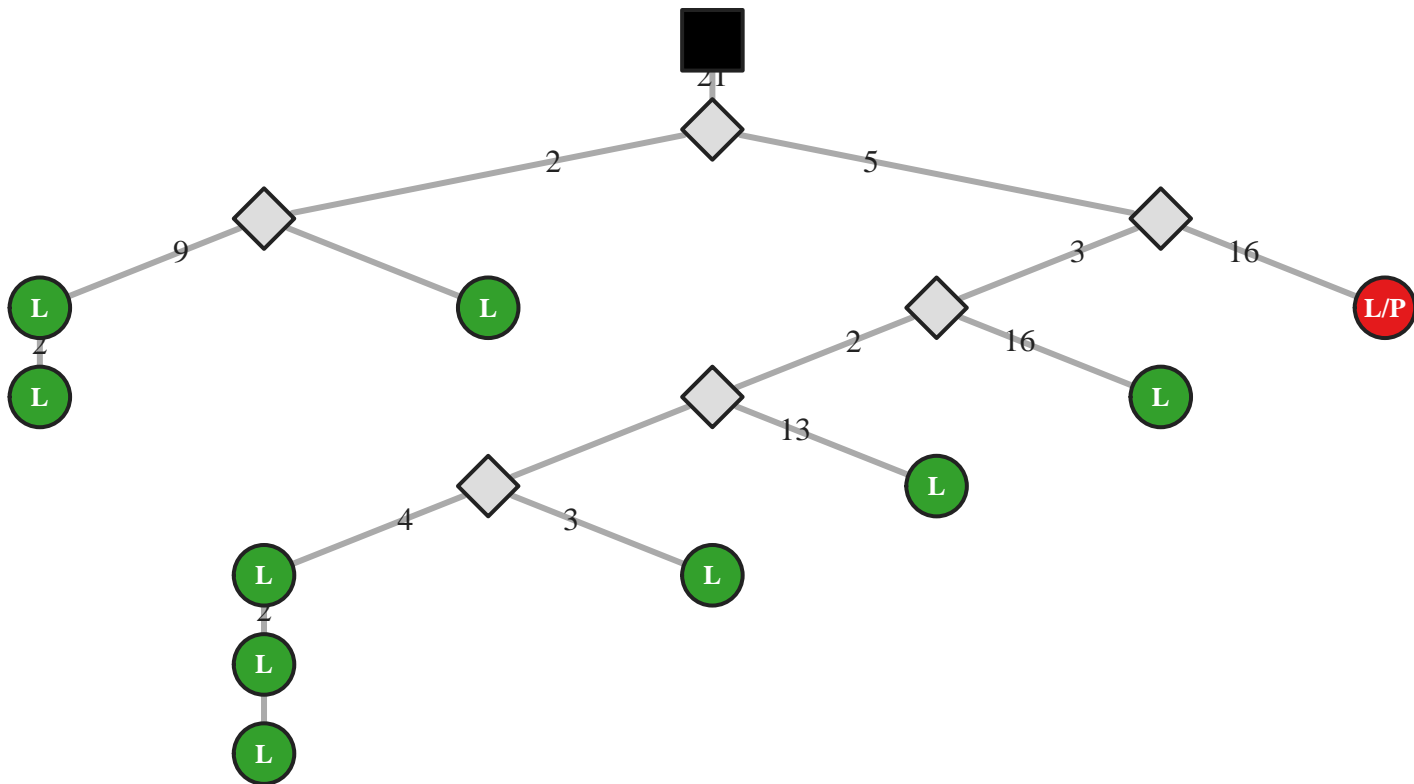

M5 IgG IGHV1-69/J4 63bp (41767)

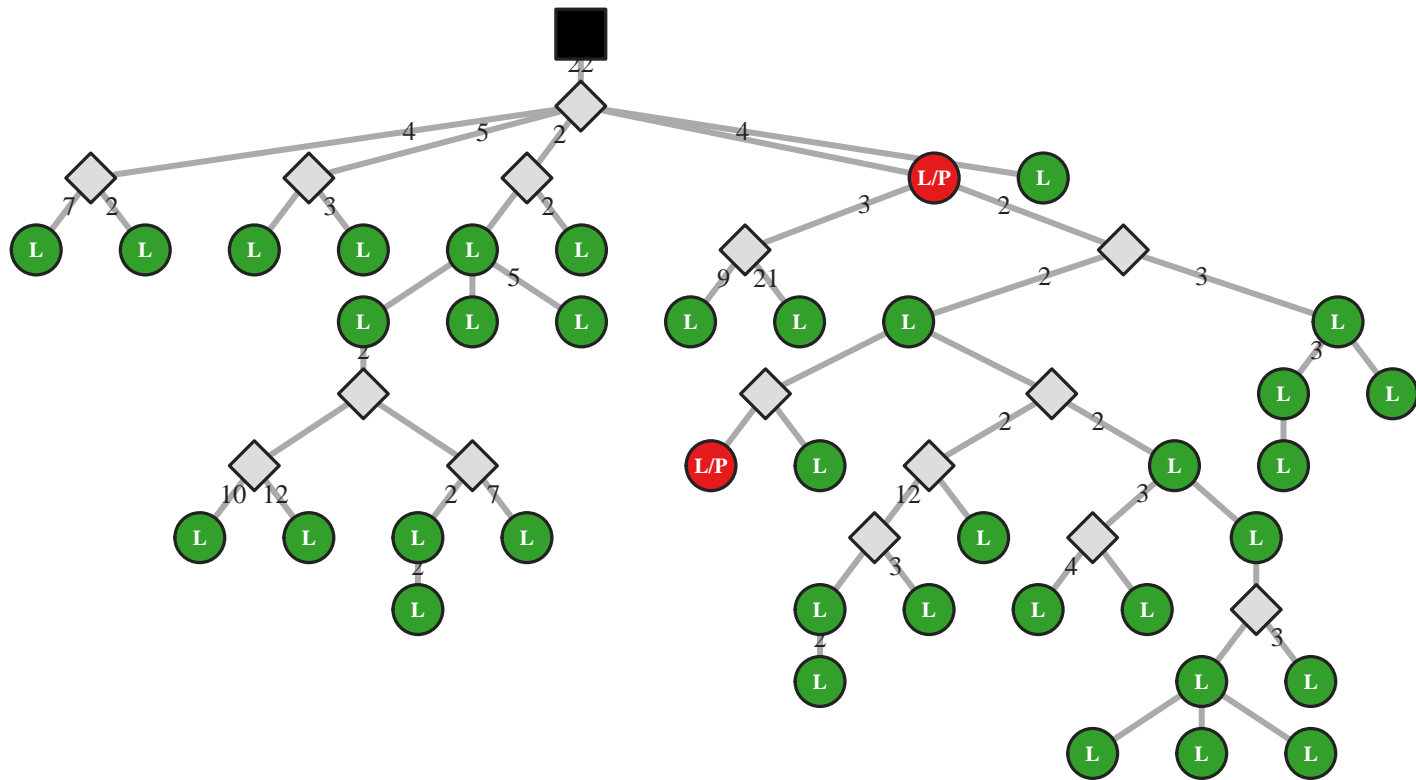

M5 IgG IGHV1-69/J4 66bp (41796)

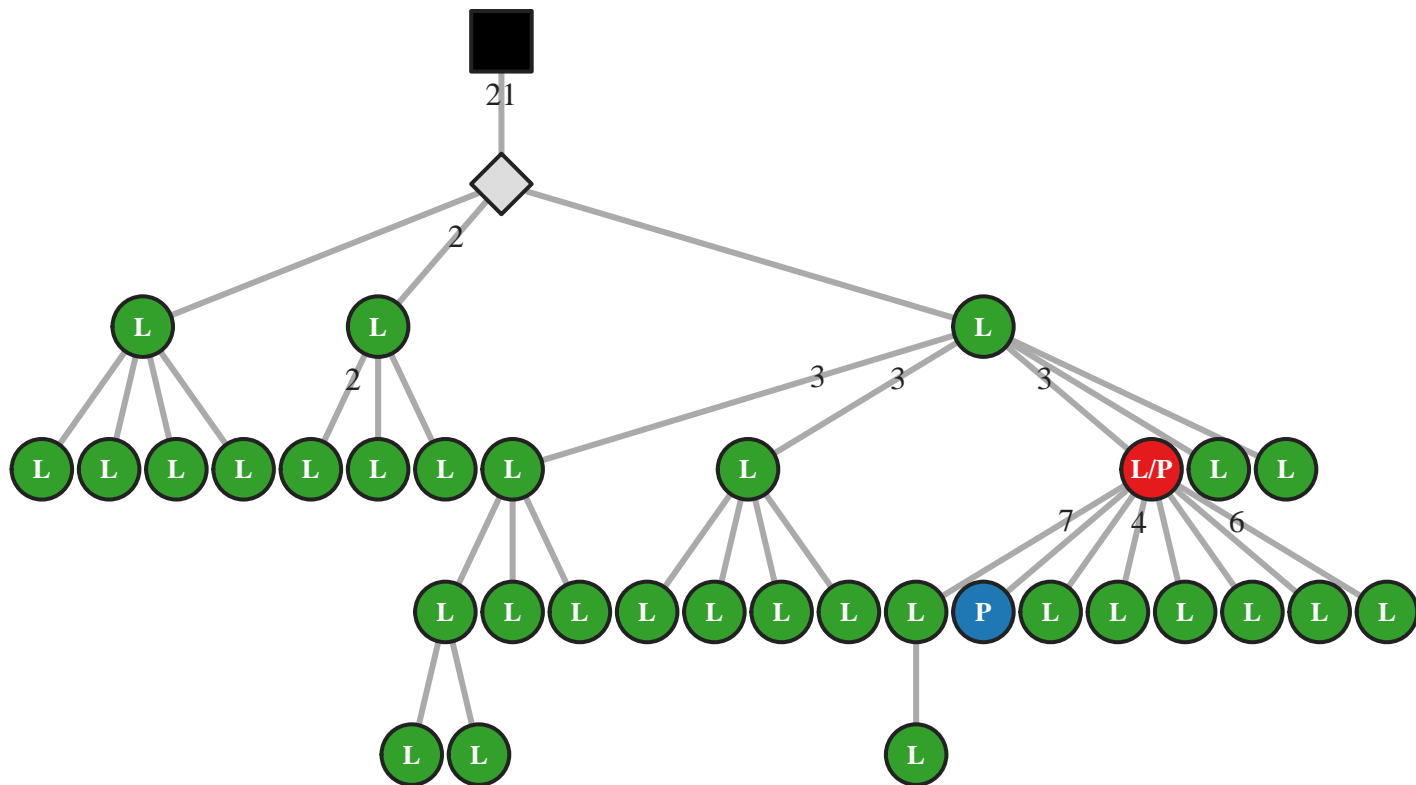

M5 IgG IGHV1-69/J4 69bp (5271)

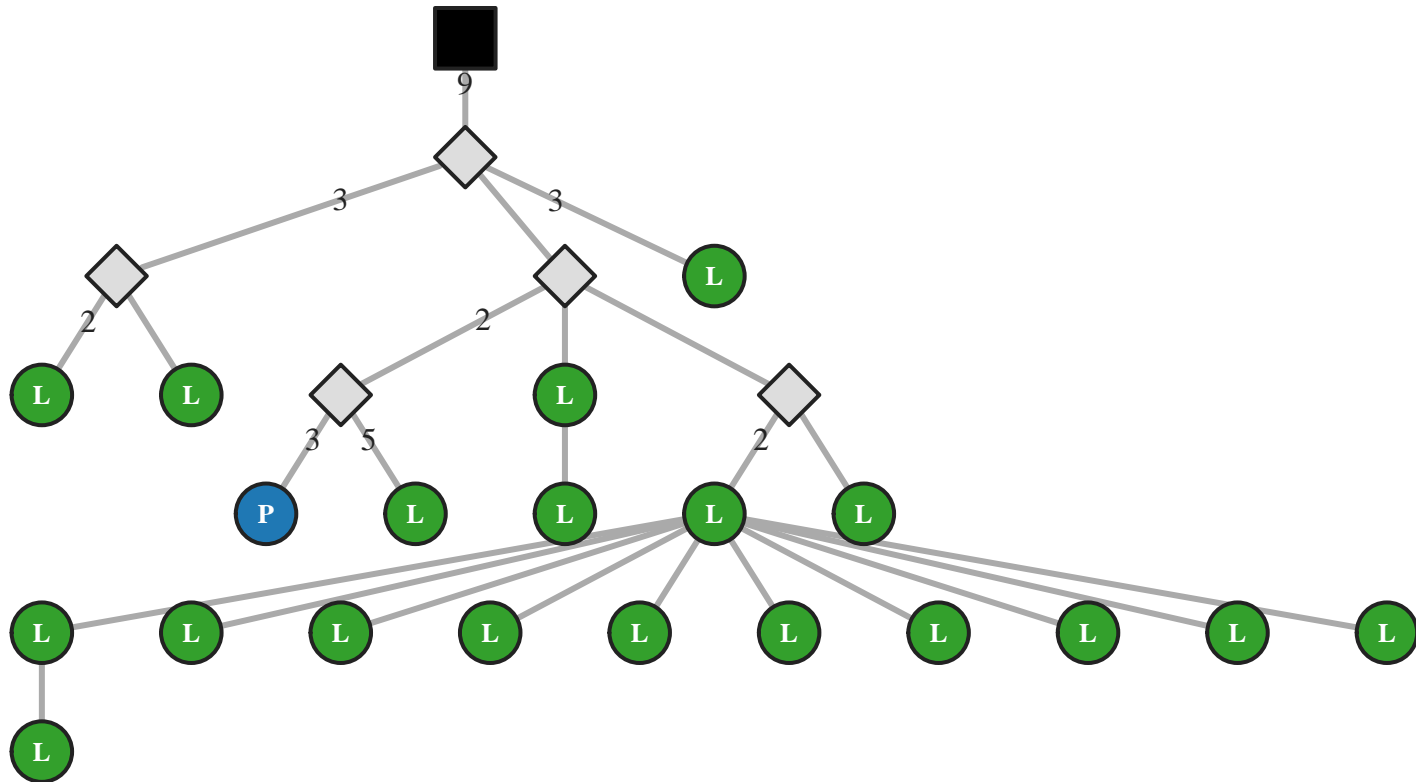

M5 IgG IGHV1-69/J5 30bp (14822)

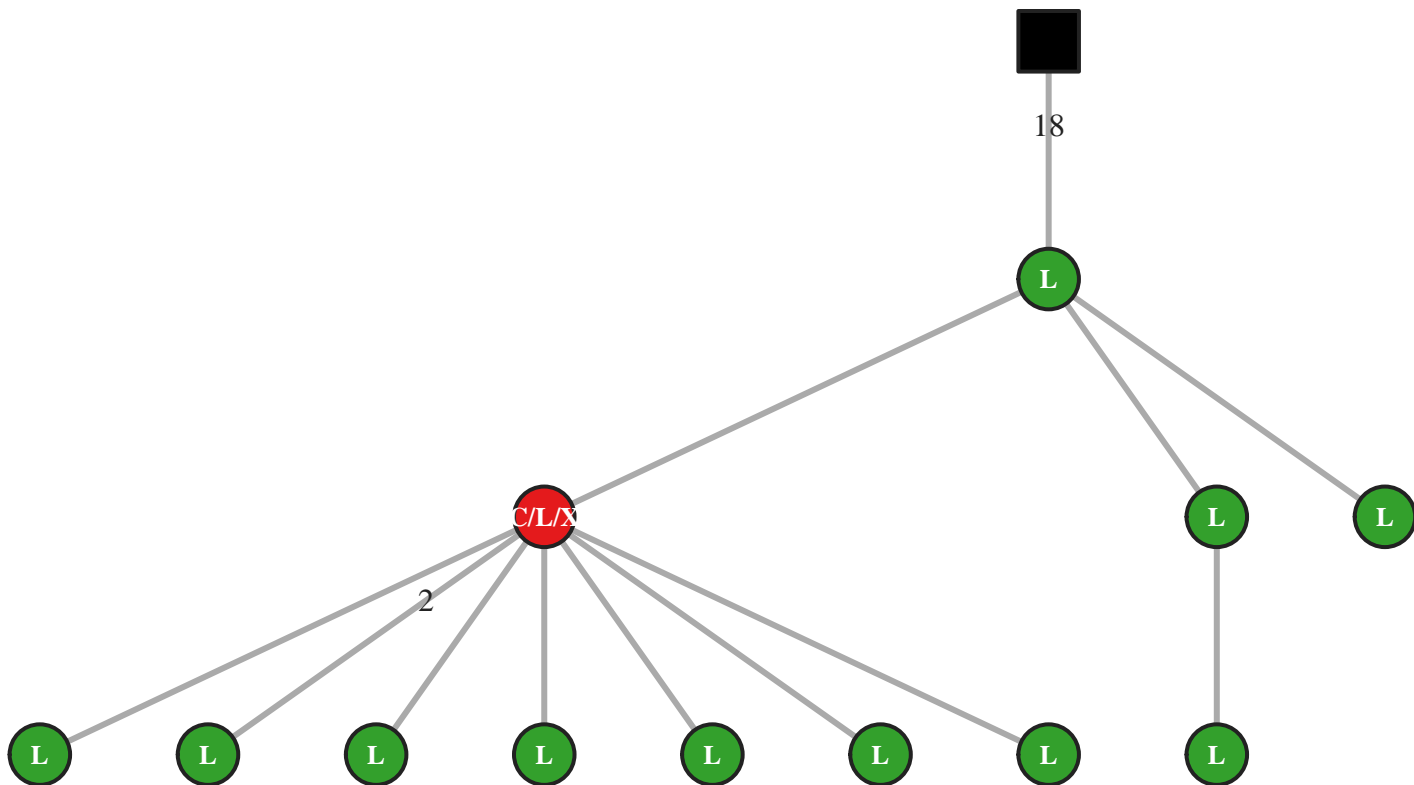

M5 IgG IGHV1-69/J5 30bp (14825)

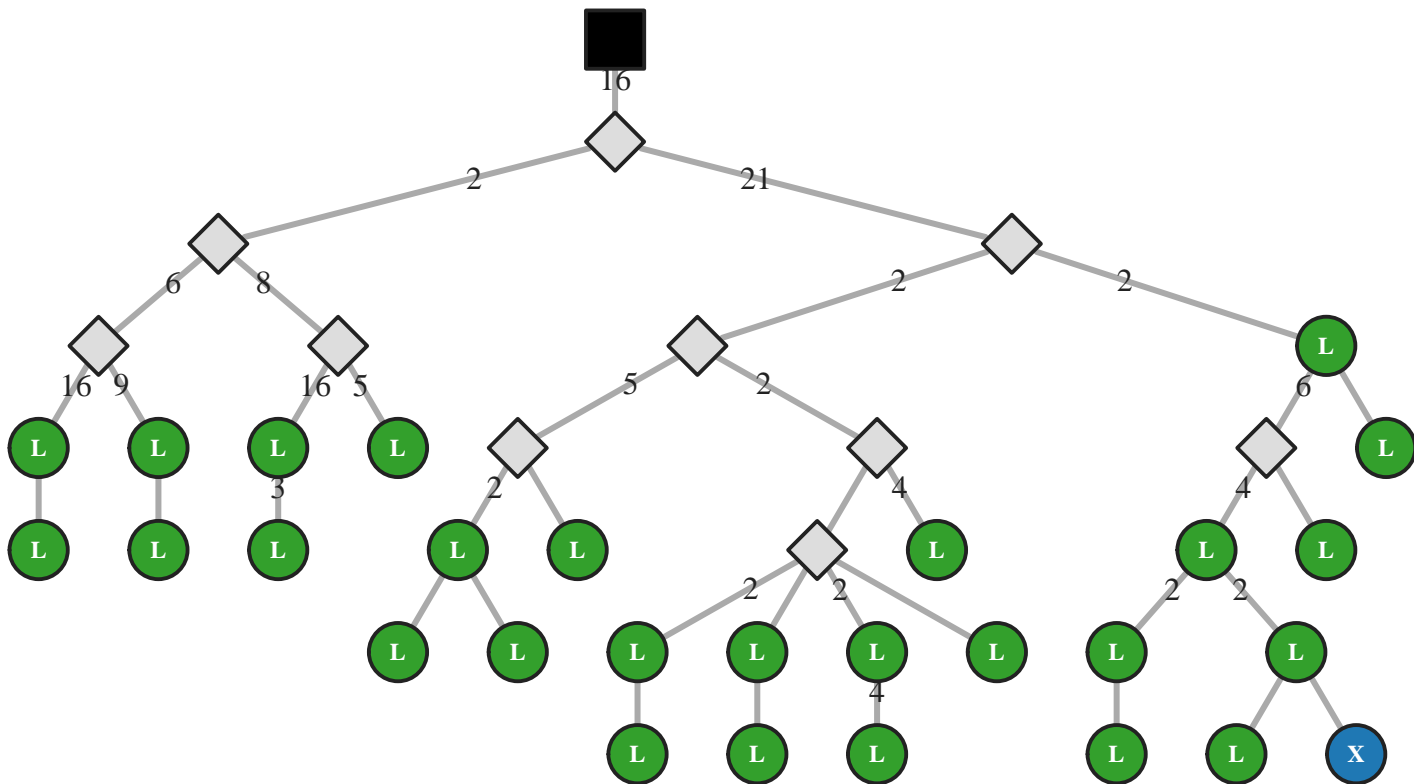

M5 IgG IGHV1-69/J5 36bp (41831)

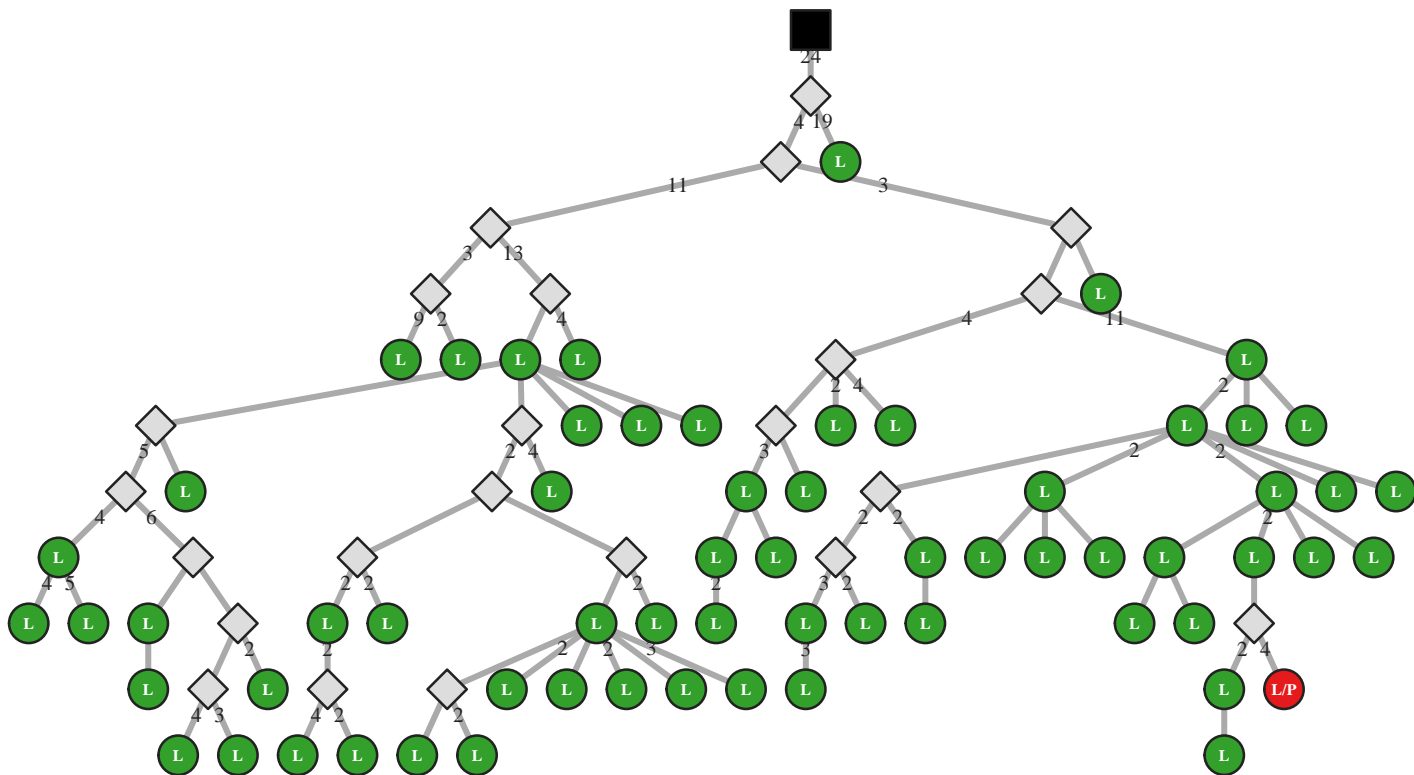

M5 IgG IGHV1-69/J5 36bp (41834)

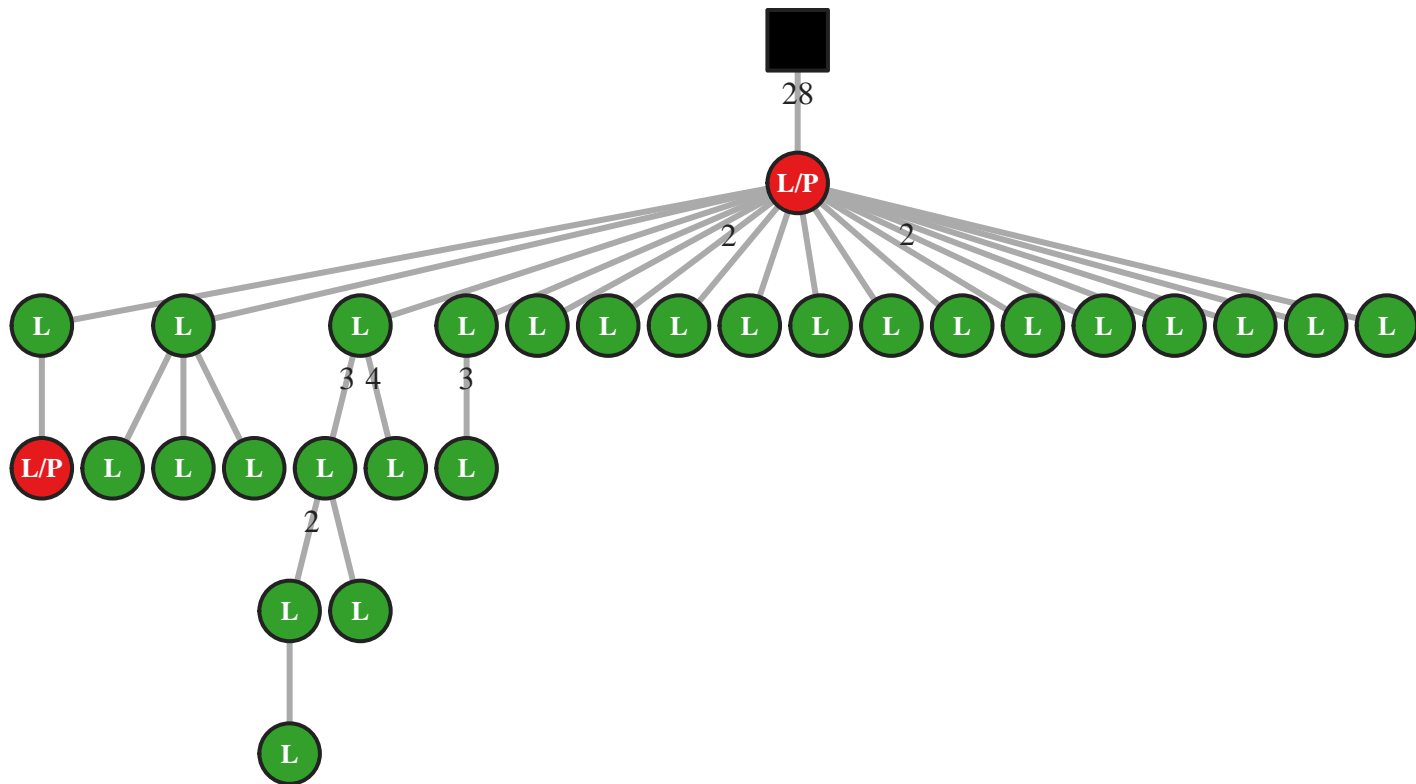

M5 IgG IGHV1-69/J5 36bp (41849)

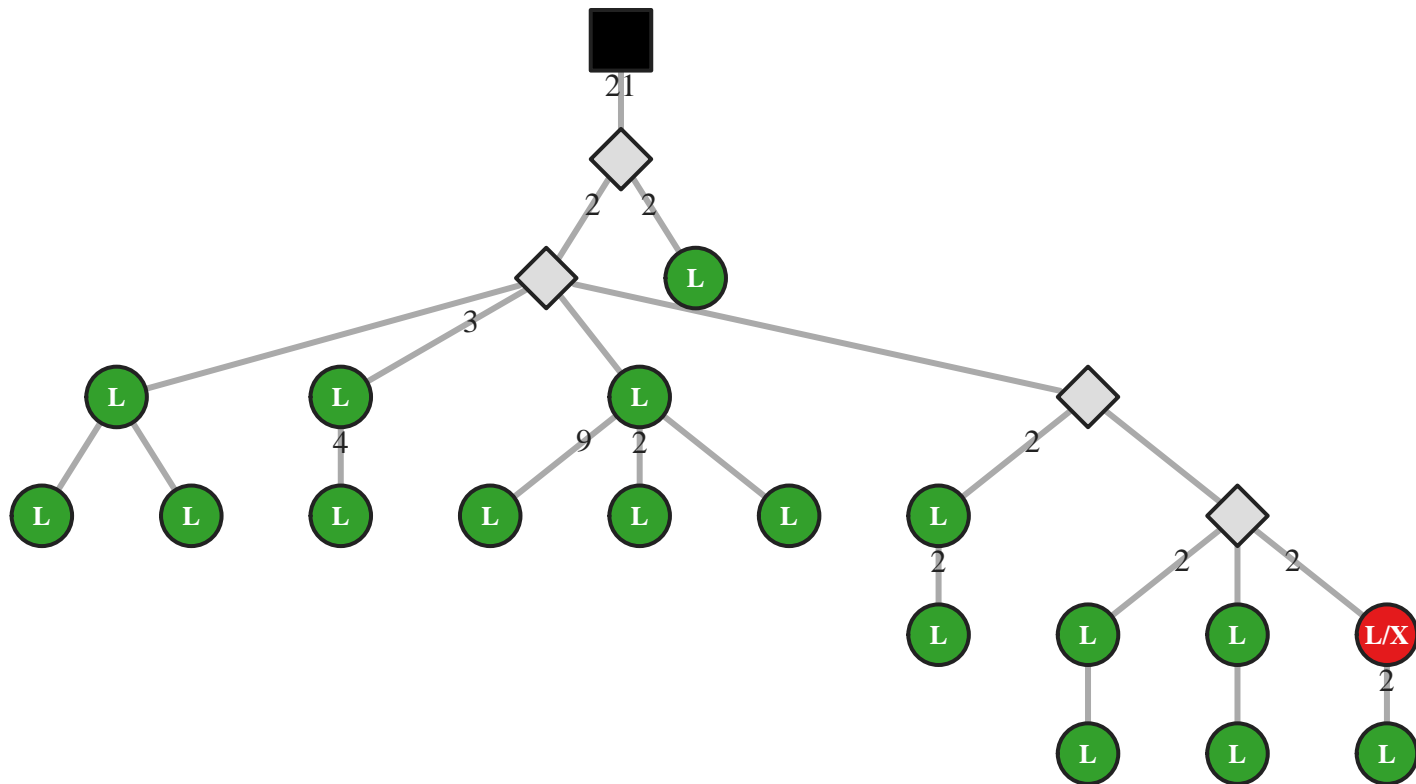

M5 IgG IGHV1-69/J5 39bp (41854)

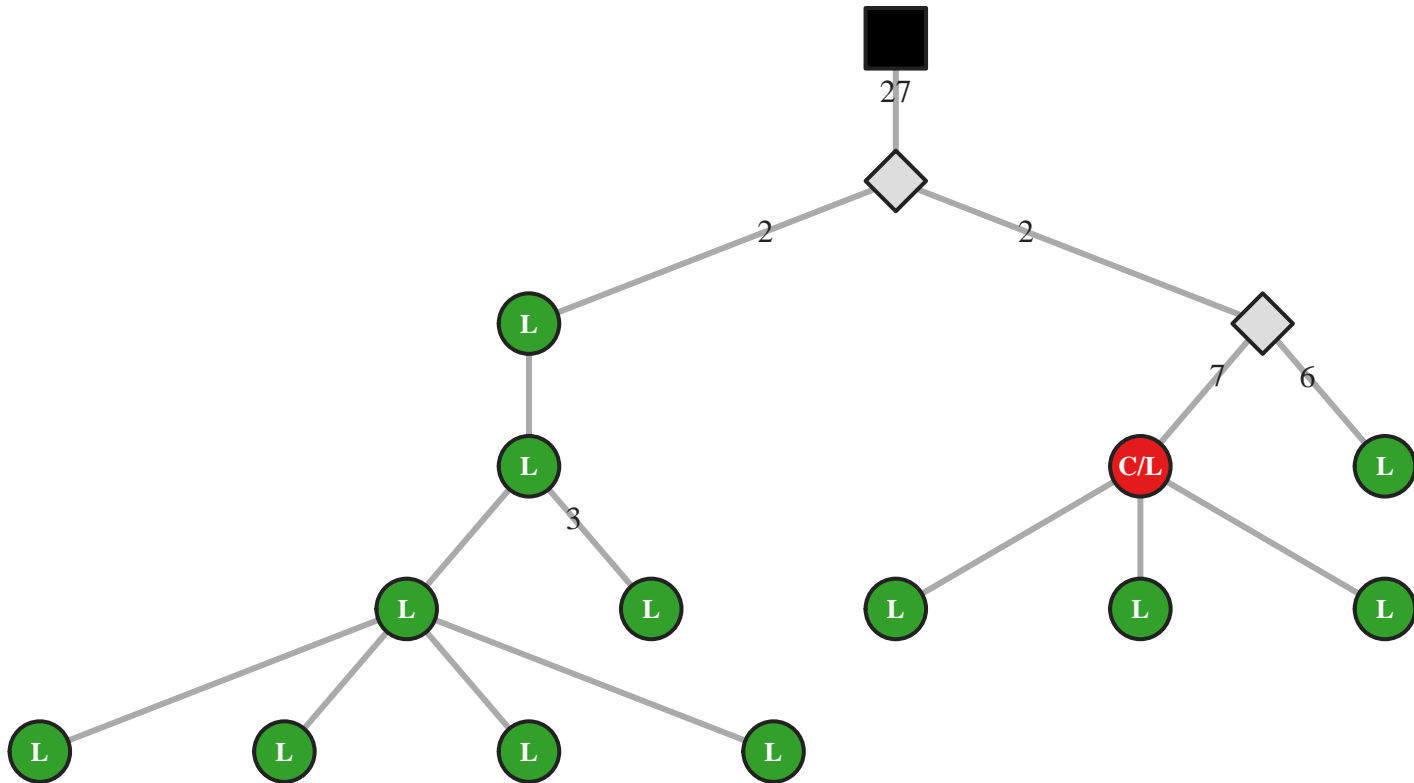

M5 IgG IGHV1-69/J5 39bp (41862)

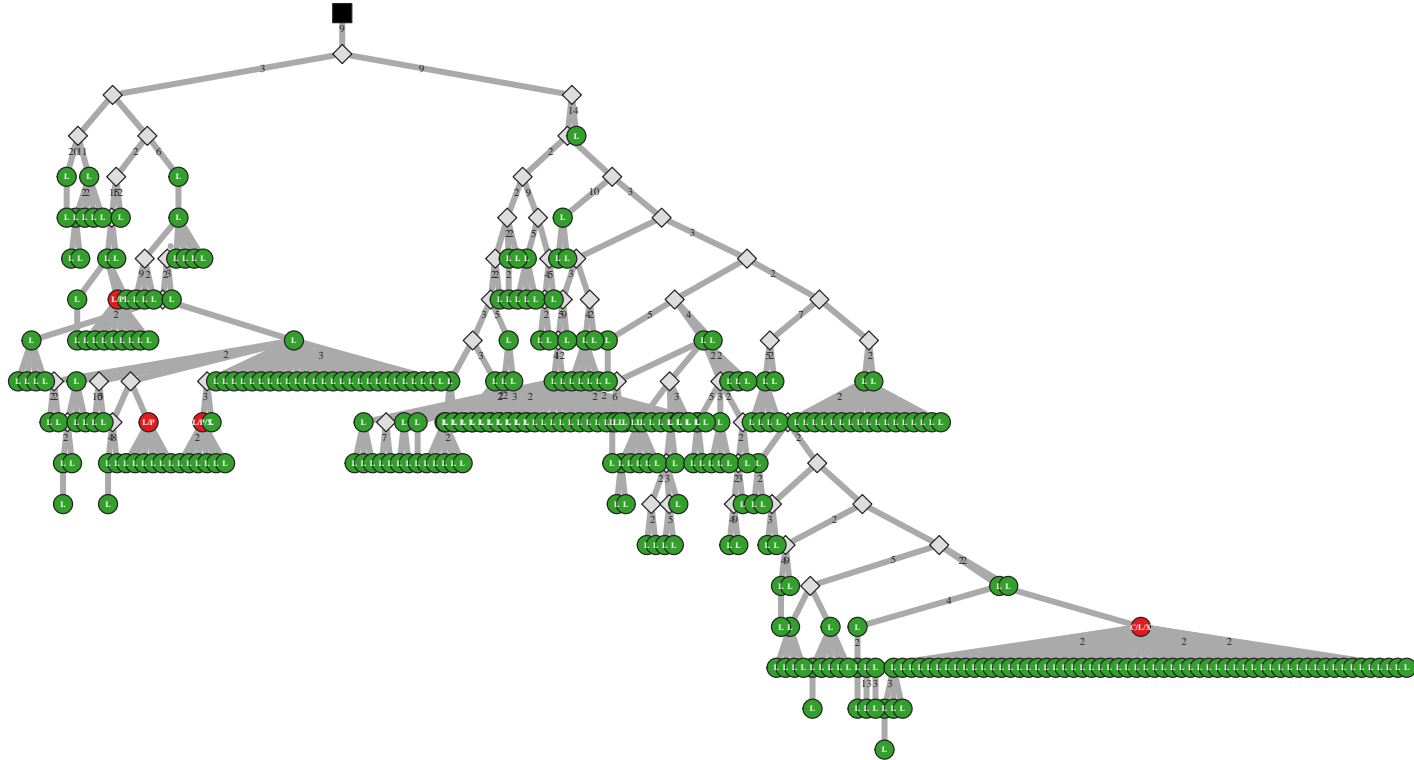

M5 IgG IGHV1-69/J5 39bp (41867)

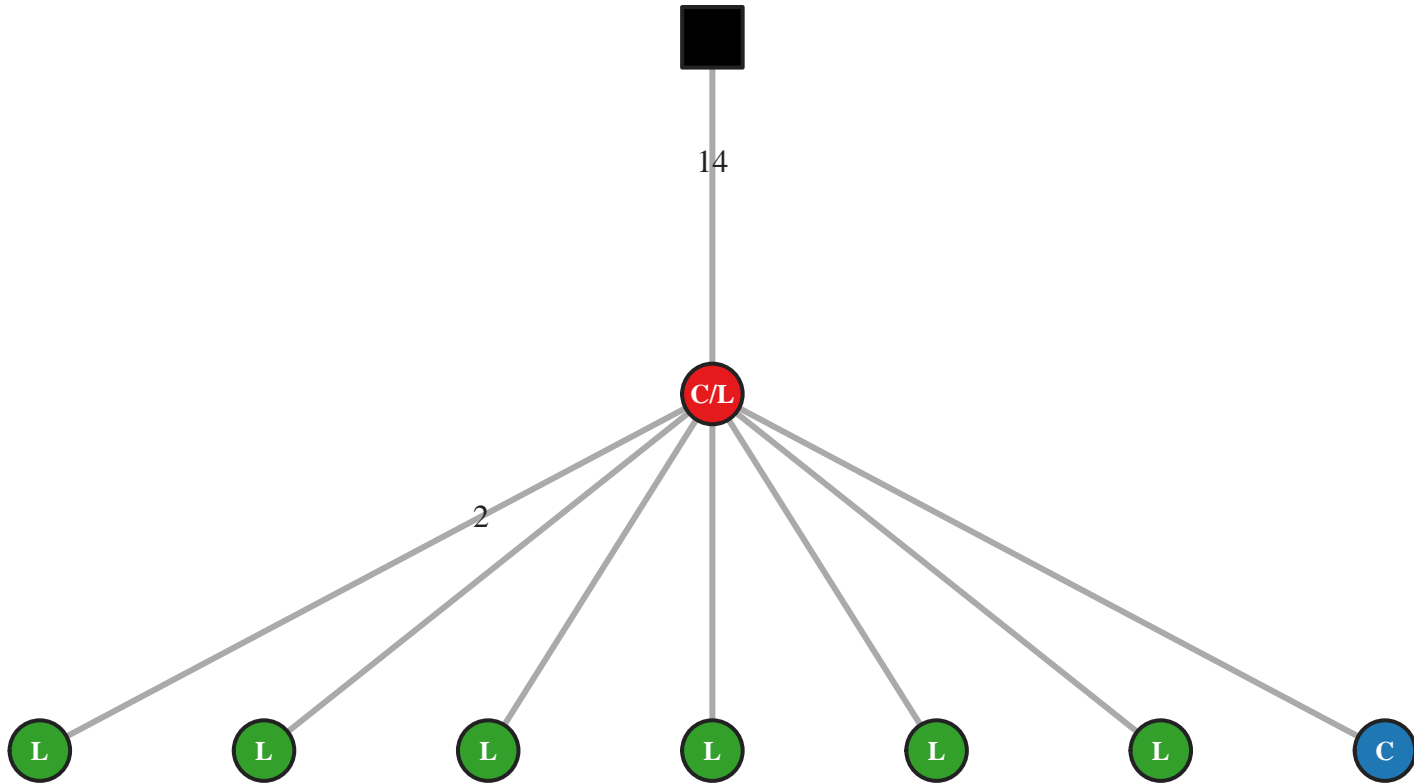

M5 IgG IGHV1-69/J5 39bp (41886)

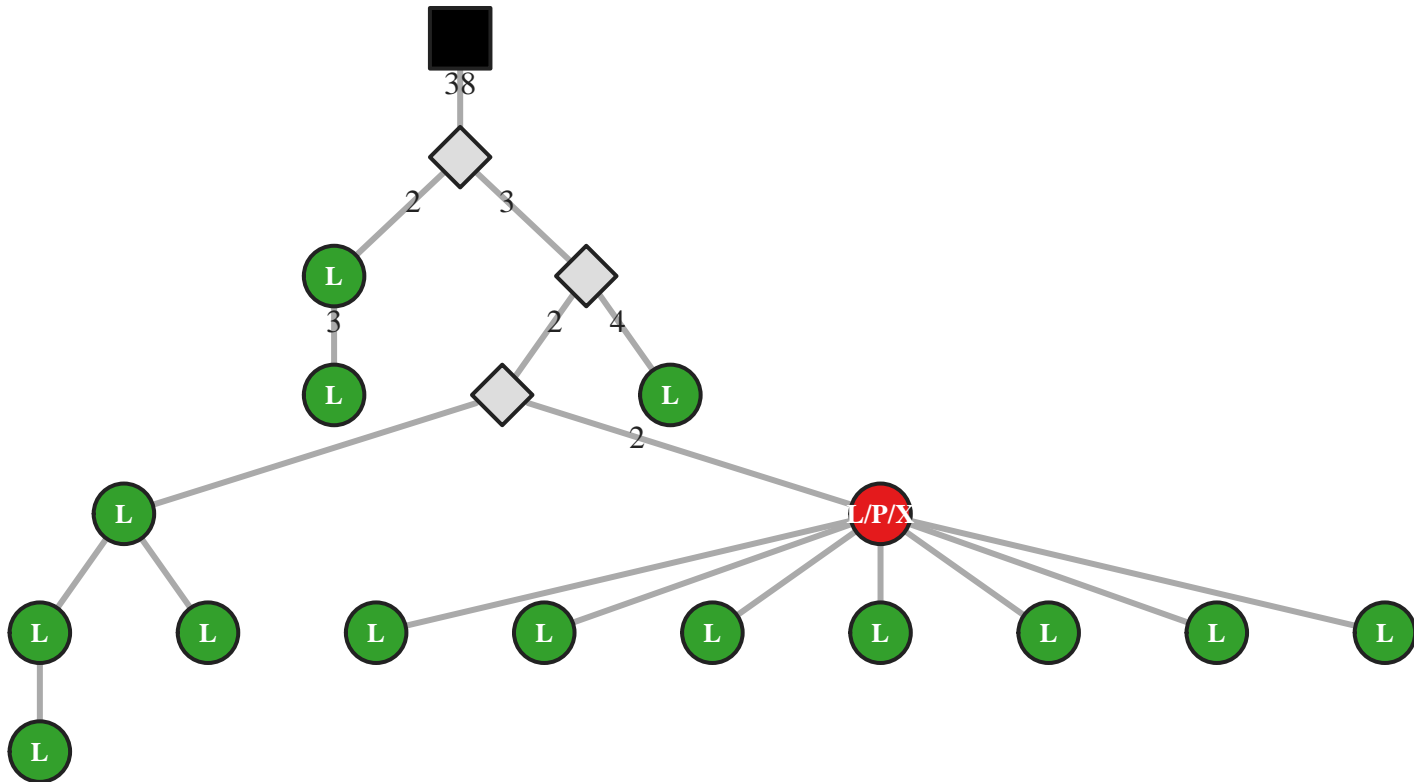

M5 IgG IGHV1-69/J5 42bp (23888)

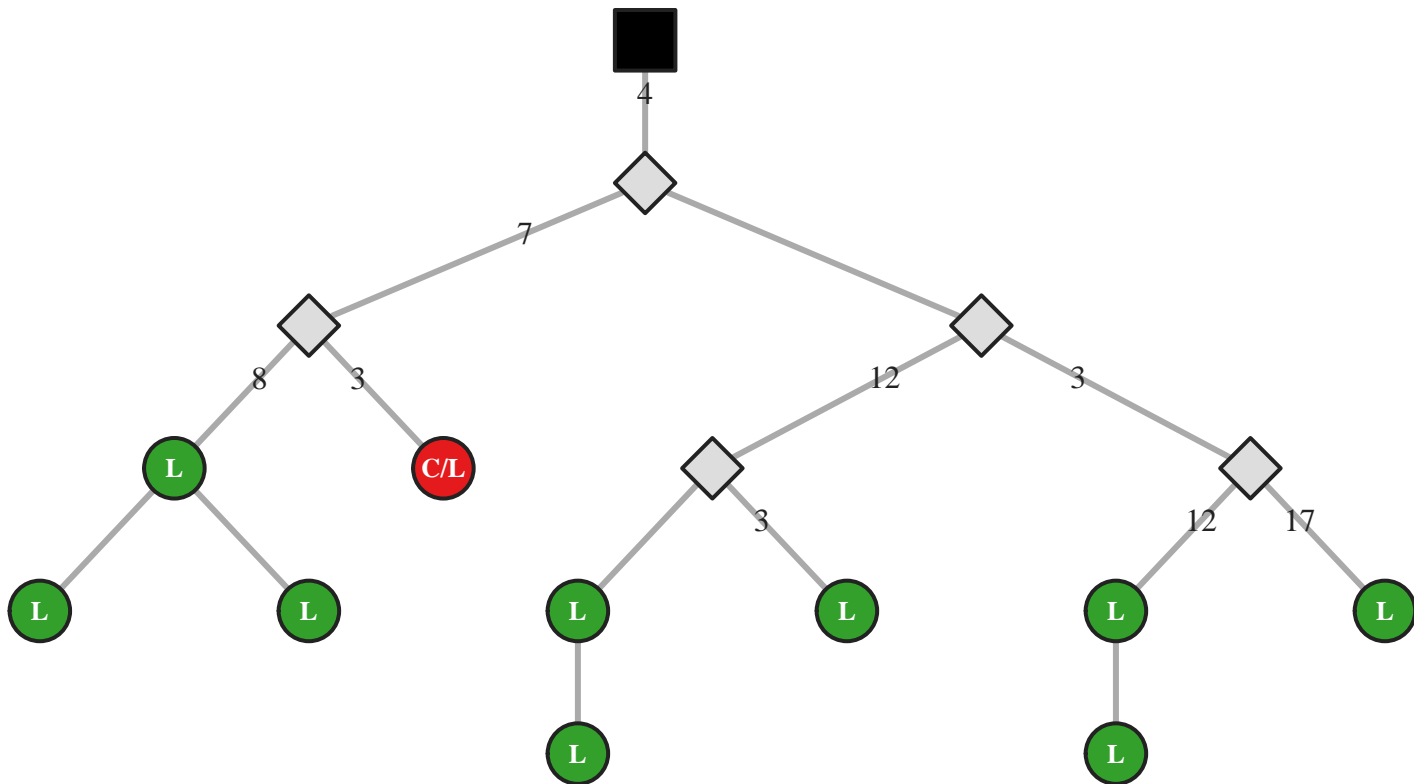

M5 IgG IGHV1-69/J5 42bp (23903)

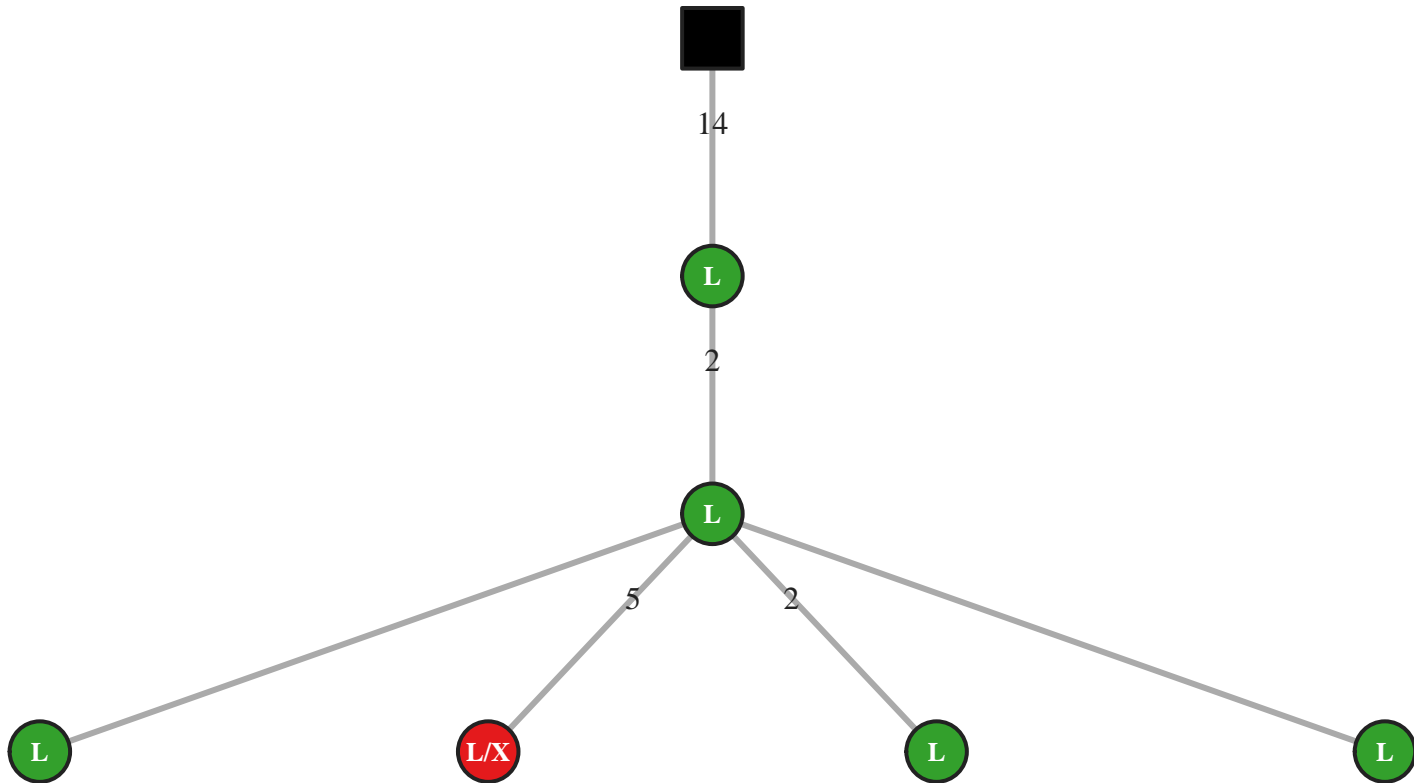

M5 IgG IGHV1-69/J5 42bp (23909)

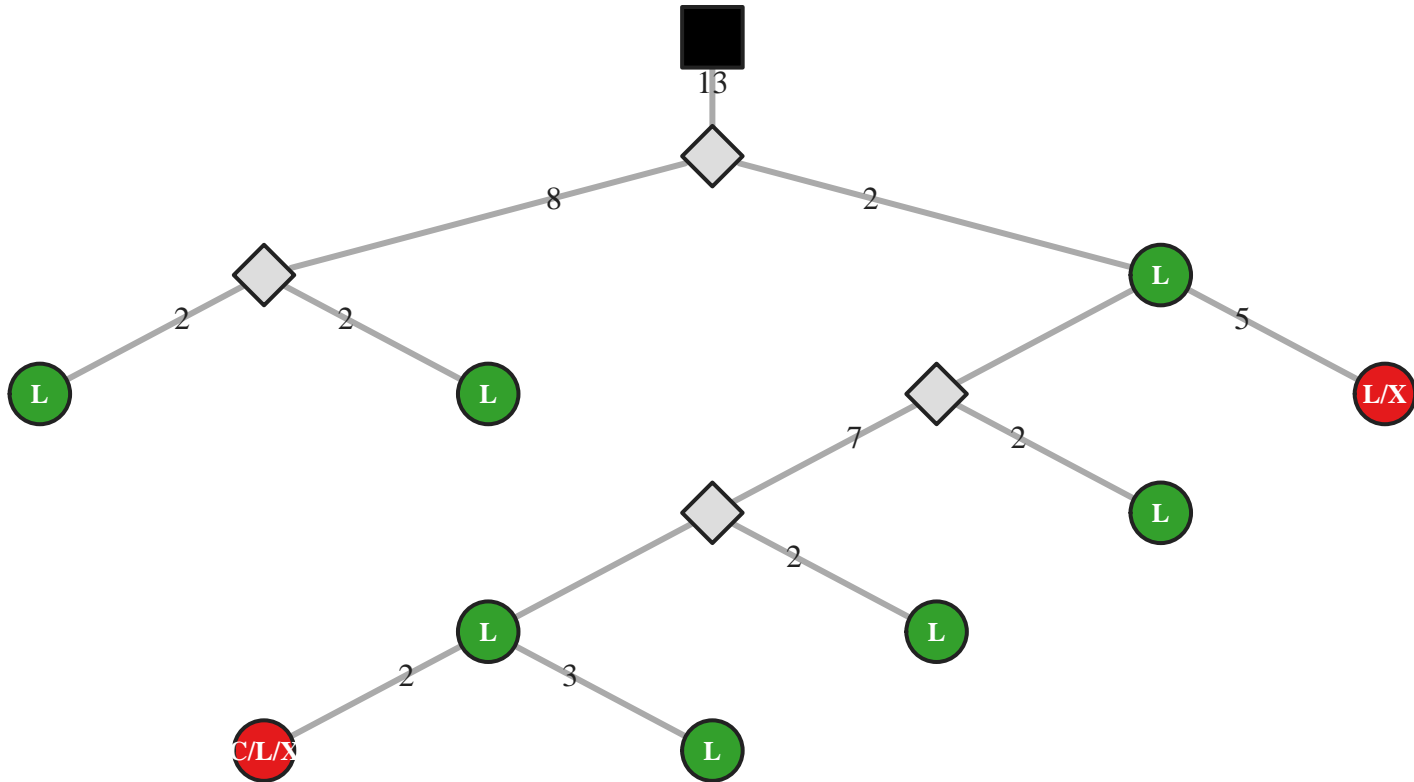

M5 IgG IGHV1-69/J5 45bp (5287)

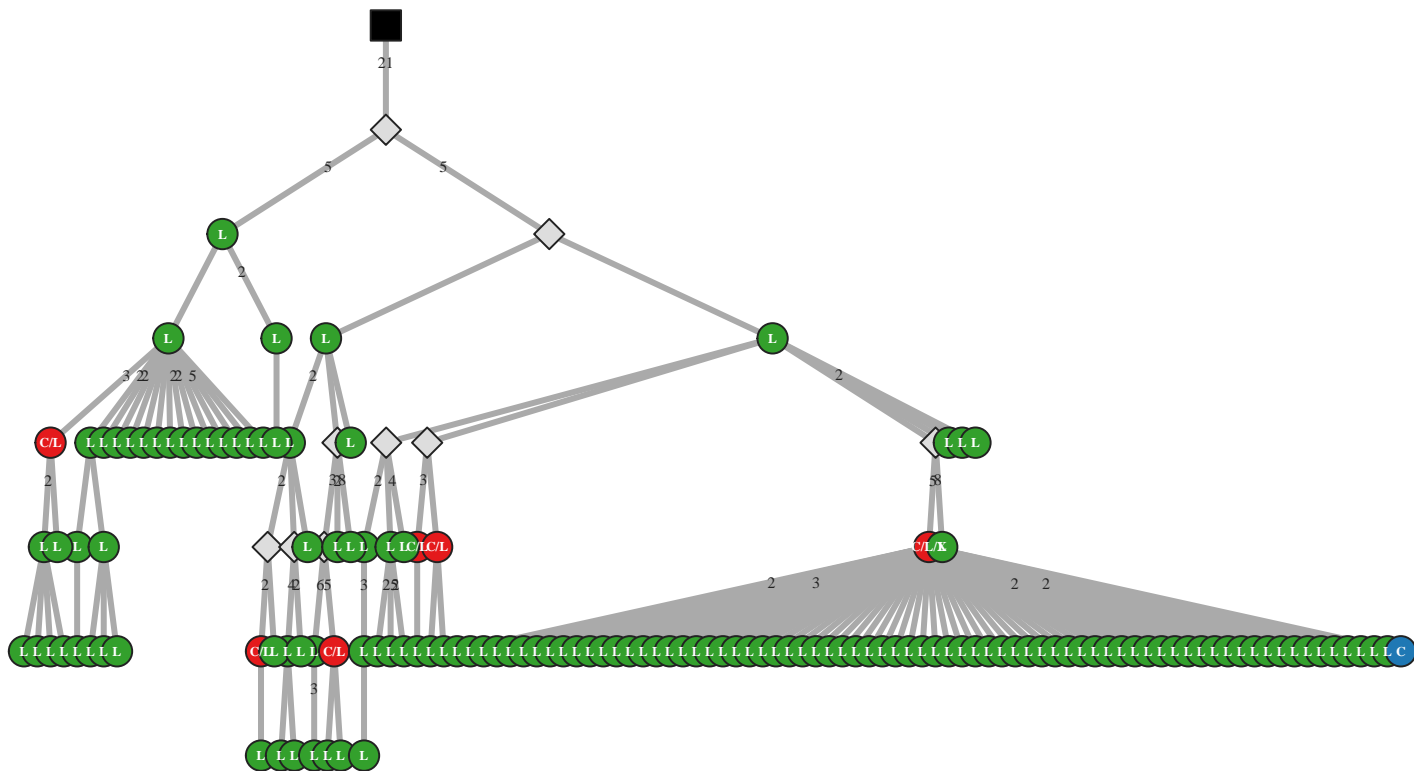

M5 IgG IGHV1-69/J5 45bp (5300)

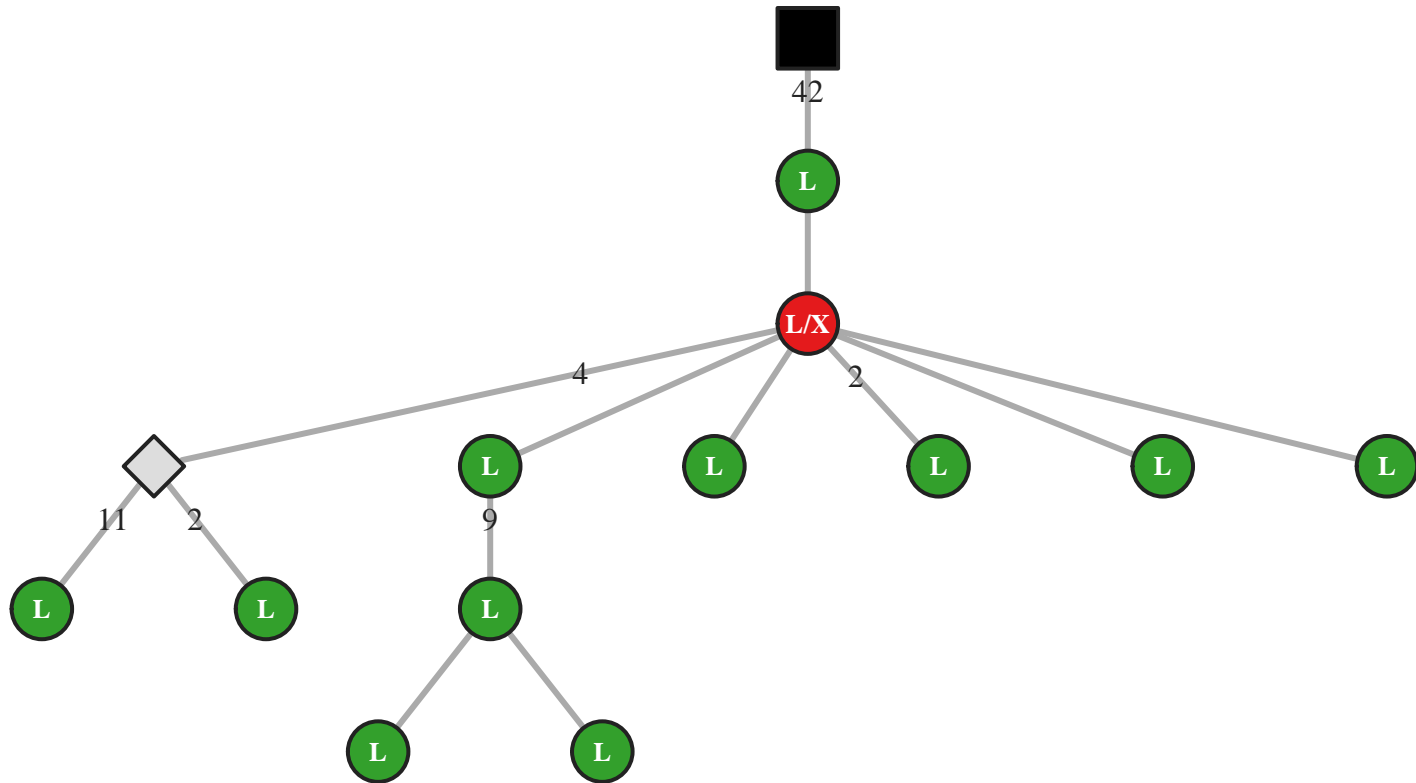

M5 IgG IGHV1-69/J5 48bp (41899)

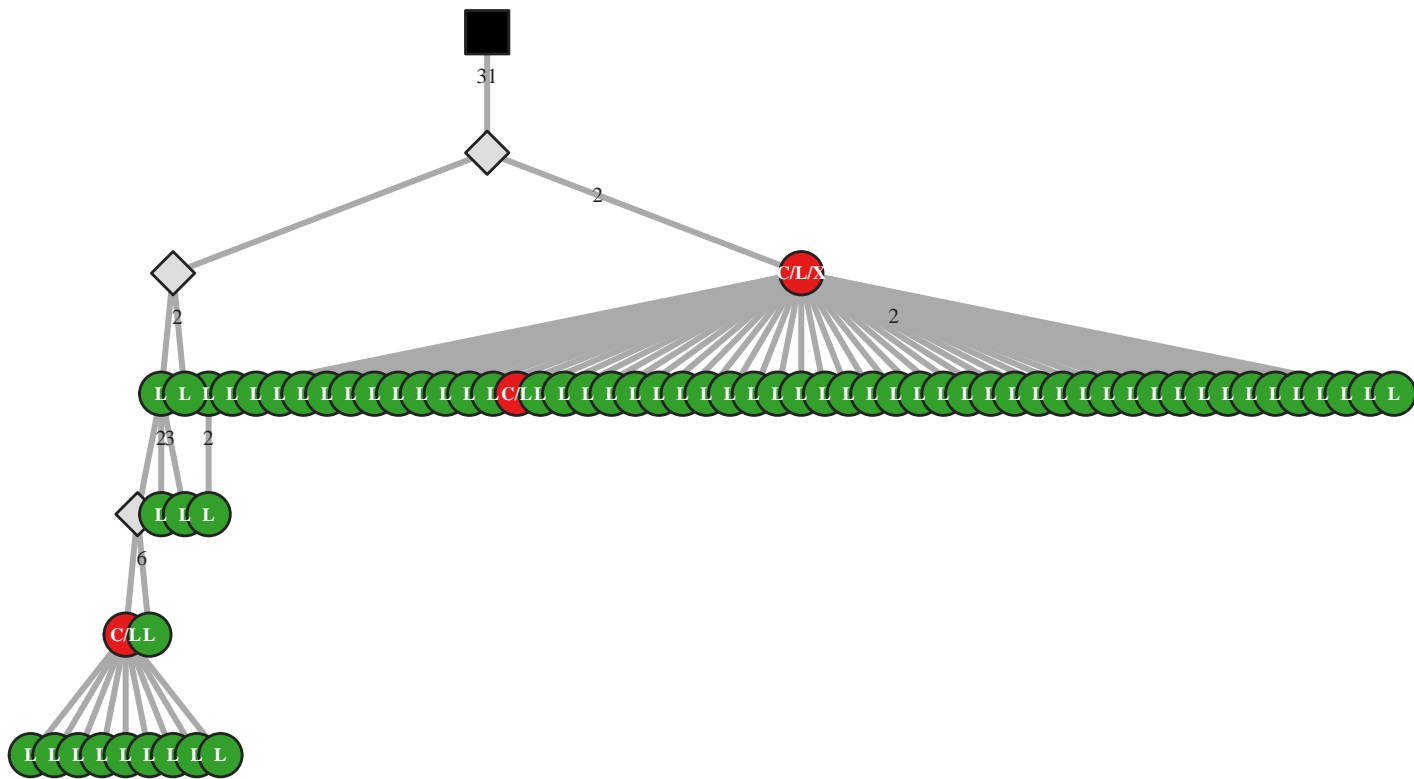

M5 IgG IGHV1-69/J5 48bp (41900)

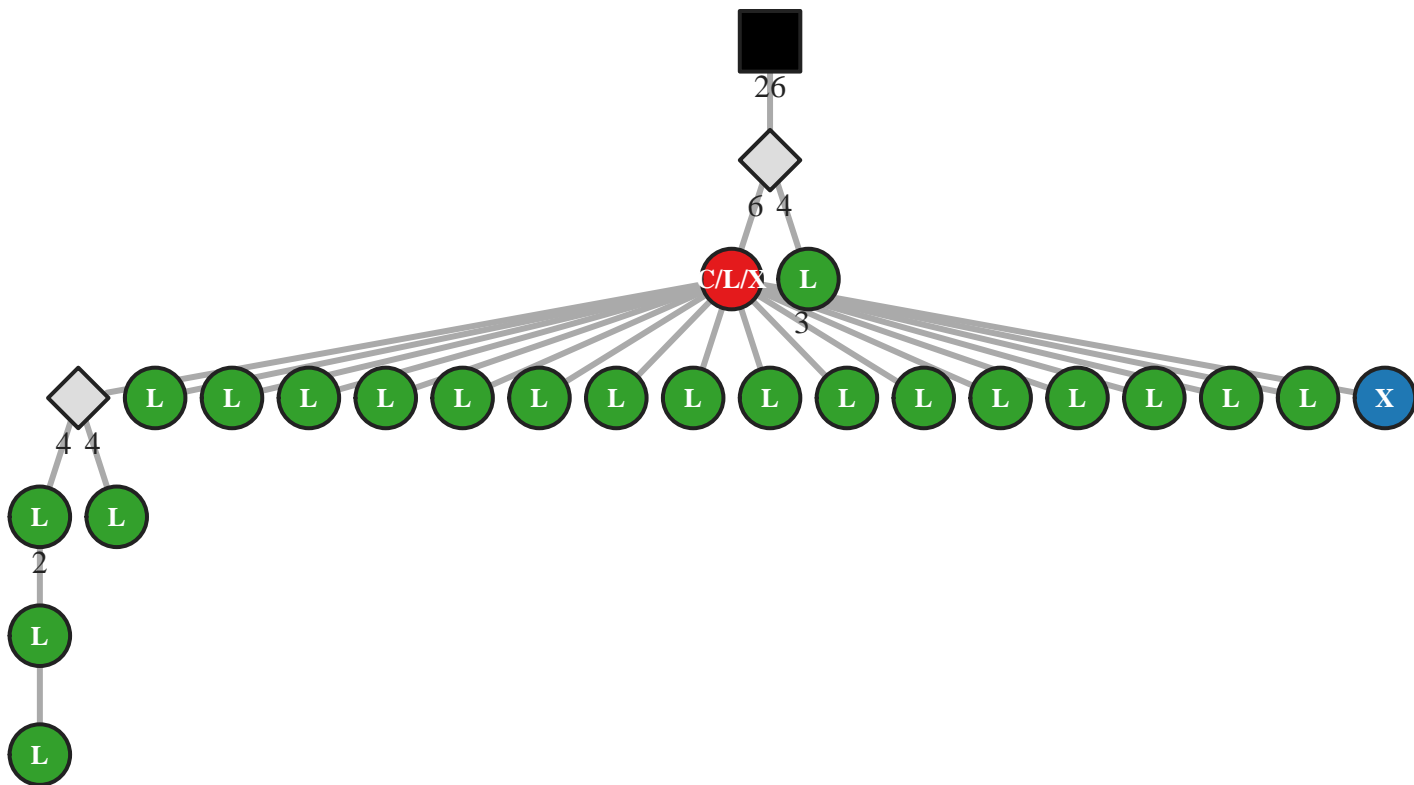

M5 IgG IGHV1-69/J5 48bp (41913)

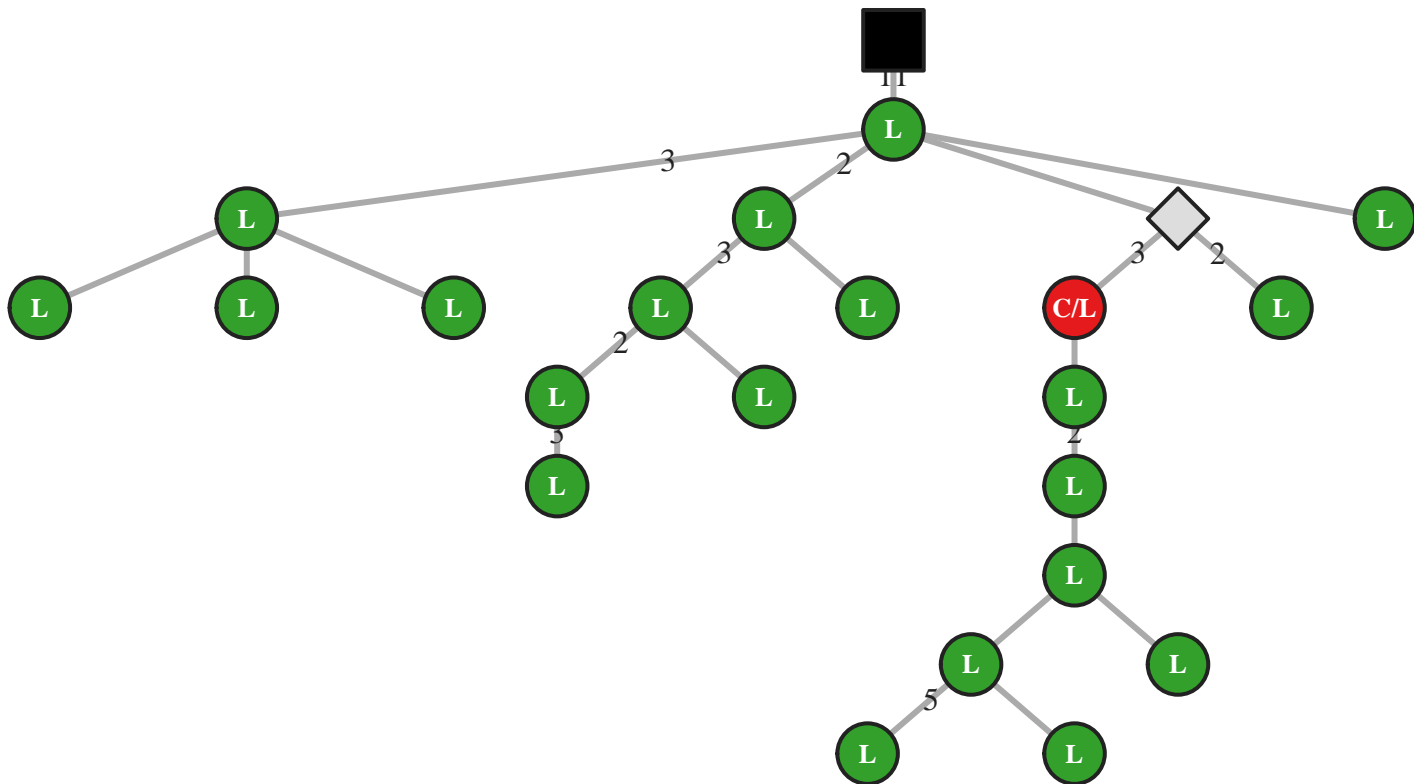

M5 IgG IGHV1-69/J5 51bp (50332)

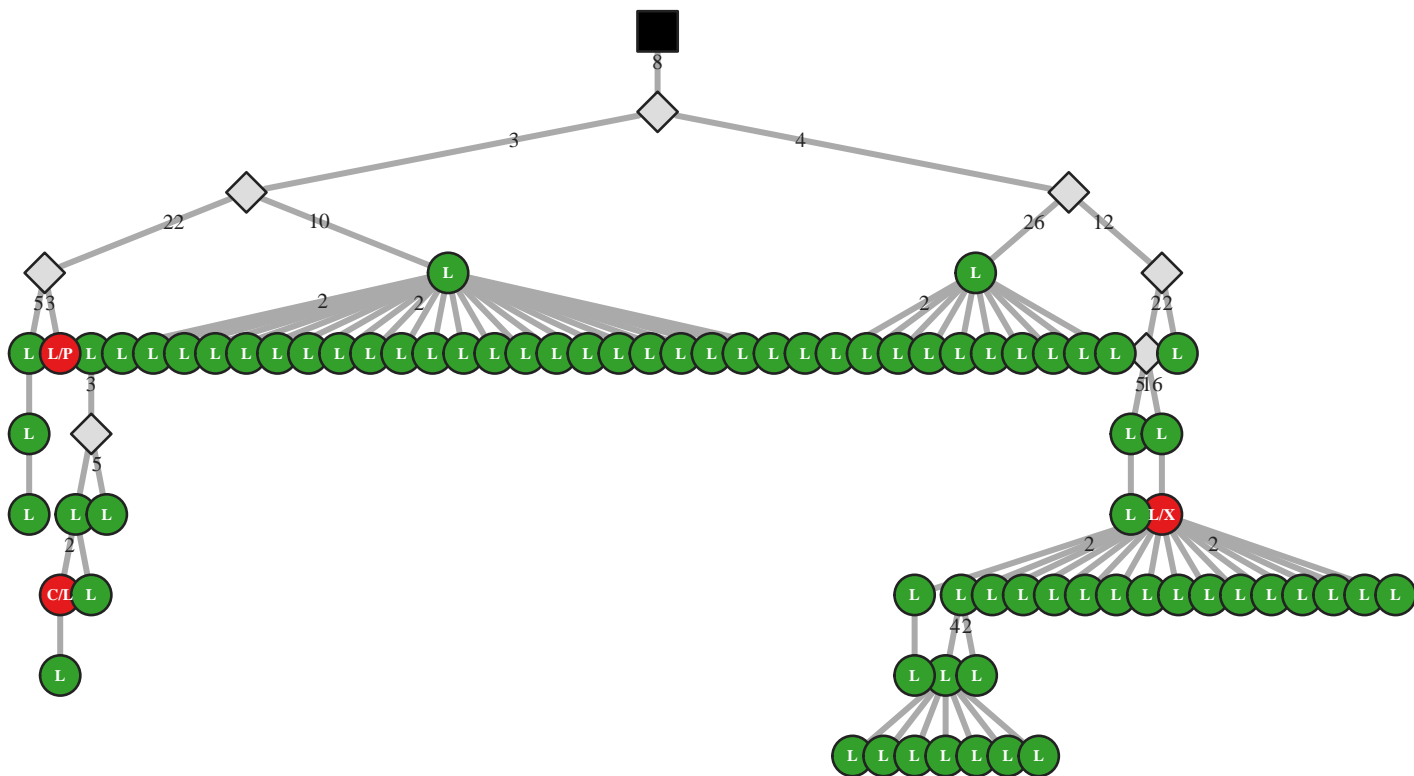

M5 IgG IGHV1-69/J5 54bp (41943)

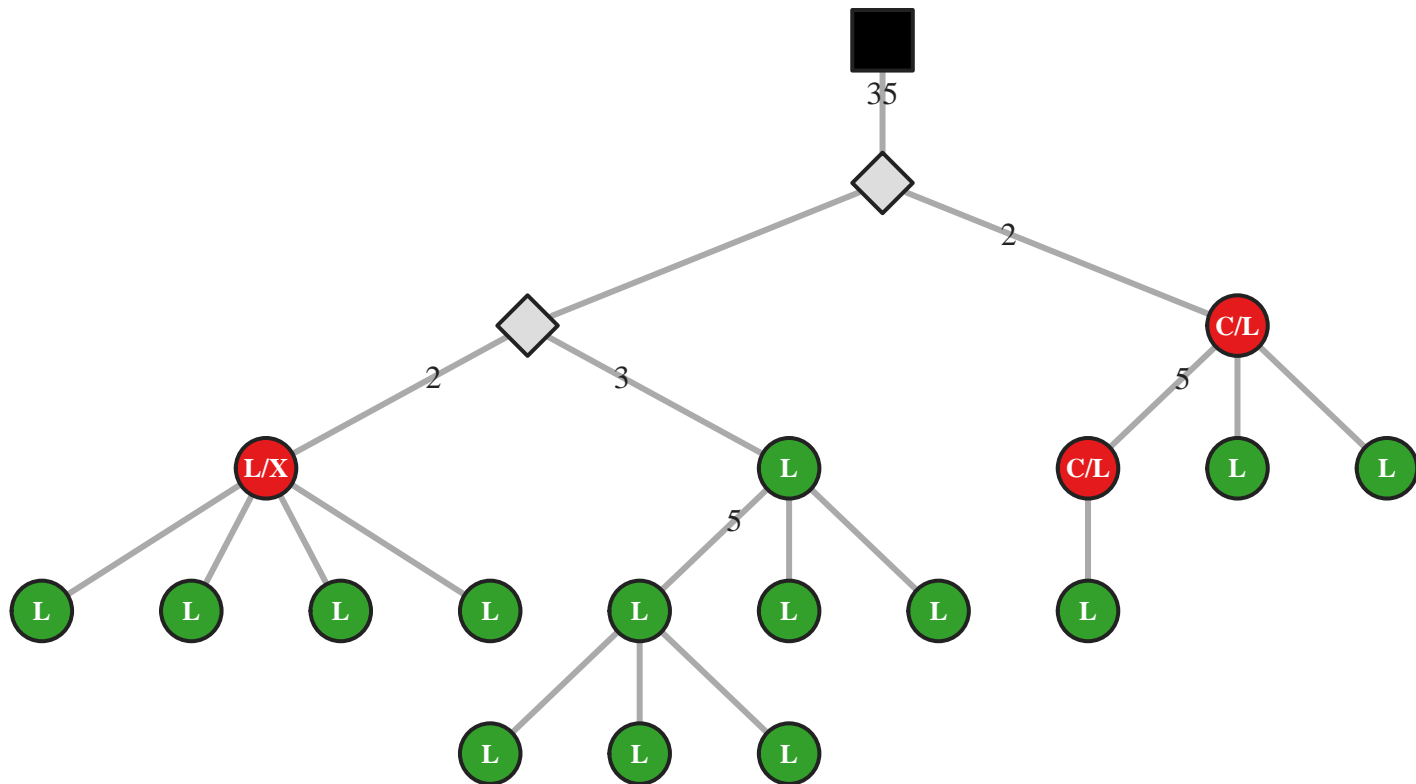

M5 IgG IGHV1-69/J5 54bp (41948)

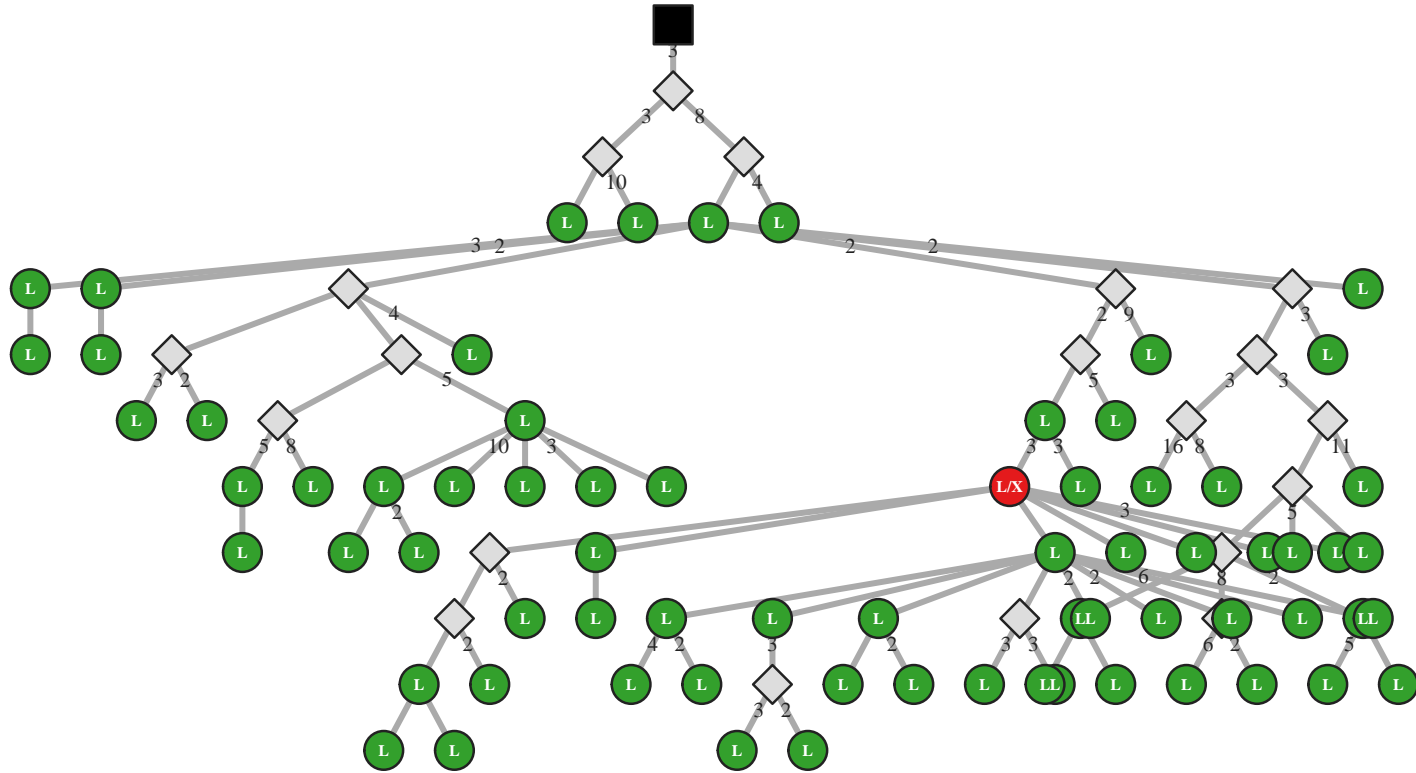

M5 IgG IGHV1-69/J5 54bp (41983)

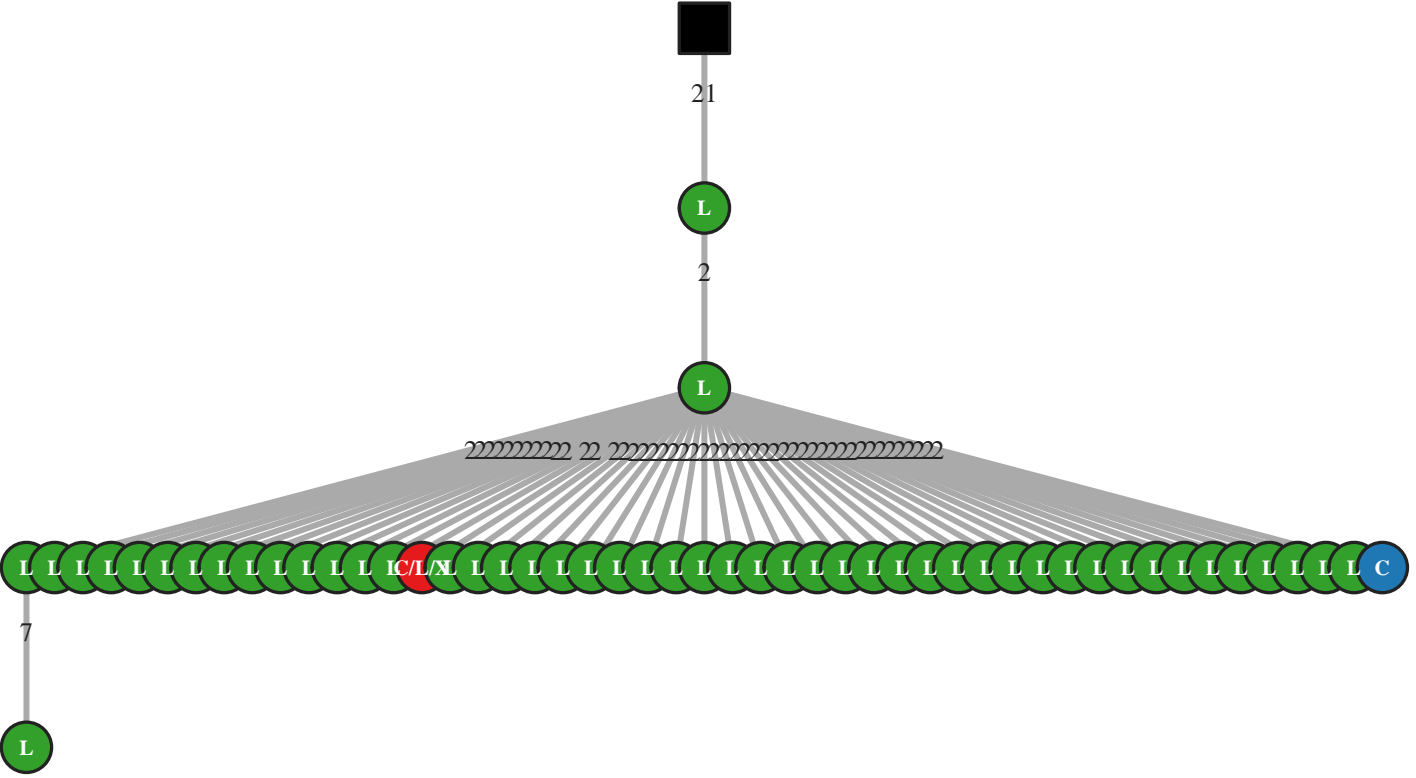

M5 IgG IGHV1-69/J5 54bp (41994)

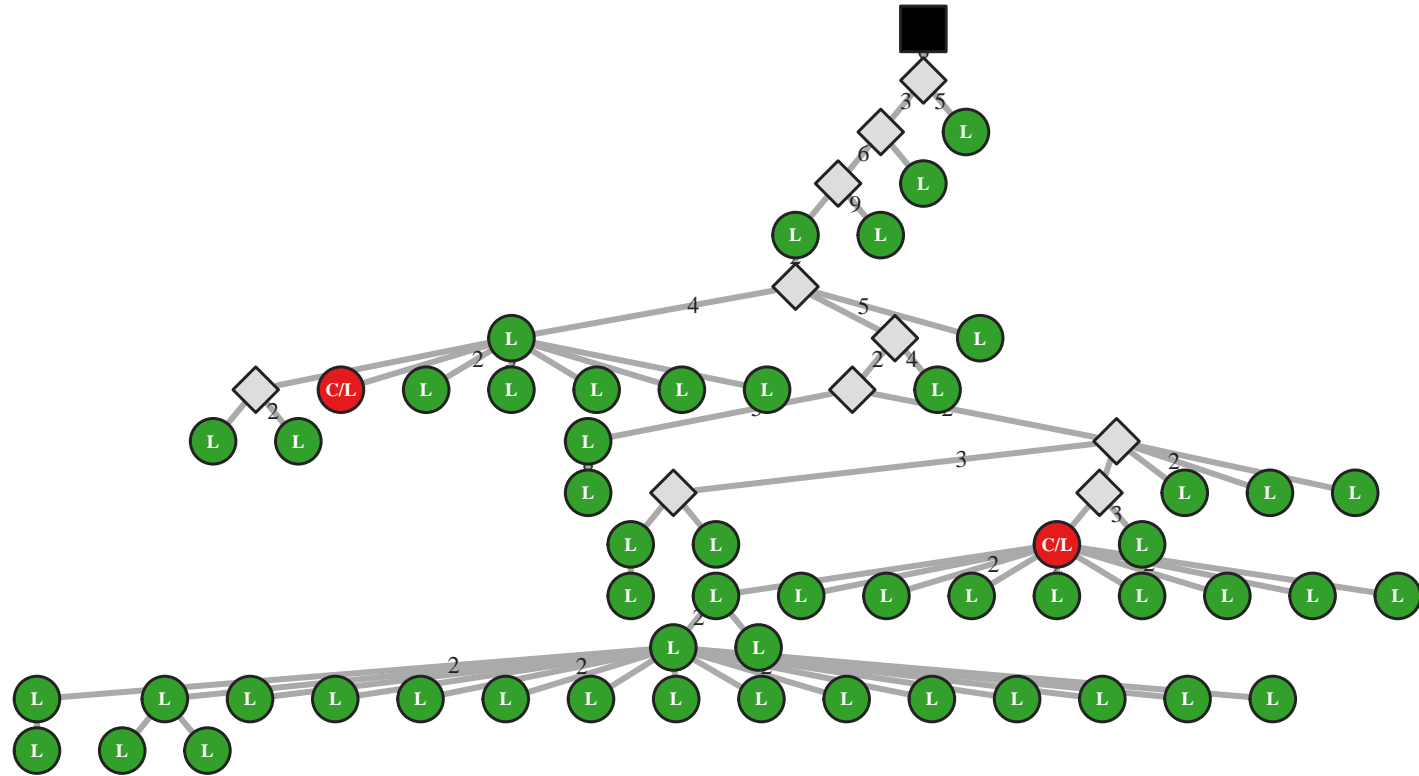

M5 IgG IGHV1-69/J5 57bp (23933)

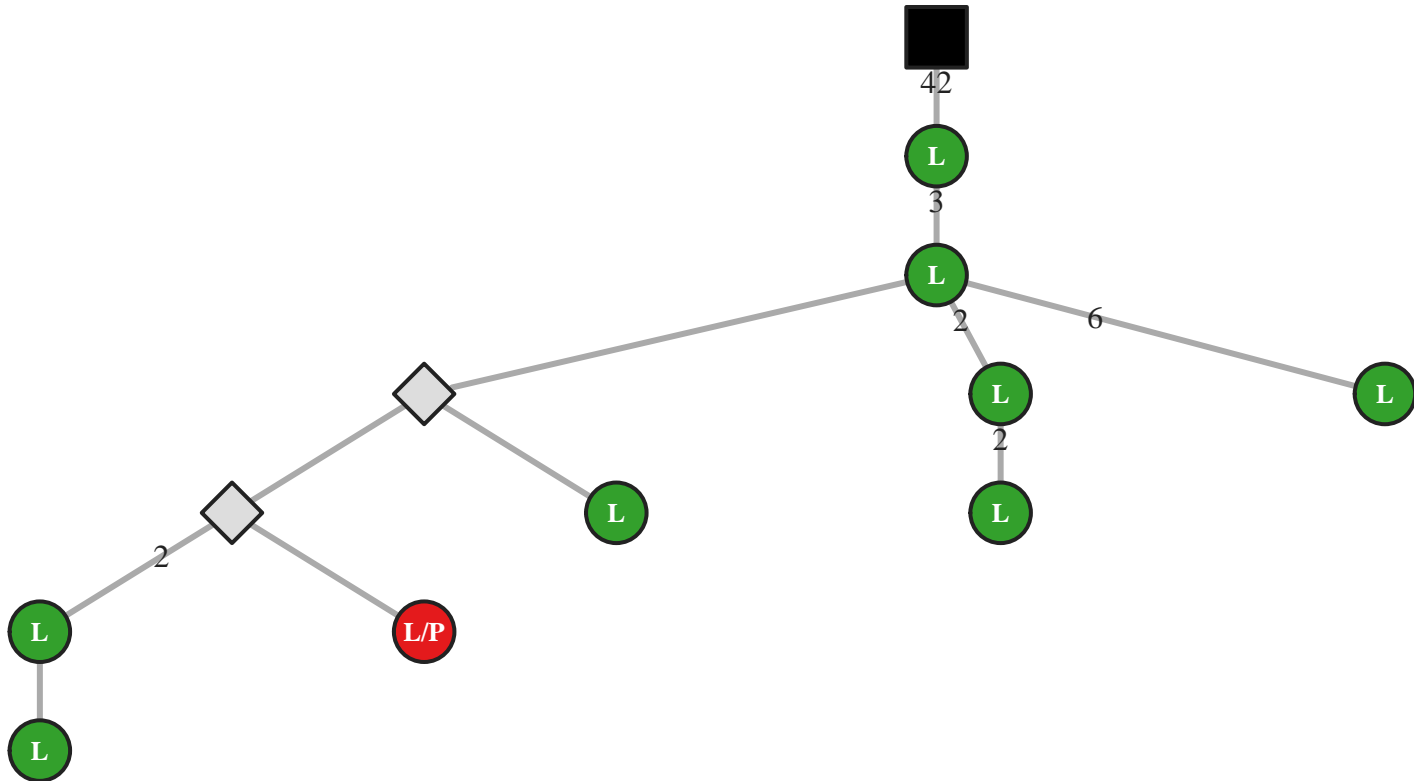

M5 IgG IGHV1-69/J5 57bp (23935)

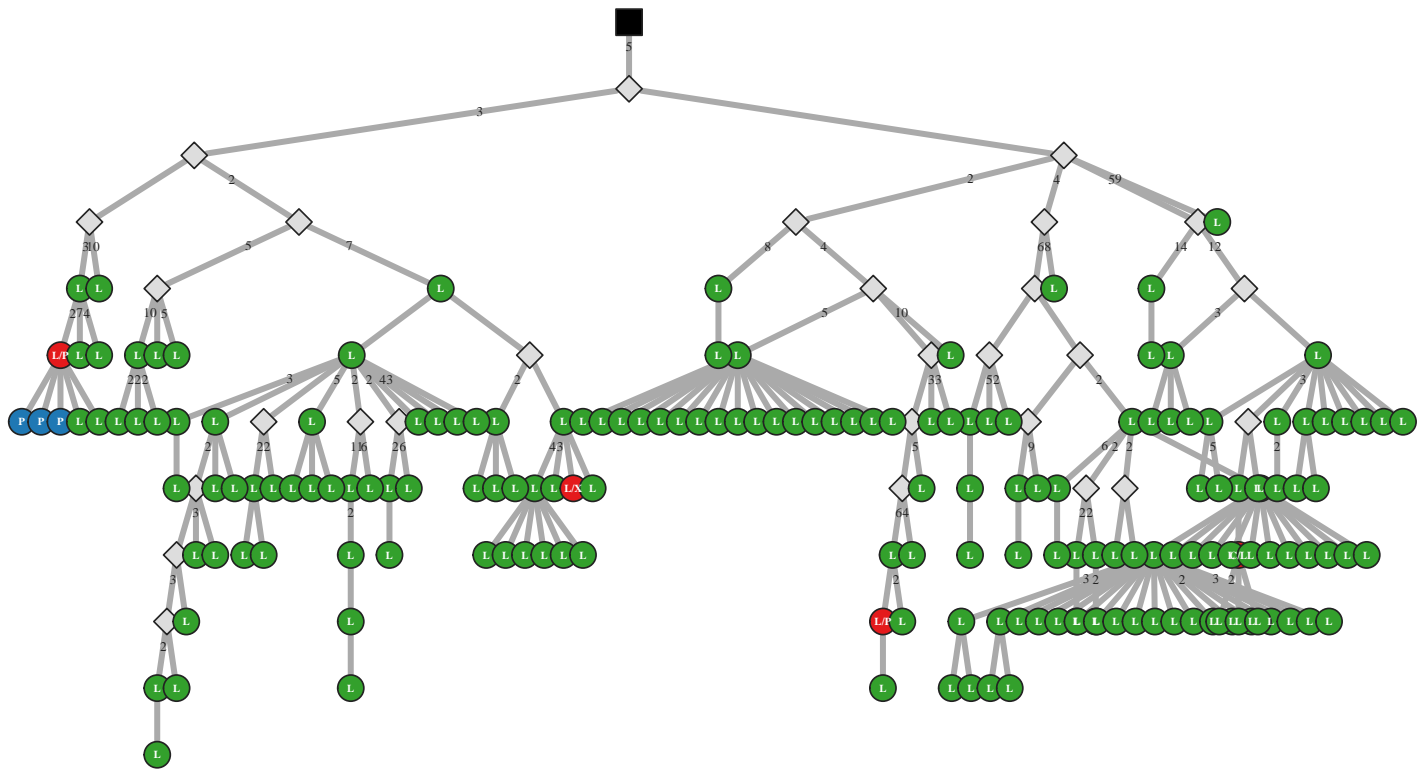

M5 IgG IGHV1-69/J5 60bp (32680)

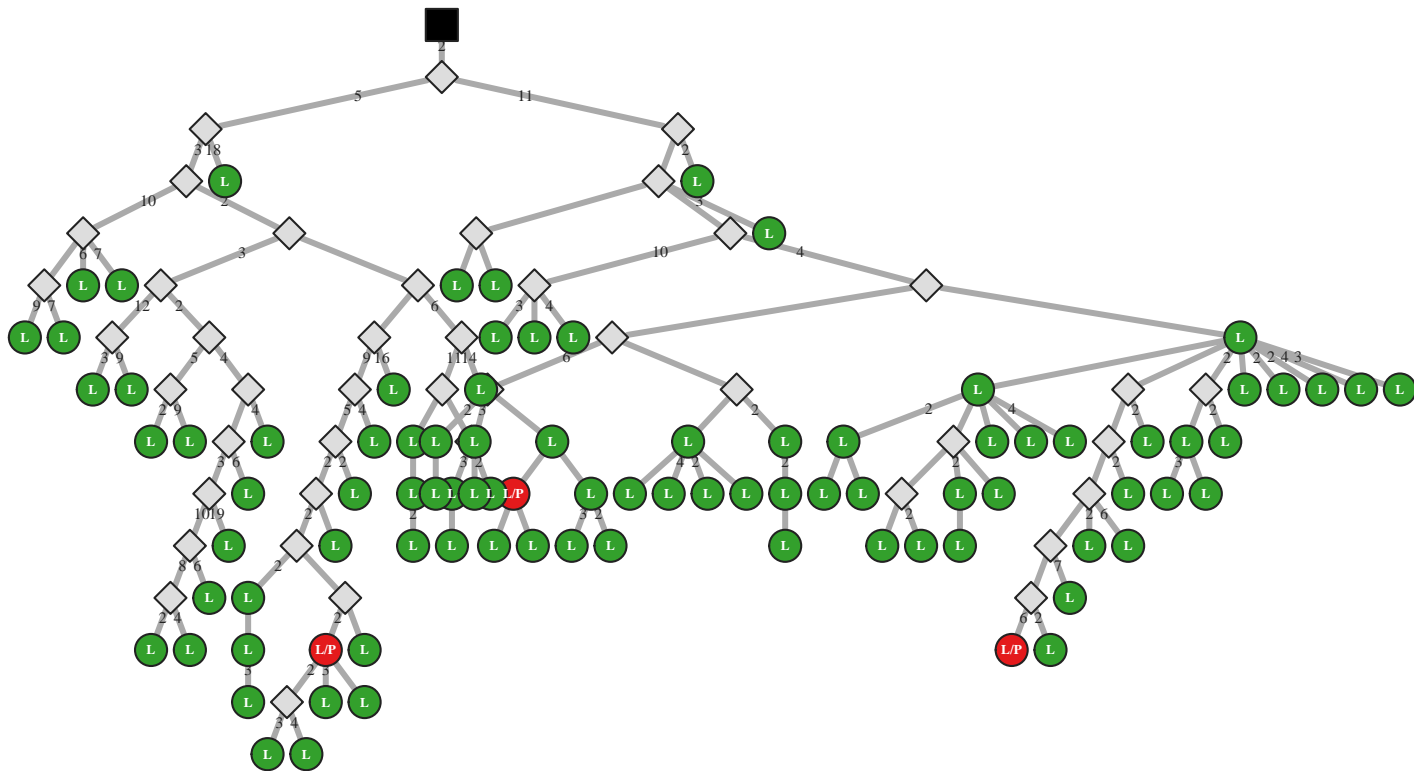

M5 IgG IGHV1-69/J5 60bp (32684)

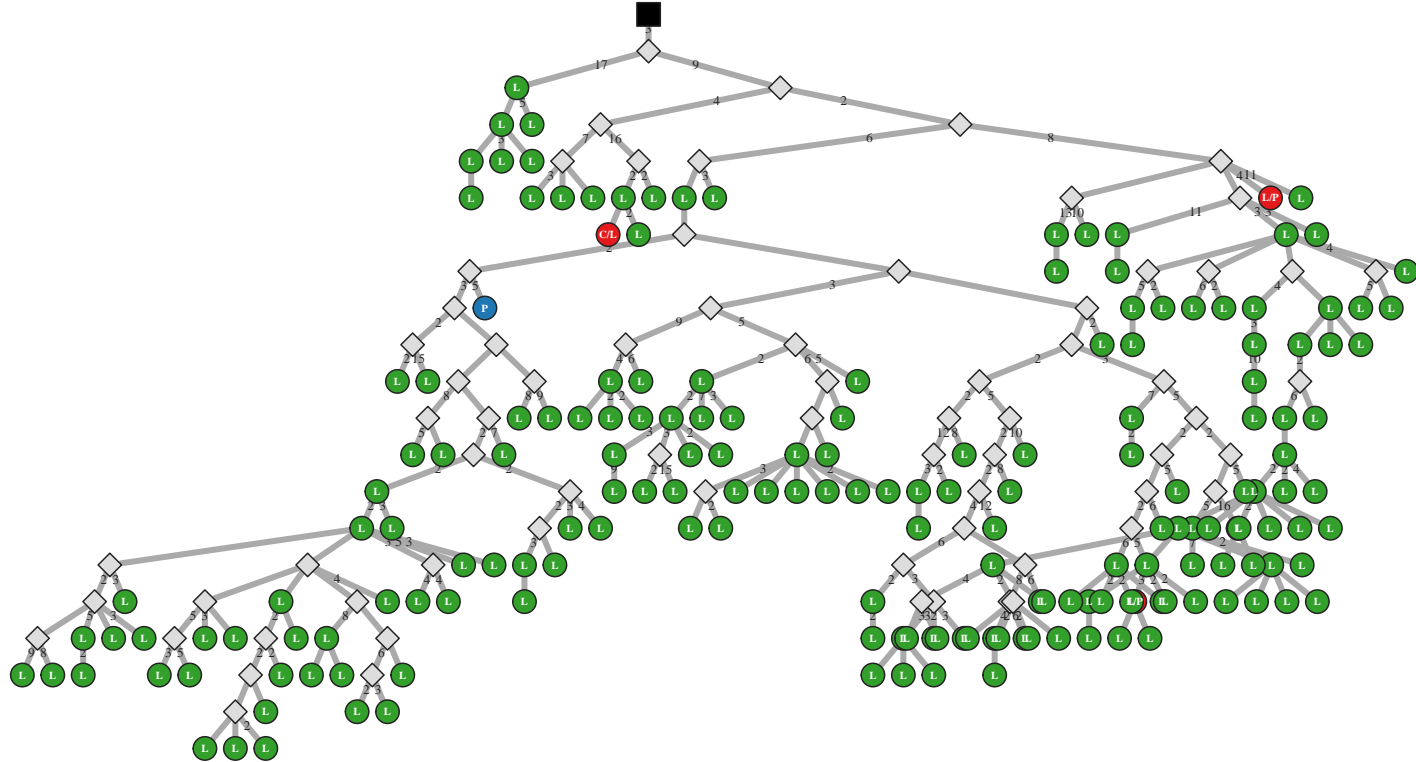

M5 IgG IGHV1-69/J5 60bp (32689)

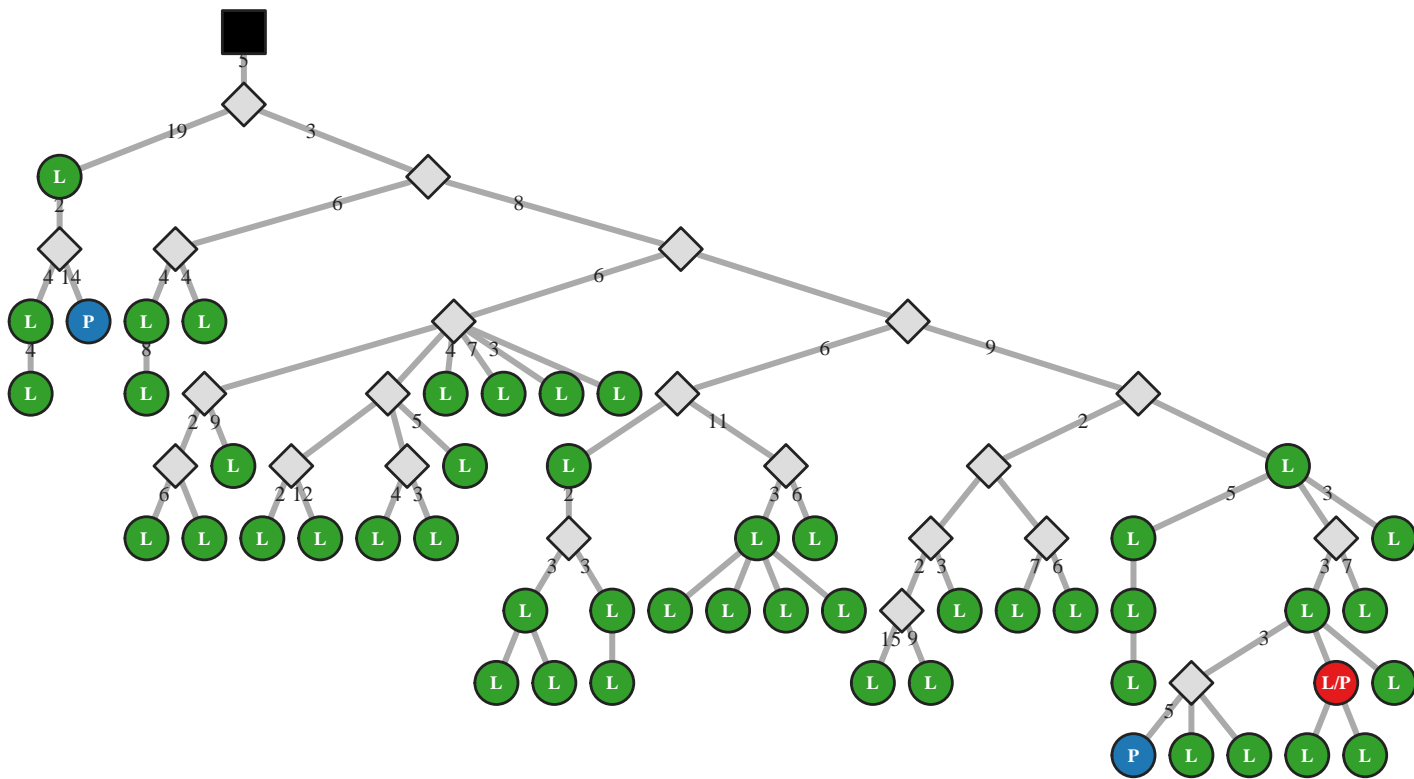

M5 IgA IGHV1-69/J5 63bp (38436)

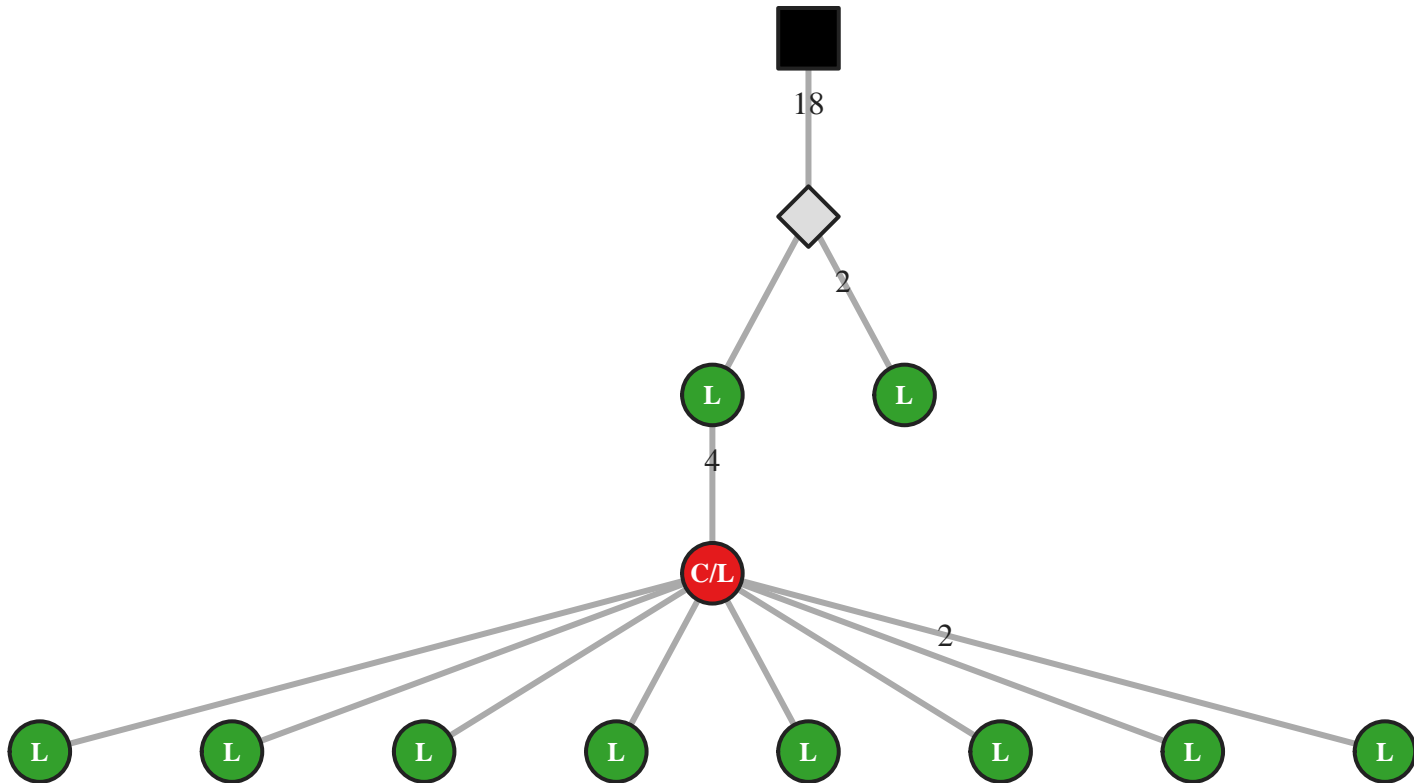

M5 IgG IGHV1-69/J5 63bp (32728)

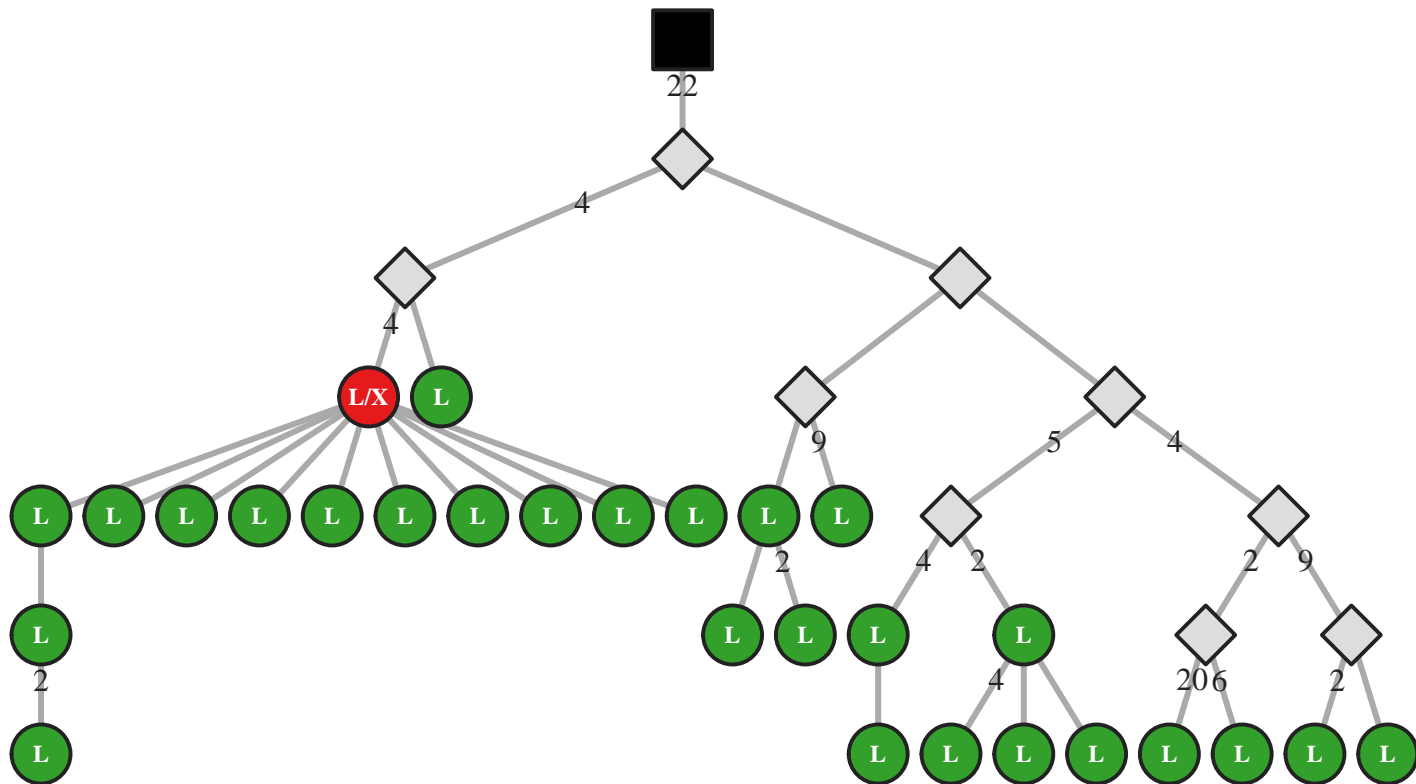

M5 IgG IGHV1-69/J5 66bp (42011)

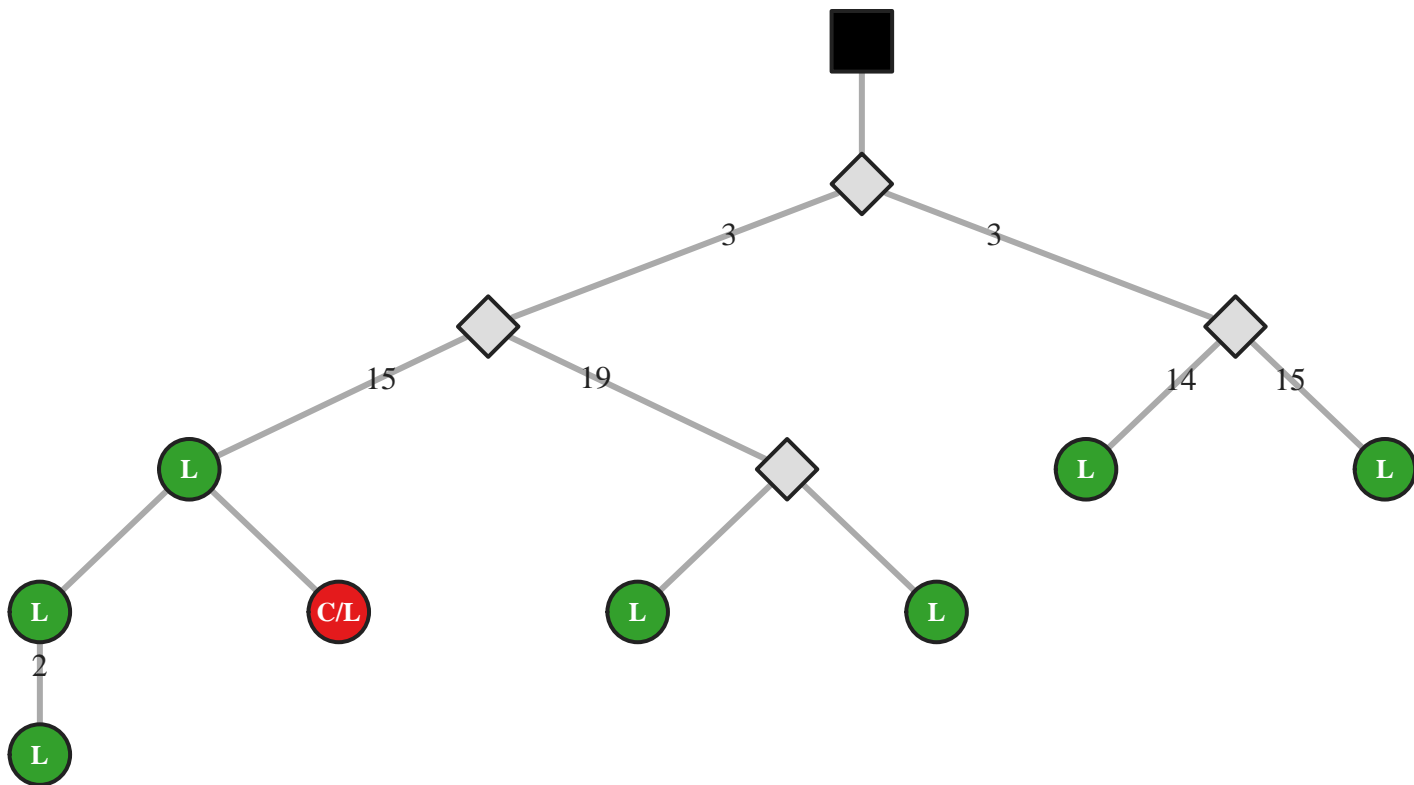

M5 IgG IGHV1-69/J5 72bp (23969)

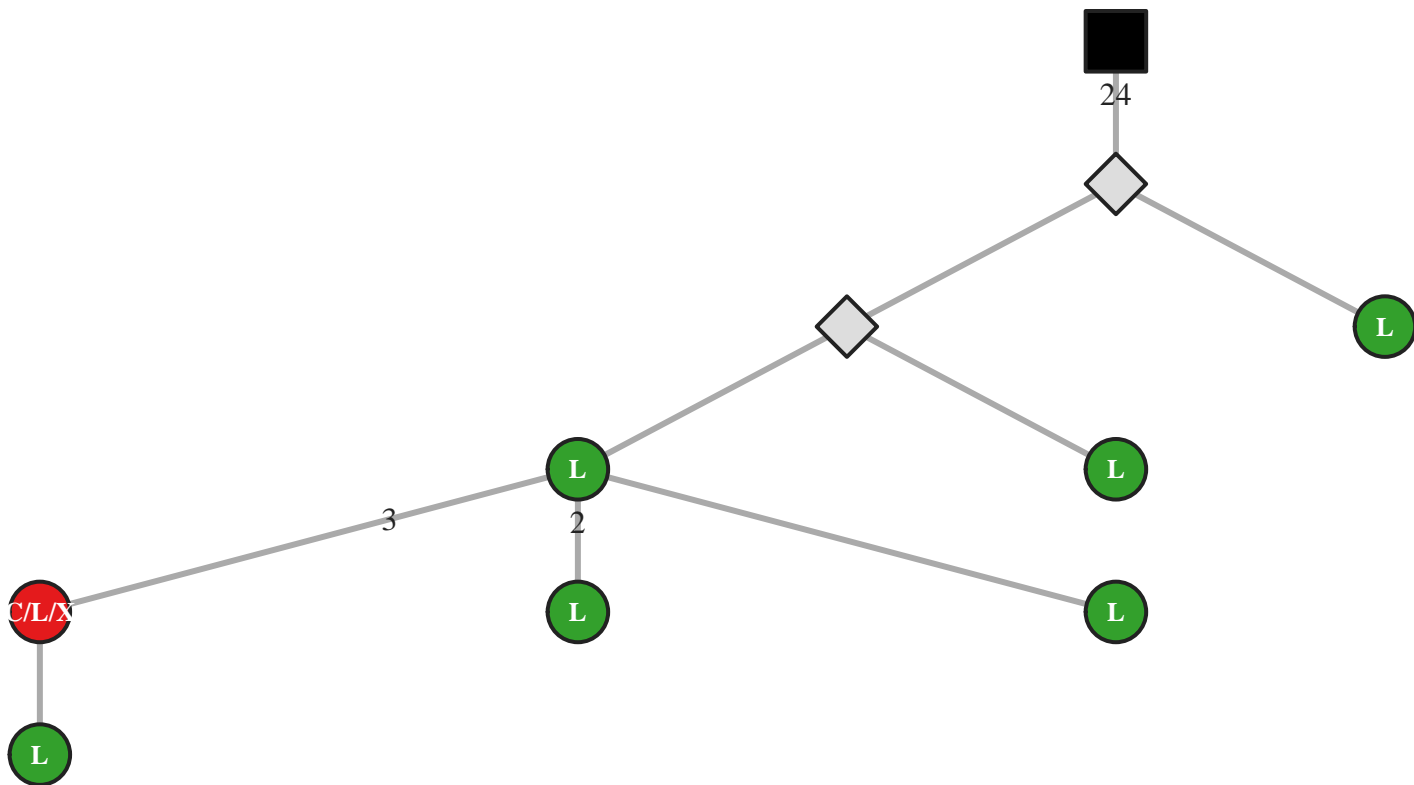

M5 IgG IGHV1-69/J6 33bp (32748)

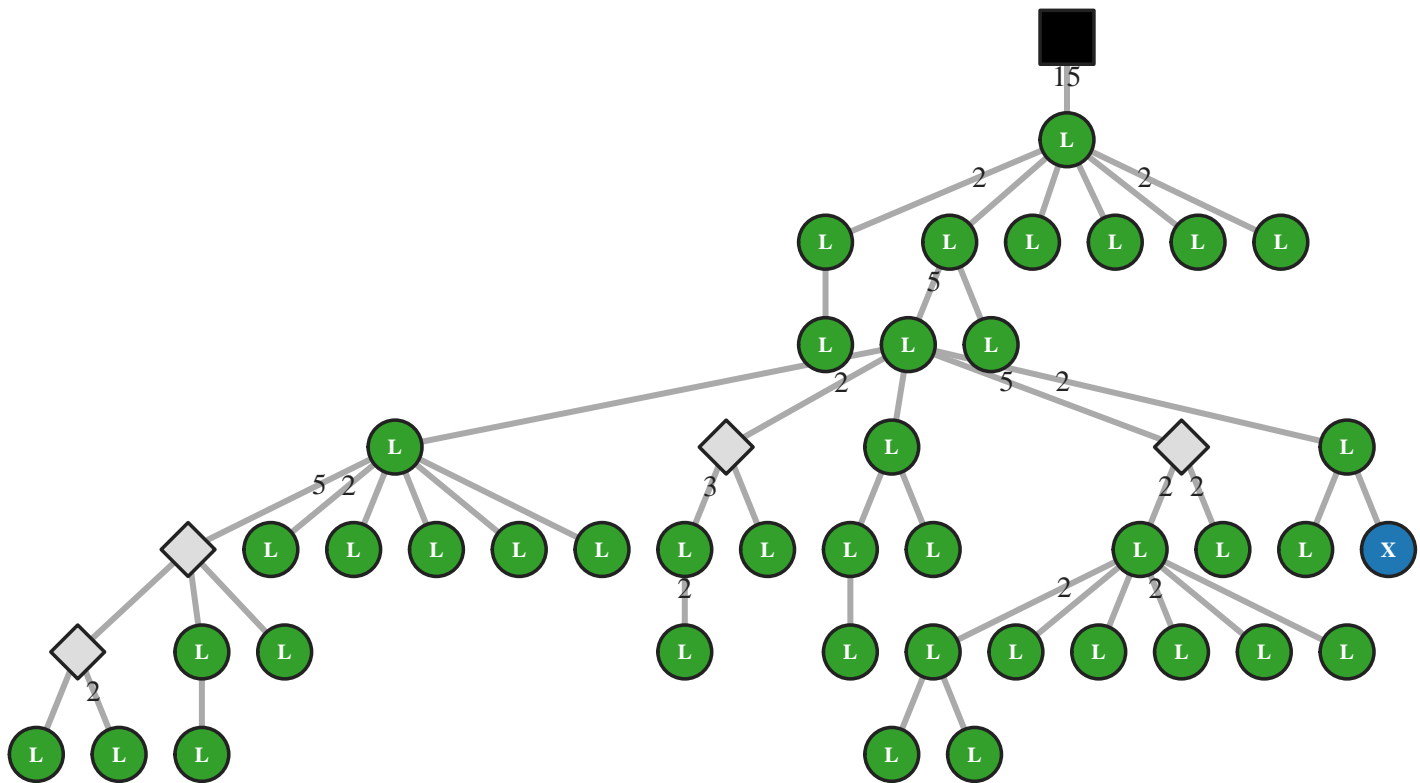

M5 IgG IGHV1-69/J6 36bp (5369)

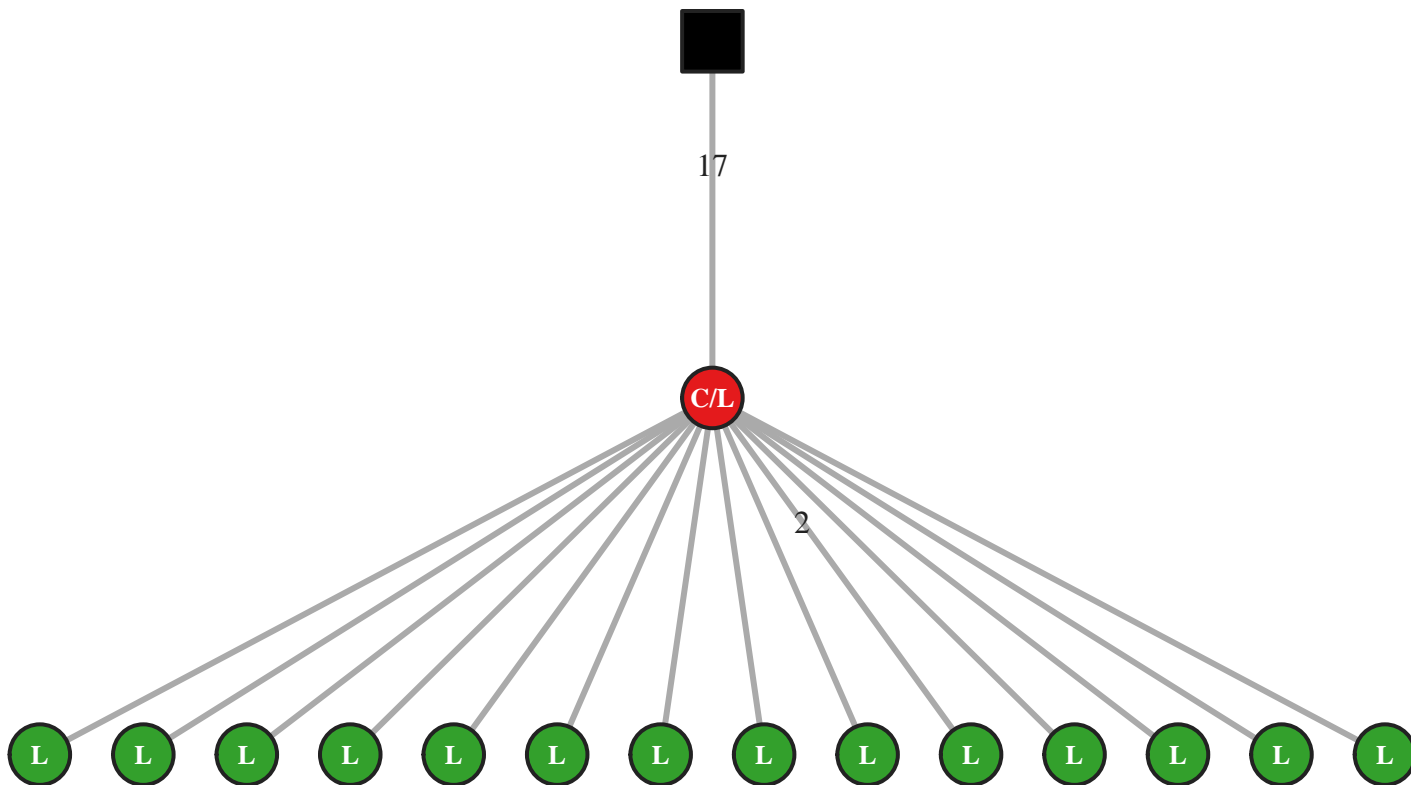

M5 IgG IGHV1-69/J6 36bp (5370)

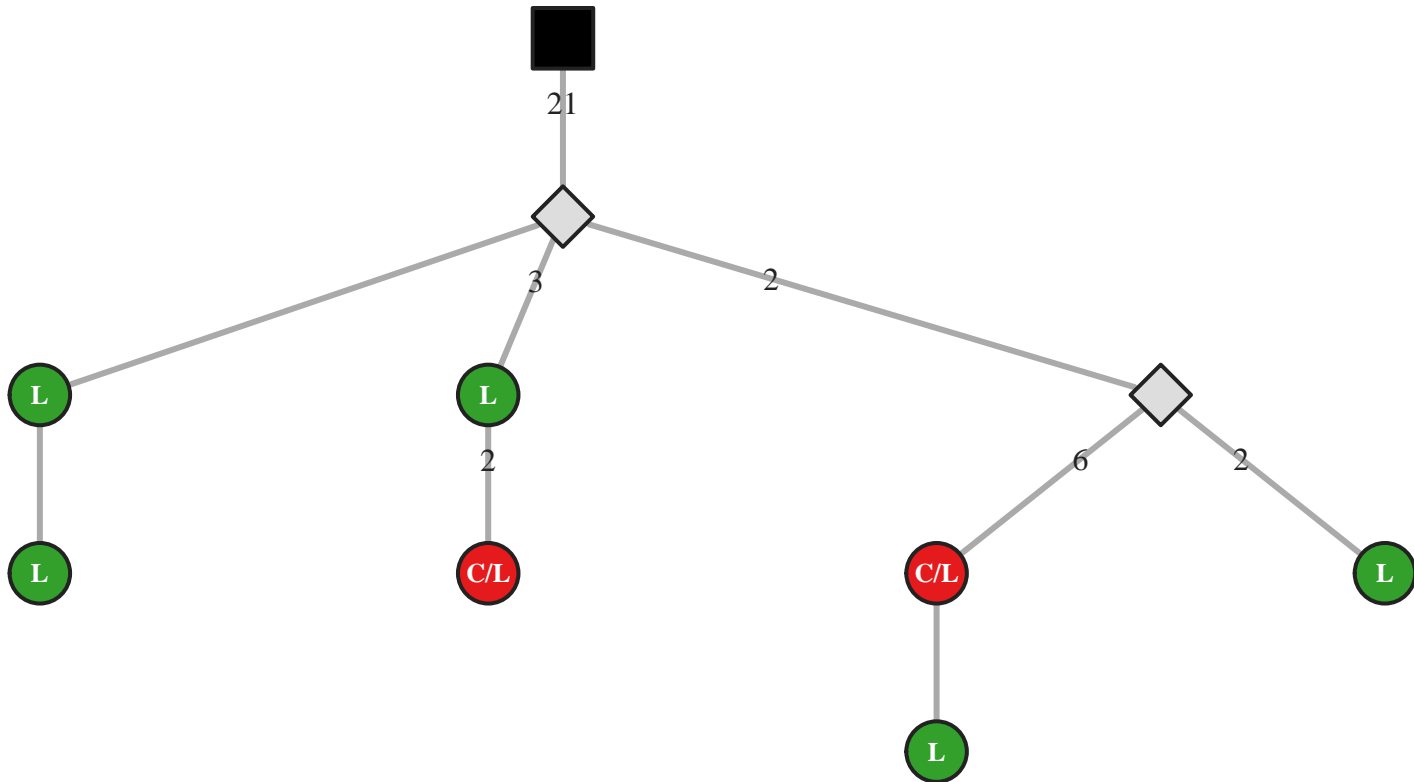

M5 IgG IGHV1-69/J6 39bp (14848)

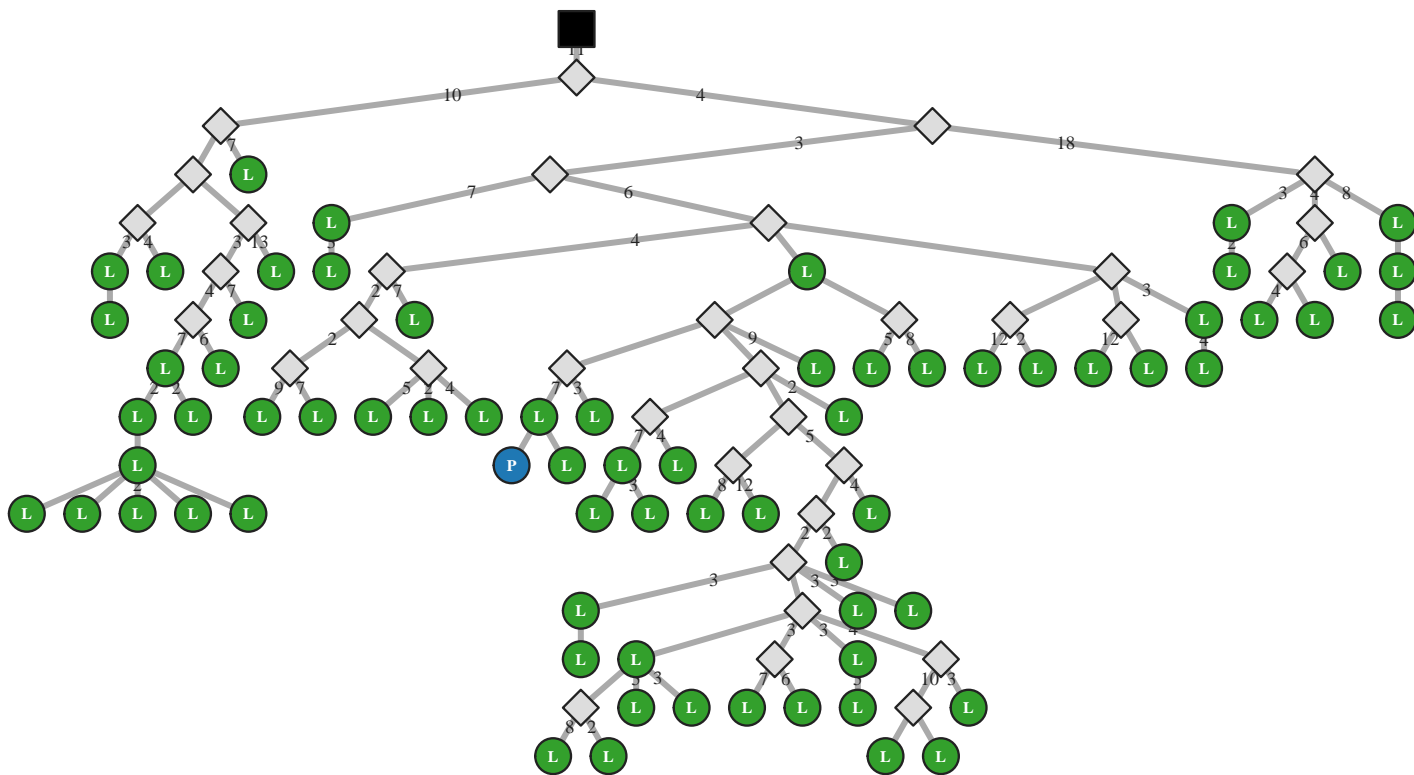

M5 IgG IGHV1-69/J6 39bp (14849)

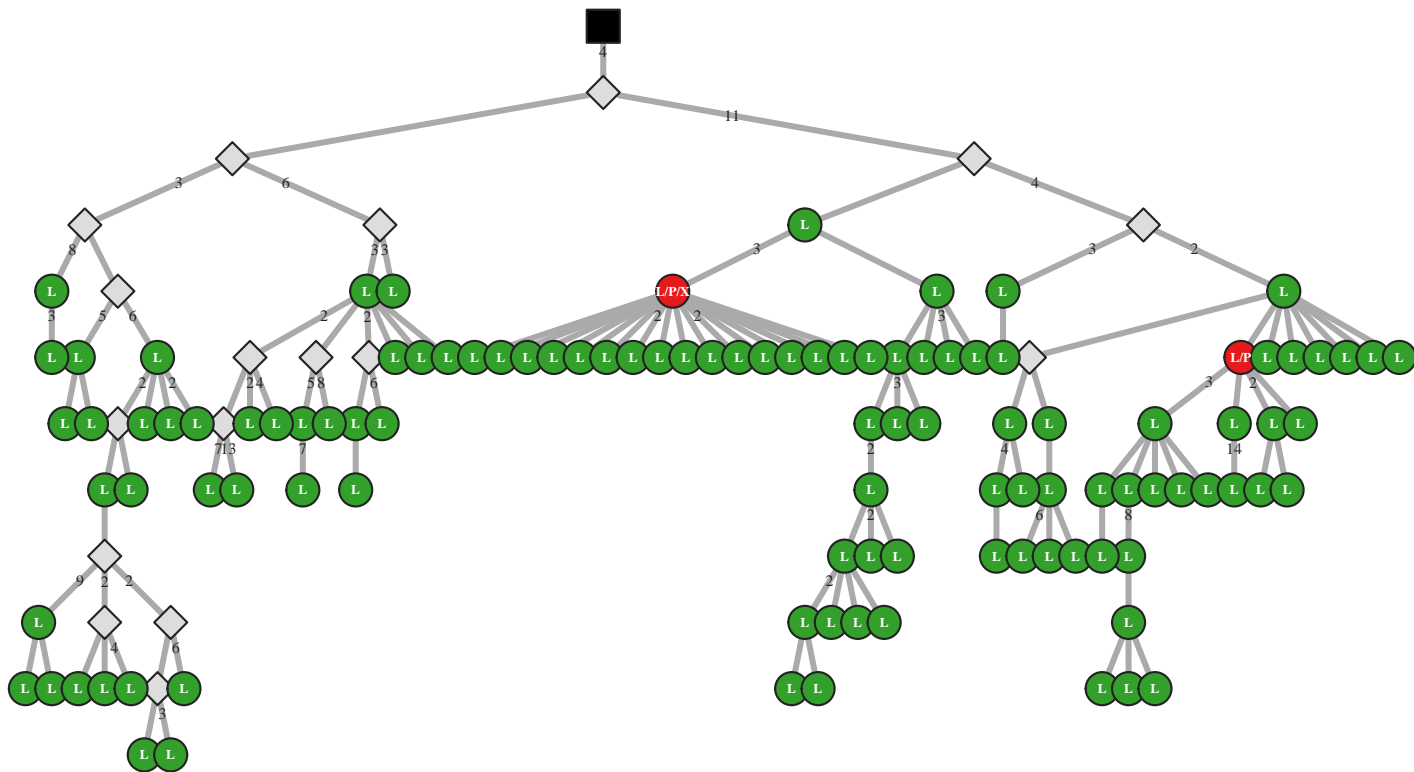

M5 IgG IGHV1-69/J6 39bp (14851)

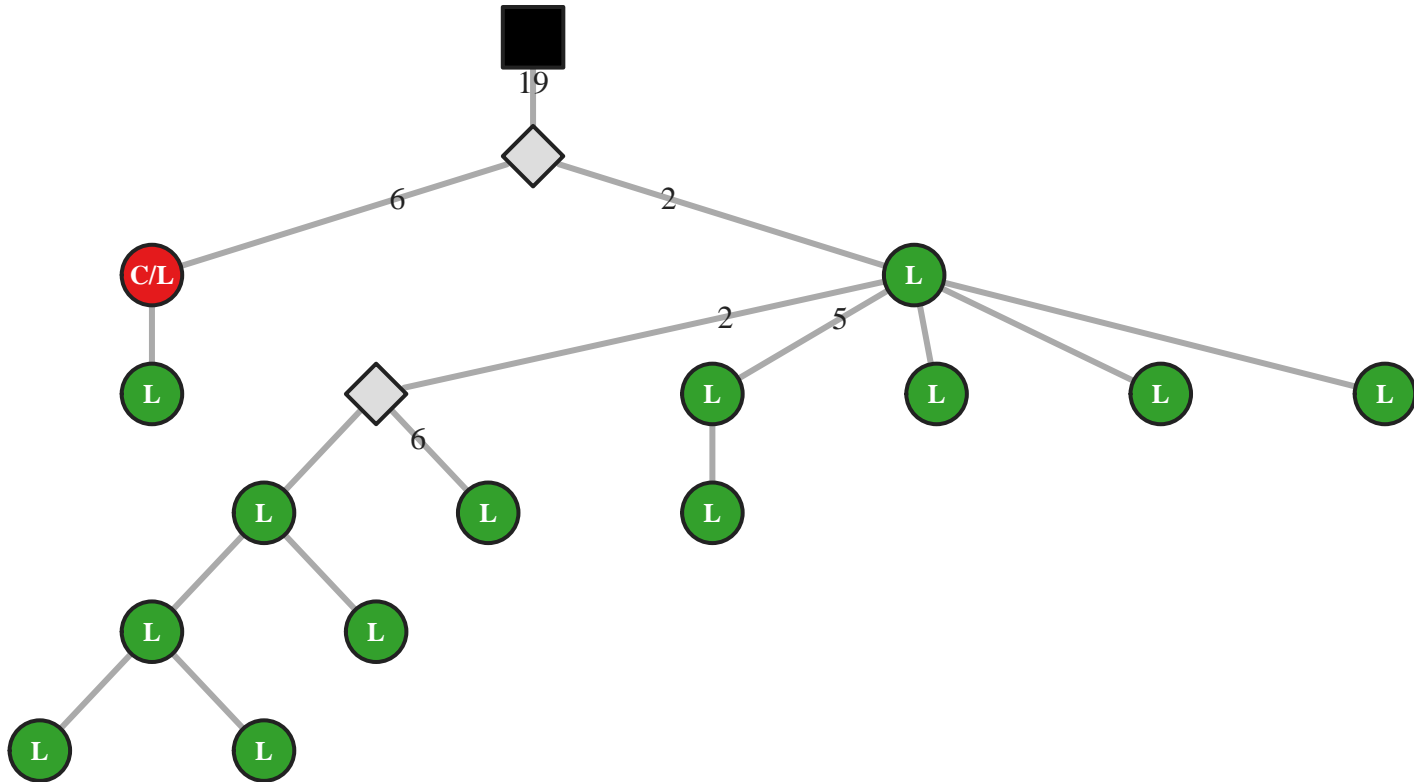

M5 IgG IGHV1-69/J6 39bp (14852)

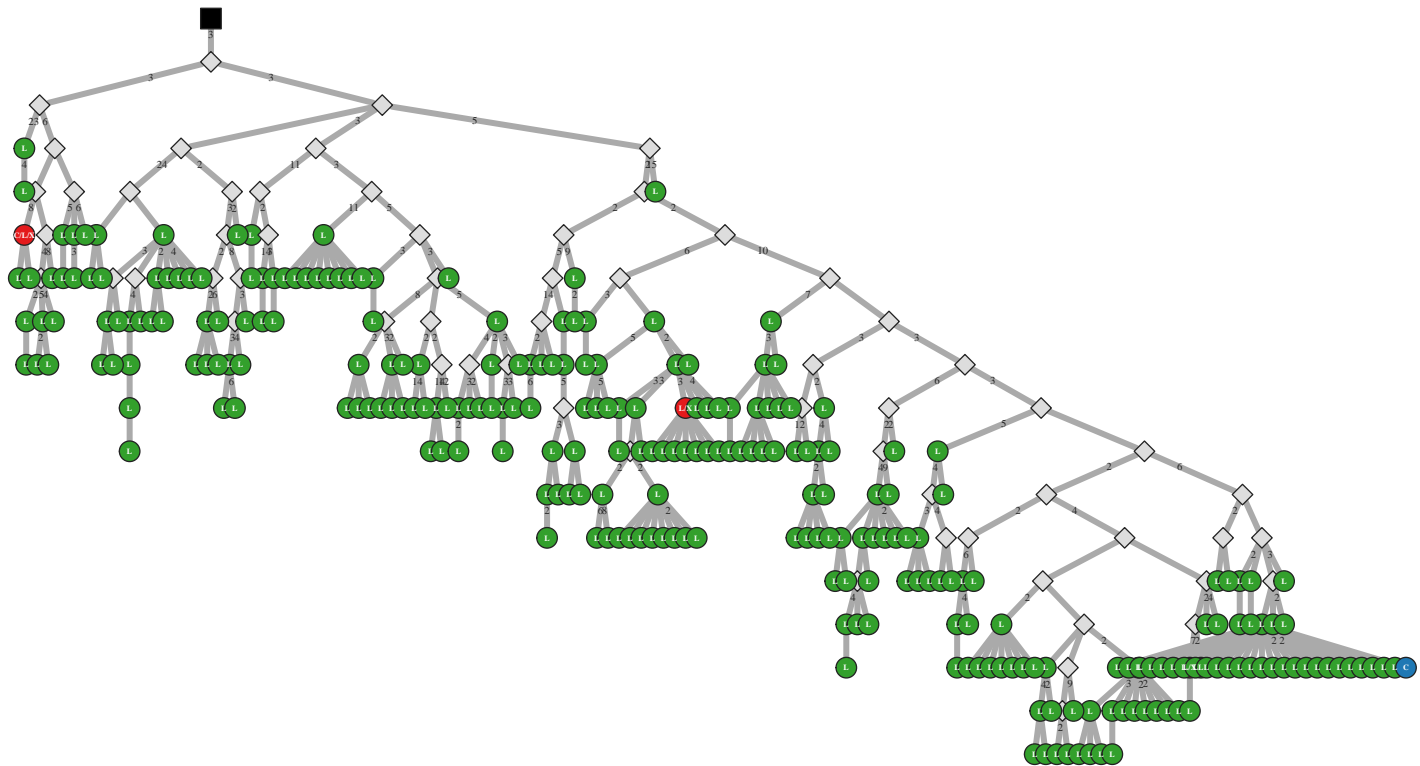

M5 IgG IGHV1-69/J6 42bp (5378)

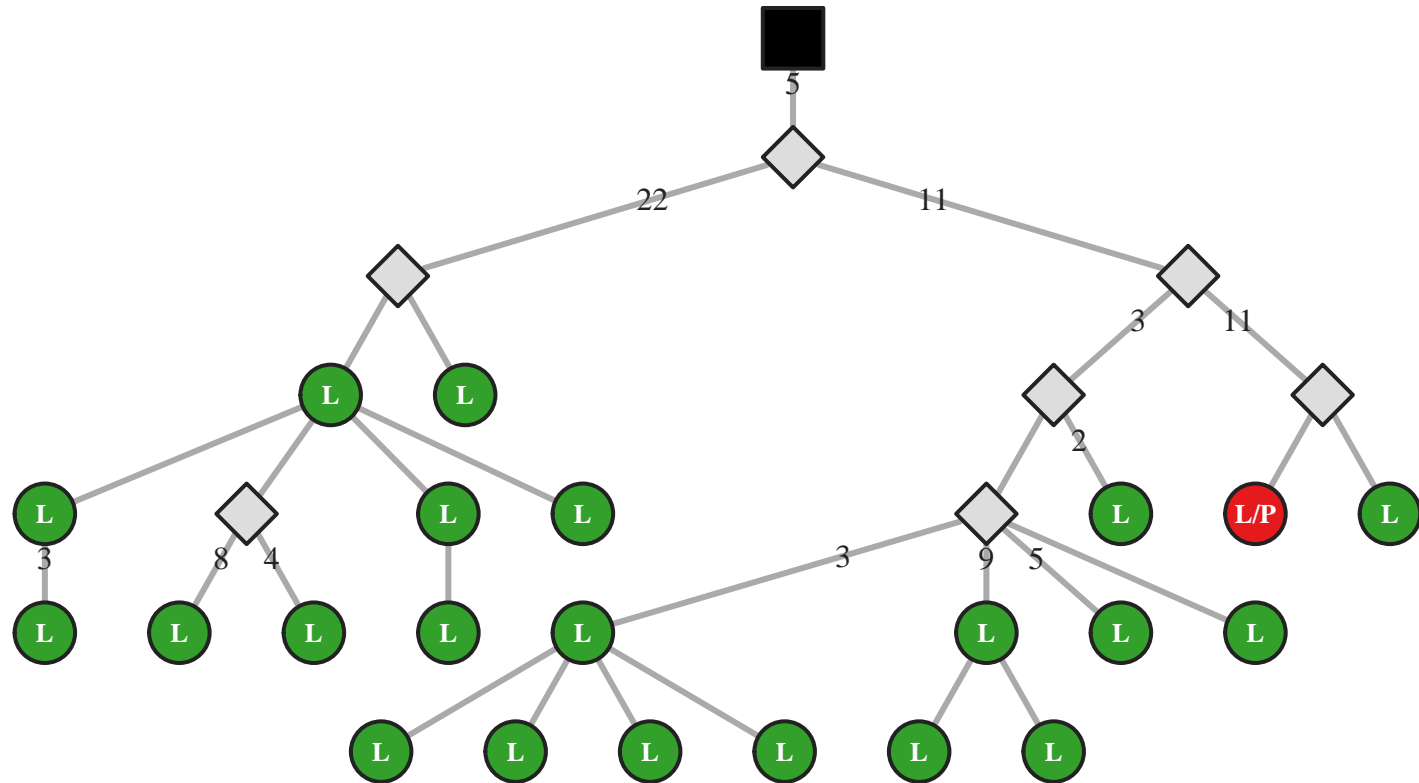

M5 IgG IGHV1-69/J6 42bp (5391)

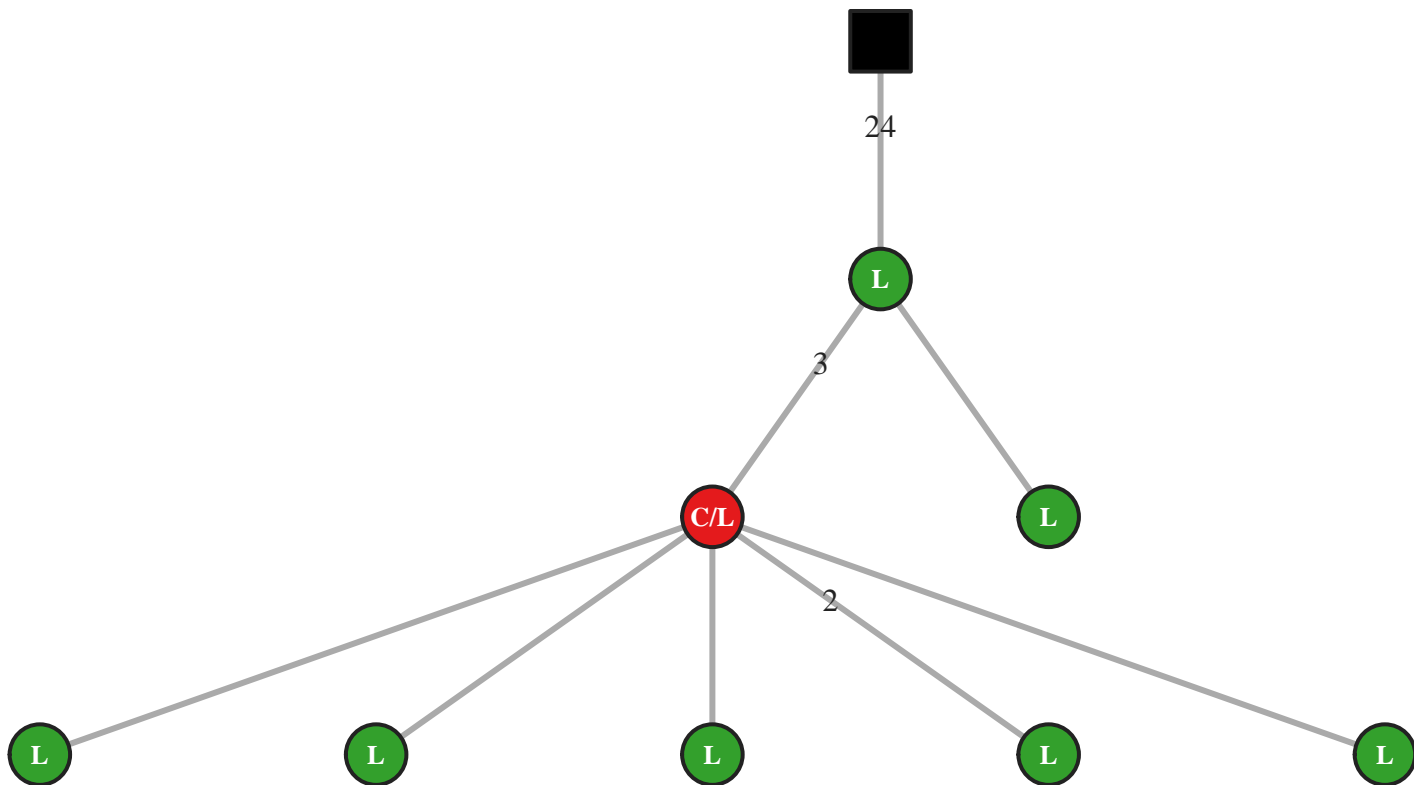

M5 IgG IGHV1-69/J6 45bp (42040)

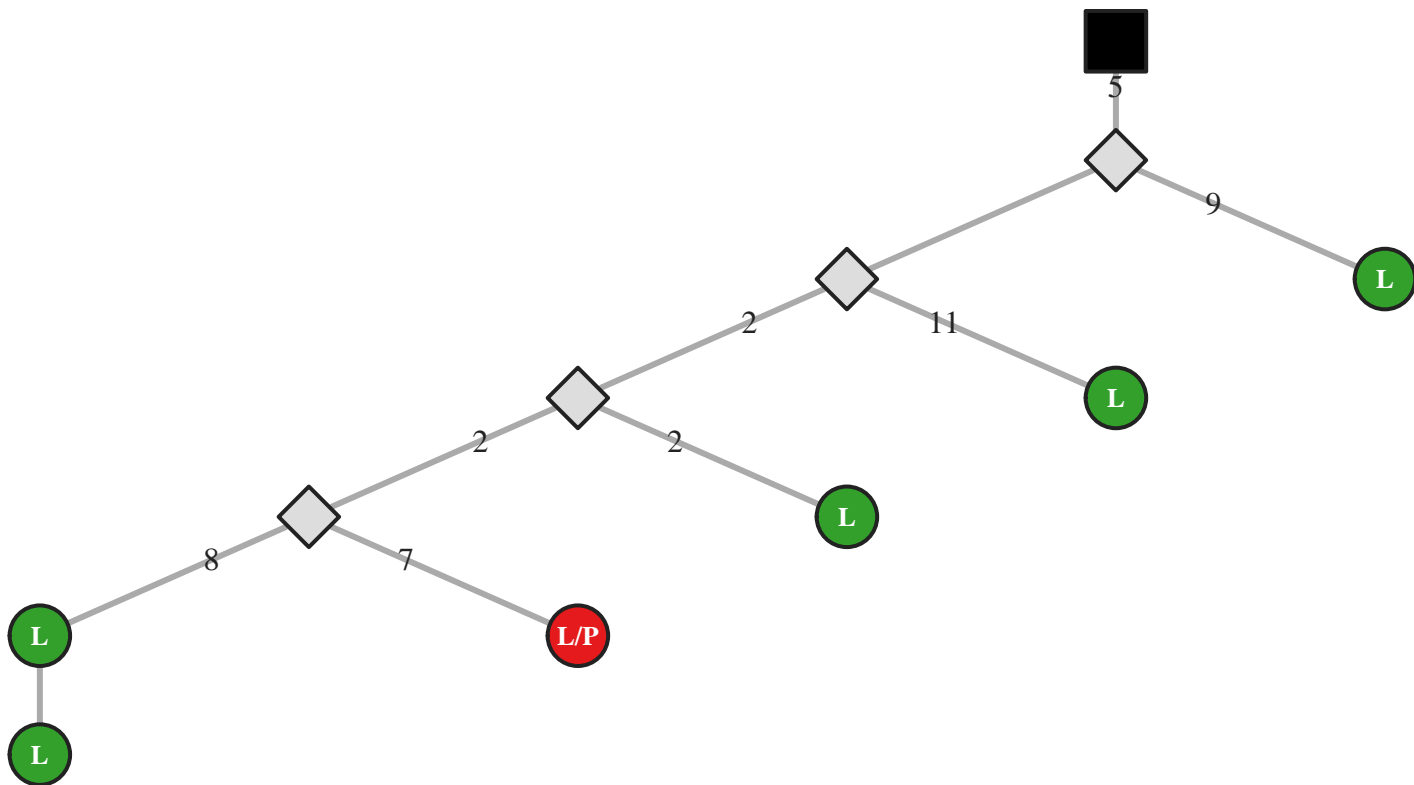

M5 IgG IGHV1-69/J6 45bp (42064)

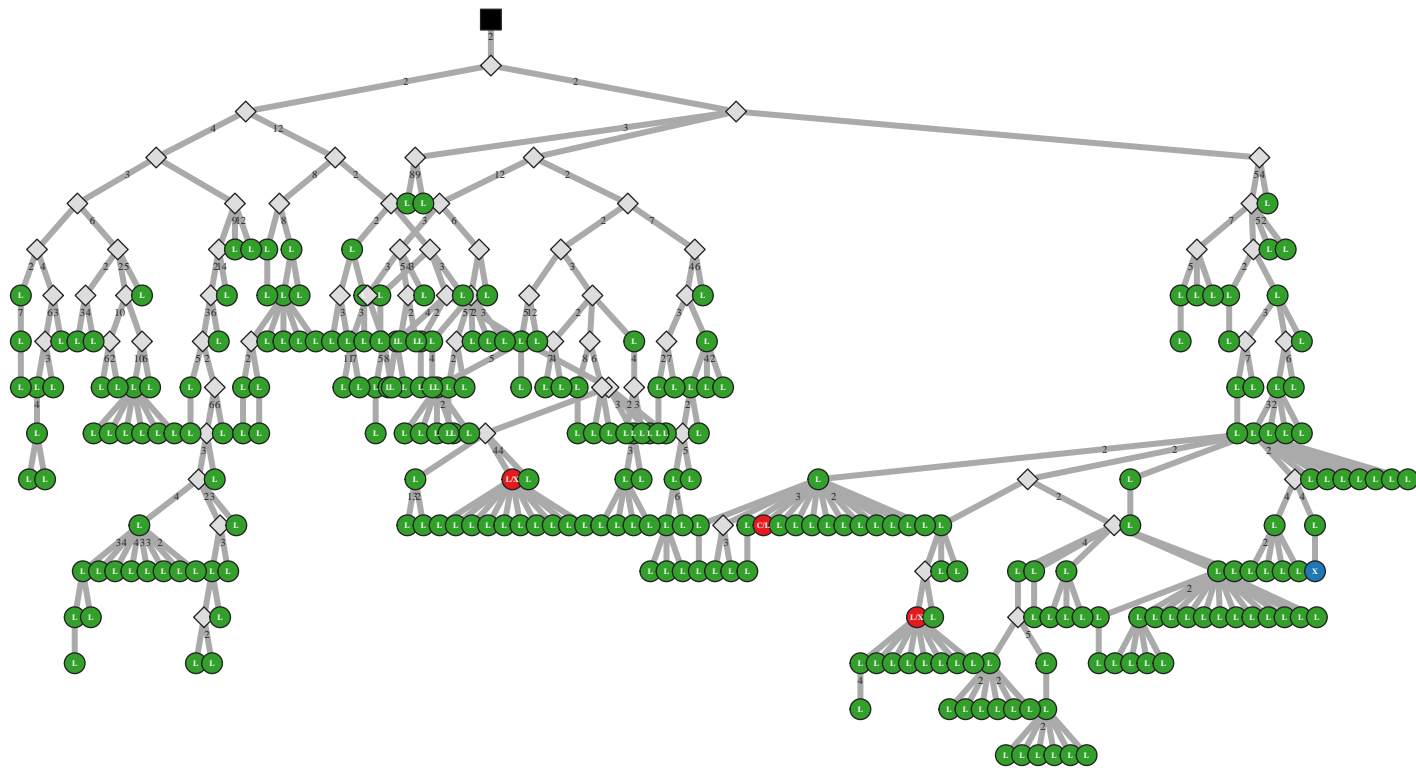

M5 IgG IGHV1-69/J6 45bp (42082)

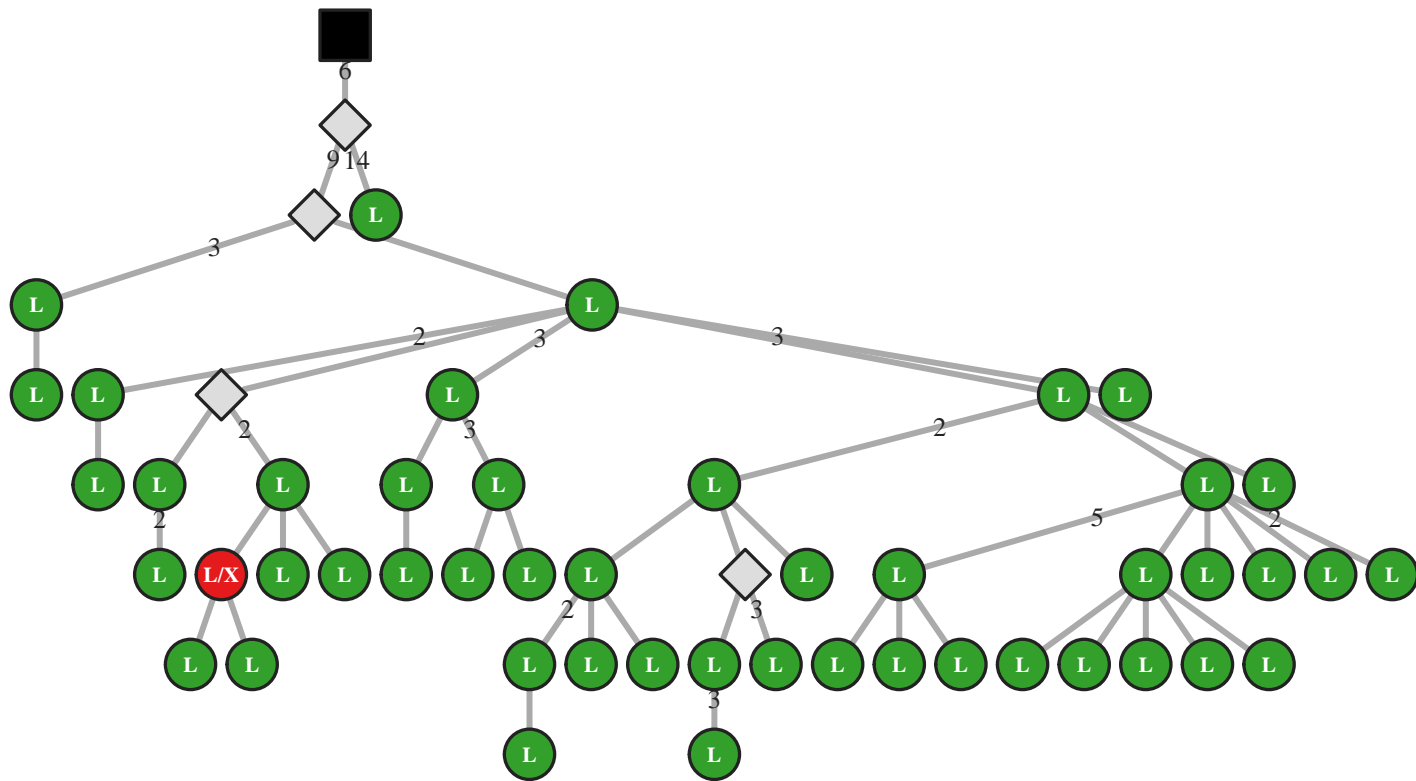

M5 IgG IGHV1-69/J6 45bp (42083)

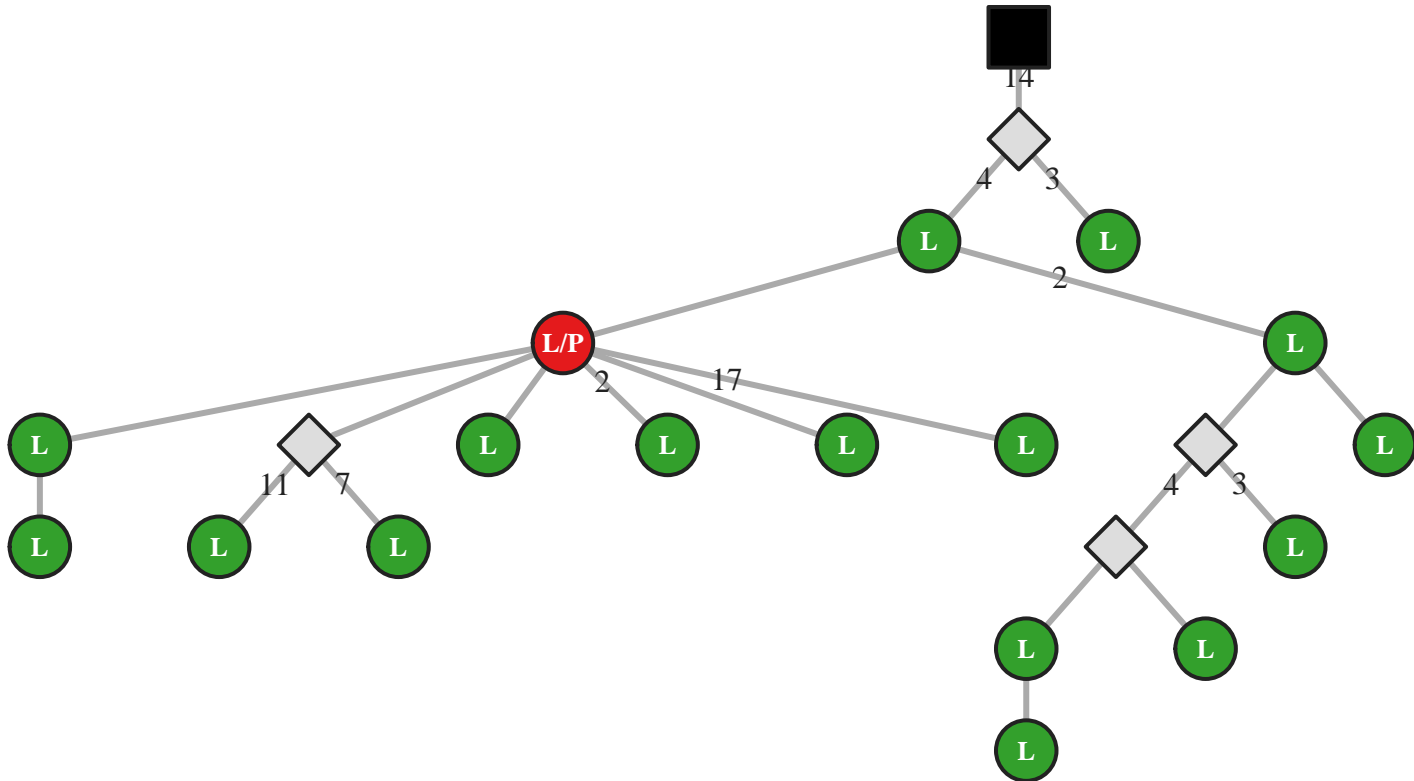

M5 IgG IGHV1-69/J6 48bp (42085)

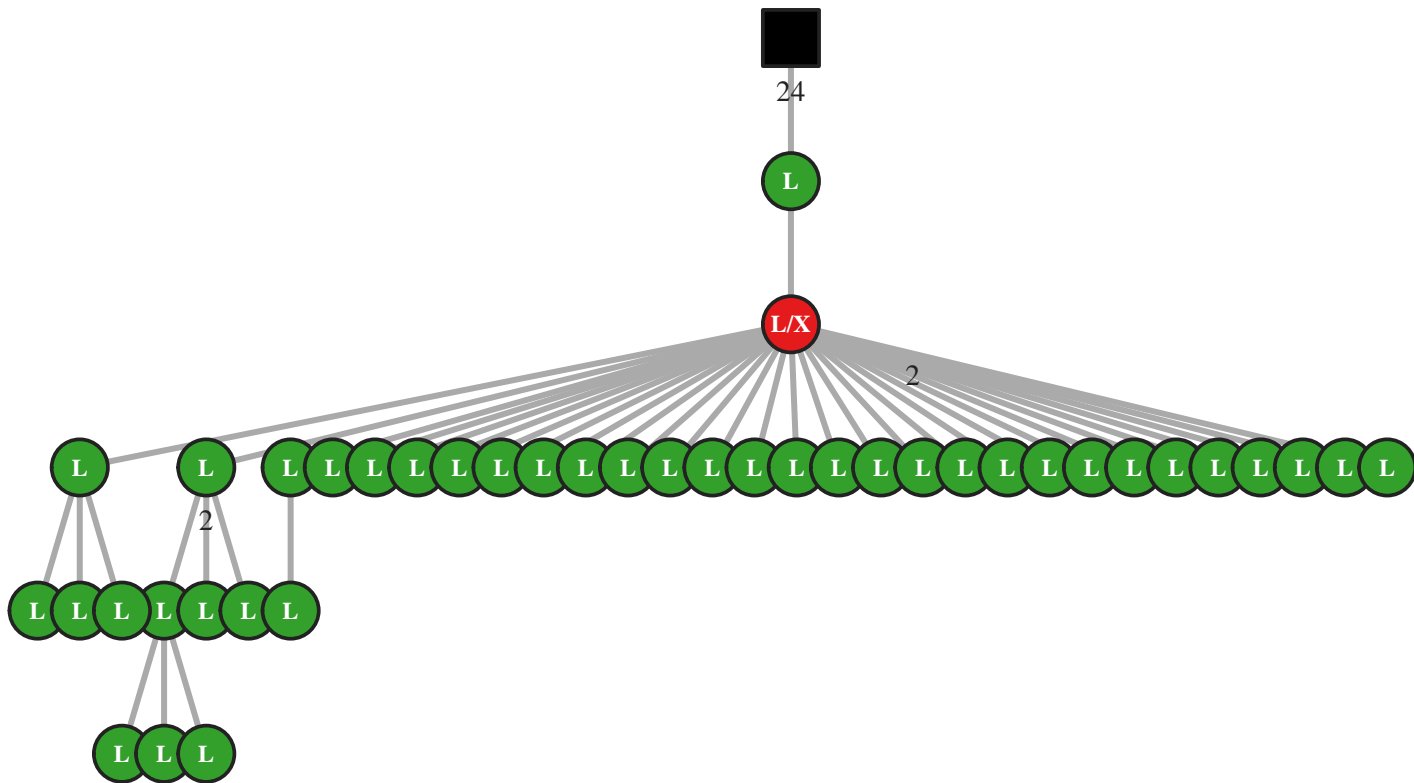

M5 IgG IGHV1-69/J6 48bp (42086)

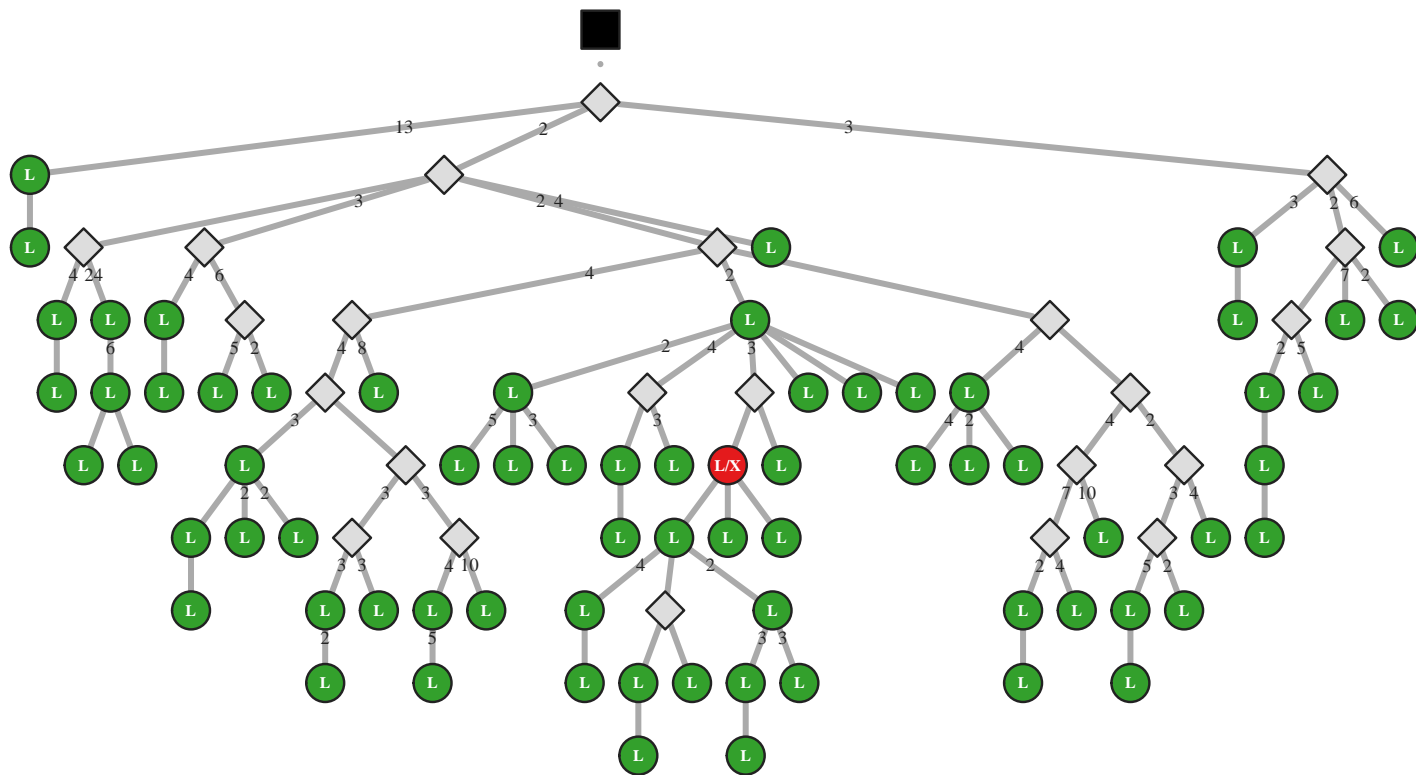

M5 IgG IGHV1-69/J6 48bp (42094)

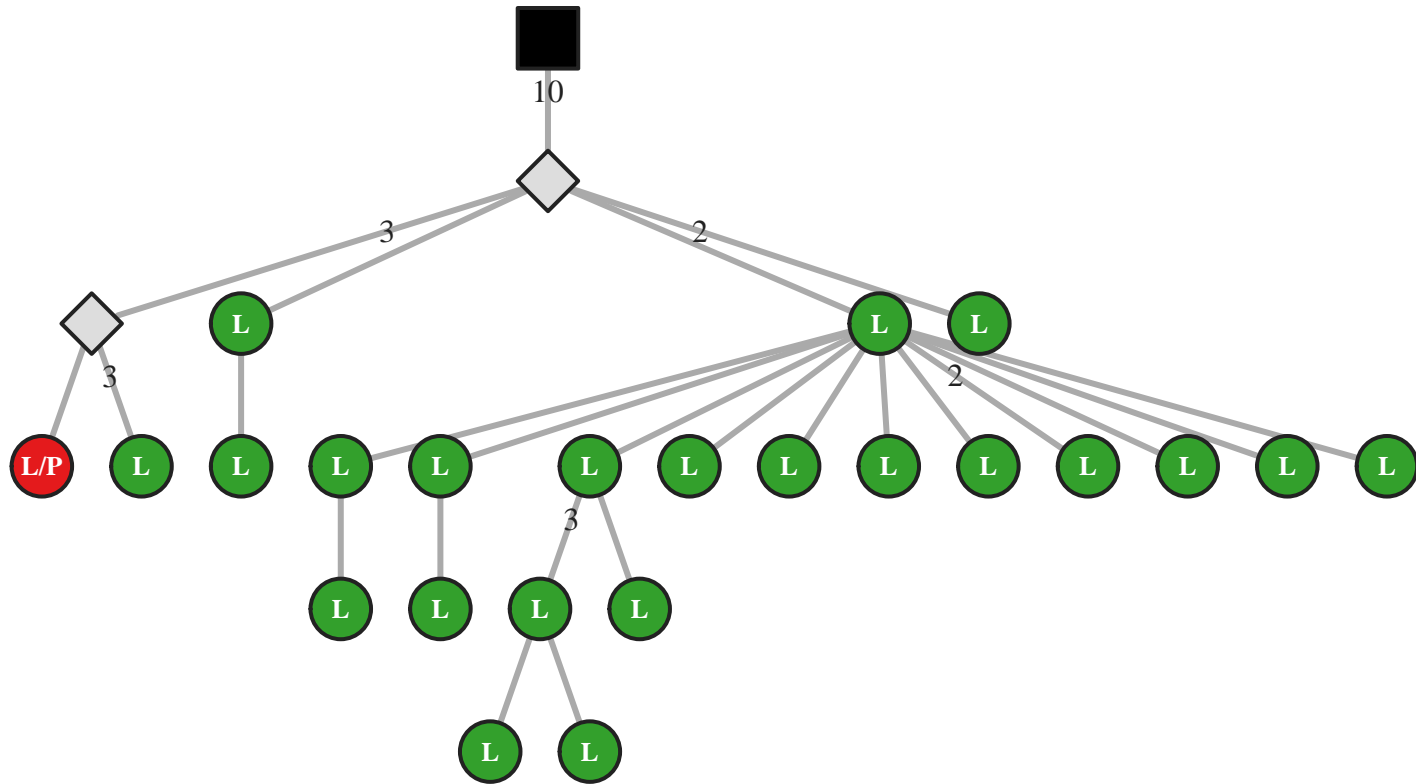

M5 IgG IGHV1-69/J6 48bp (42105)

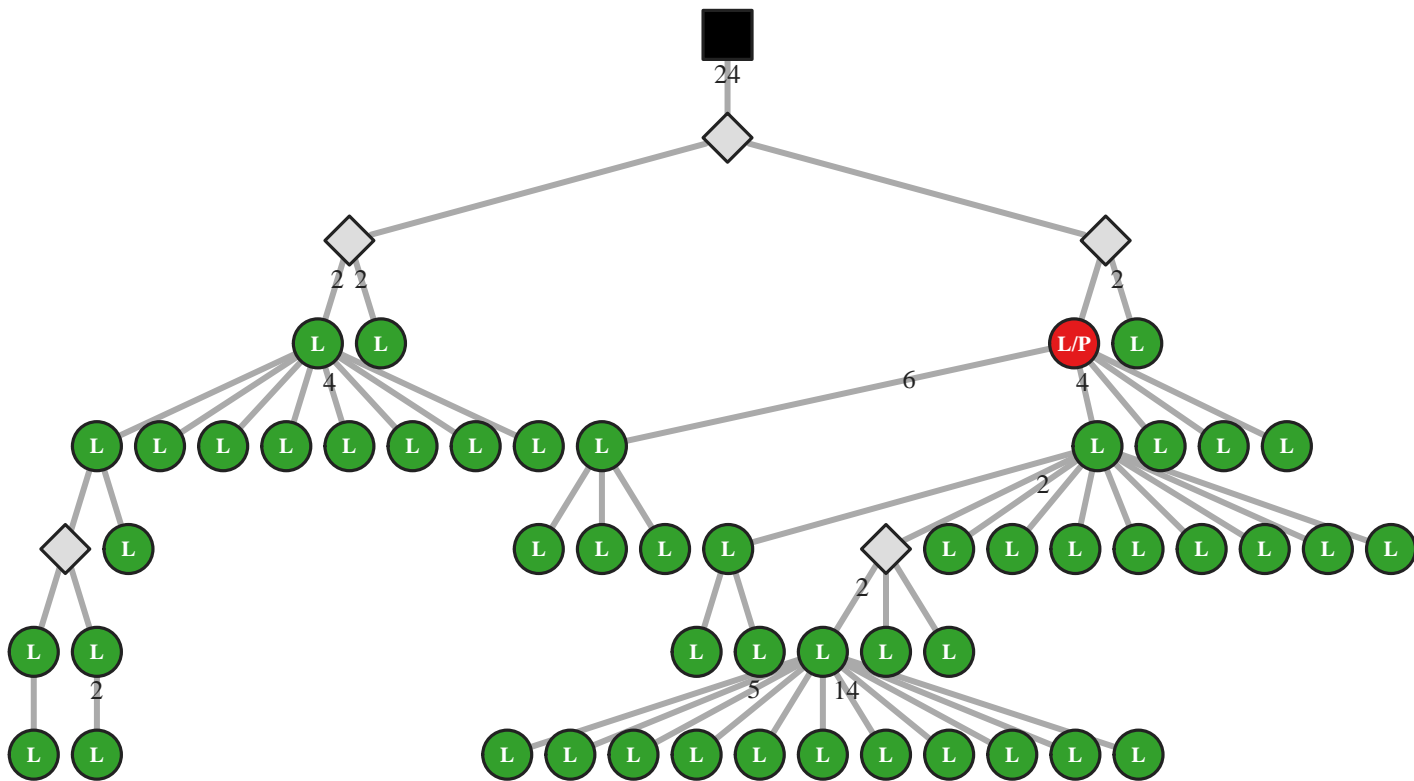

M5 IgG IGHV1-69/J6 48bp (42127)

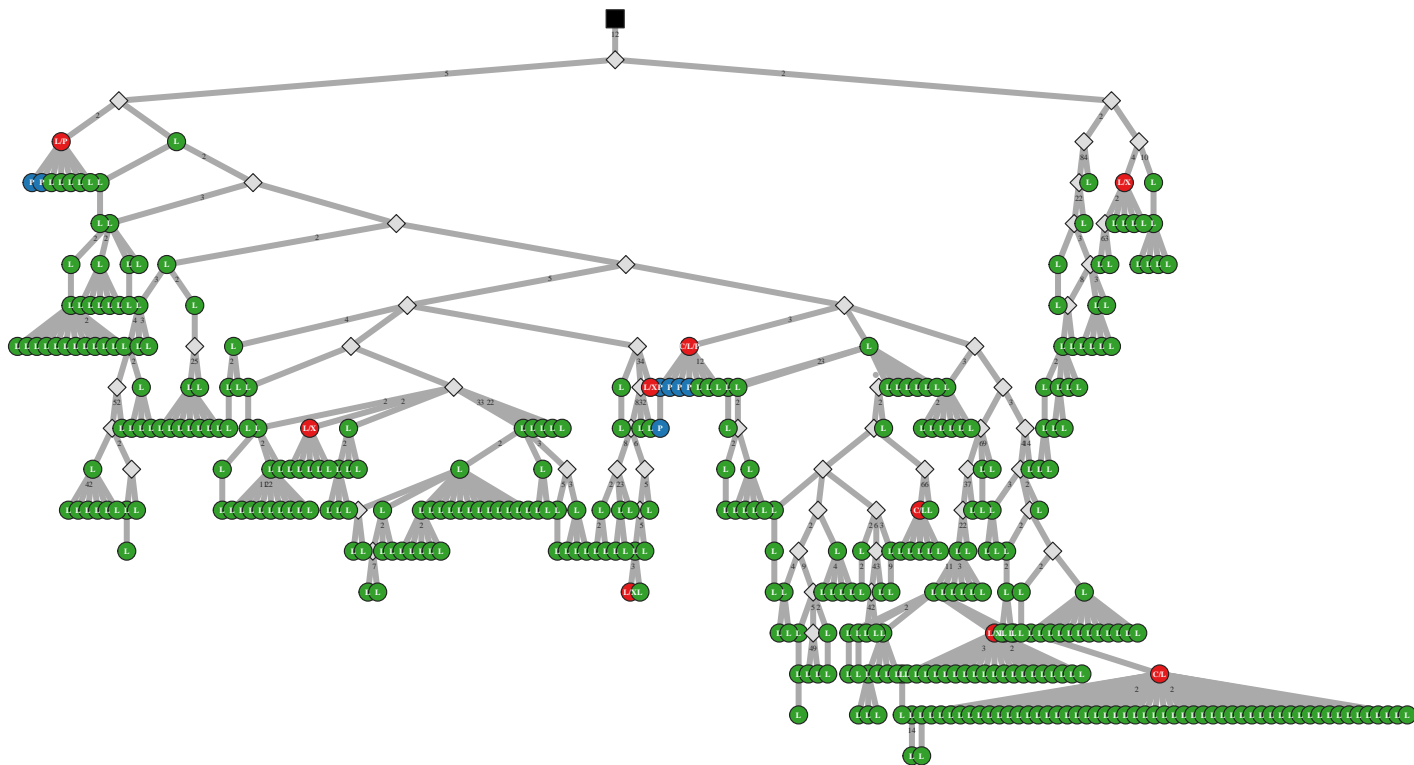

M5 IgG IGHV1-69/J6 48bp (42138)

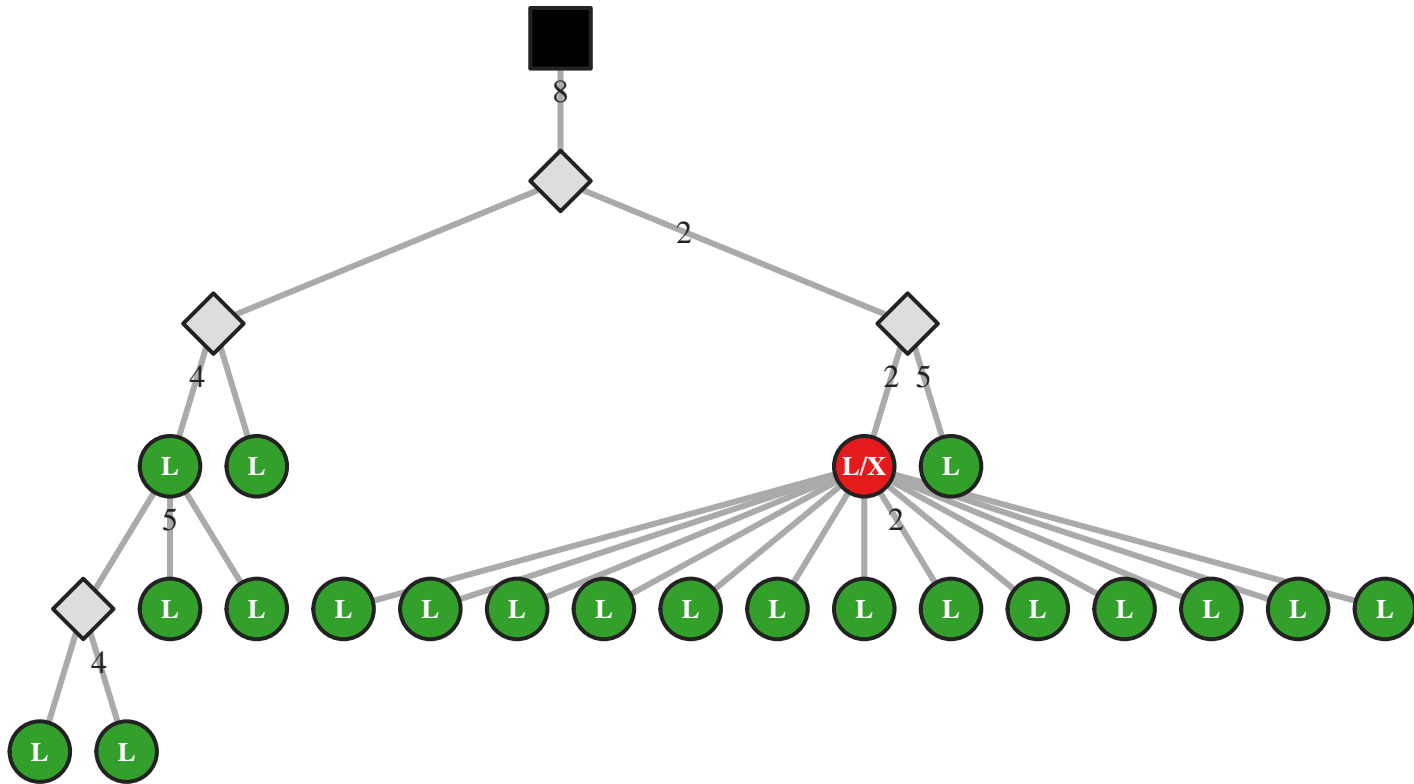

M5 IgG IGHV1-69/J6 48bp (42142)

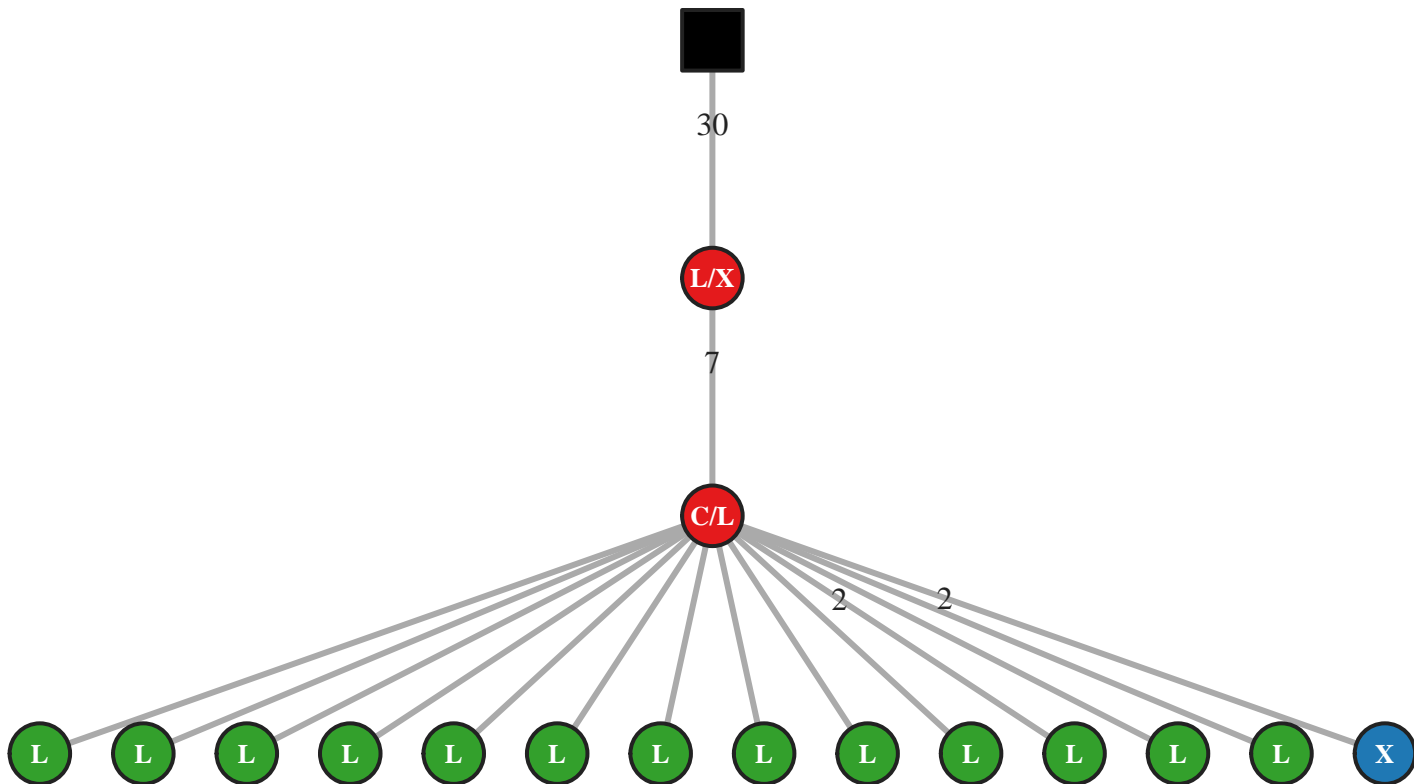

M5 IgG IGHV1-69/J6 48bp (42160)

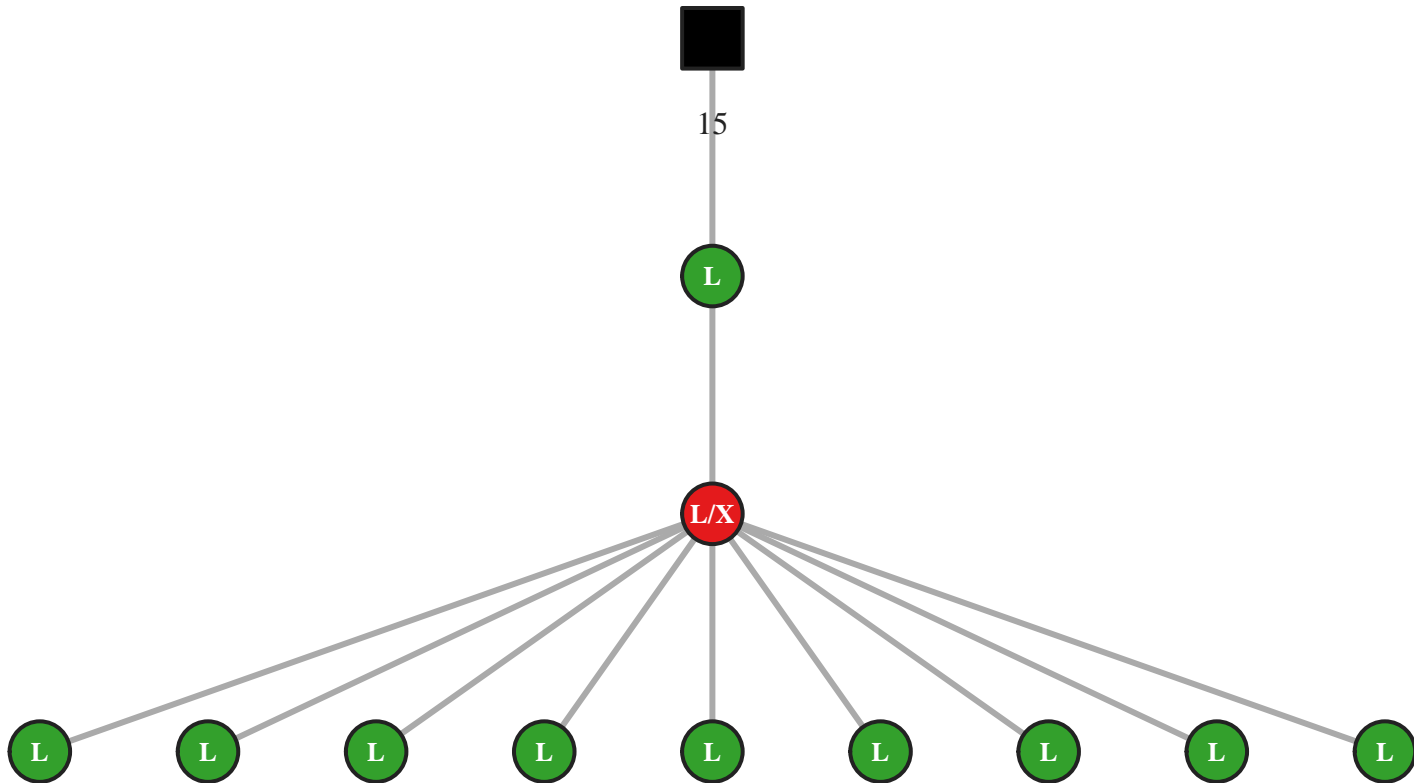

M5 IgG IGHV1-69/J6 48bp (42179)

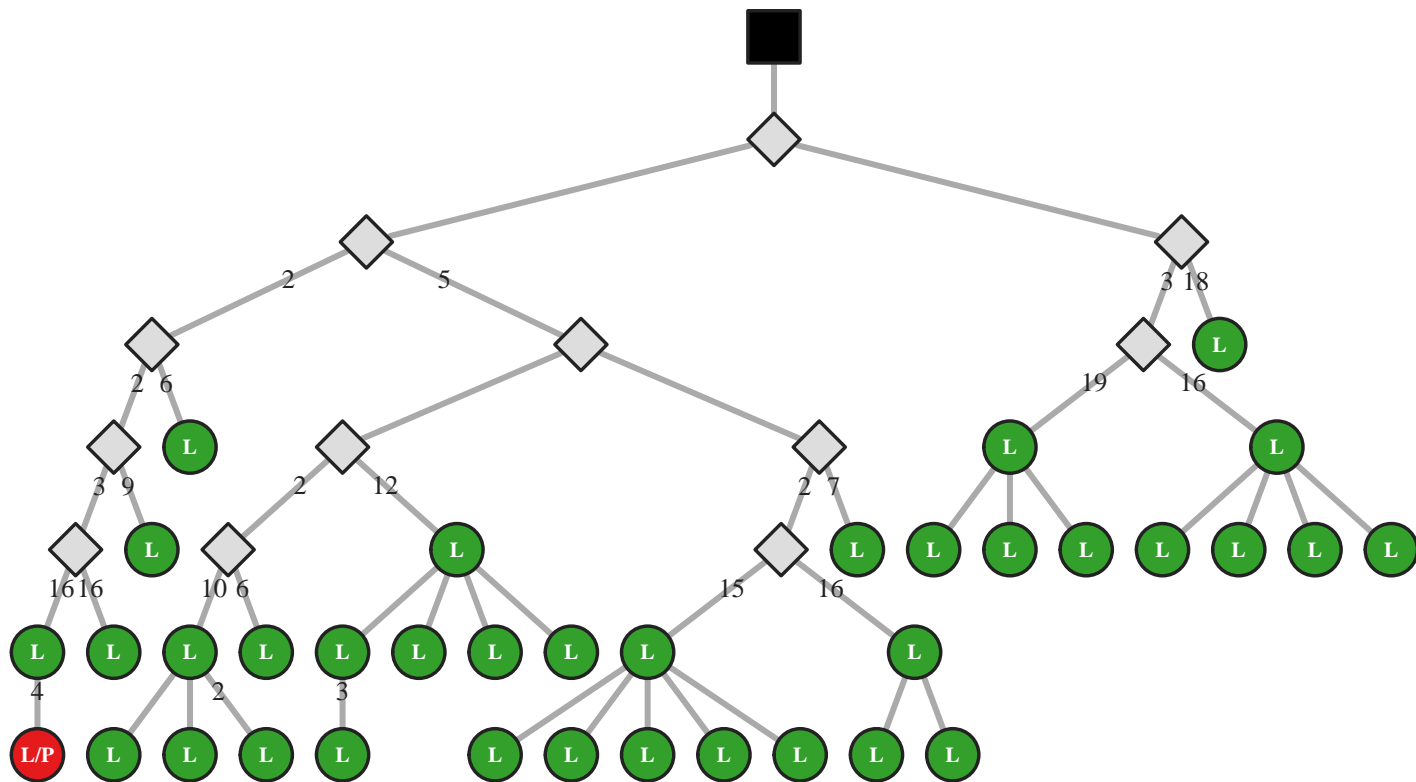

M5 IgG IGHV1-69/J6 51bp (32757)

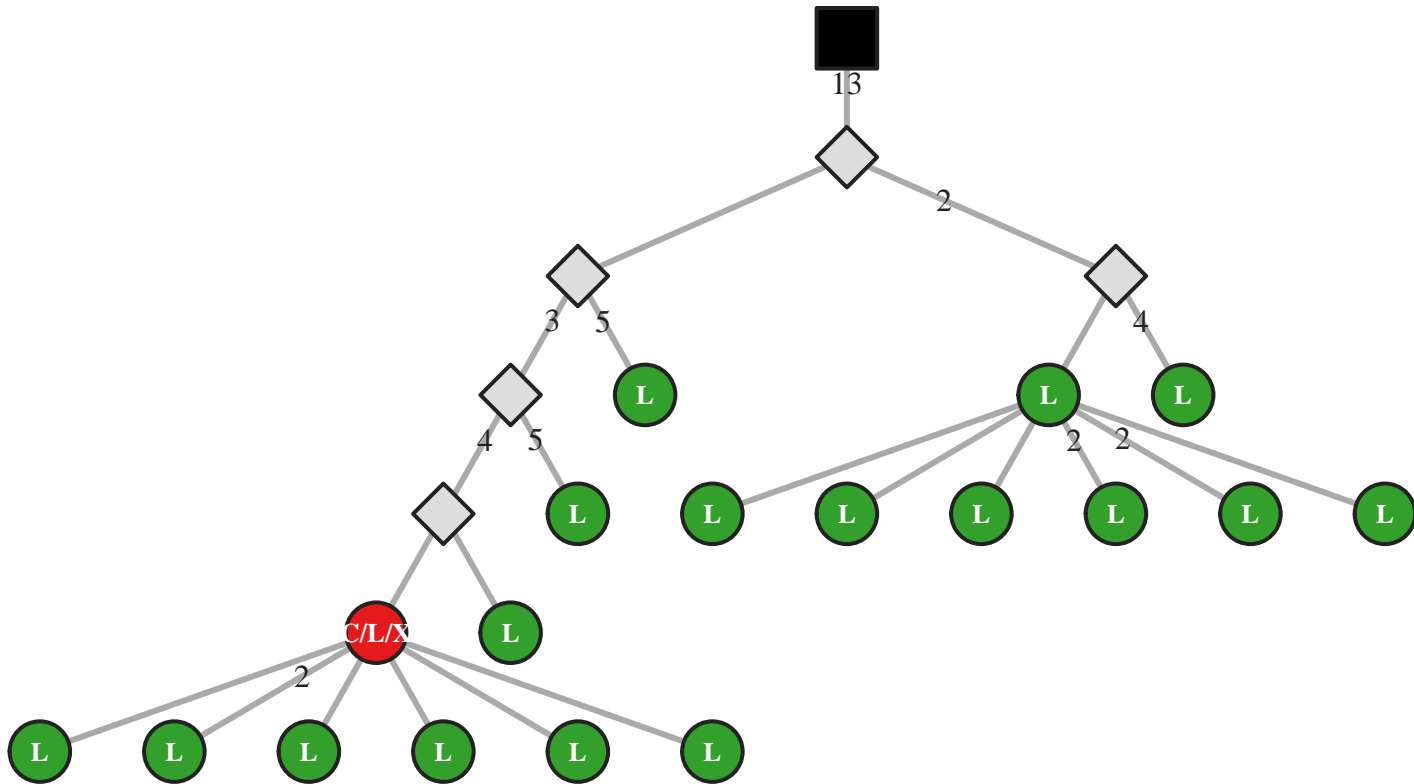

M5 IgG IGHV1-69/J6 51bp (32774)

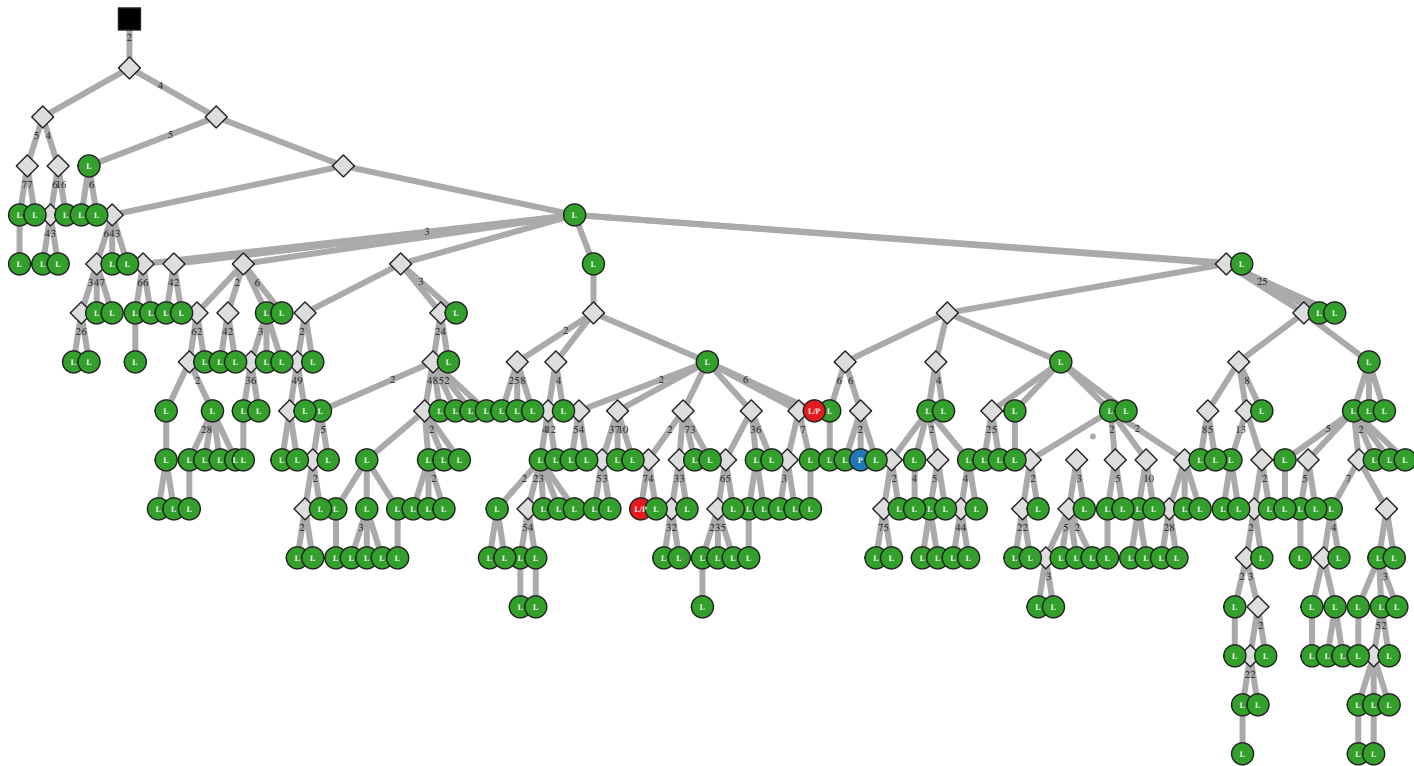

M5 IgG IGHV1-69/J6 51bp (32777)

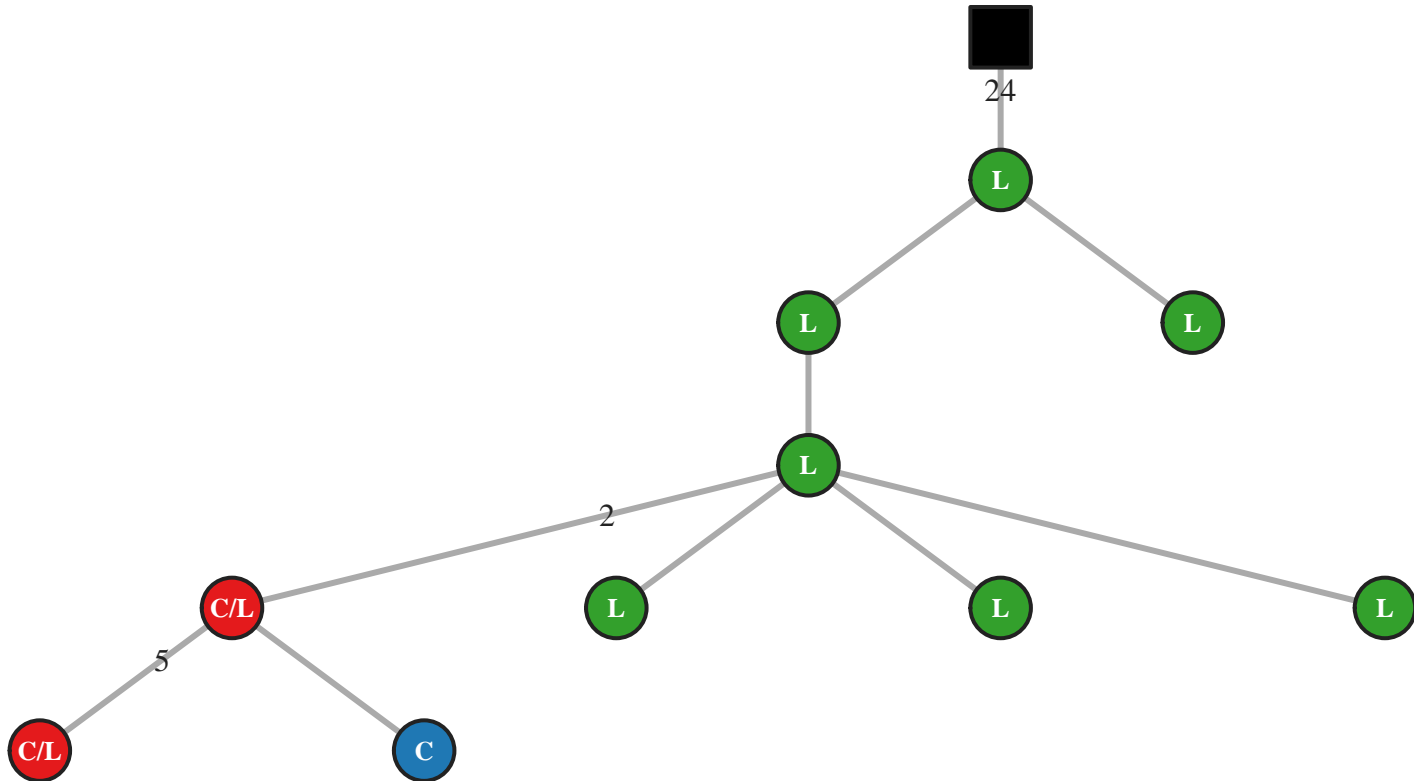

M5 IgG IGHV1-69/J6 51bp (32818)

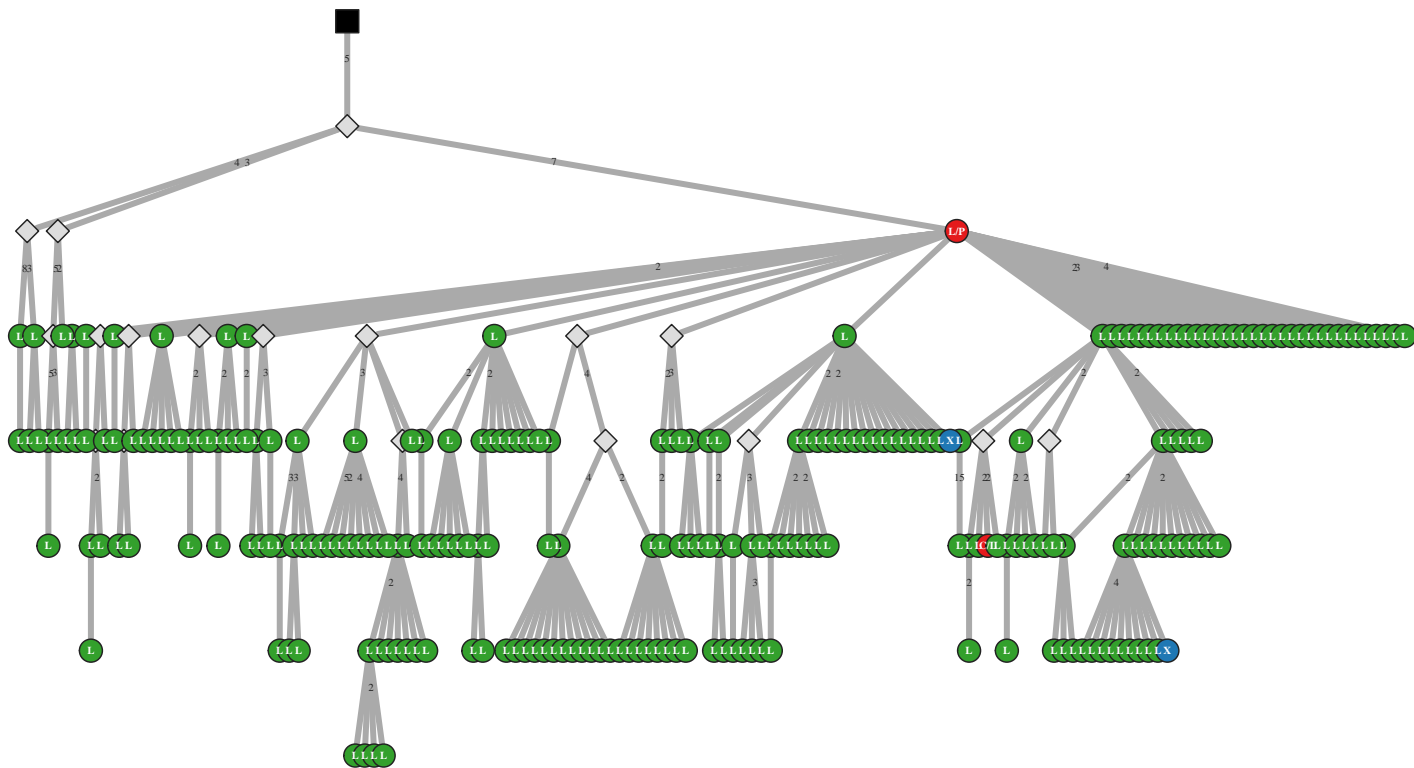

M5 IgG IGHV1-69/J6 54bp (14866)

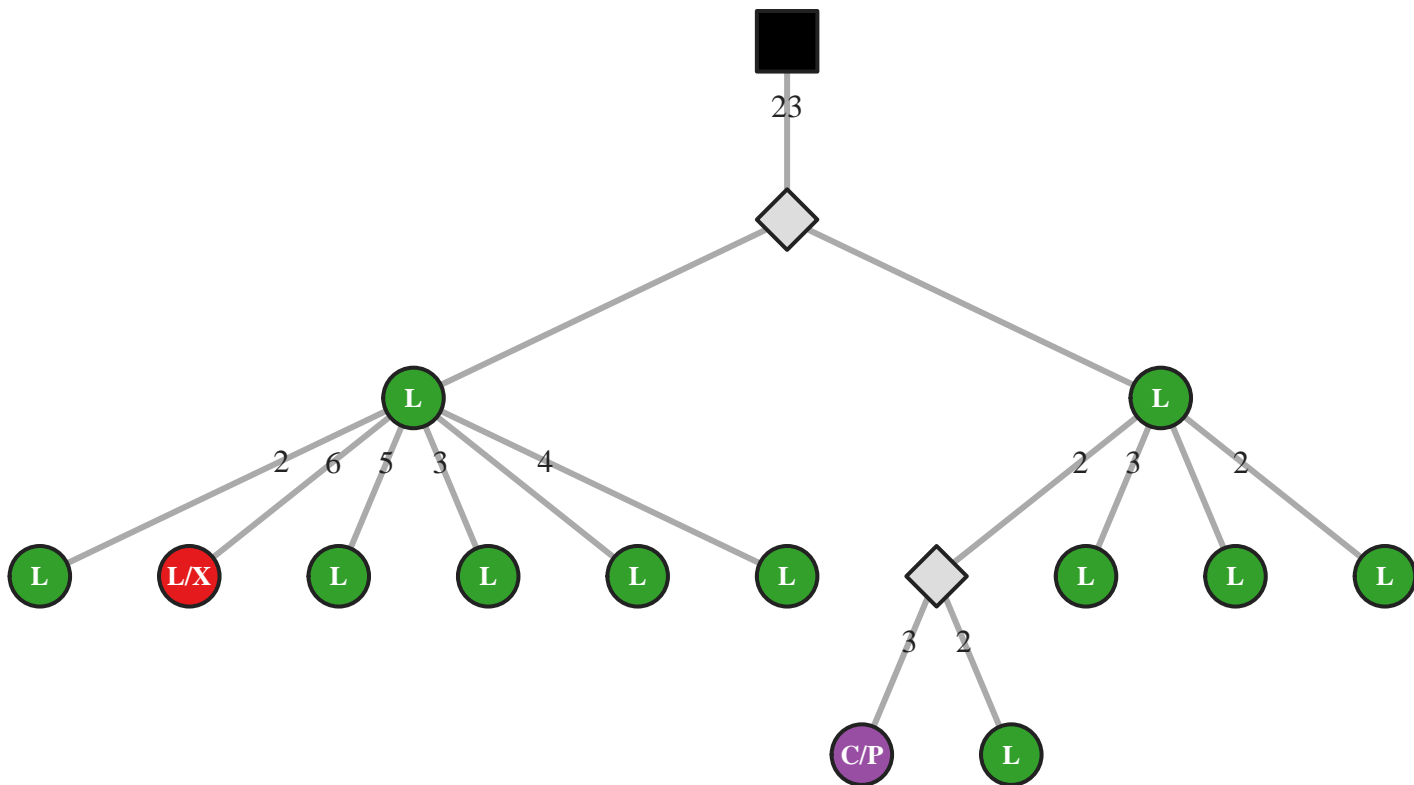

M5 IgG IGHV1-69/J6 54bp (14872)

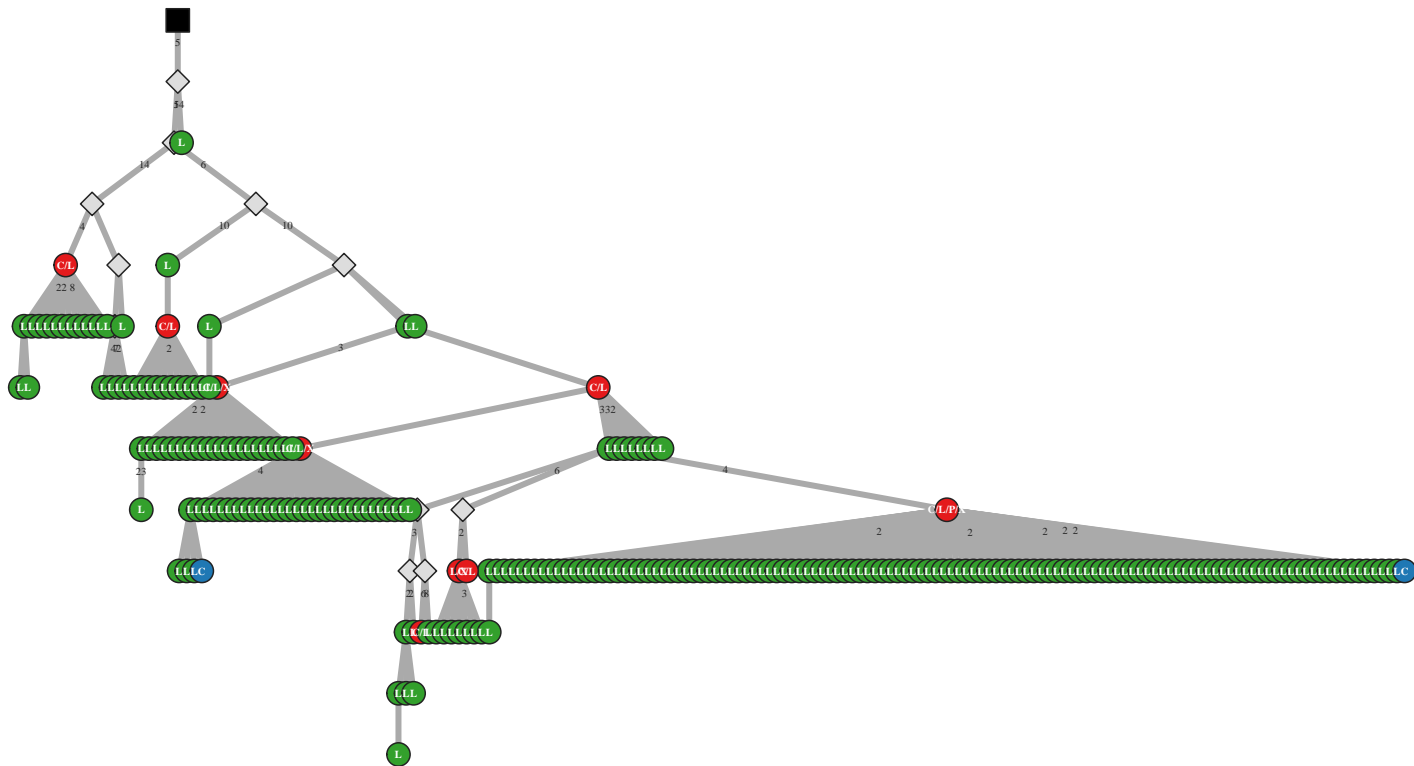

M5 IgG IGHV1-69/J6 54bp (14899)

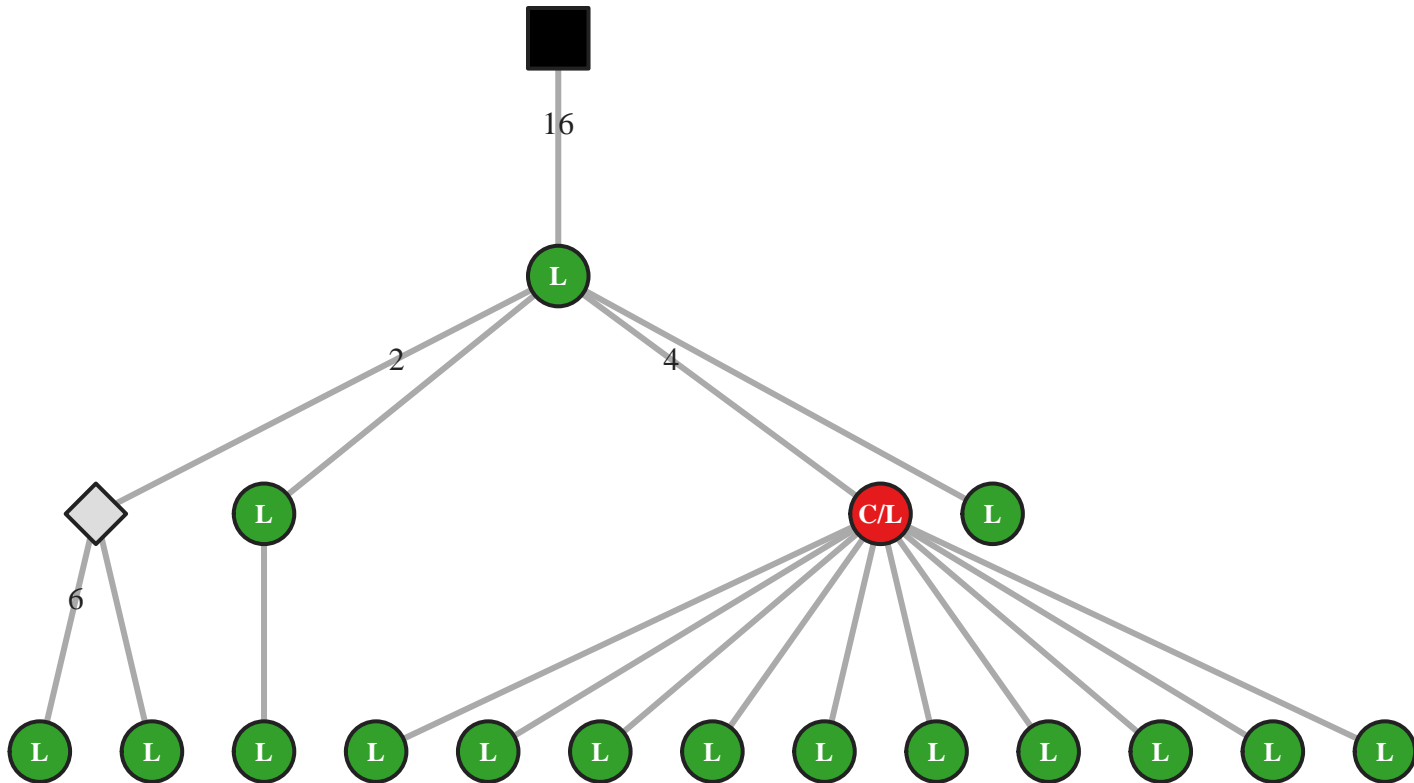

M5 IgG IGHV1-69/J6 54bp (14900)

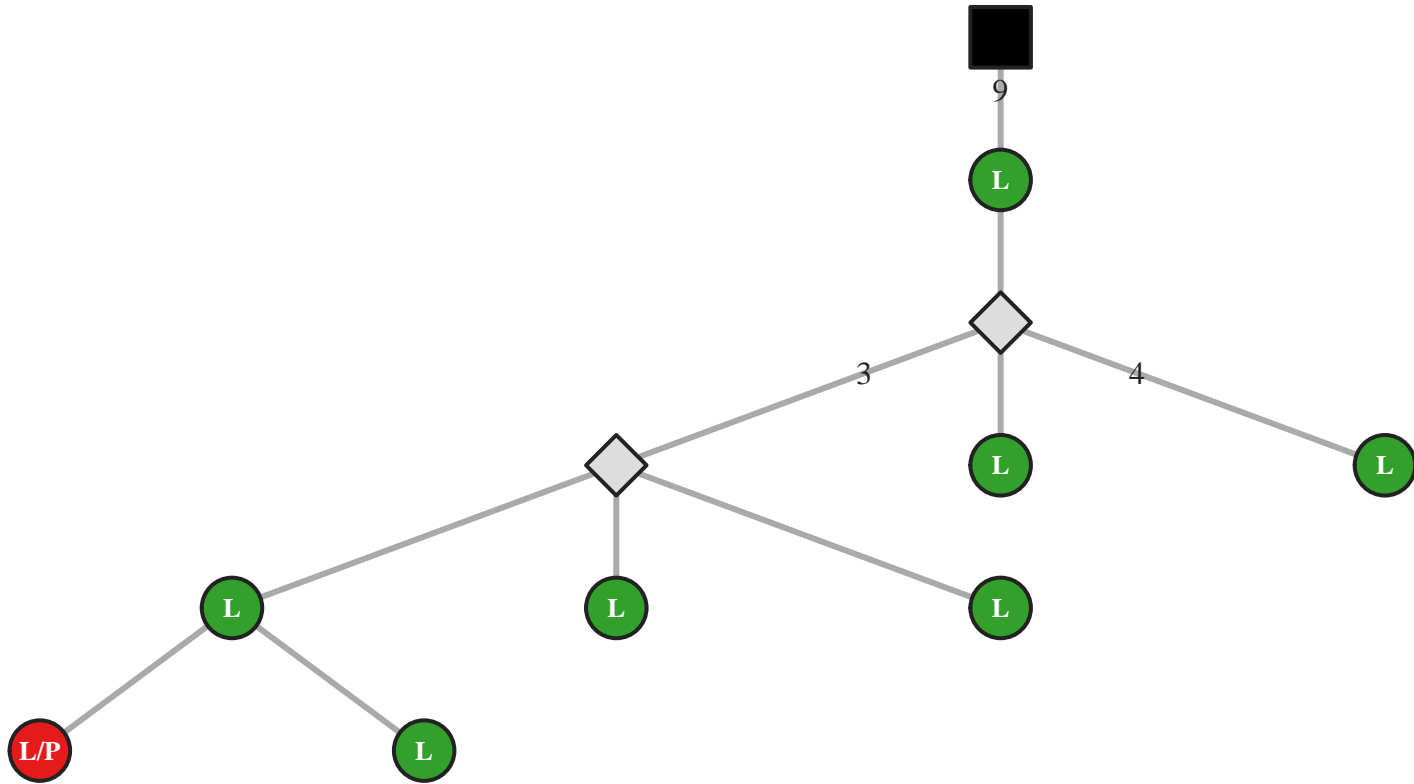

M5 IgG IGHV1-69/J6 54bp (14930)

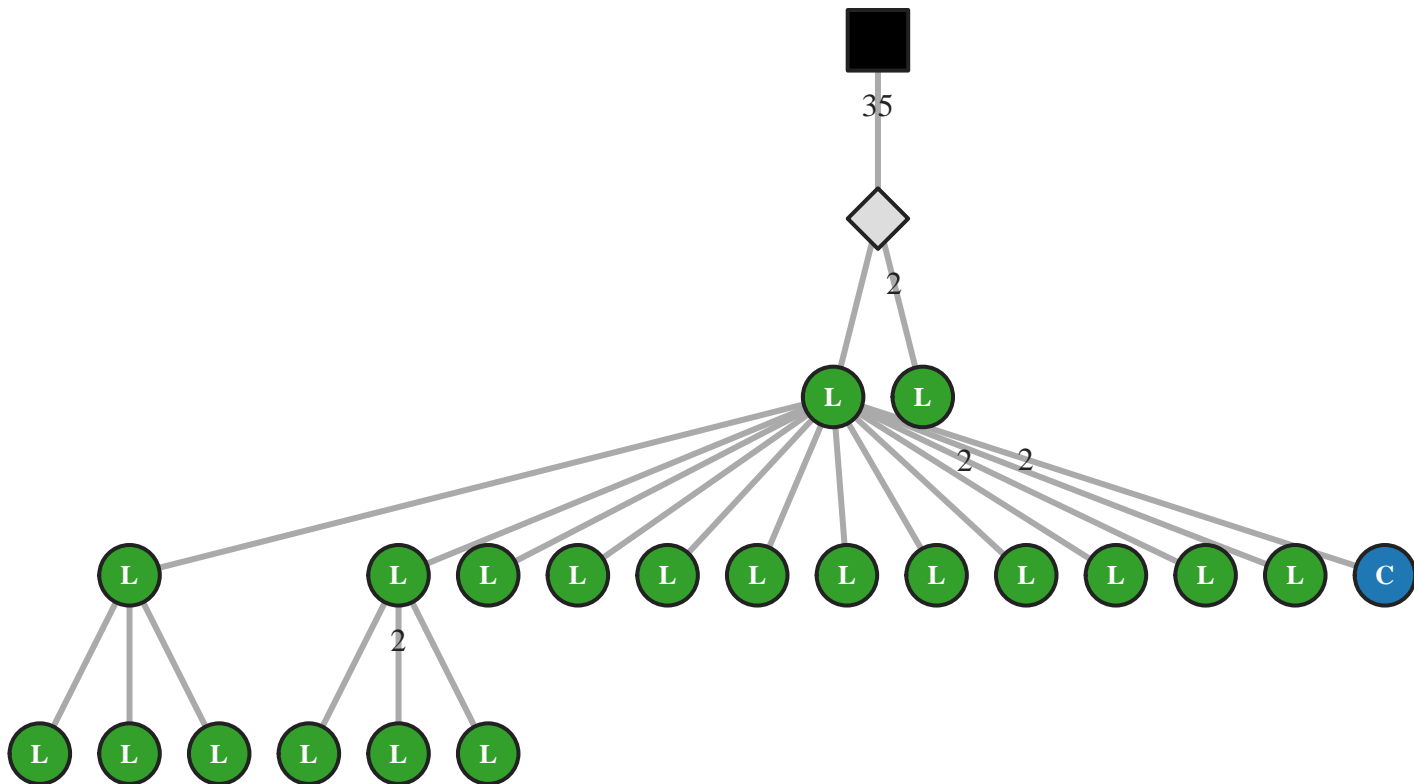

M5 IgG IGHV1-69/J6 54bp (14934)

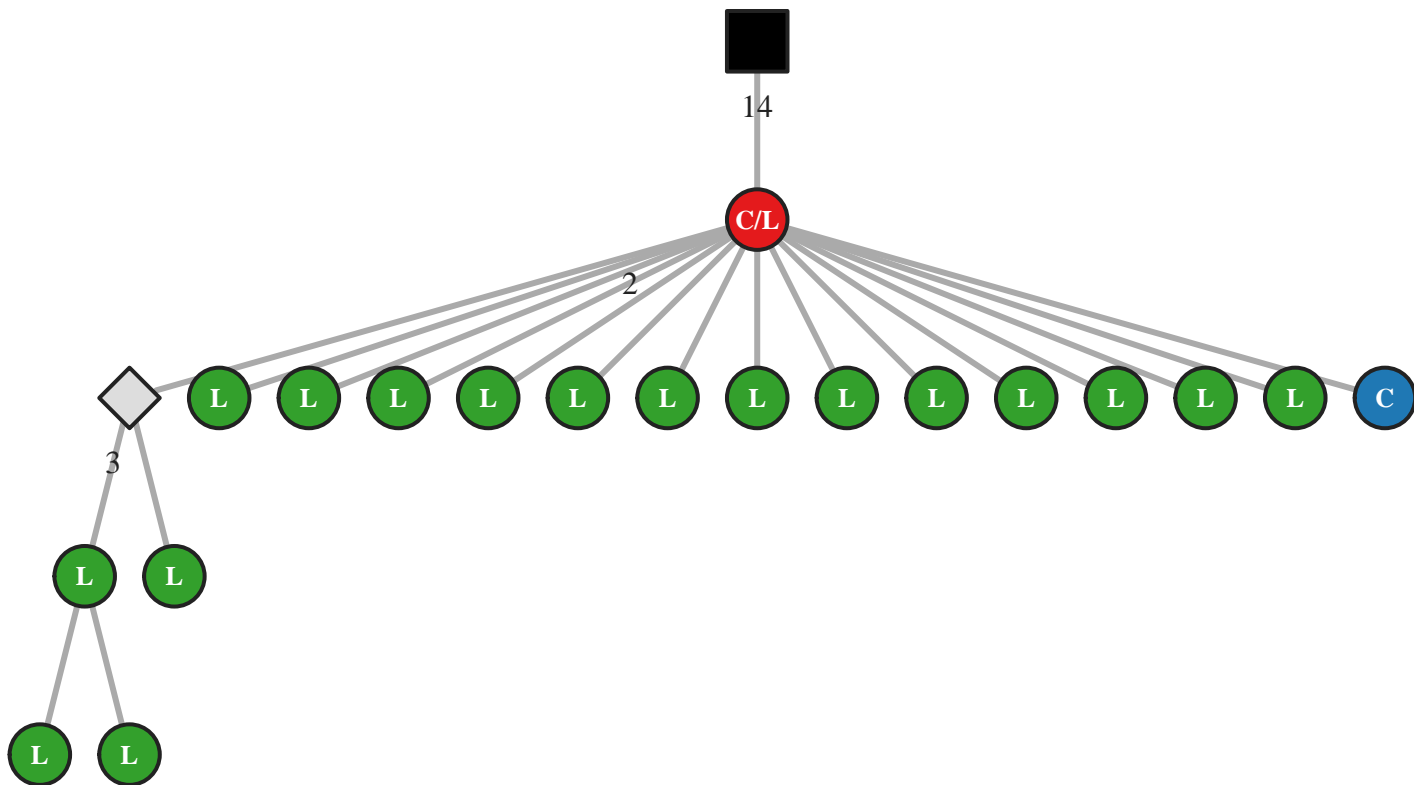

M5 IgG IGHV1-69/J6 57bp (24040)

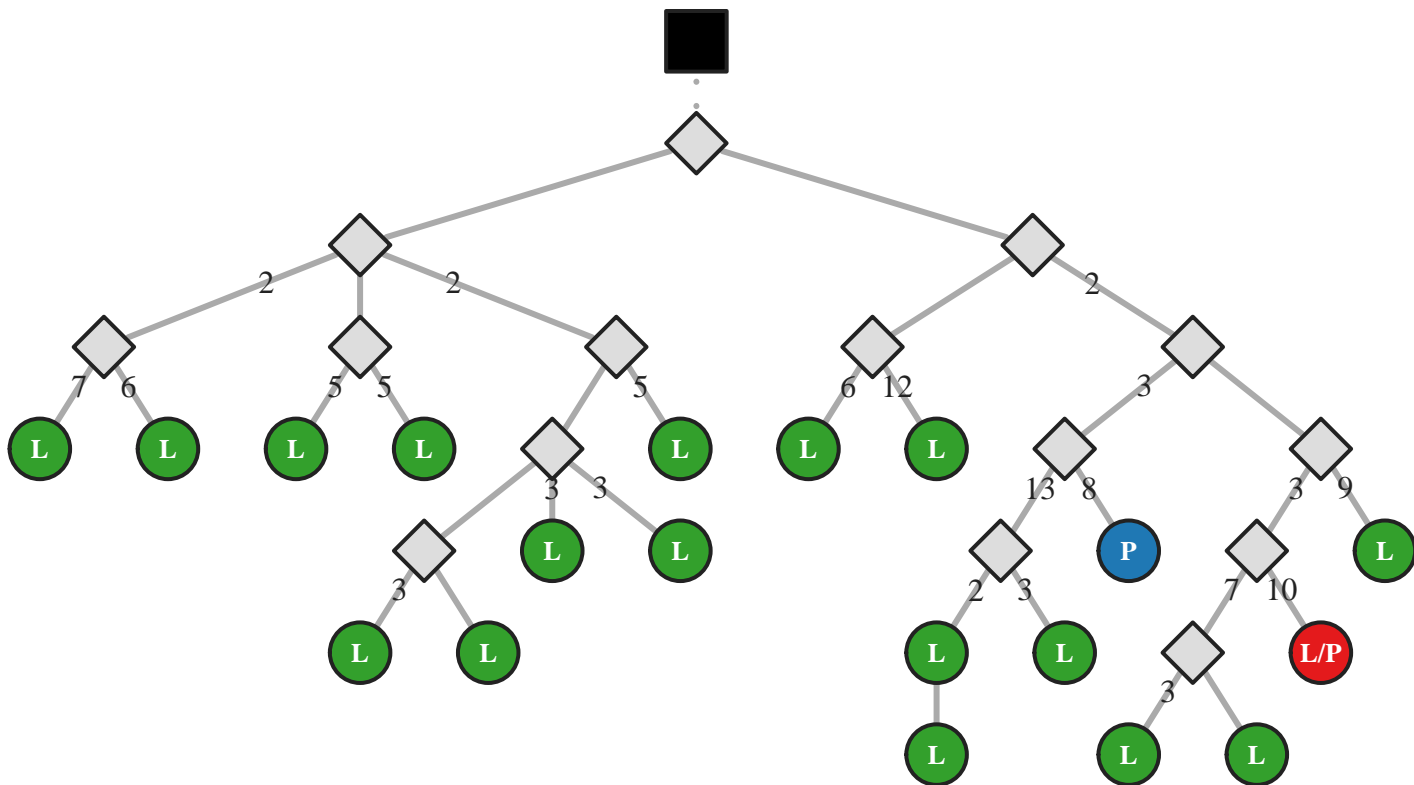

M5 IgG IGHV1-69/J6 57bp (24047)

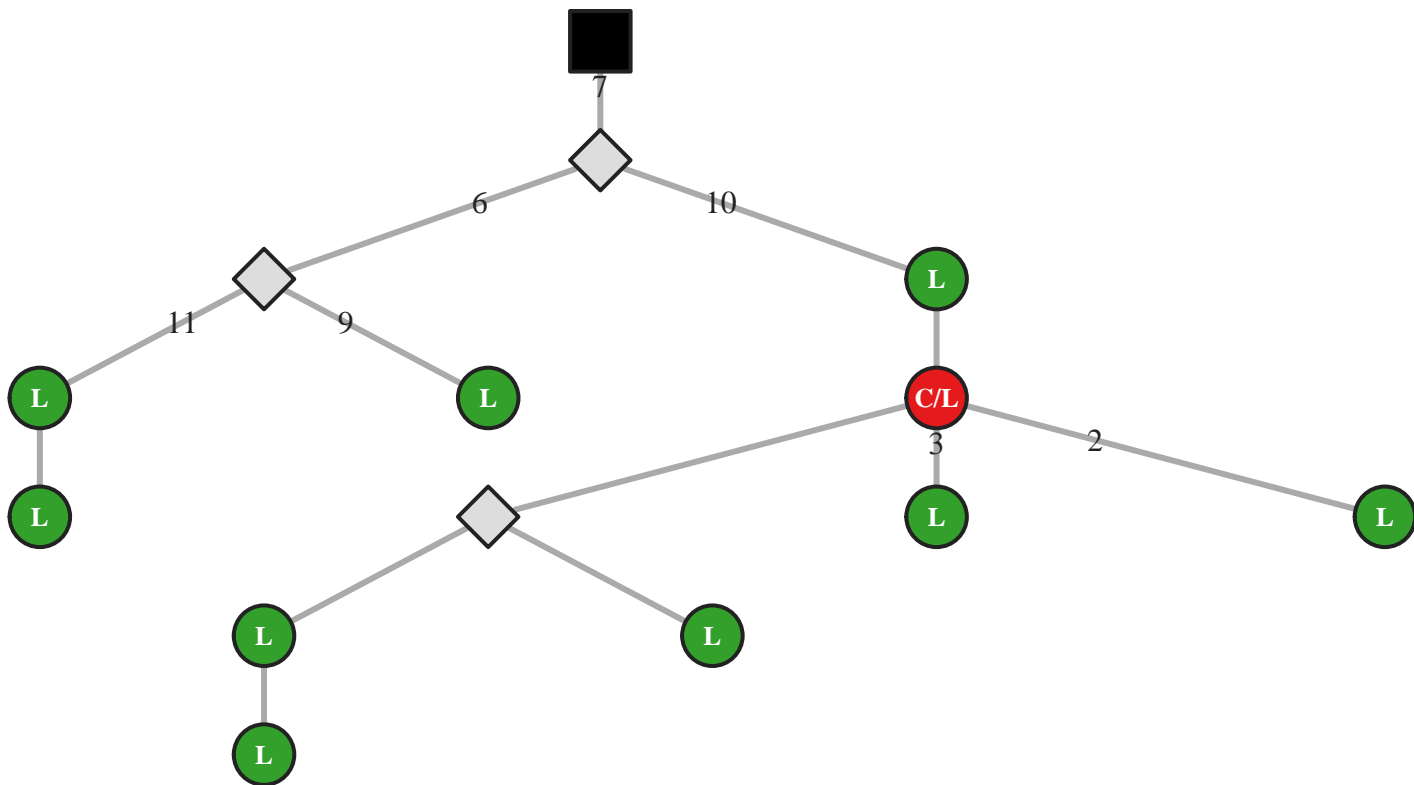

M5 IgG IGHV1-69/J6 57bp (24086)

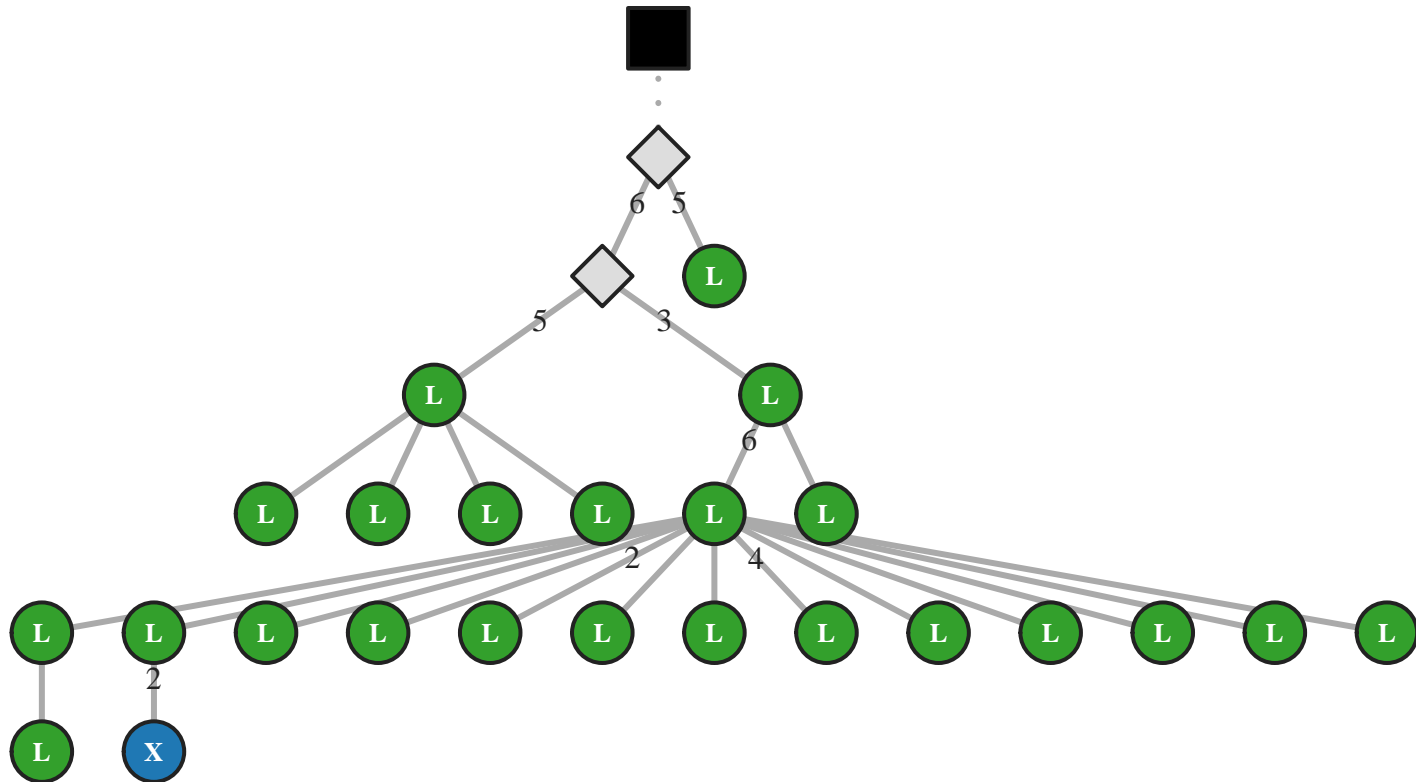

M5 IgG IGHV1-69/J6 60bp (24189)

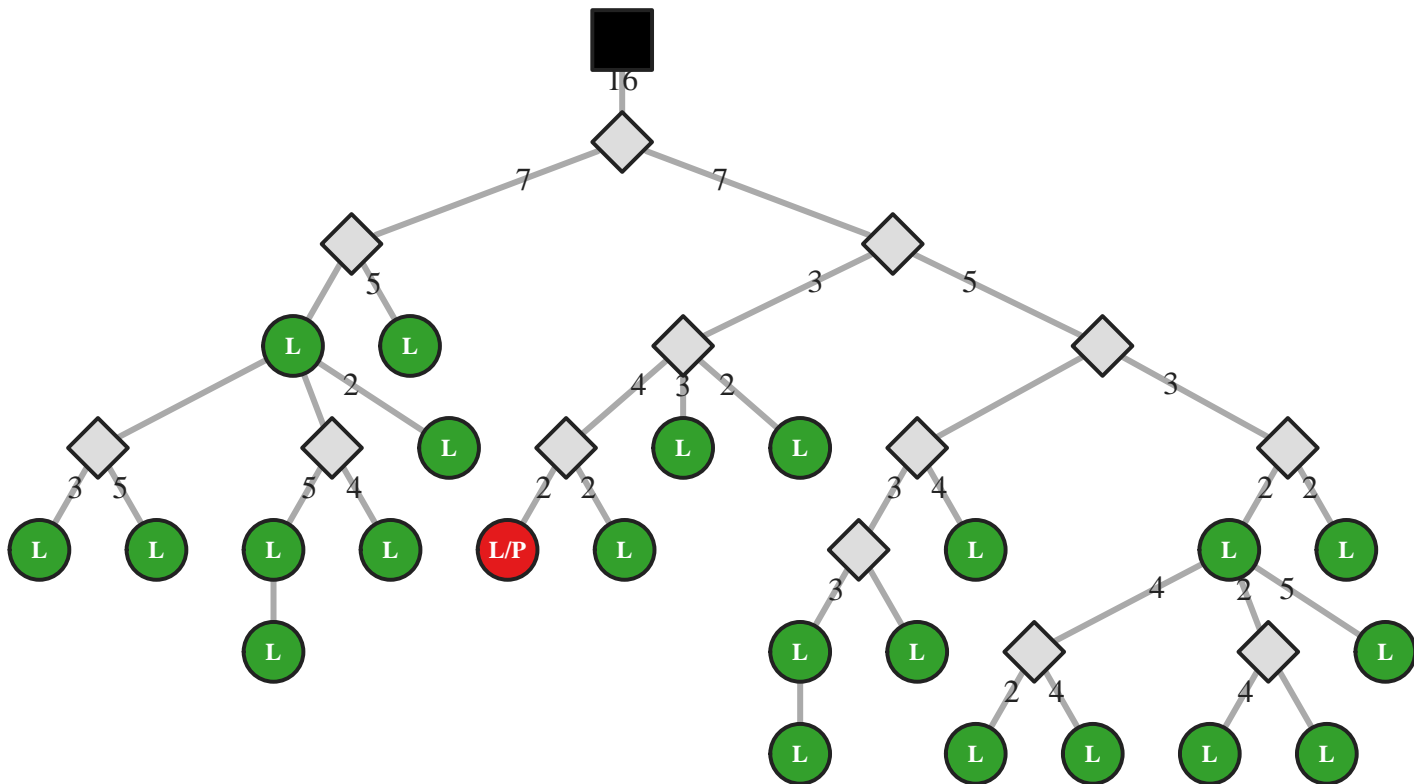

M5 IgG IGHV1-69/J6 60bp (24196)

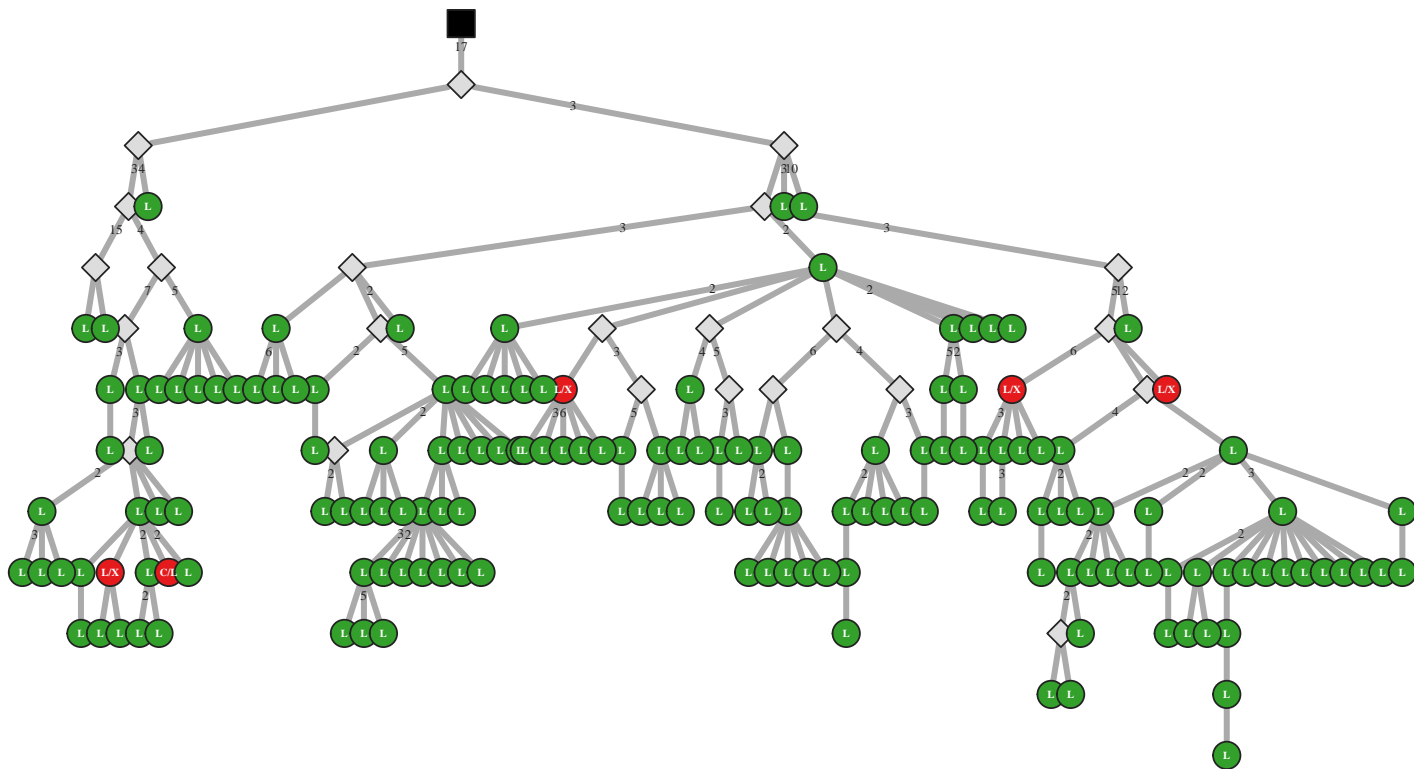

M5 IgG IGHV1-69/J6 60bp (24207)

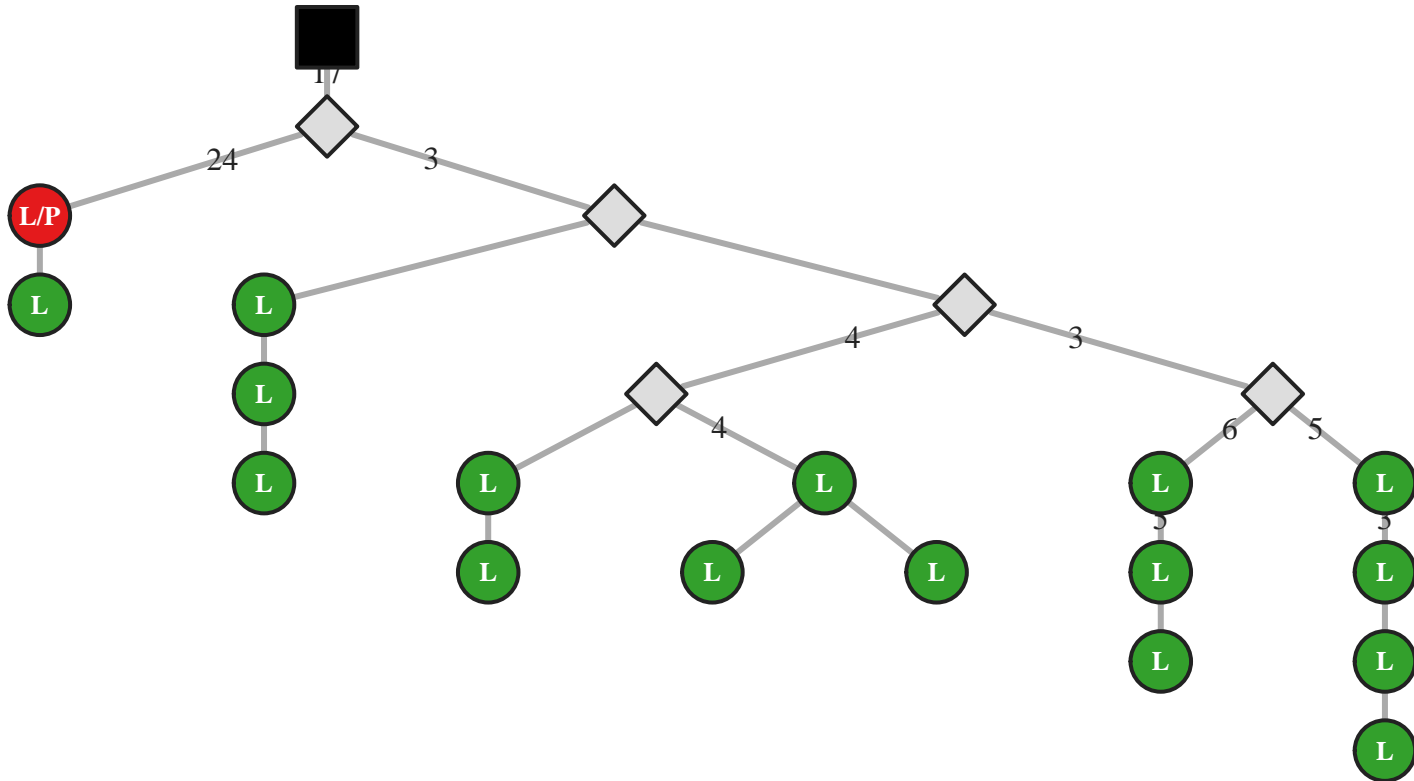

M5 IgG IGHV1-69/J6 60bp (24208)

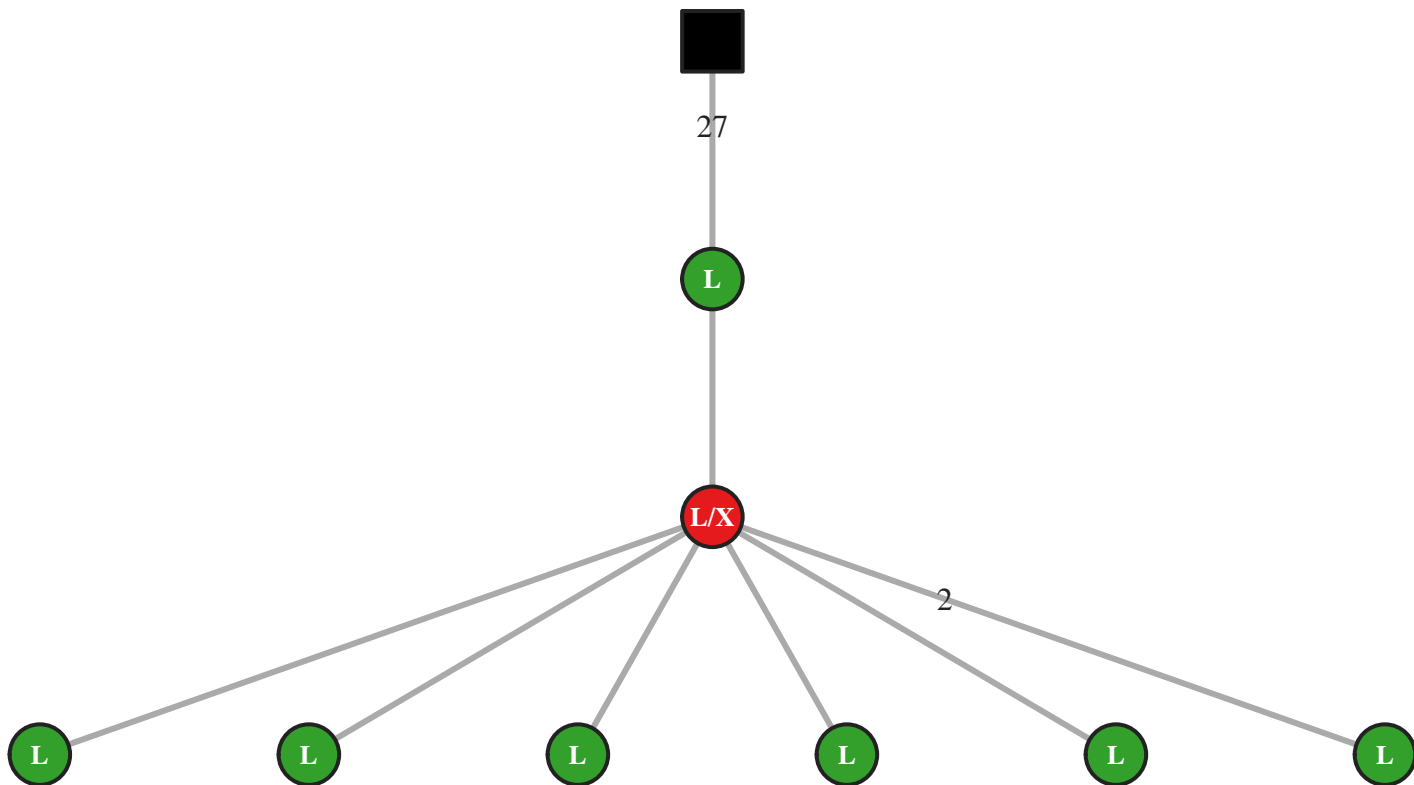

M5 IgG IGHV1-69/J6 60bp (24218)

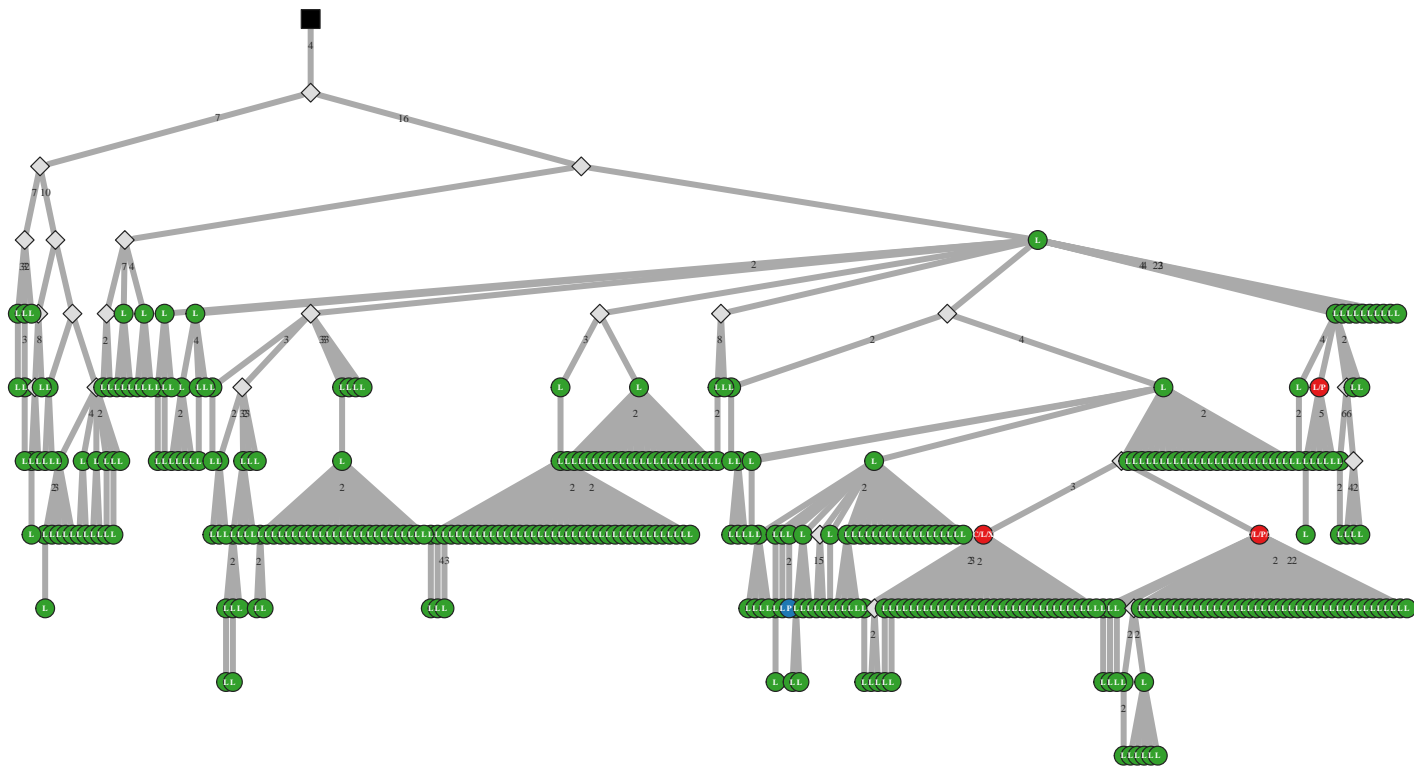

M5 IgG IGHV1-69/J6 60bp (24229)

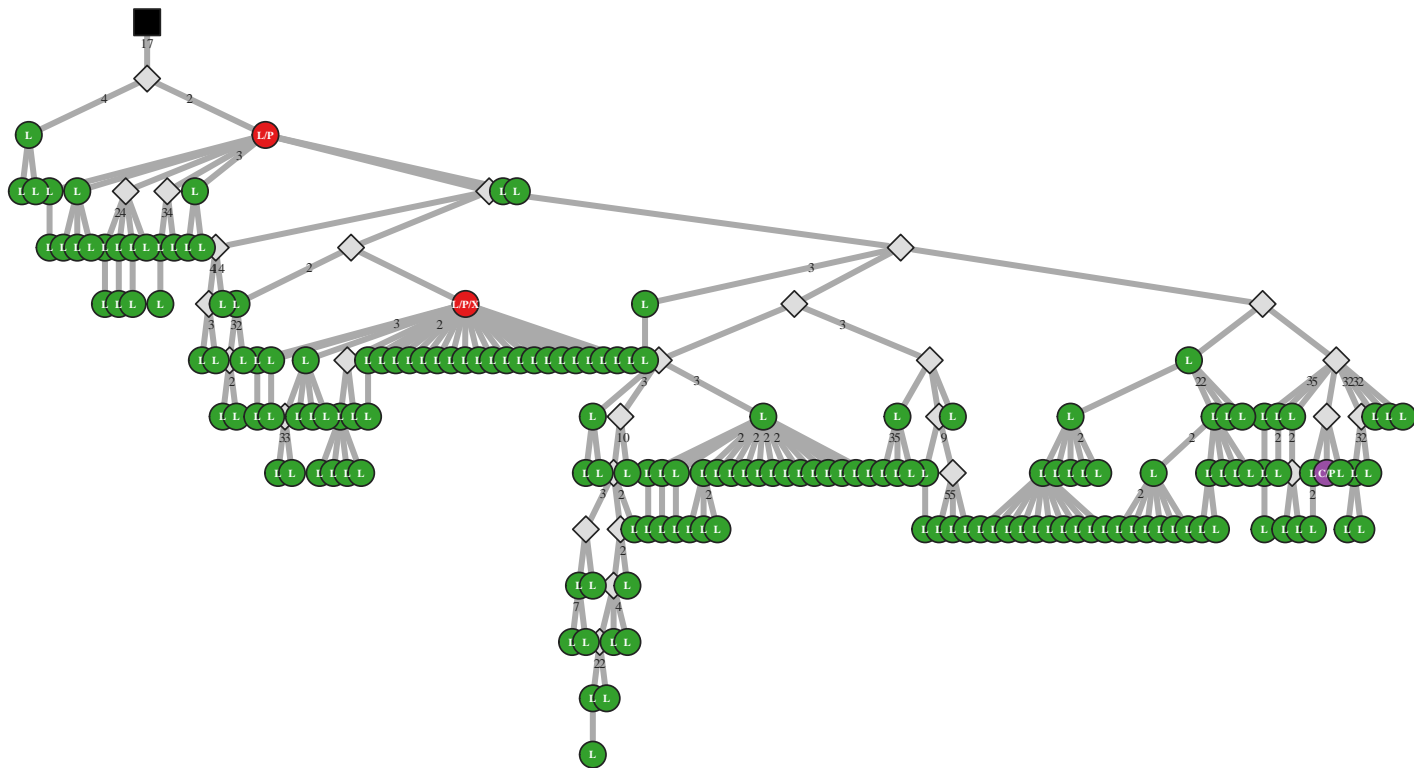

M5 IgG IGHV1-69/J6 63bp (32839)

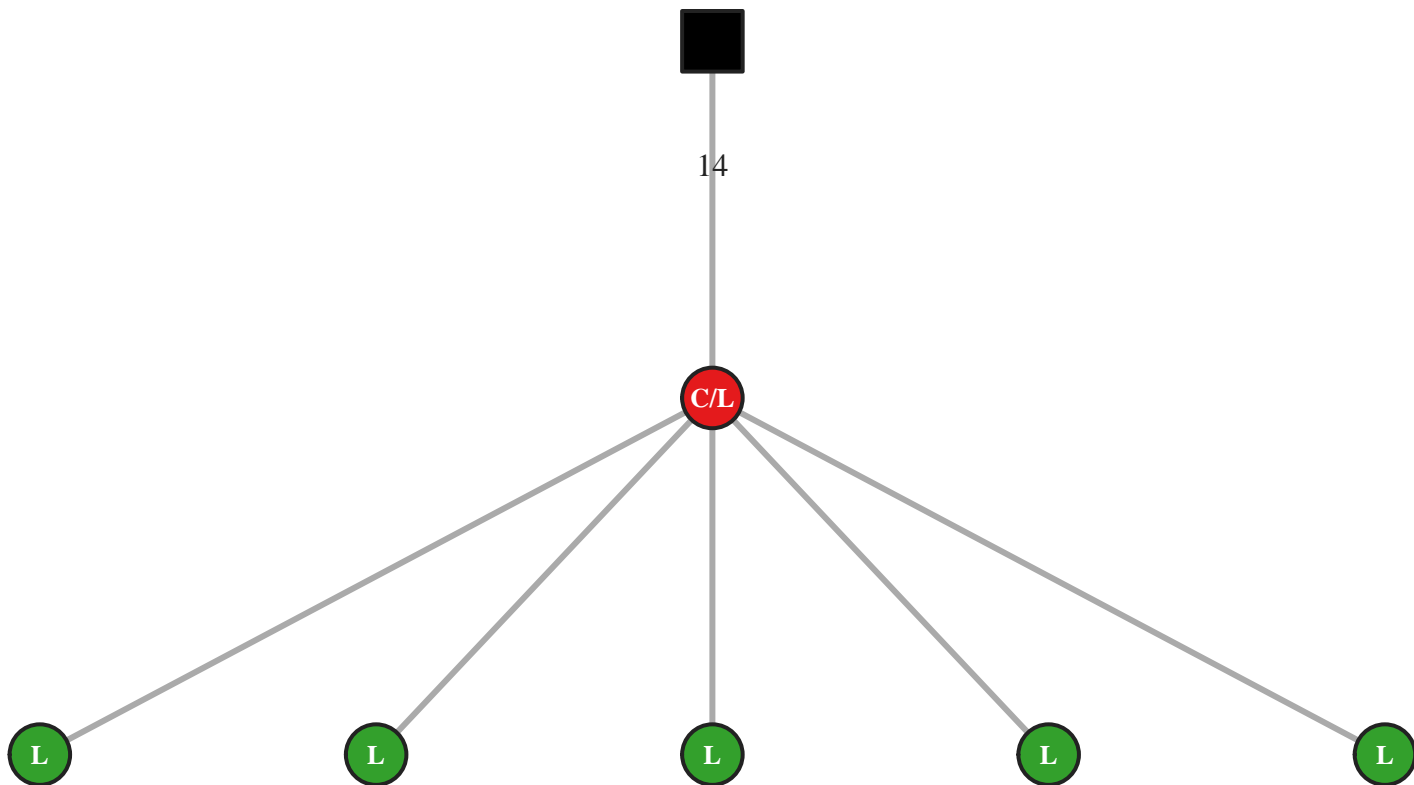

M5 IgG IGHV1-69/J6 63bp (32928)

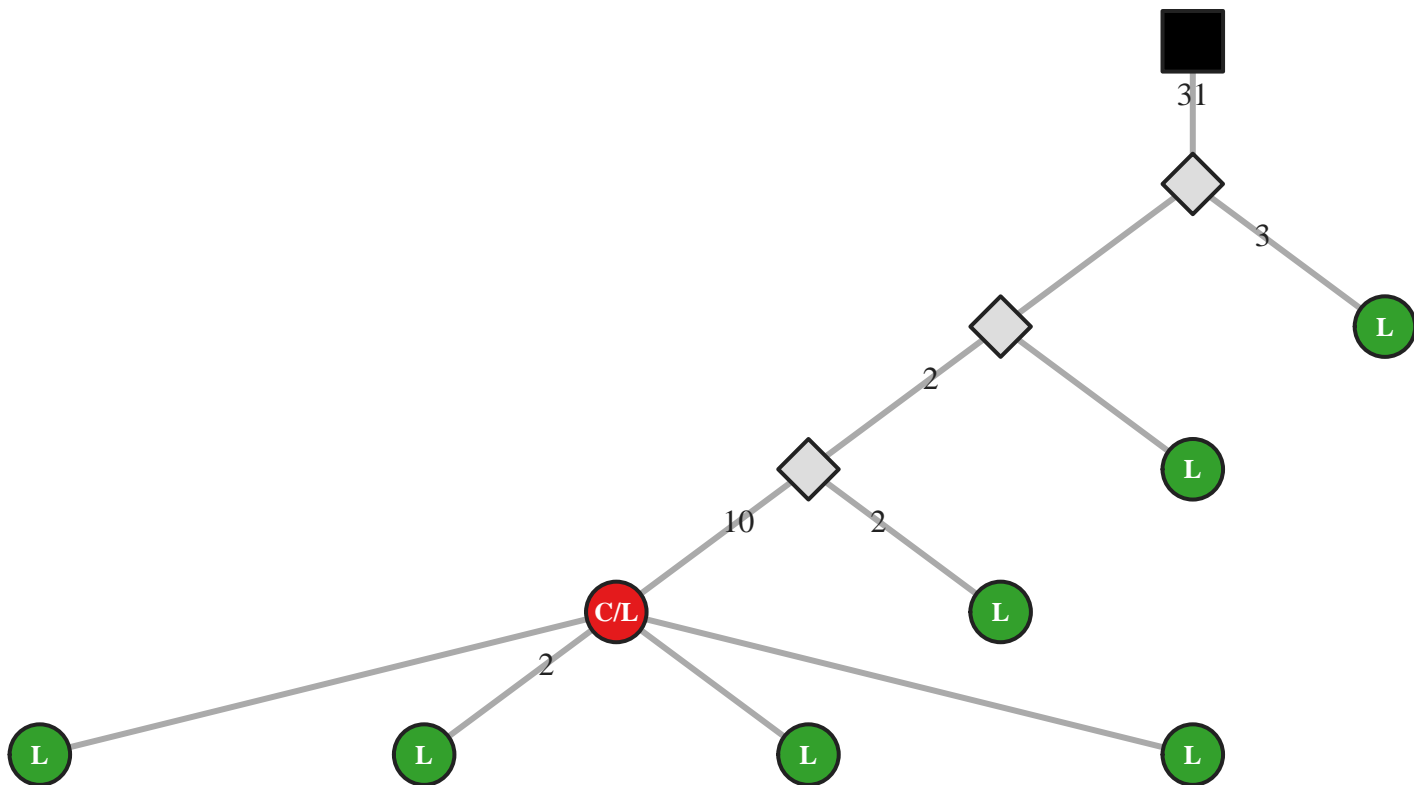

M5 IgG IGHV1-69/J6 66bp (50360)

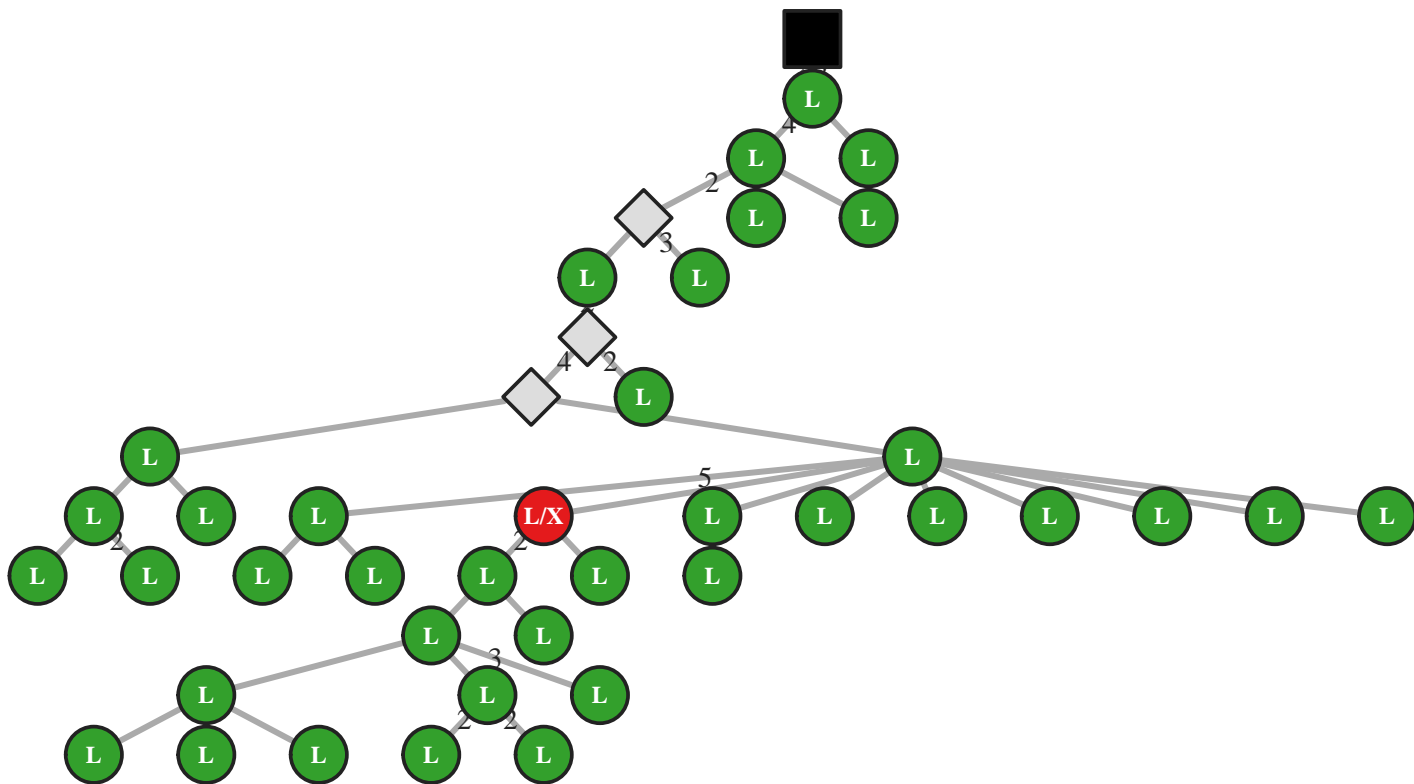

M5 IgG IGHV1-69/J6 66bp (50379)

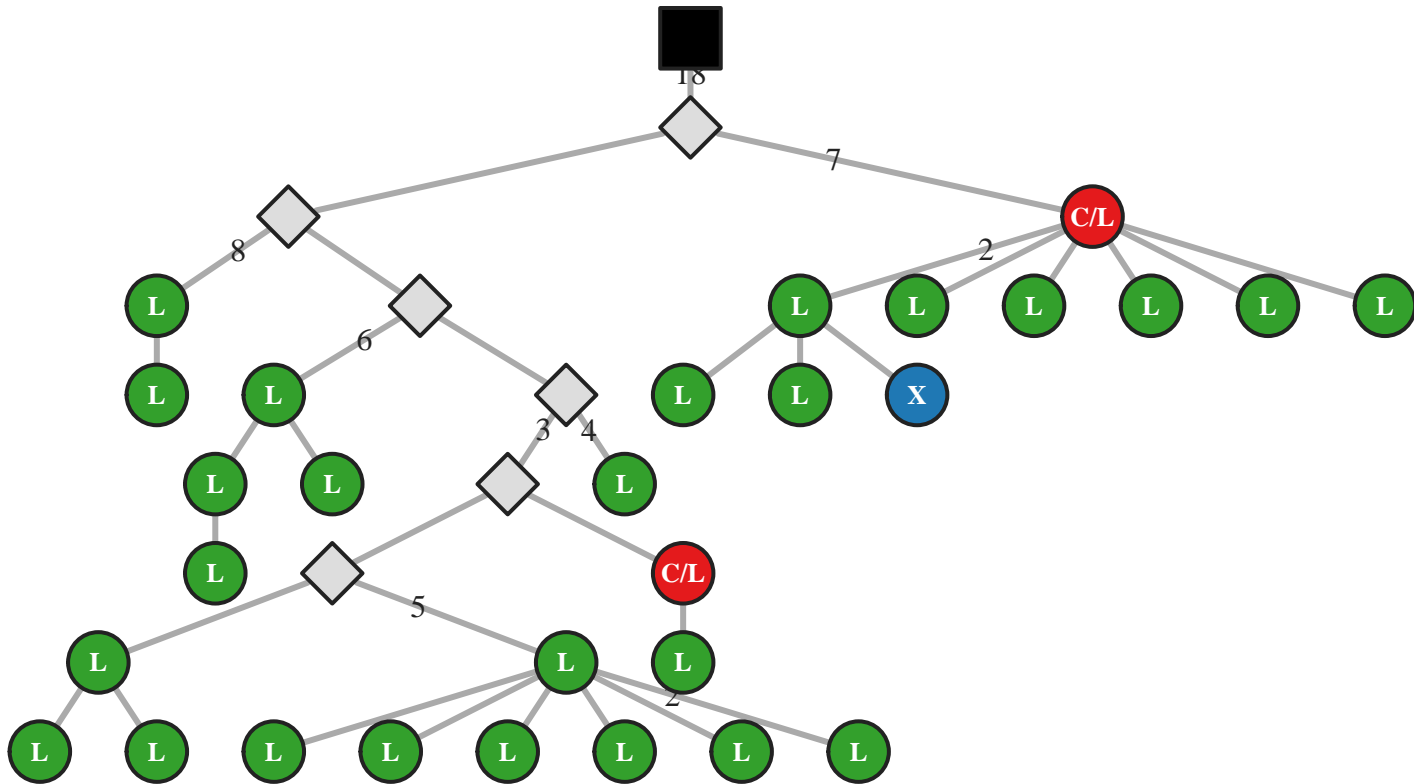

M5 IgG IGHV1-69/J6 66bp (50434)

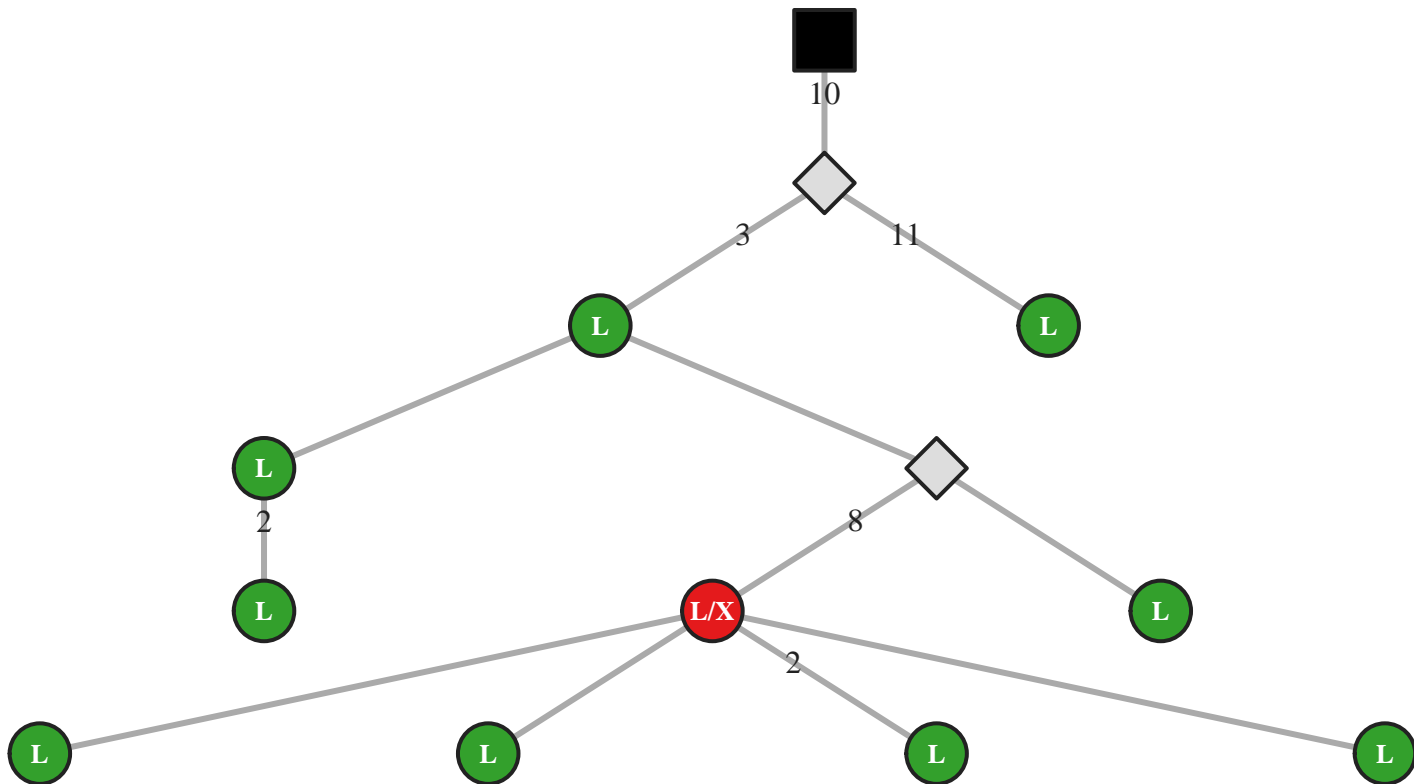

M5 IgG IGHV1-69/J6 69bp (42190)

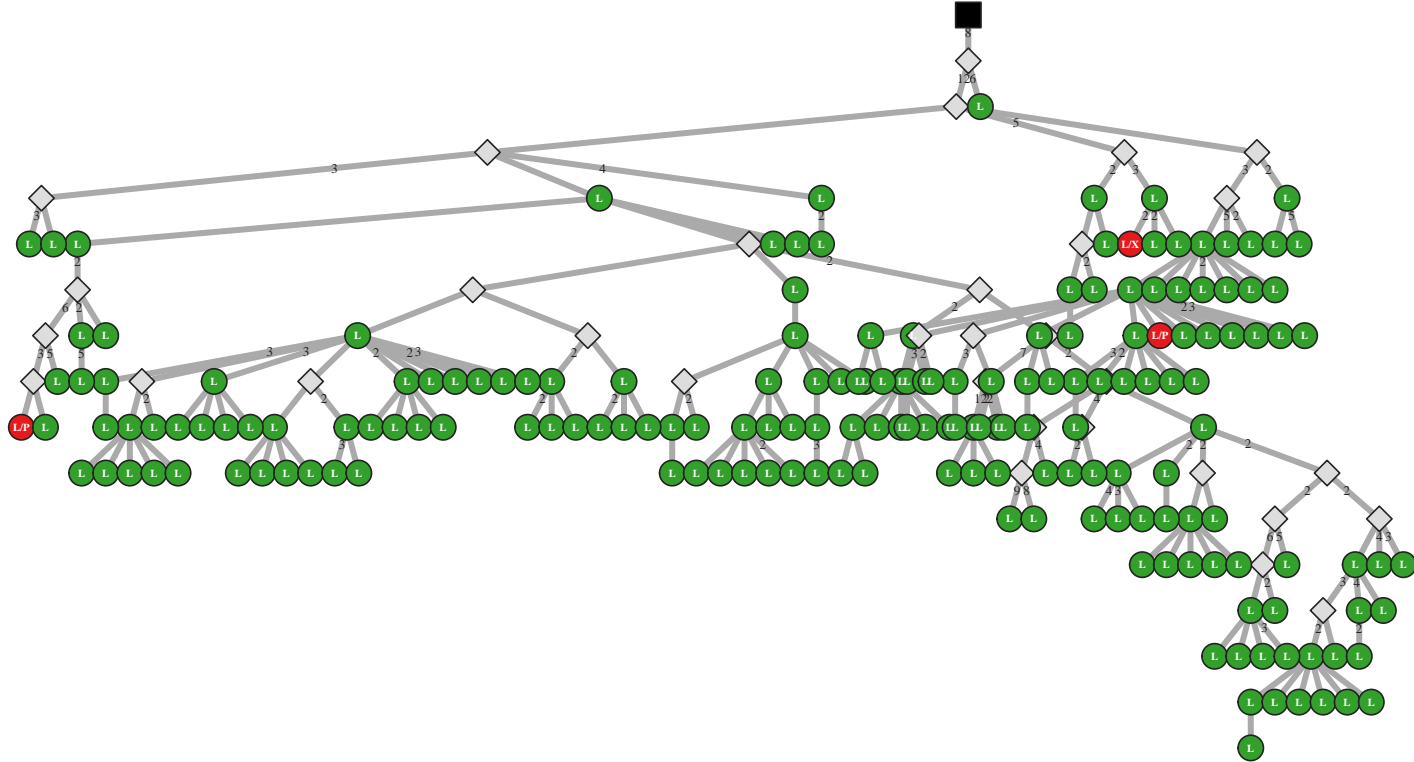

M5 IgG IGHV1-69/J6 69bp (42246)

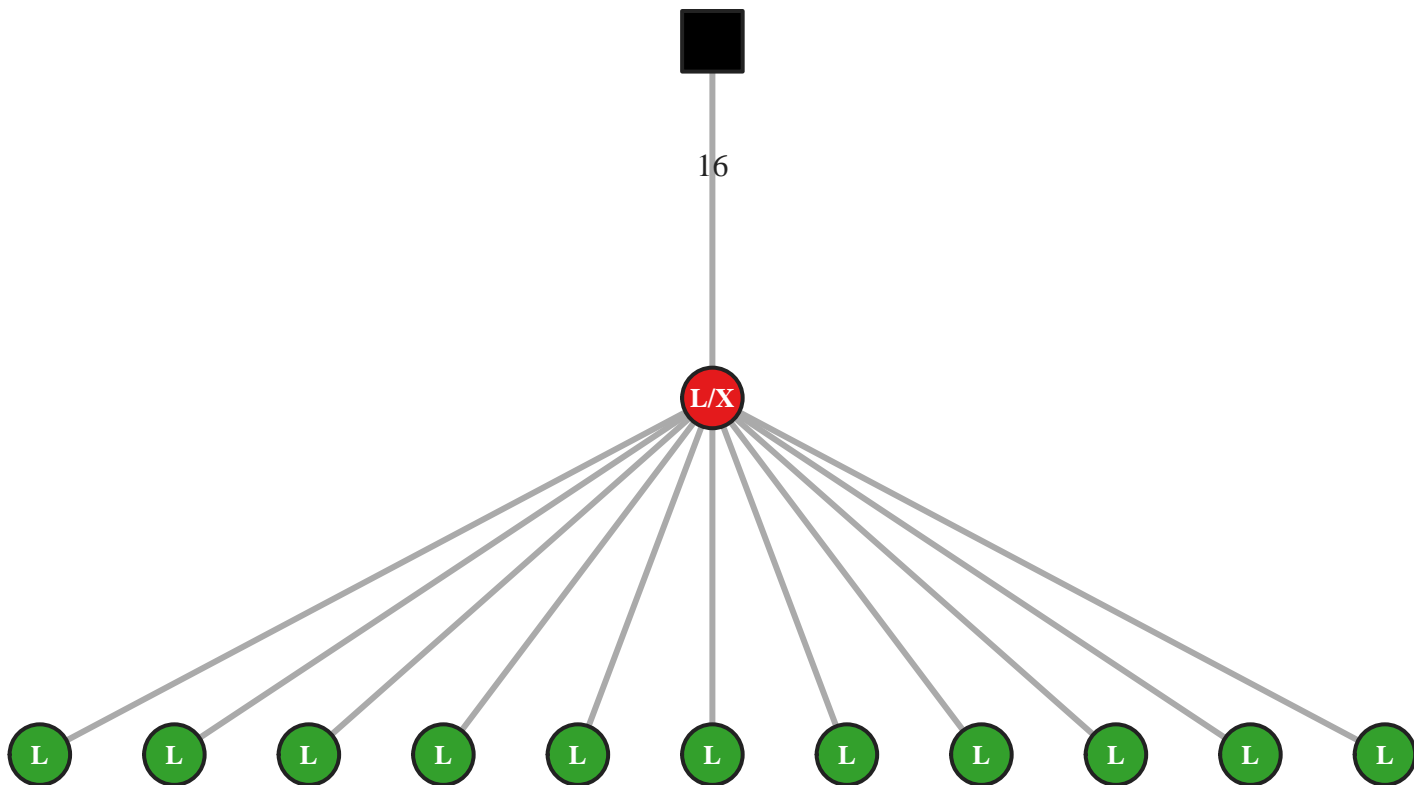

M5 IgG IGHV1-69/J6 72bp (42300)

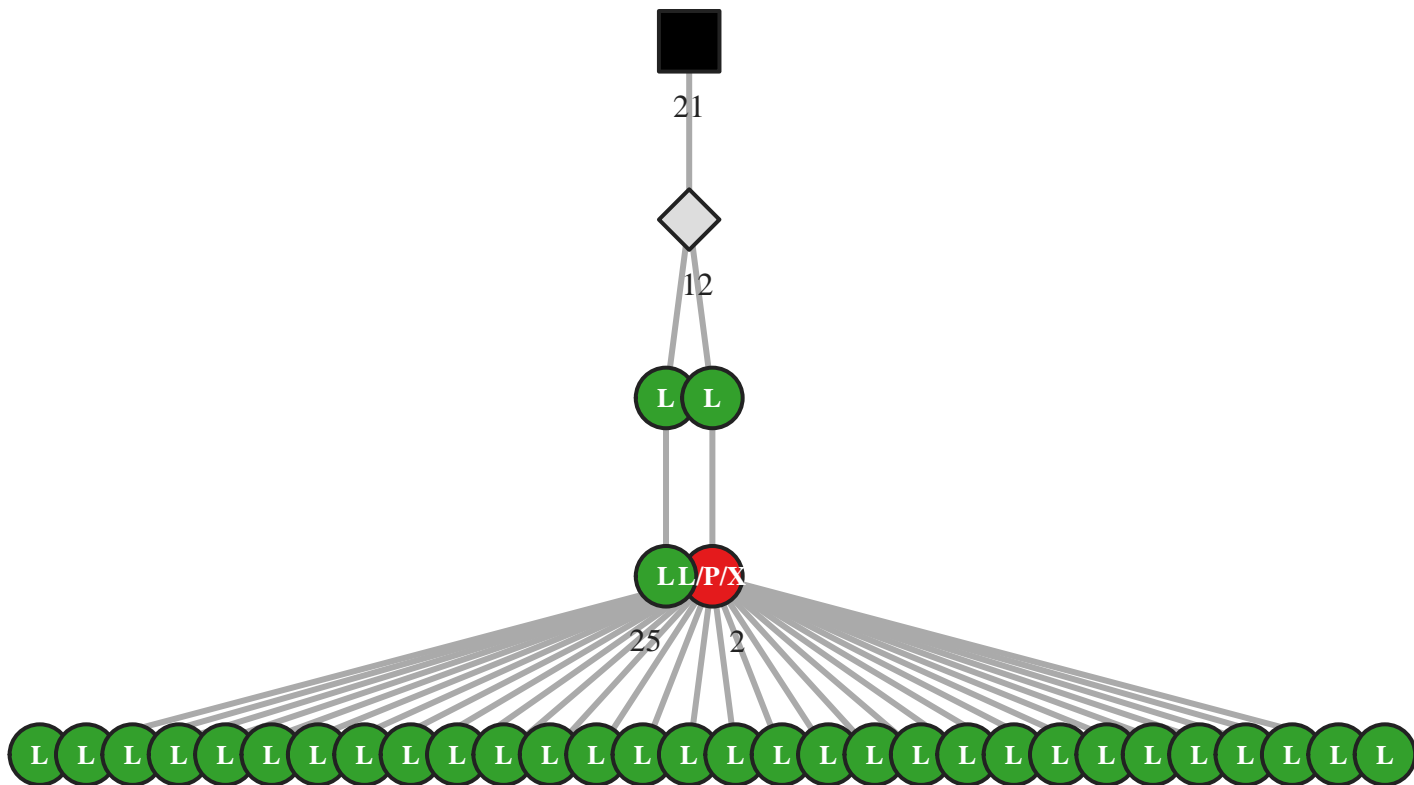

M5 IgG IGHV1-69/J6 72bp (42362)

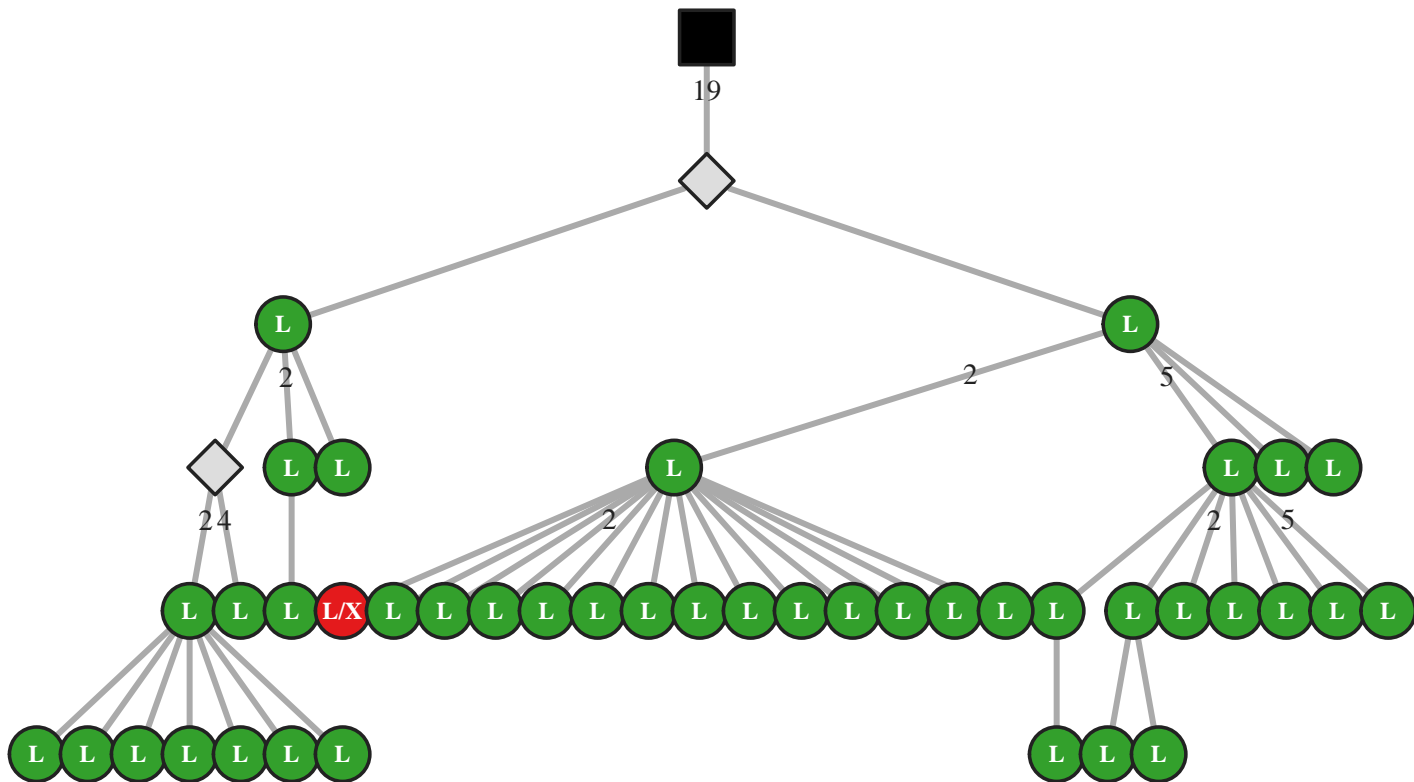

M5 IgG IGHV1-69/J6 75bp (33004)

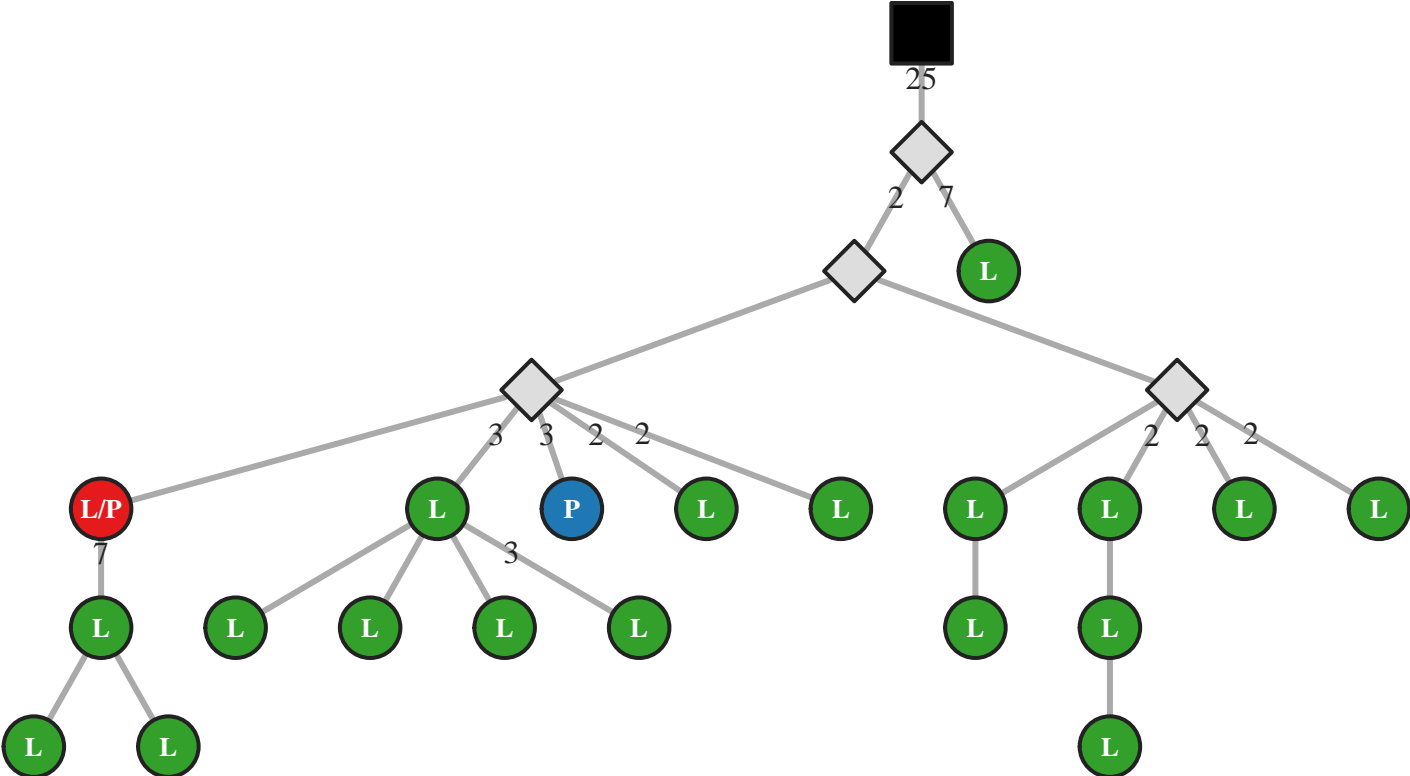

M5 IgG IGHV1-69/J6 75bp (33009)

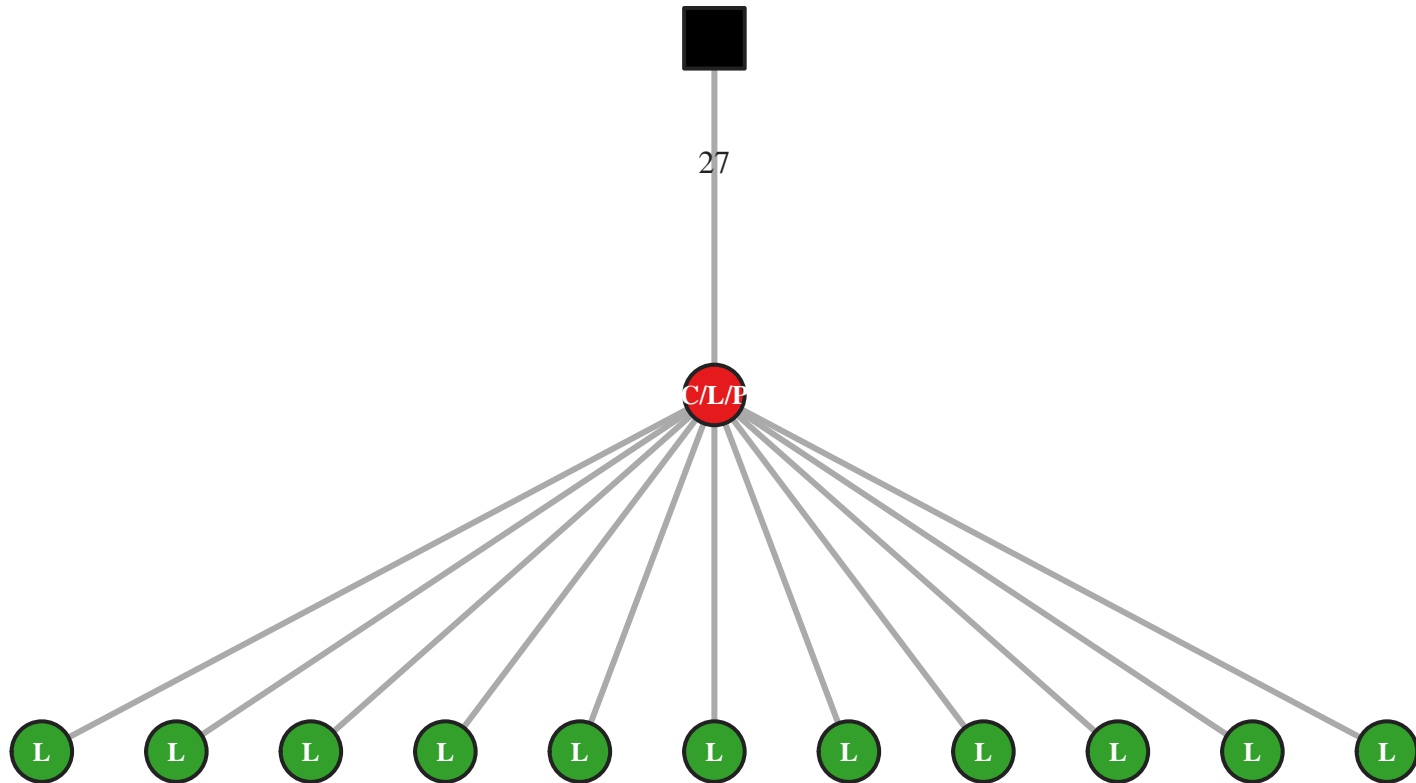

M5 IgG IGHV1-69/J6 75bp (33048)

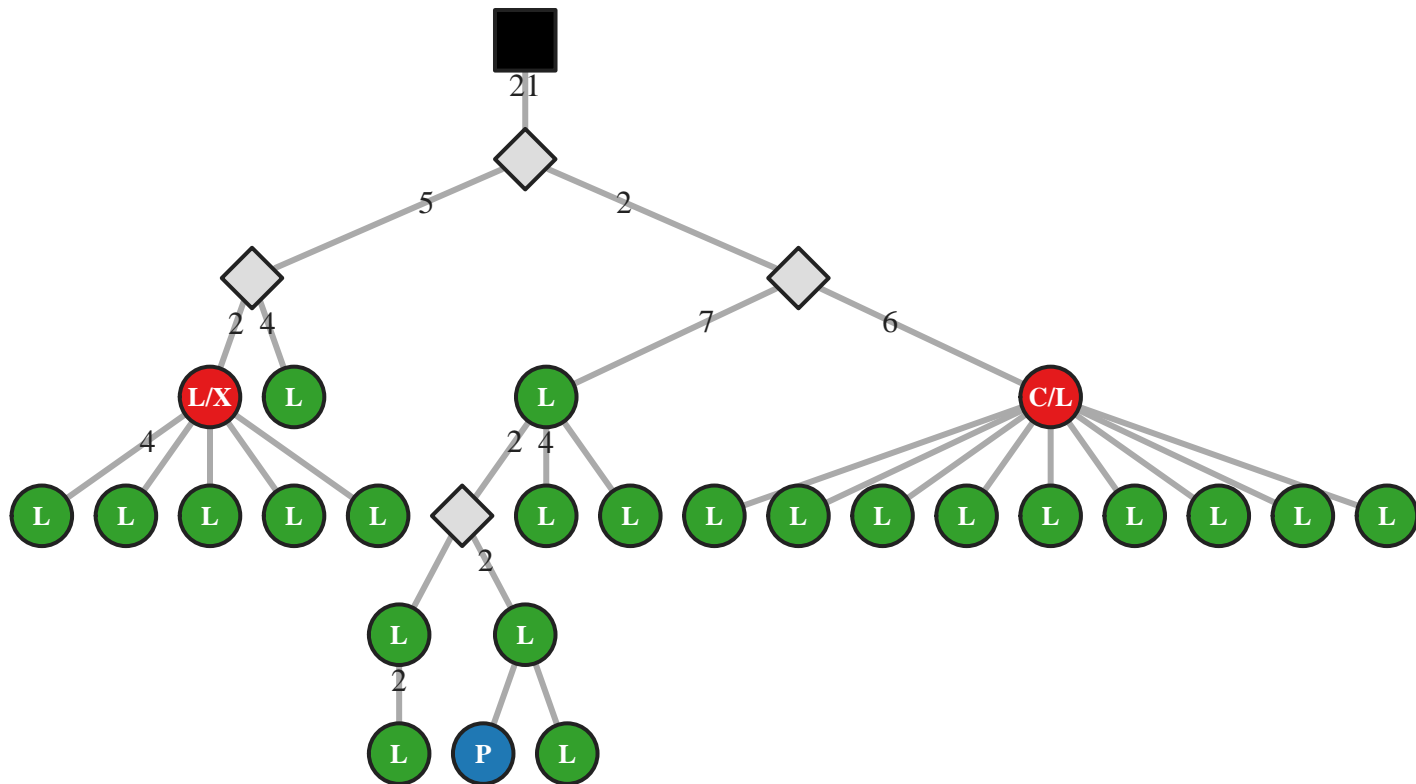

M5 IgG IGHV1-69/J6 81bp (5432)

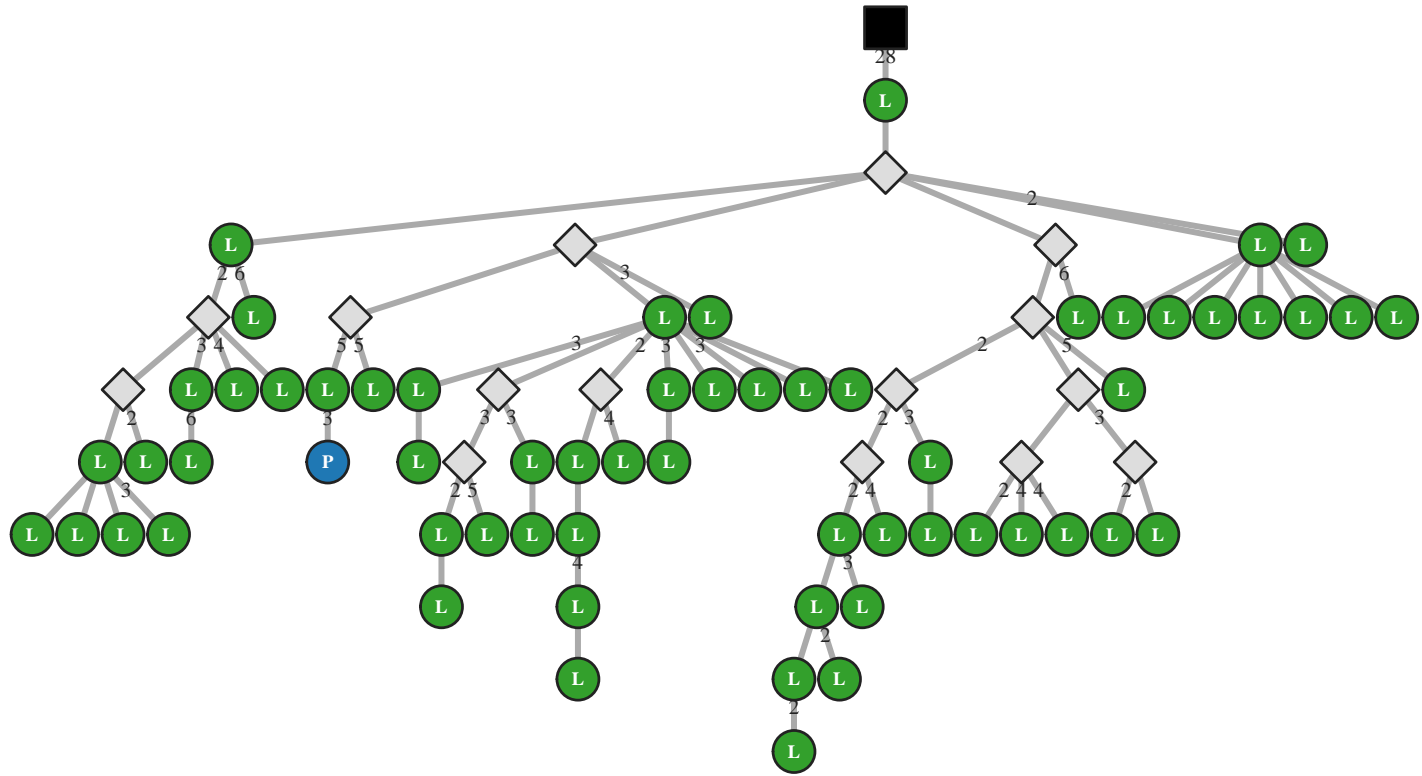

M5 IgG IGHV1-8/J1 24bp (15028)

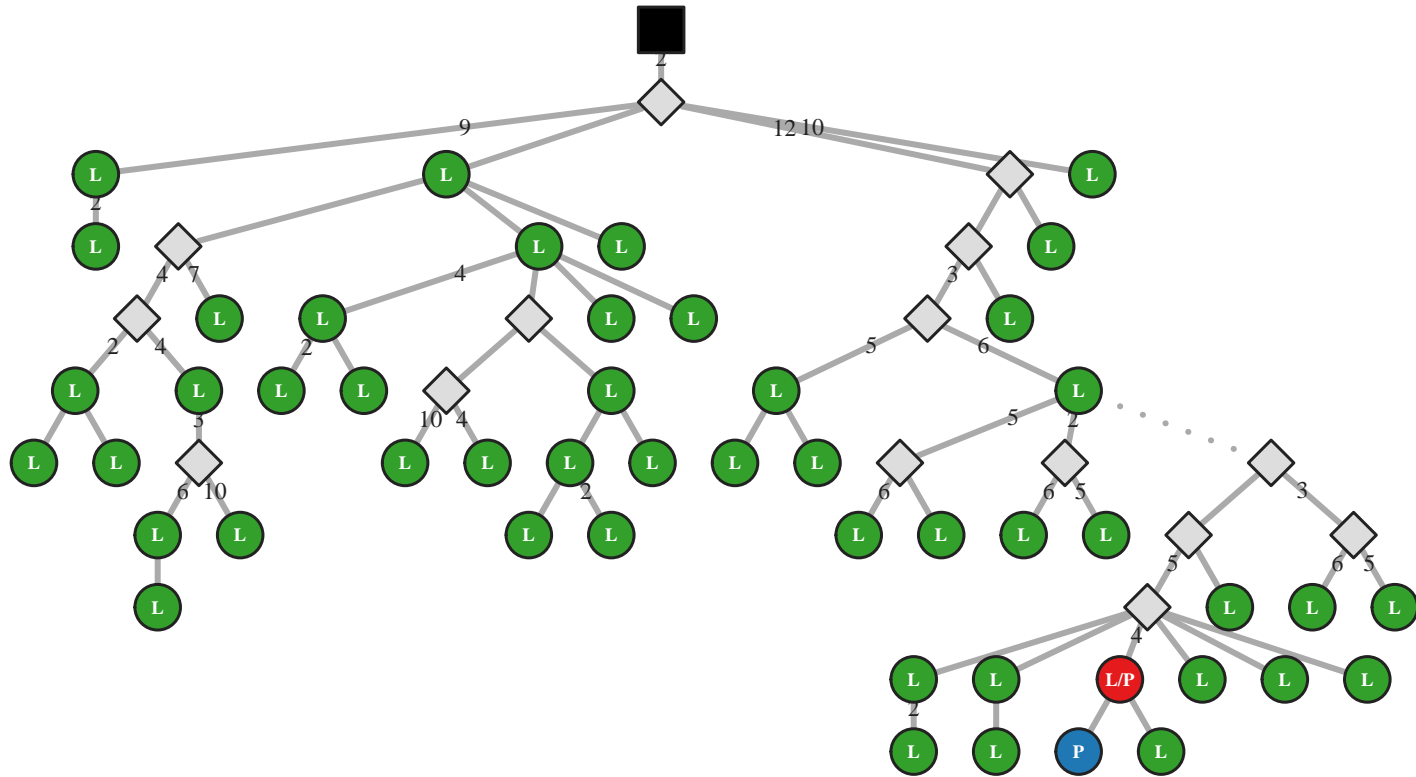

M5 IgG IGHV1-8/J3 33bp (33057)

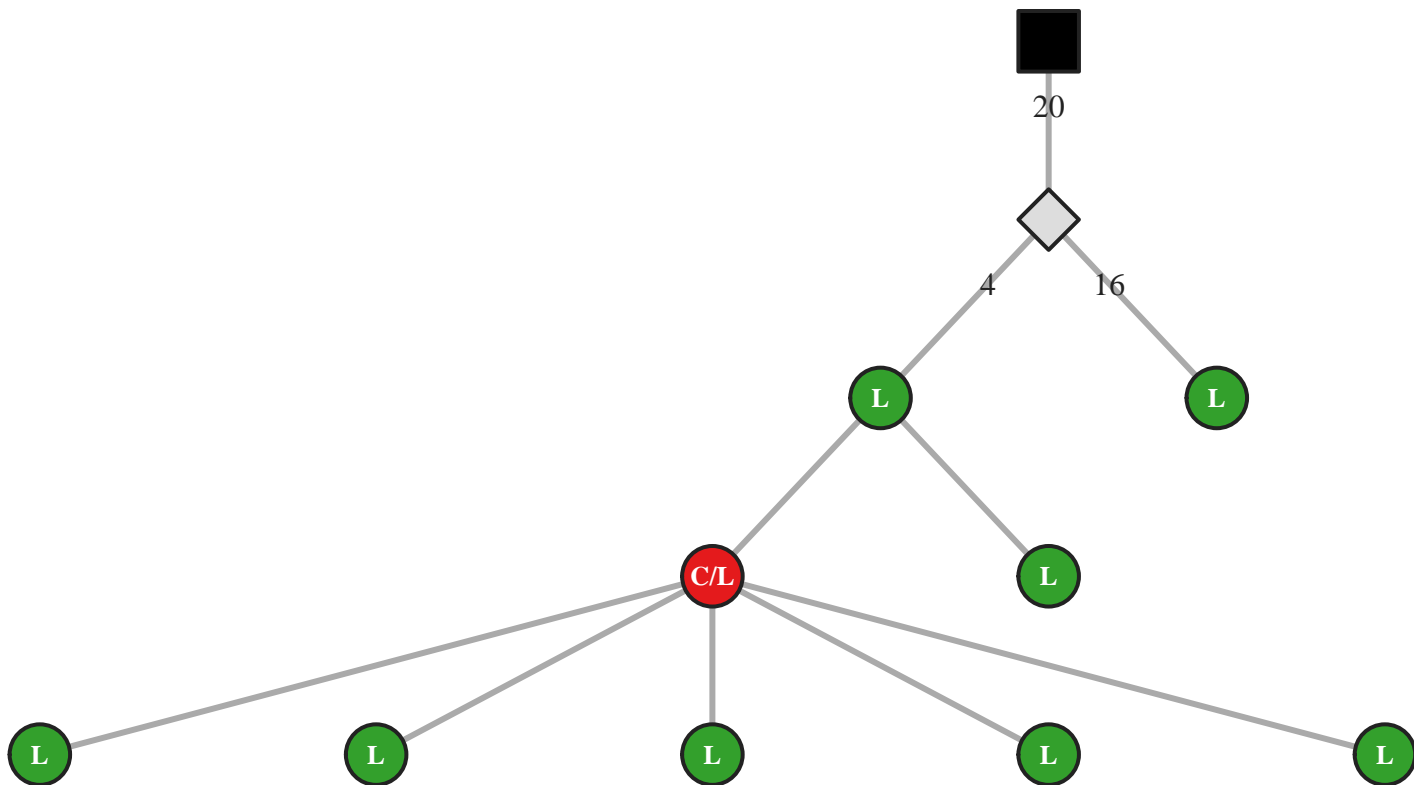

M5 IgG IGHV1-8/J3 42bp (24292)

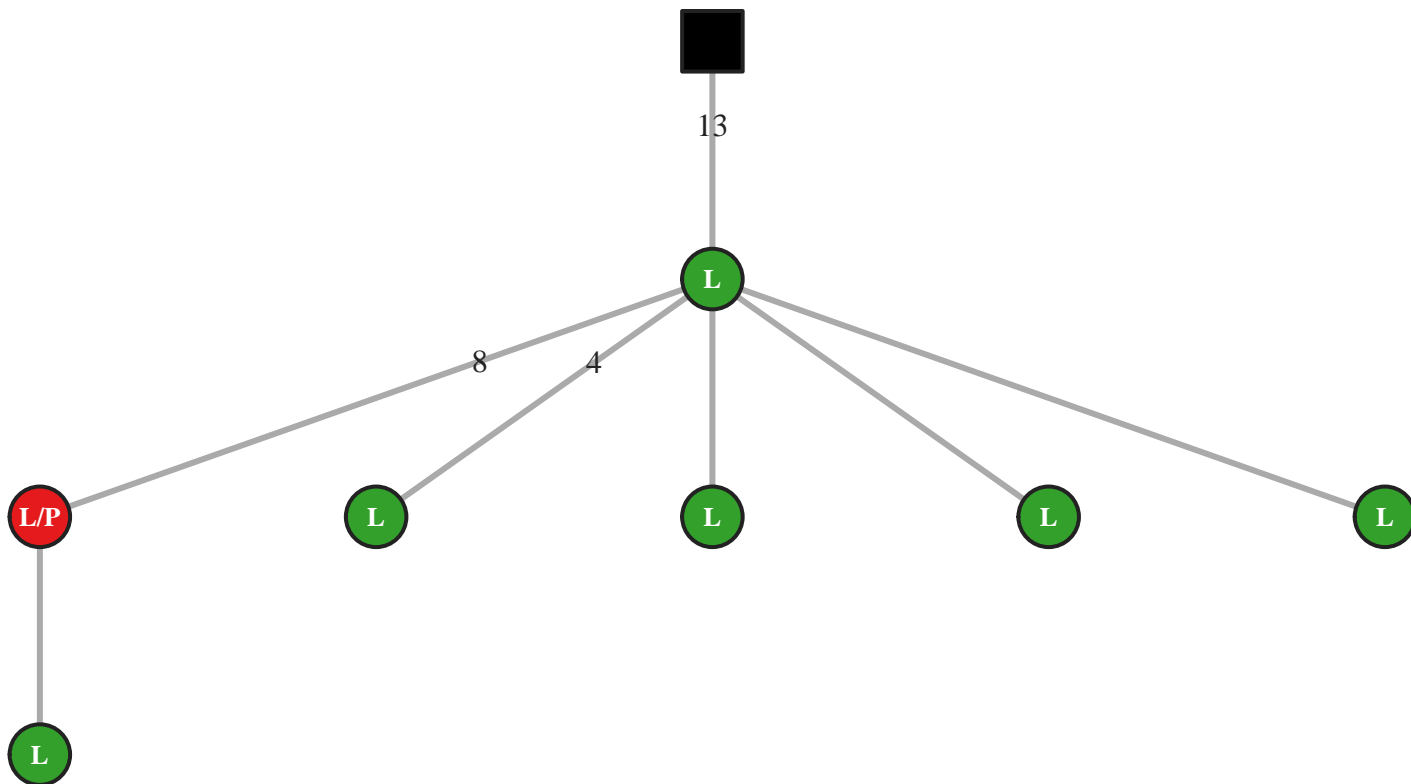

M5 IgA IGHV1-8/J3 60bp (30275)

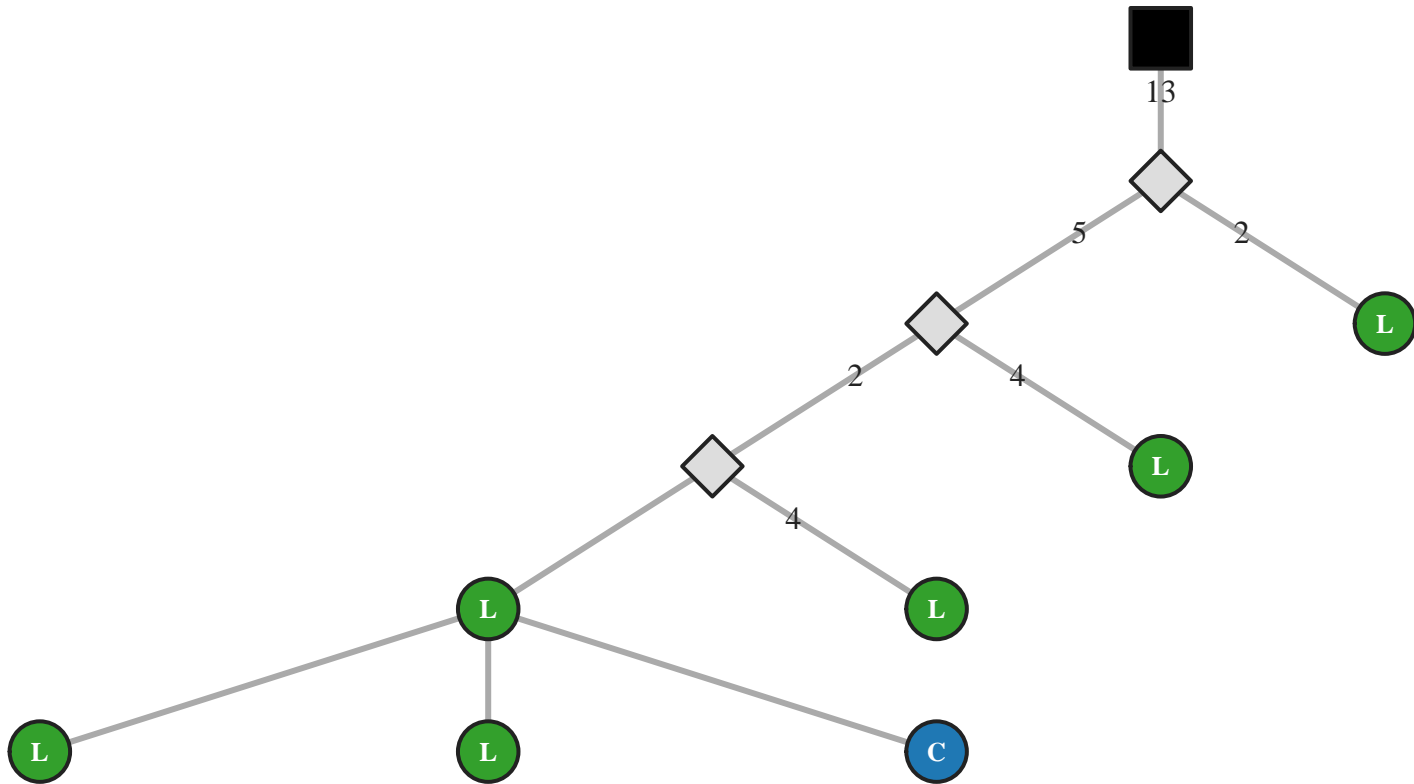

M5 IgG IGHV1-8/J4 24bp (15025)

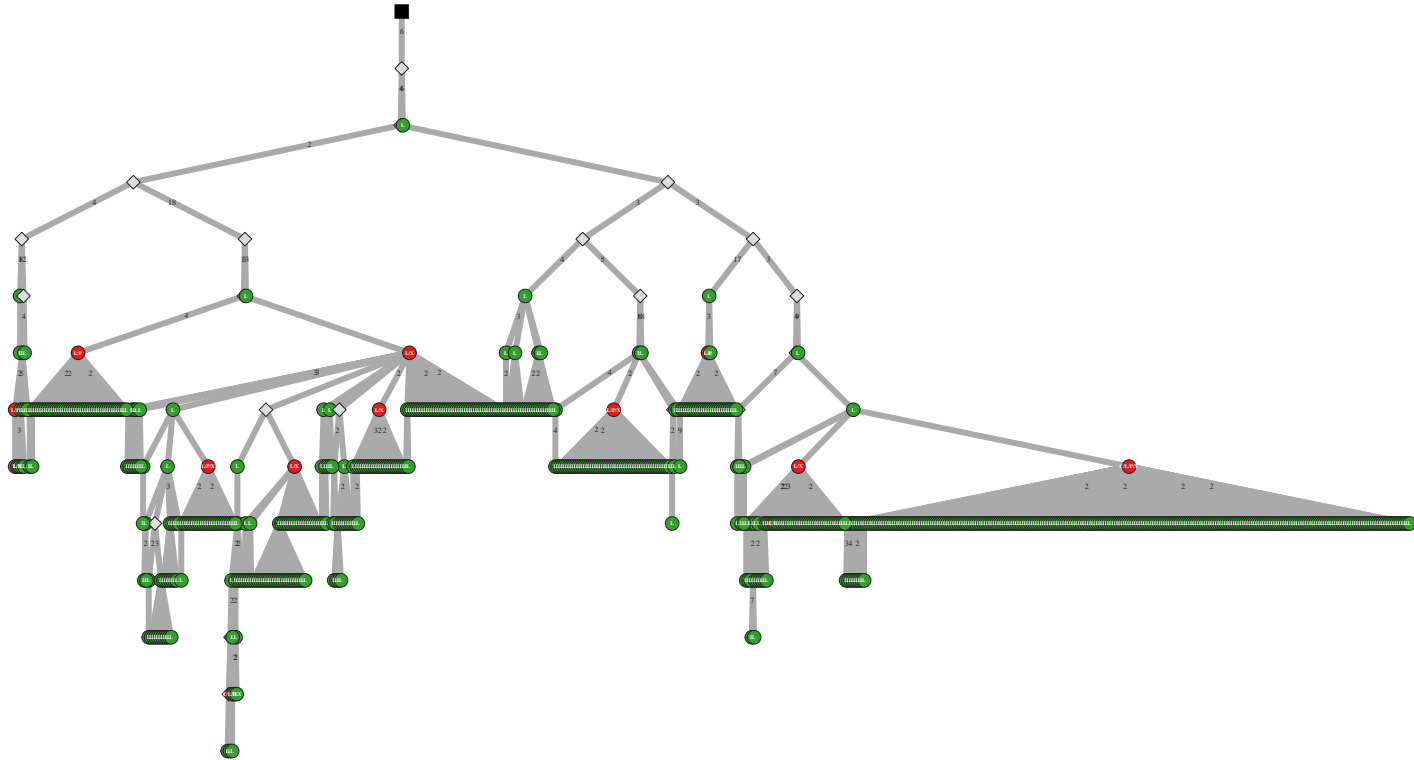

M5 IgG IGHV1-8/J4 27bp (24312)

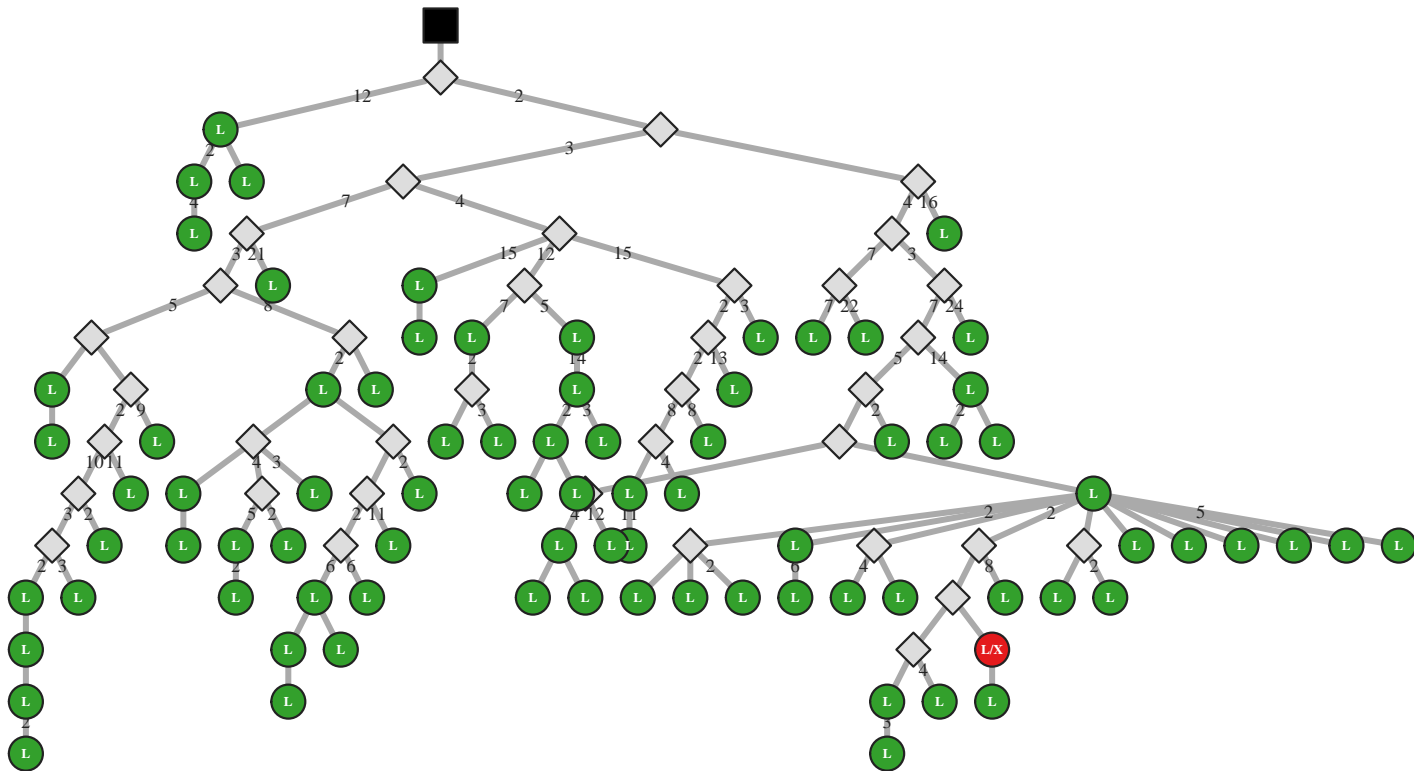

M5 IgG IGHV1-8/J4 30bp (15037)

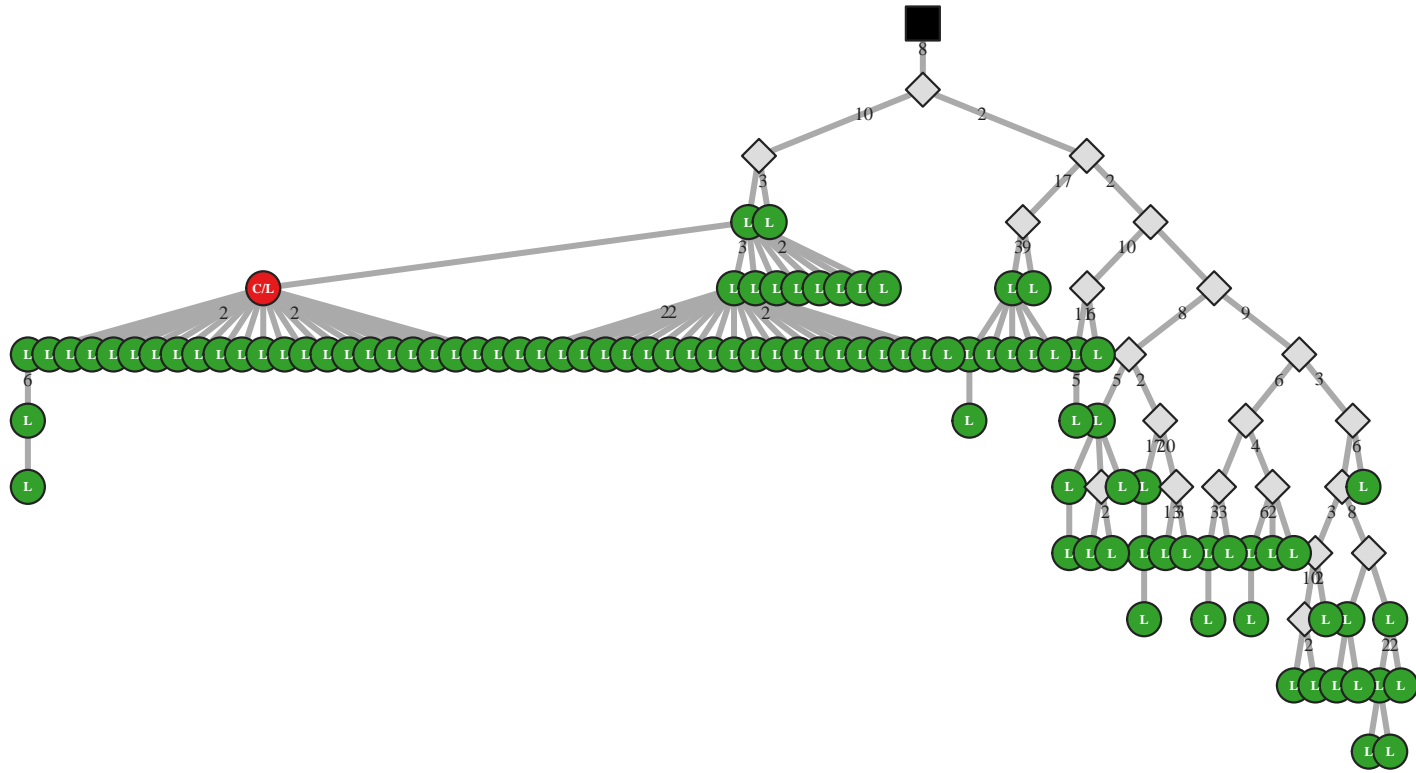

M5 IgG IGHV1-8/J4 42bp (33099)

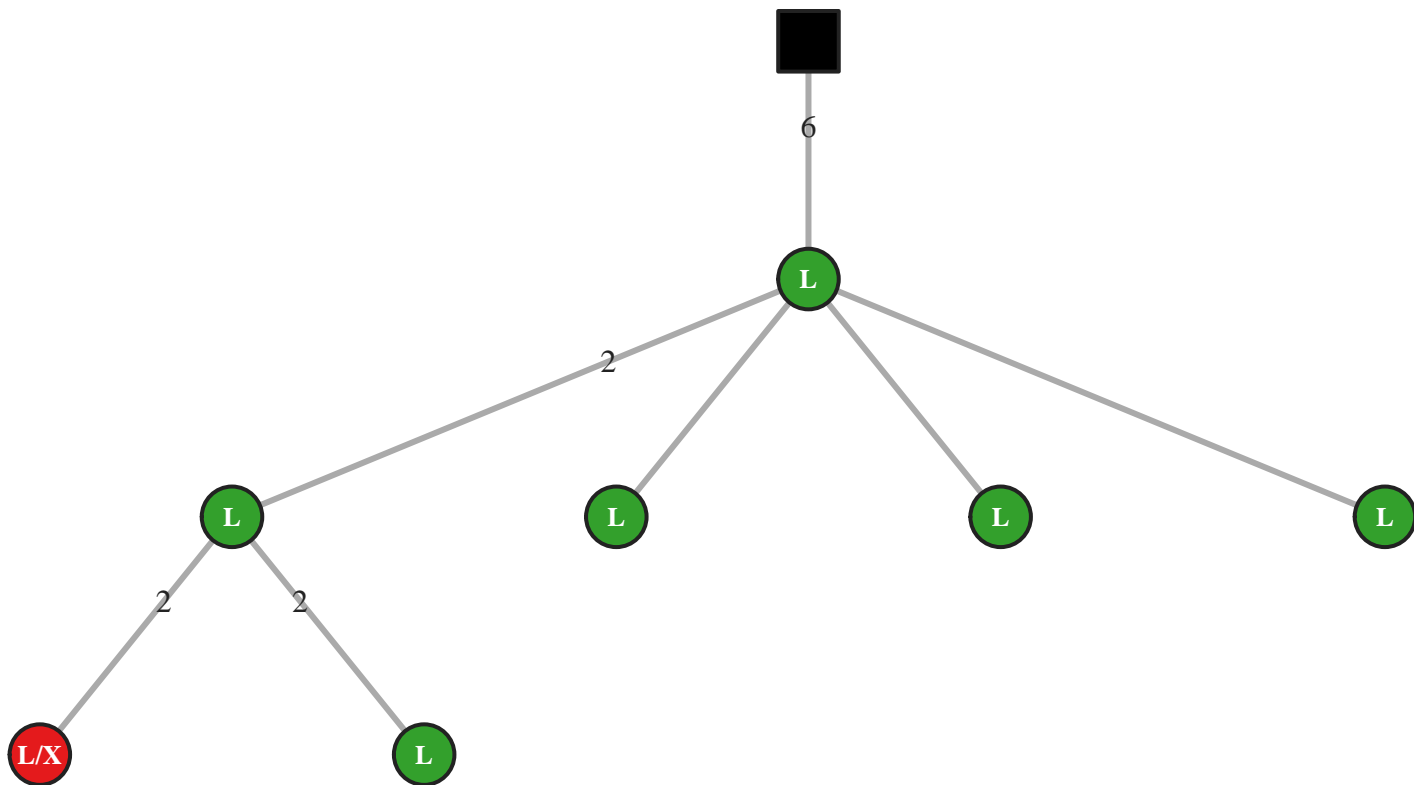

M5 IgG IGHV1-8/J4 45bp (33142)

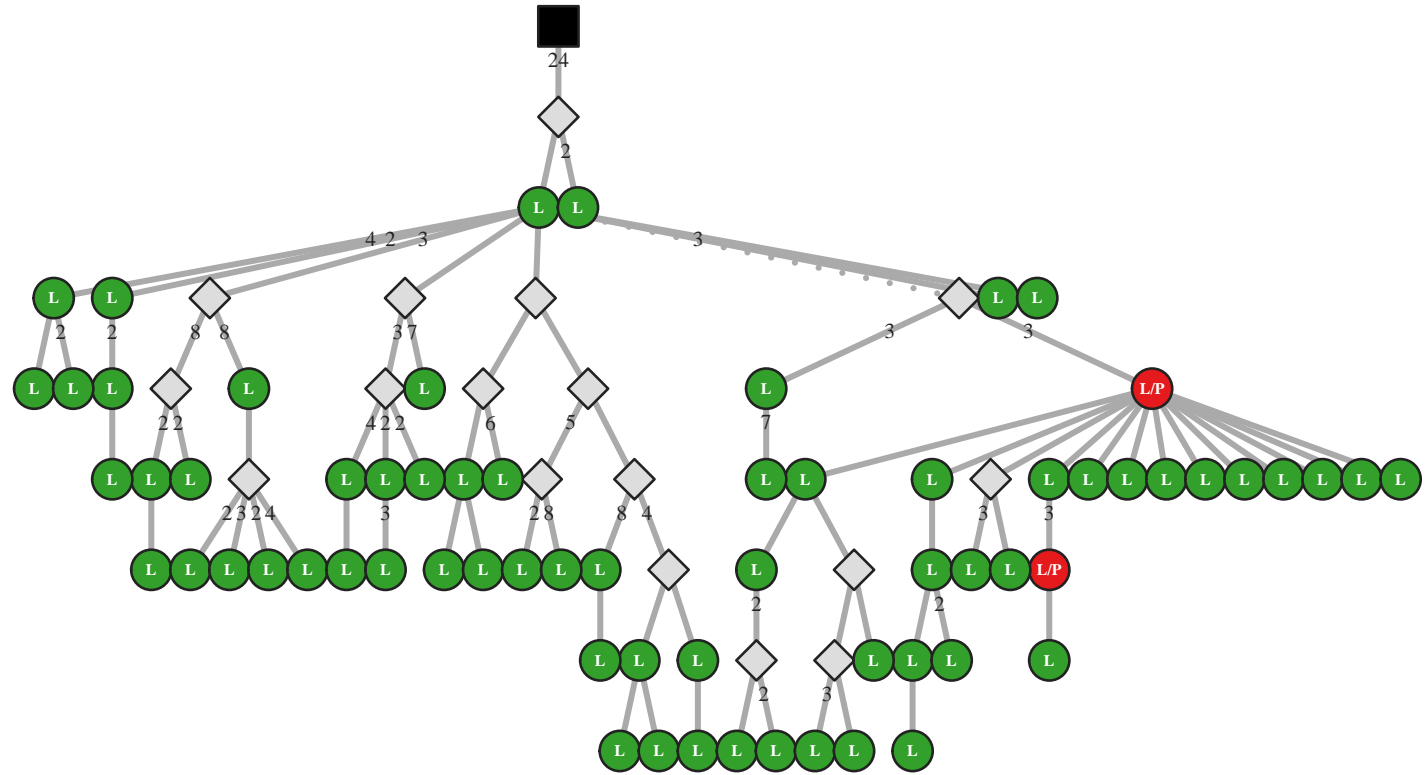

M5 IgG IGHV1-8/J4 45bp (33168)

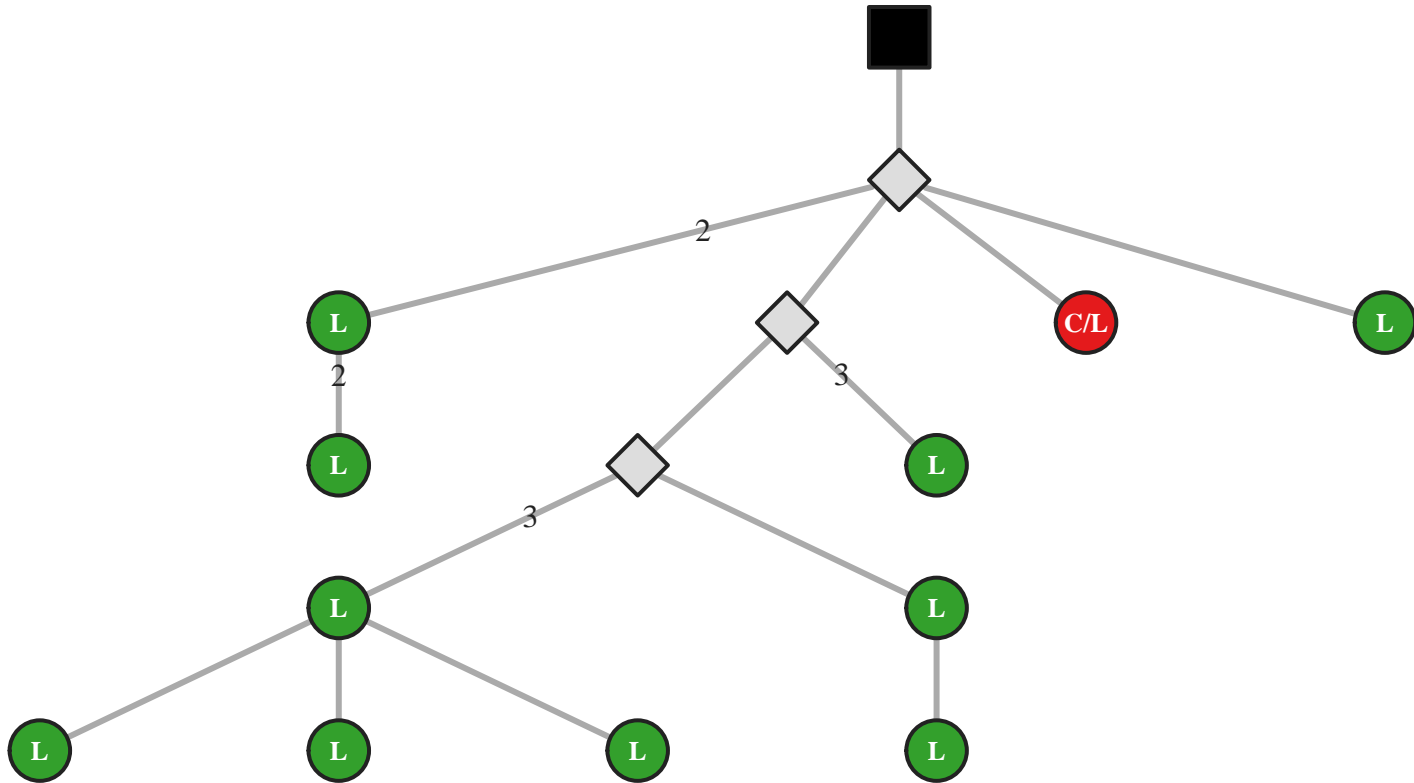

M5 IgG IGHV1-8/J4 48bp (24321)

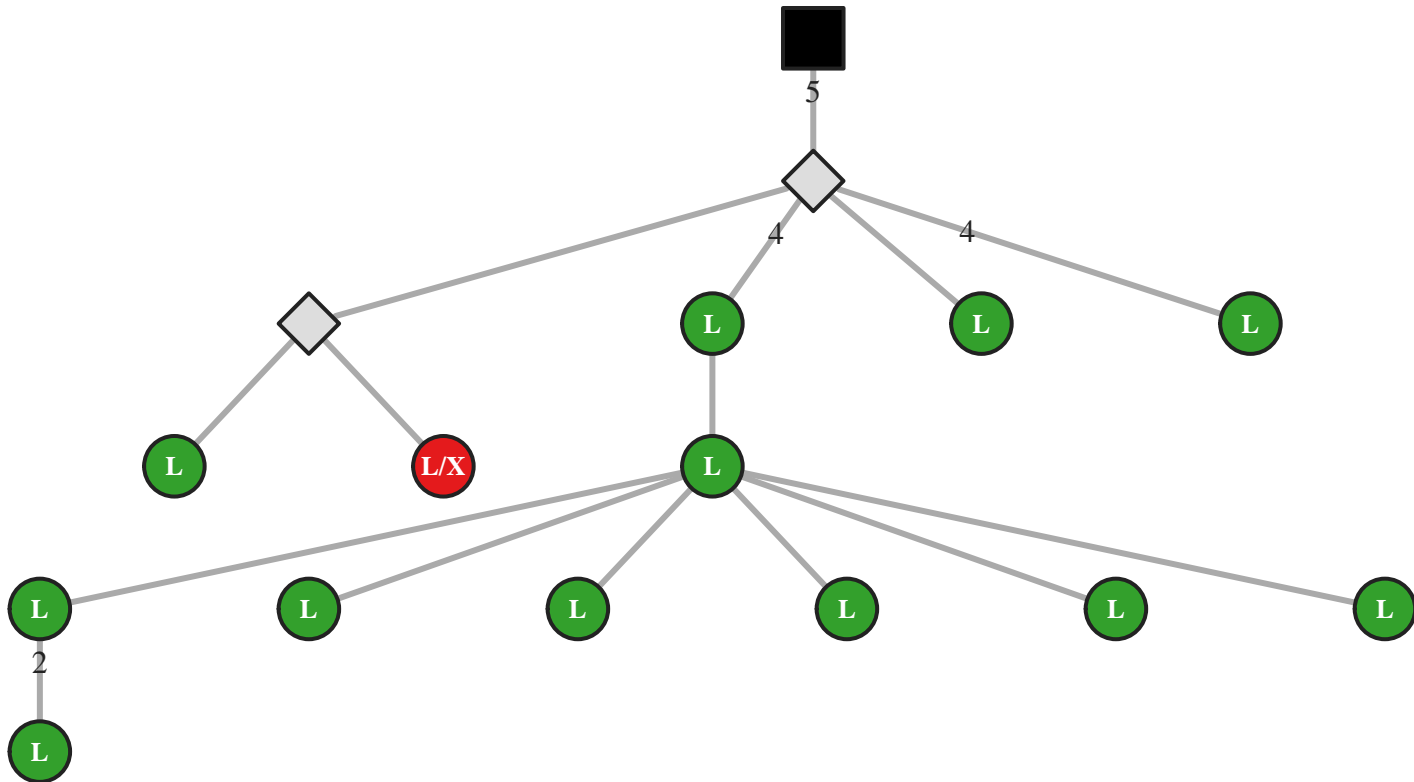

M5 IgG IGHV1-8/J4 48bp (24353)

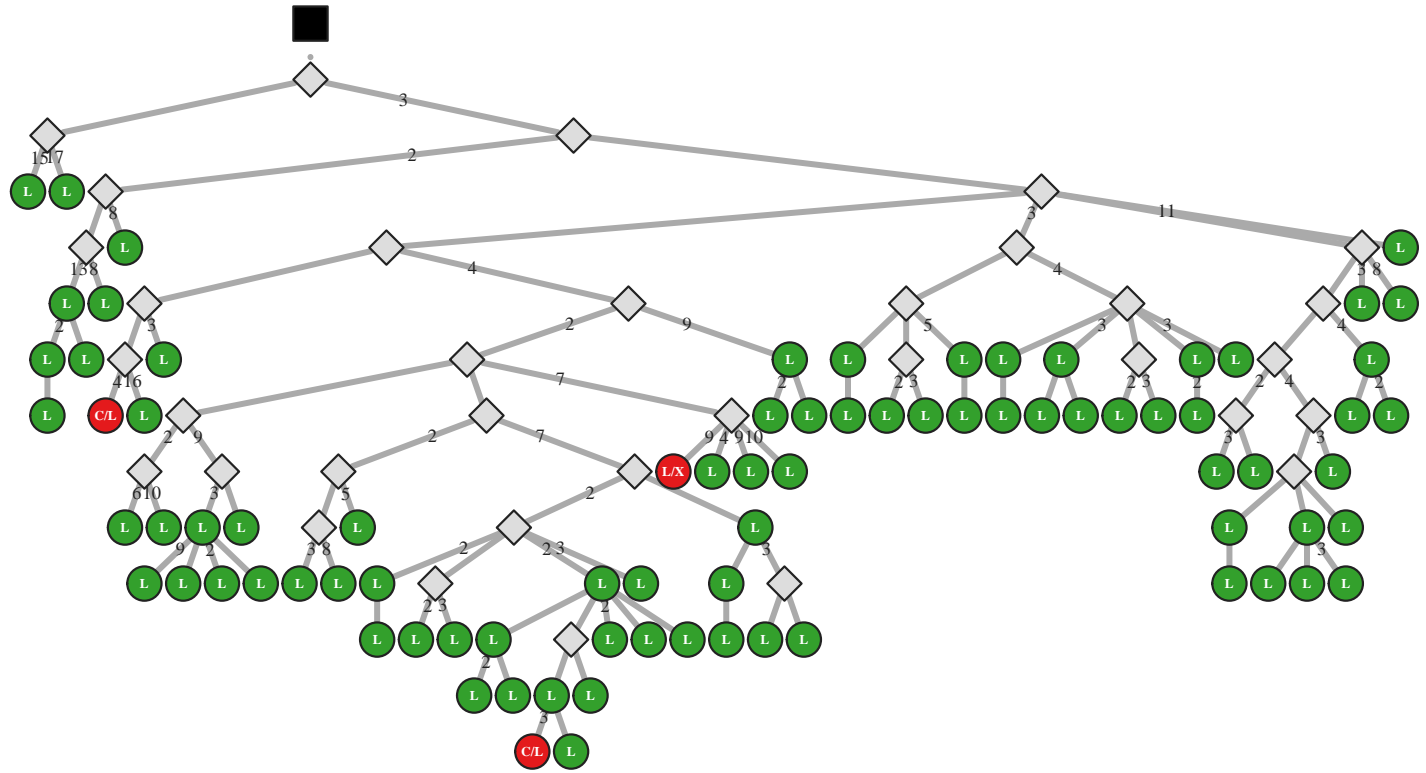

M5 IgG IGHV1-8/J4 48bp (24359)

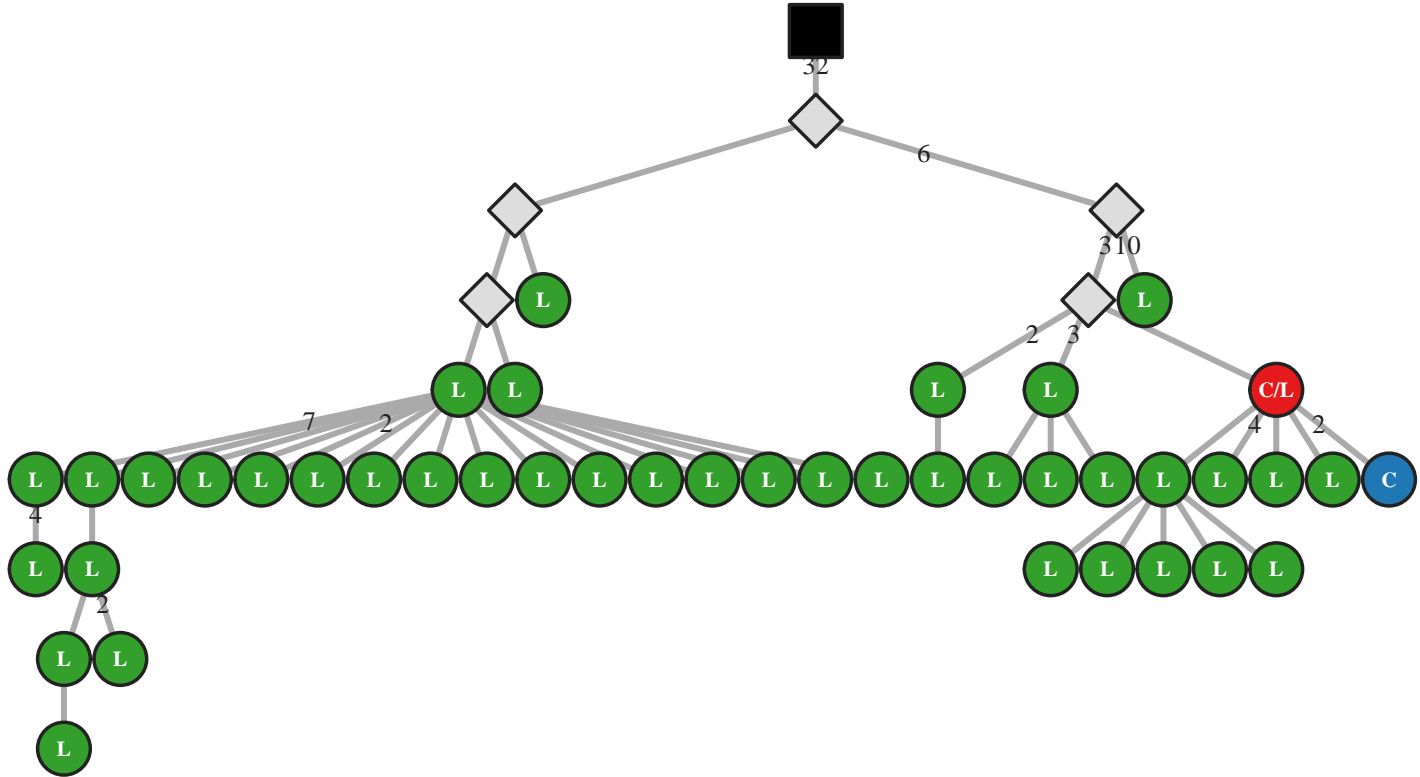

M5 IgG IGHV1-8/J4 51bp (33199)

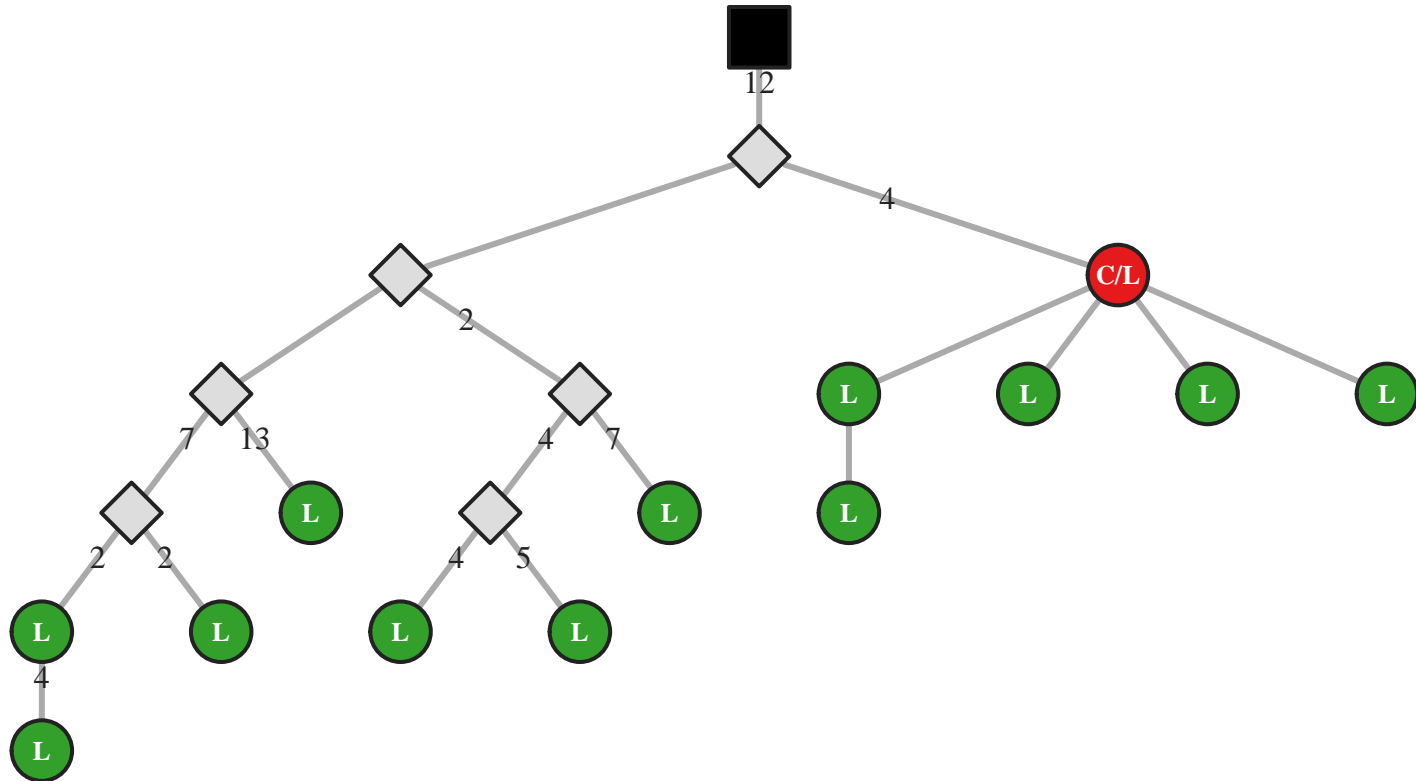

M5 IgG IGHV1-8/J4 51bp (33201)

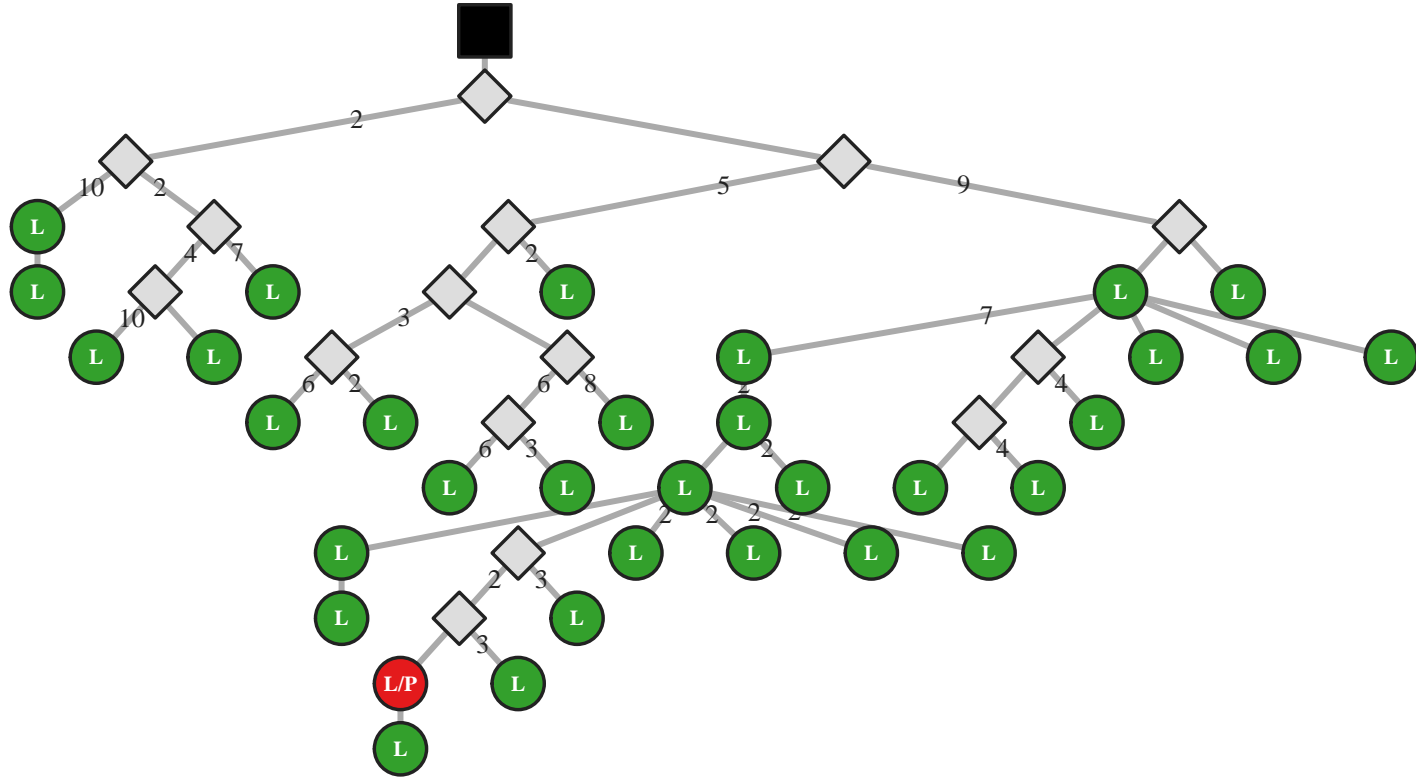

M5 IgG IGHV1-8/J4 63bp (33215)

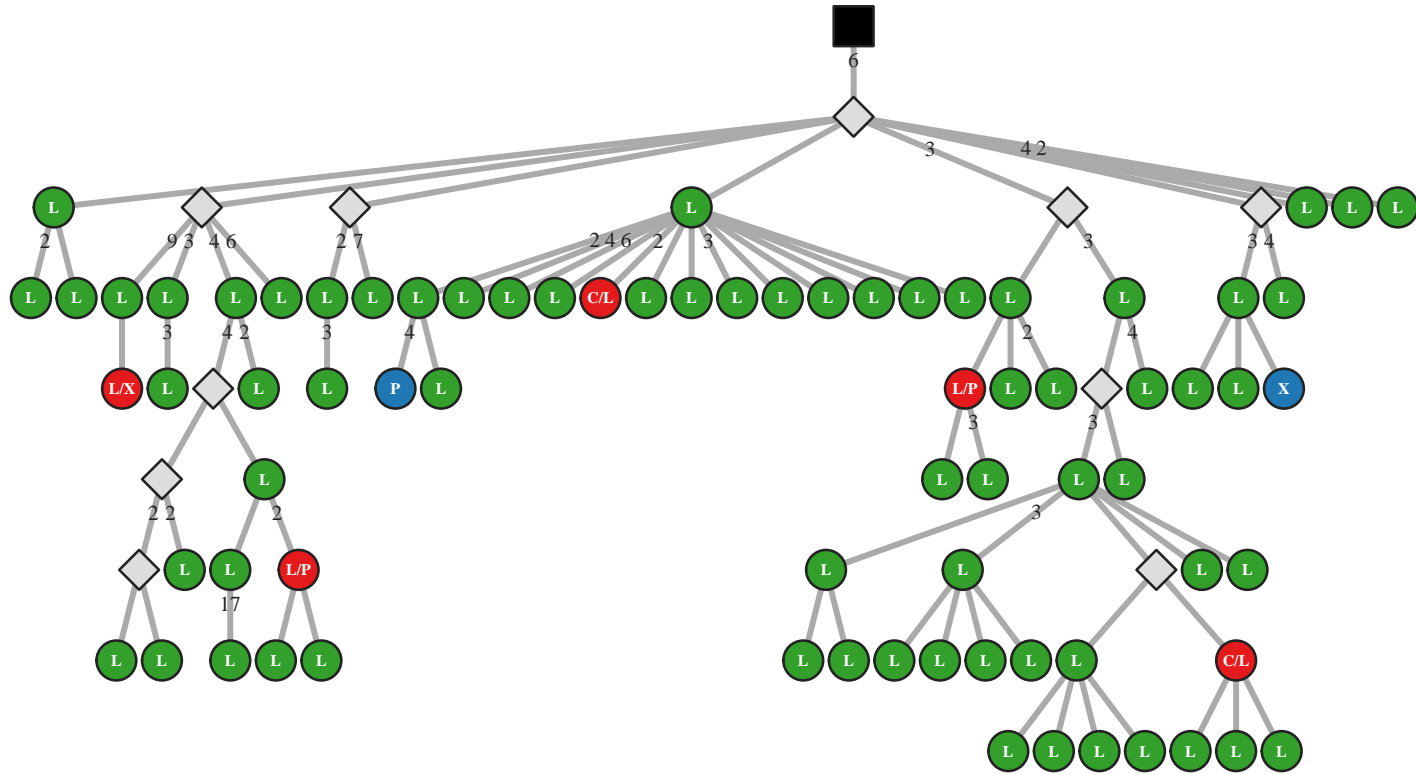

M5 IgG IGHV1-8/J4 69bp (42435)

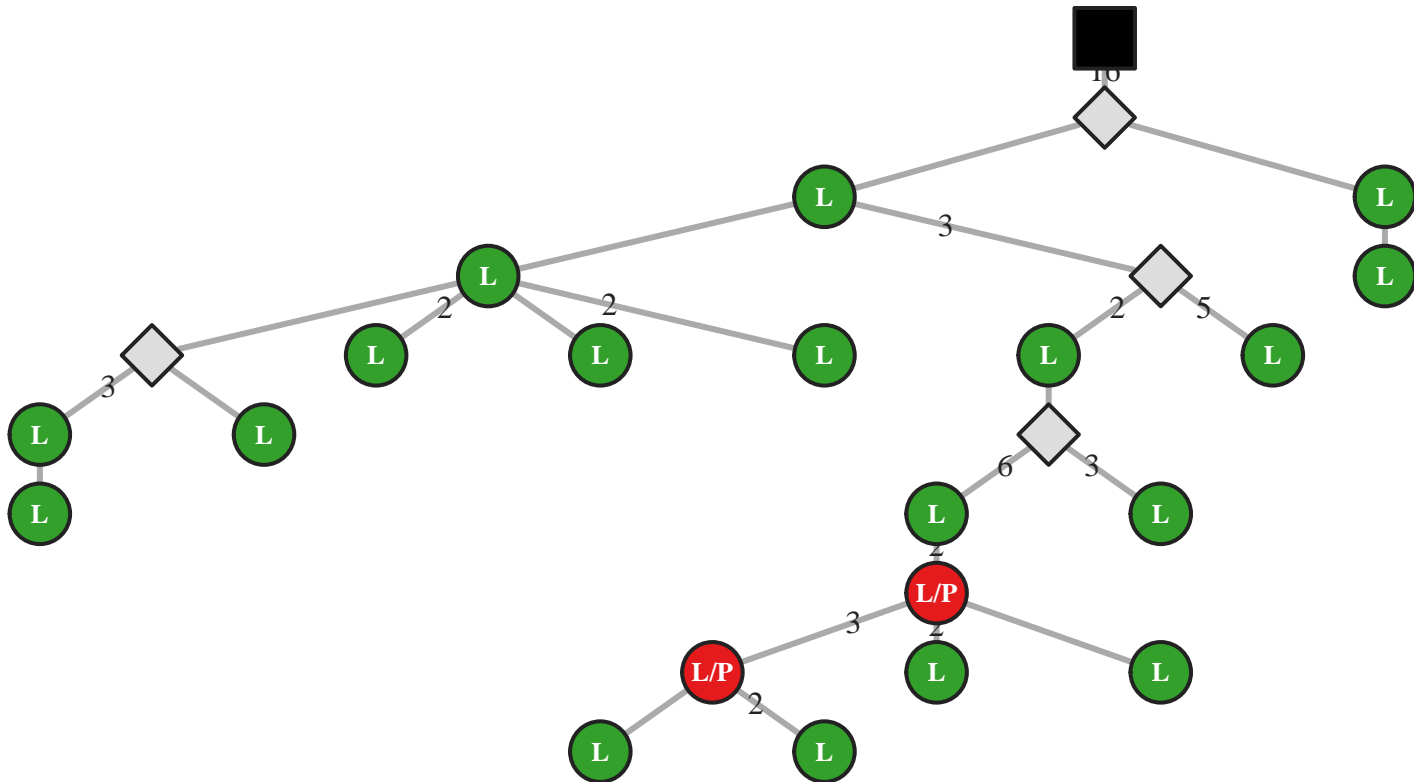

M5 IgG IGHV1-8/J5 45bp (42448)

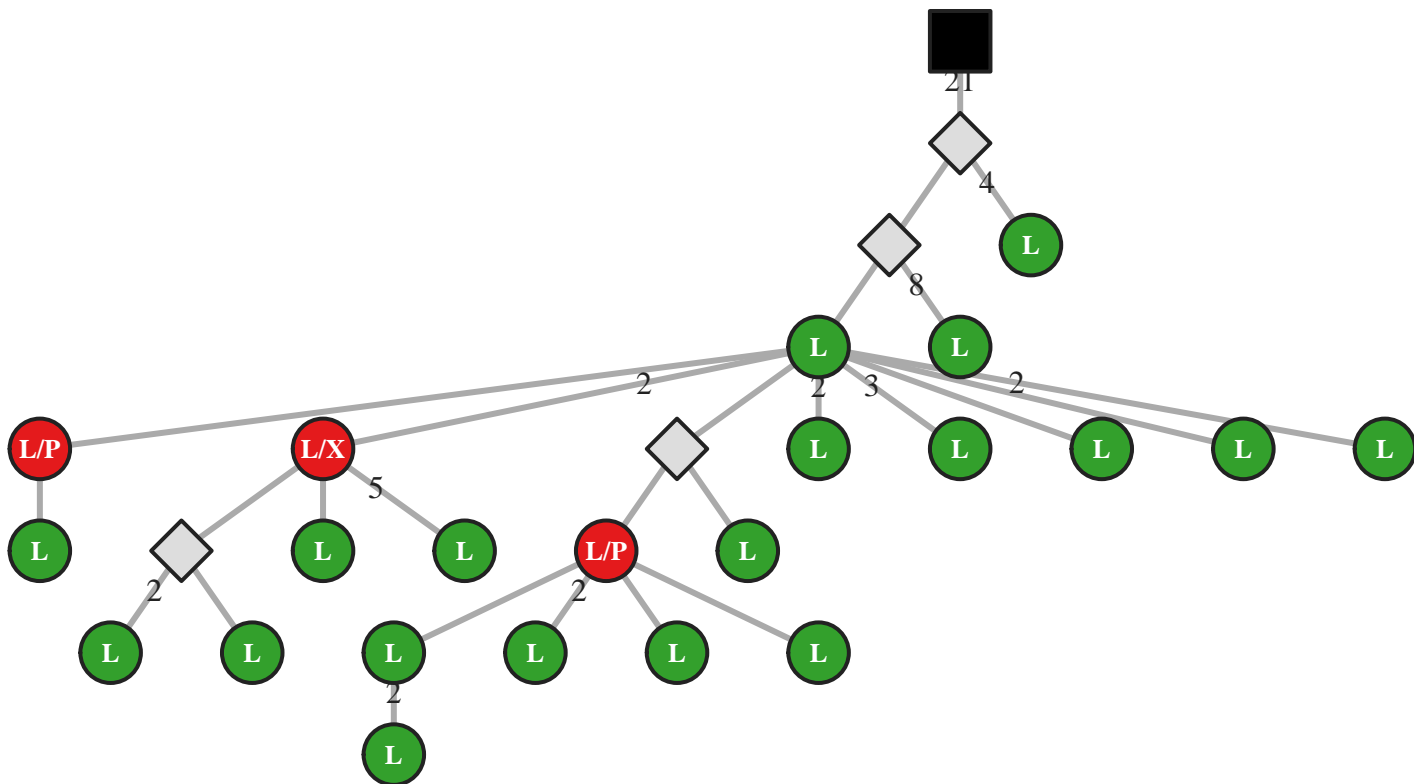

M5 IgG IGHV1-8/J5 66bp (50511)

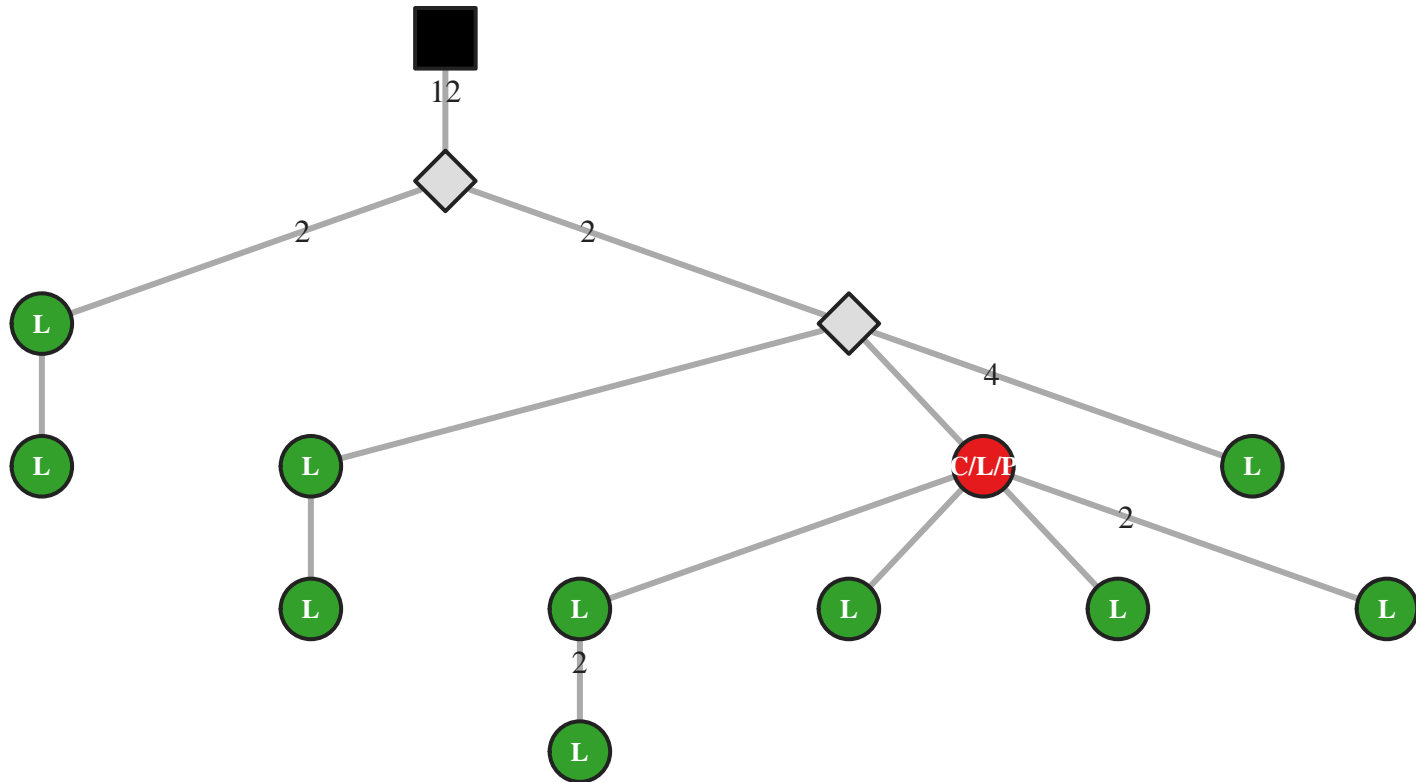

M5 IgG IGHV1-8/J5 72bp (24416)

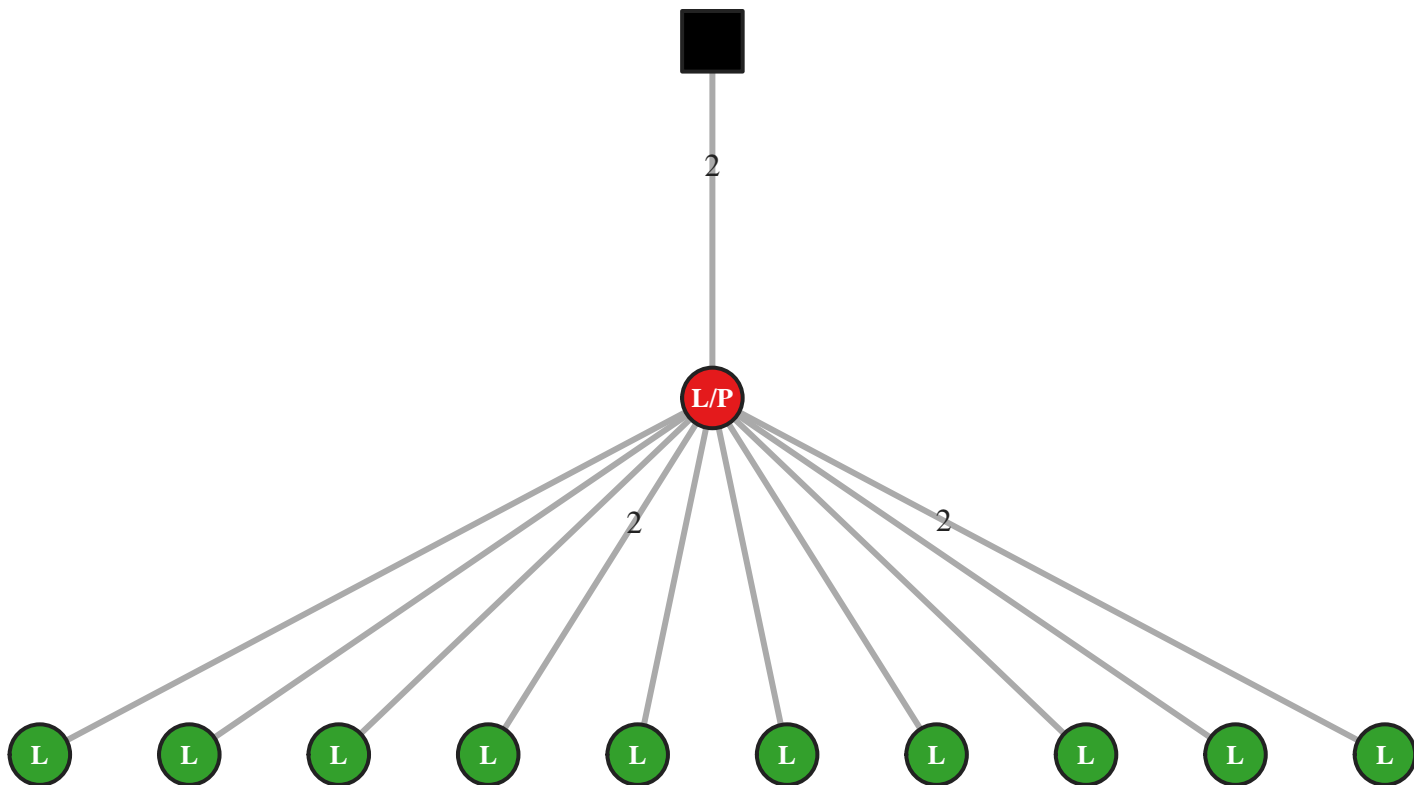

M5 IgG IGHV1-8/J6 45bp (24424)

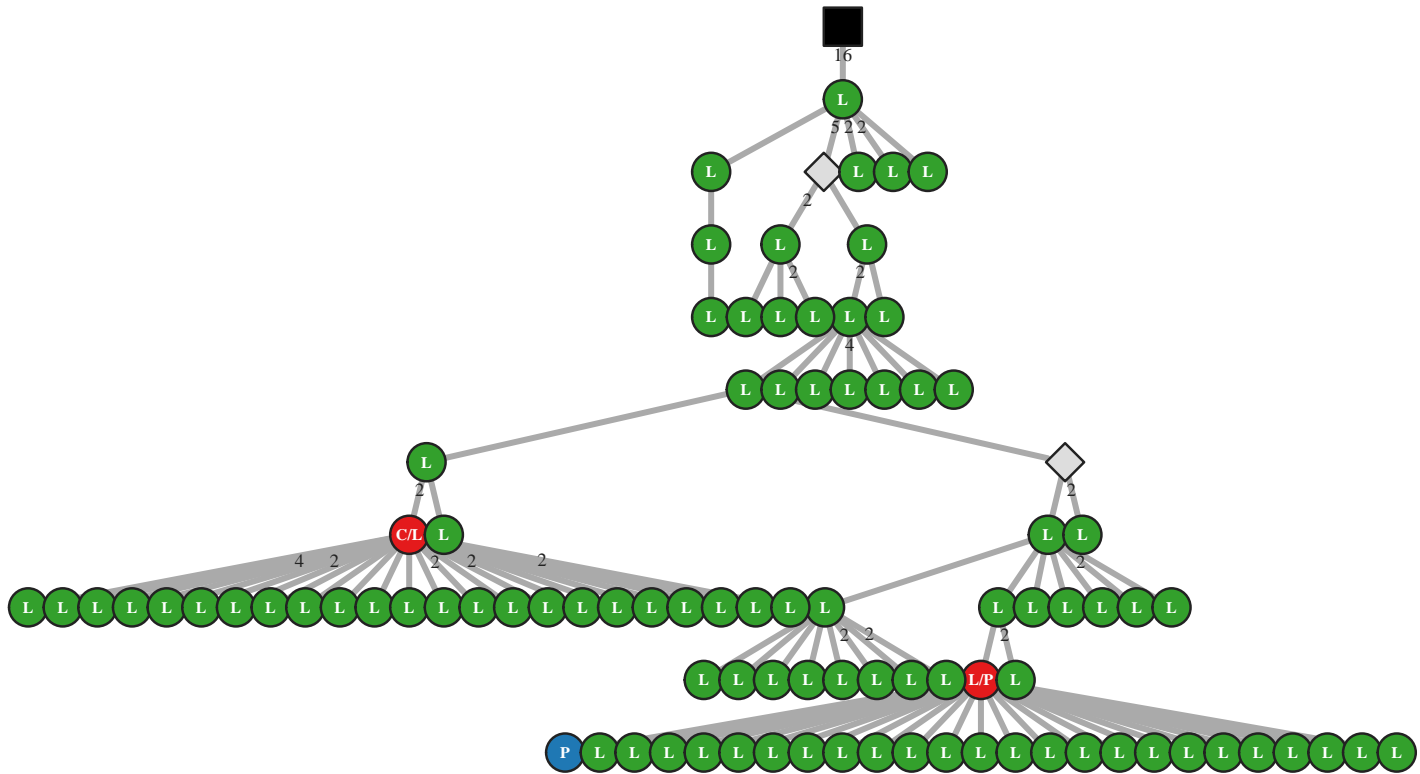

M5 IgG IGHV1-8/J6 45bp (24428)

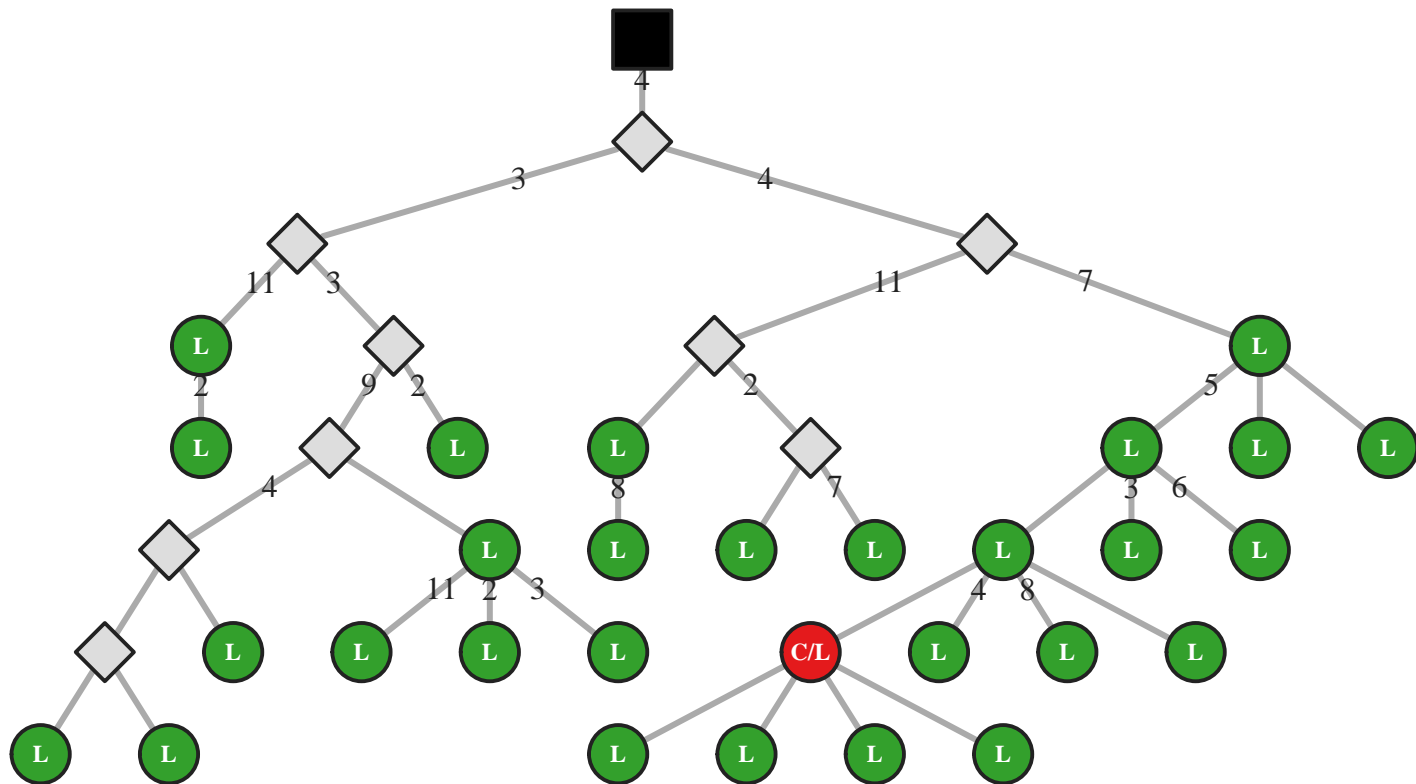

M5 IgG IGHV1-8/J6 69bp (50543)

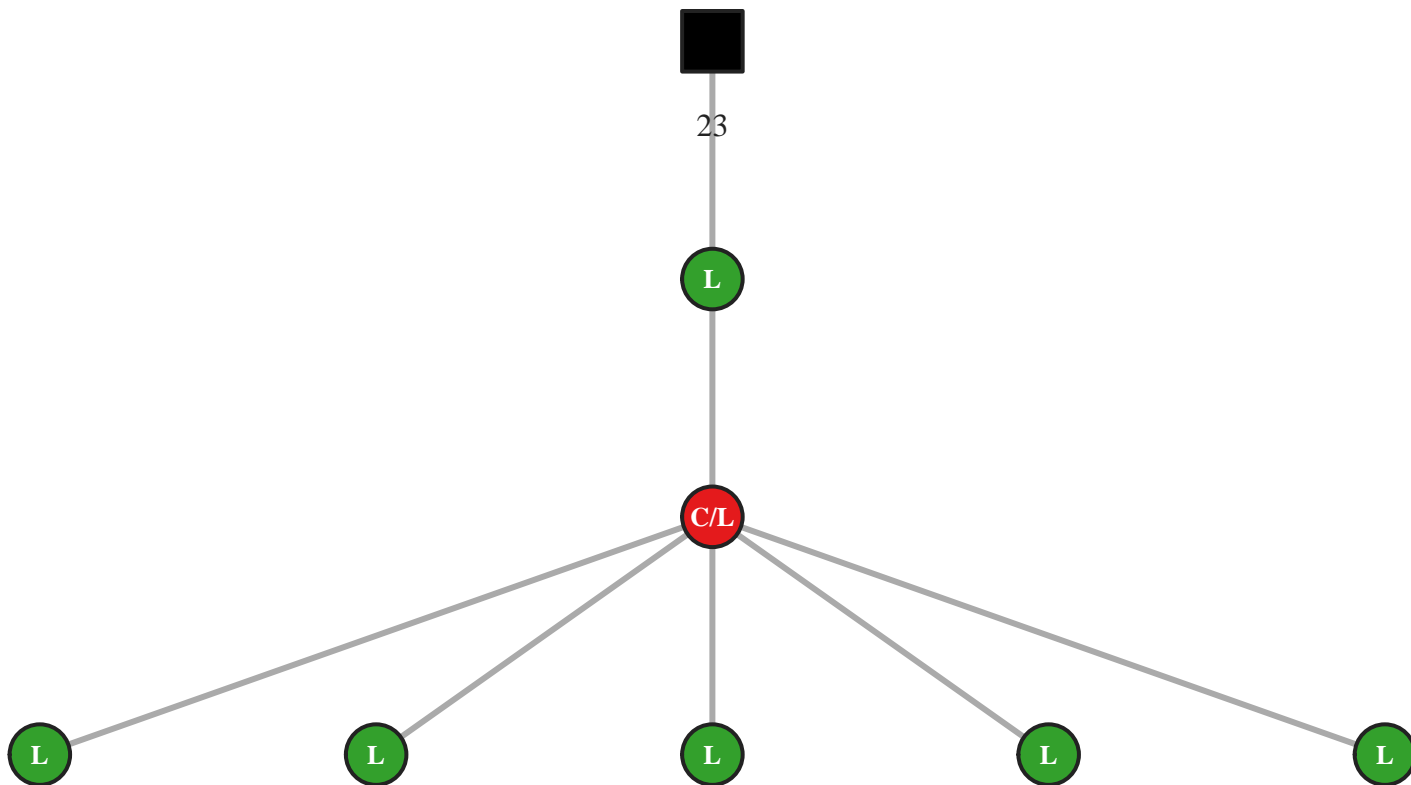

M5 IgG IGHV1-8/J6 69bp (50552)

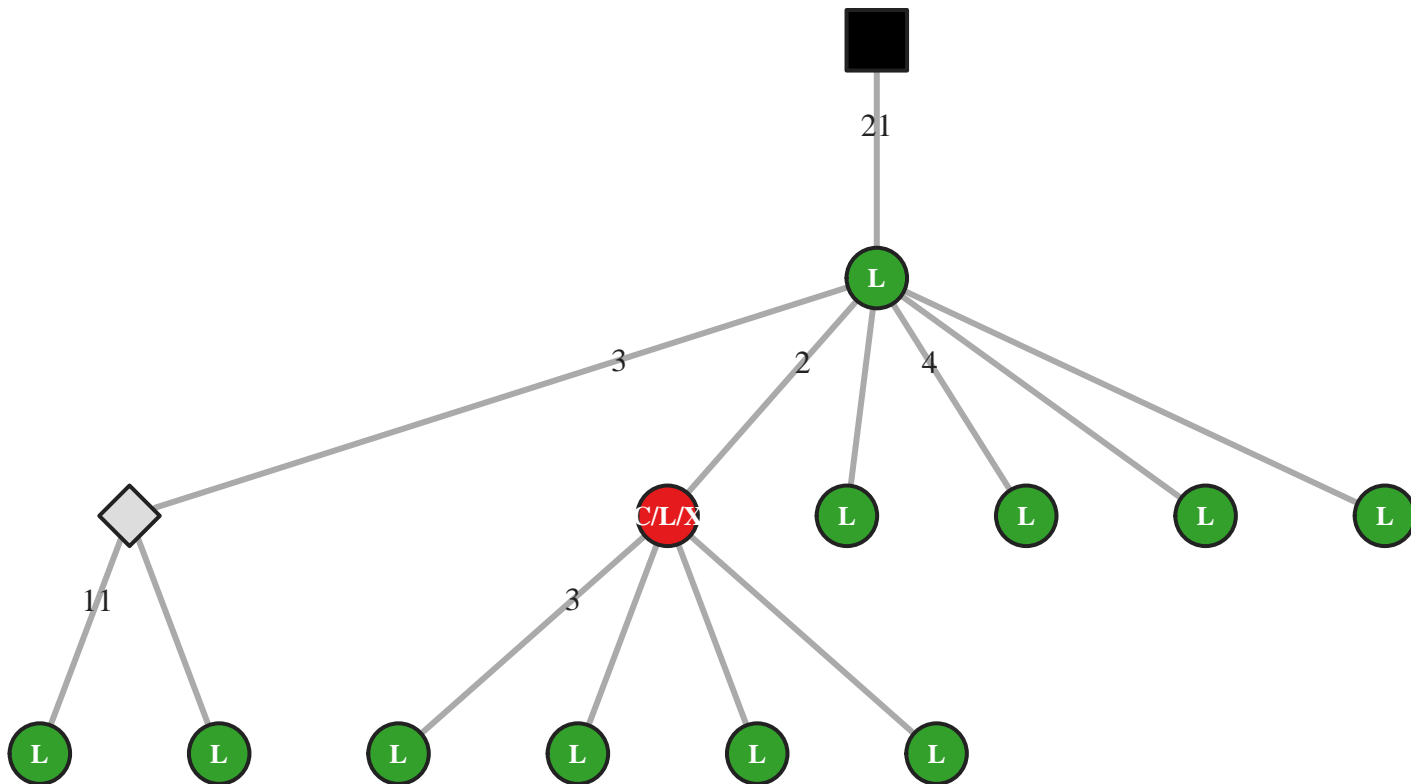

M5 IgG IGHV1-8/J6 72bp (15106)

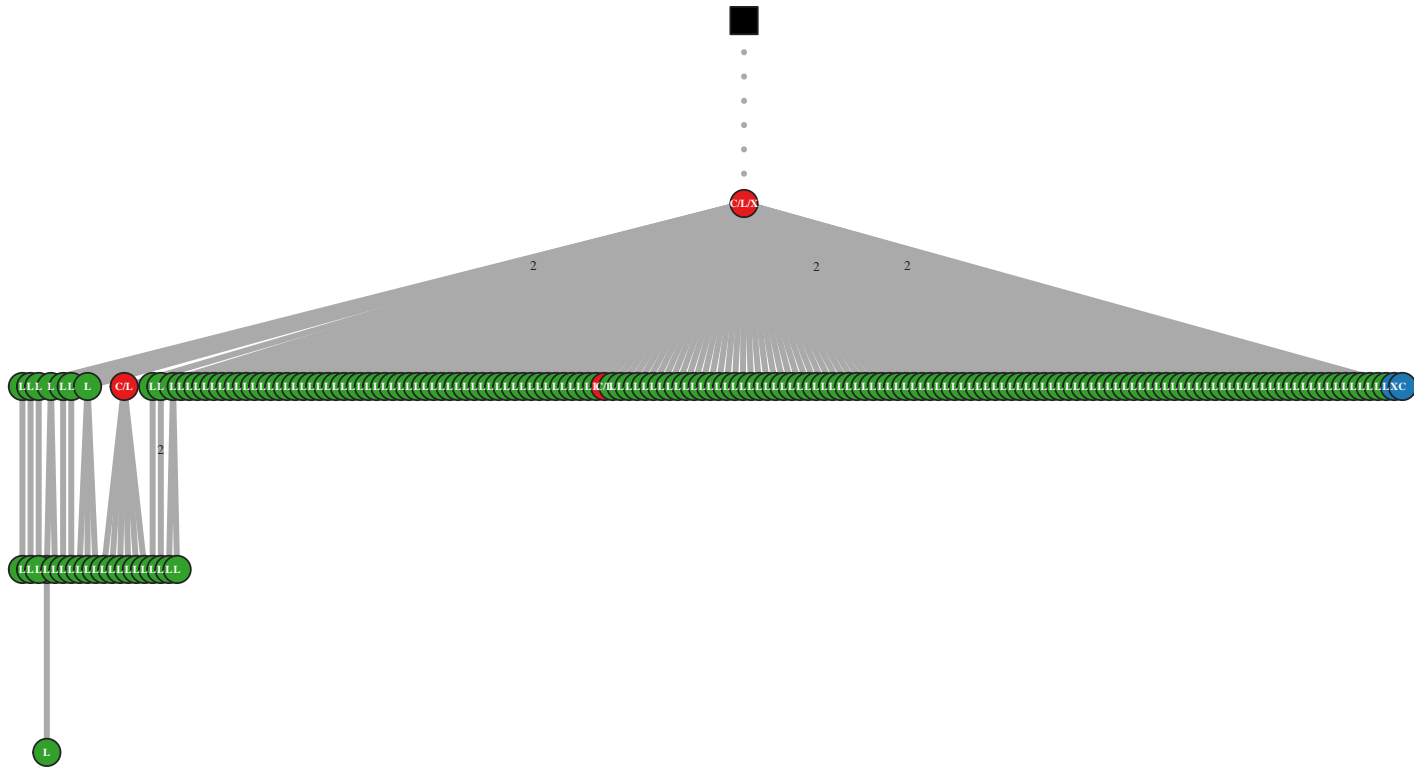

M5 IgG IGHV2-26/J2 57bp (33291)

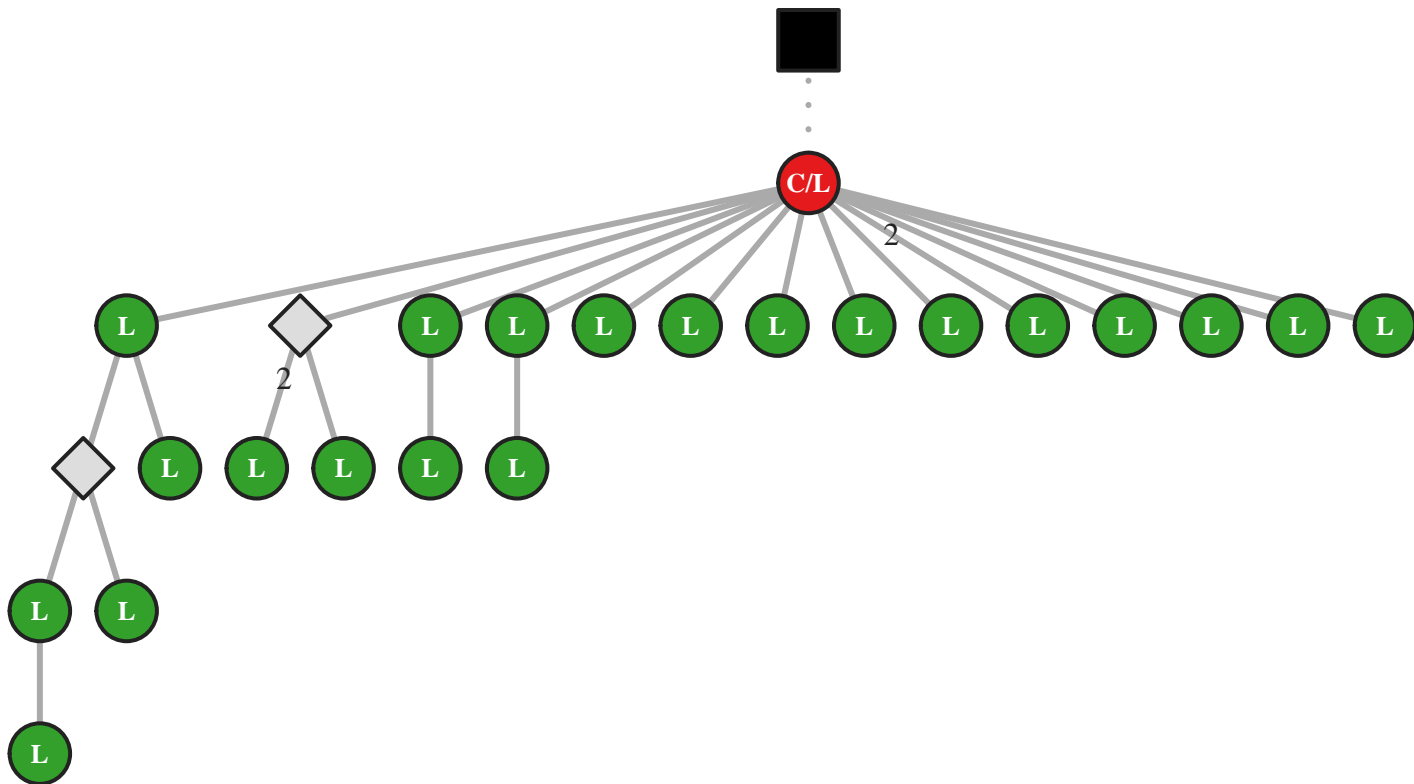

M5 IgG IGHV2-26/J3 42bp (50584)

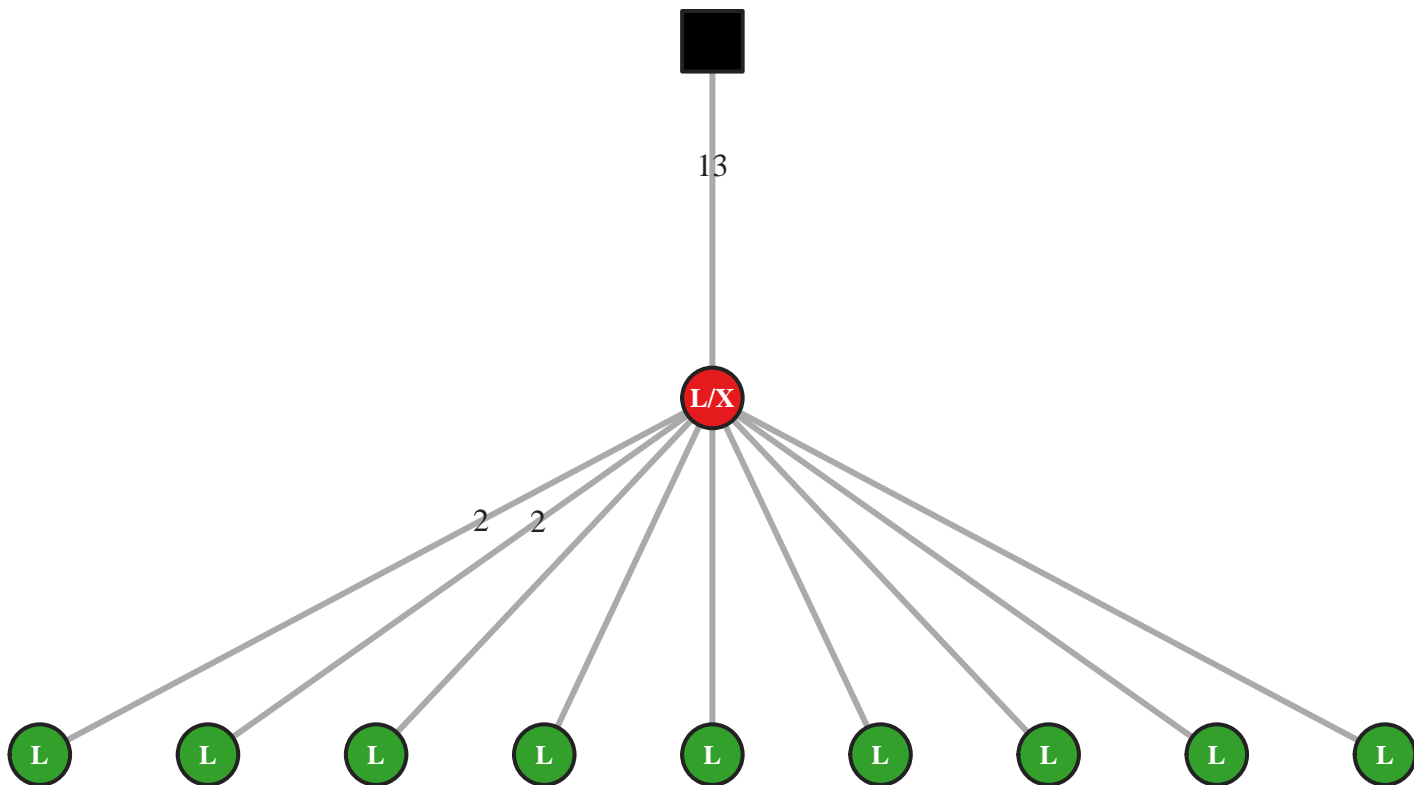

M5 IgG IGHV2-26/J3 48bp (15147)

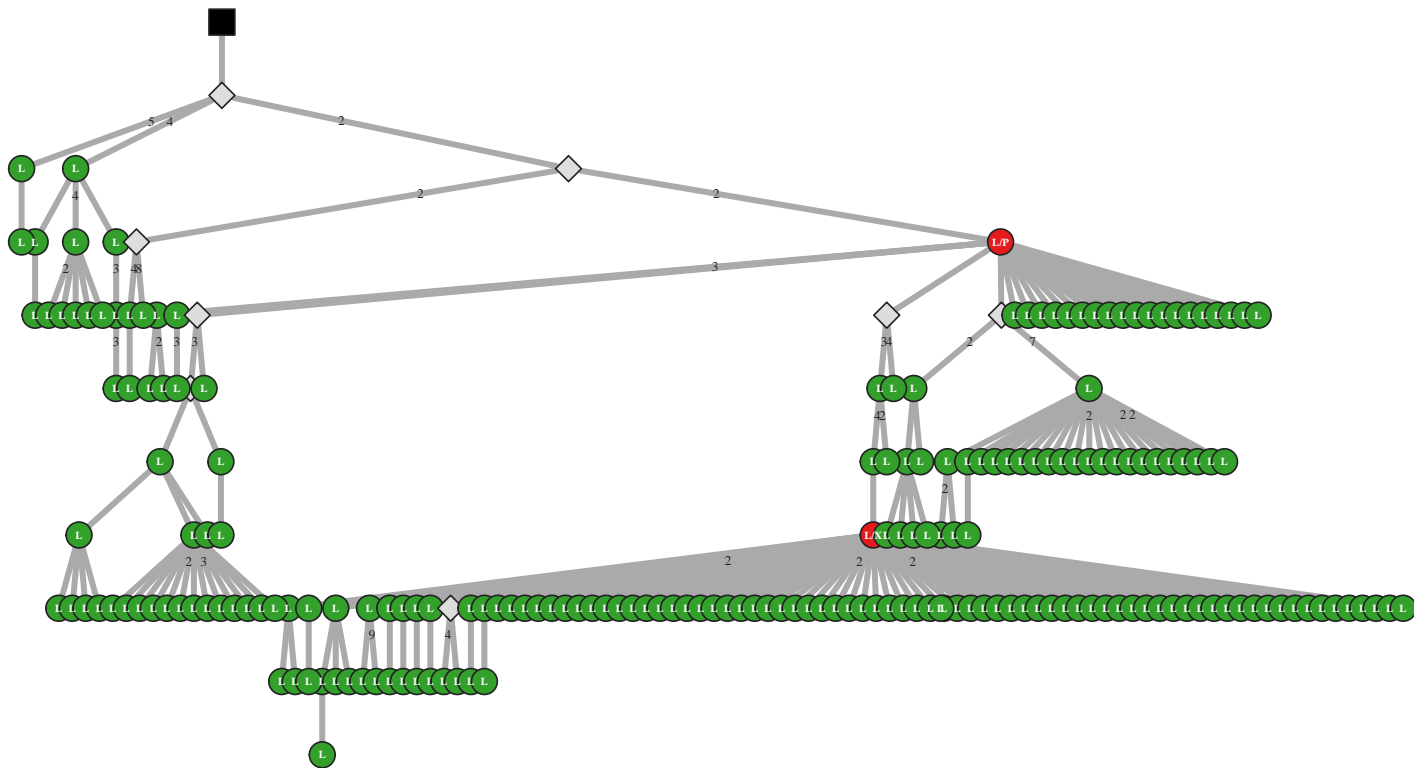

M5 IgG IGHV2-26/J3 51bp (42504)

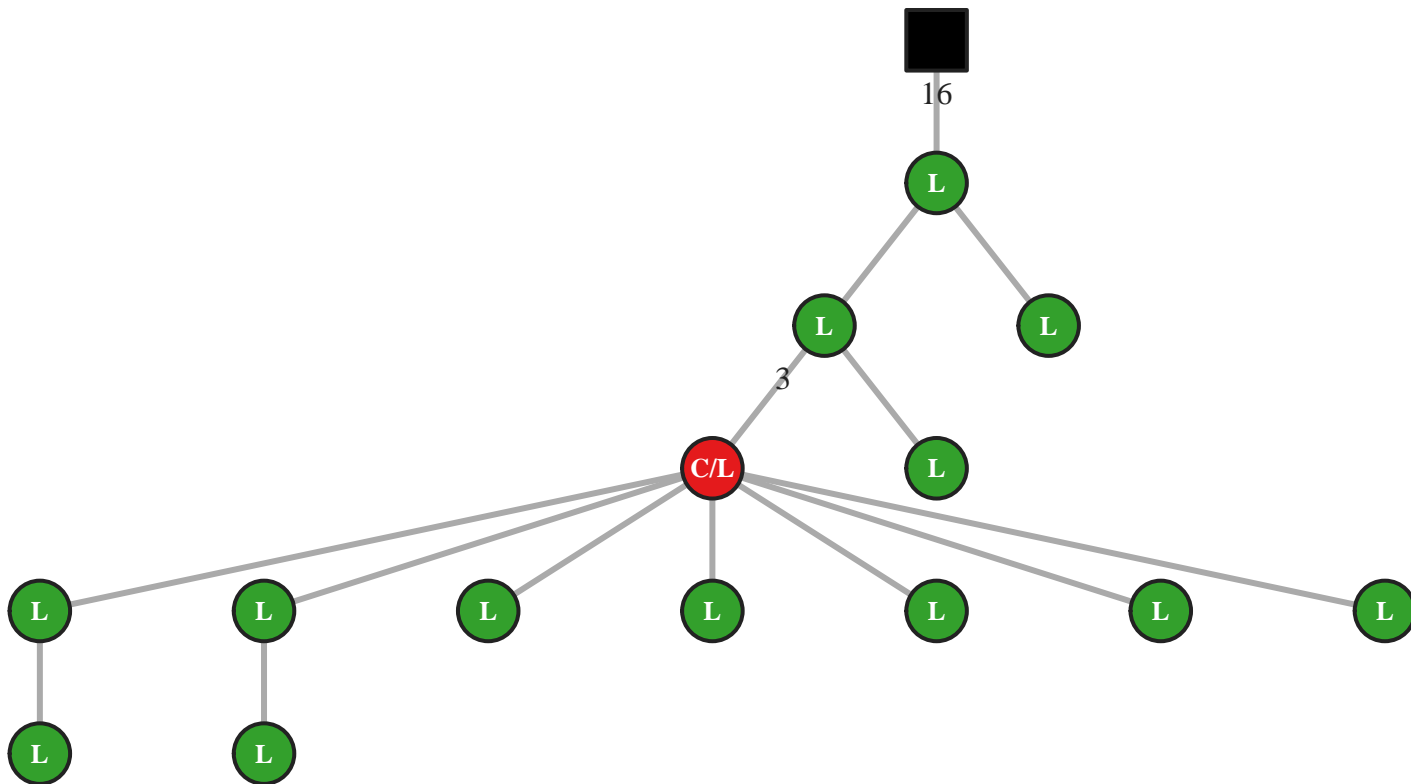

M5 IgG IGHV2-26/J4 45bp (15172)

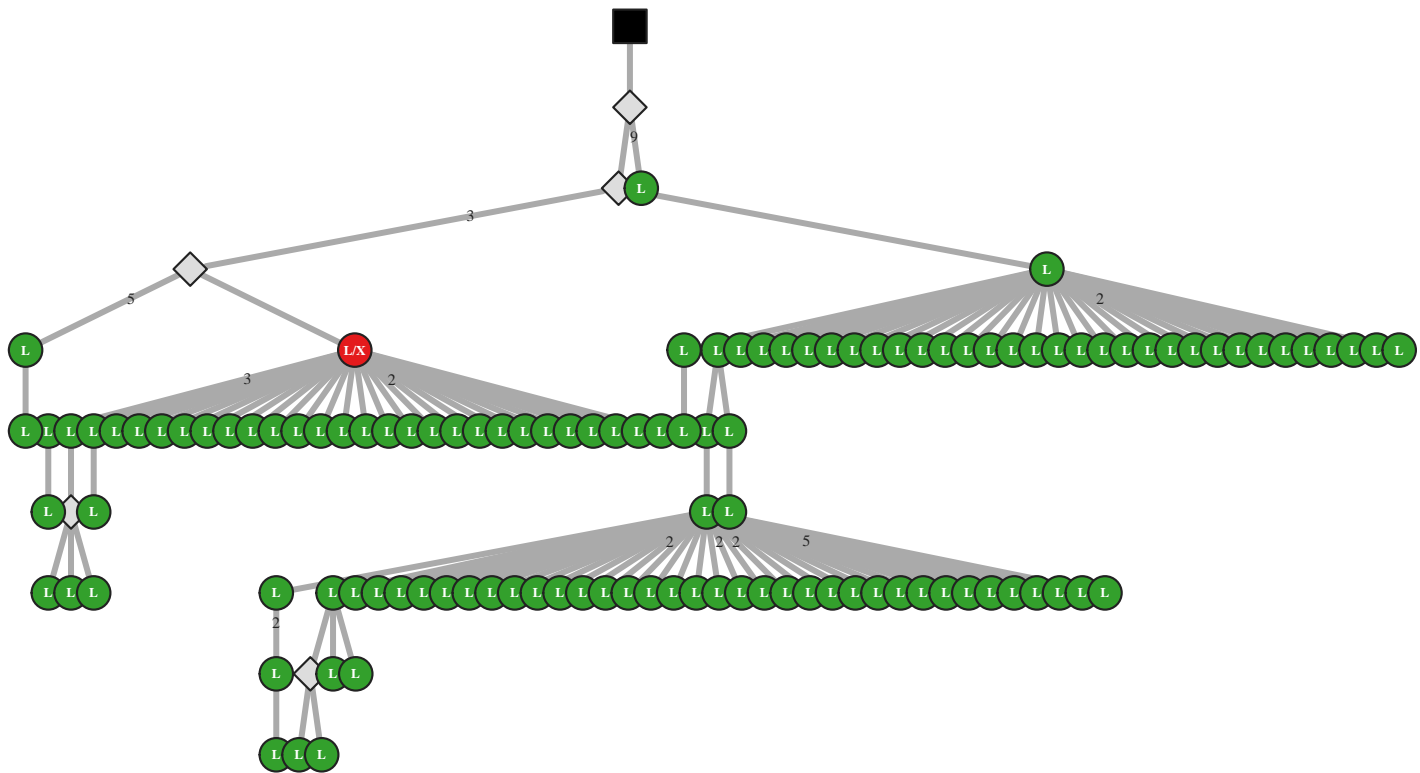

M5 IgG IGHV2-26/J4 51bp (5519)

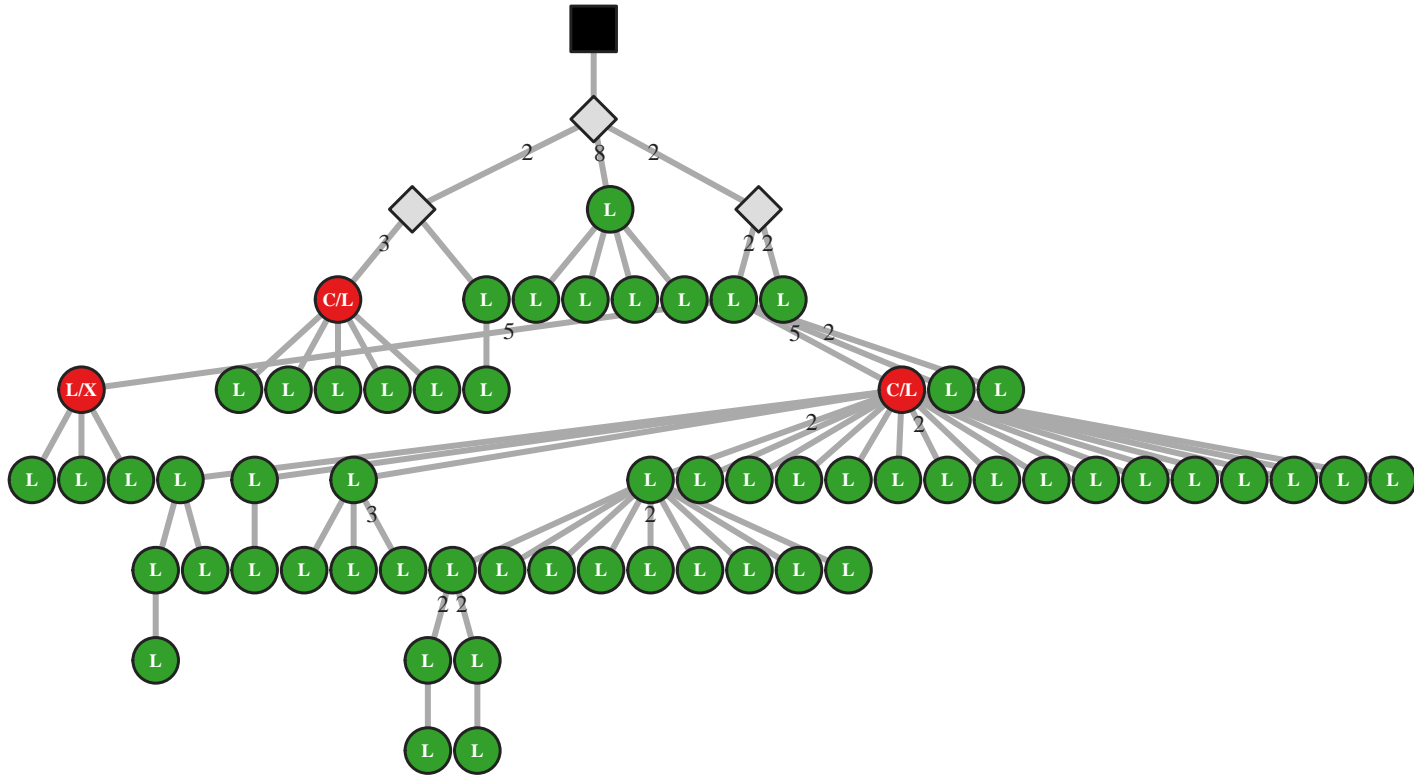

M5 IgG IGHV2-26/J4 51bp (5521)

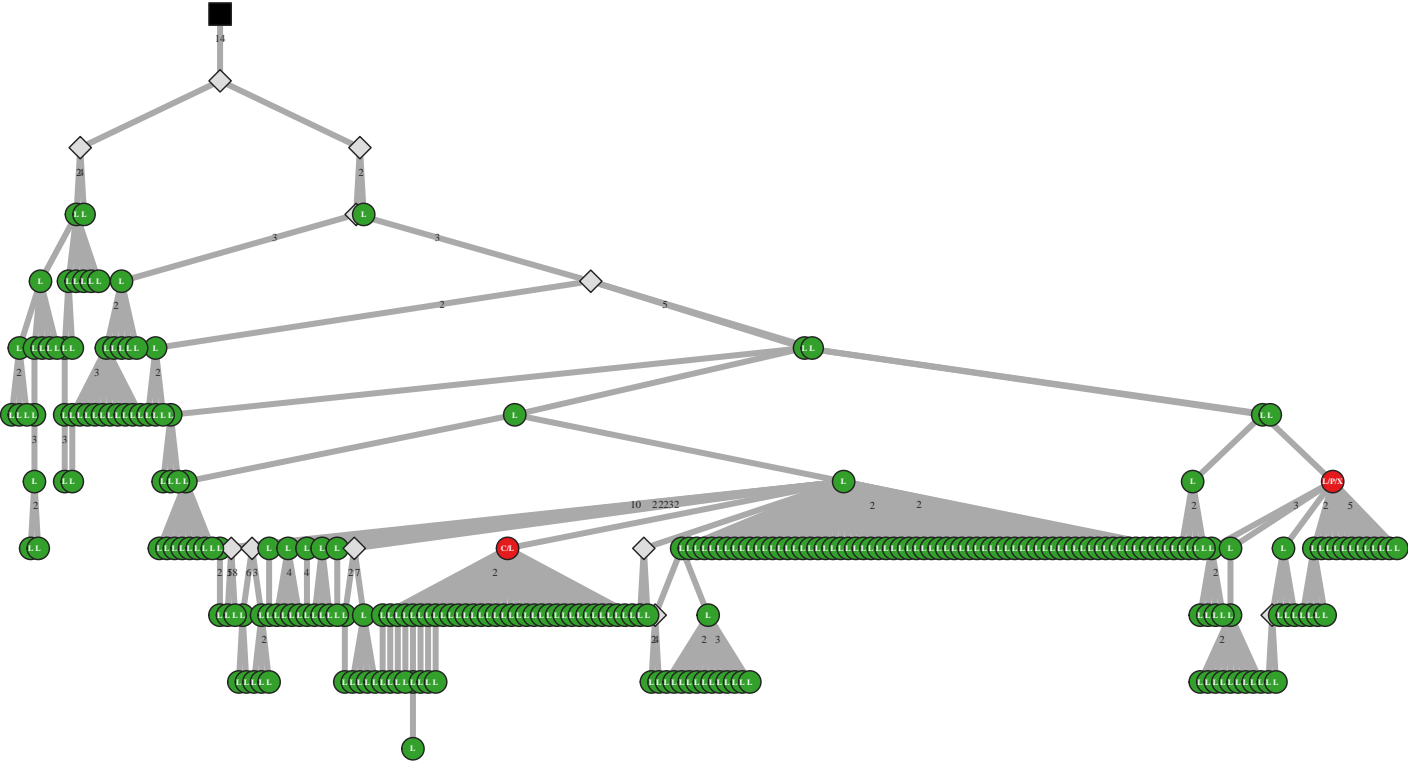

M5 IgG IGHV2-26/J4 54bp (15182)

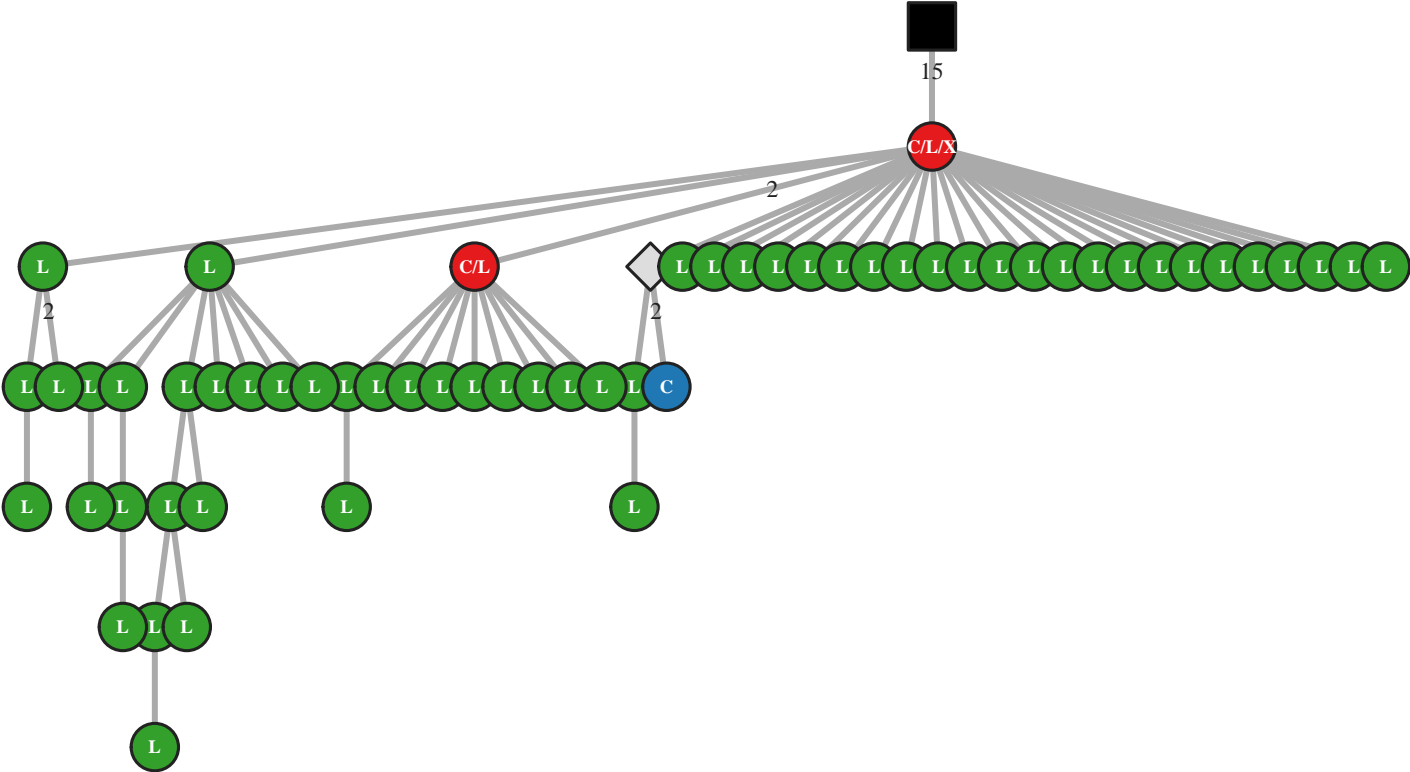

M5 IgG IGHV2-26/J4 54bp (15195)

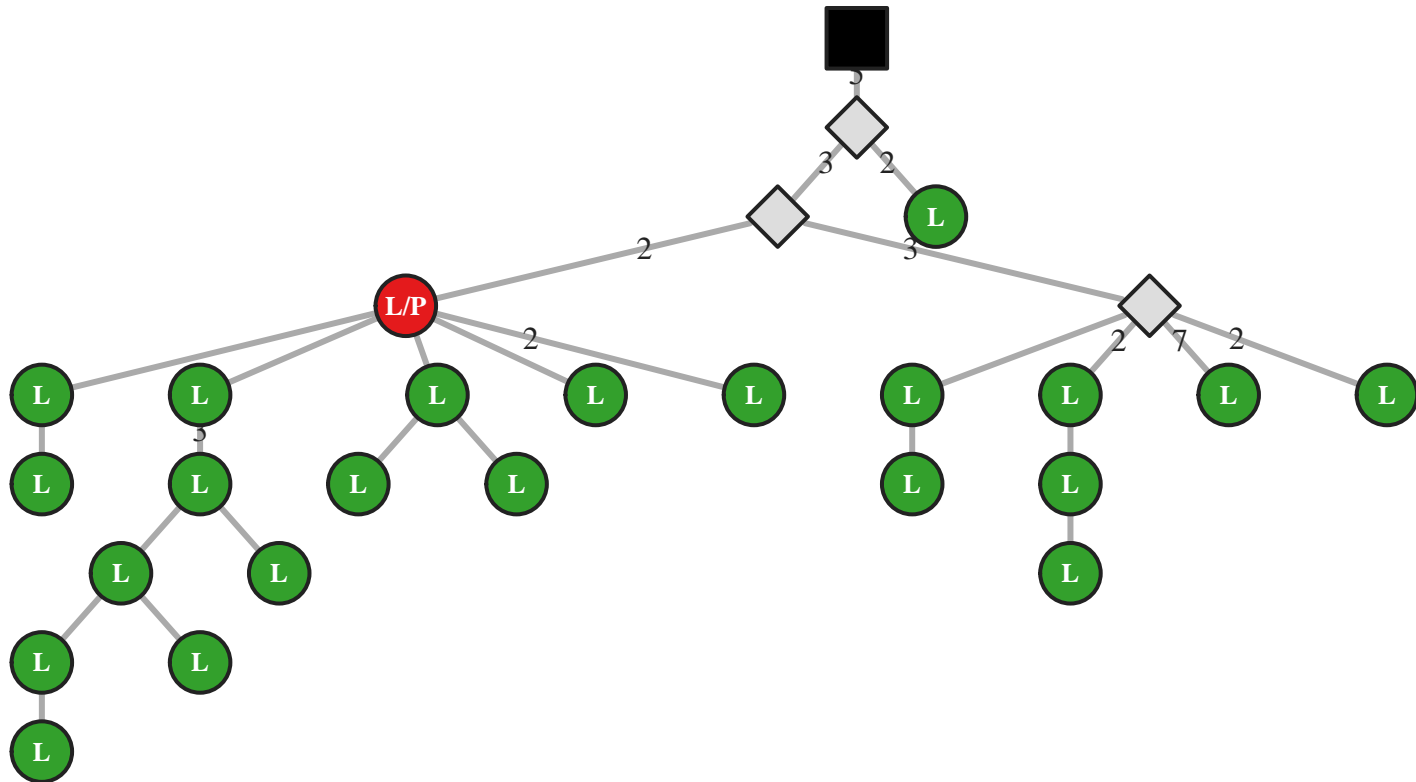

M5 IgG IGHV2-26/J5 39bp (5534)

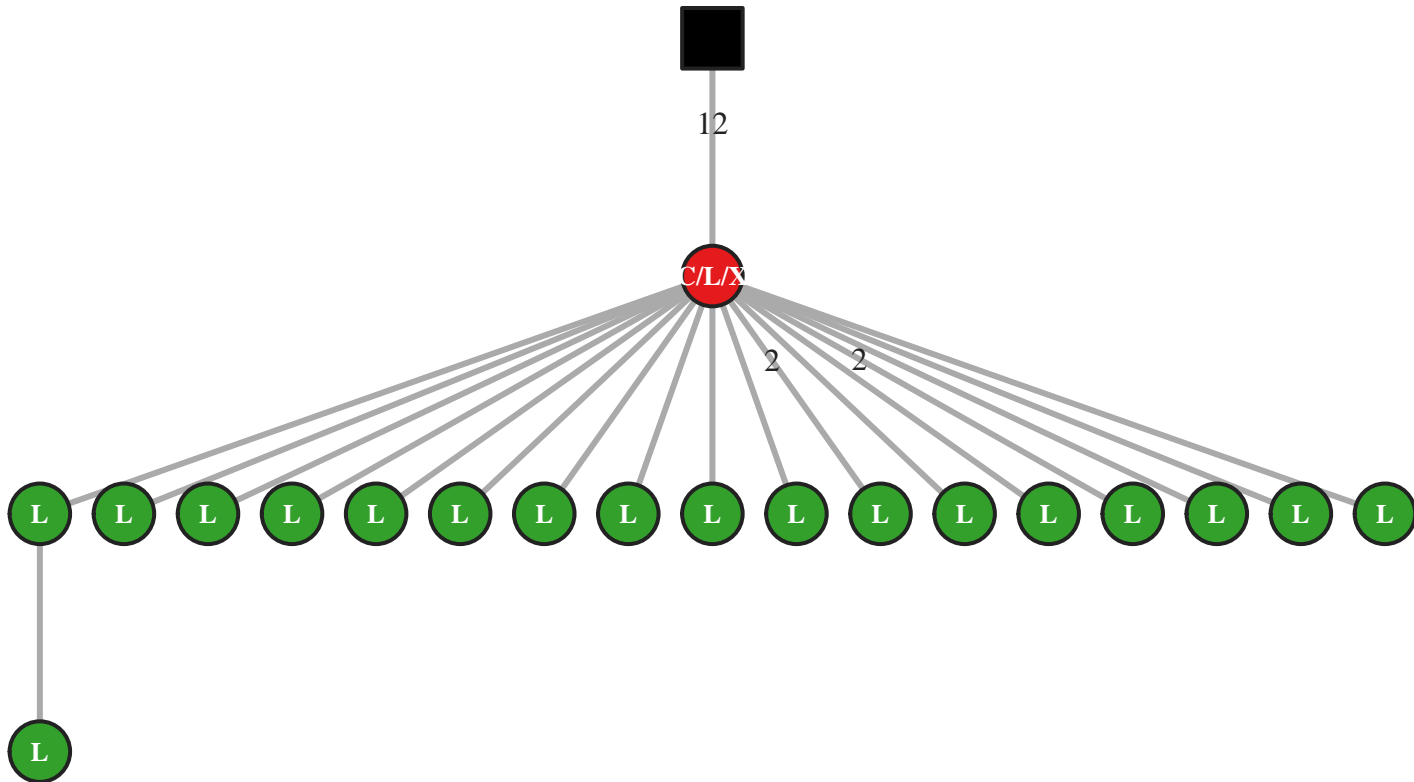

M5 IgG IGHV2-26/J5 57bp (42522)

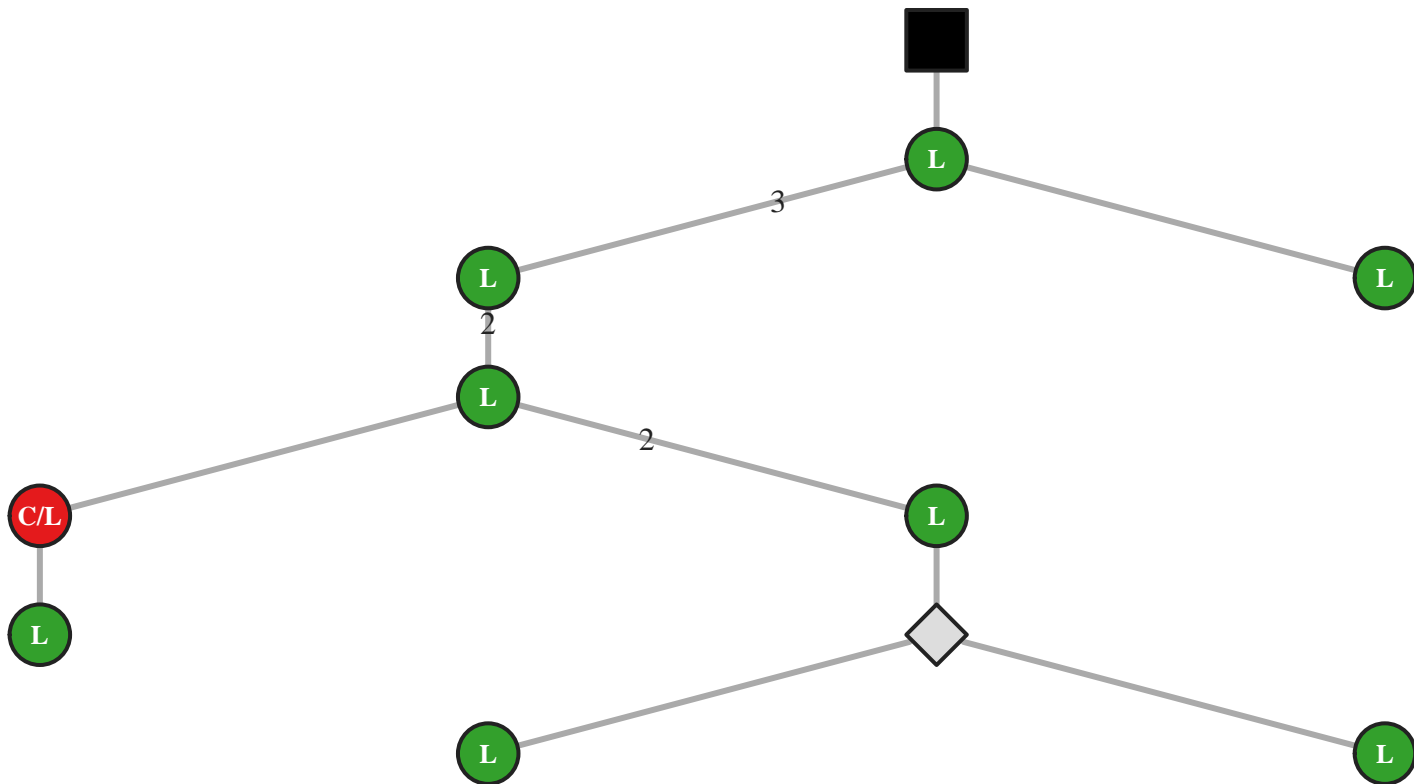

M5 IgG IGHV2-26/J5 66bp (5544)

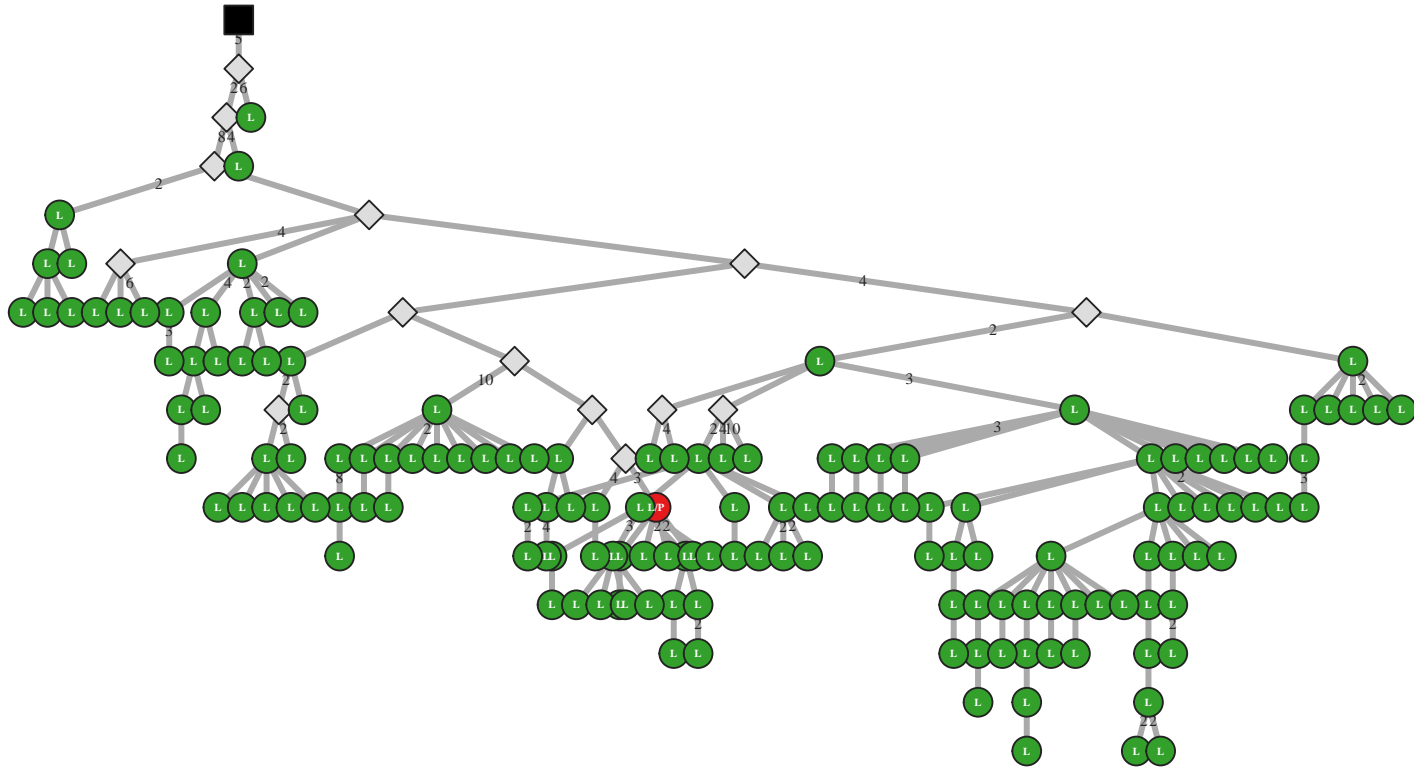

M5 IgA IGHV2-26/J5 72bp (30306)

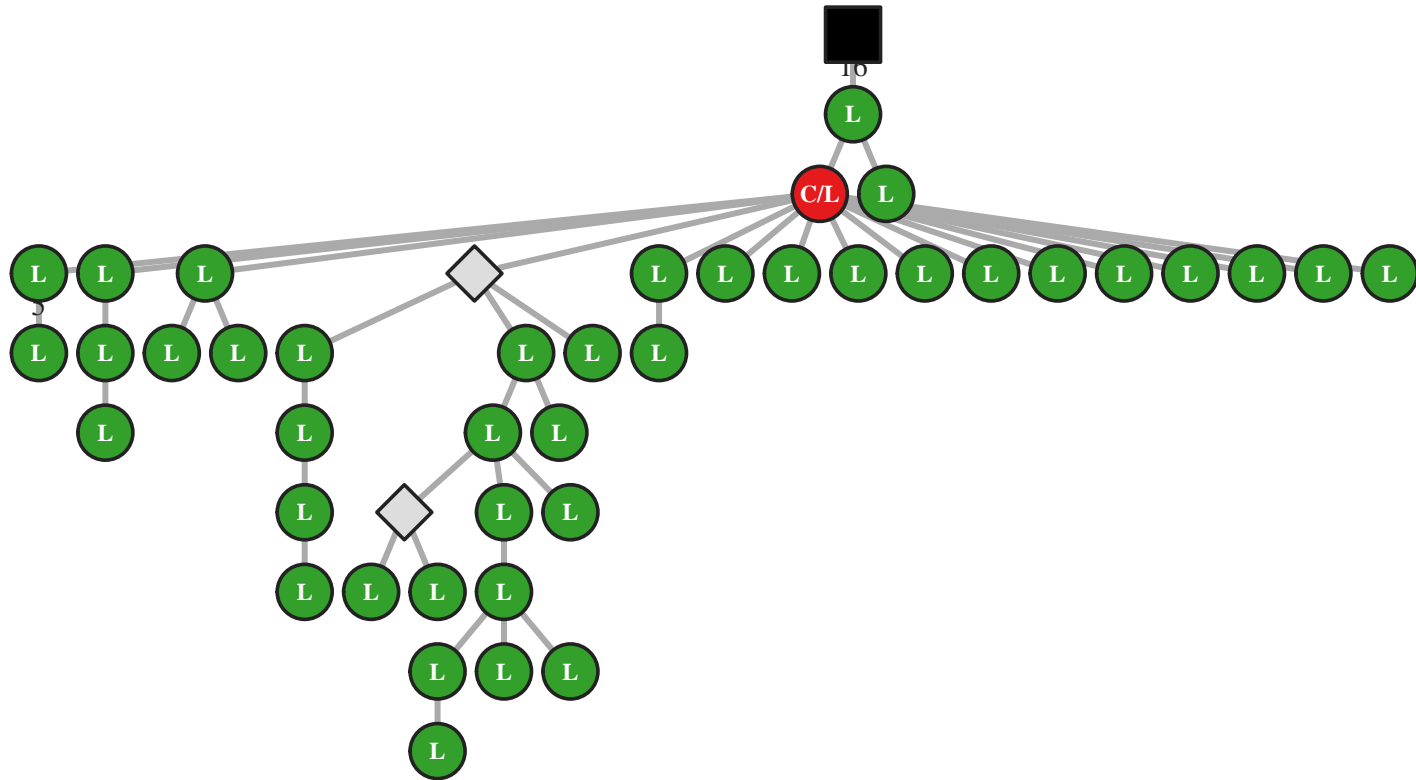

M5 IgG IGHV2-26/J6 60bp (15242)

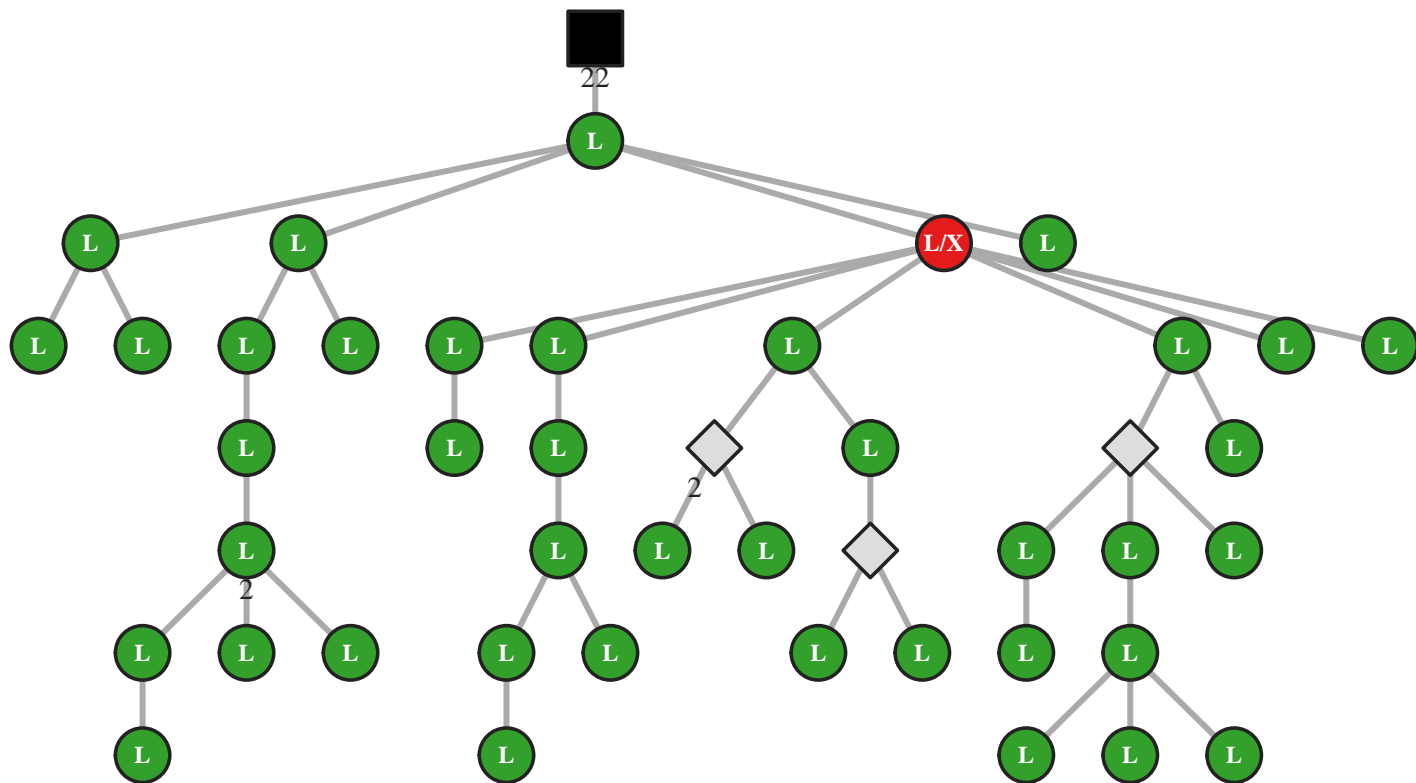

M5 IgG IGHV2-5/J1 36bp (33338)

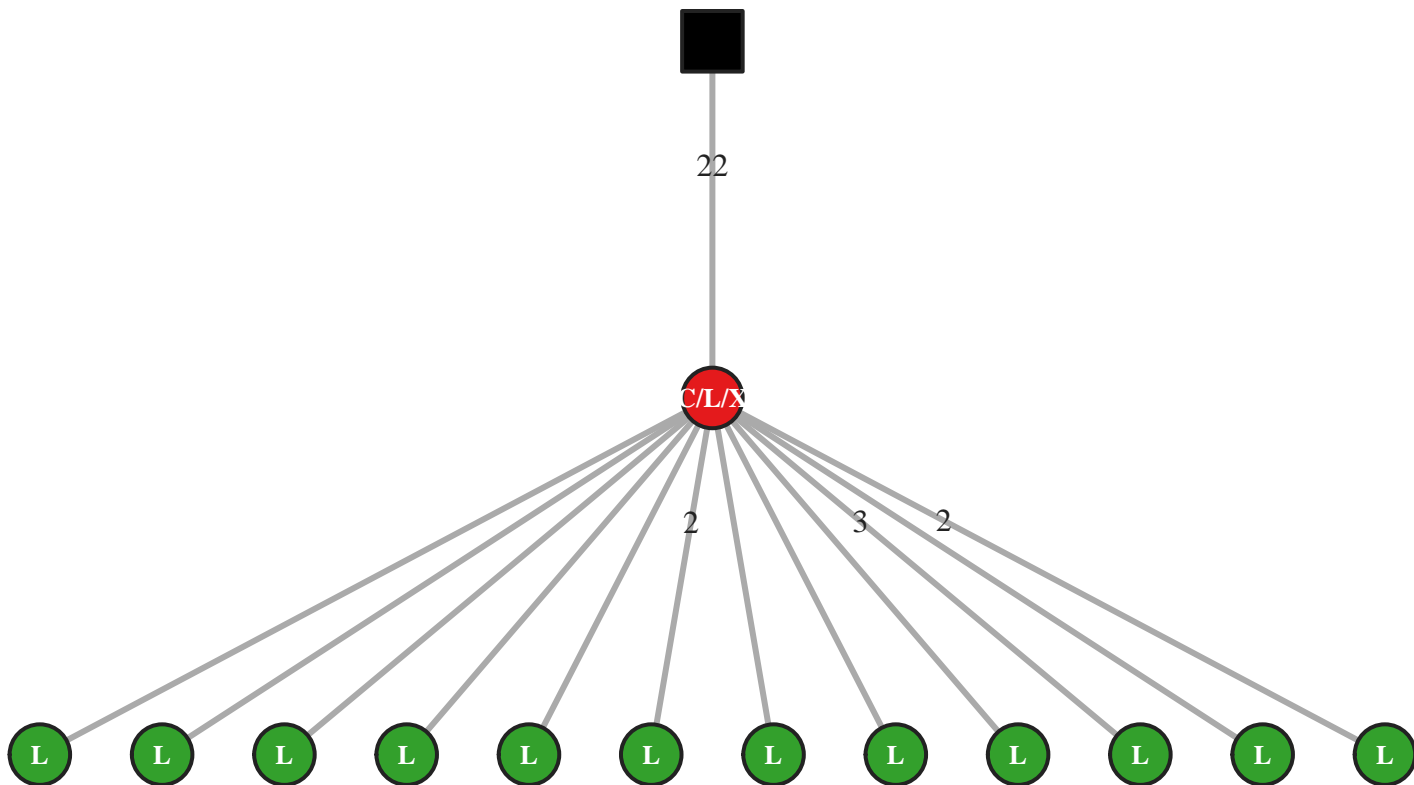

M5 IgA IGHV2-5/J1 51bp (38482)

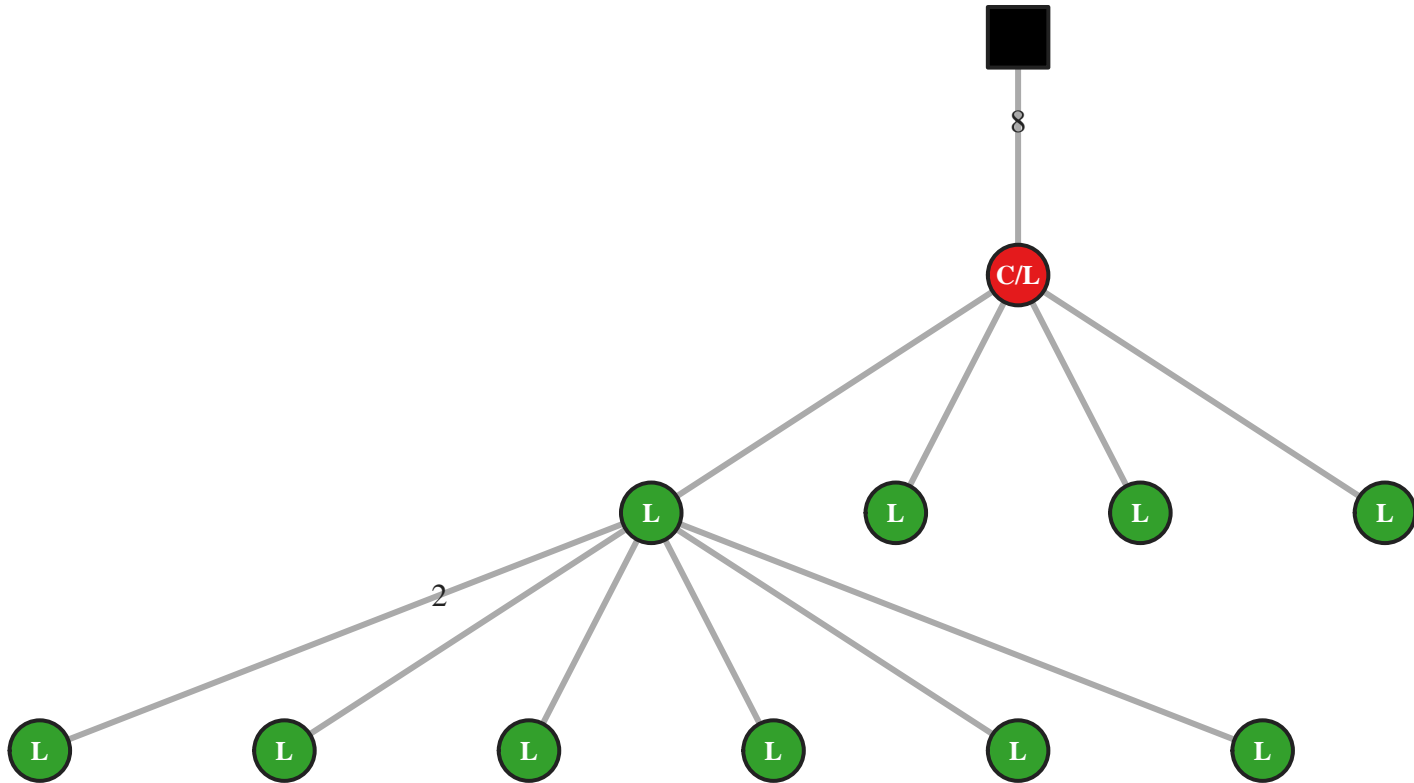

M5 IgA IGHV2-5/J1 63bp (2458)

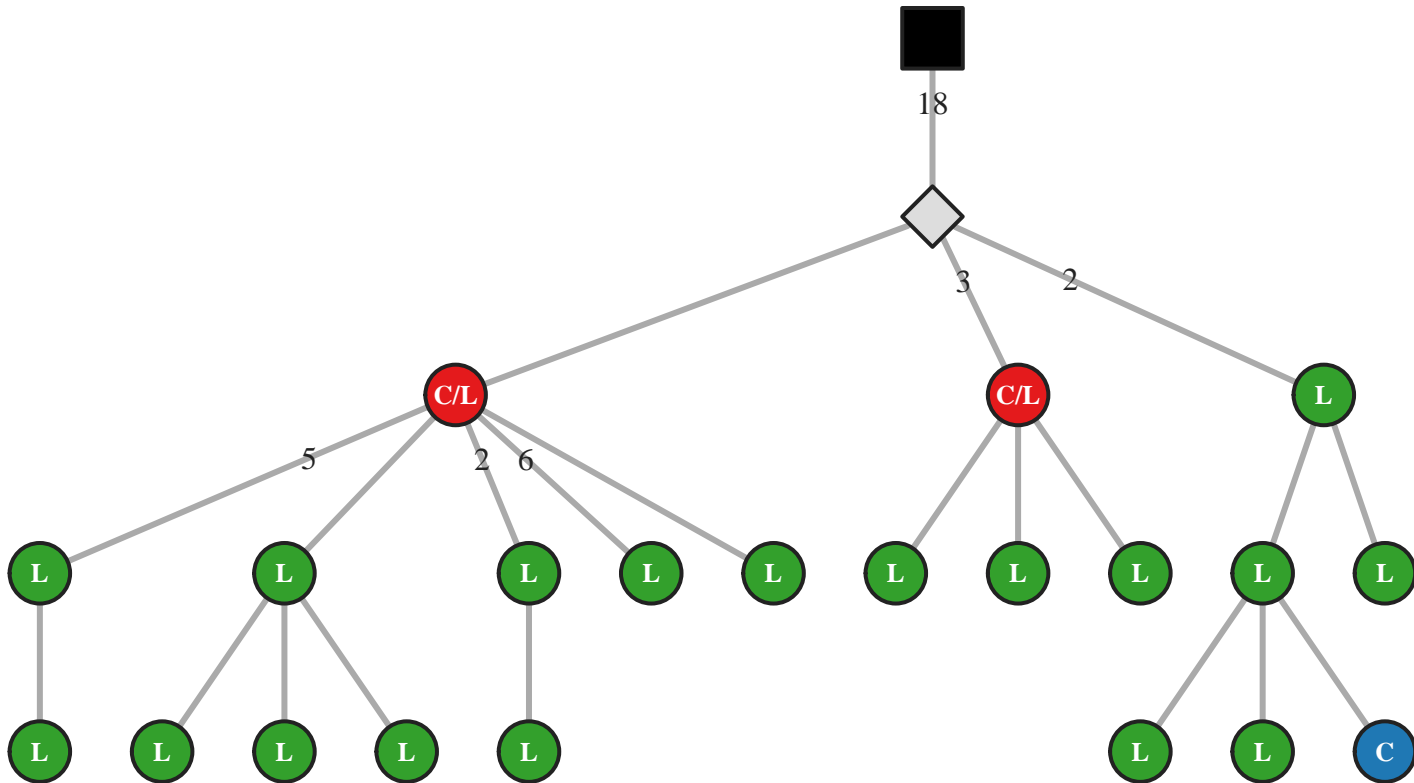

M5 IgG IGHV2-5/J1 63bp (33340)

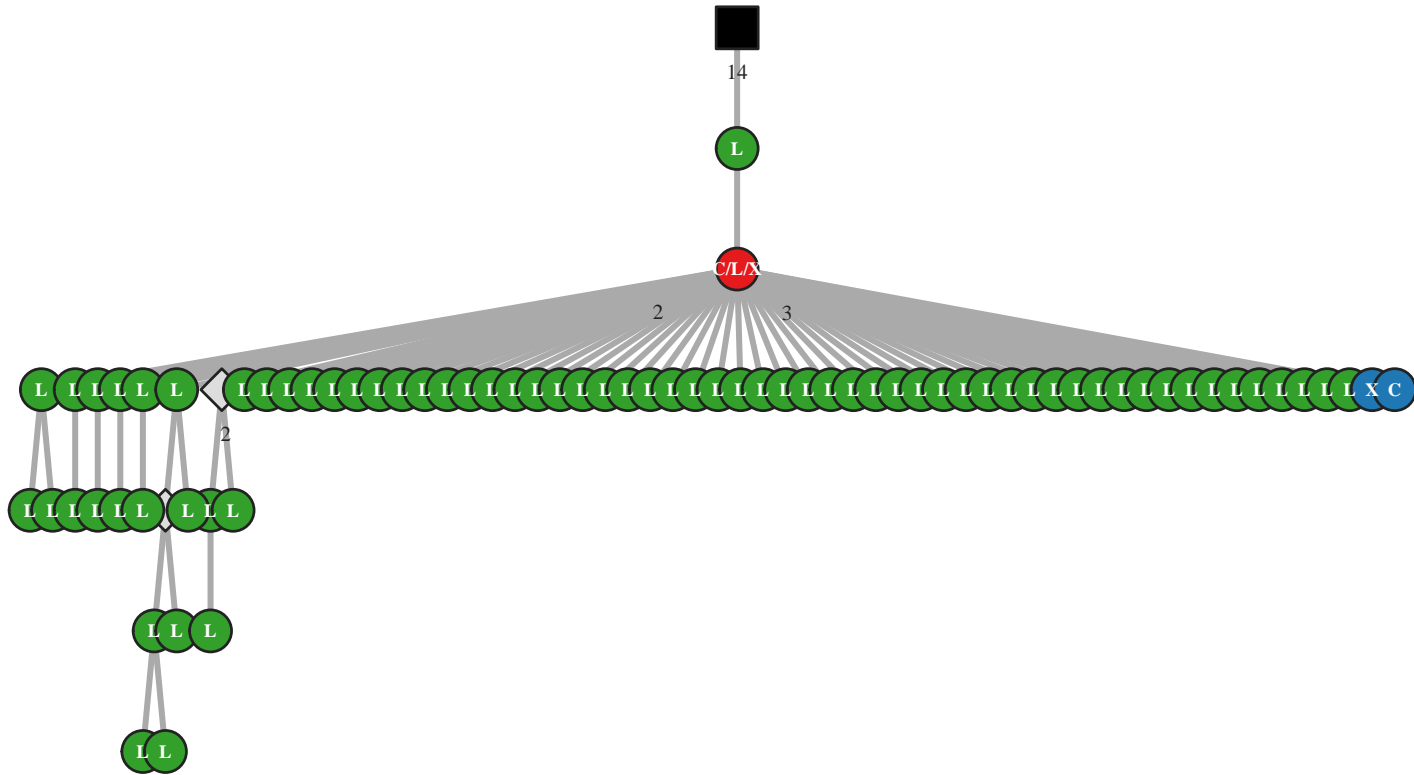

M5 IgM IGHV2-5/J1 66bp (29301)

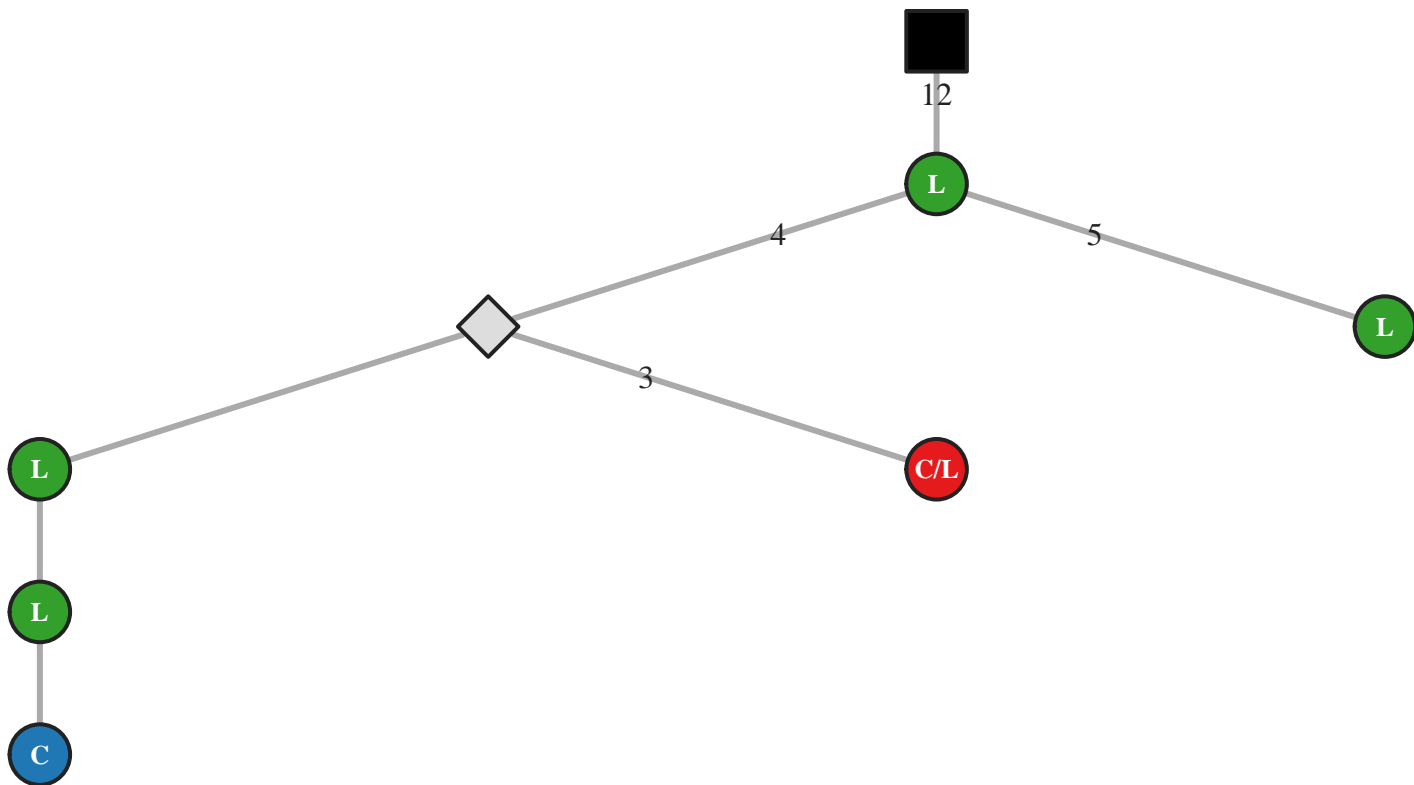

M5 IgG IGHV2-5/J3 45bp (42589)

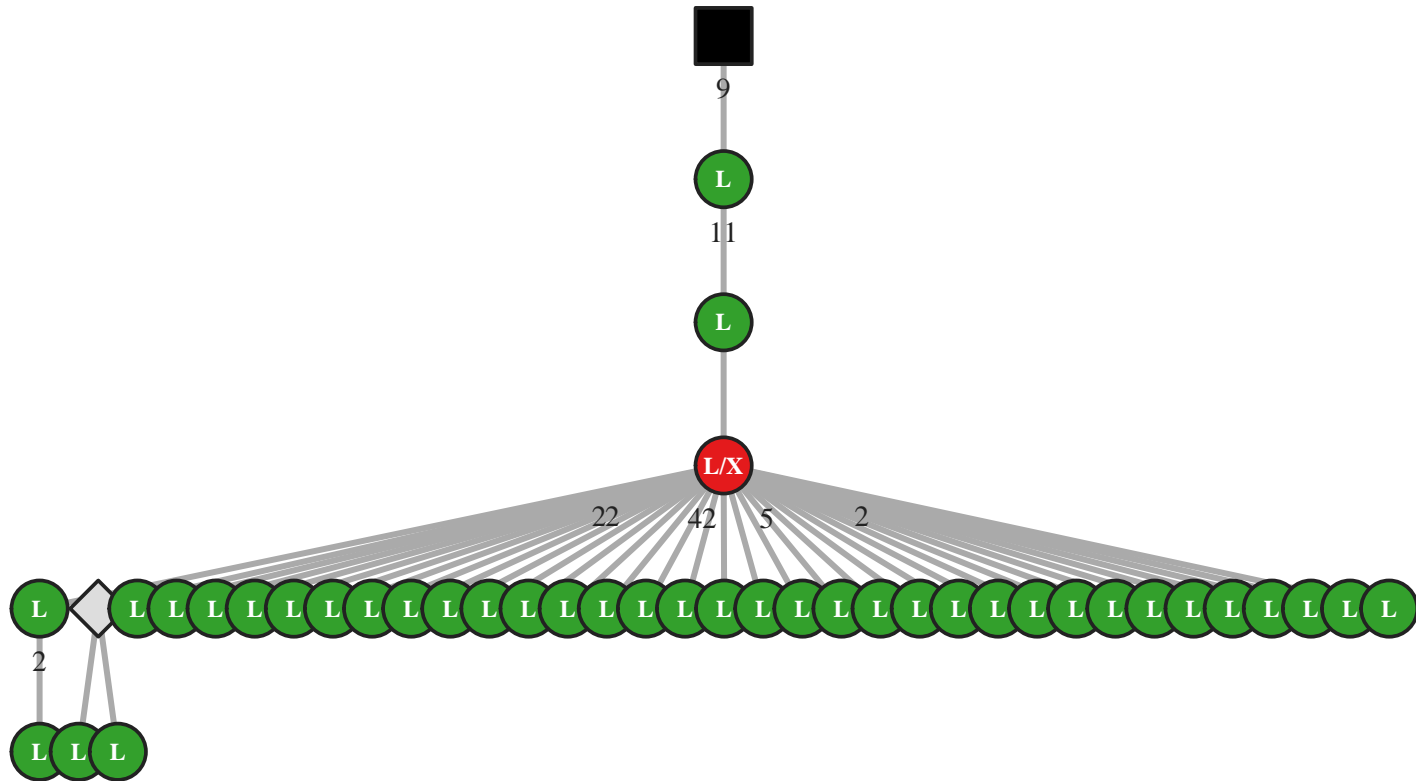

M5 IgG IGHV2-5/J3 54bp (42603)

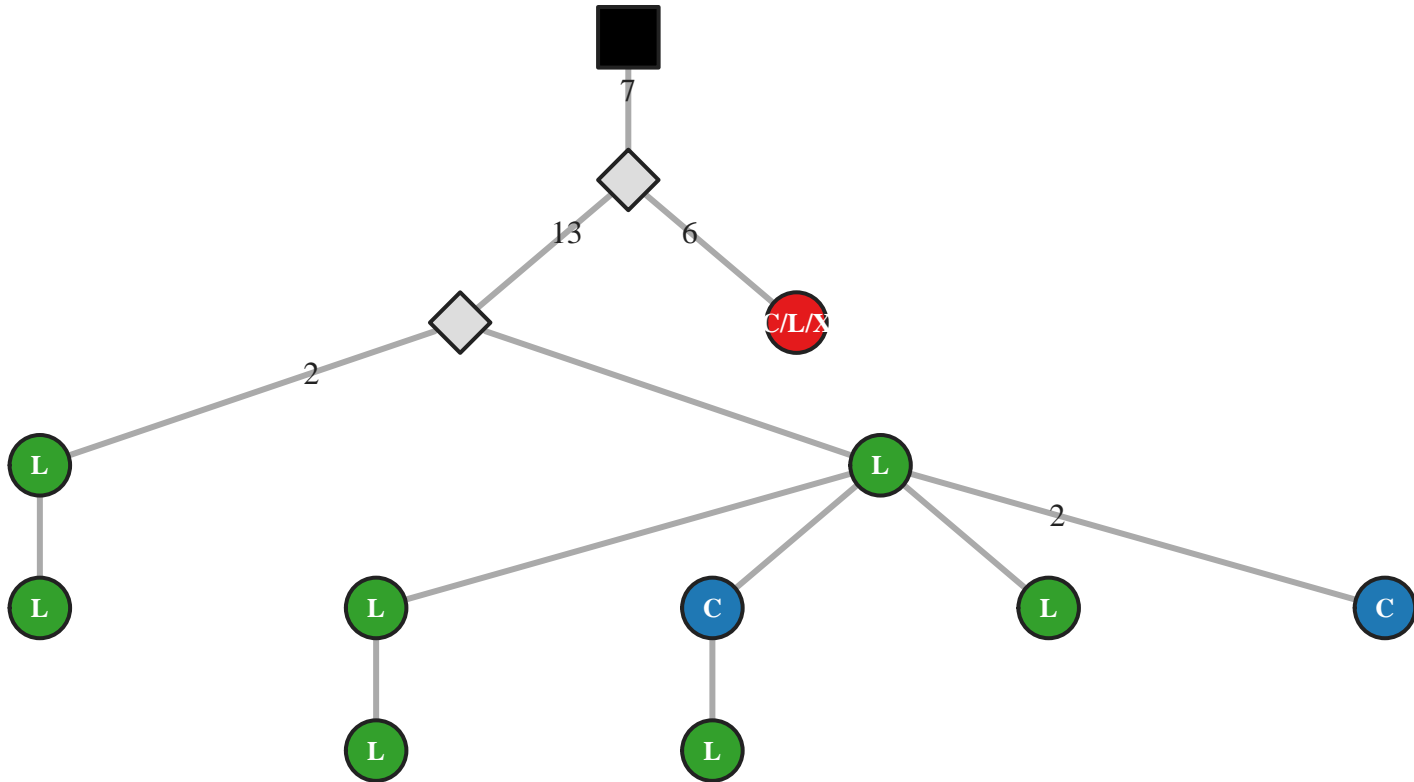

M5 IgG IGHV2-5/J3 54bp (42604)

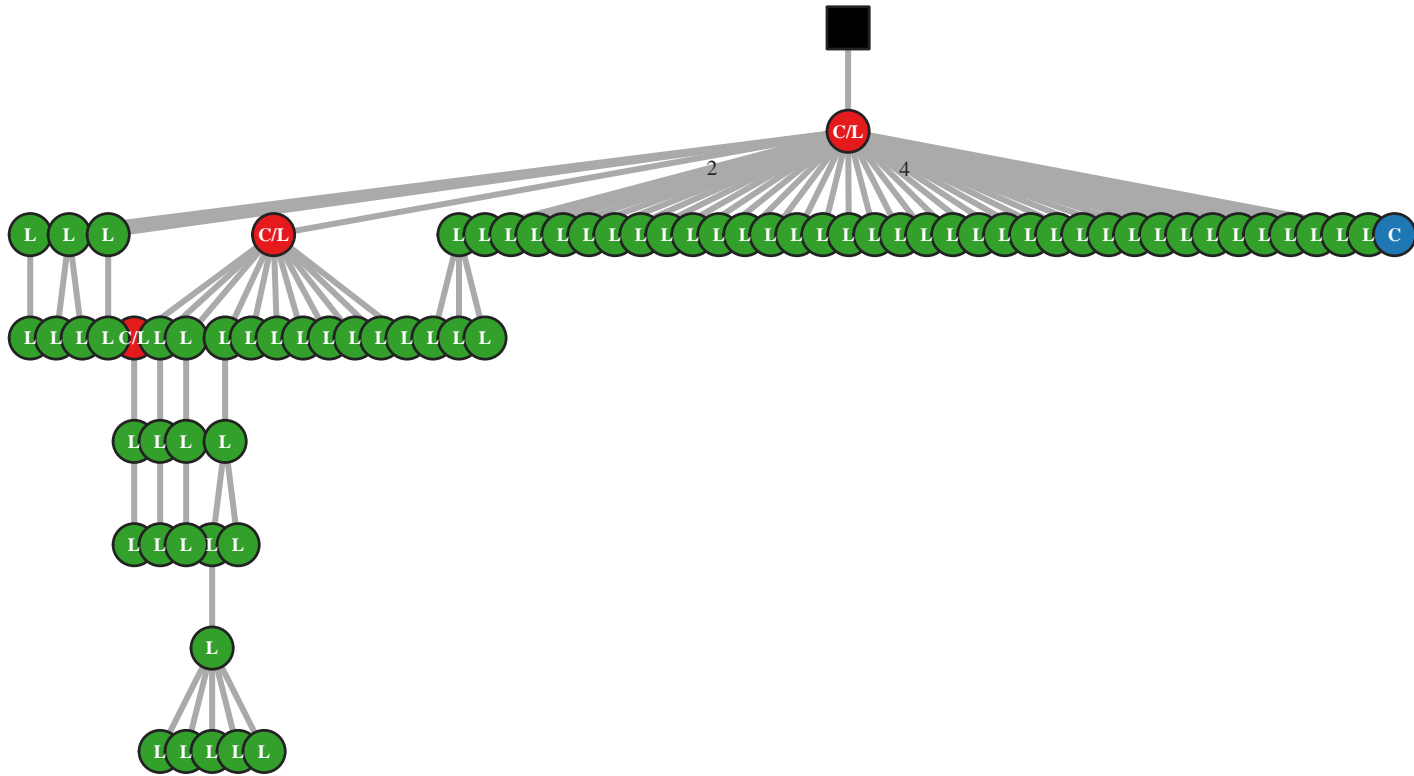

M5 IgG IGHV2-5/J3 54bp (42609)

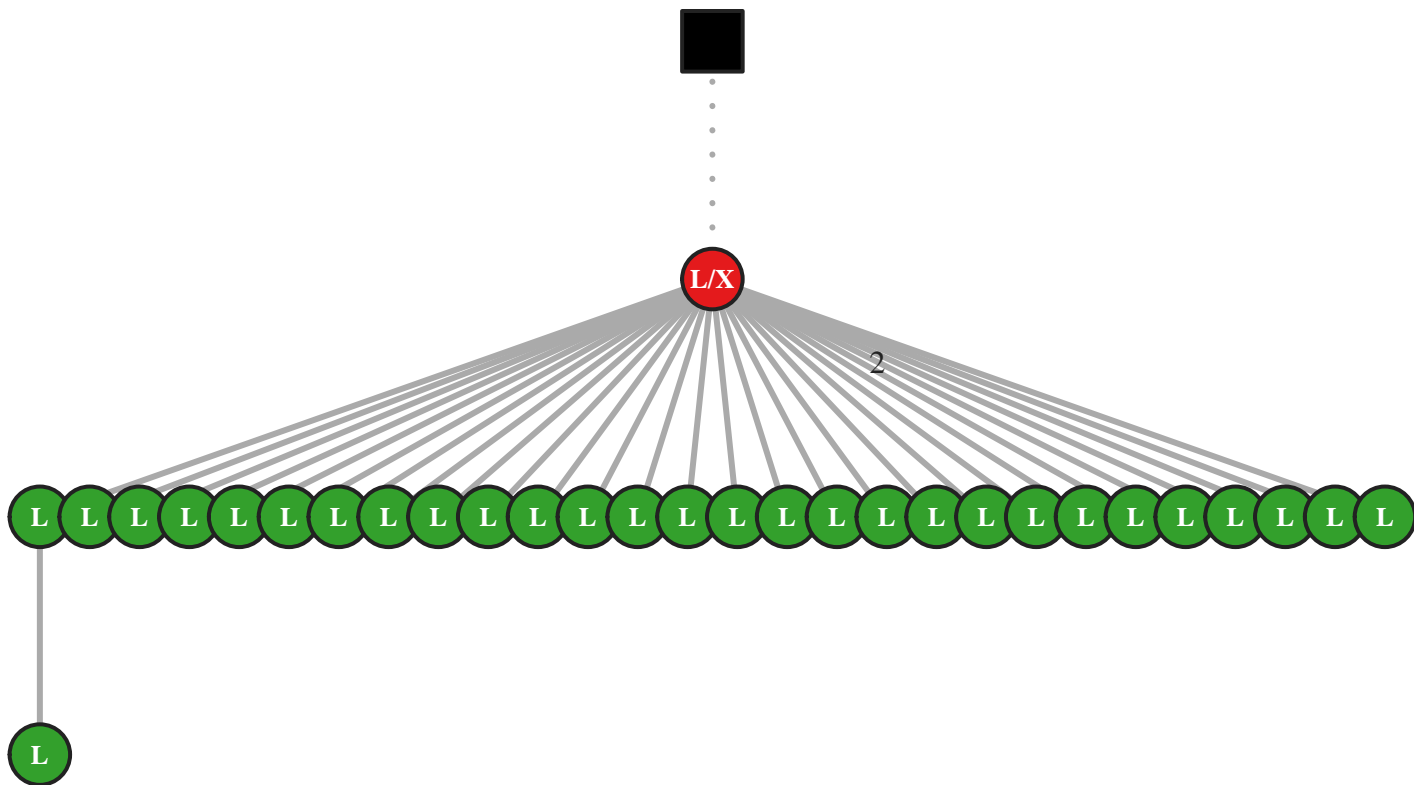

M5 IgG IGHV2-5/J3 54bp (42611)

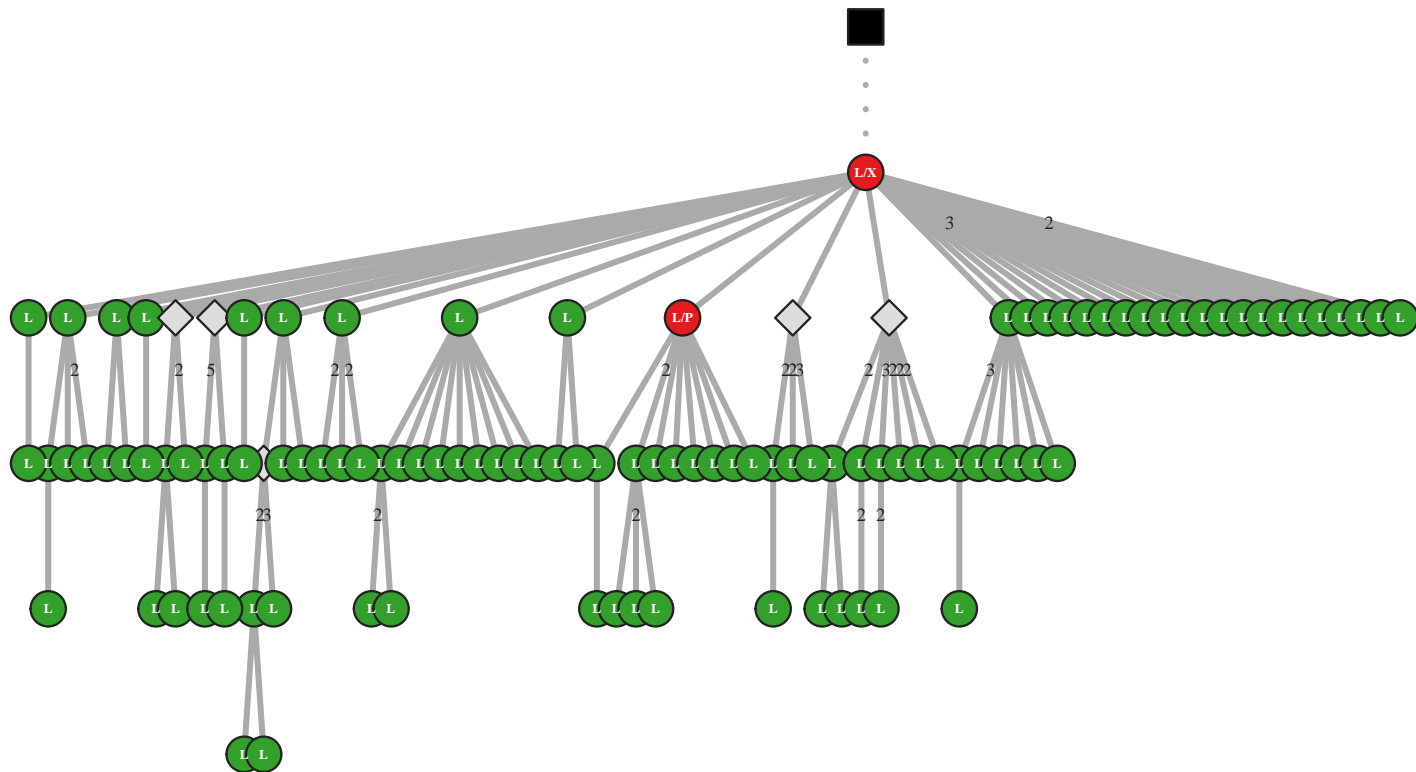

M5 IgG IGHV2-5/J3 57bp (50616)

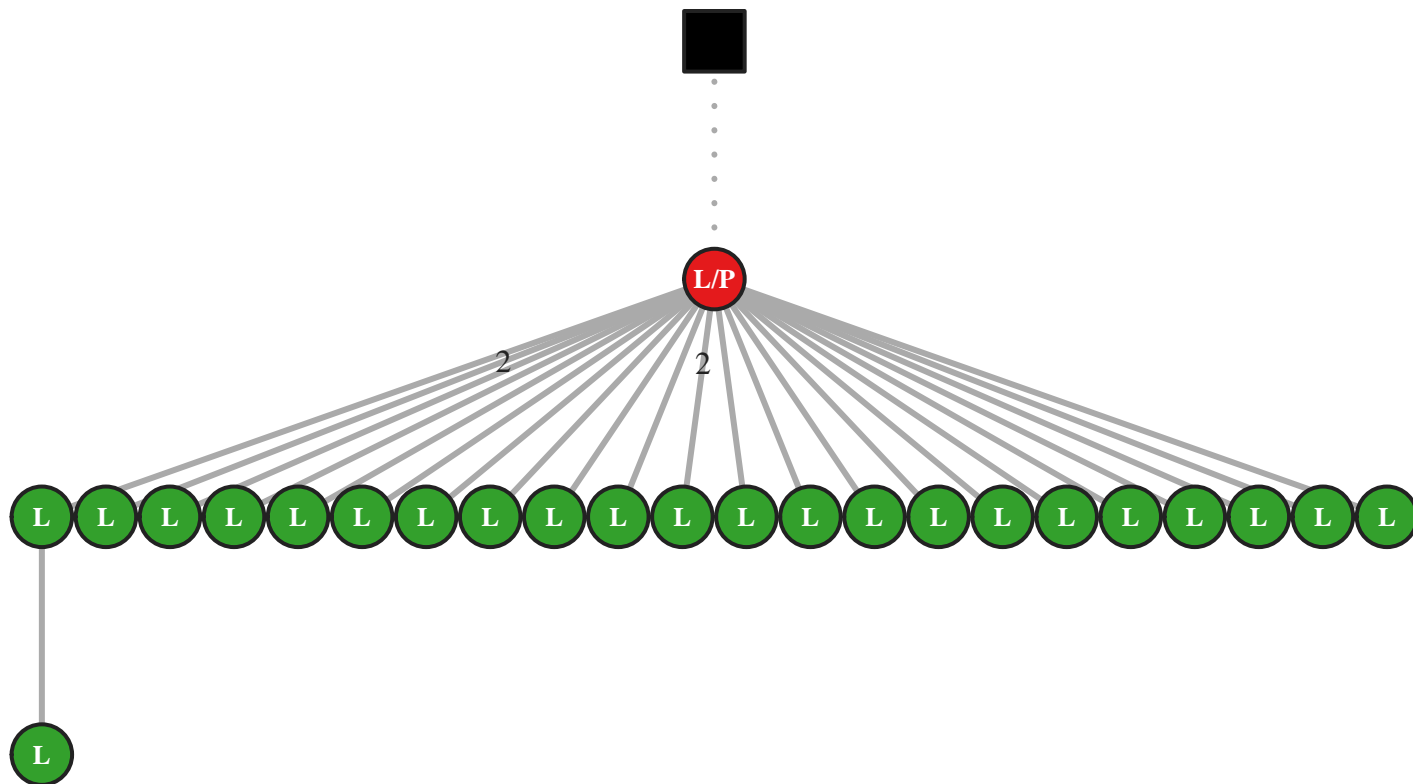

M5 IgG IGHV2-5/J3 60bp (33360)

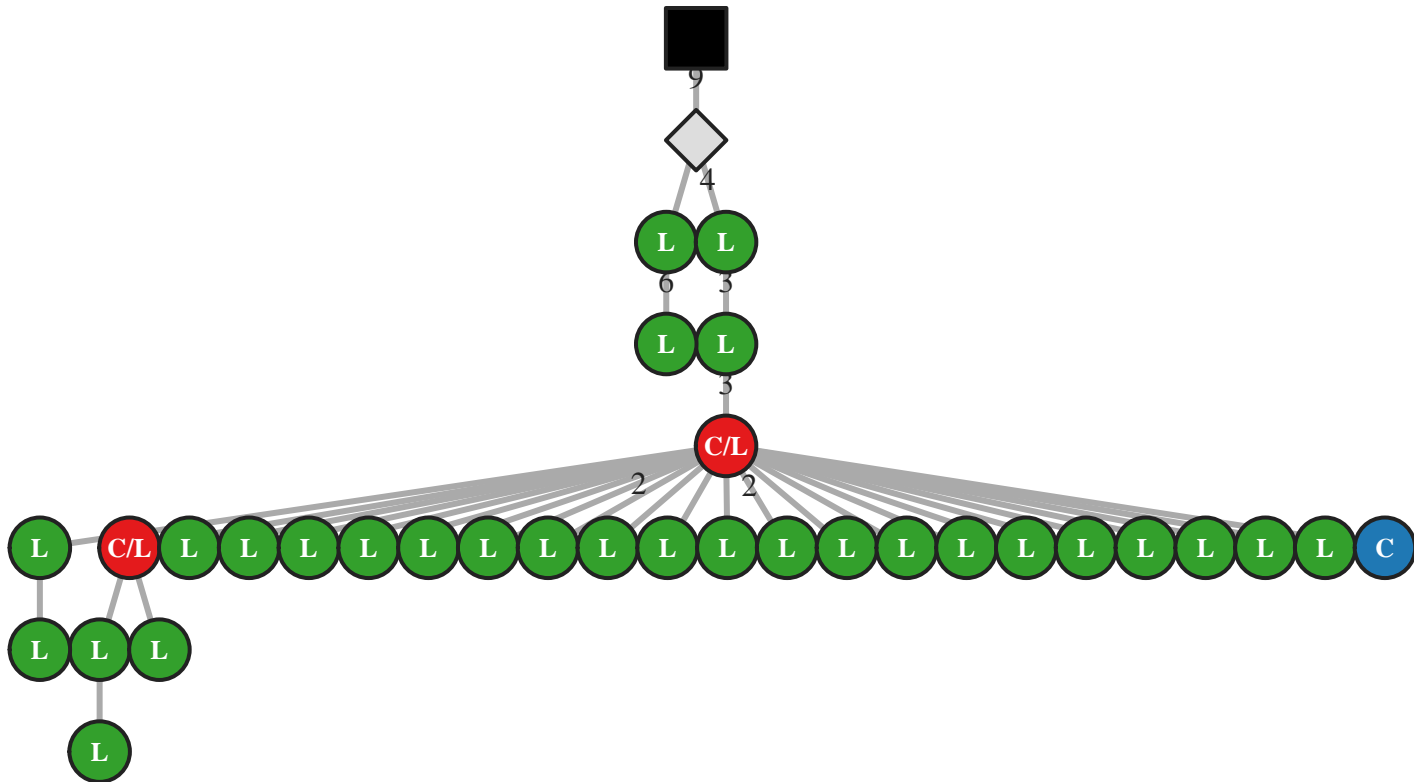

M5 IgG IGHV2-5/J3 60bp (33362)

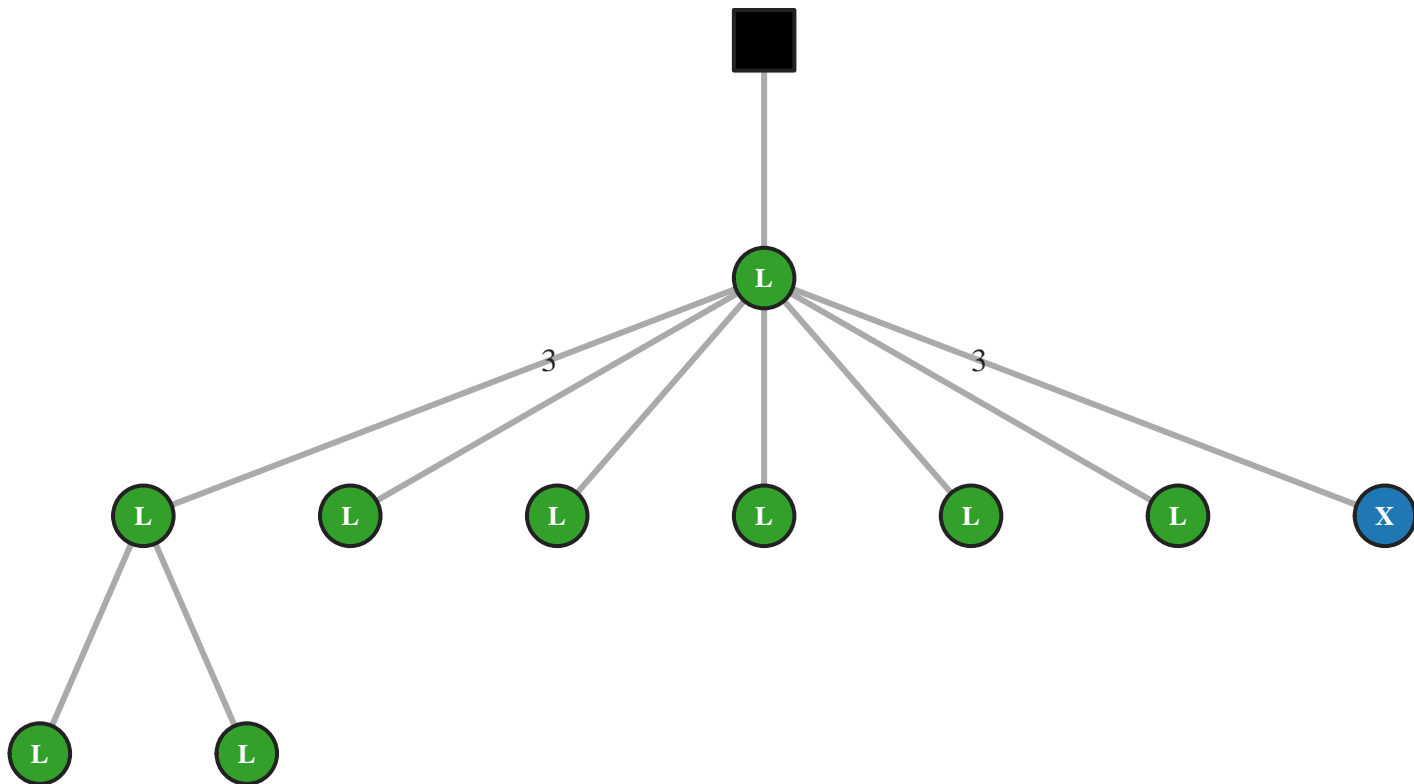

M5 IgG IGHV2-5/J3 60bp (33389)

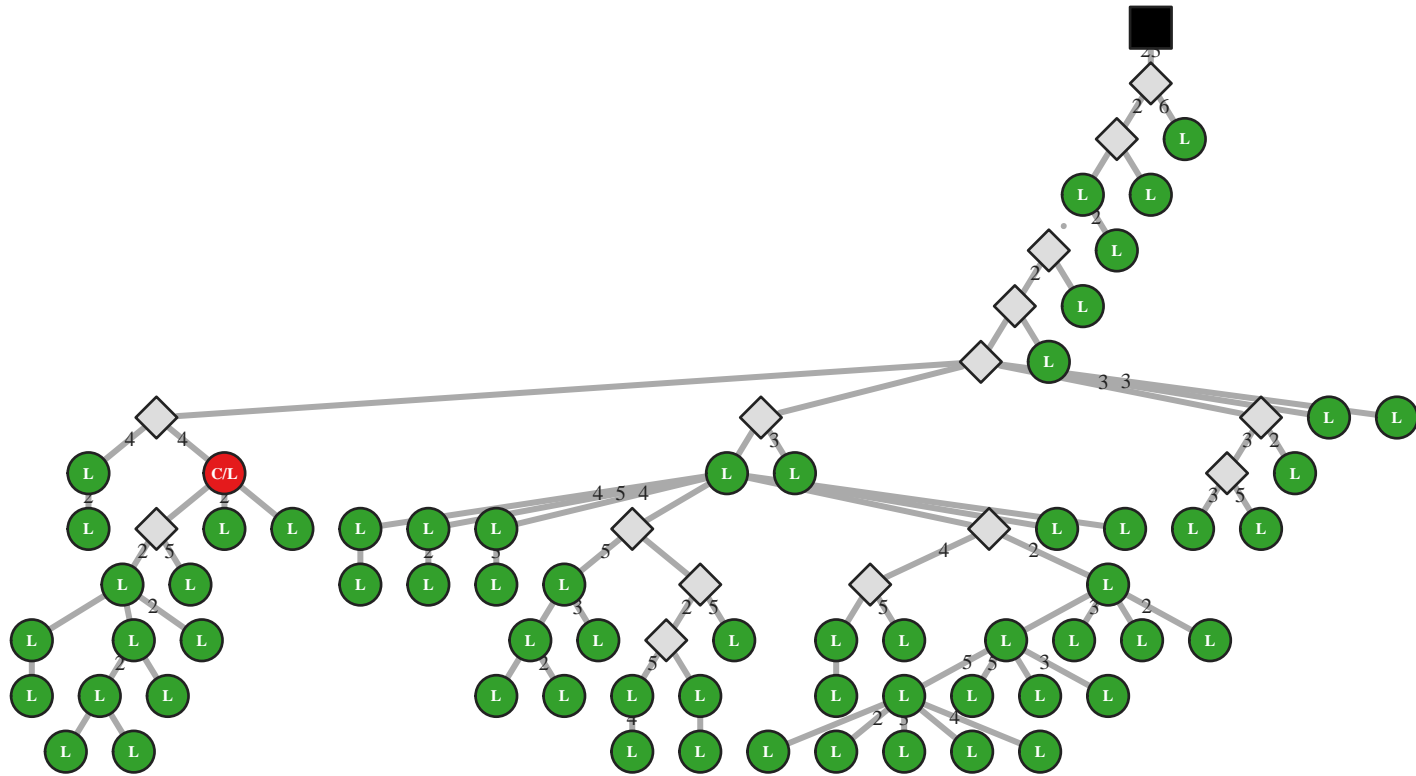

M5 IgG IGHV2-5/J3 63bp (42633)

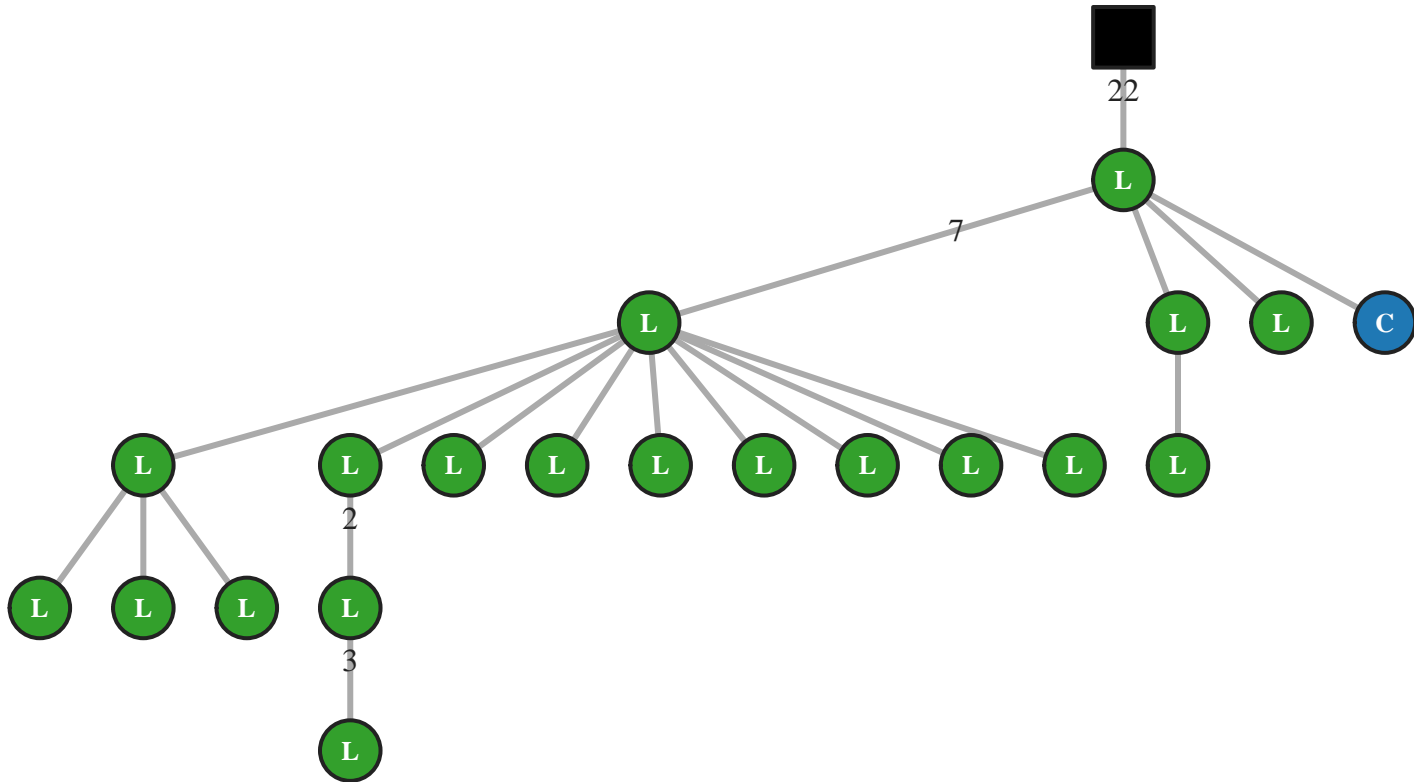

M5 IgG IGHV2-5/J3 69bp (15275)

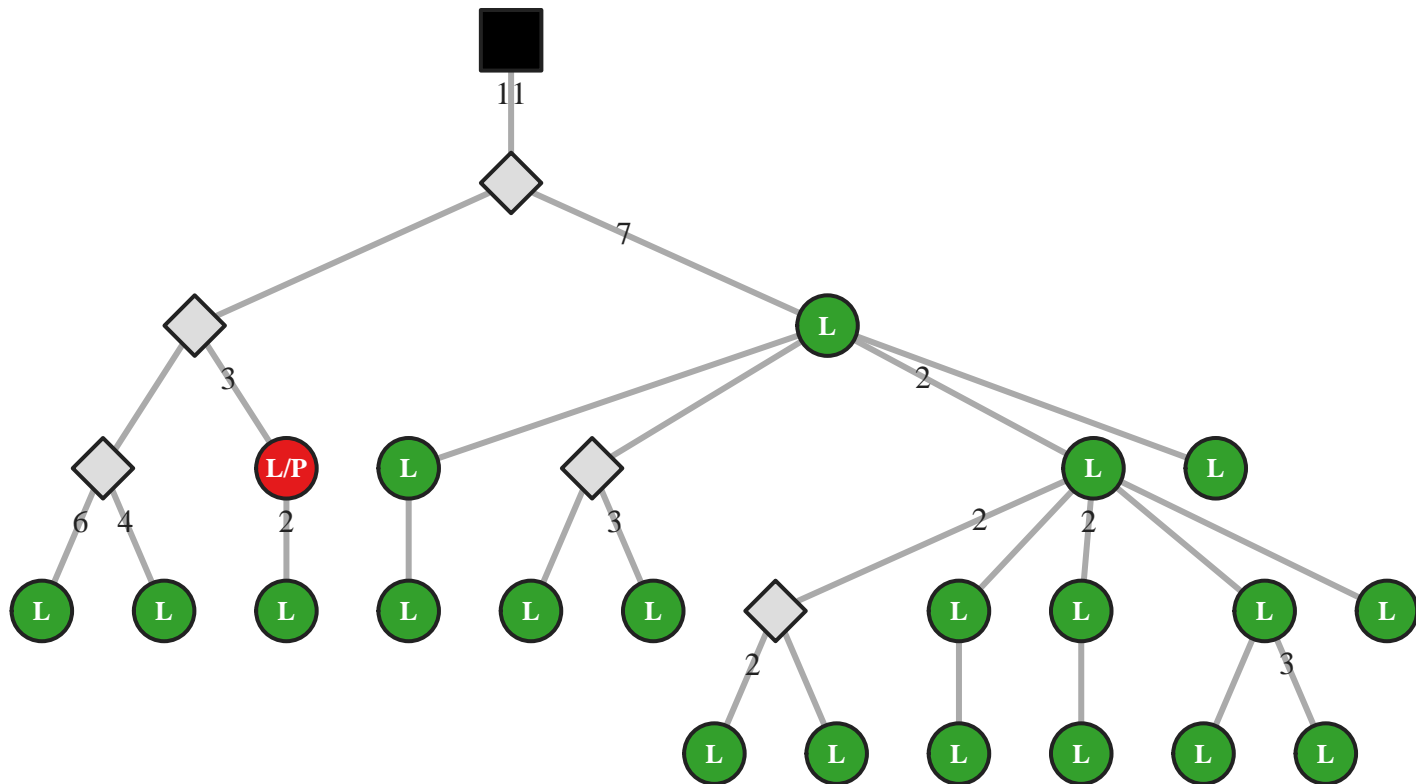

M5 IgG IGHV2-5/J3 69bp (15278)

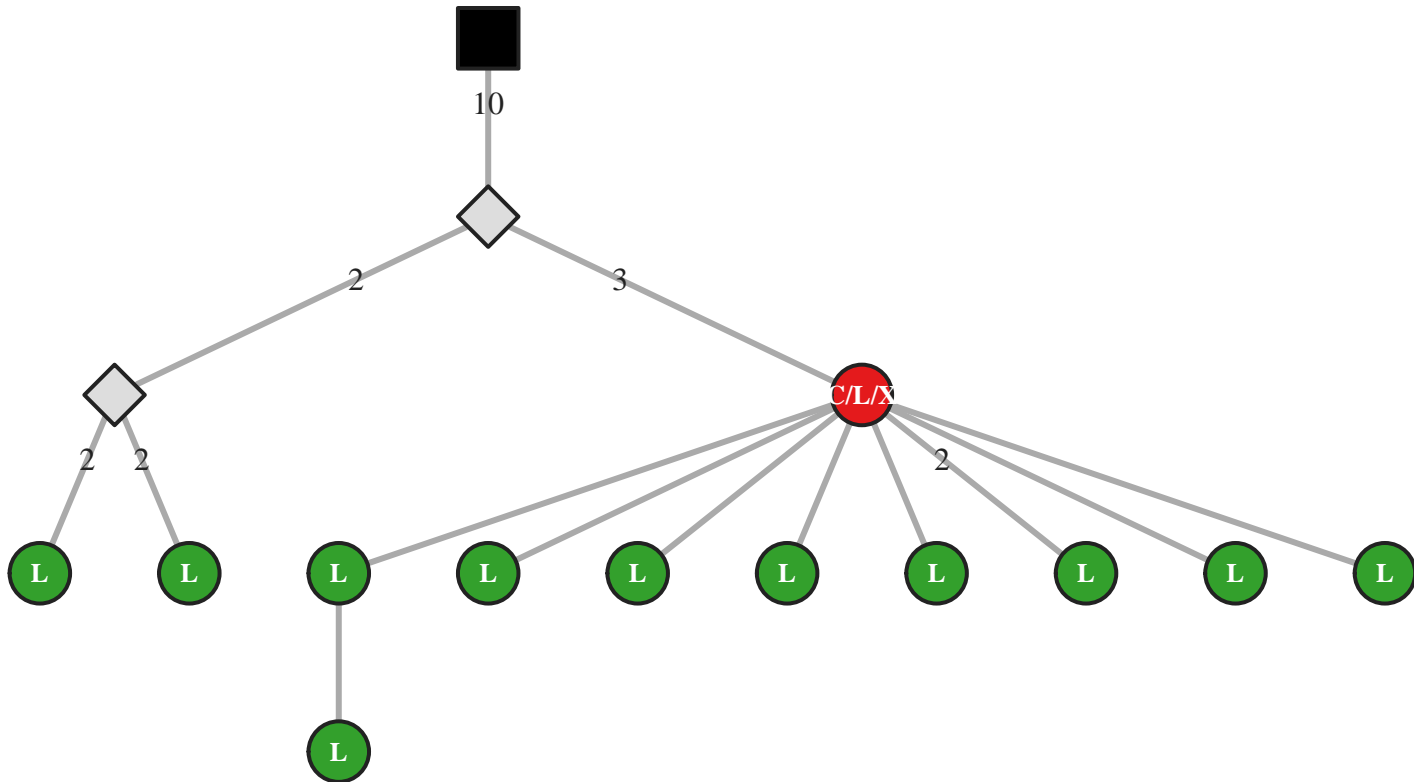

M5 IgG IGHV2-5/J4 24bp (50628)

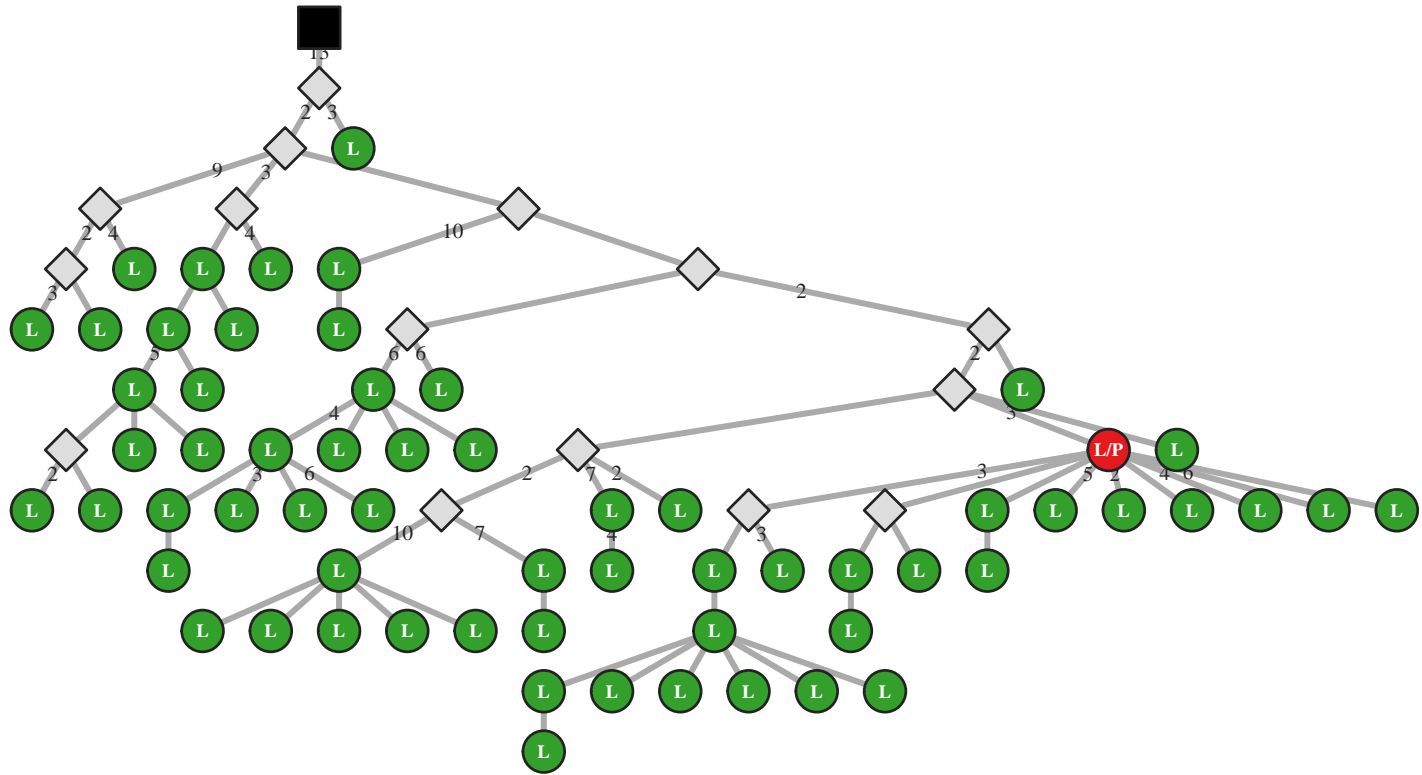

M5 IgG IGHV2-5/J4 36bp (42649)

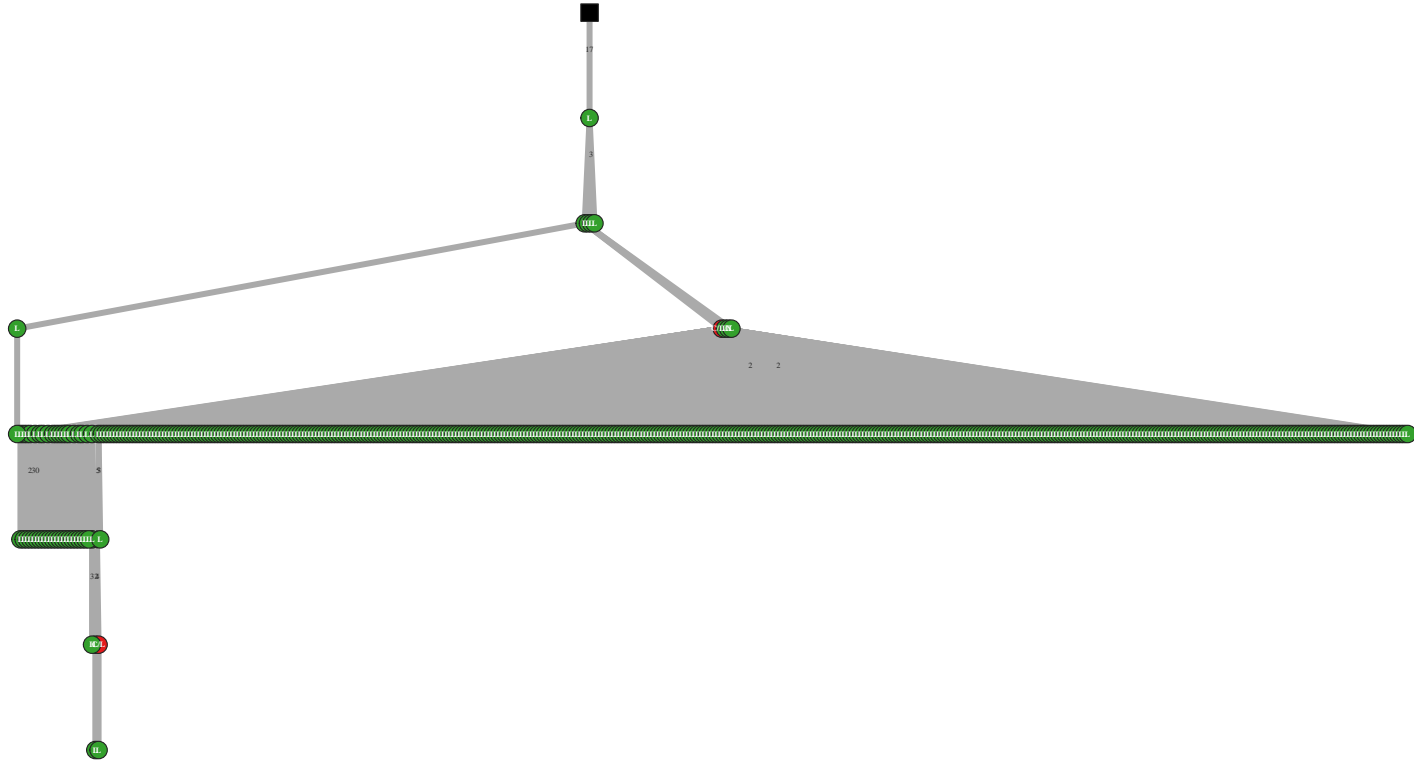

M5 IgG IGHV2-5/J4 36bp (42669)

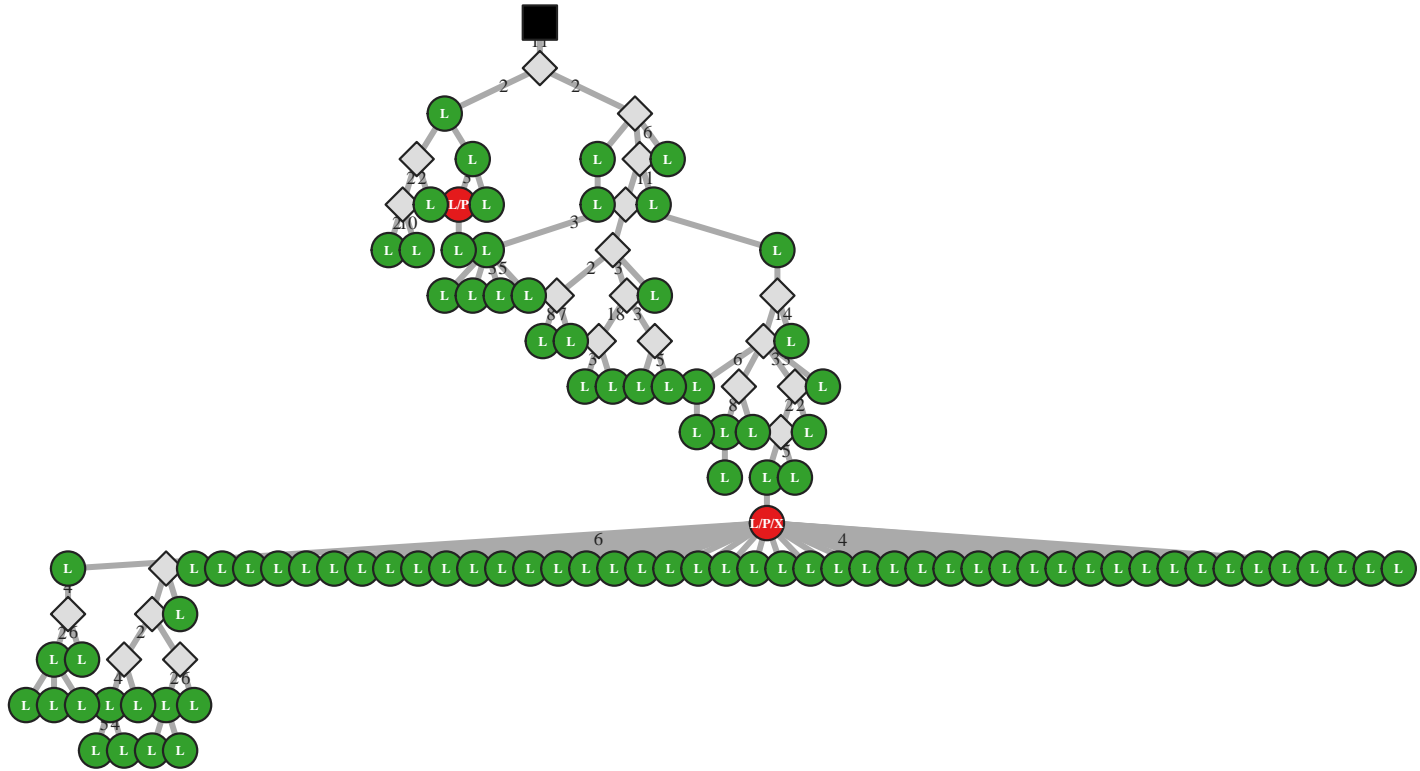

M5 IgG IGHV2-5/J4 39bp (33400)

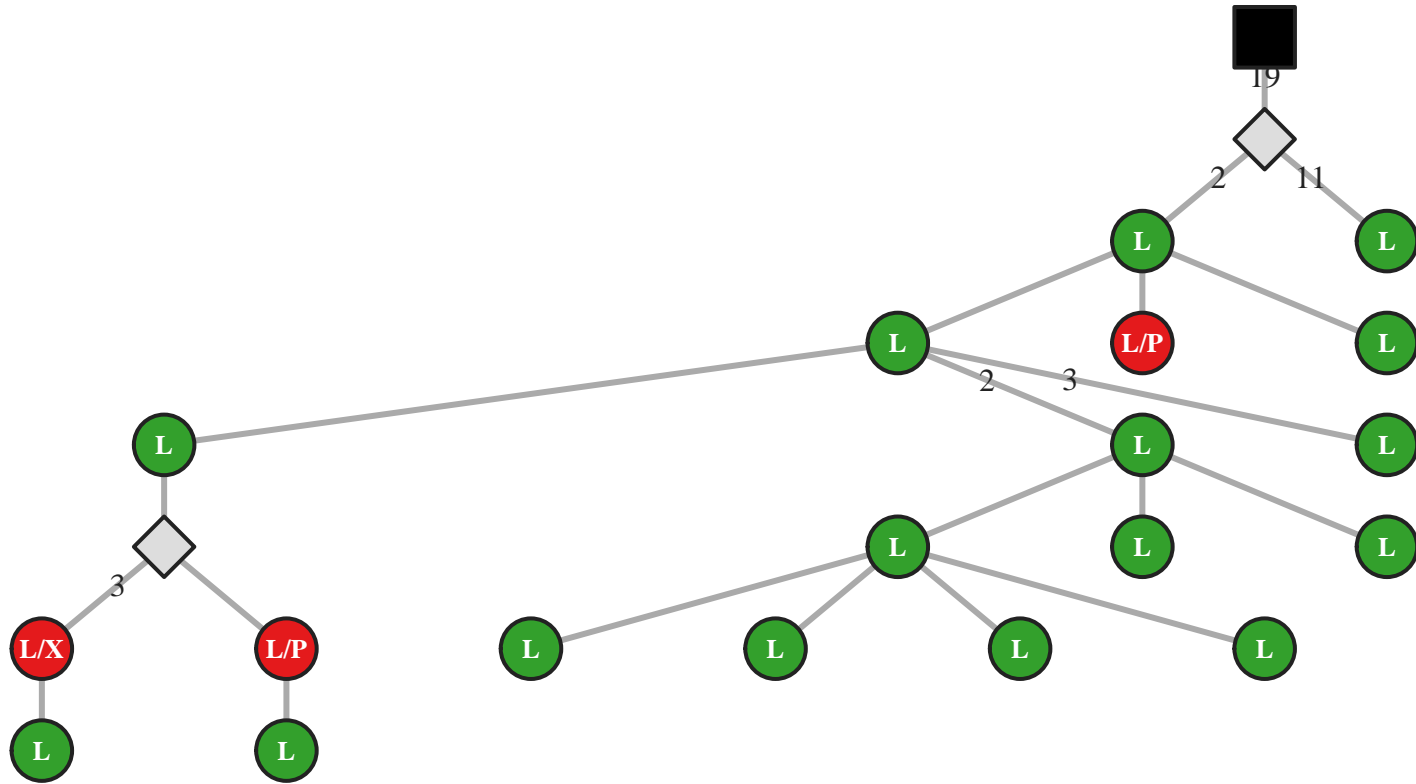

M5 IgG IGHV2-5/J4 39bp (33429)

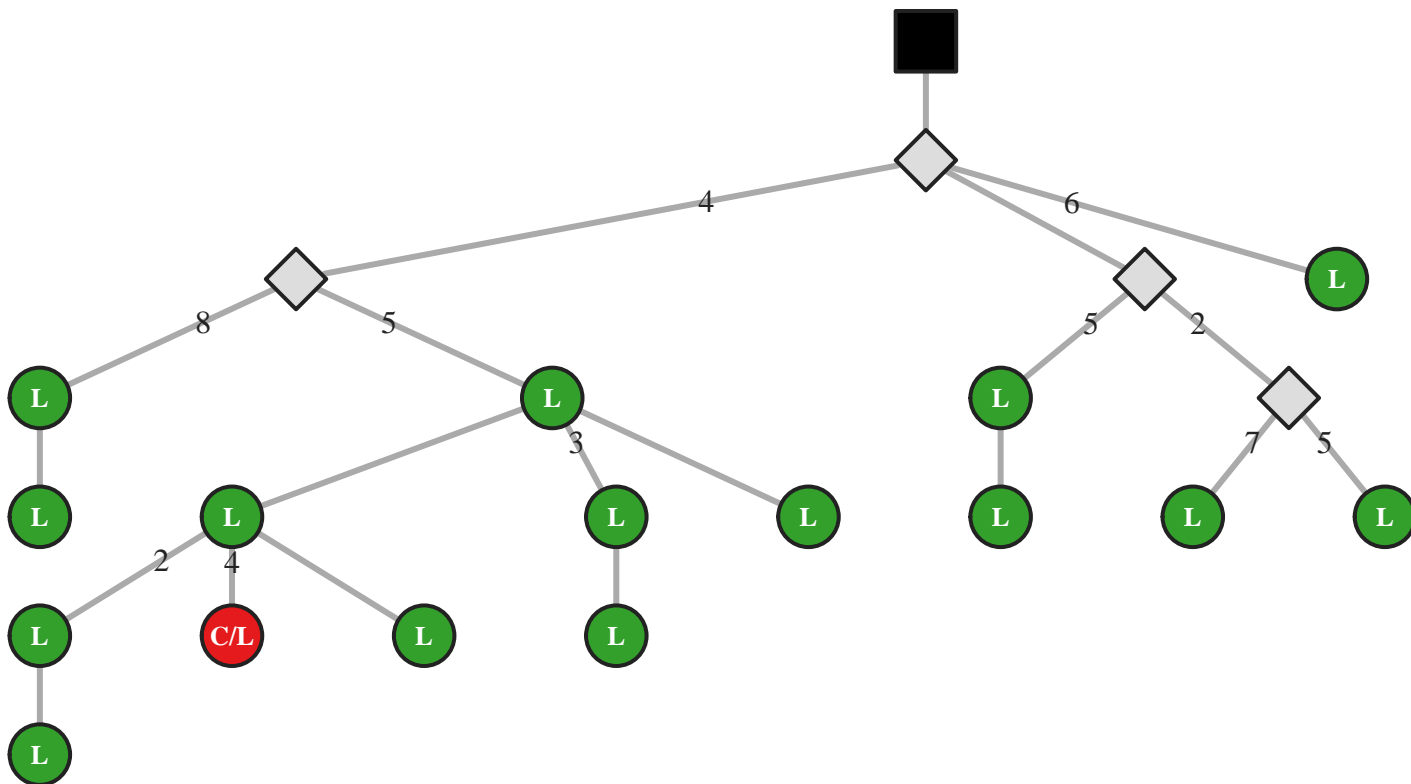

M5 IgA IGHV2-5/J4 42bp (21440)

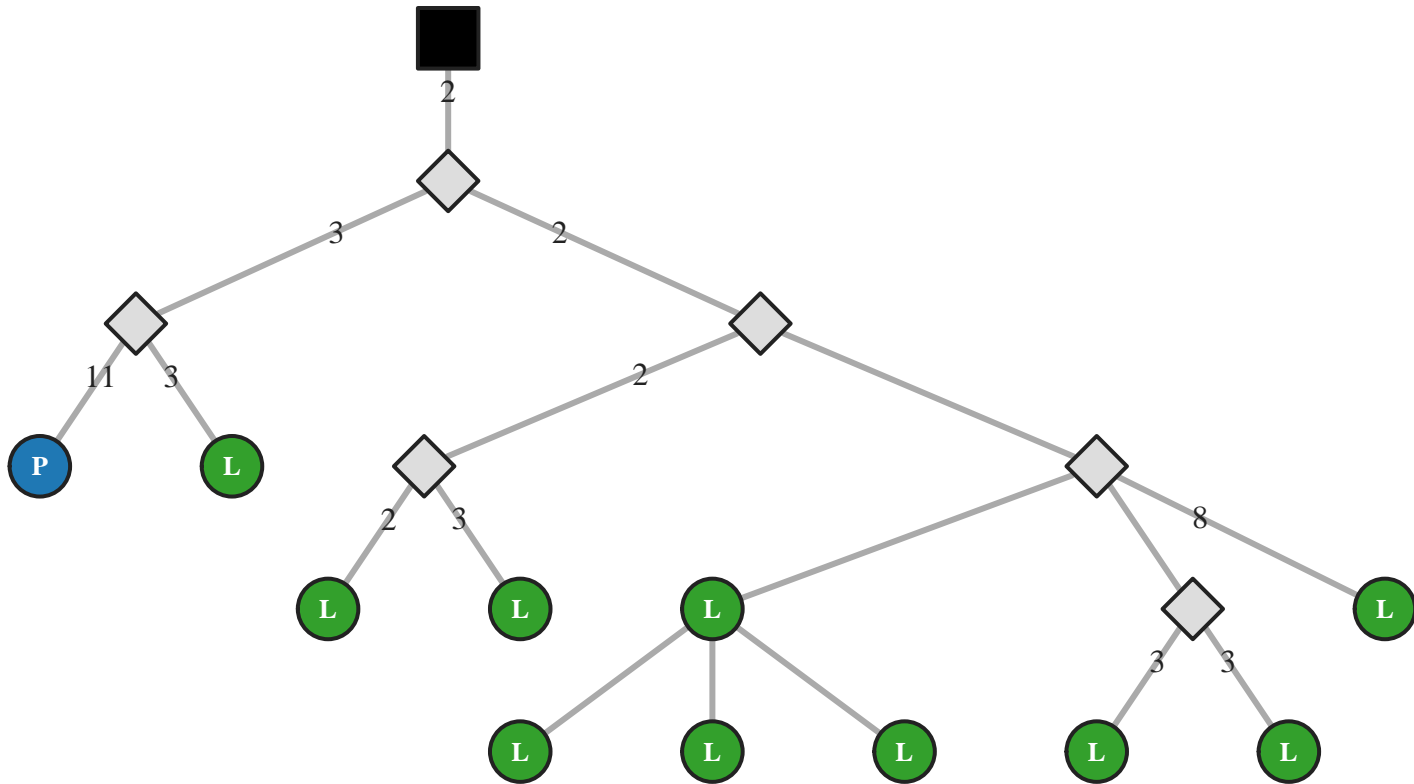

M5 IgA IGHV2-5/J4 42bp (21450)

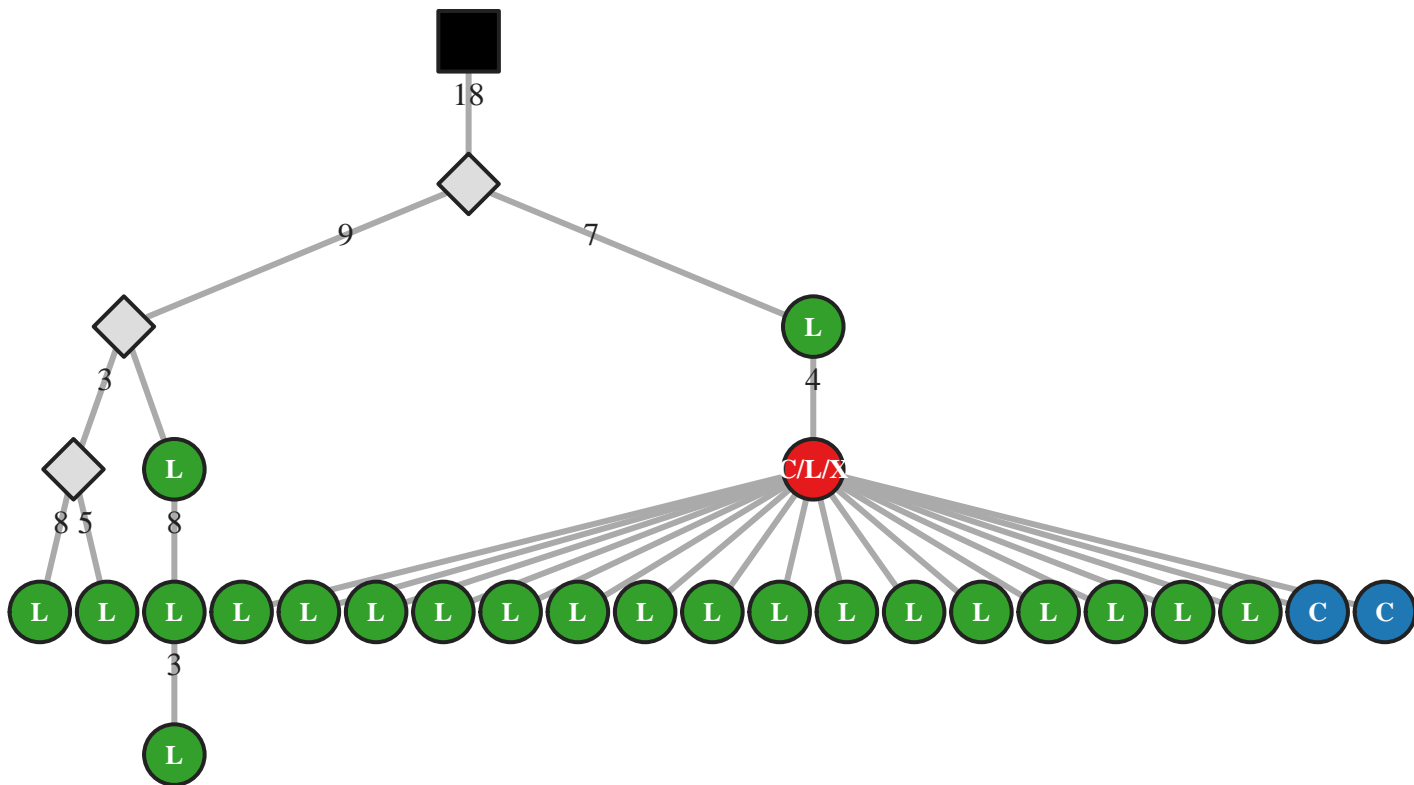

M5 IgA IGHV2-5/J4 42bp (21460)

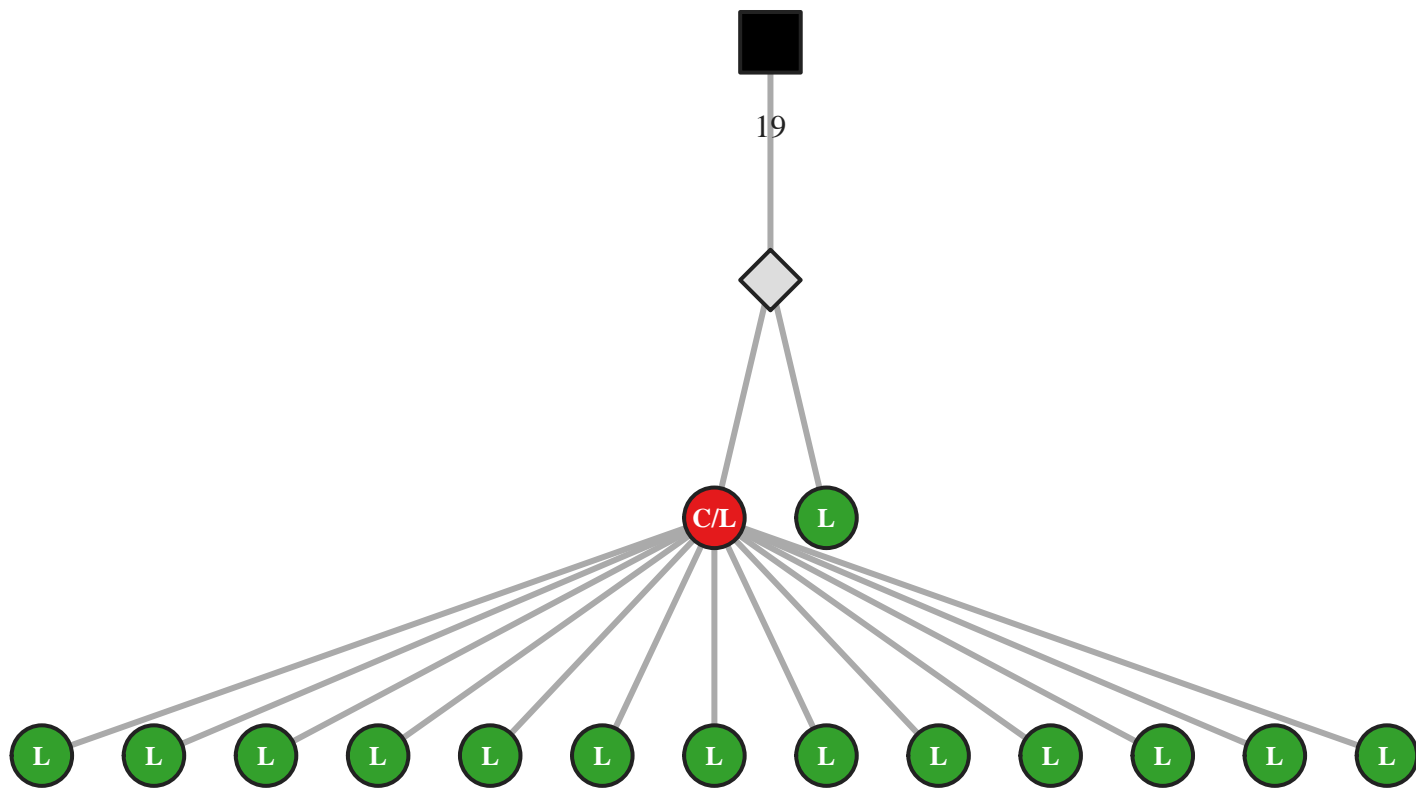

M5 IgA IGHV2-5/J4 42bp (21475)

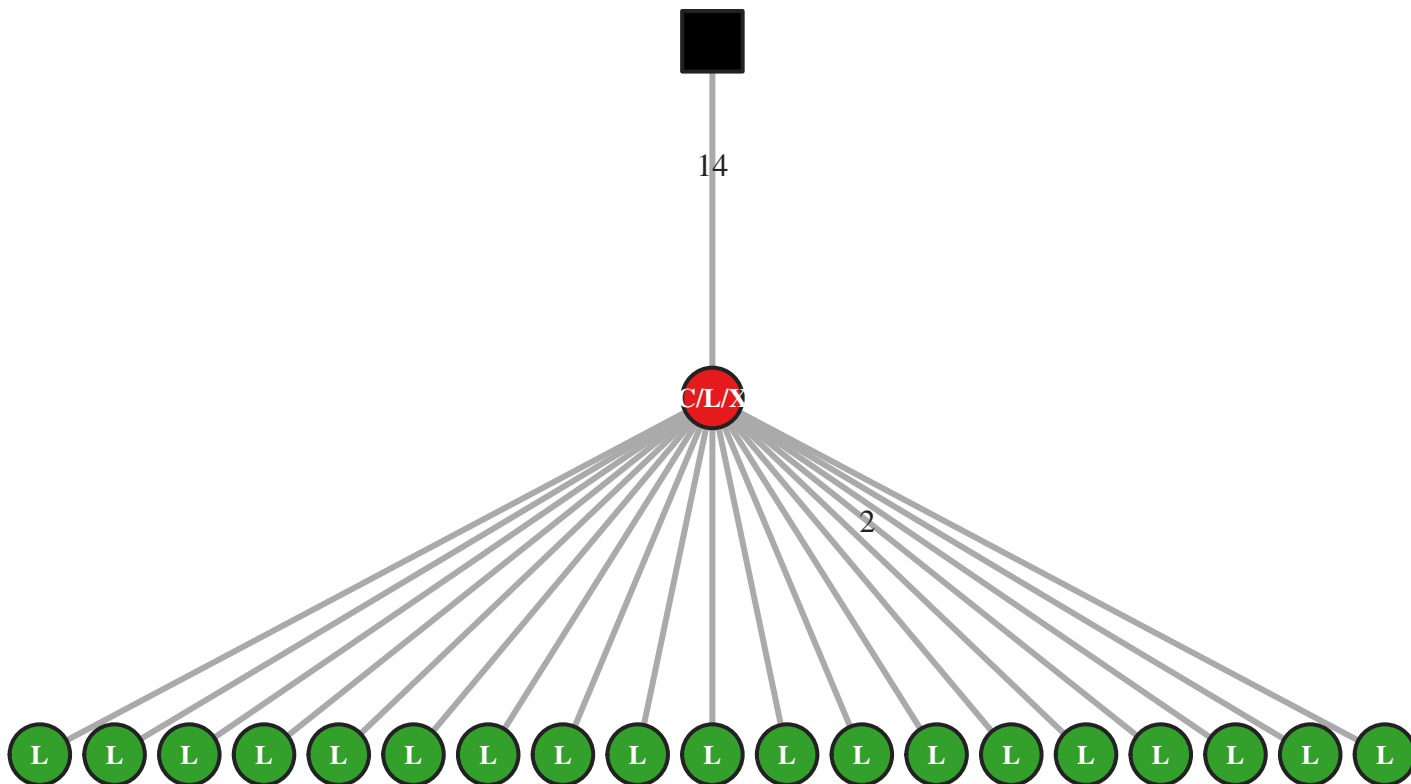

M5 IgG IGHV2-5/J4 42bp (15321)

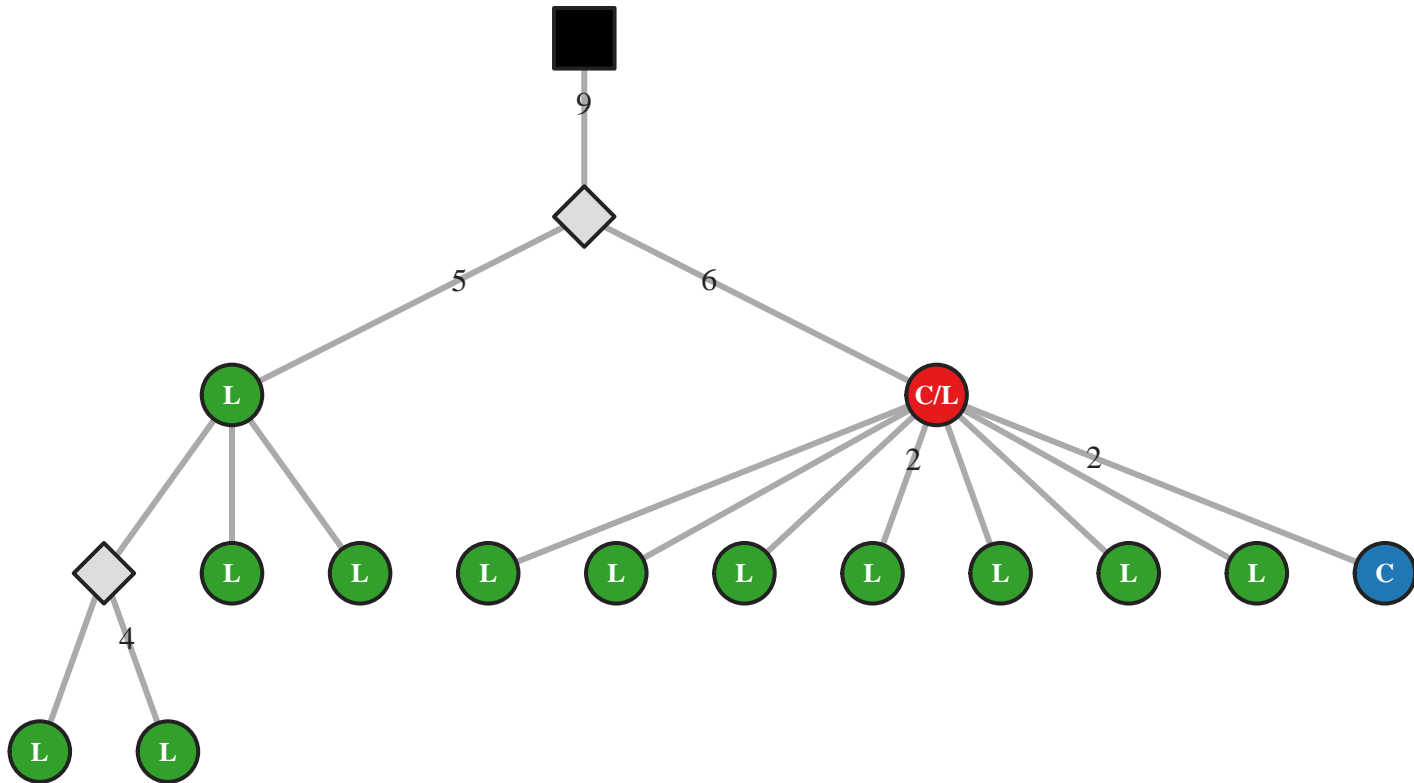

M5 IgG IGHV2-5/J4 42bp (15327)

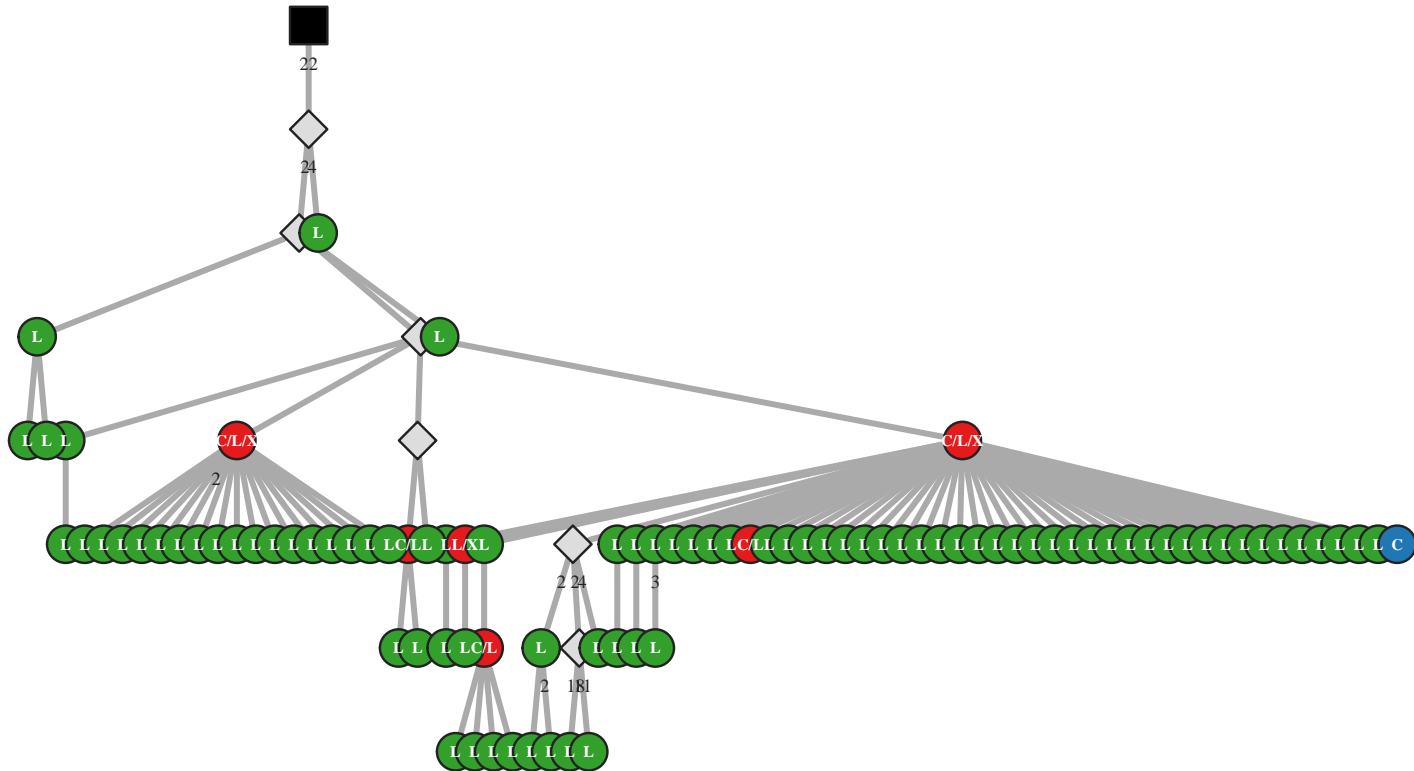

M5 IgG IGHV2-5/J4 42bp (15335)

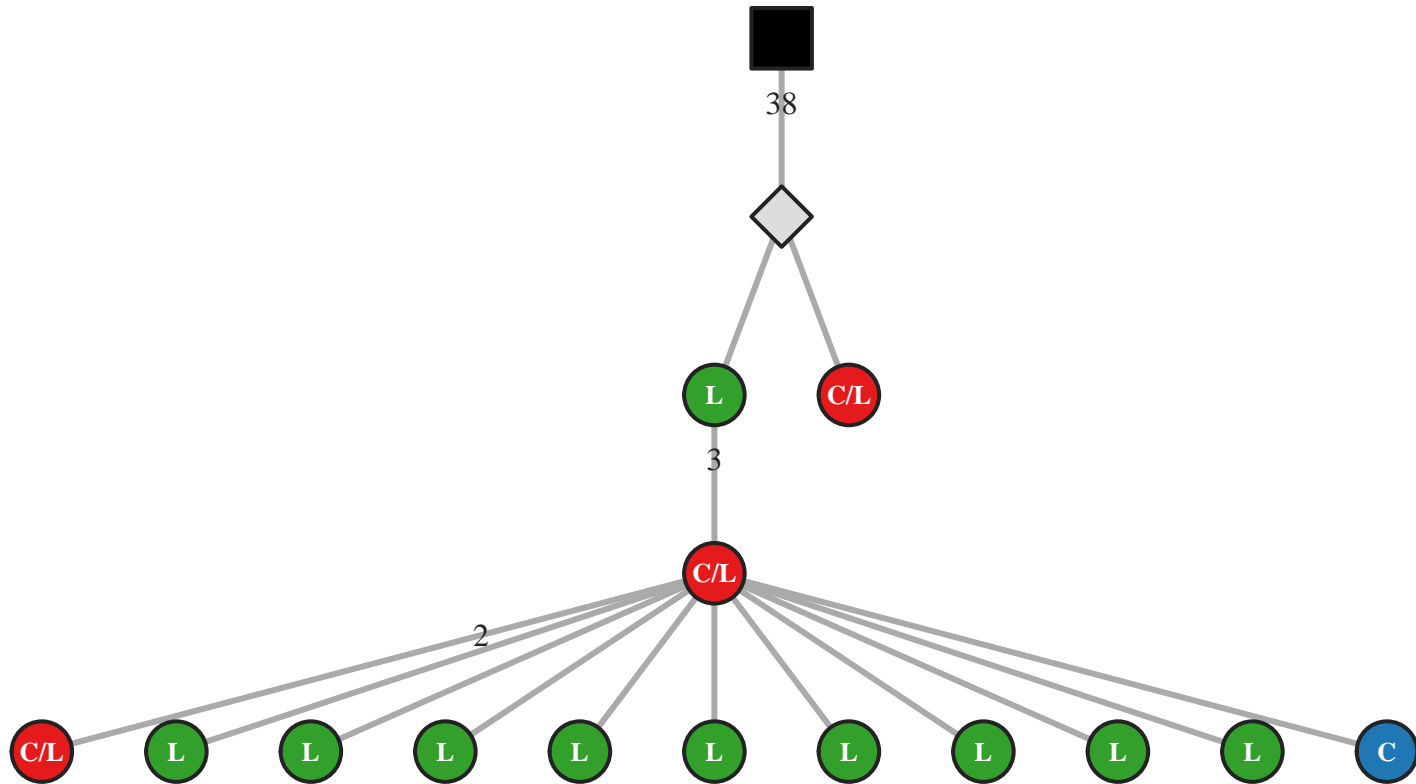

M5 IgG IGHV2-5/J4 42bp (15337)

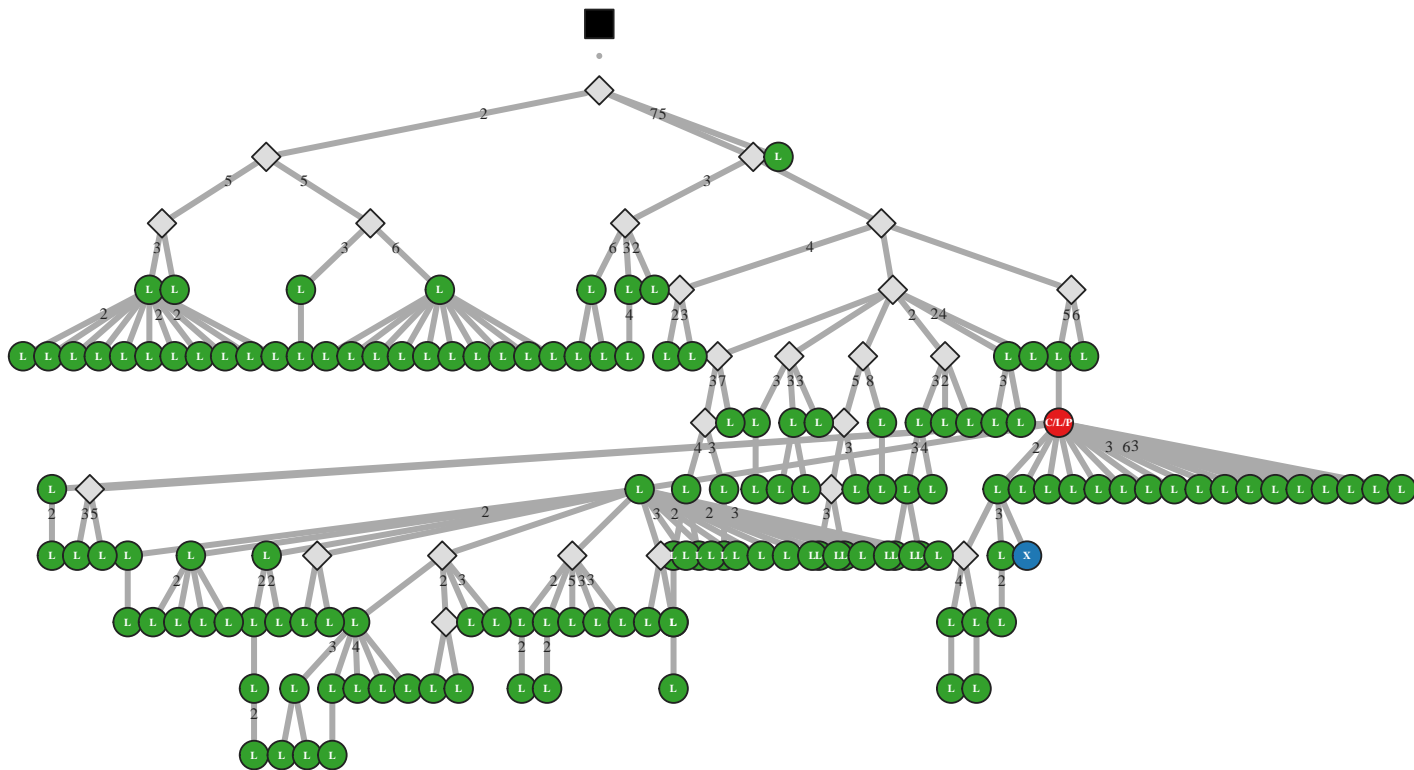

M5 IgG IGHV2-5/J4 42bp (15346)

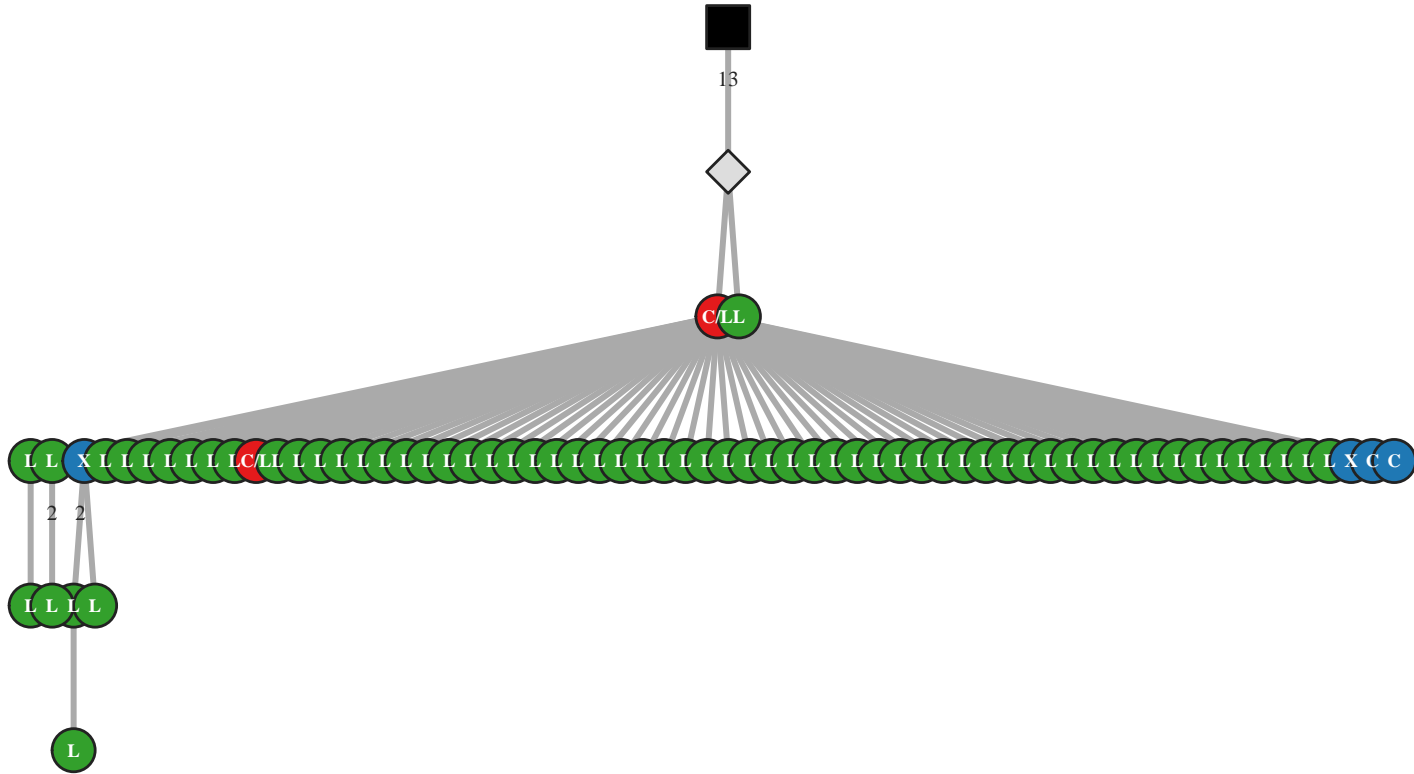

M5 IgG IGHV2-5/J4 42bp (15359)

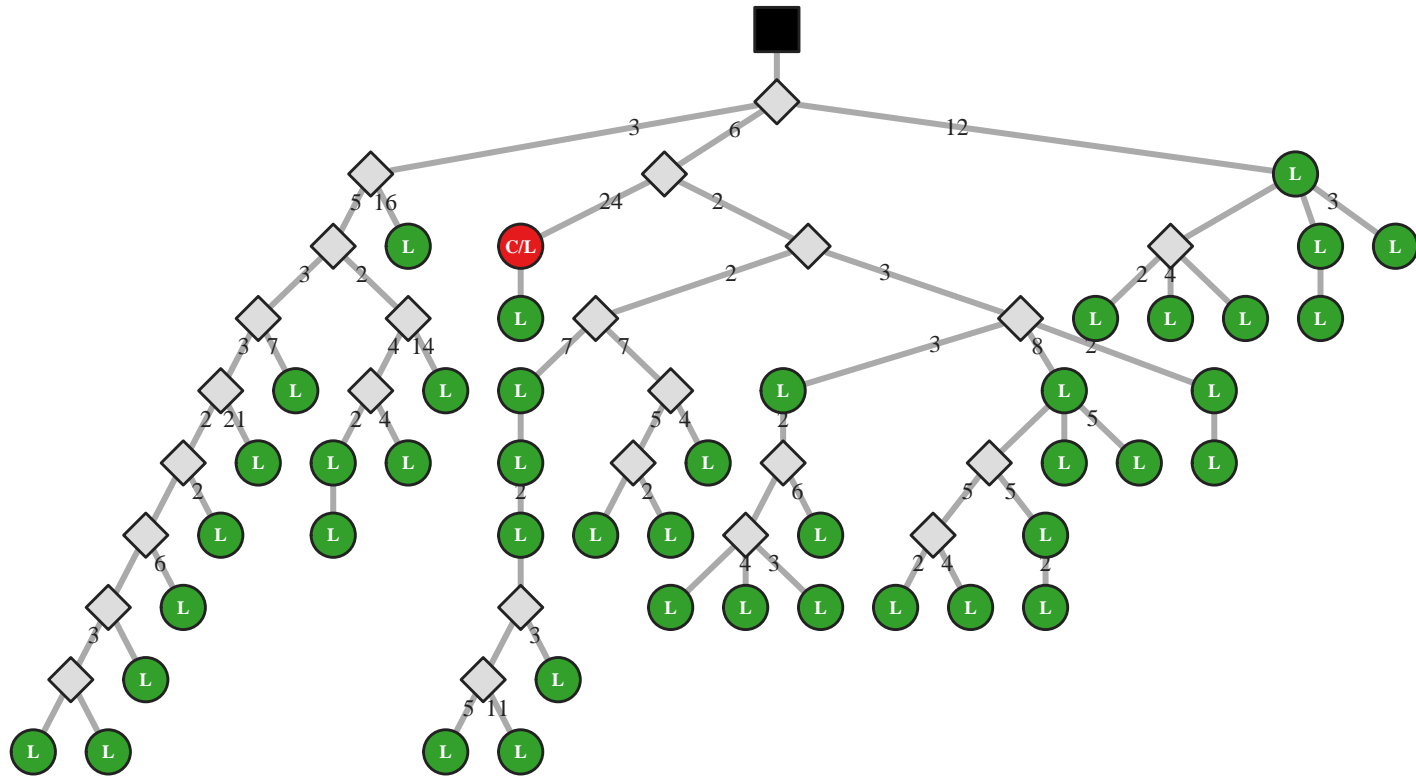

M5 IgG IGHV2-5/J4 42bp (15365)

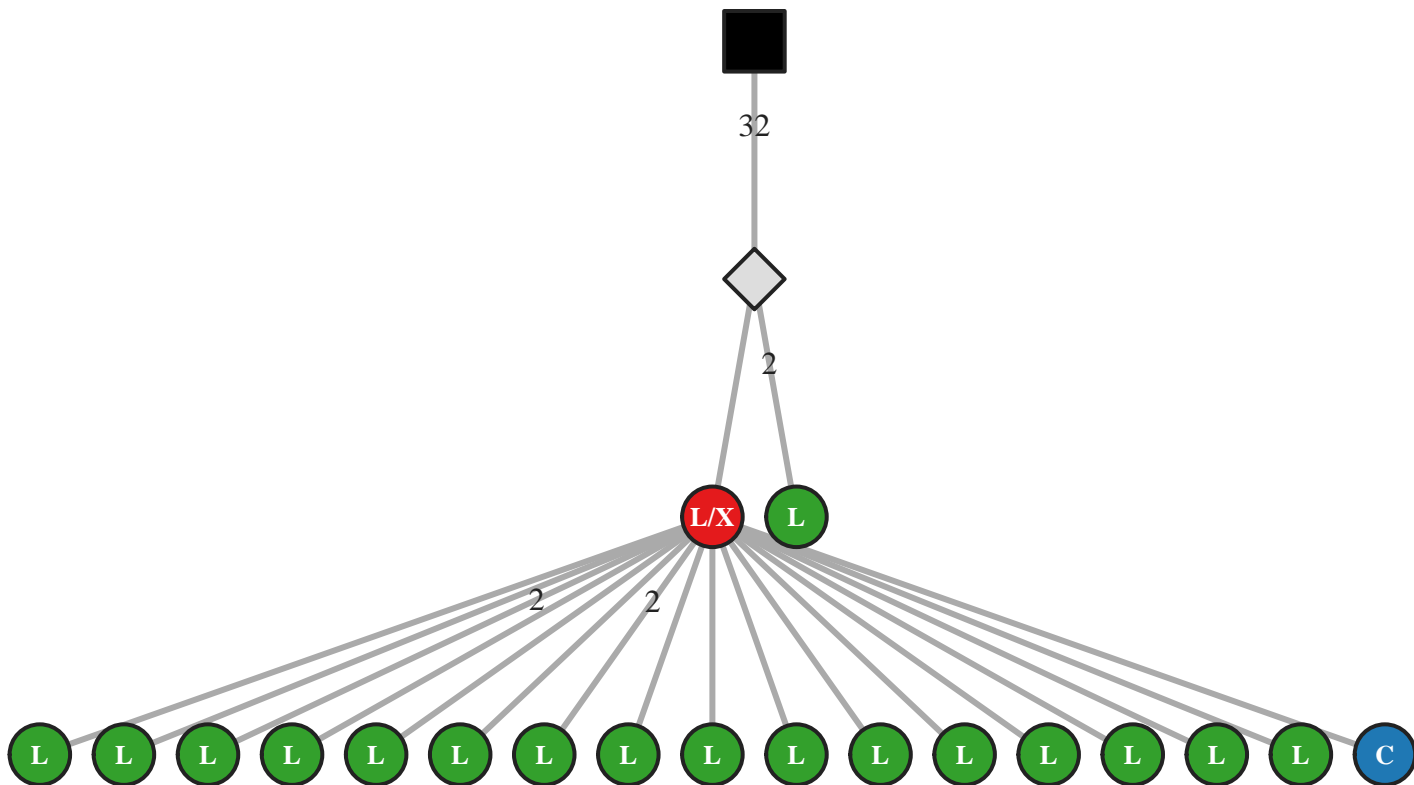

M5 IgG IGHV2-5/J4 42bp (15370)

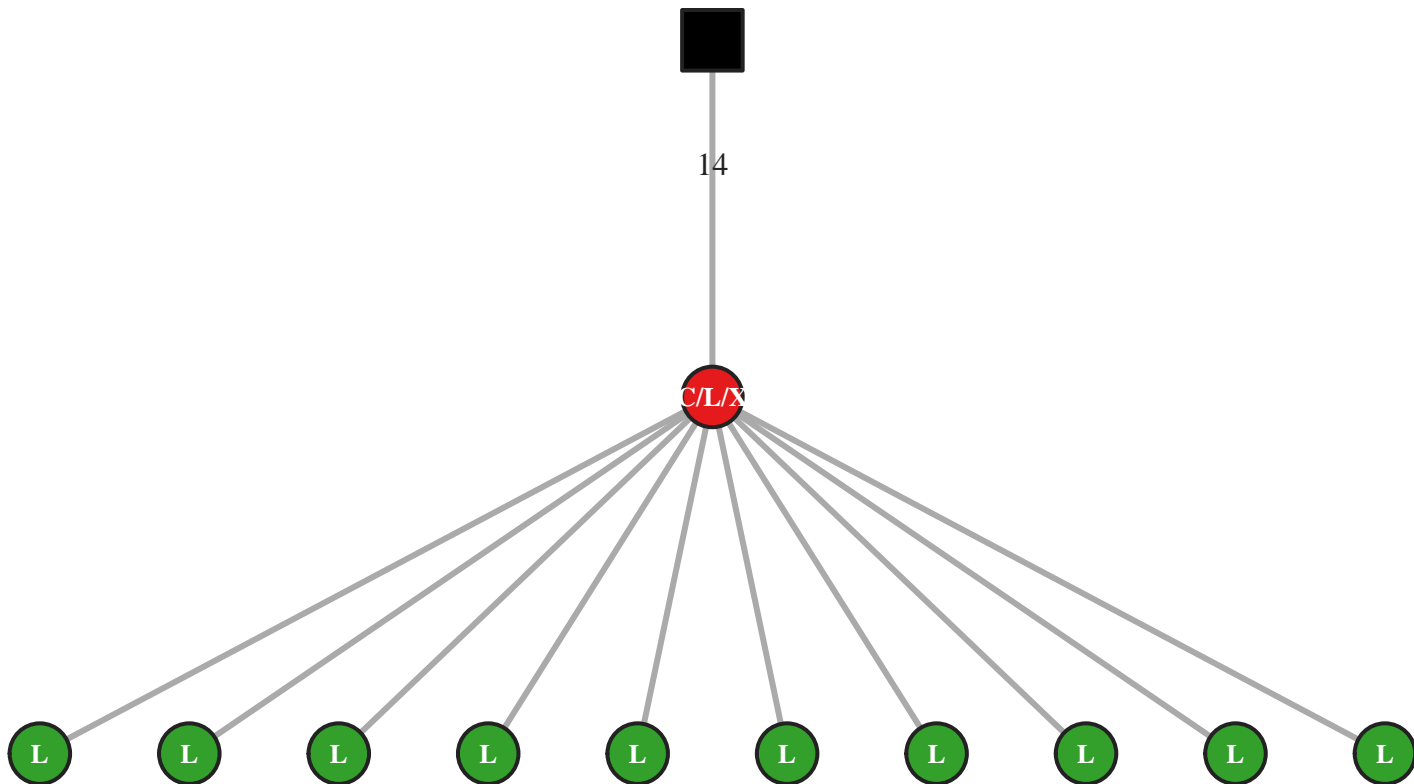

M5 IgG IGHV2-5/J4 42bp (15375)

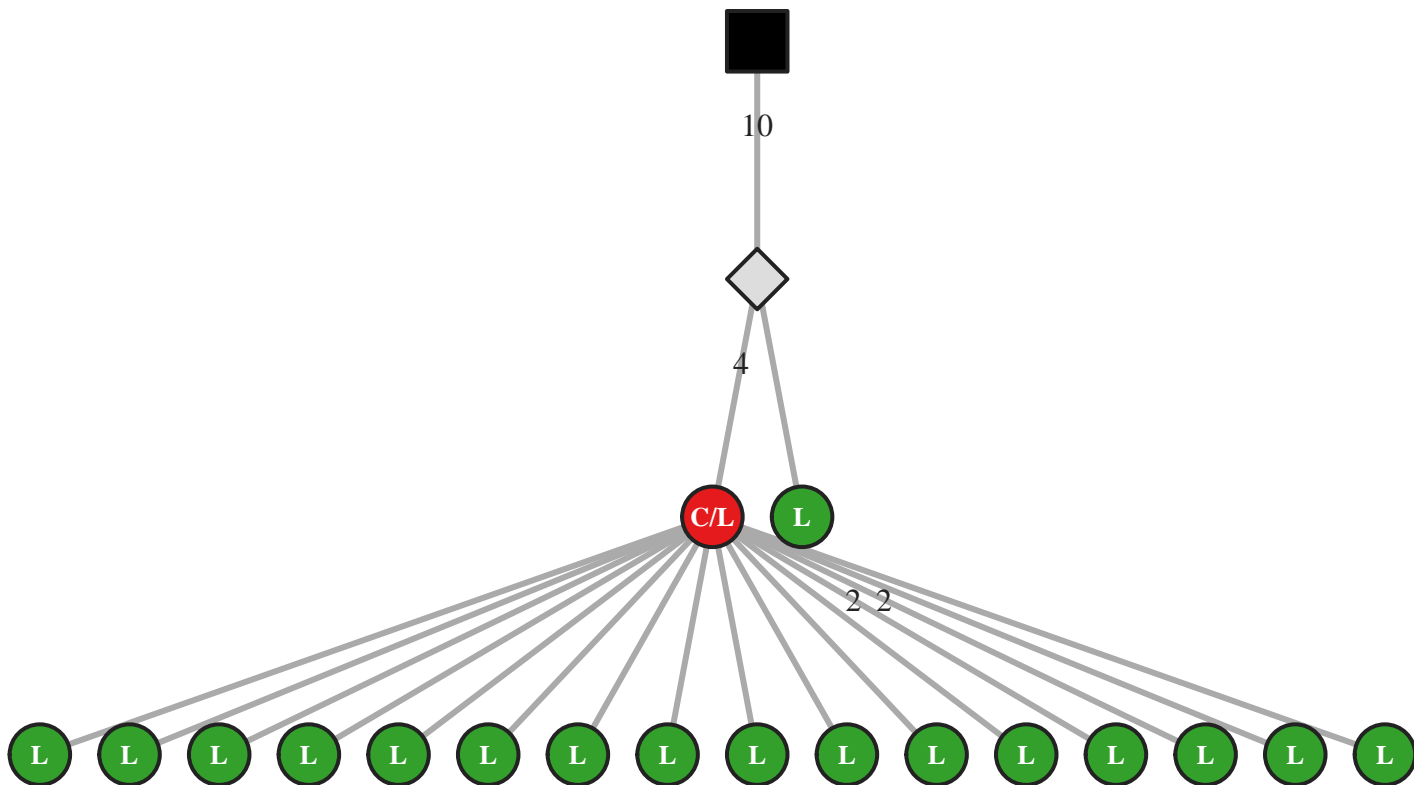

M5 IgG IGHV2-5/J4 42bp (15390)

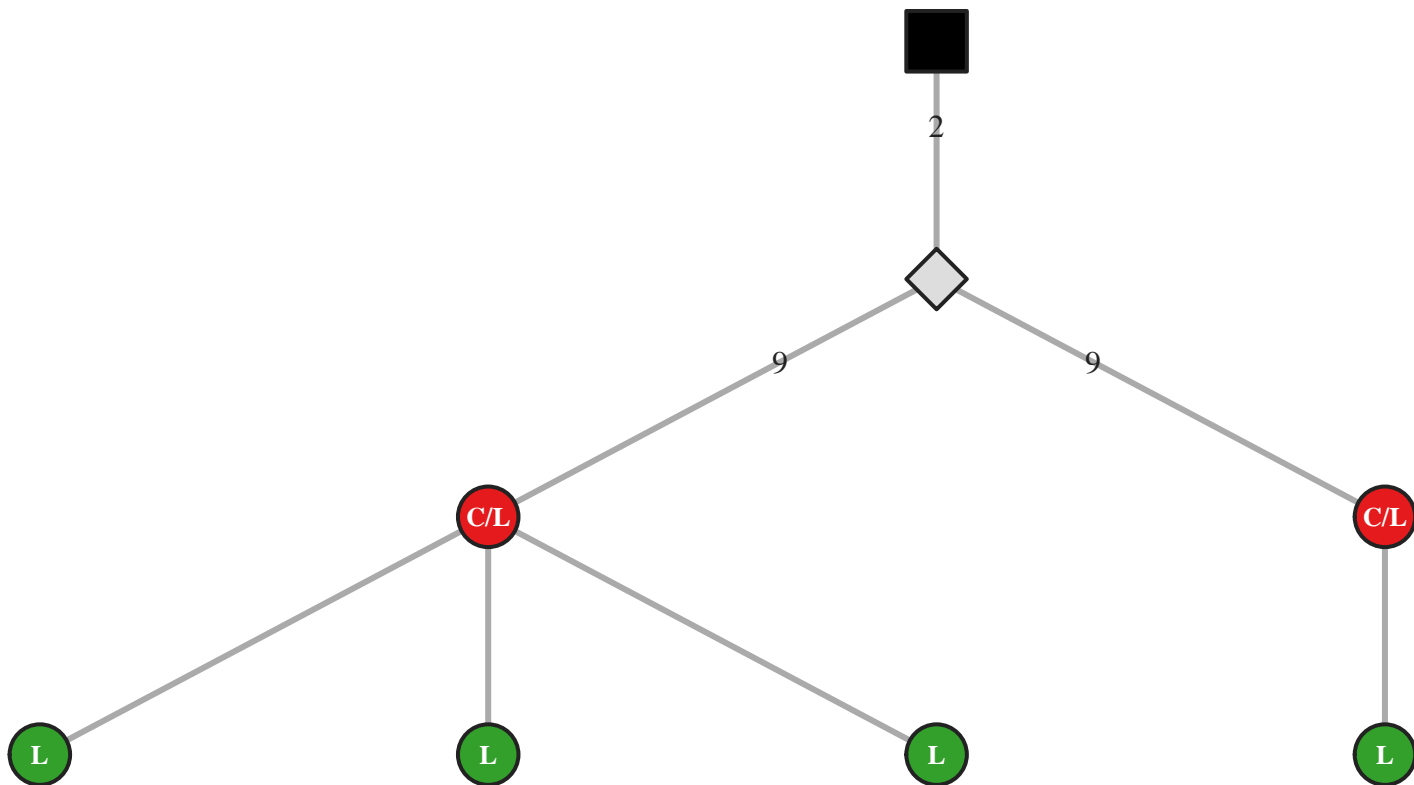

M5 IgG IGHV2-5/J4 42bp (15392)

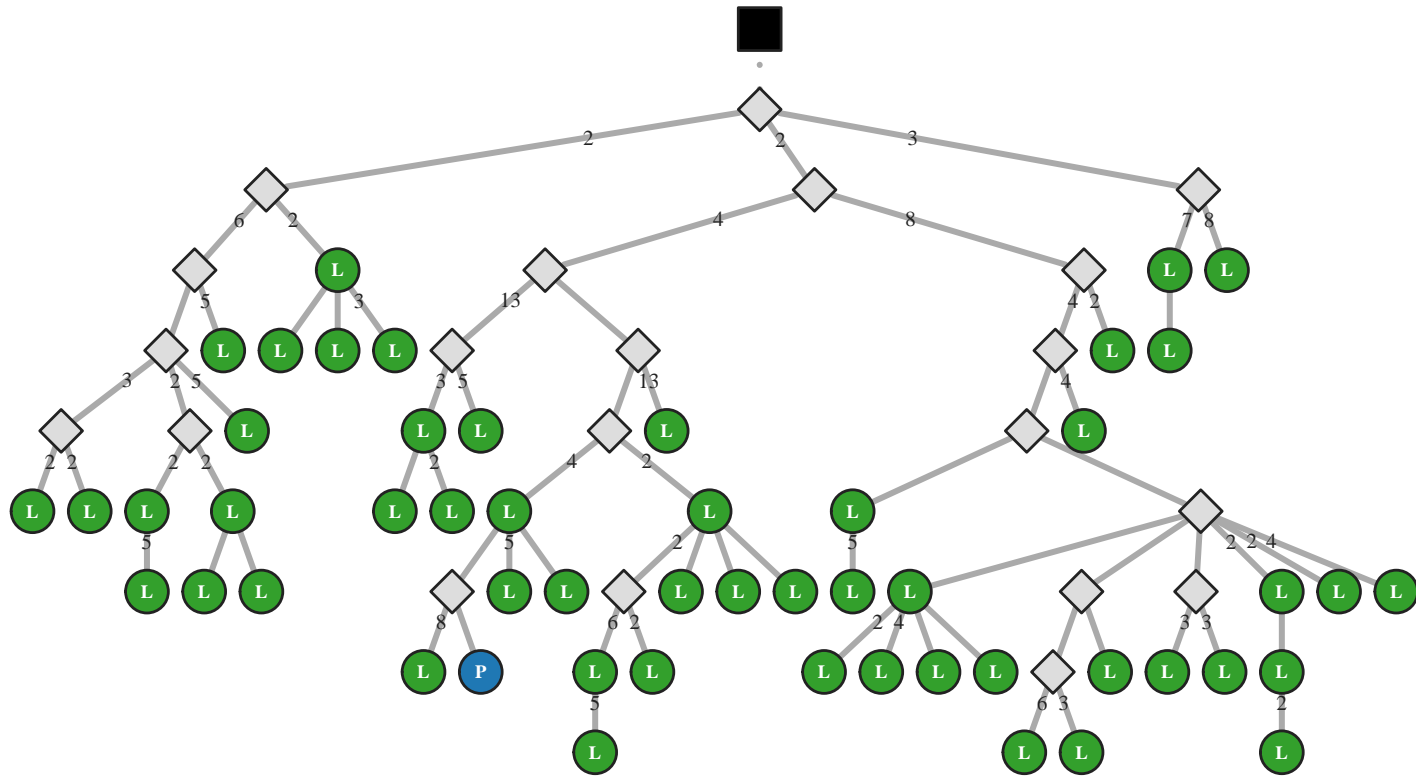

M5 IgM IGHV2-5/J4 42bp (37621)

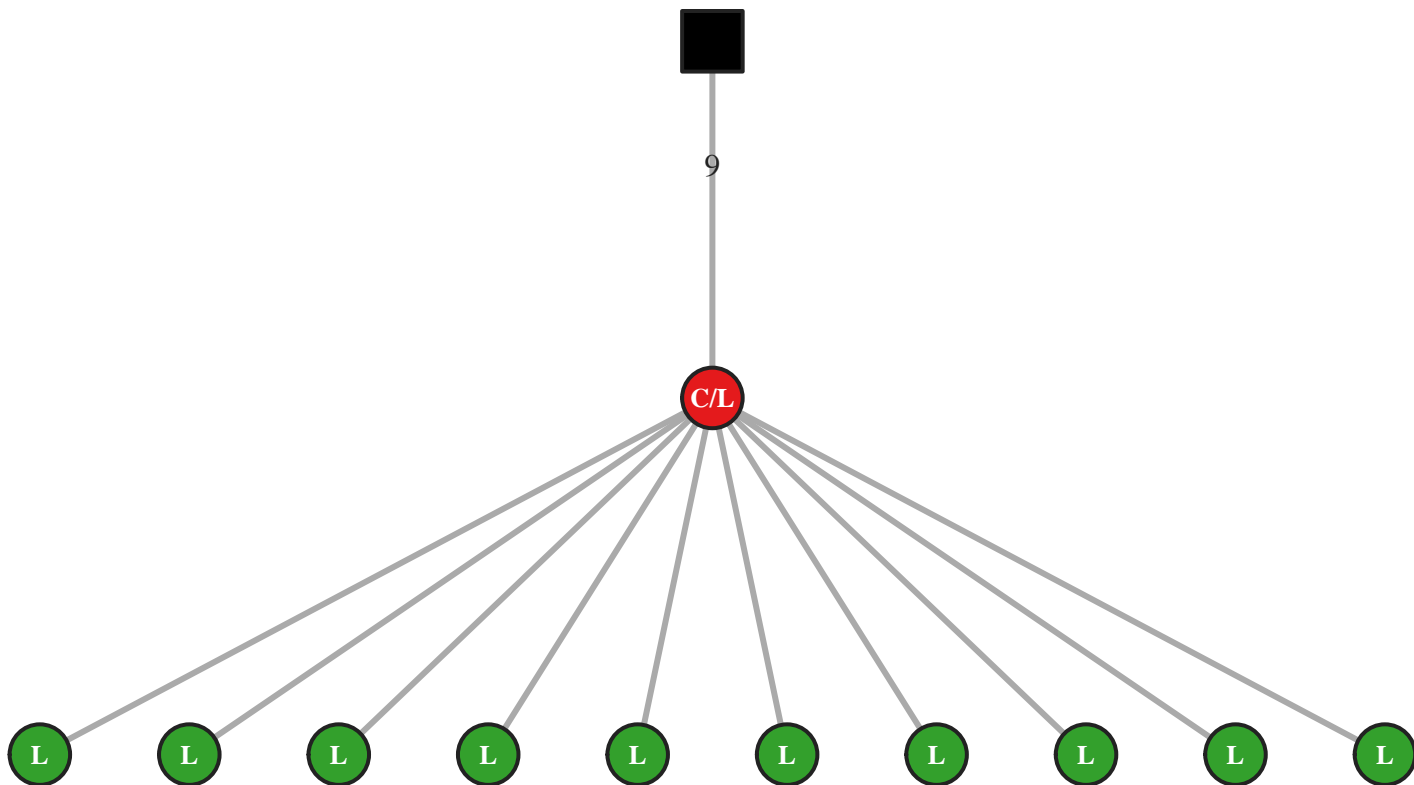

M5 IgG IGHV2-5/J4 45bp (15417)

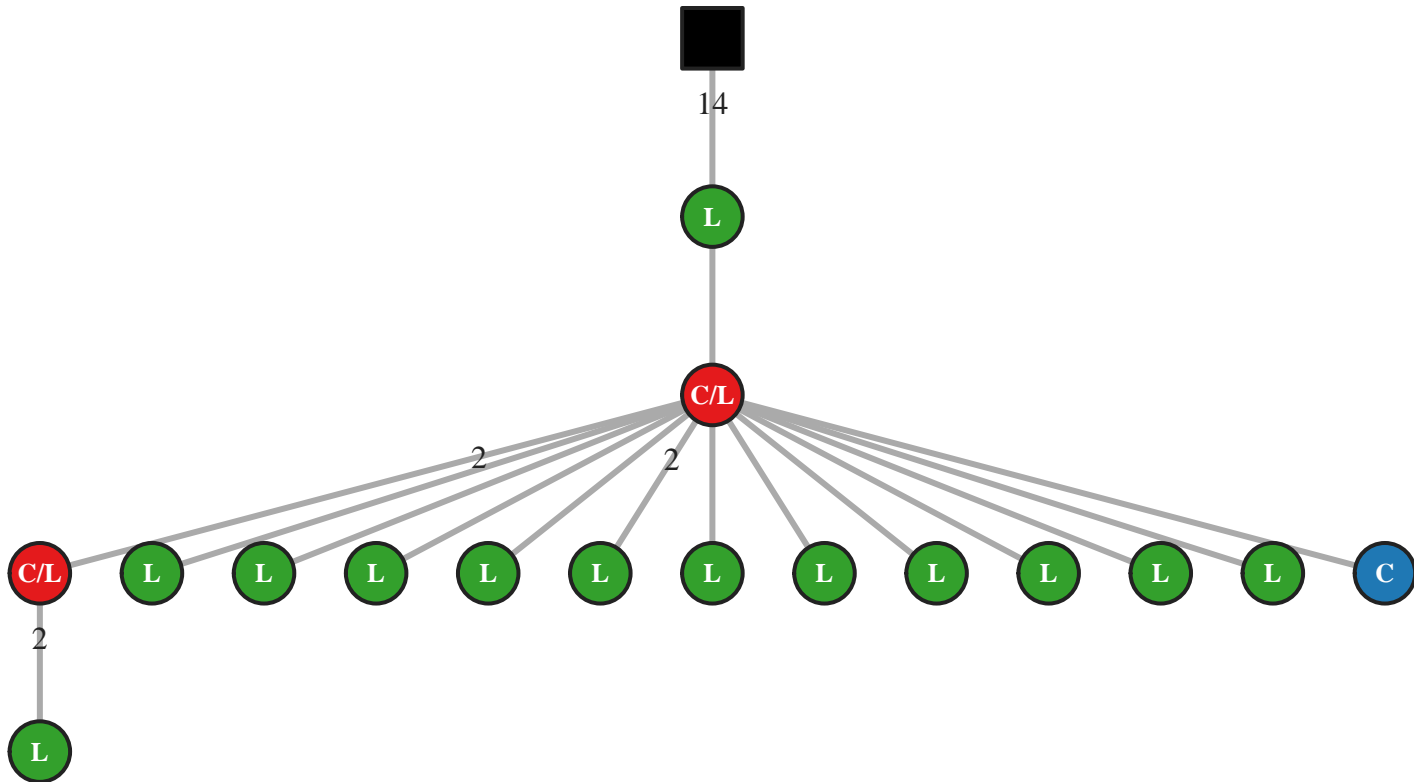

M5 IgG IGHV2-5/J4 45bp (15436)

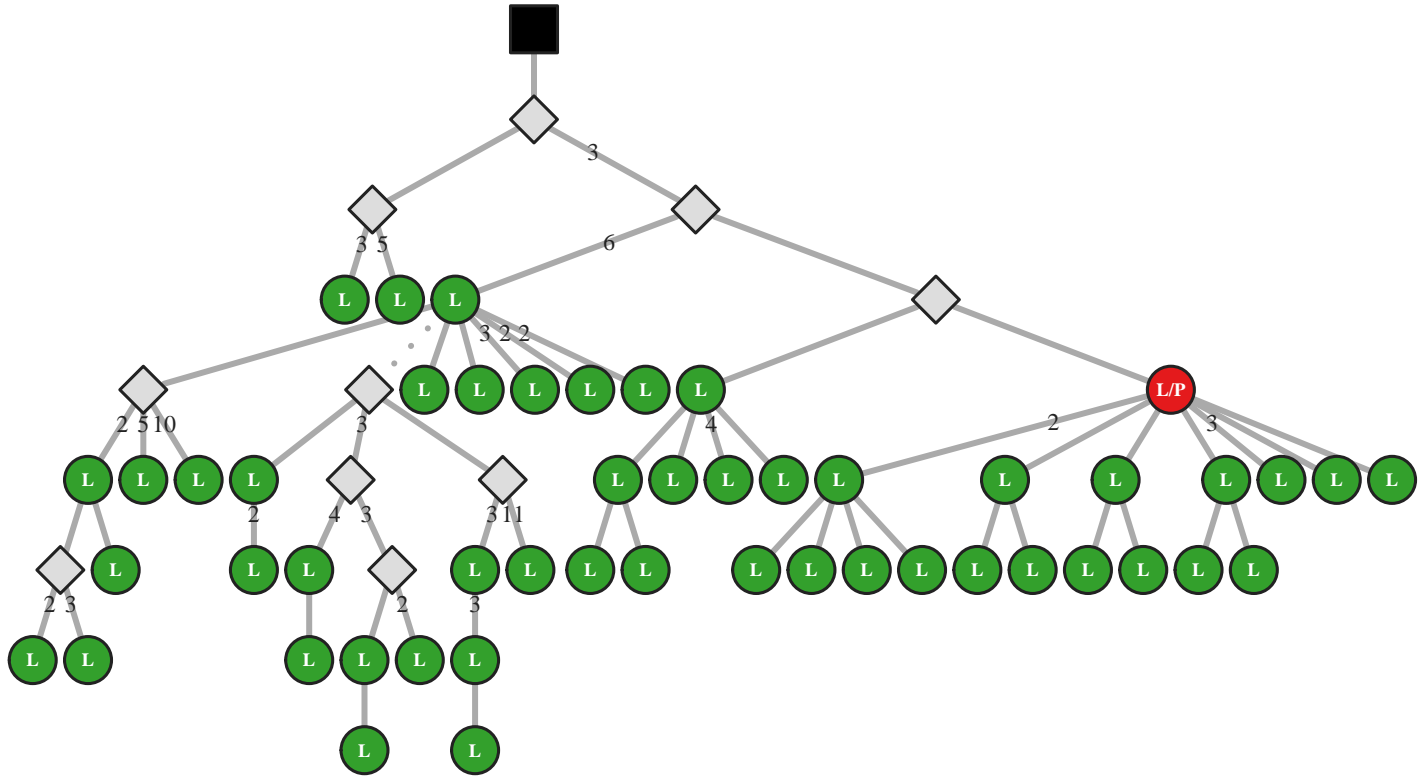

M5 IgG IGHV2-5/J4 45bp (15458)

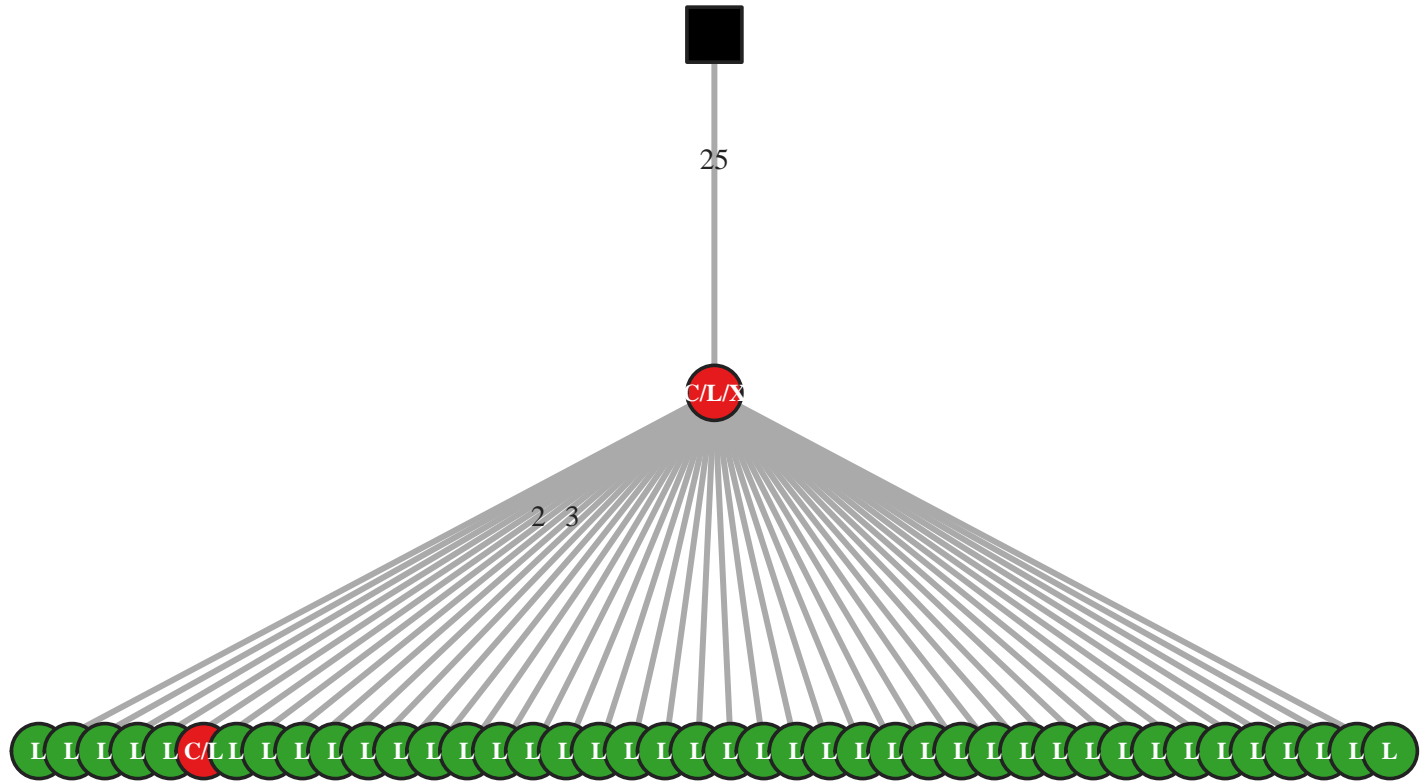

M5 IgG IGHV2-5/J4 45bp (15471)

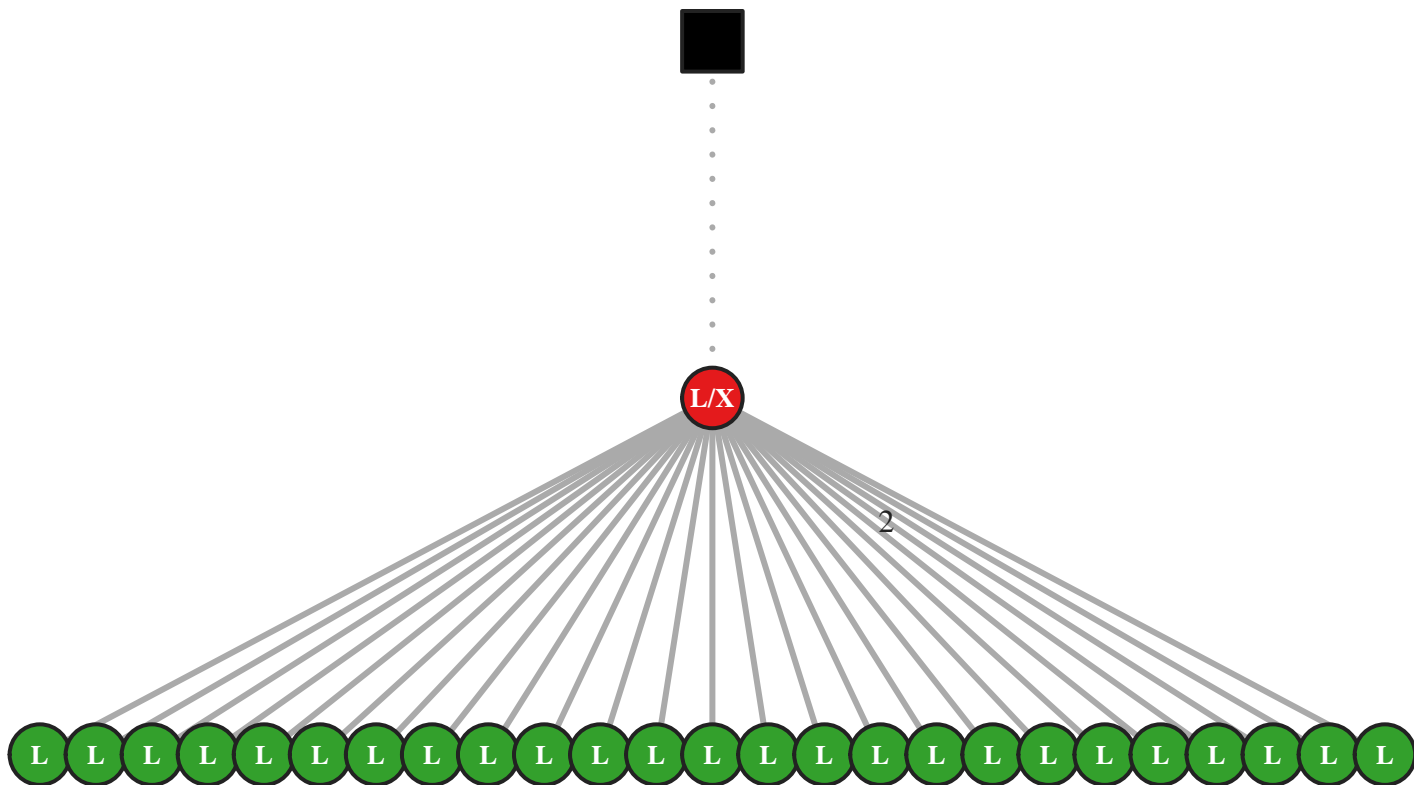

M5 IgG IGHV2-5/J4 45bp (15476)

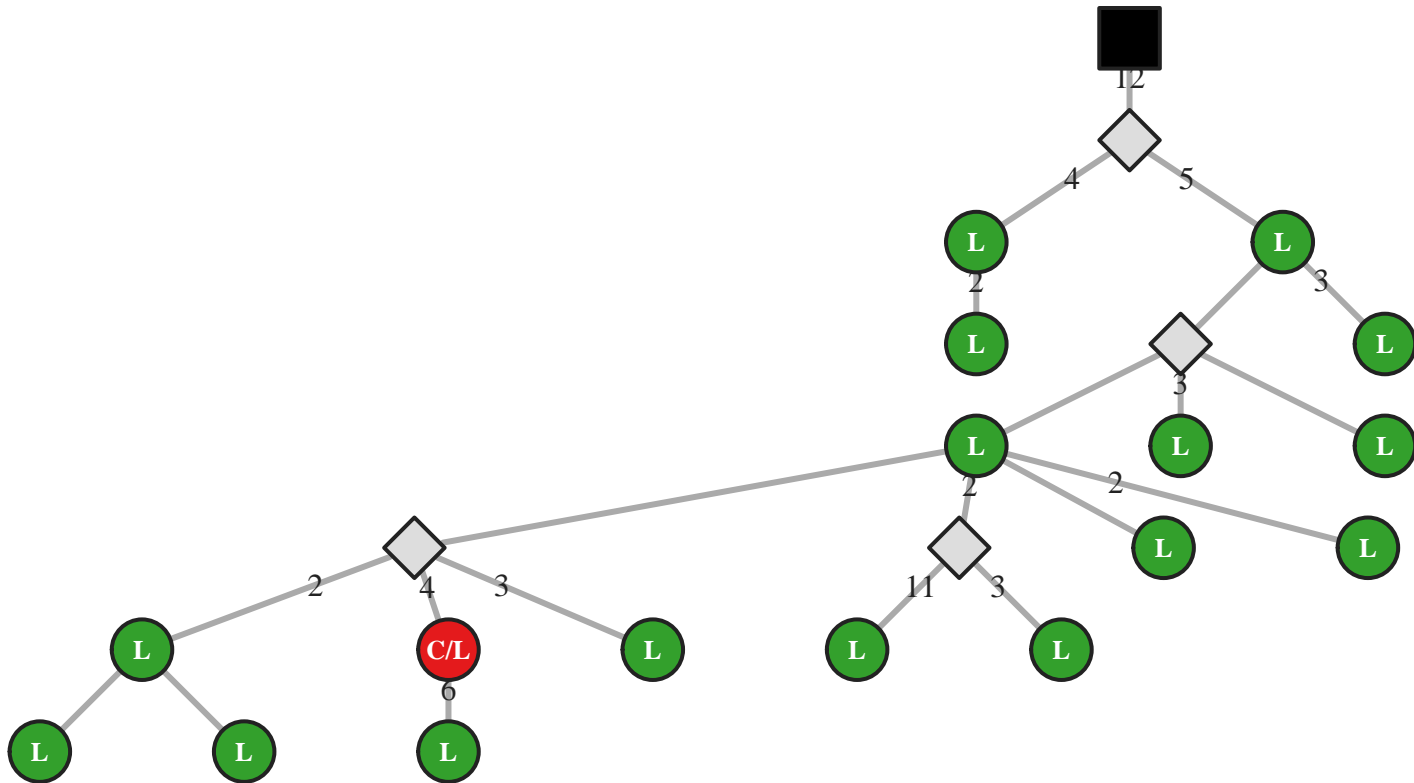

M5 IgG IGHV2-5/J4 45bp (15482)

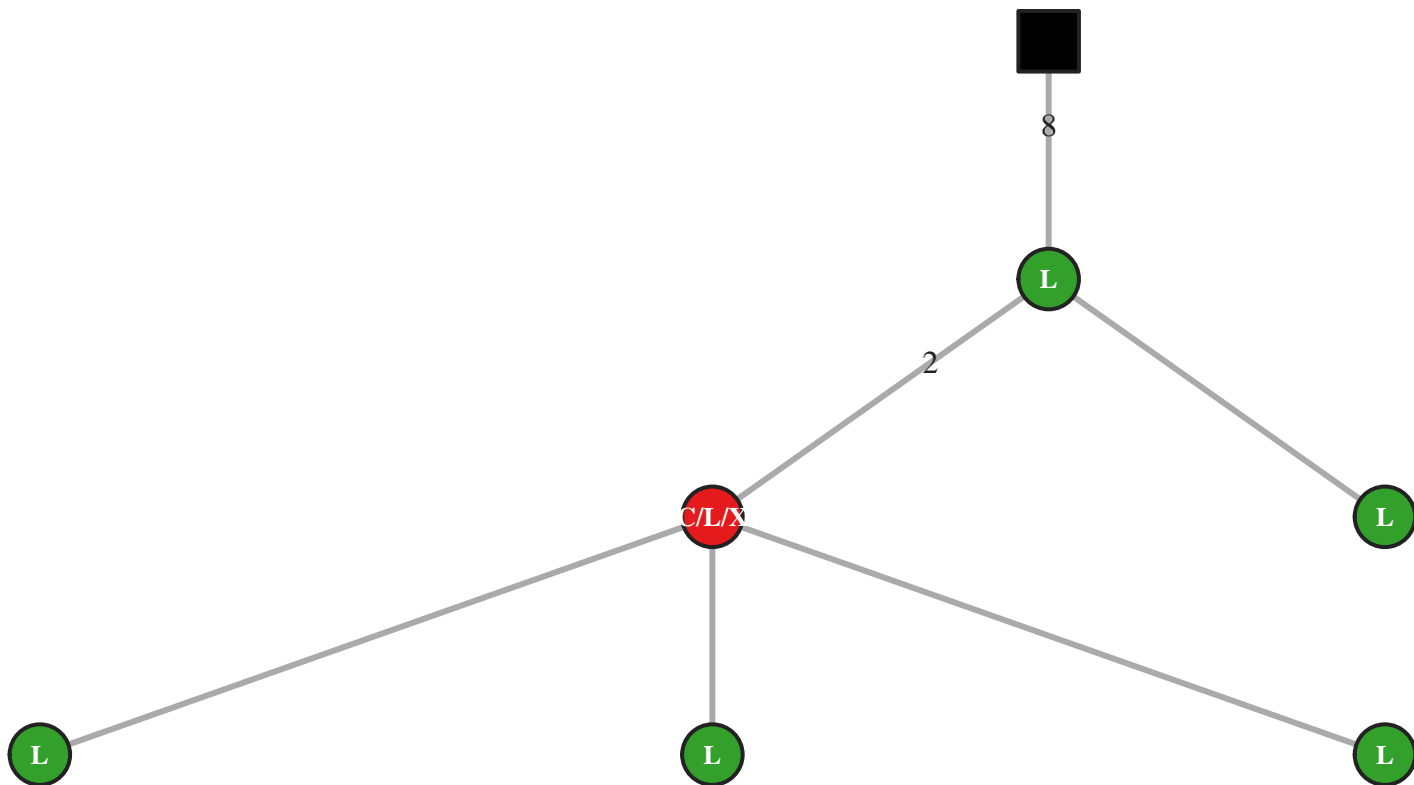

M5 IgG IGHV2-5/J4 45bp (15484)

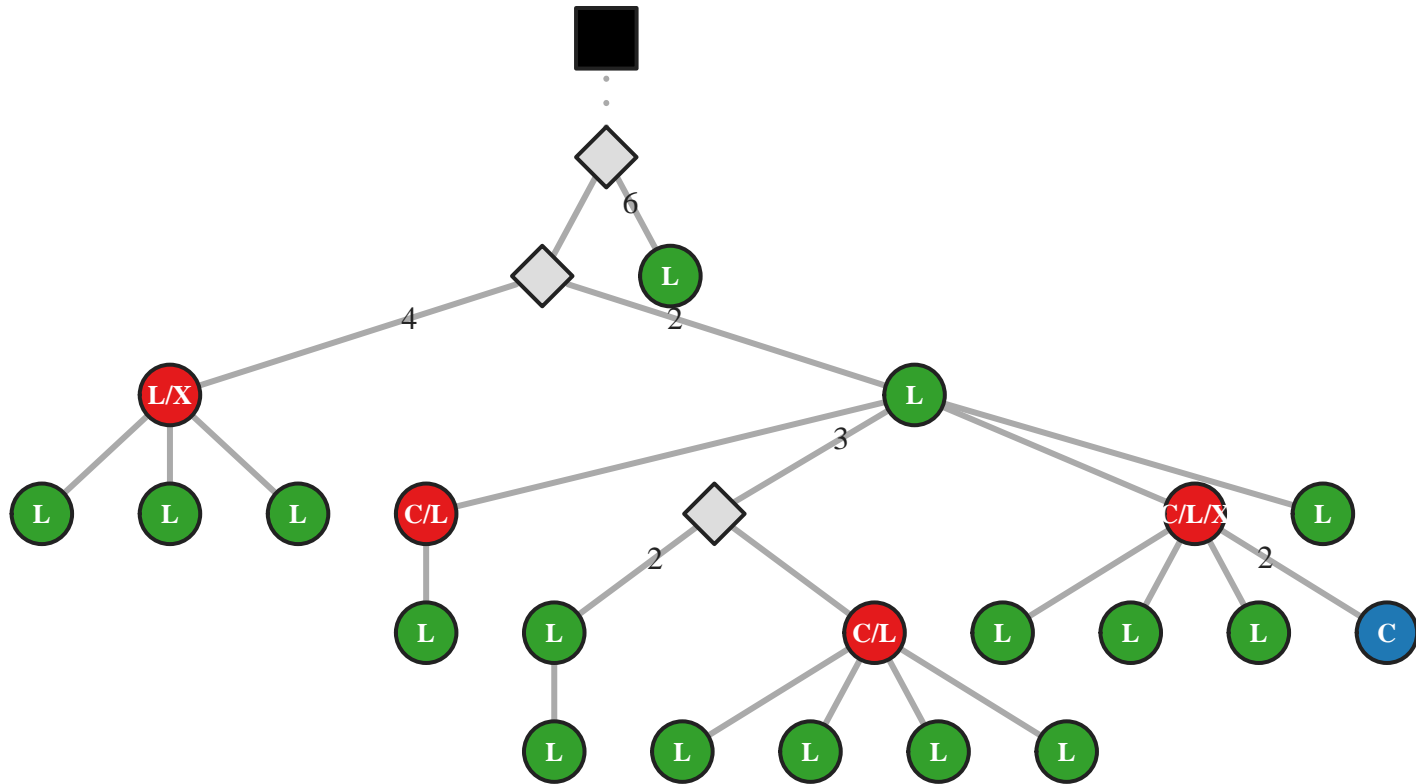

M5 IgG IGHV2-5/J4 45bp (15486)

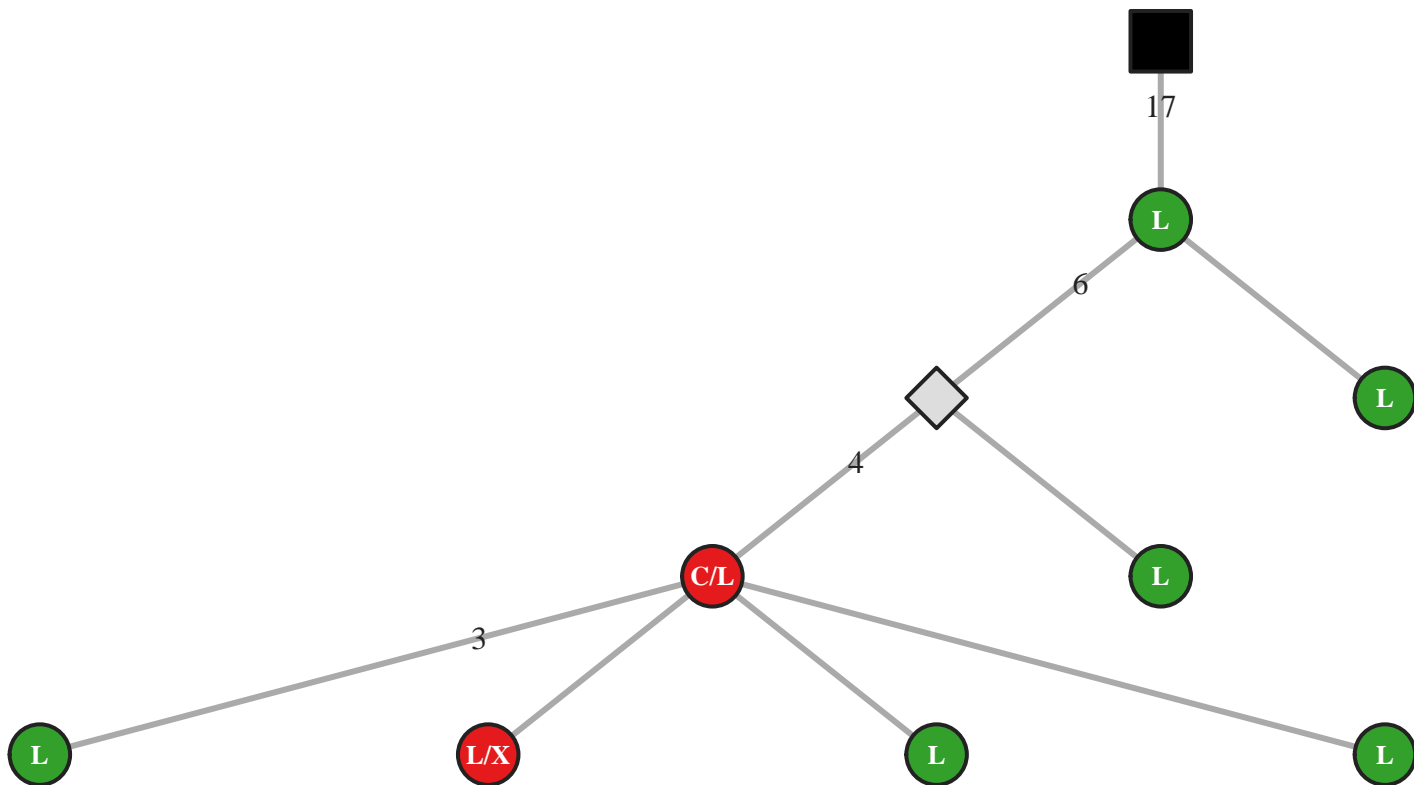

M5 IgG IGHV2-5/J4 45bp (15487)

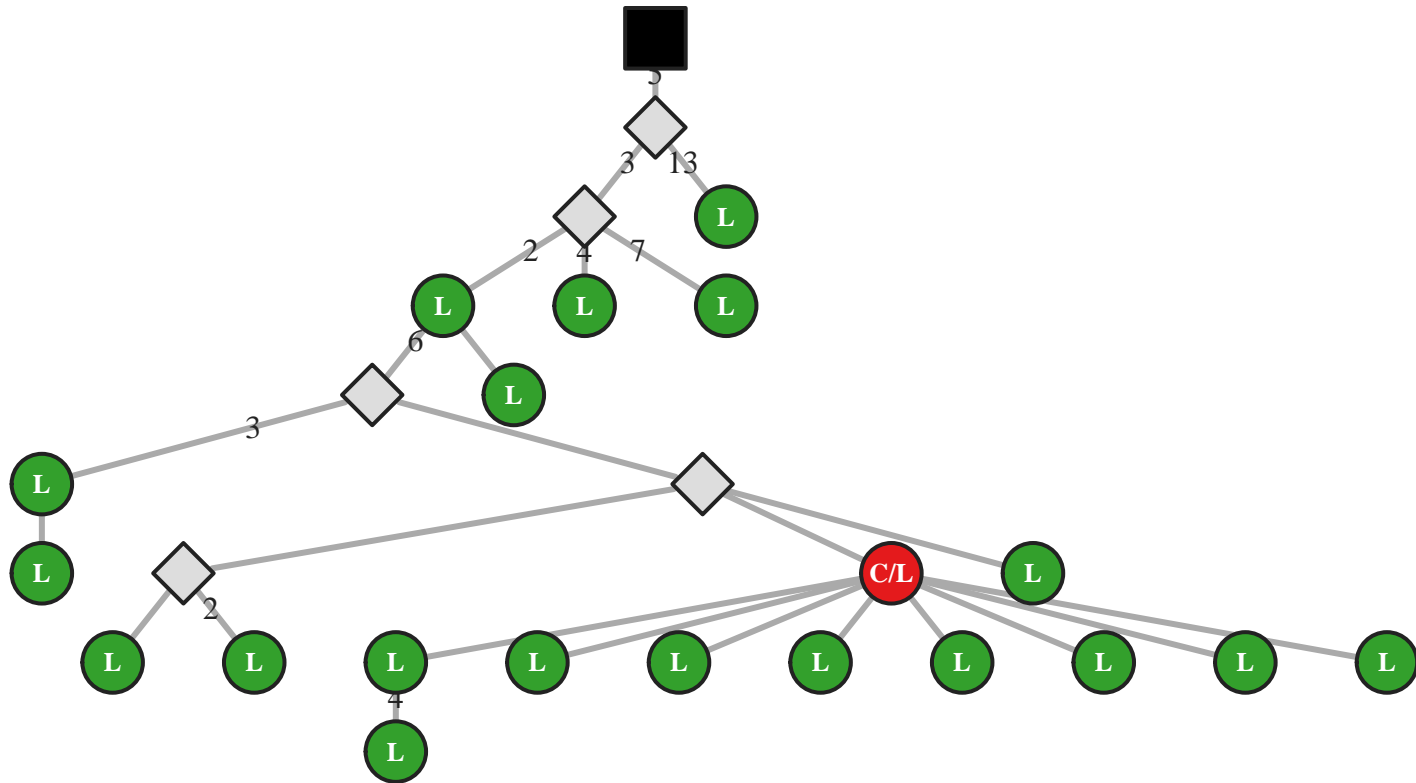

M5 IgA IGHV2-5/J4 48bp (12091)

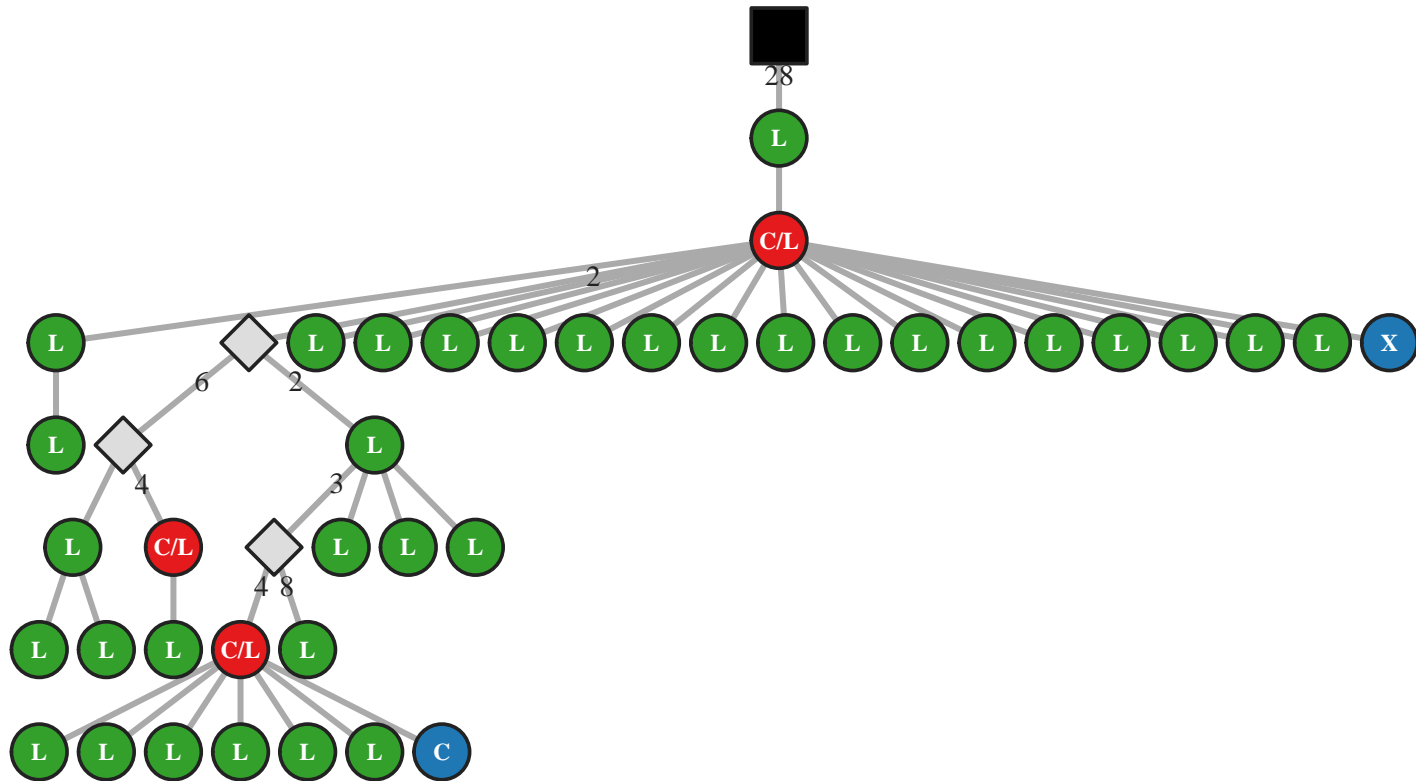

M5 IgG IGHV2-5/J4 48bp (42702)

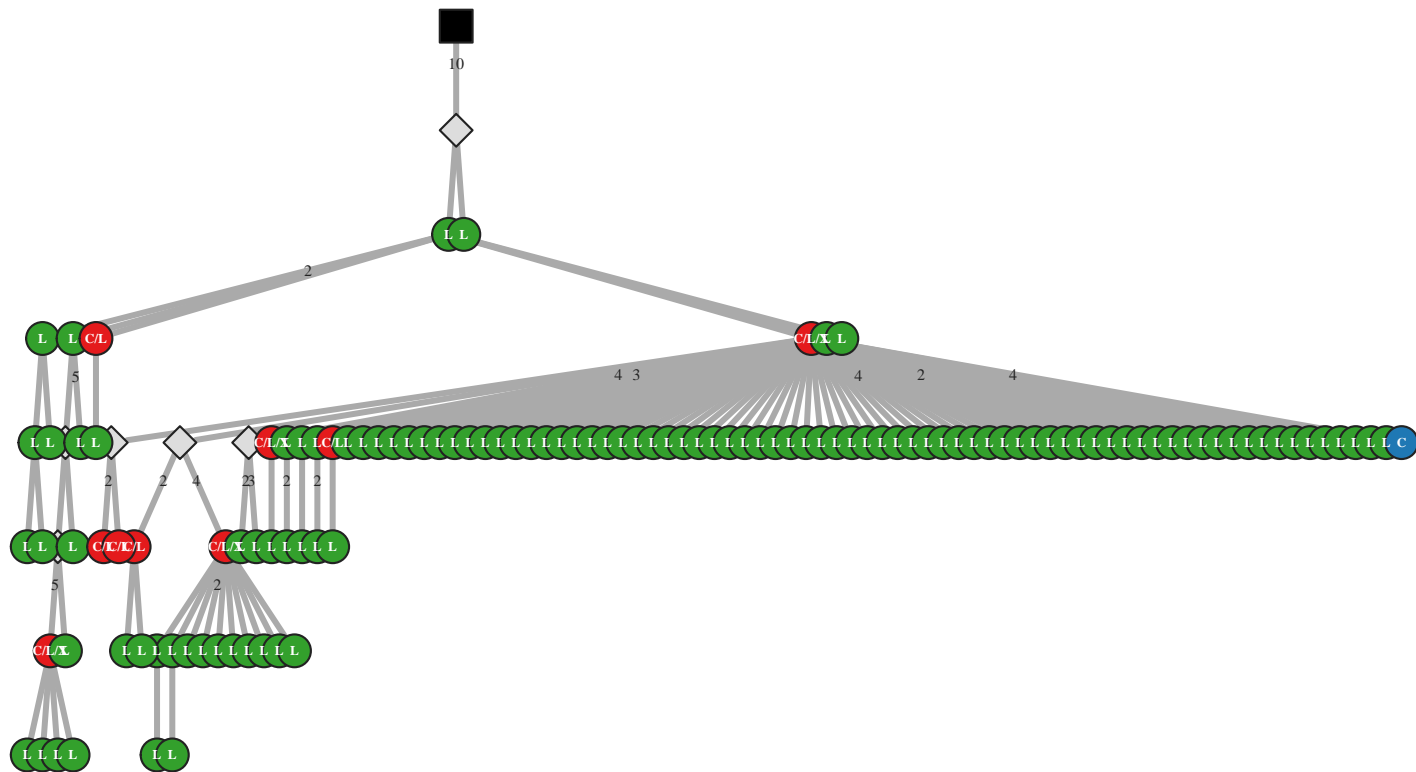

M5 IgG IGHV2-5/J4 48bp (42741)

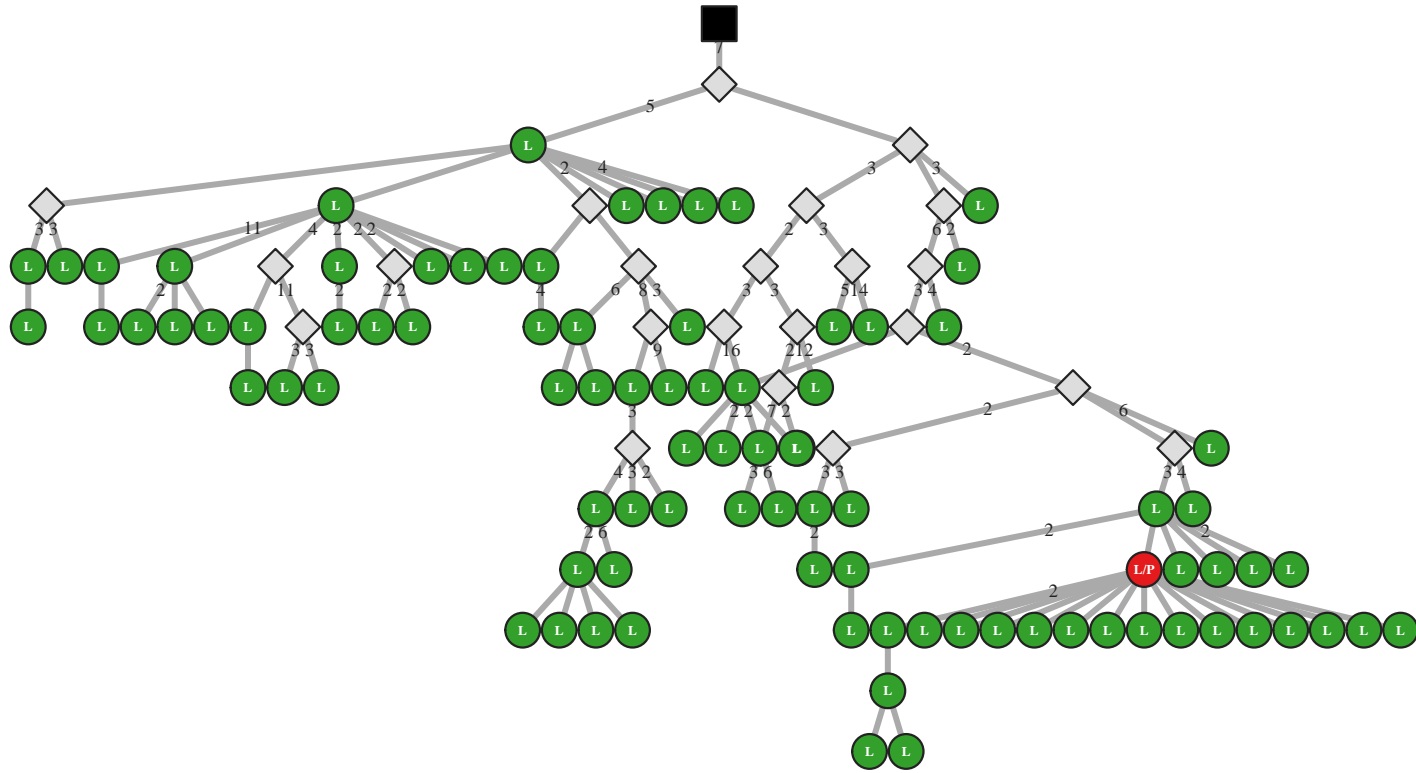

M5 IgG IGHV2-5/J4 51bp (33470)

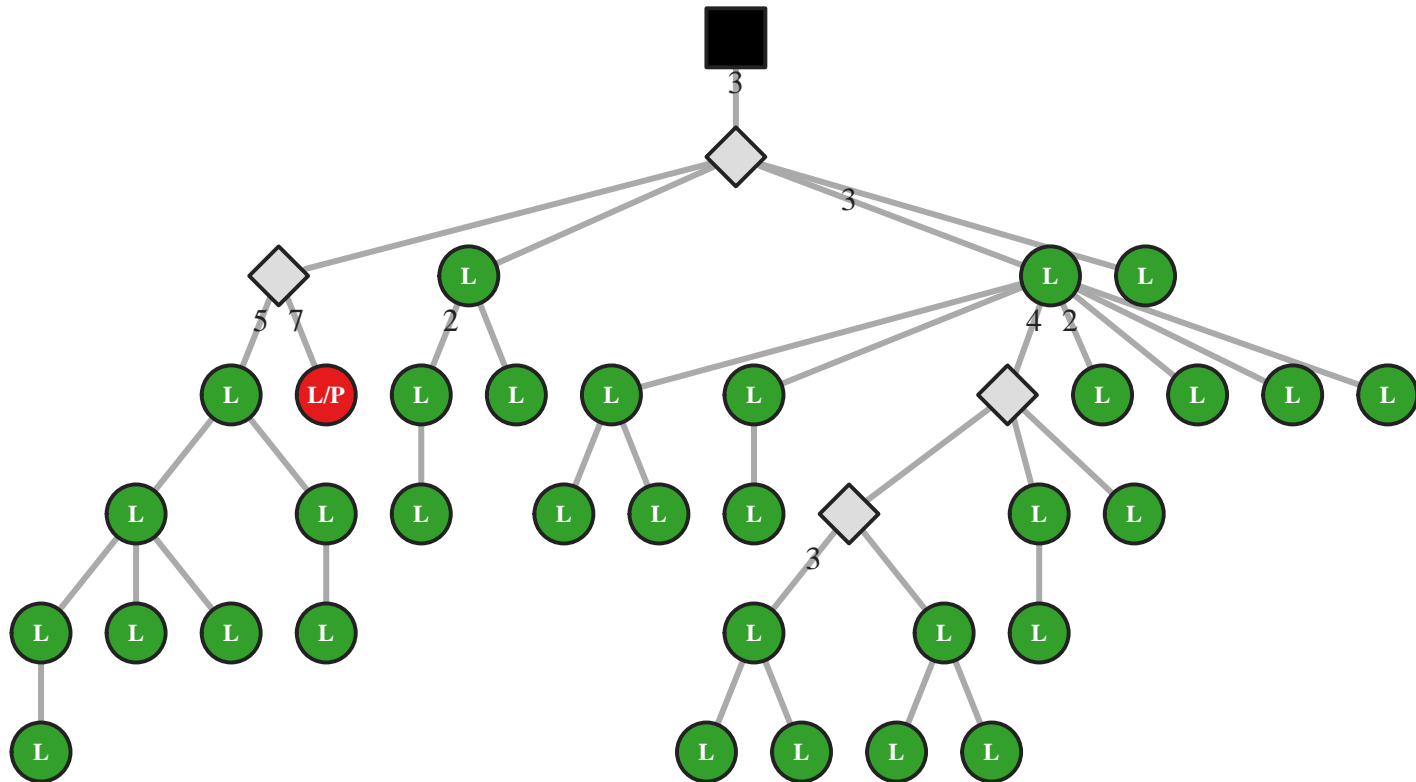

M5 IgG IGHV2-5/J4 51bp (33476)

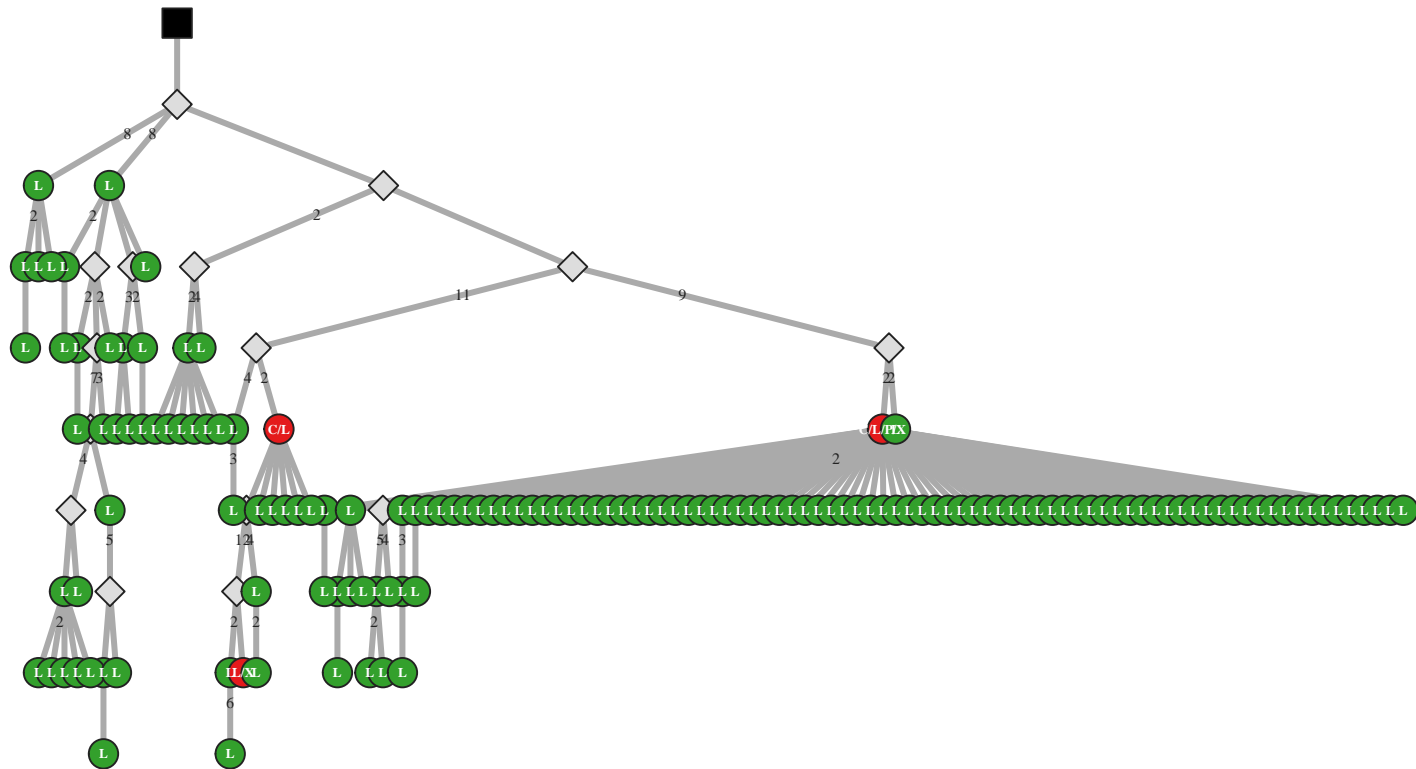

M5 IgG IGHV2-5/J4 51bp (33505)

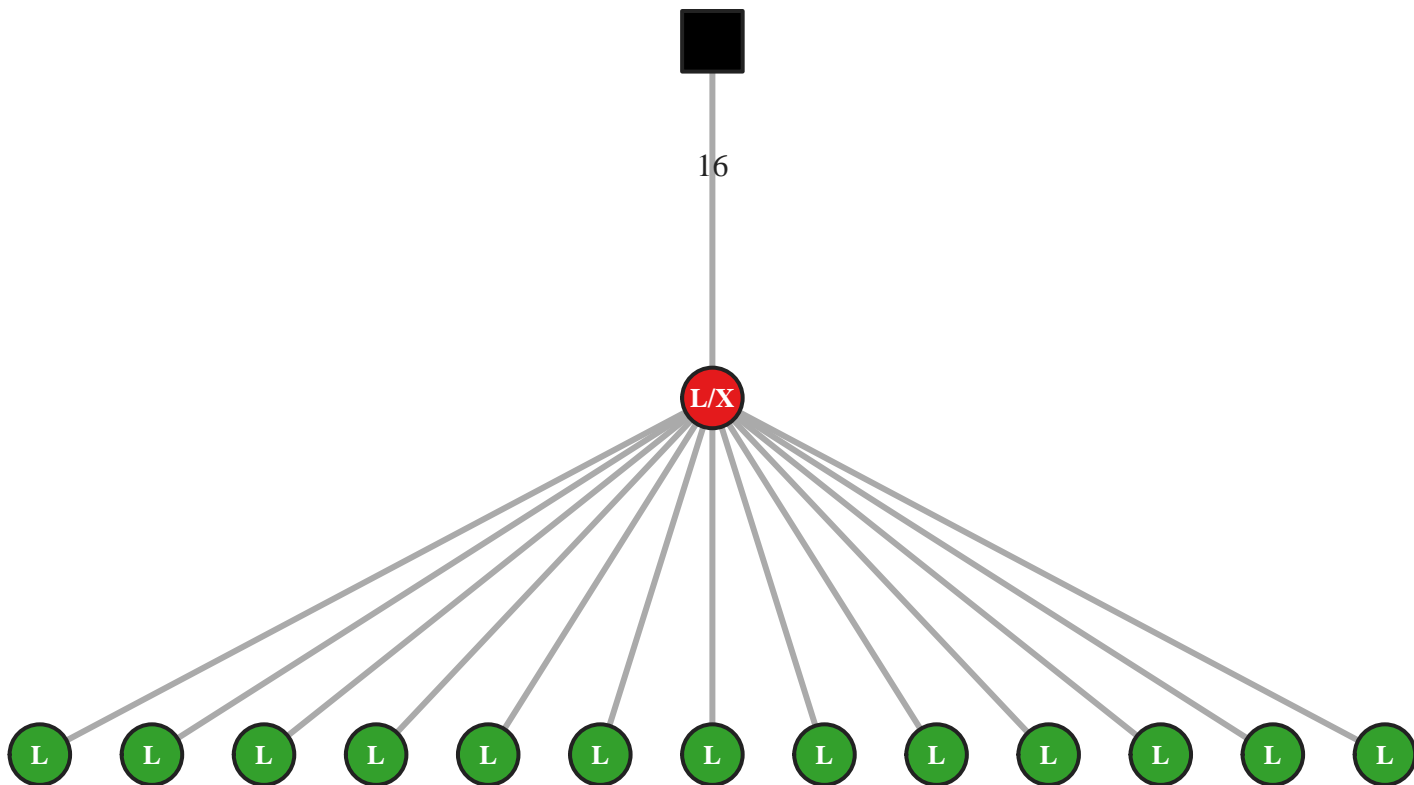

M5 IgG IGHV2-5/J4 51bp (33513)

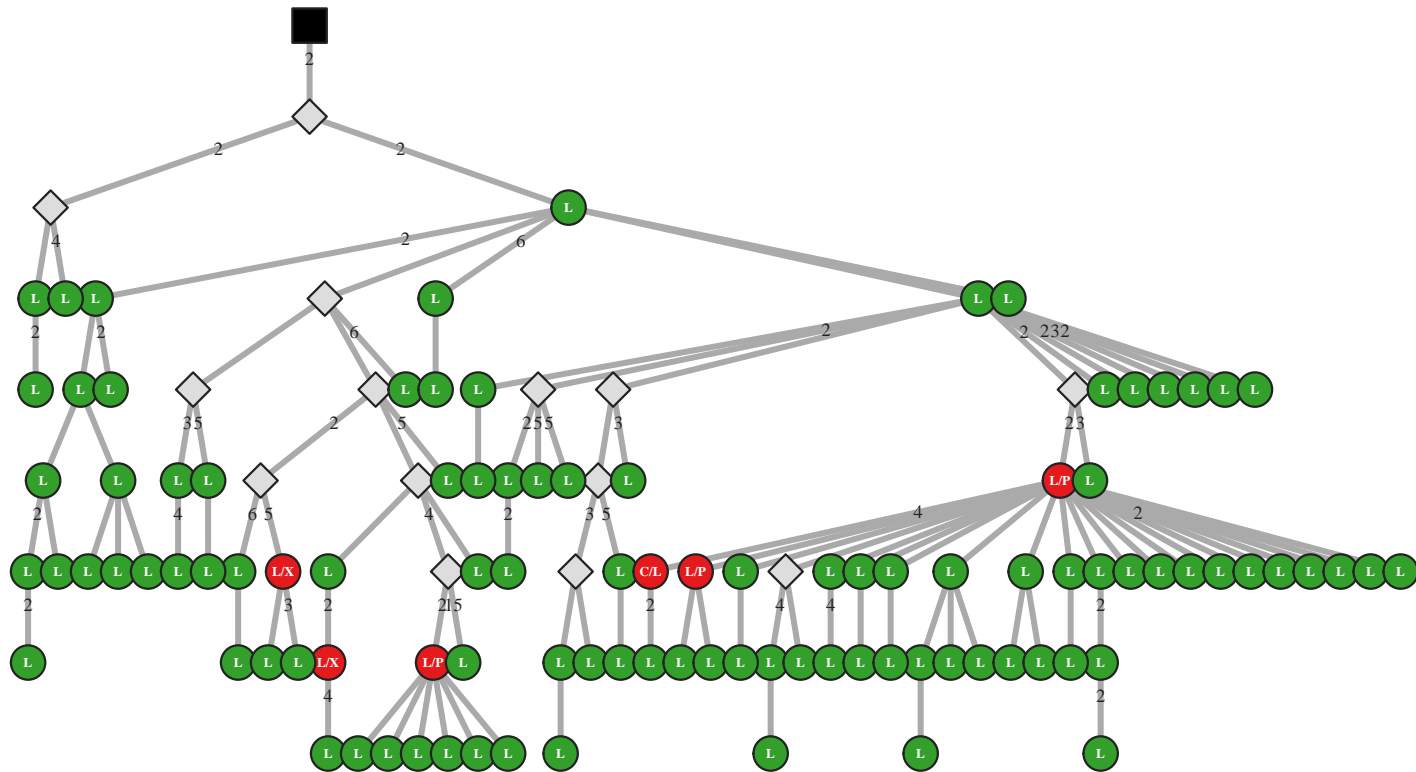

M5 IgG IGHV2-5/J4 51bp (33553)

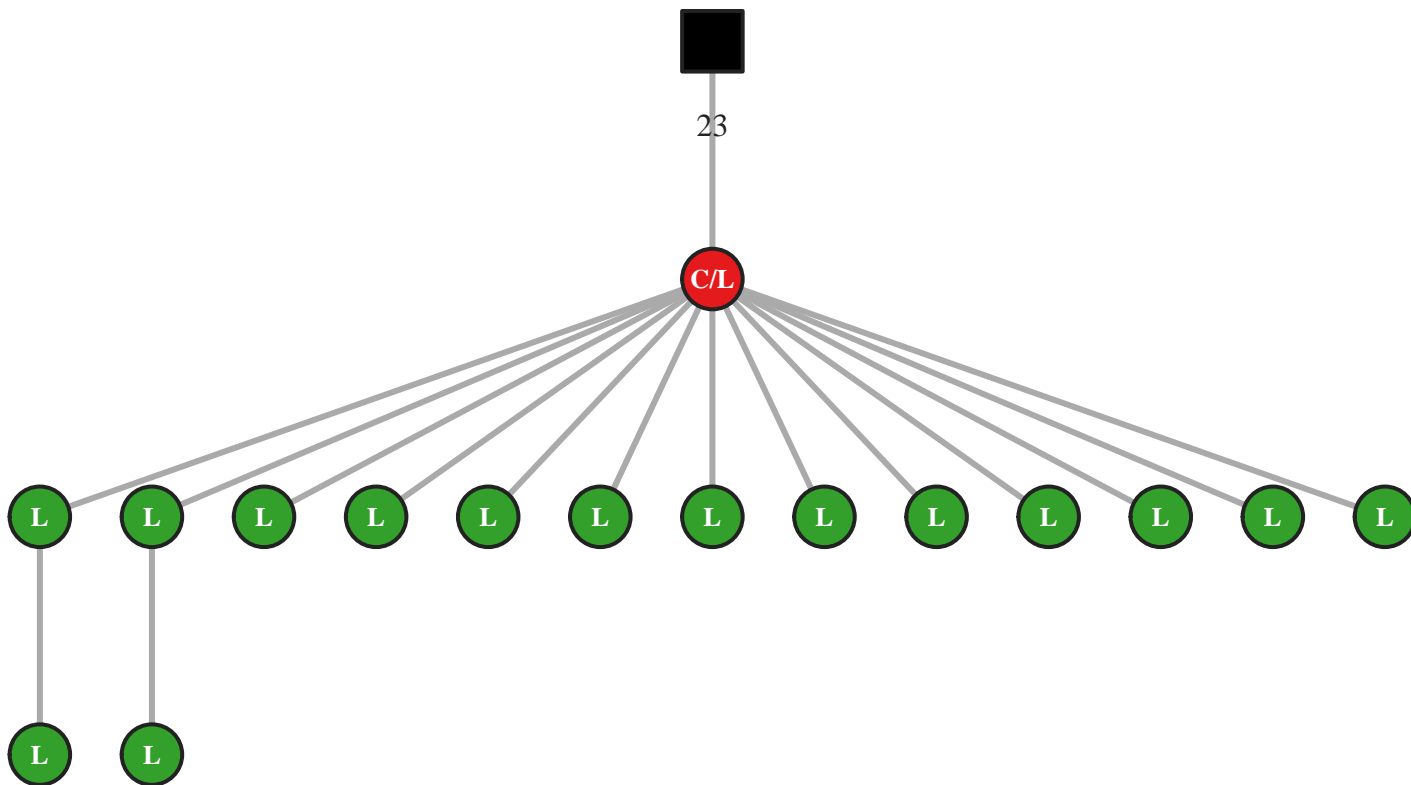

M5 IgA IGHV2-5/J4 54bp (38534)

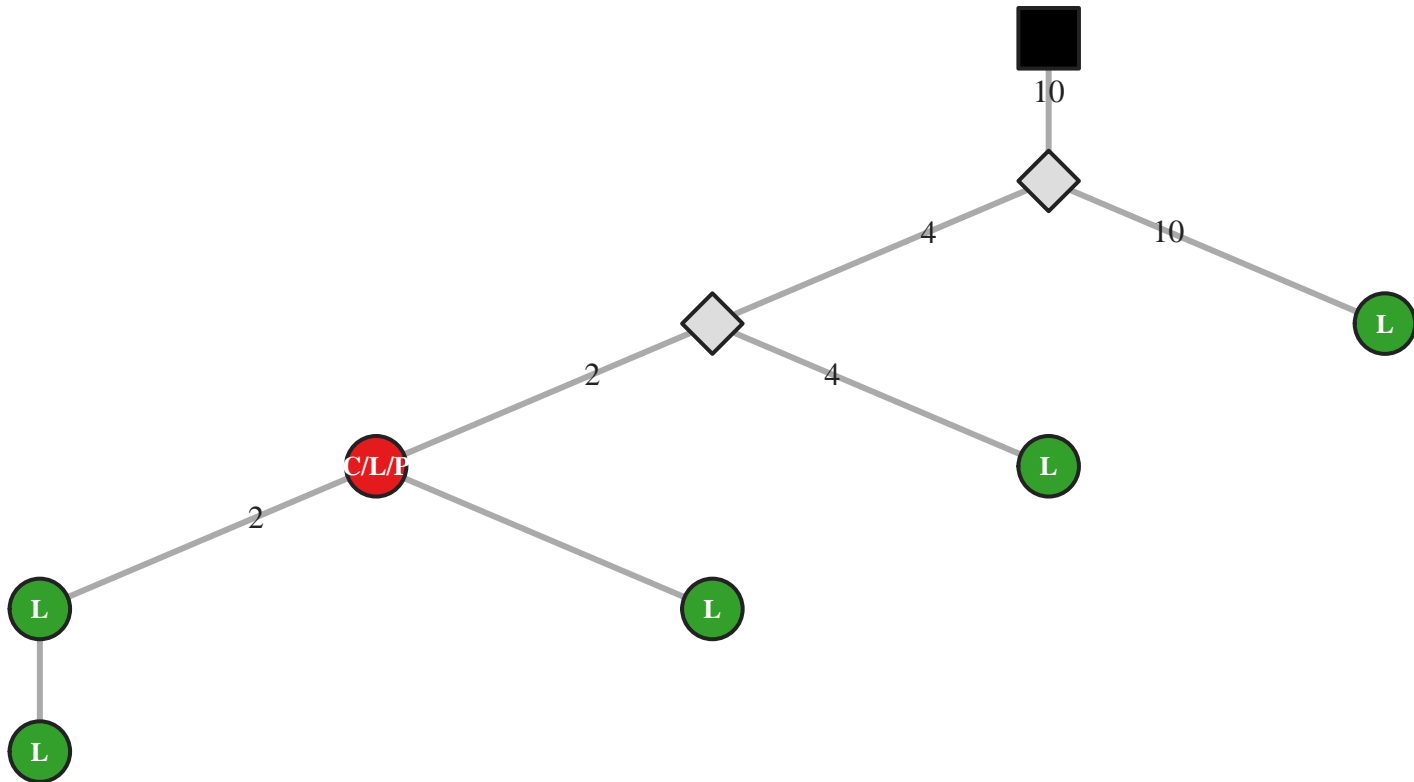

M5 IgG IGHV2-5/J4 54bp (5615)

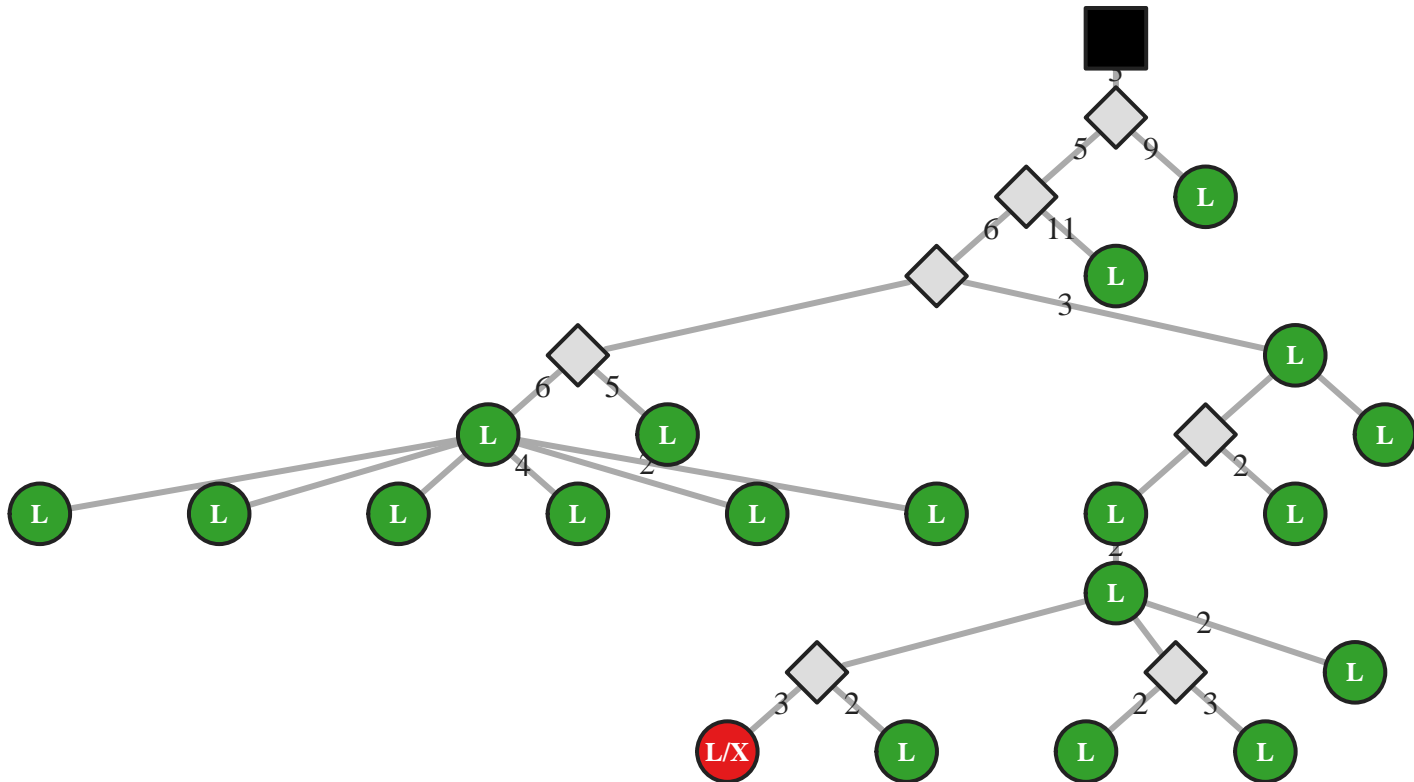

M5 IgG IGHV2-5/J4 54bp (5619)

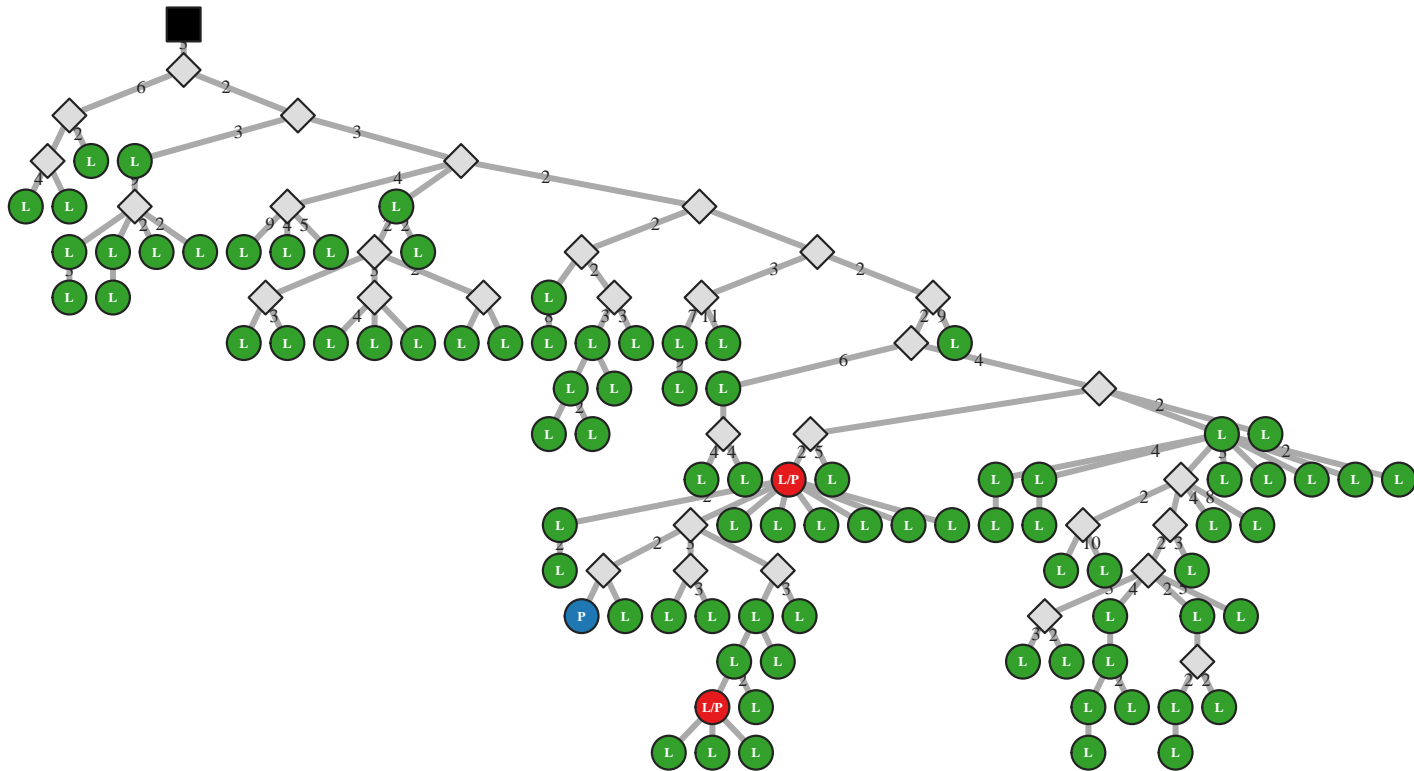

M5 IgG IGHV2-5/J4 54bp (5621)

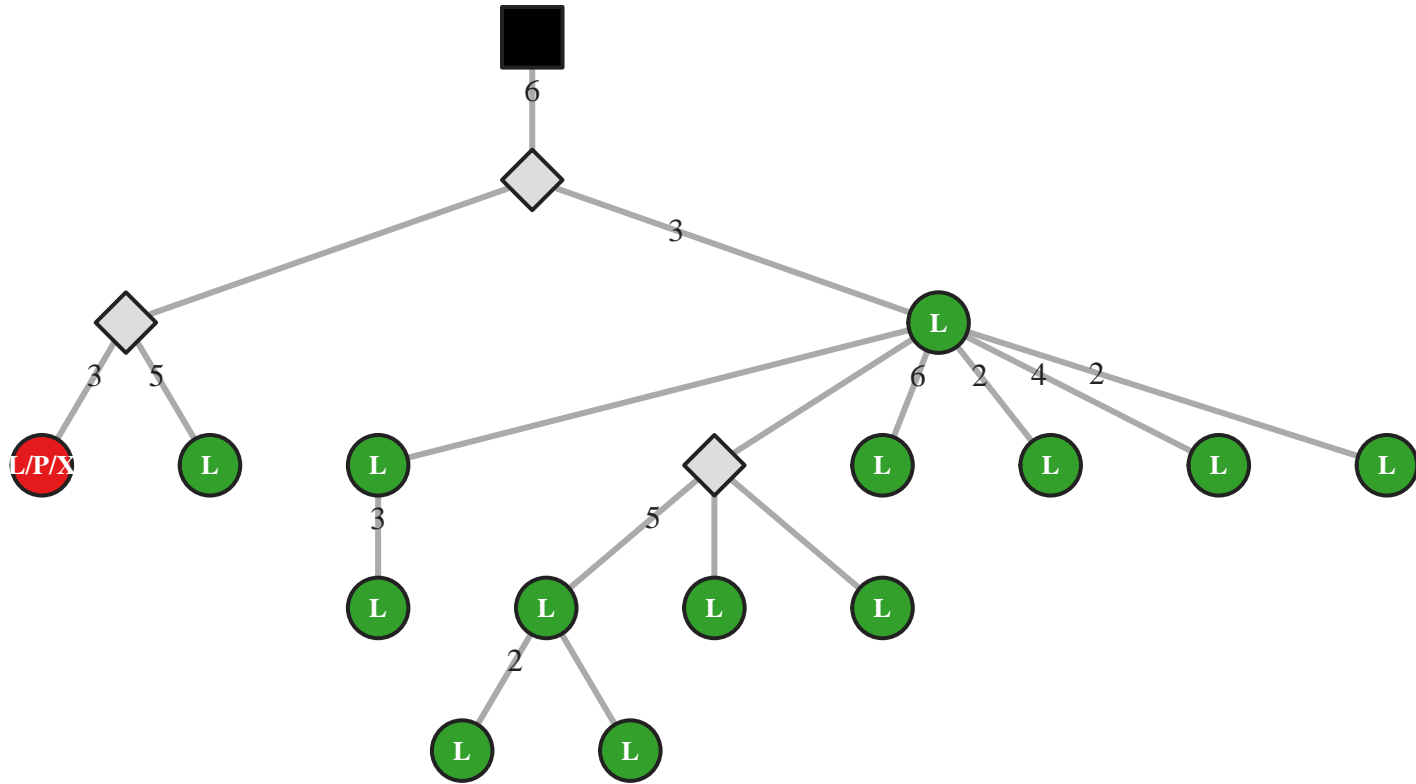

M5 IgG IGHV2-5/J4 54bp (5641)

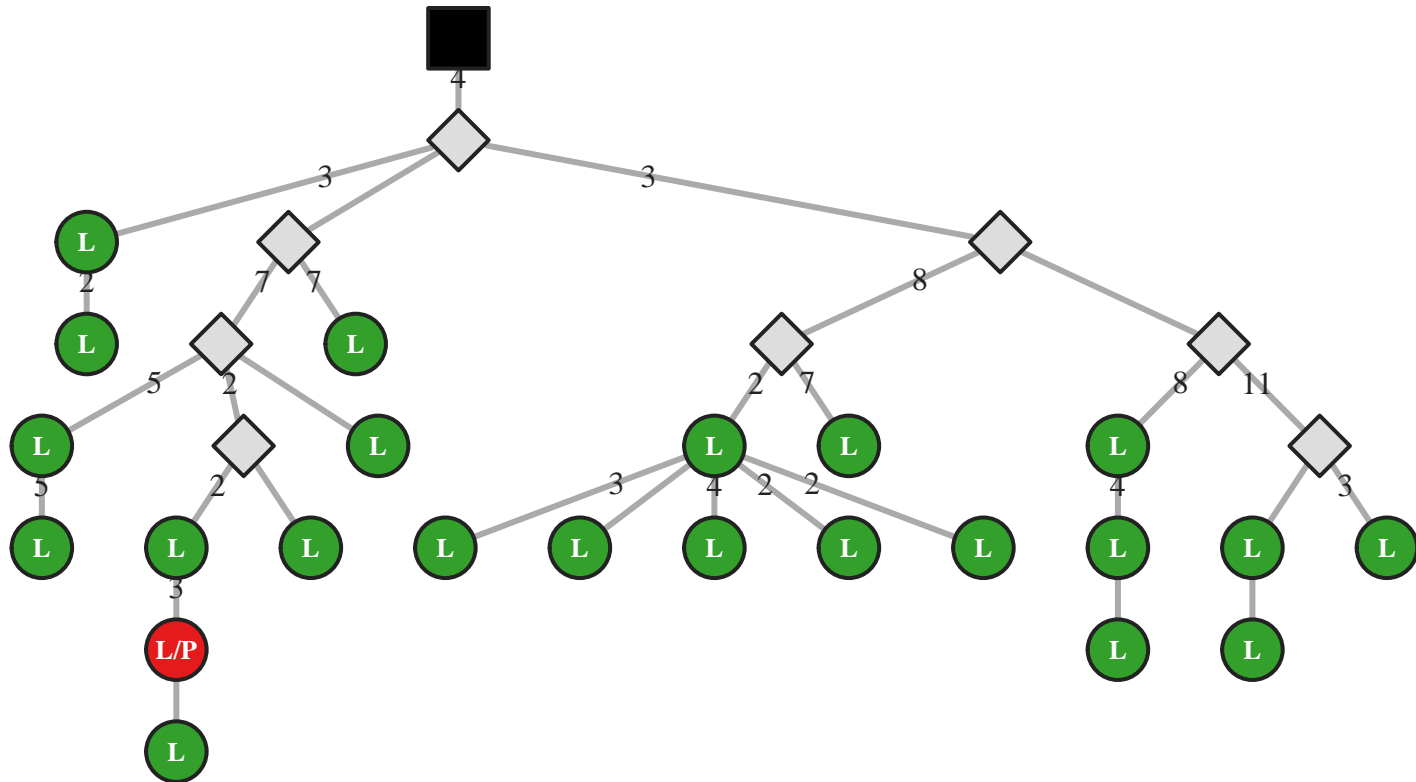

M5 IgA IGHV2-5/J4 57bp (48658)

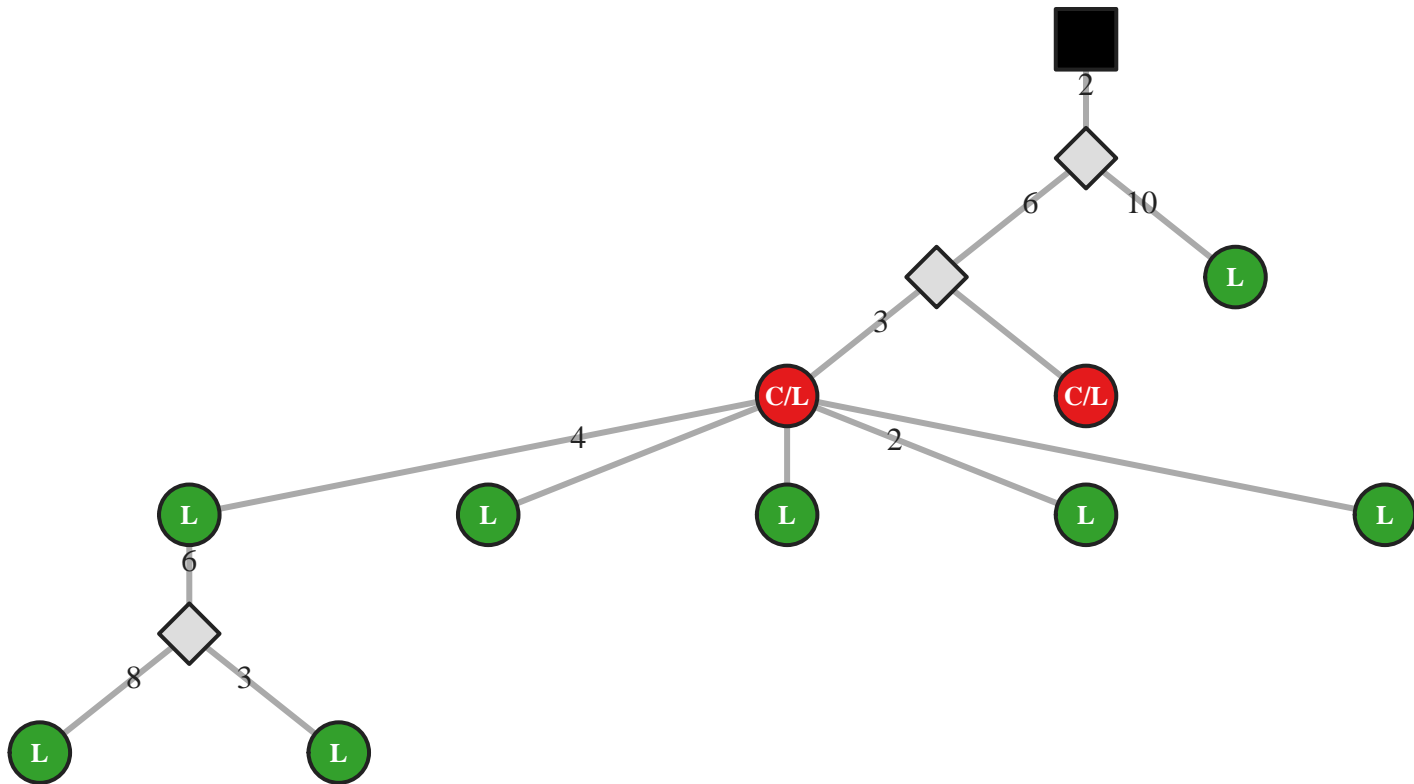

M5 IgG IGHV2-5/J4 57bp (42799)

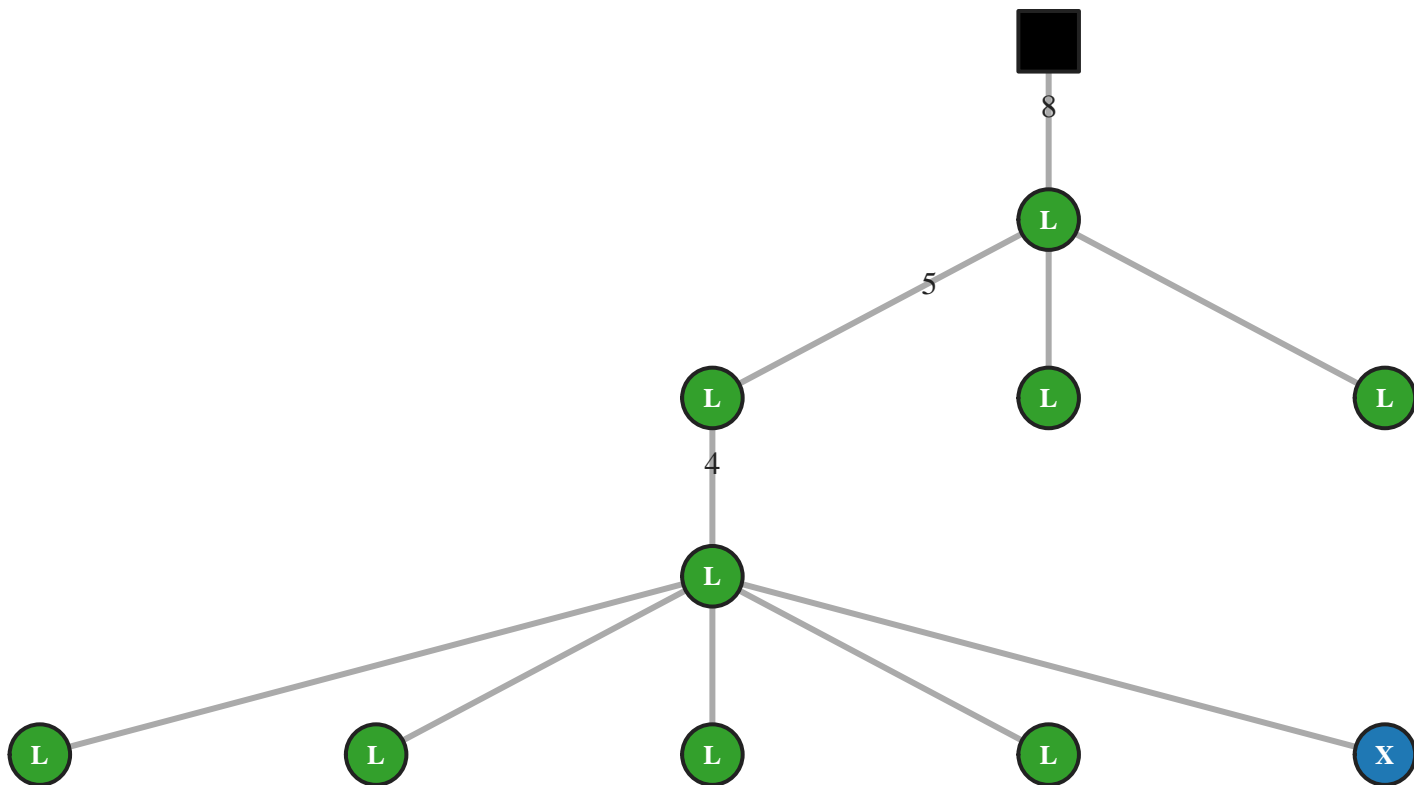

M5 IgG IGHV2-5/J4 57bp (42804)

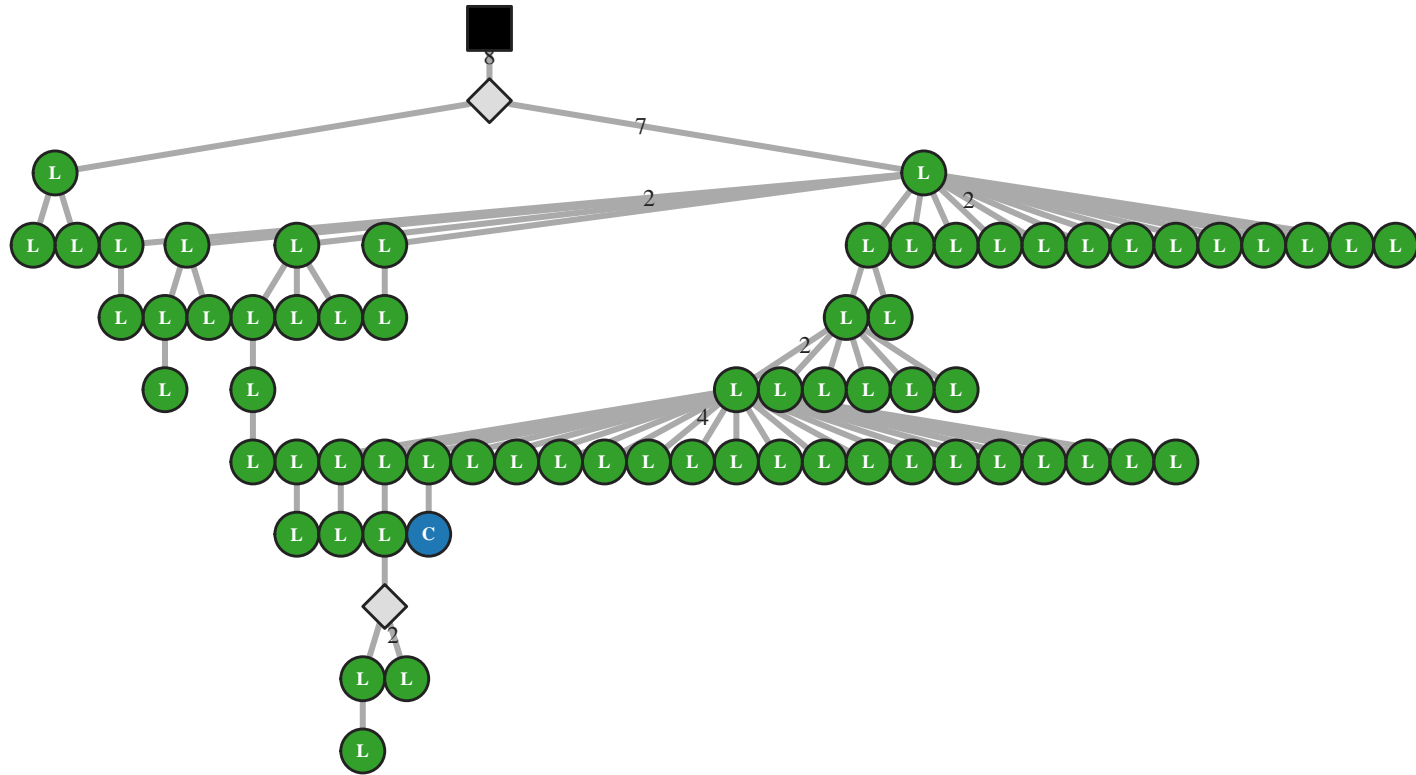

M5 IgG IGHV2-5/J4 57bp (42809)

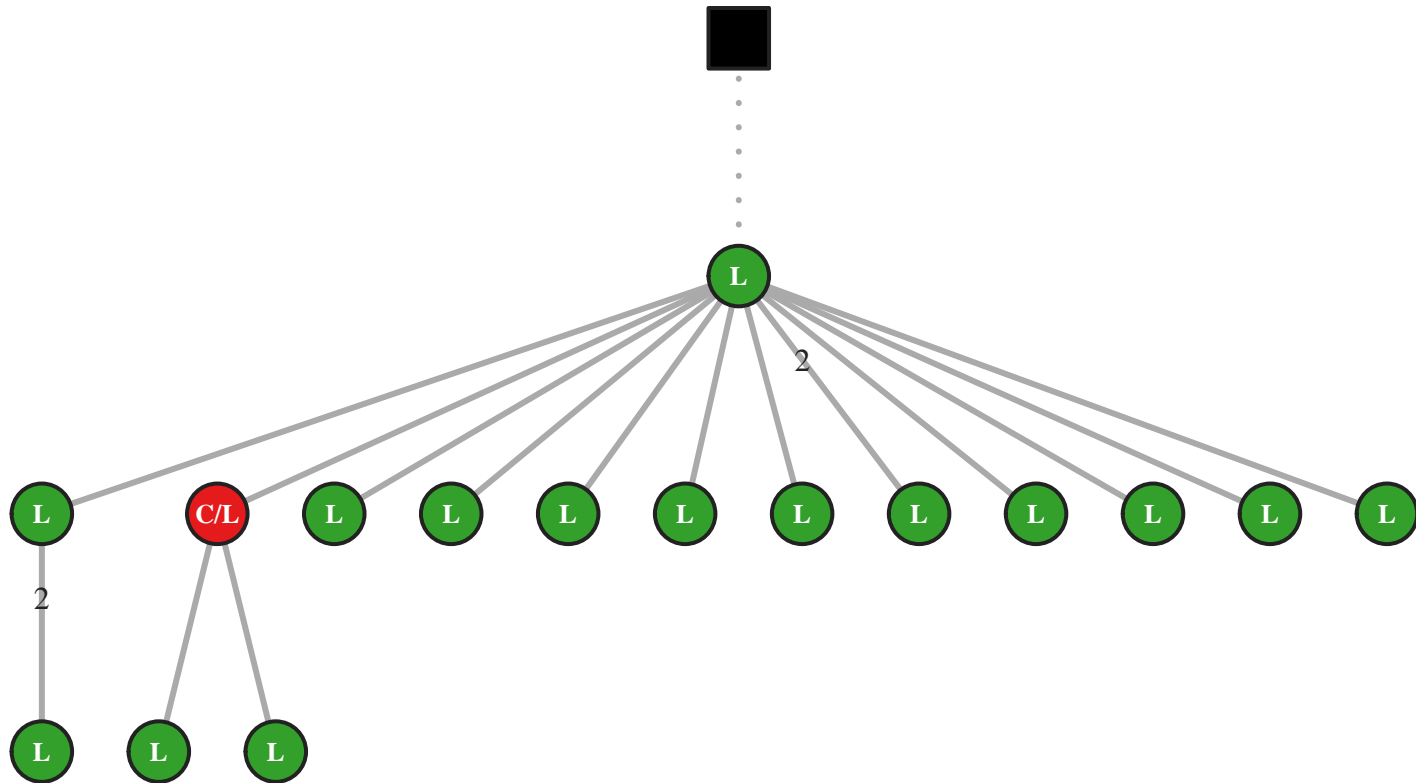

M5 IgG IGHV2-5/J4 57bp (42817)

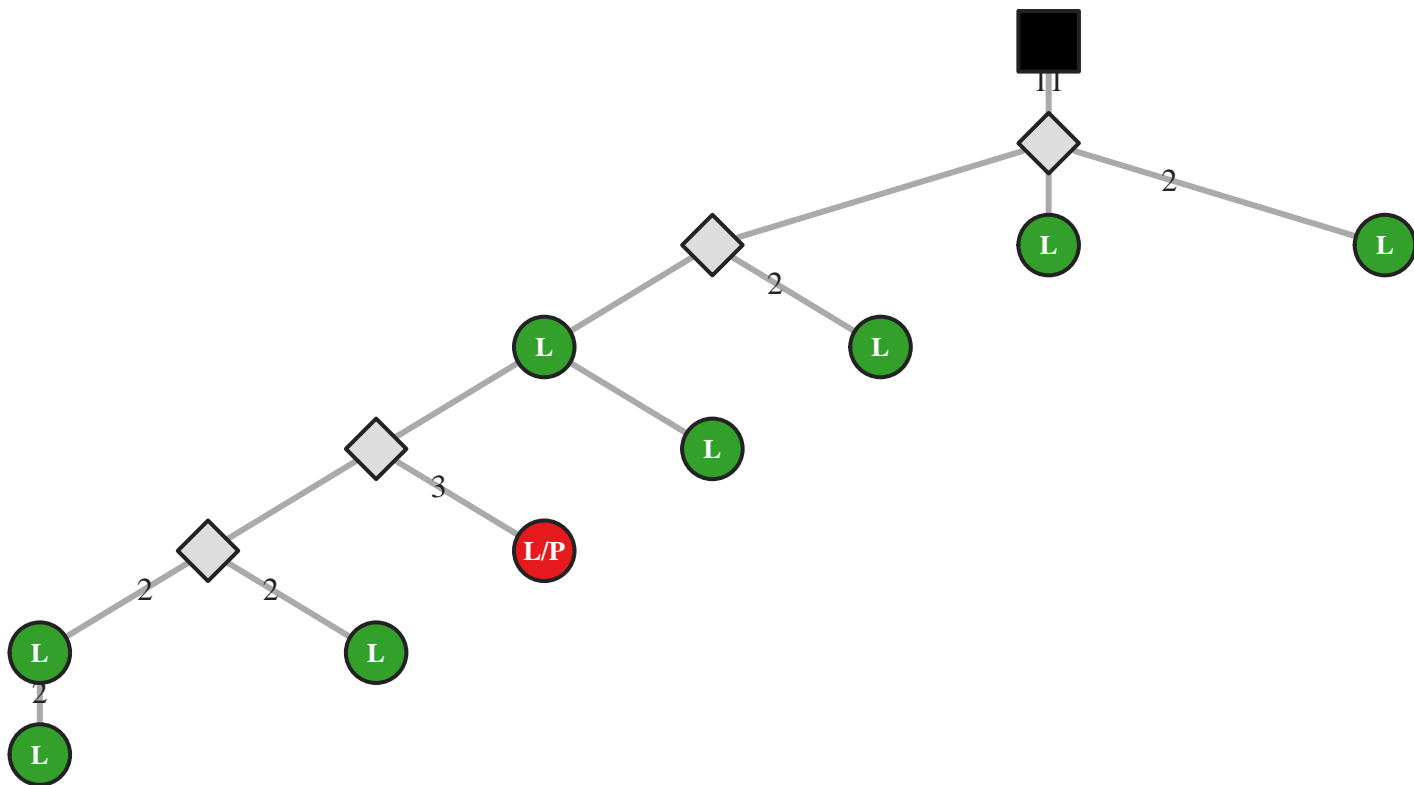

M5 IgG IGHV2-5/J4 57bp (42818)

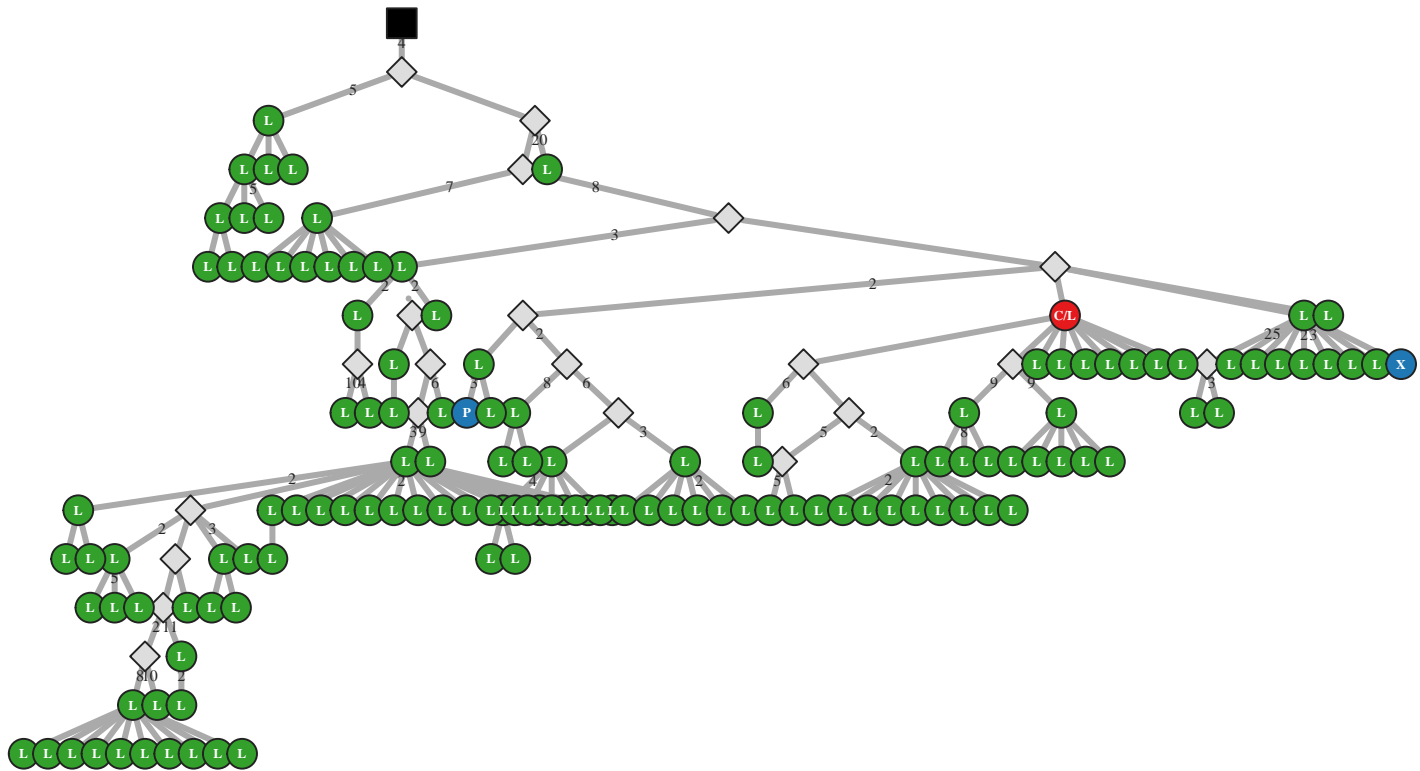

M5 IgG IGHV2-5/J4 57bp (42849)

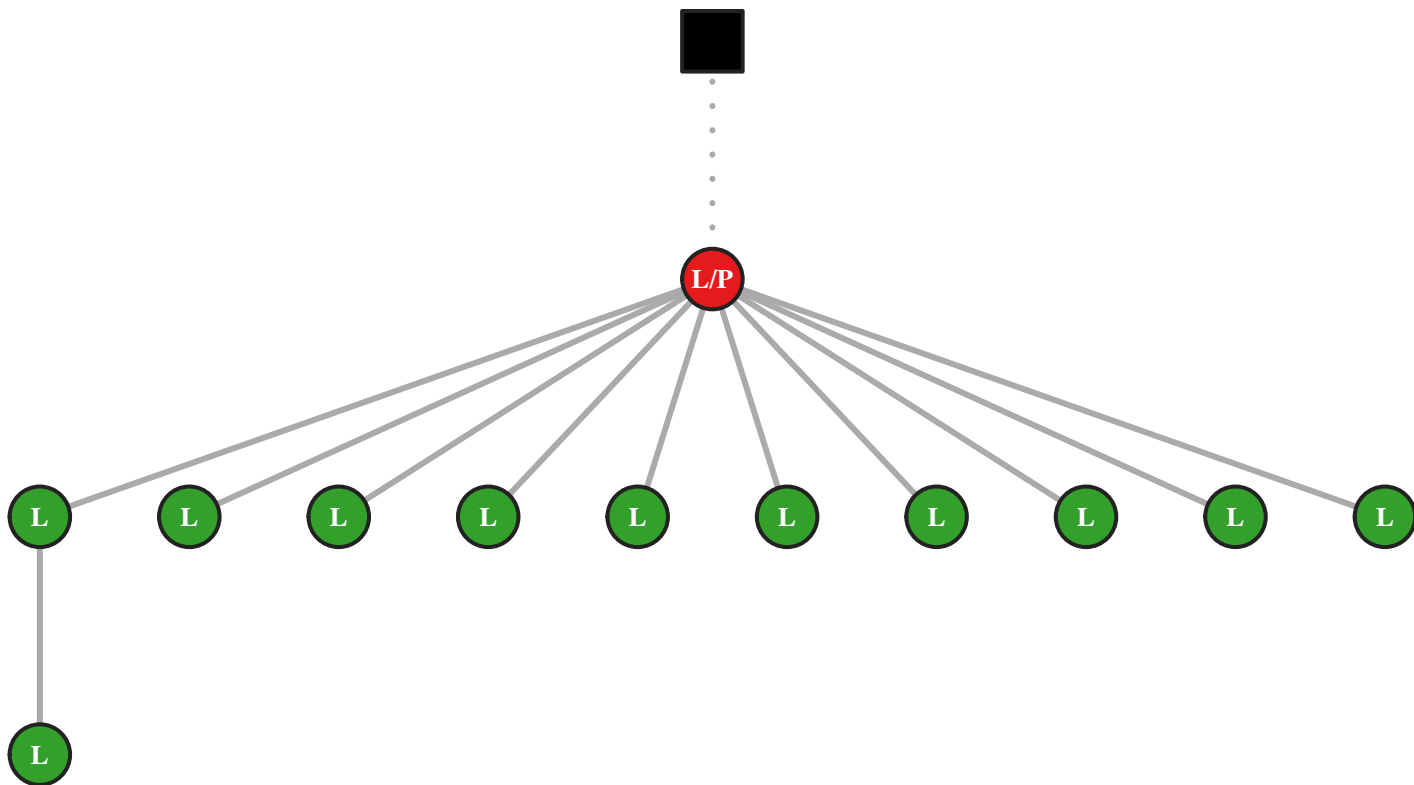

M5 IgG IGHV2-5/J4 60bp (24562)

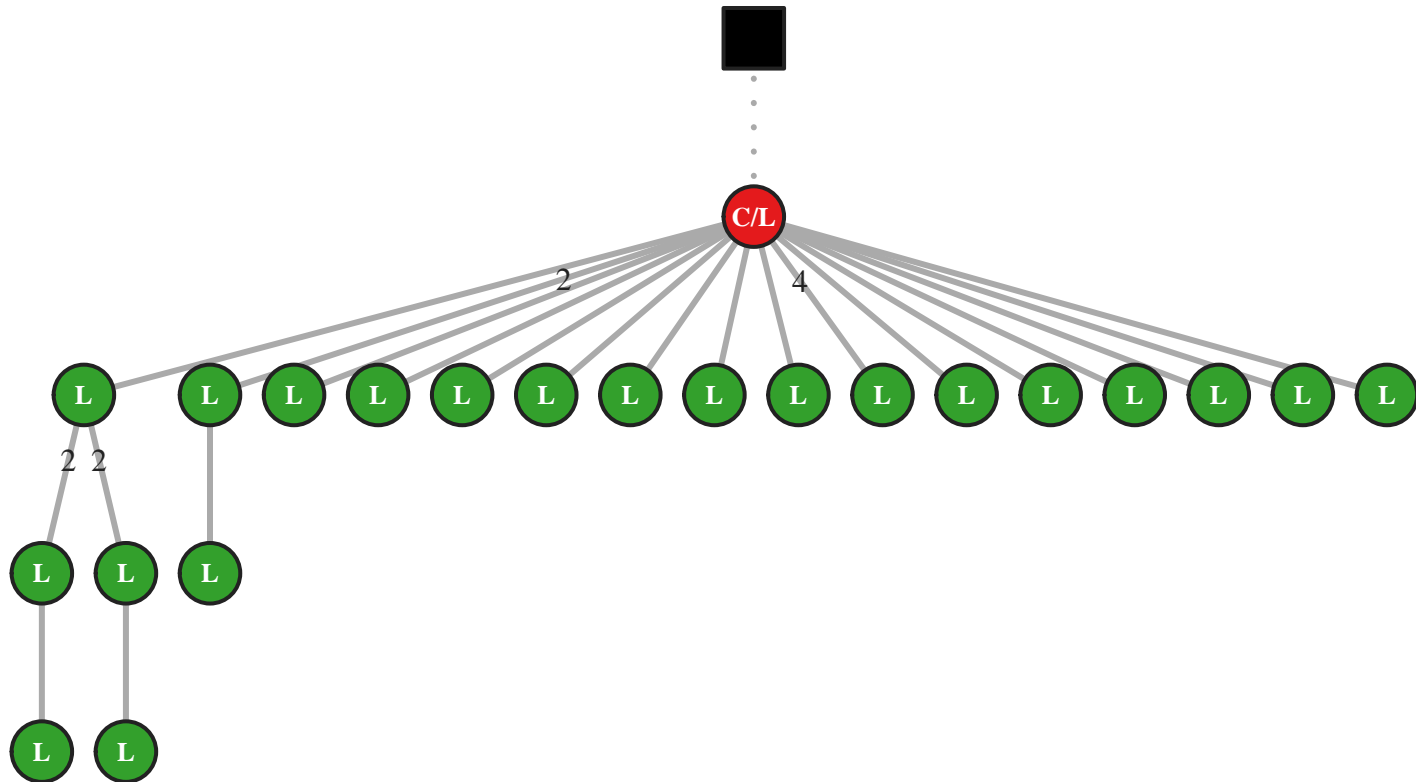

M5 IgM IGHV2-5/J4 60bp (53968)

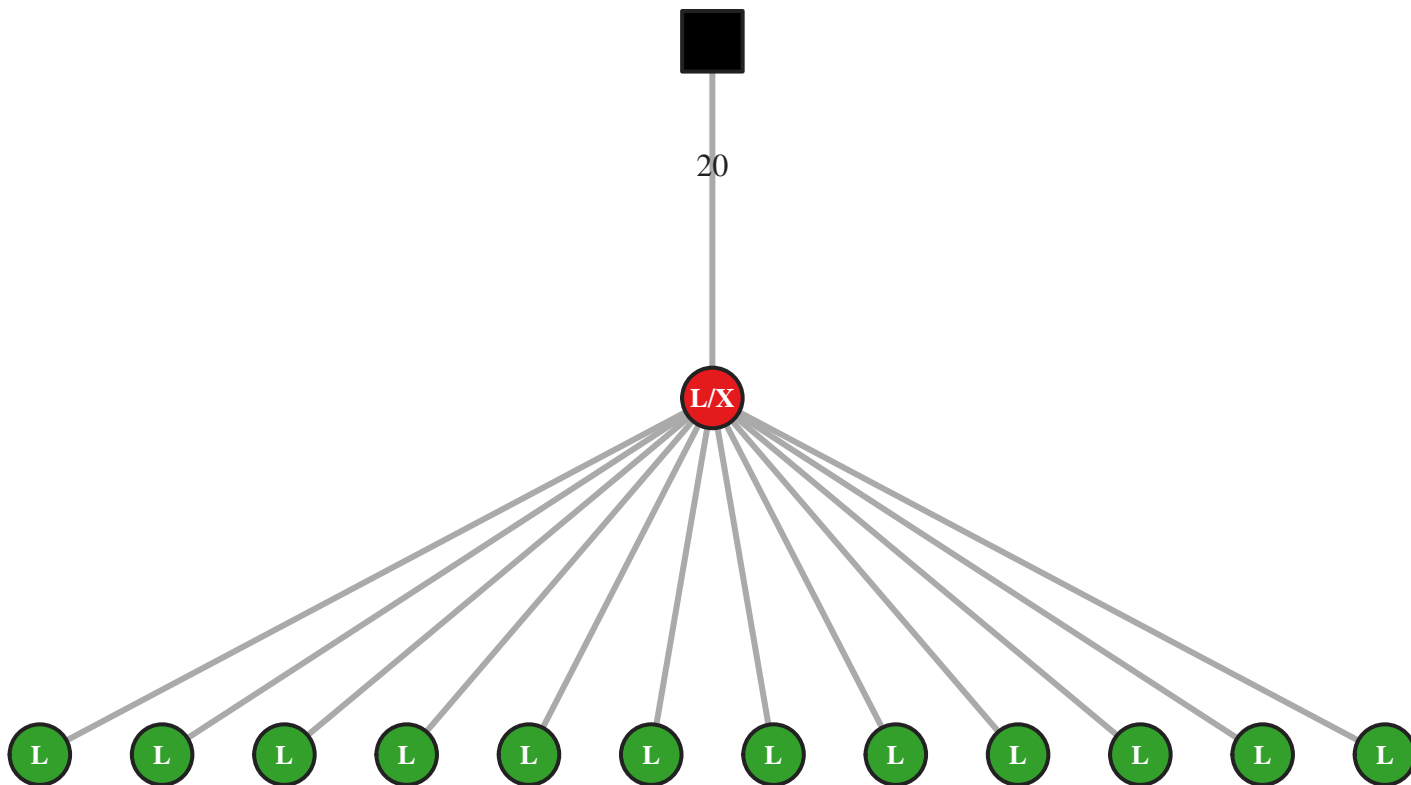

M5 IgG IGHV2-5/J4 63bp (15575)

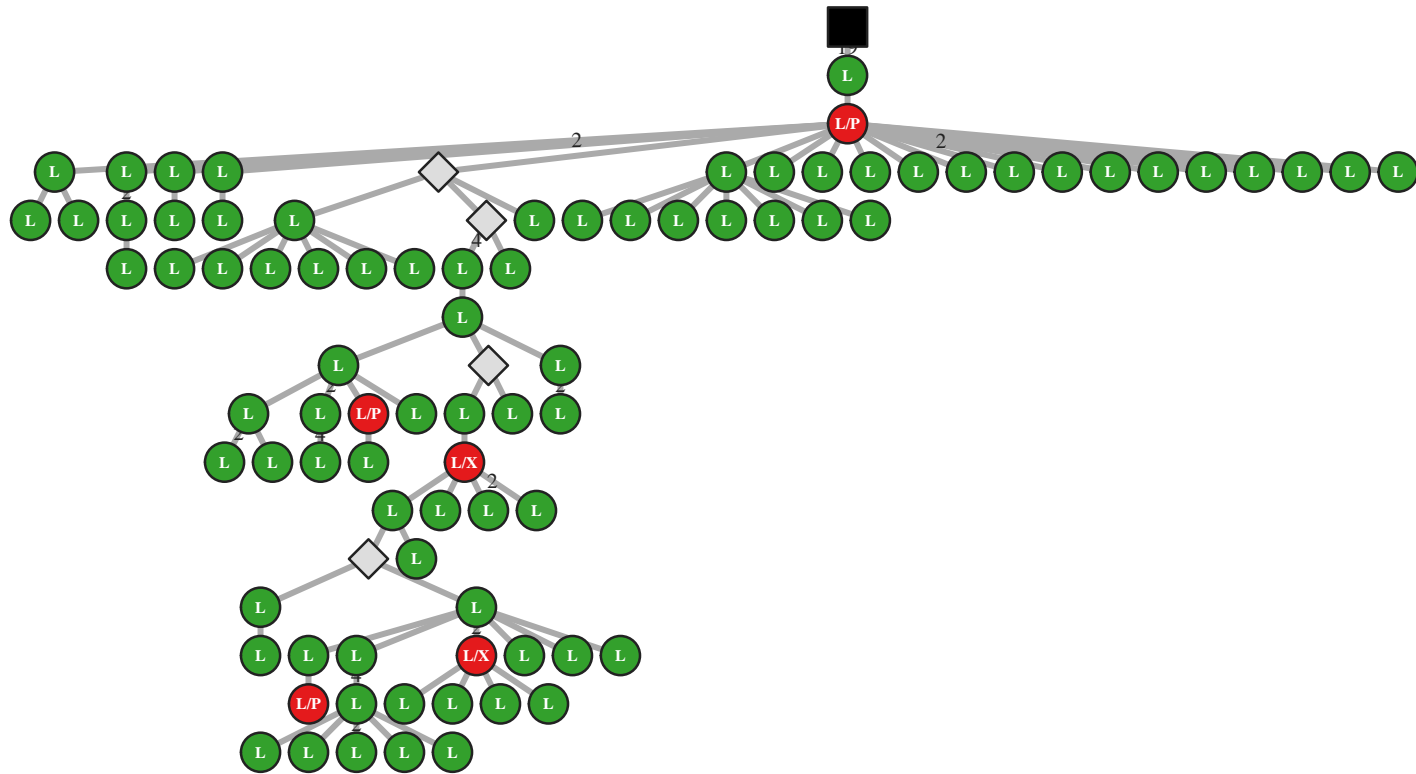

M5 IgG IGHV2-5/J4 63bp (15591)

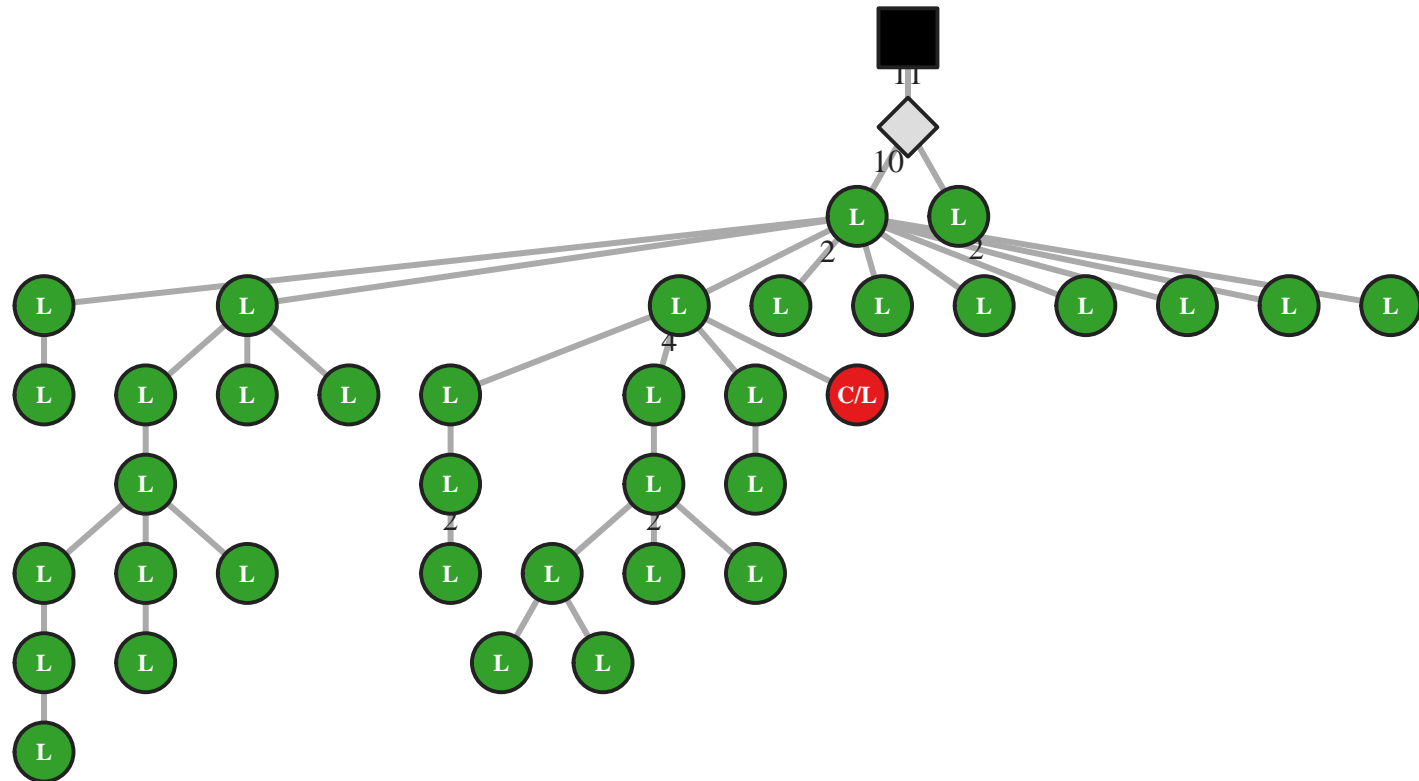

M5 IgM IGHV2-5/J4 63bp (11180)

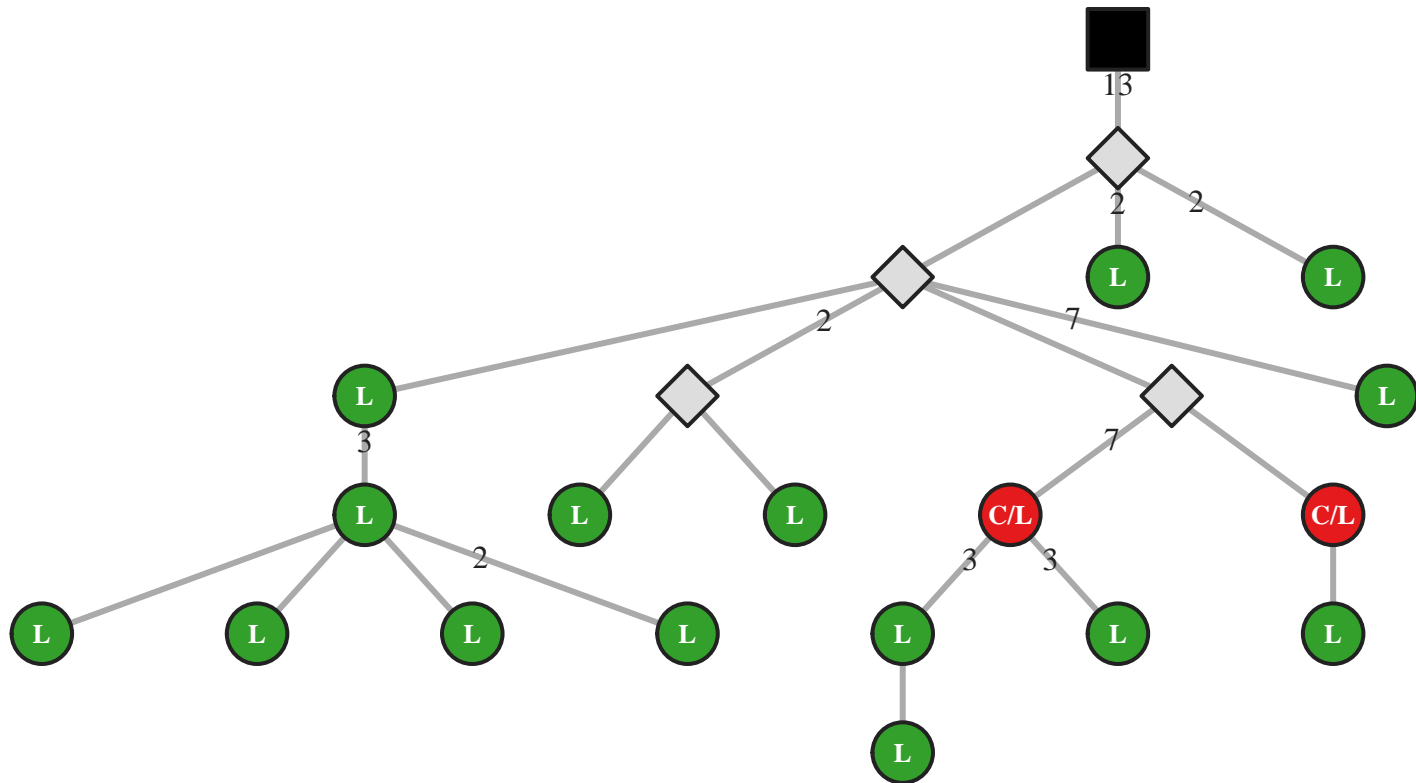

M5 IgG IGHV2-5/J4 66bp (5704)

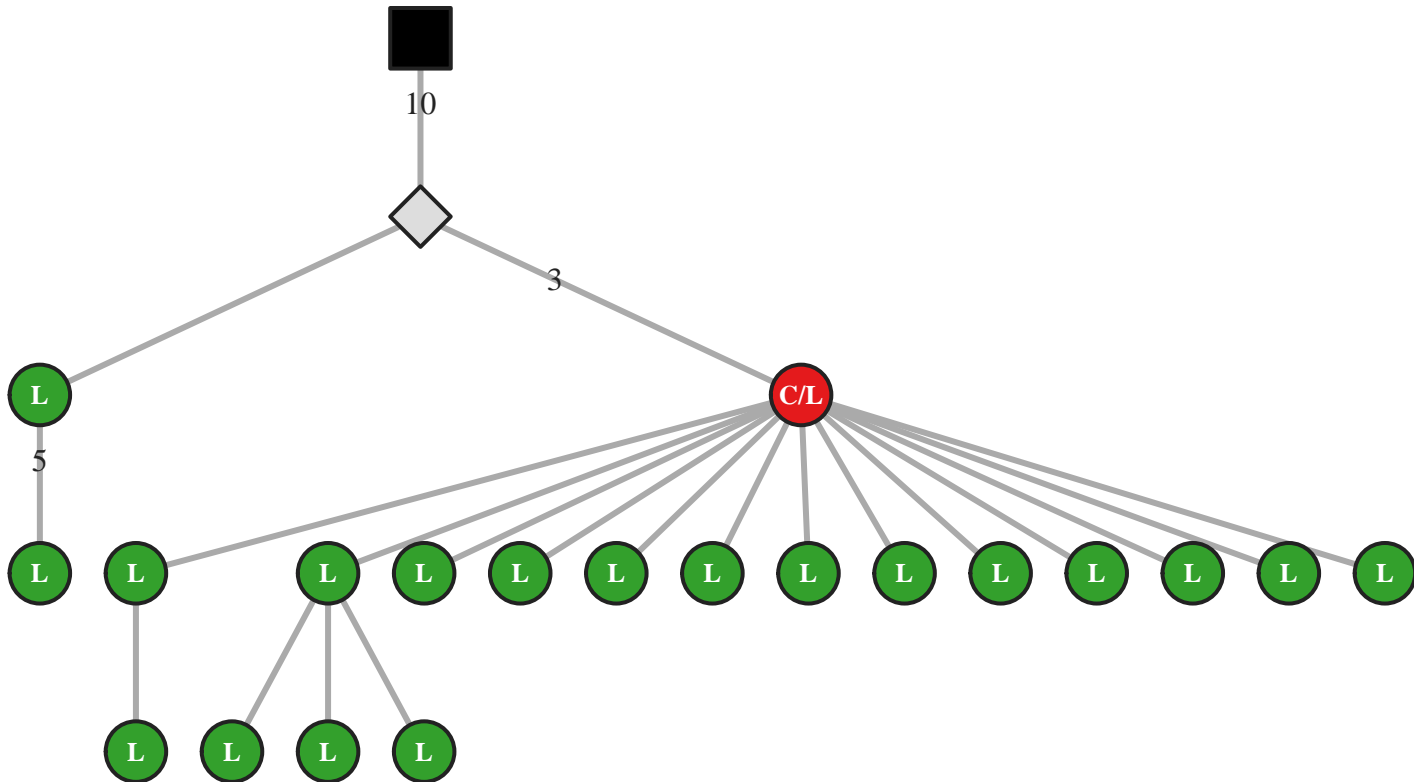

M5 IgG IGHV2-5/J4 66bp (5715)

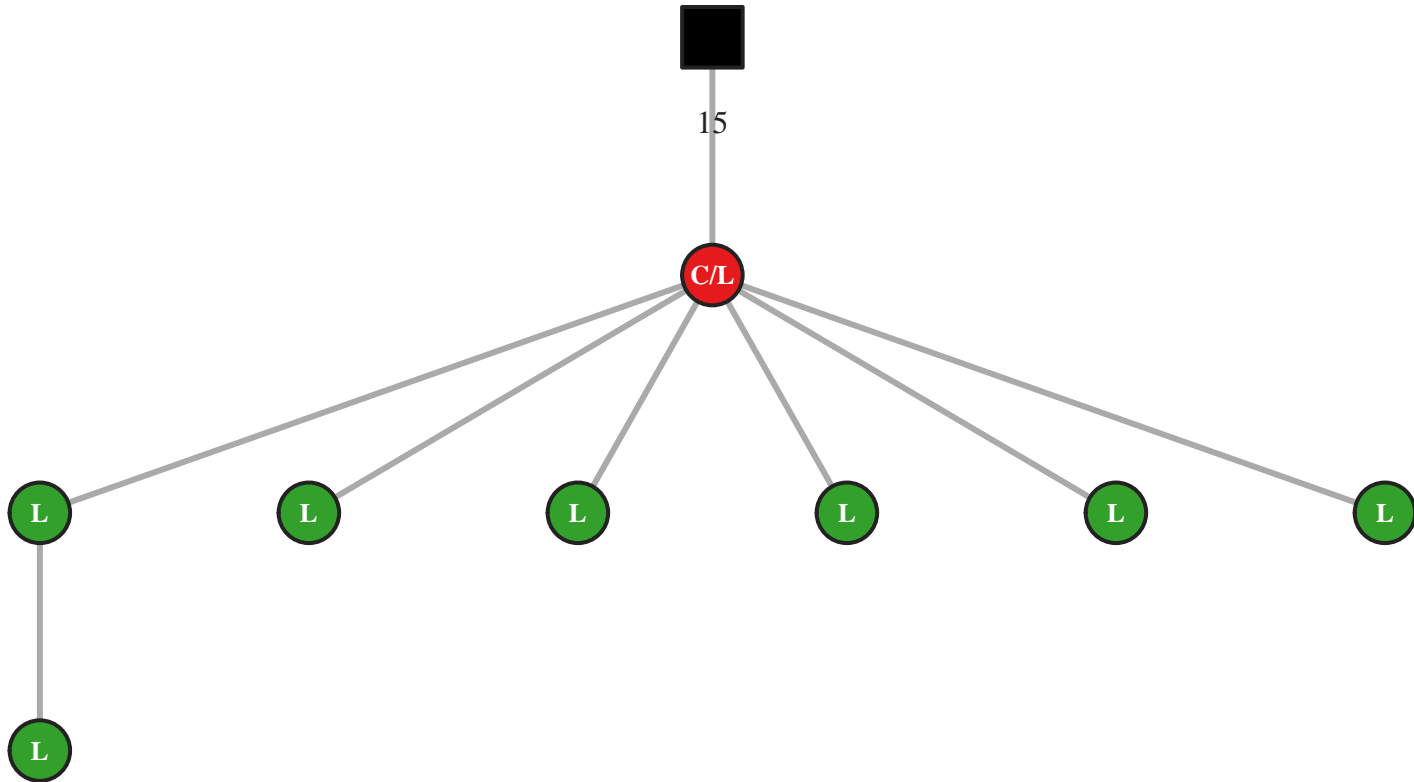

M5 IgG IGHV2-5/J4 66bp (5730)

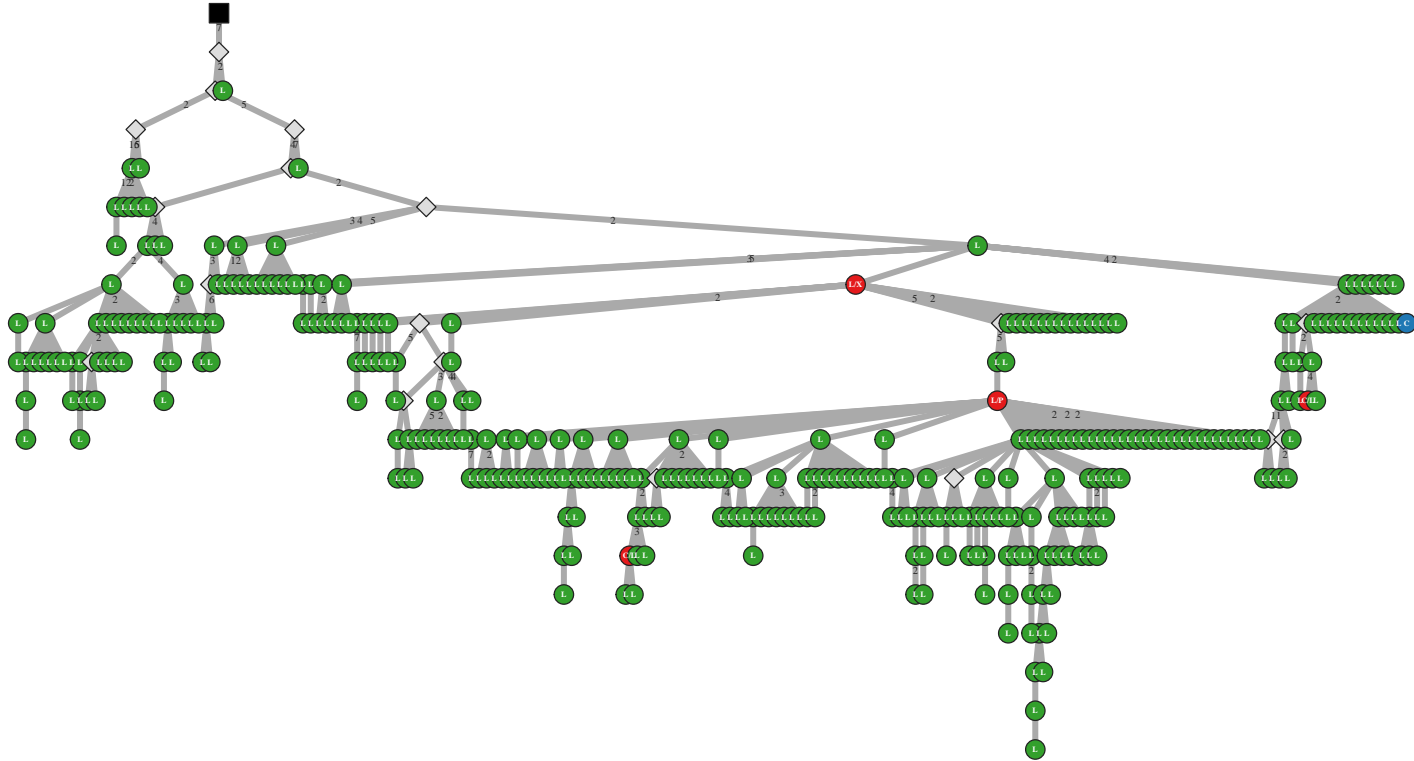

M5 IgA IGHV2-5/J5 36bp (21496)

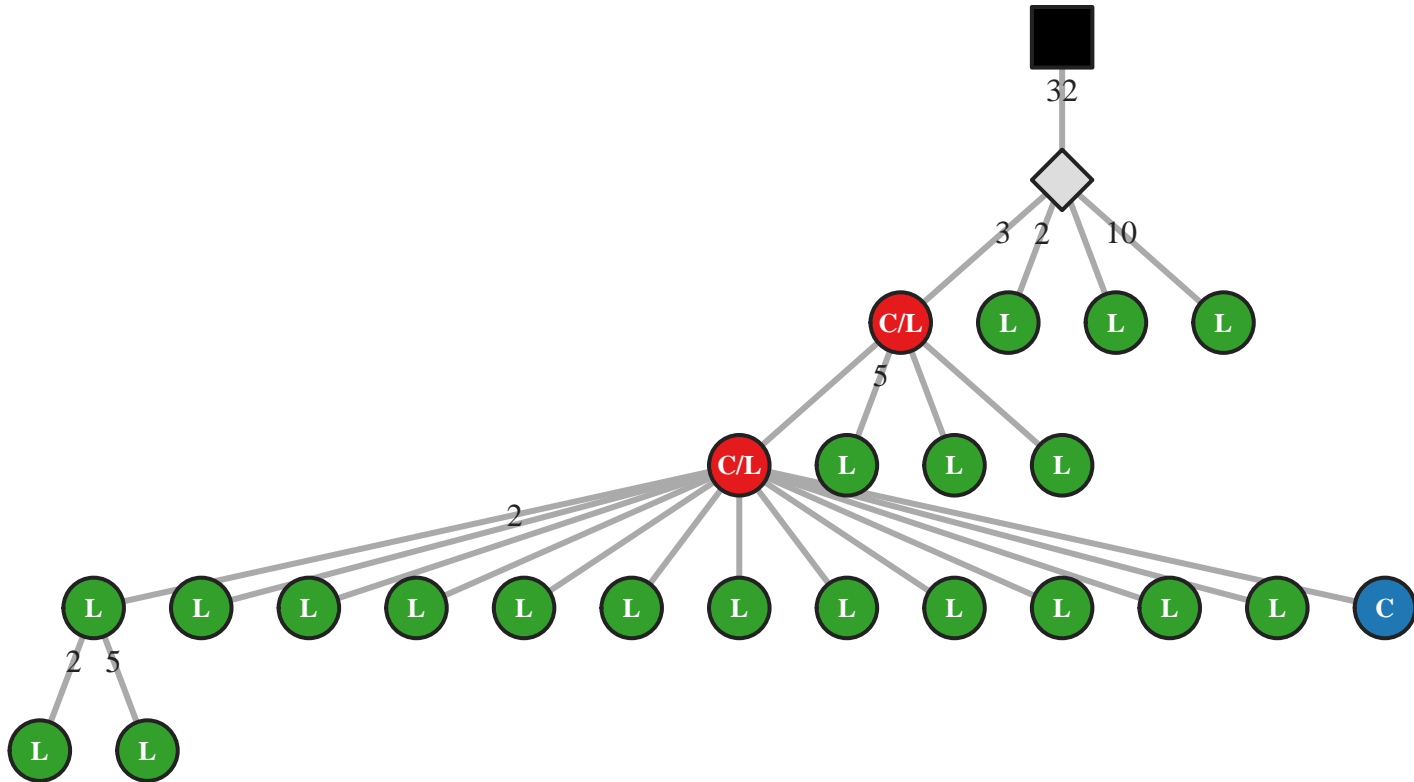

M5 IgG IGHV2-5/J5 36bp (33574)

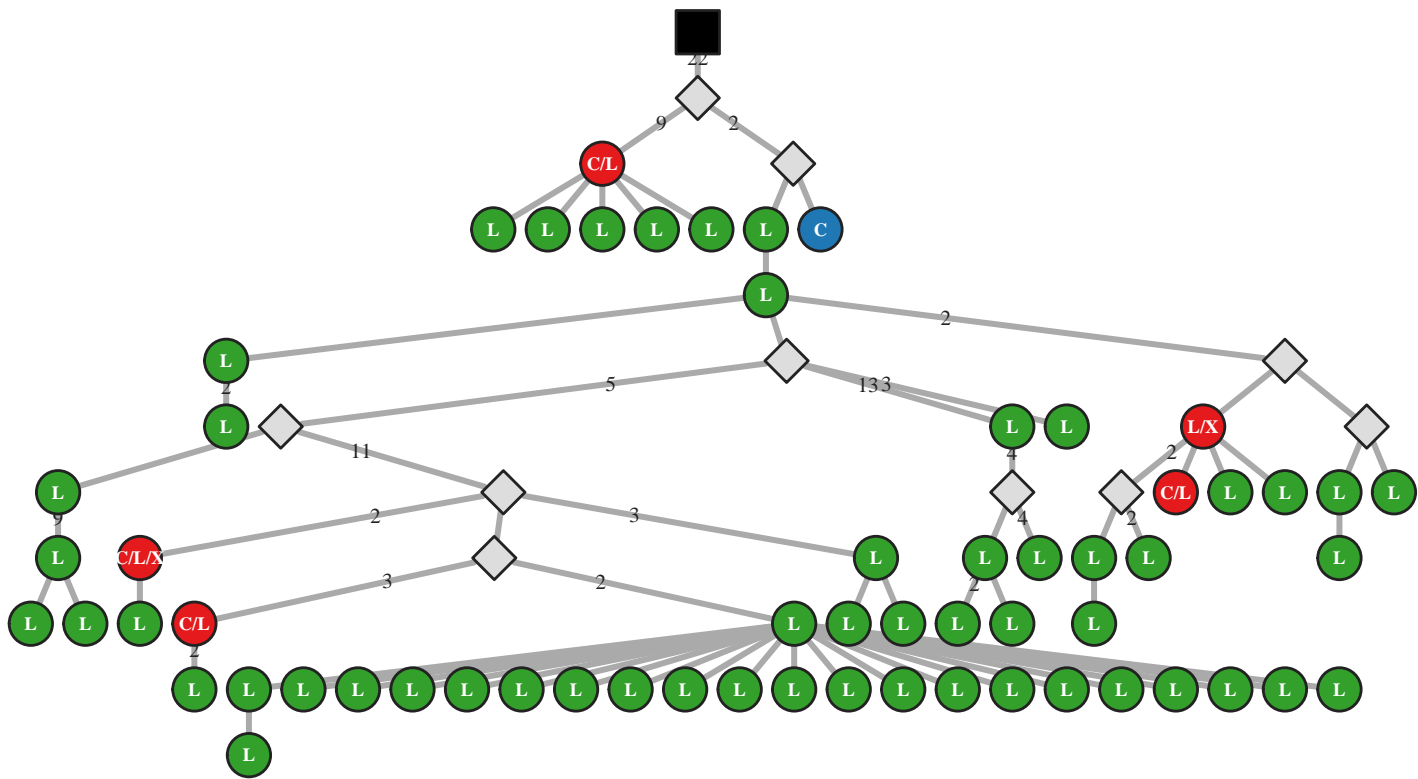

M5 IgA IGHV2-5/J5 45bp (38572)

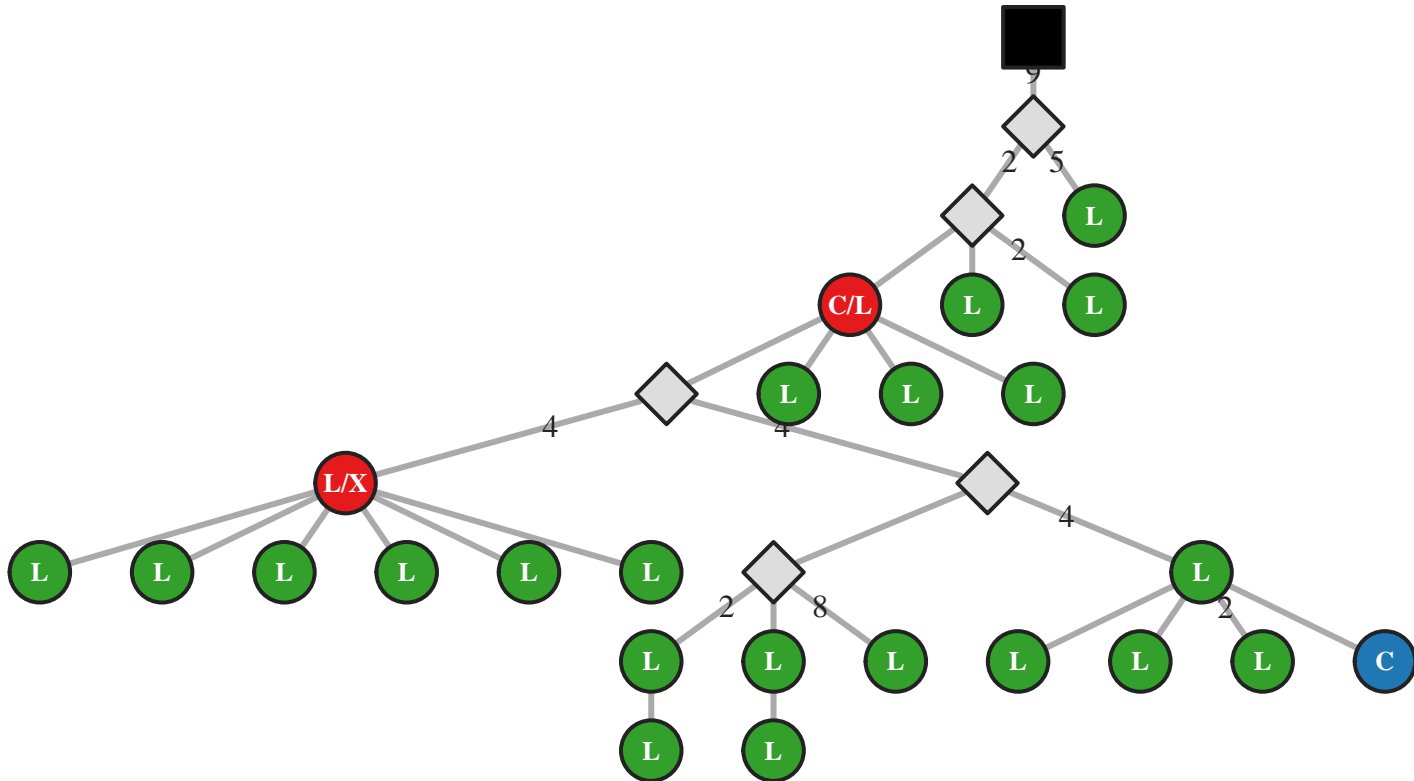

M5 IgG IGHV2-5/J5 45bp (5778)

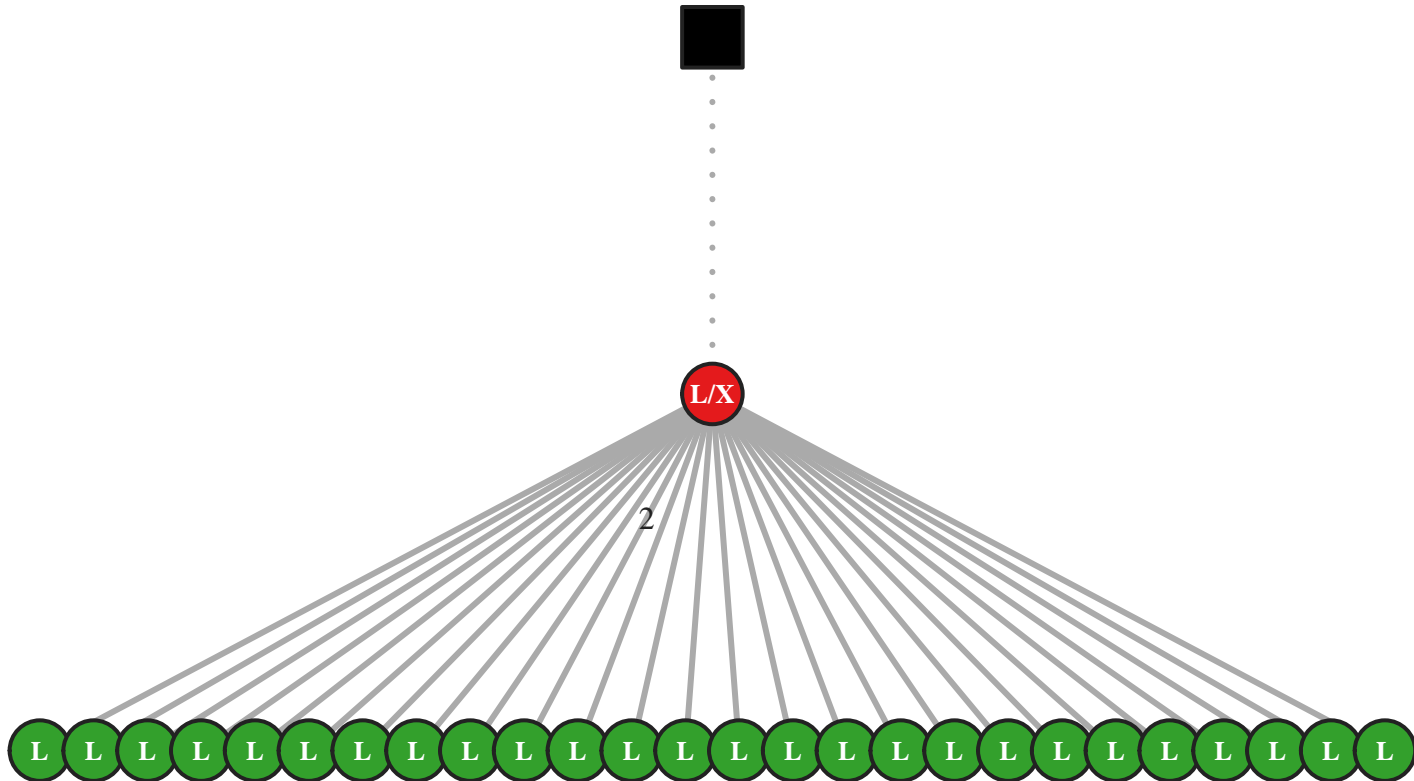

M5 IgA IGHV2-5/J5 48bp (48663)

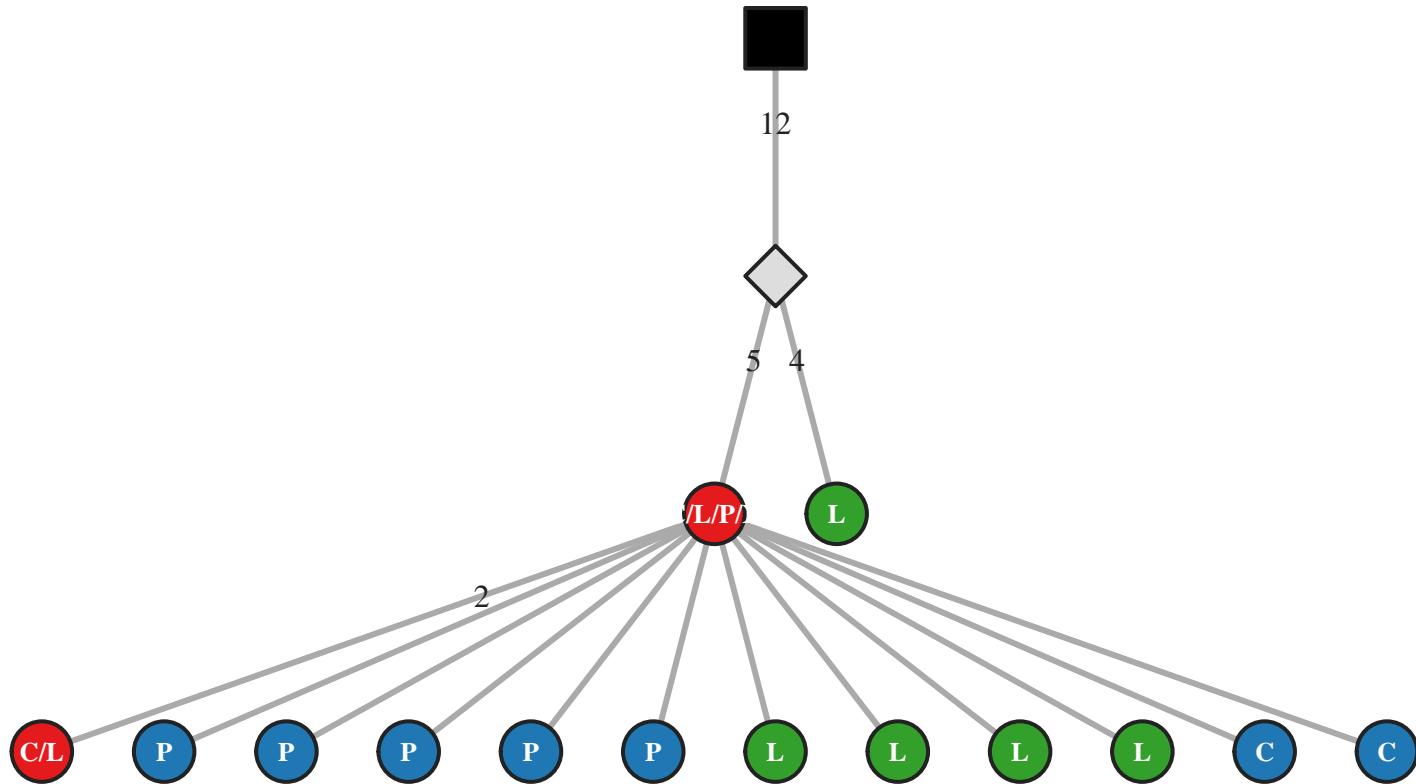

M5 IgG IGHV2-5/J5 54bp (24612)

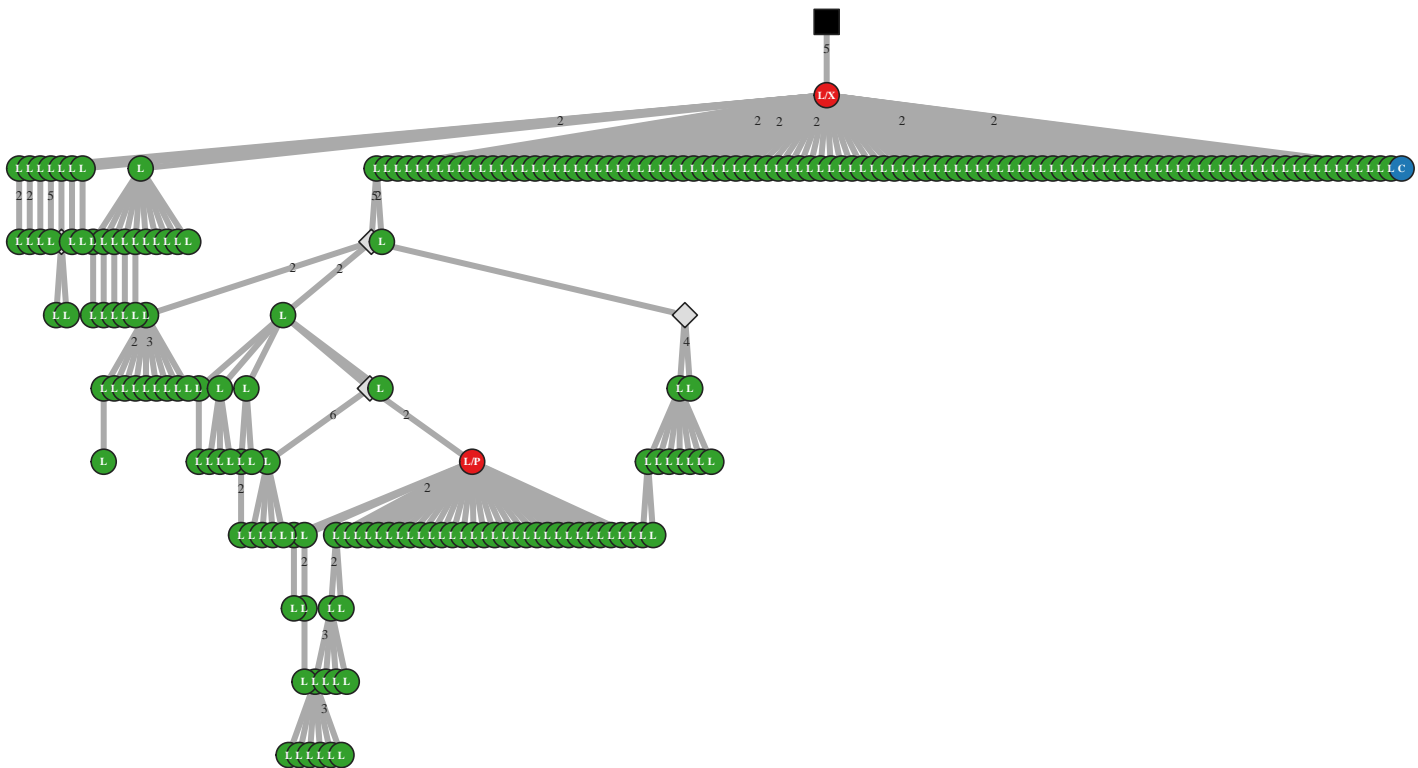

M5 IgG IGHV2-5/J5 54bp (24633)

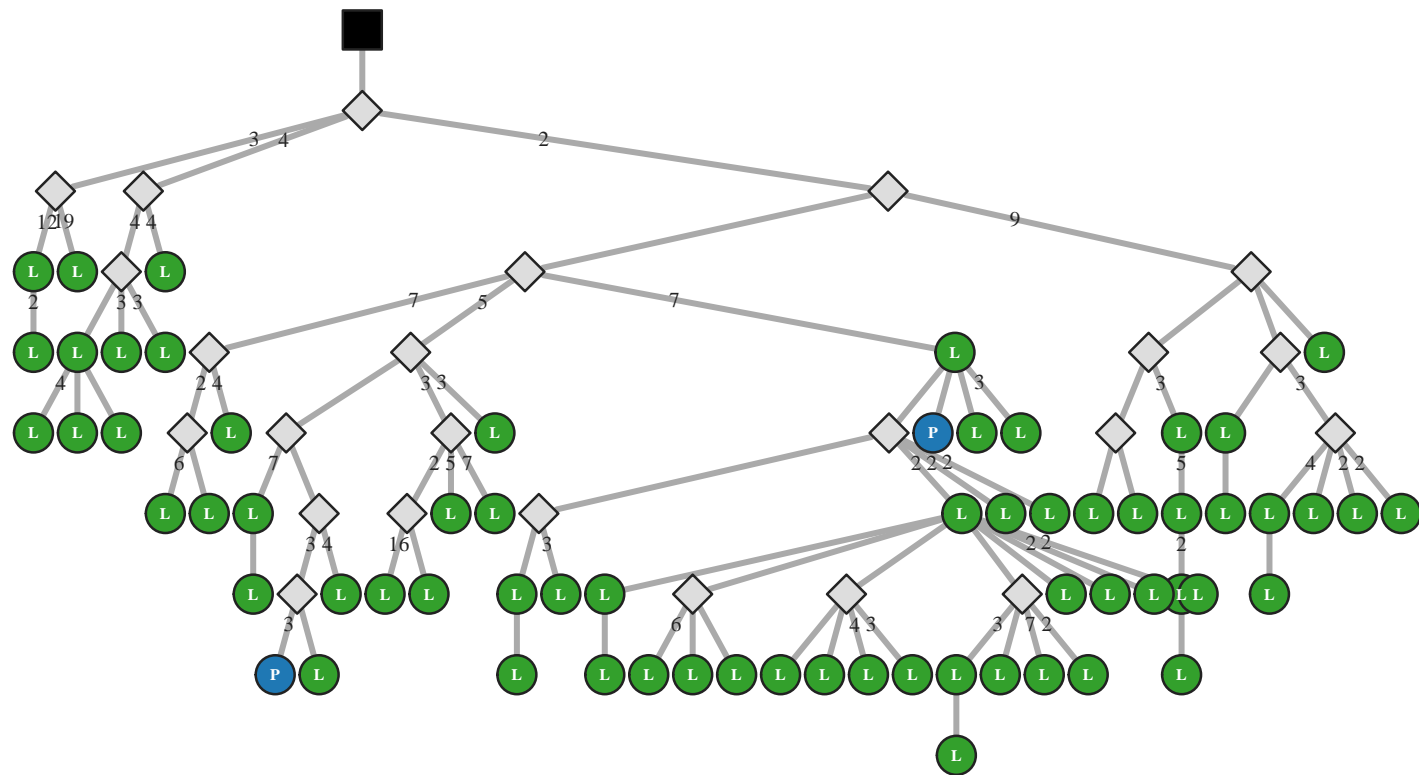

M5 IgG IGHV2-5/J5 54bp (24644)

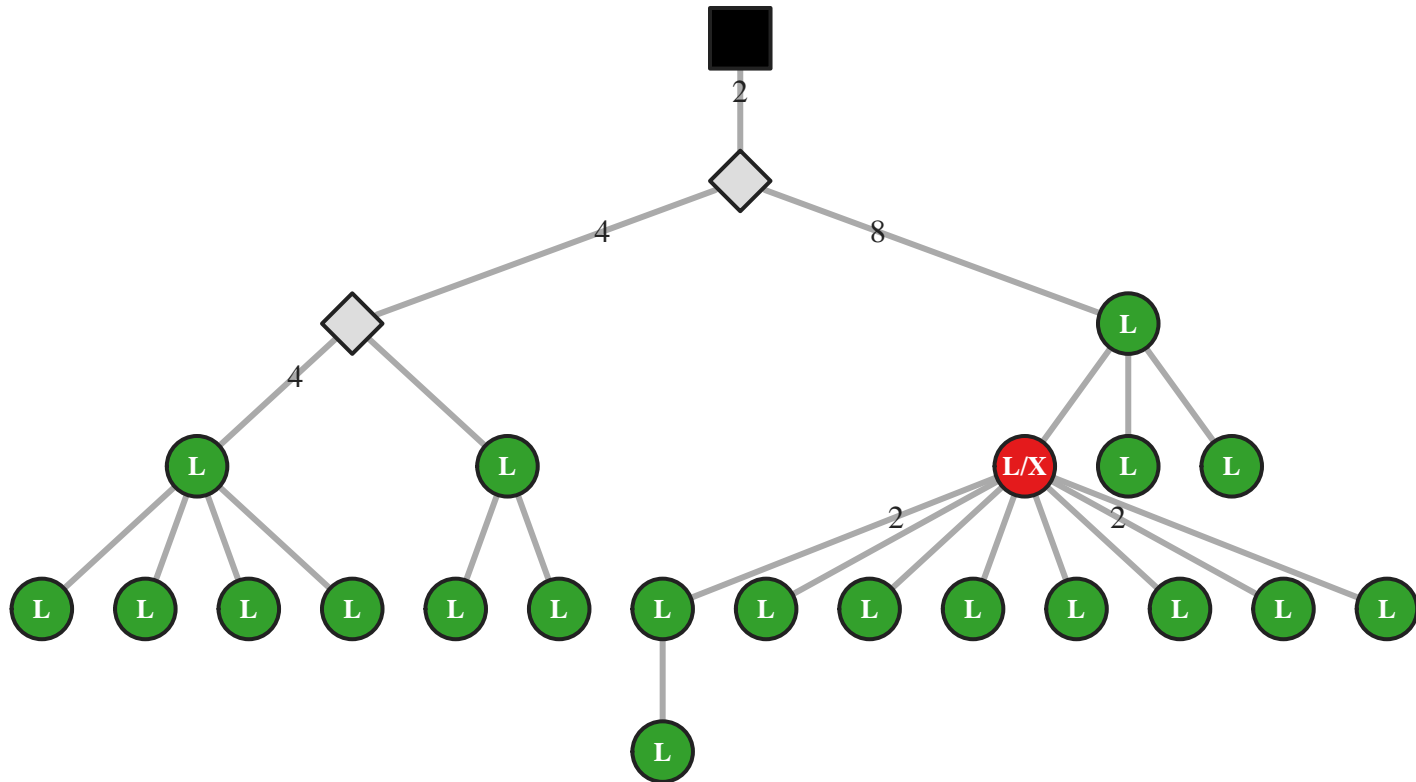

M5 IgG IGHV2-5/J5 57bp (5800)

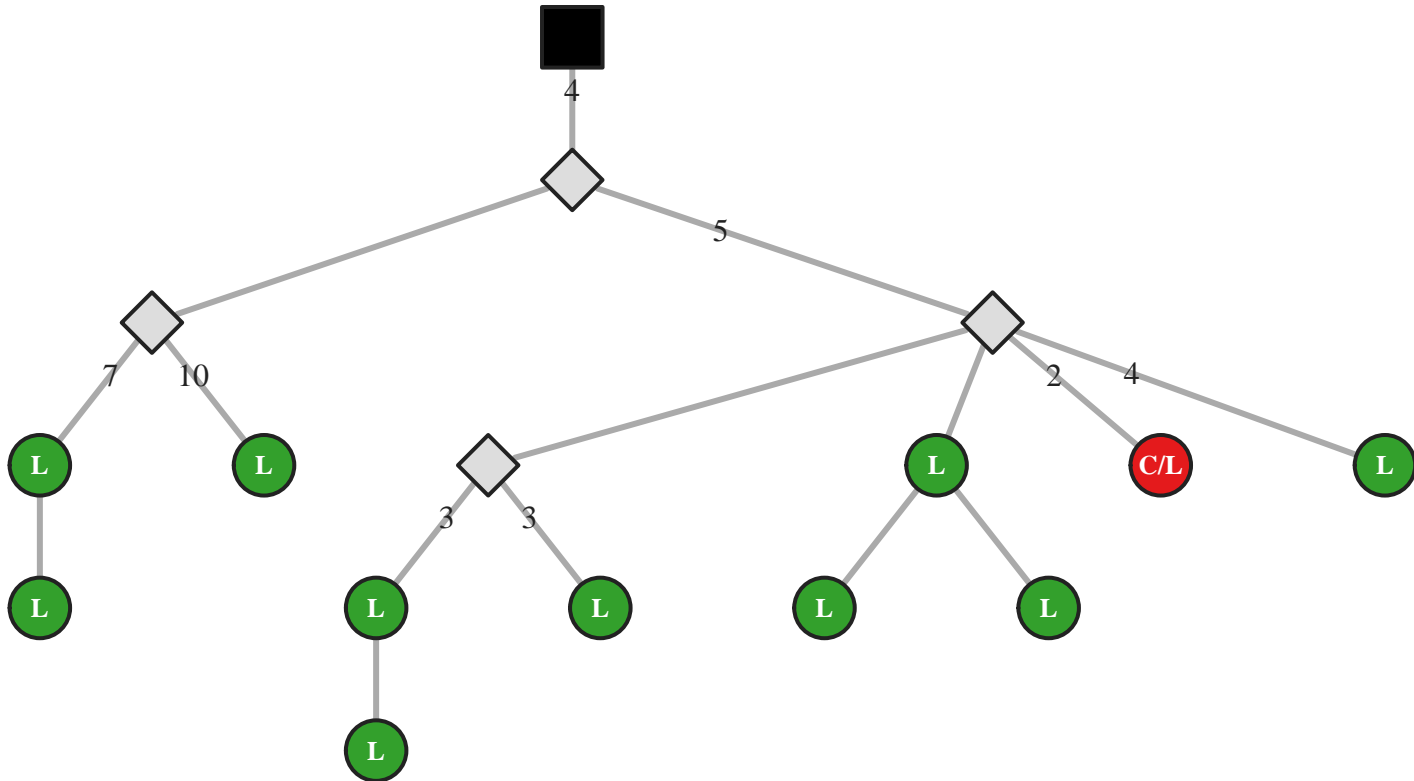

M5 IgG IGHV2-5/J5 57bp (5806)

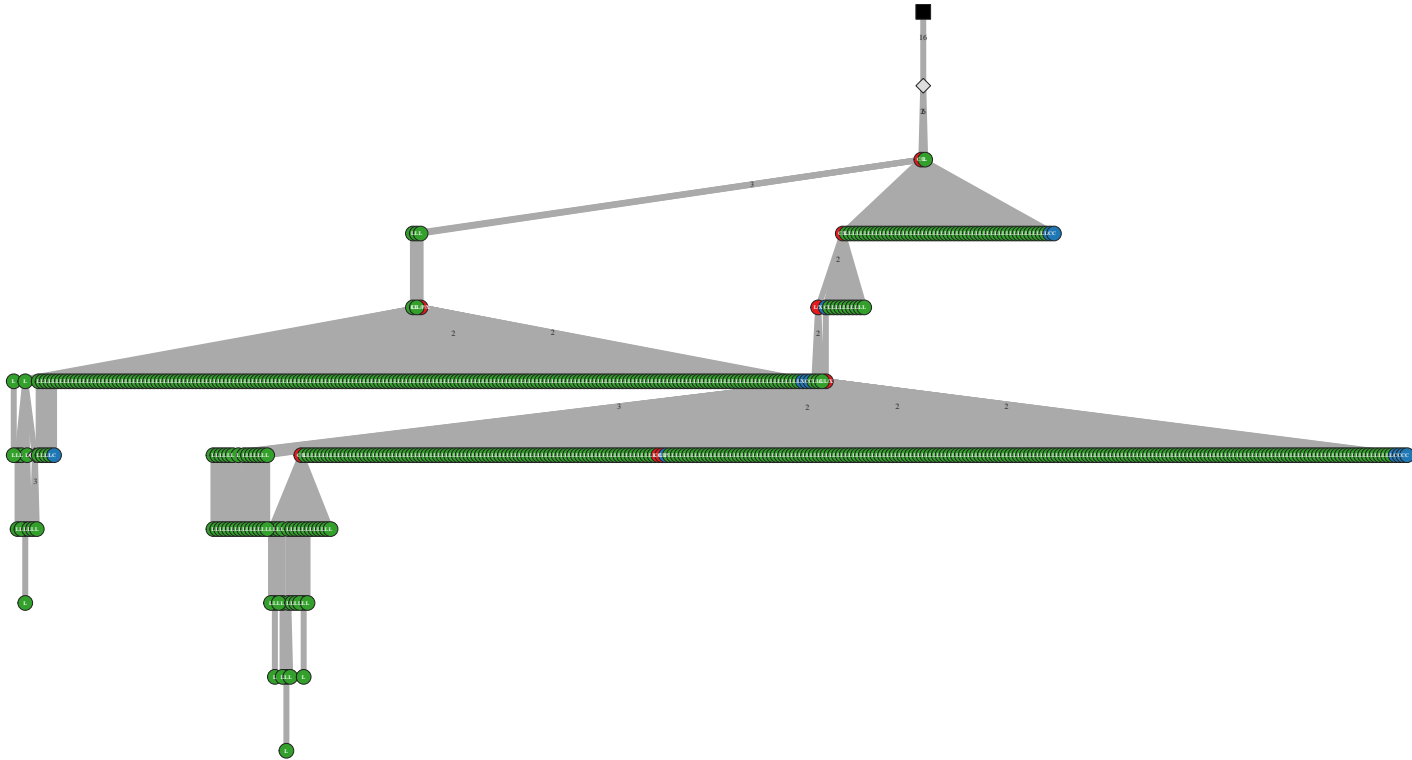

M5 IgG IGHV2-5/J5 57bp (5826)

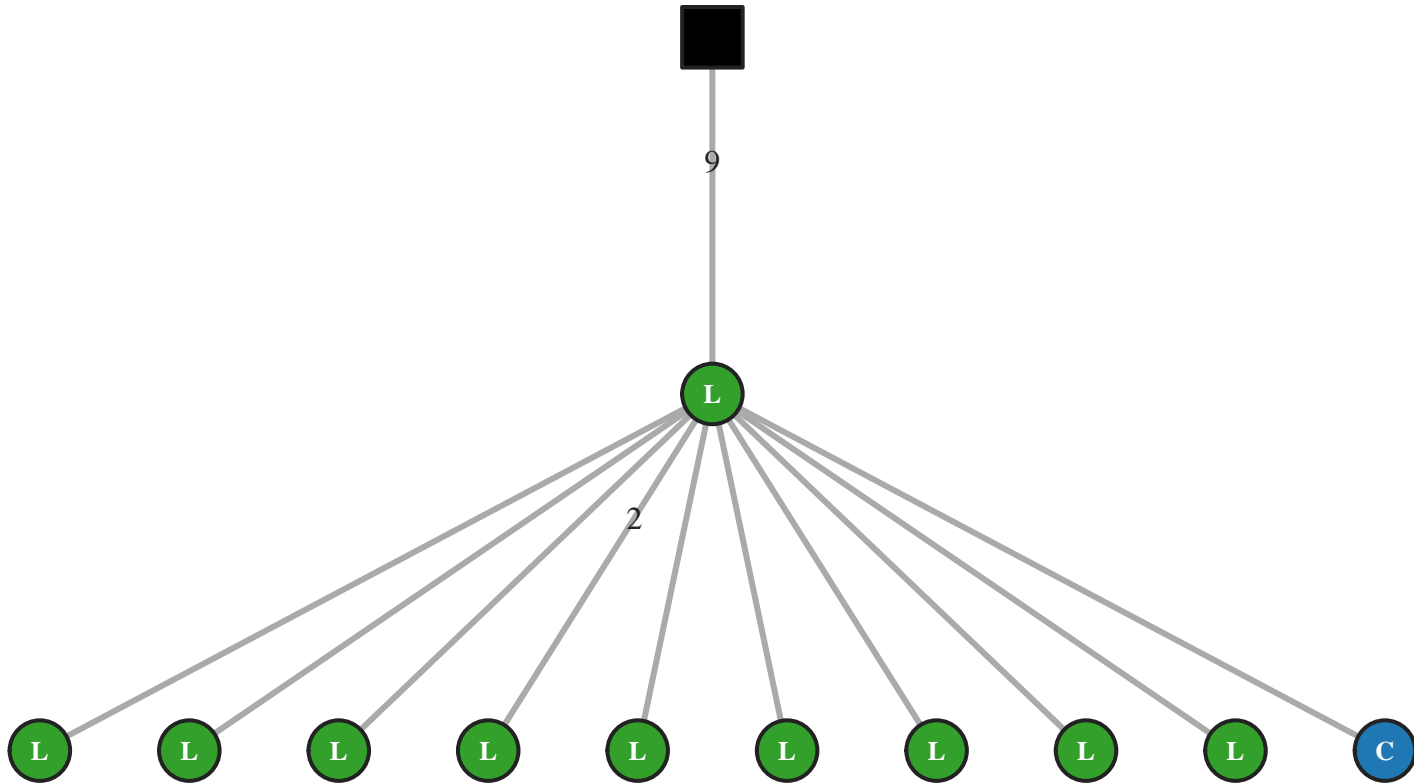

M5 IgM IGHV2-5/J5 57bp (20534)

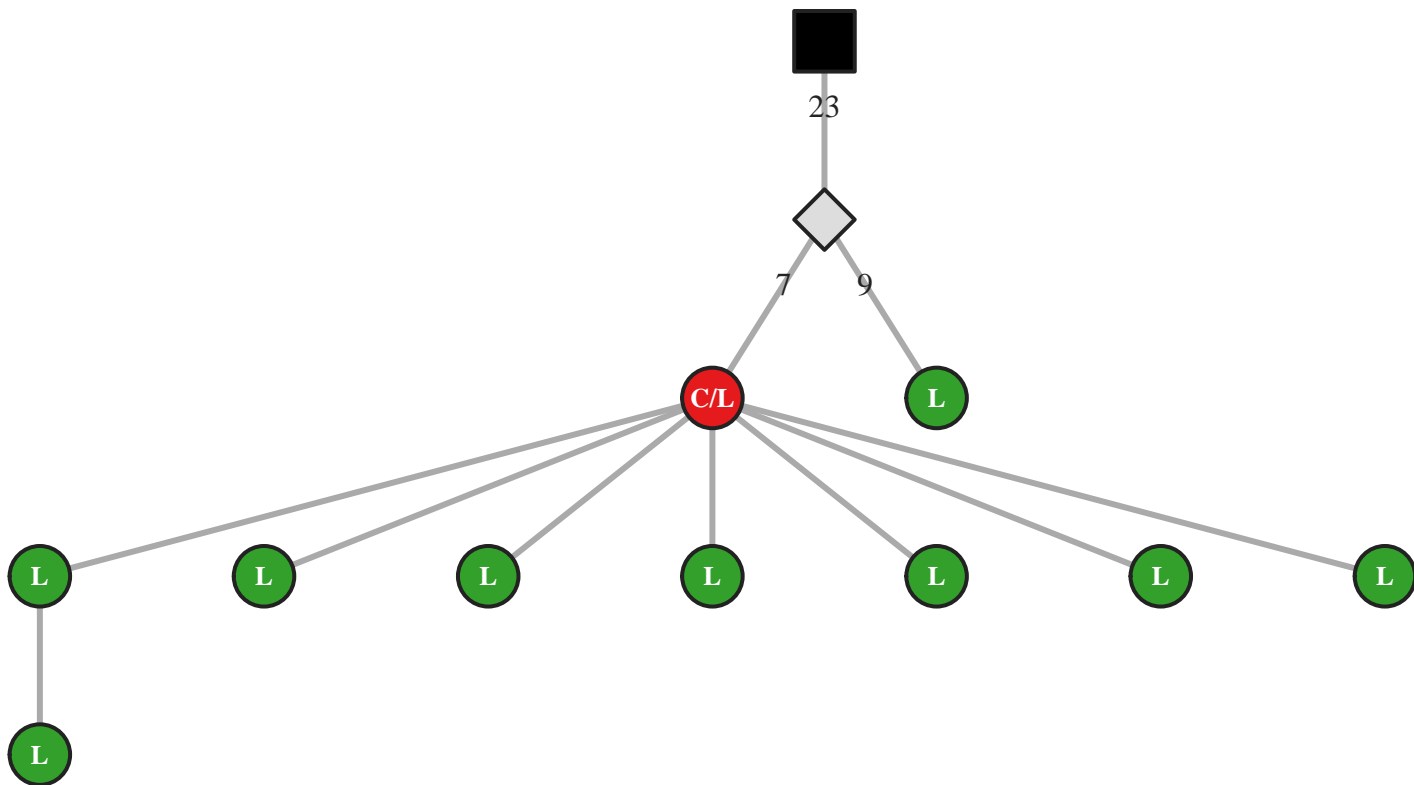

M5 IgA IGHV2-5/J5 60bp (30344)

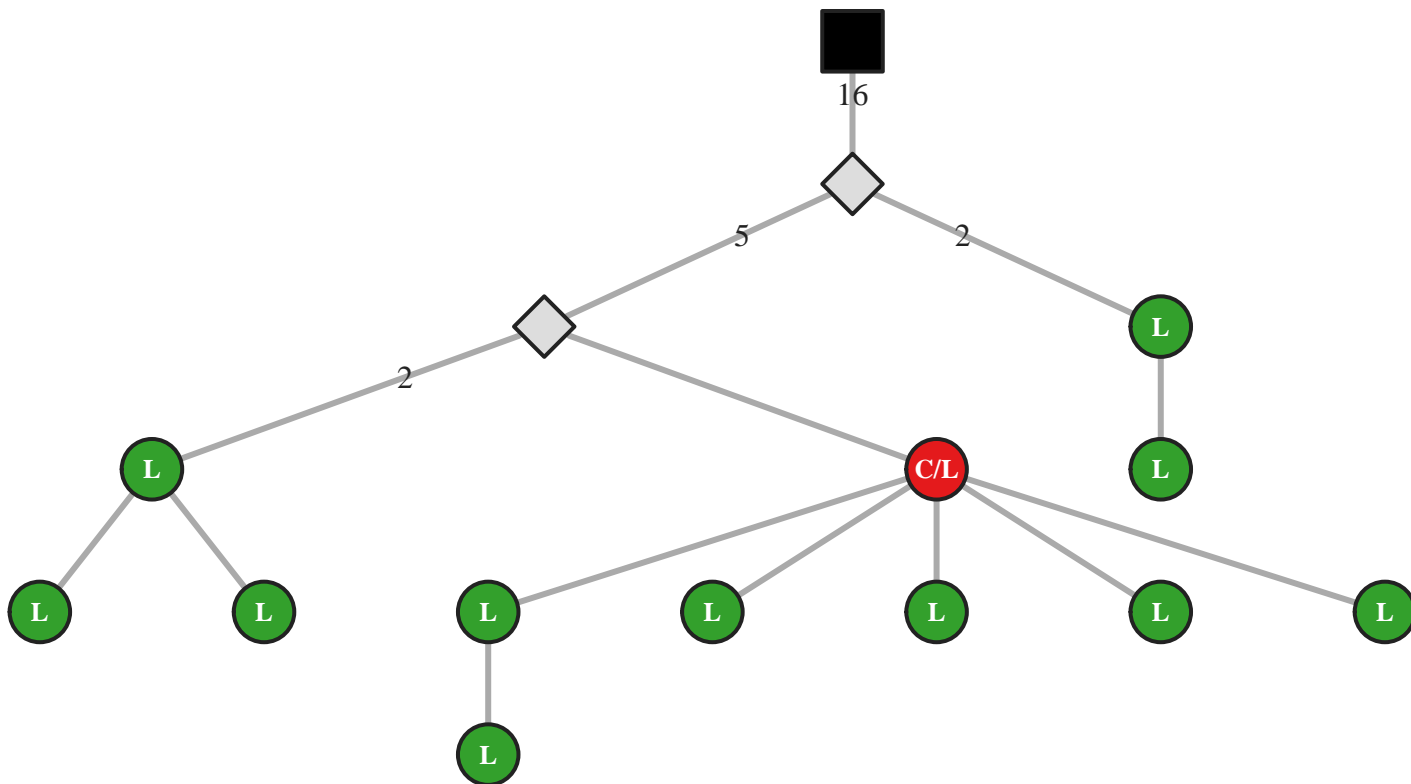

M5 IgA IGHV2-5/J5 60bp (30348)

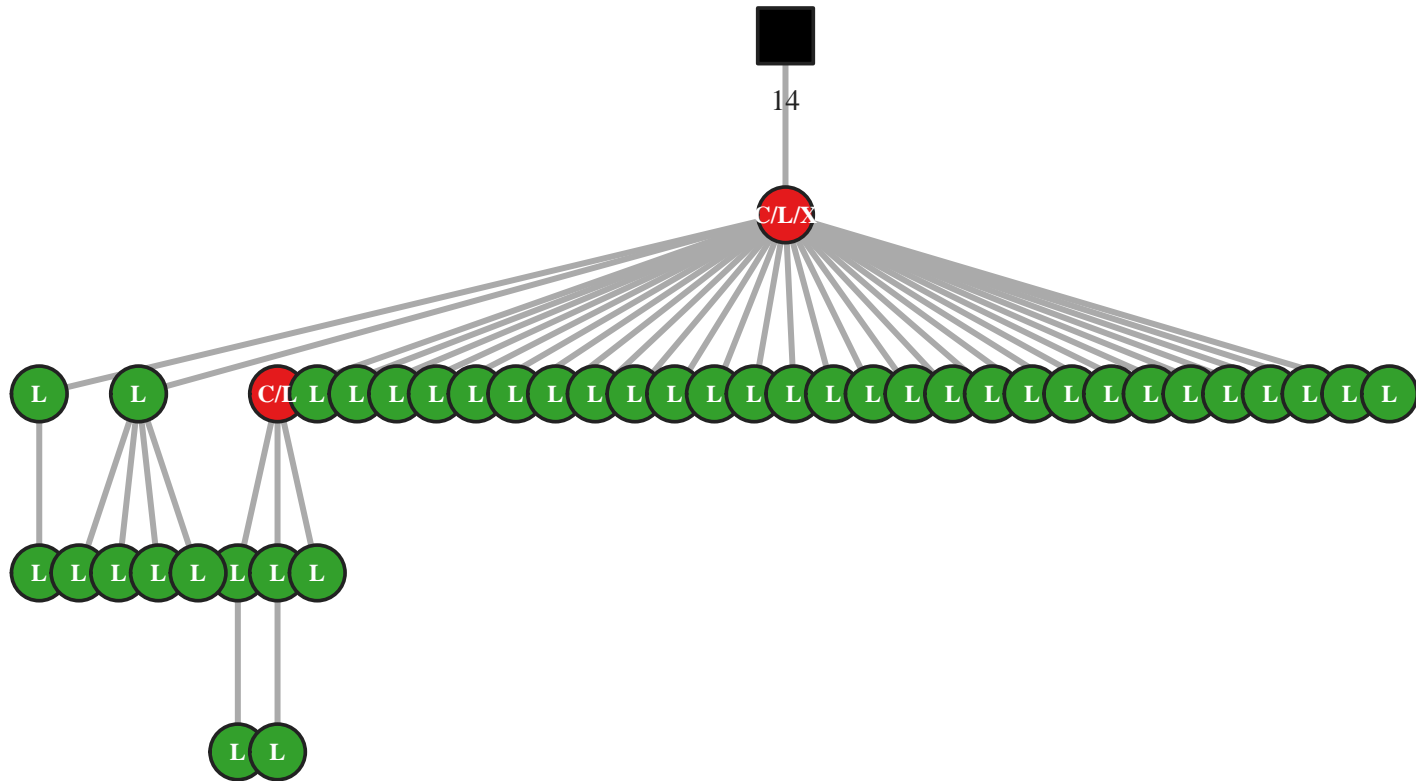

M5 IgG IGHV2-5/J5 60bp (33584)

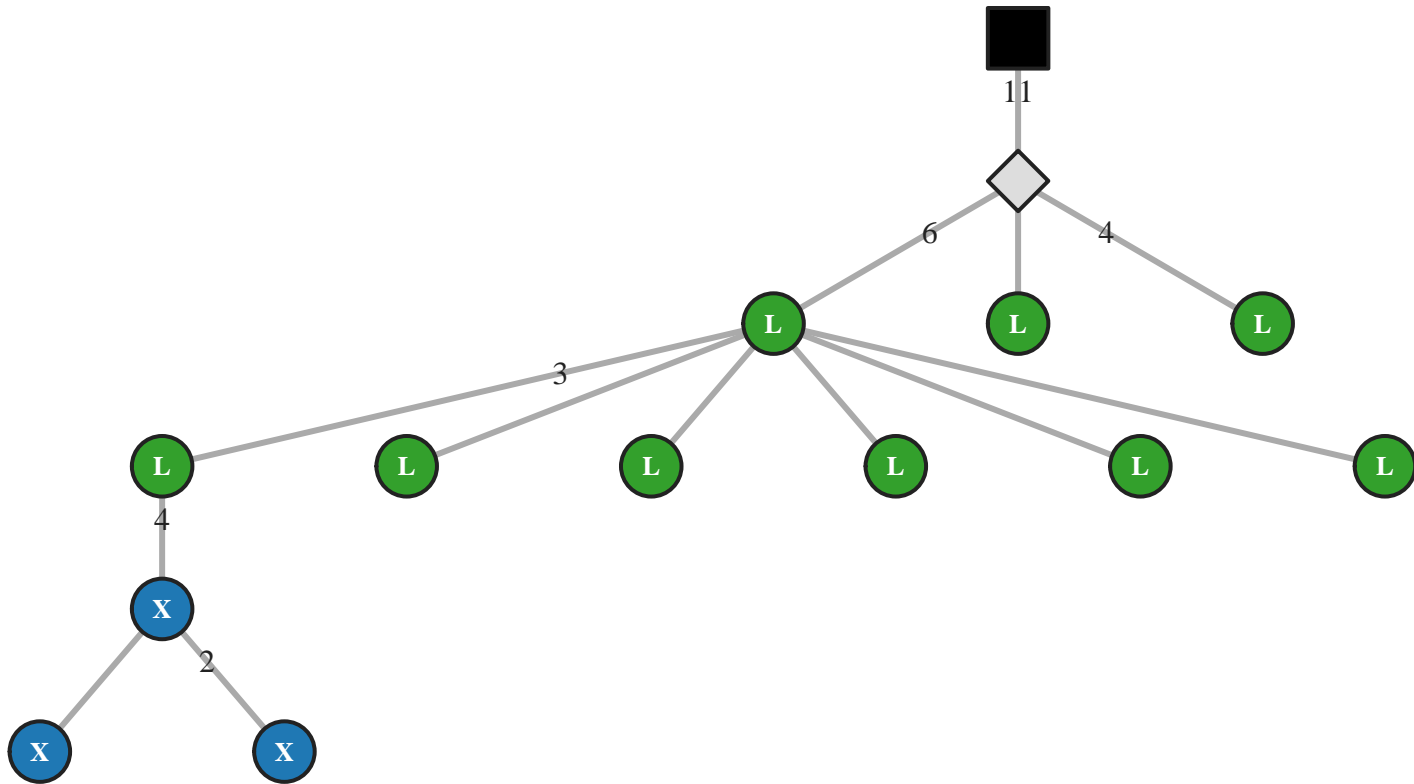

M5 IgG IGHV2-5/J5 60bp (33591)

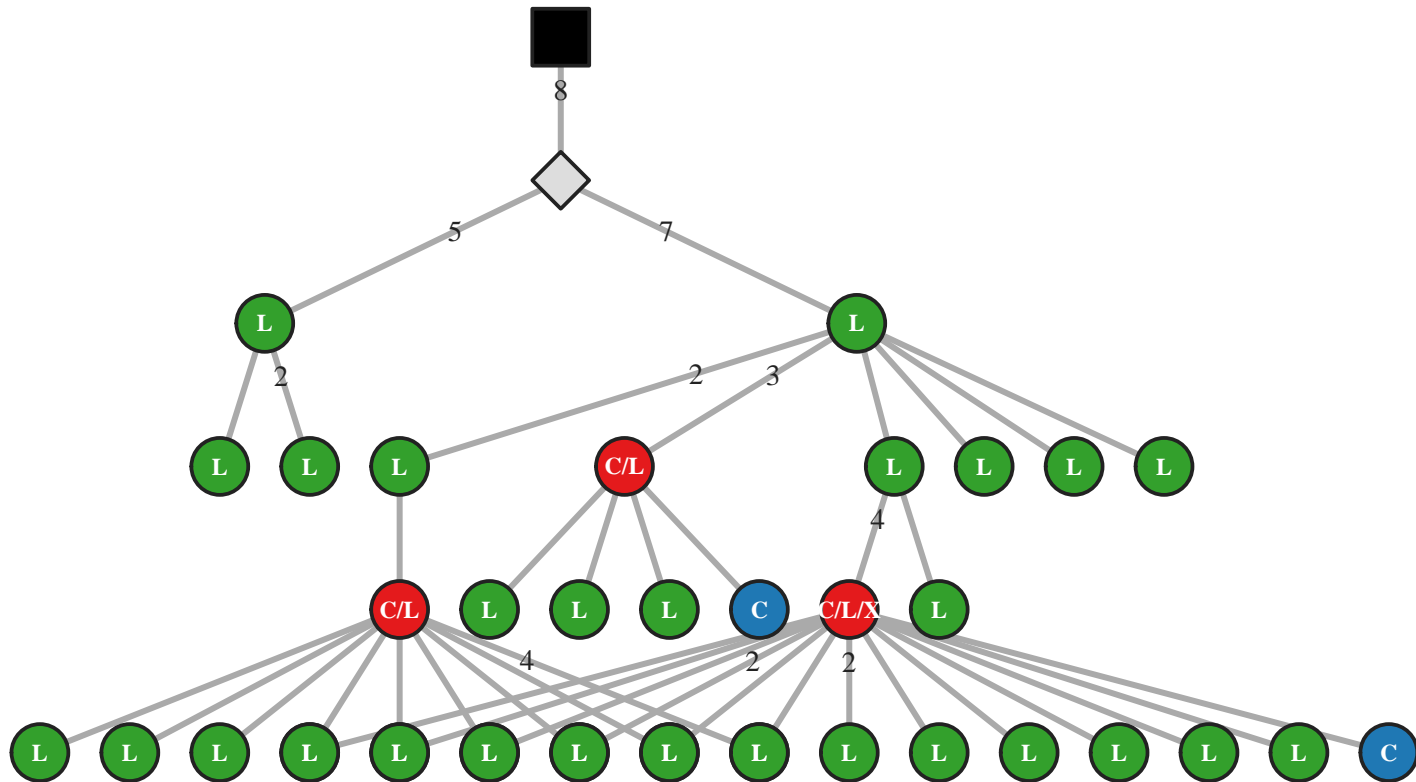

M5 IgG IGHV2-5/J5 60bp (33602)

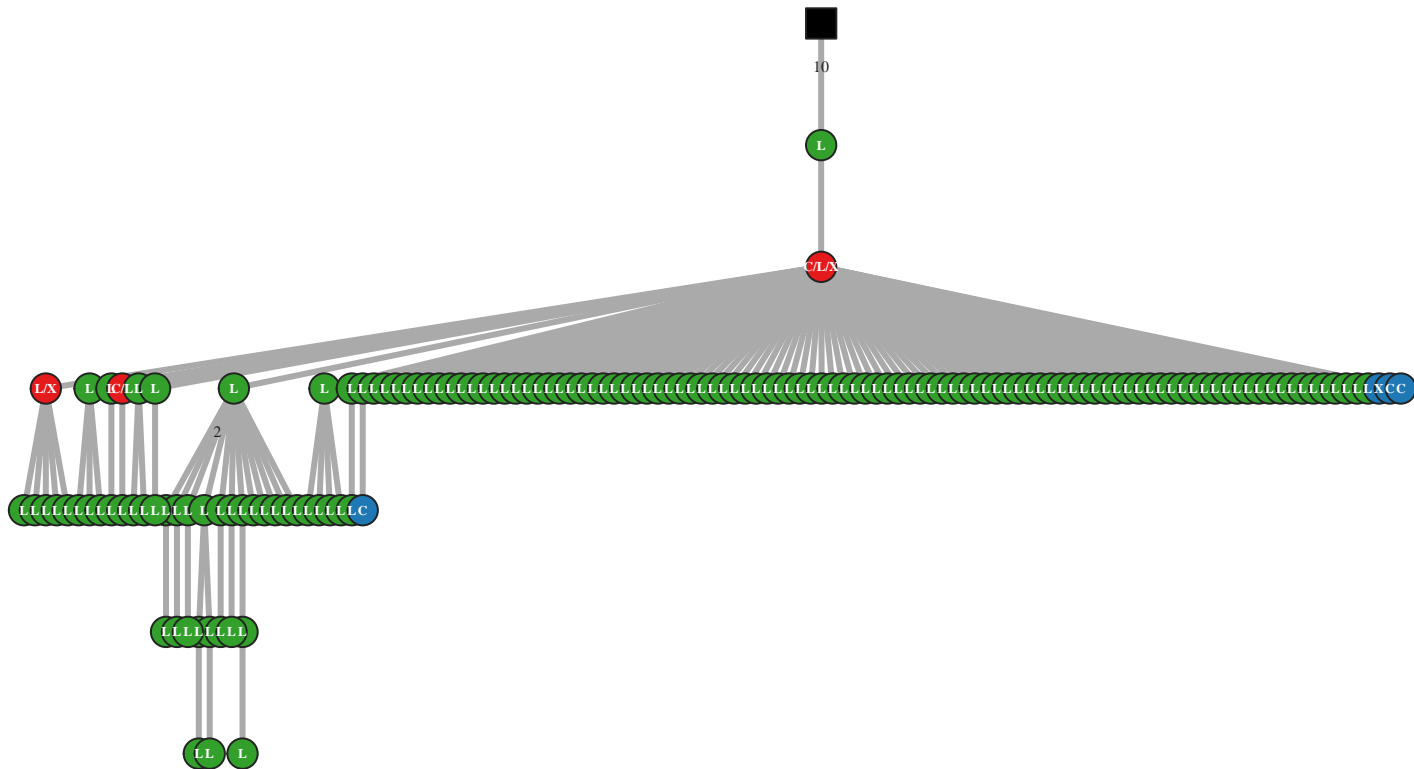

M5 IgG IGHV2-5/J5 60bp (33609)

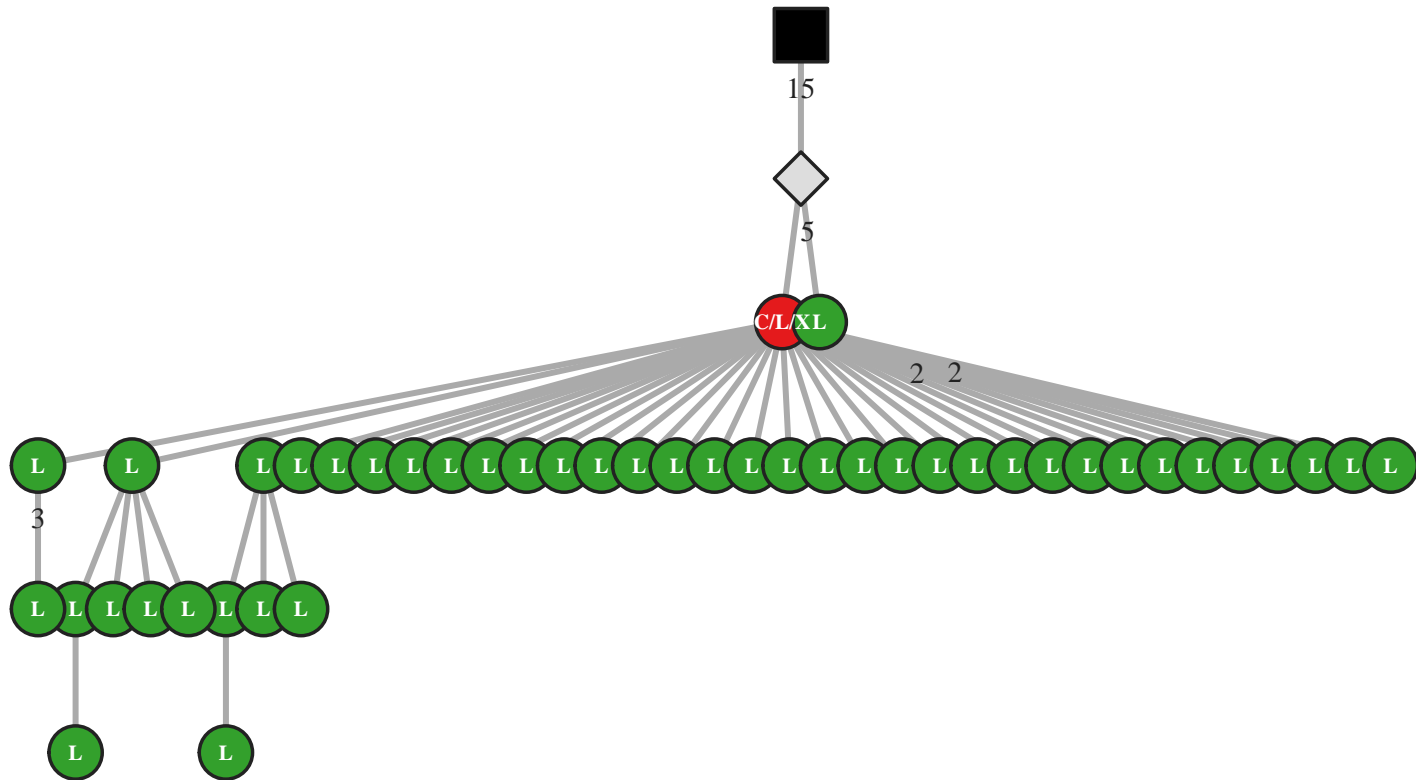

M5 IgG IGHV2-5/J5 60bp (33610)

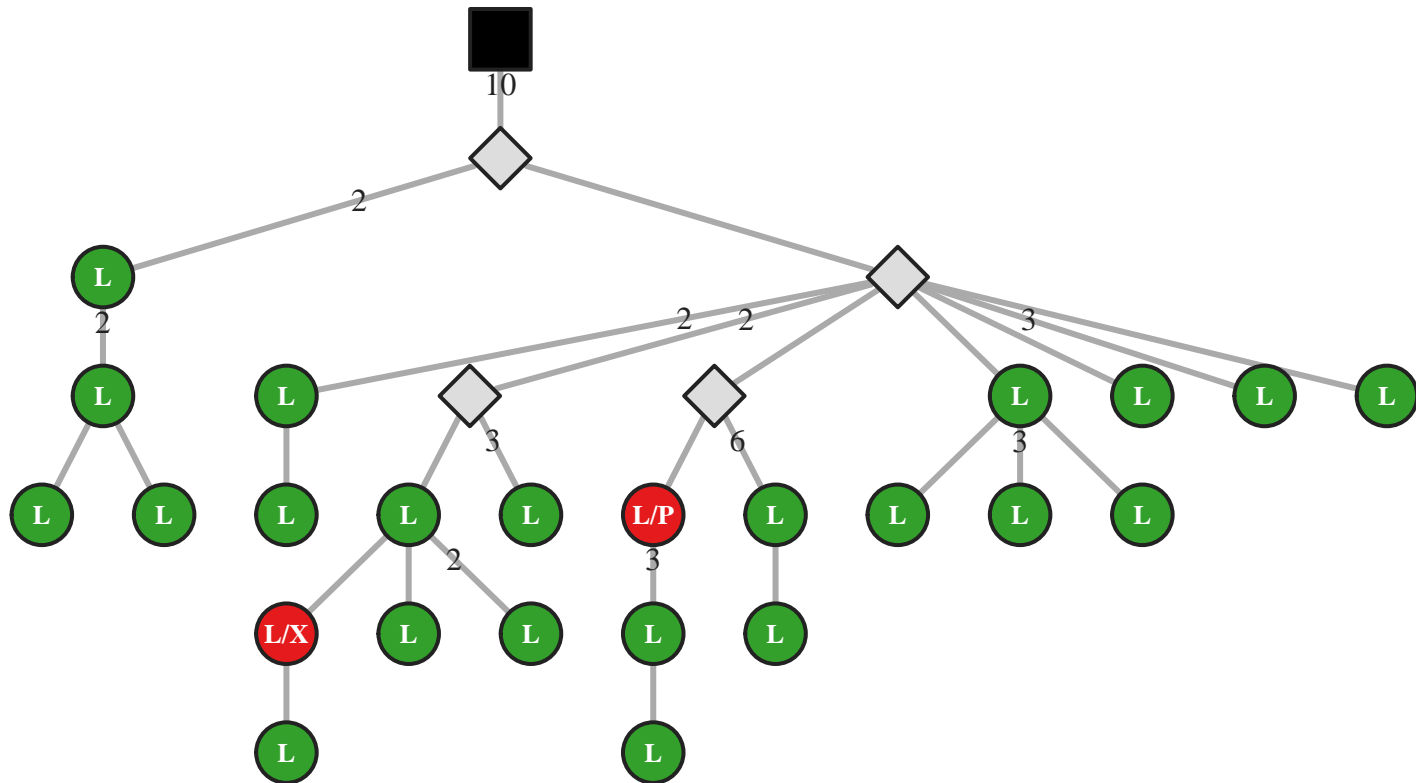

M5 IgG IGHV2-5/J5 60bp (33613)

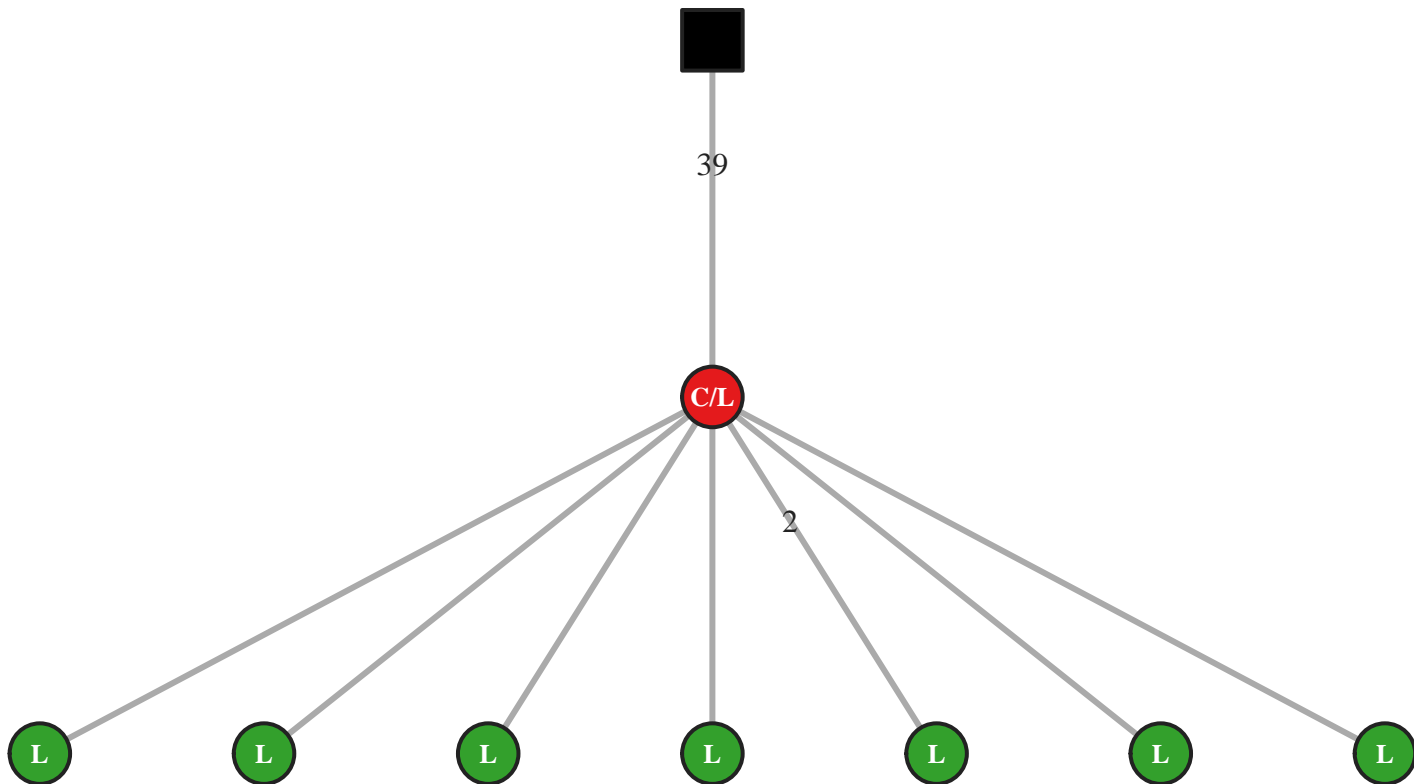

M5 IgG IGHV2-5/J5 66bp (24682)

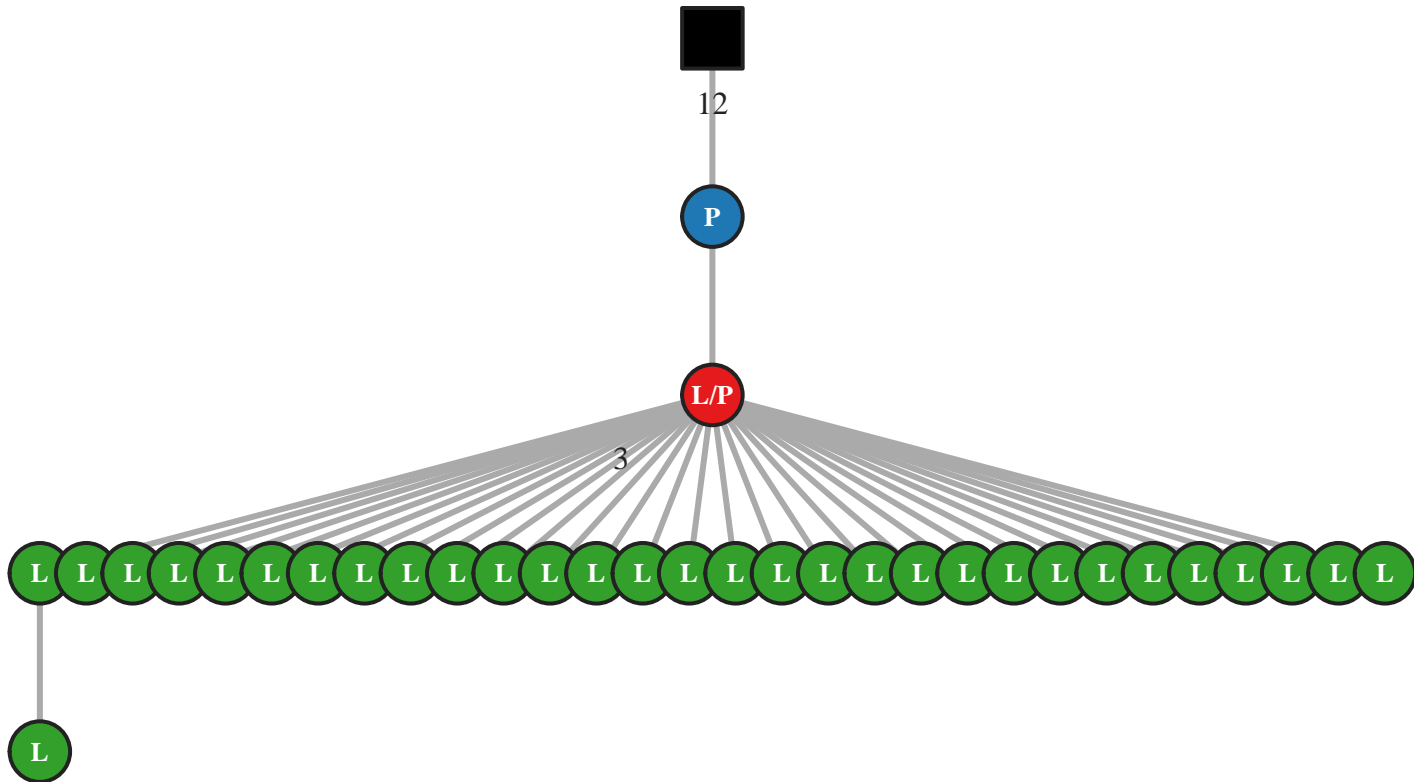

M5 IgA IGHV2-5/J5 69bp (12121)

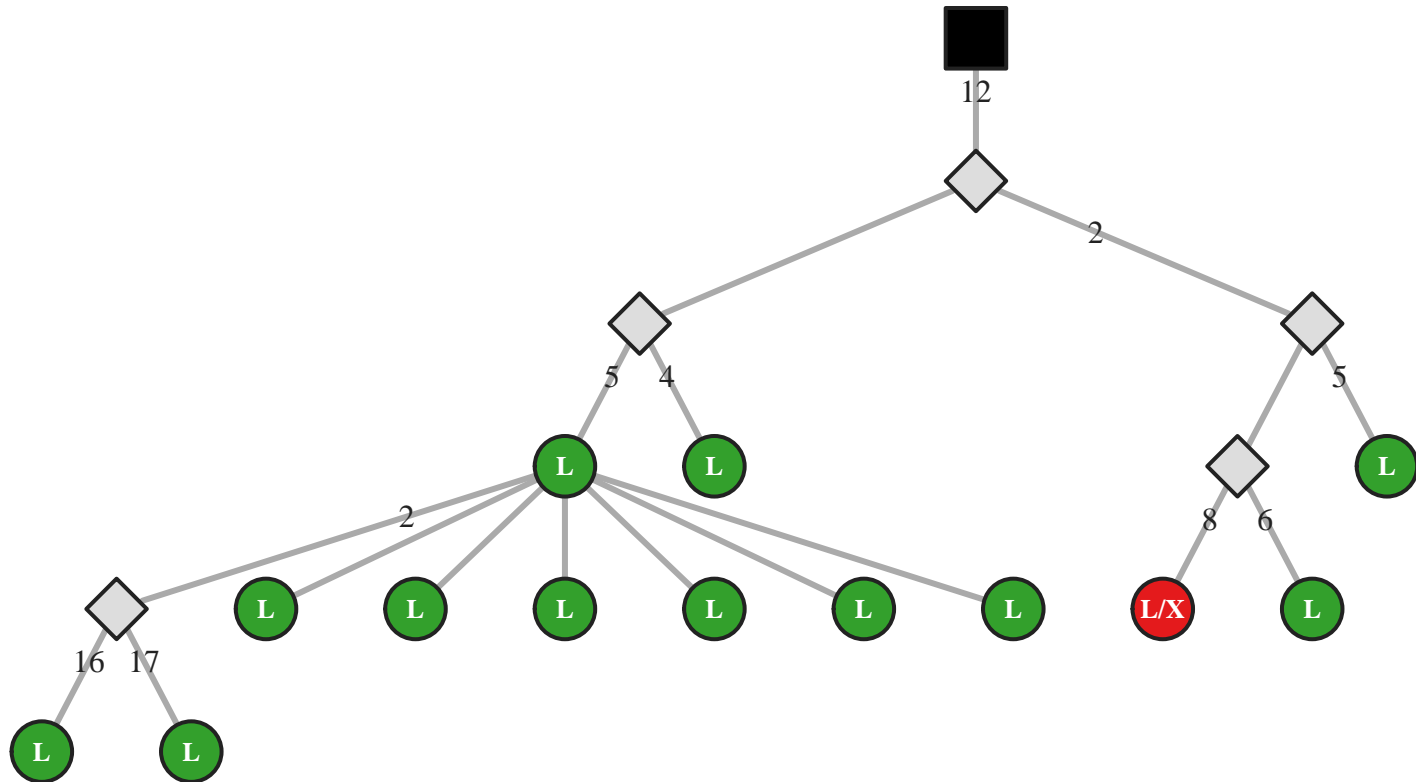

M5 IgG IGHV2-5/J6 39bp (15634)

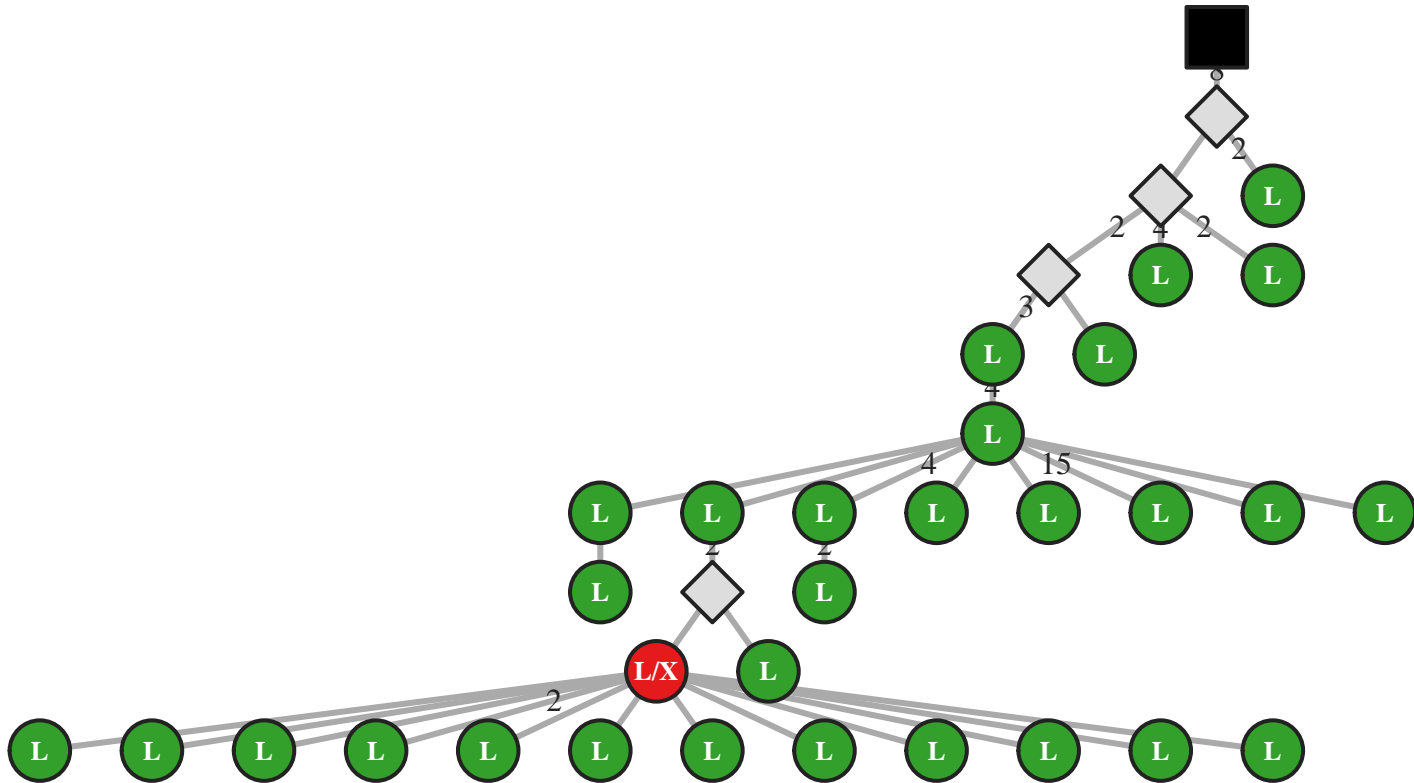

M5 IgG IGHV2-5/J6 45bp (50665)

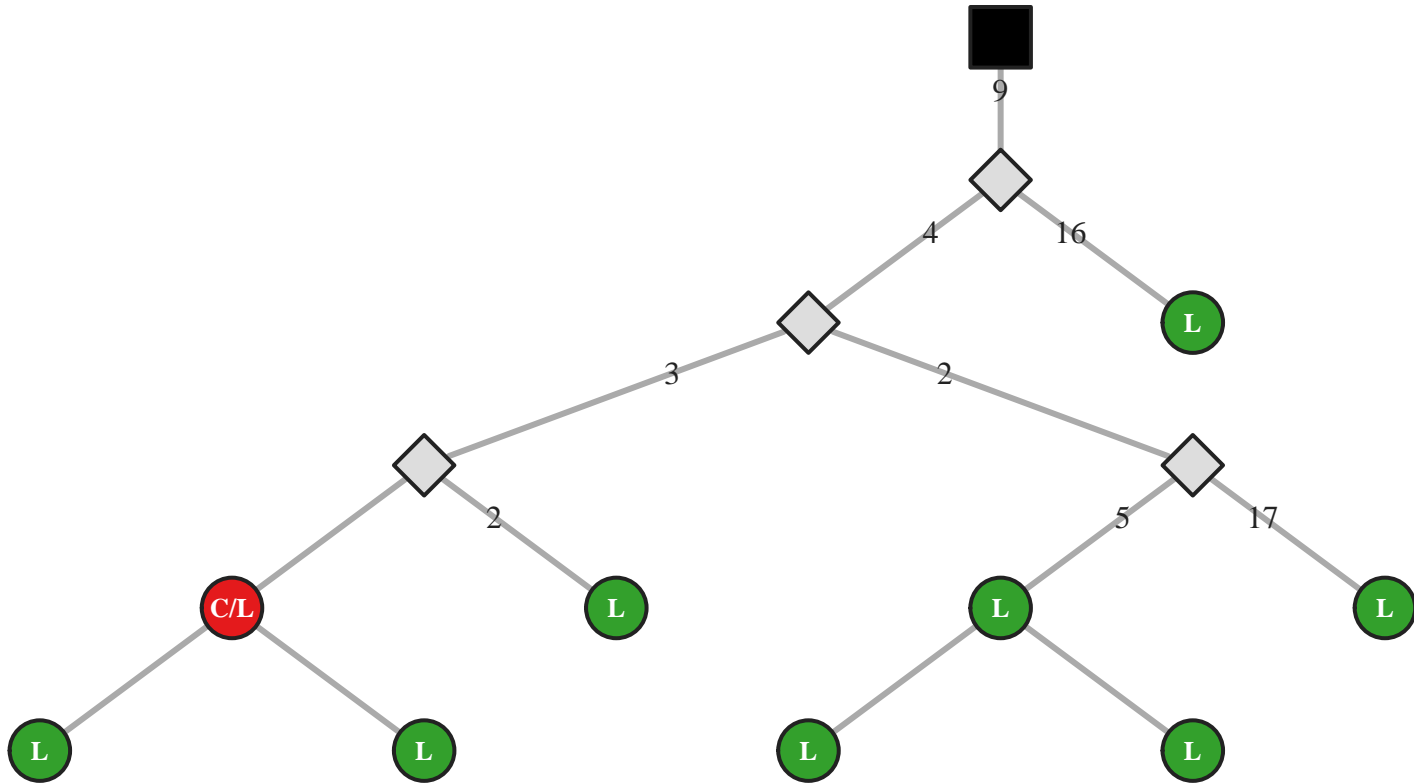

M5 IgG IGHV2-5/J6 51bp (15652)

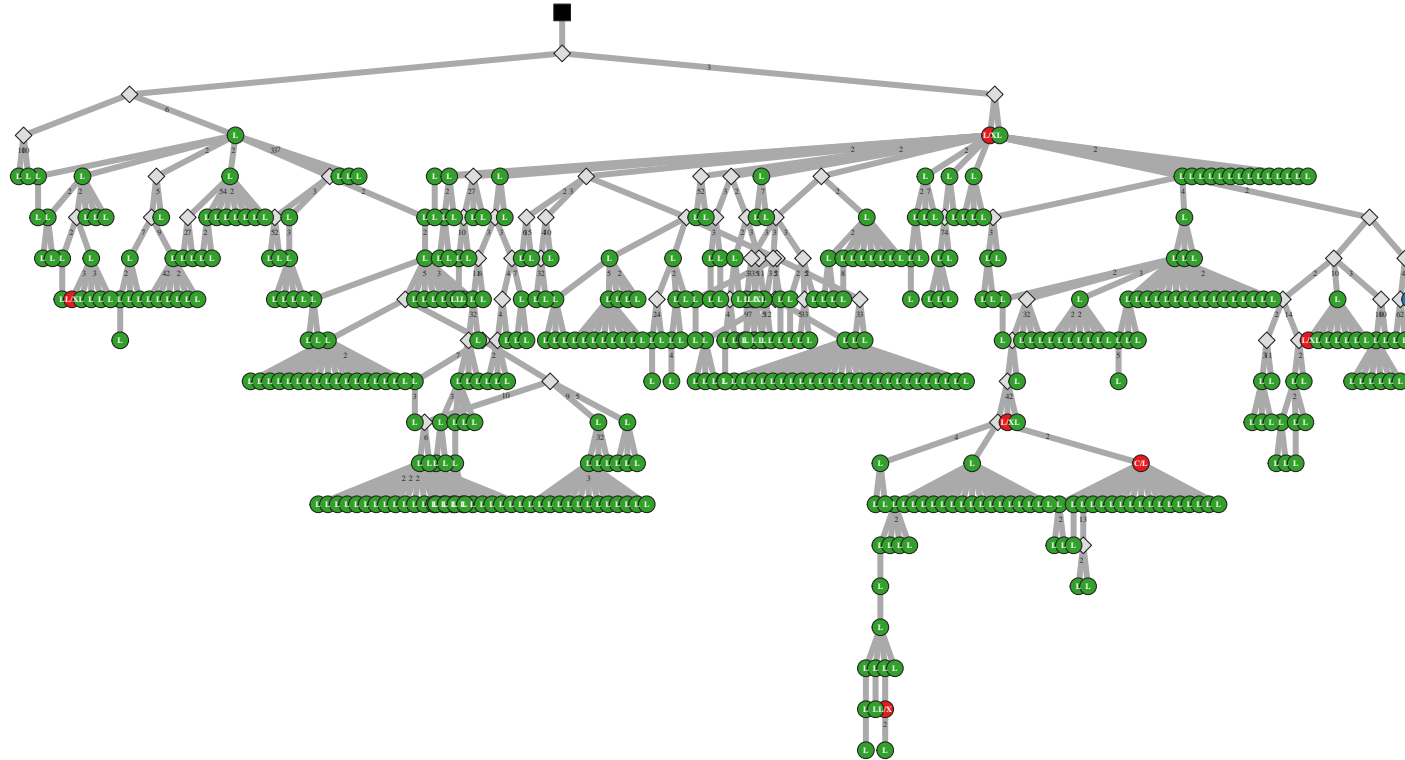

M5 IgG IGHV2-5/J6 54bp (24702)

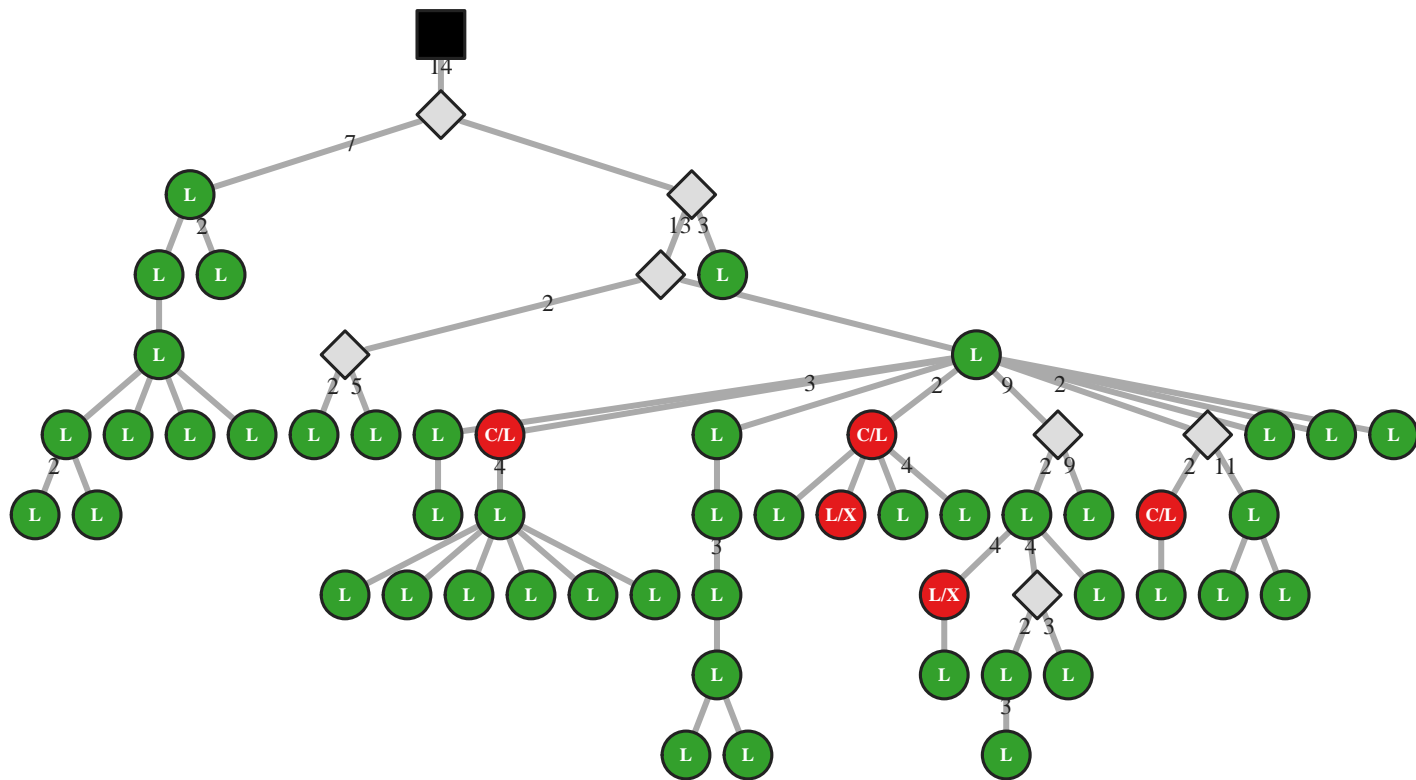

M5 IgG IGHV2-5/J6 75bp (50672)

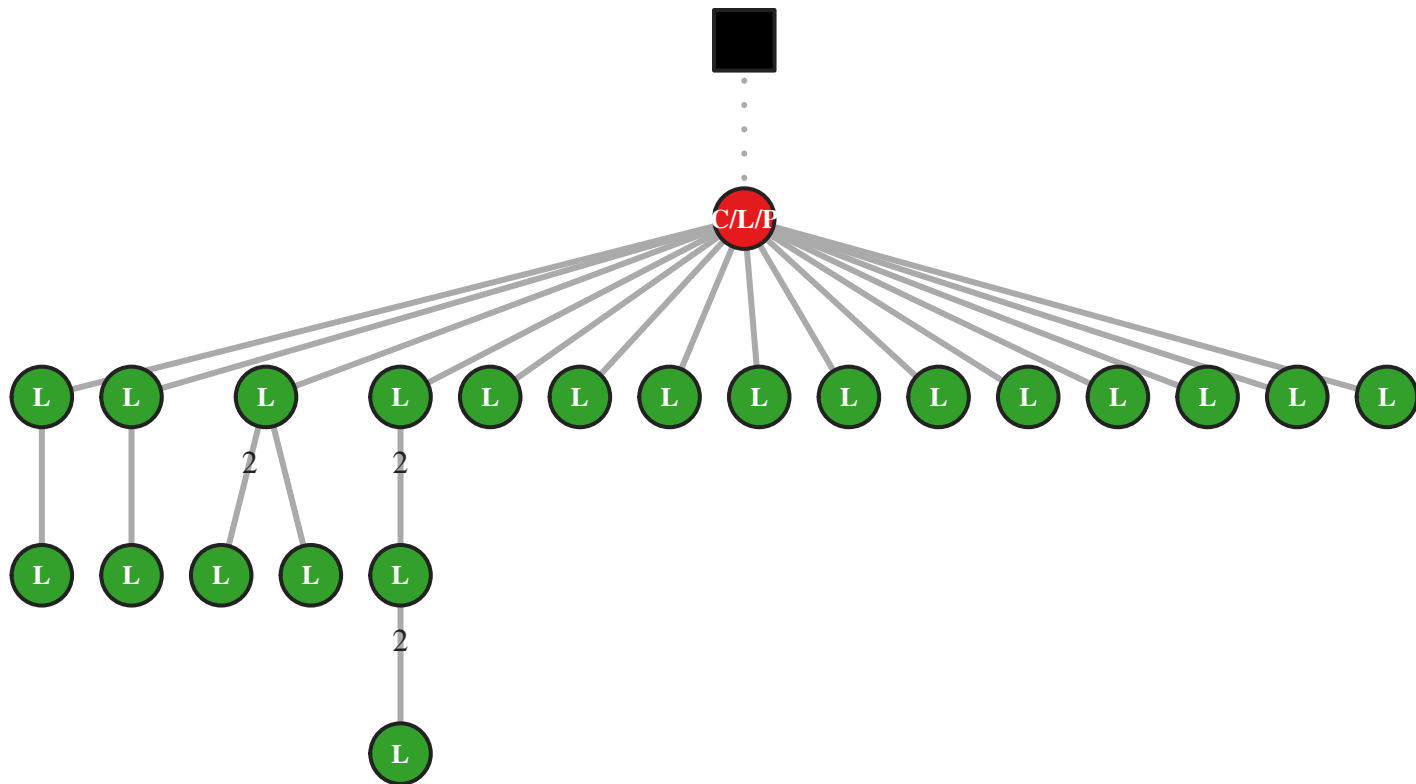

M5 IgG IGHV2-70/J3 33bp (33662)

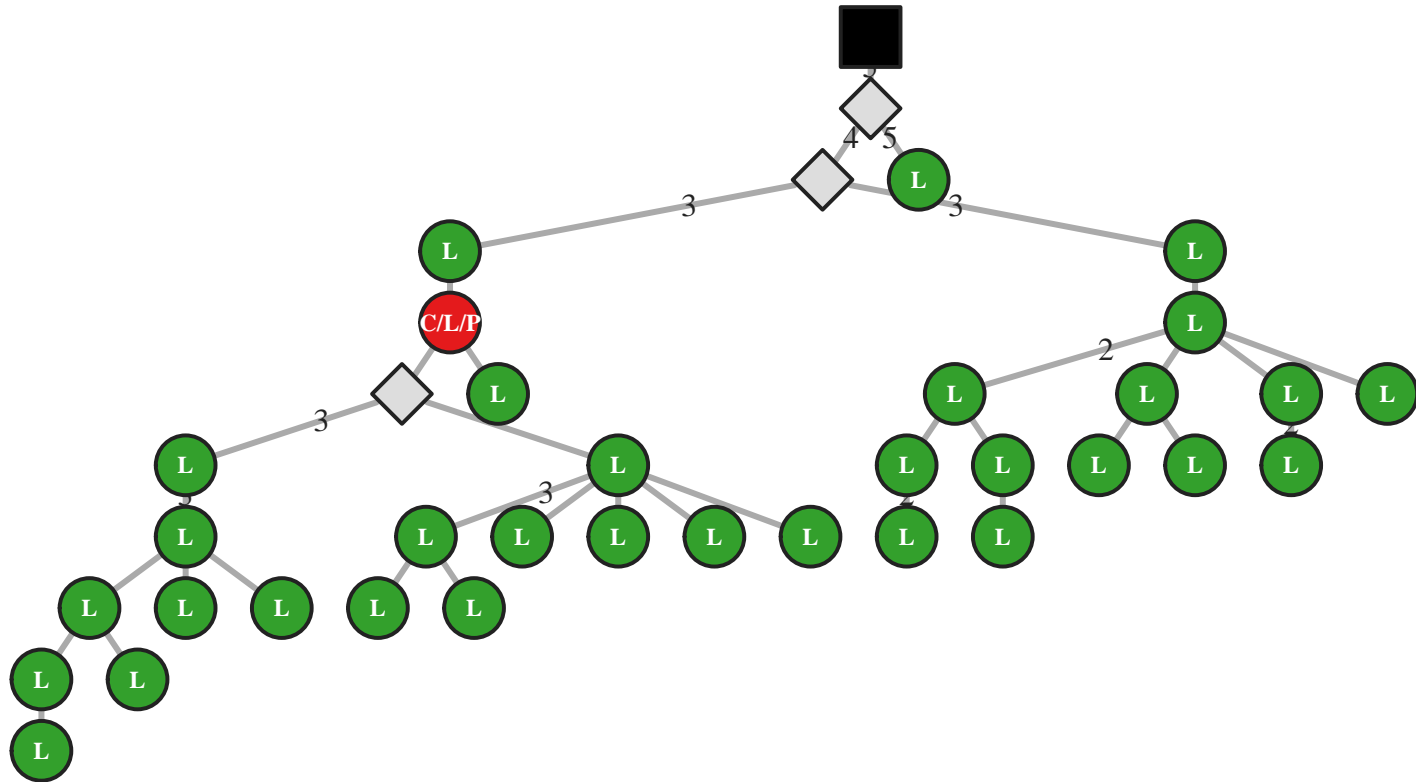

M5 IgG IGHV2-70/J3 42bp (33676)

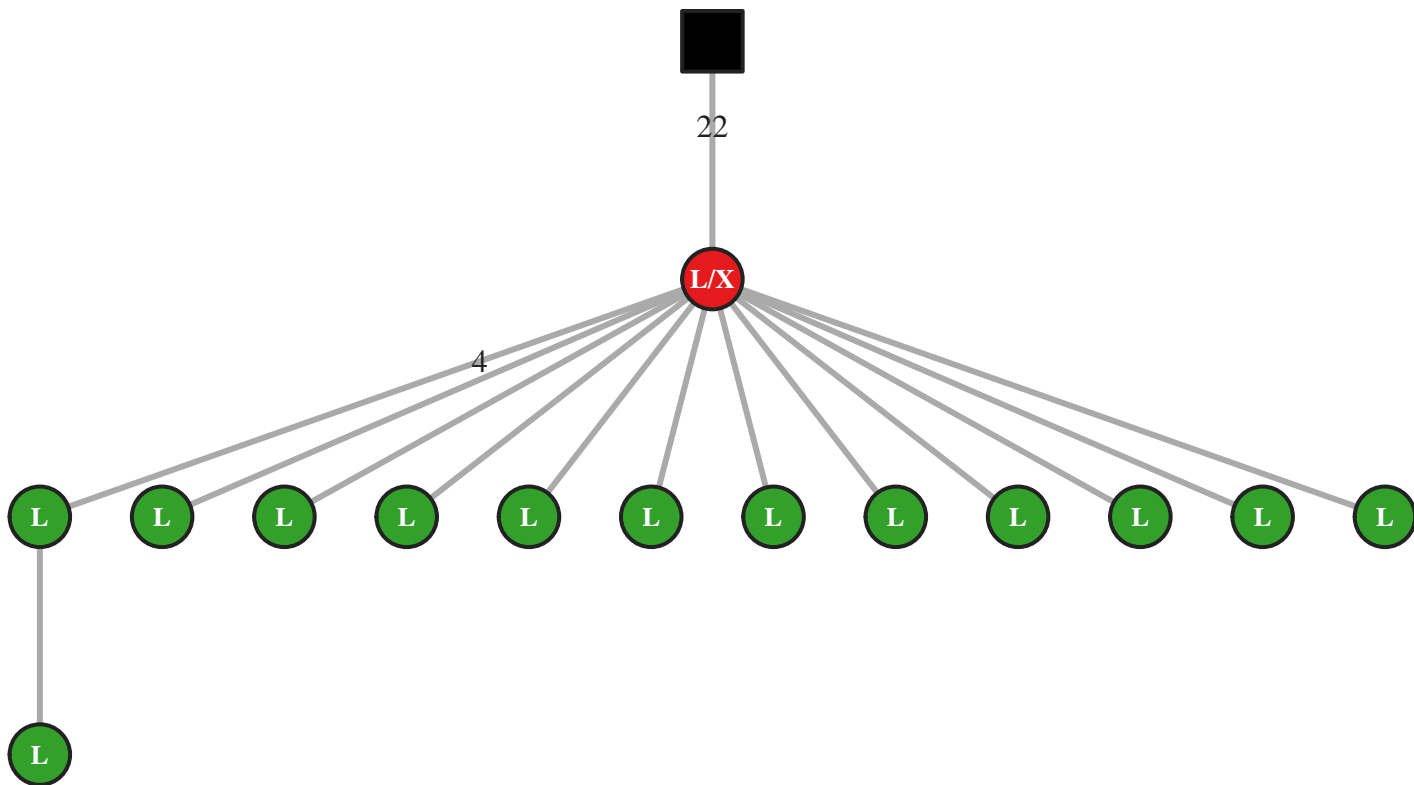

M5 IgG IGHV2-70/J3 45bp (5870)

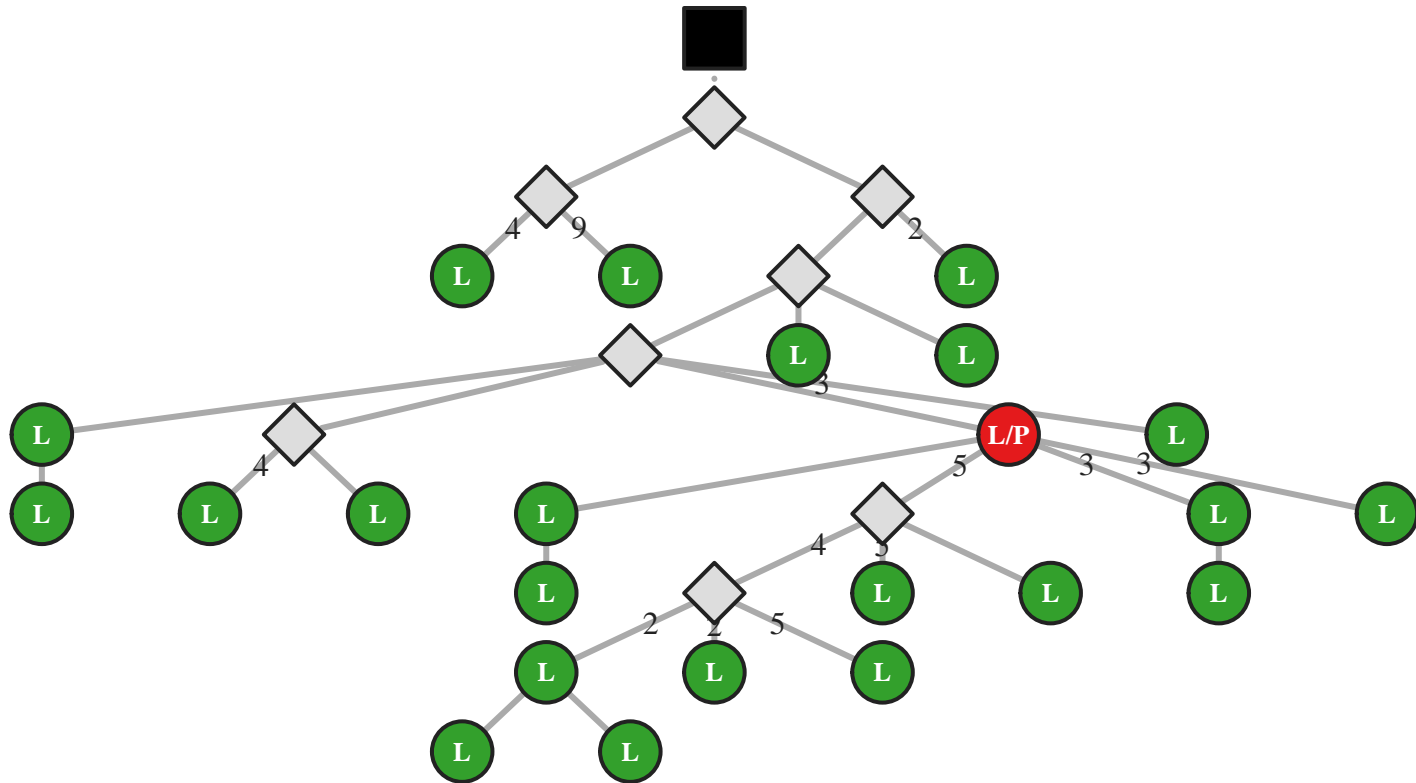

M5 IgG IGHV2-70/J3 48bp (5878)

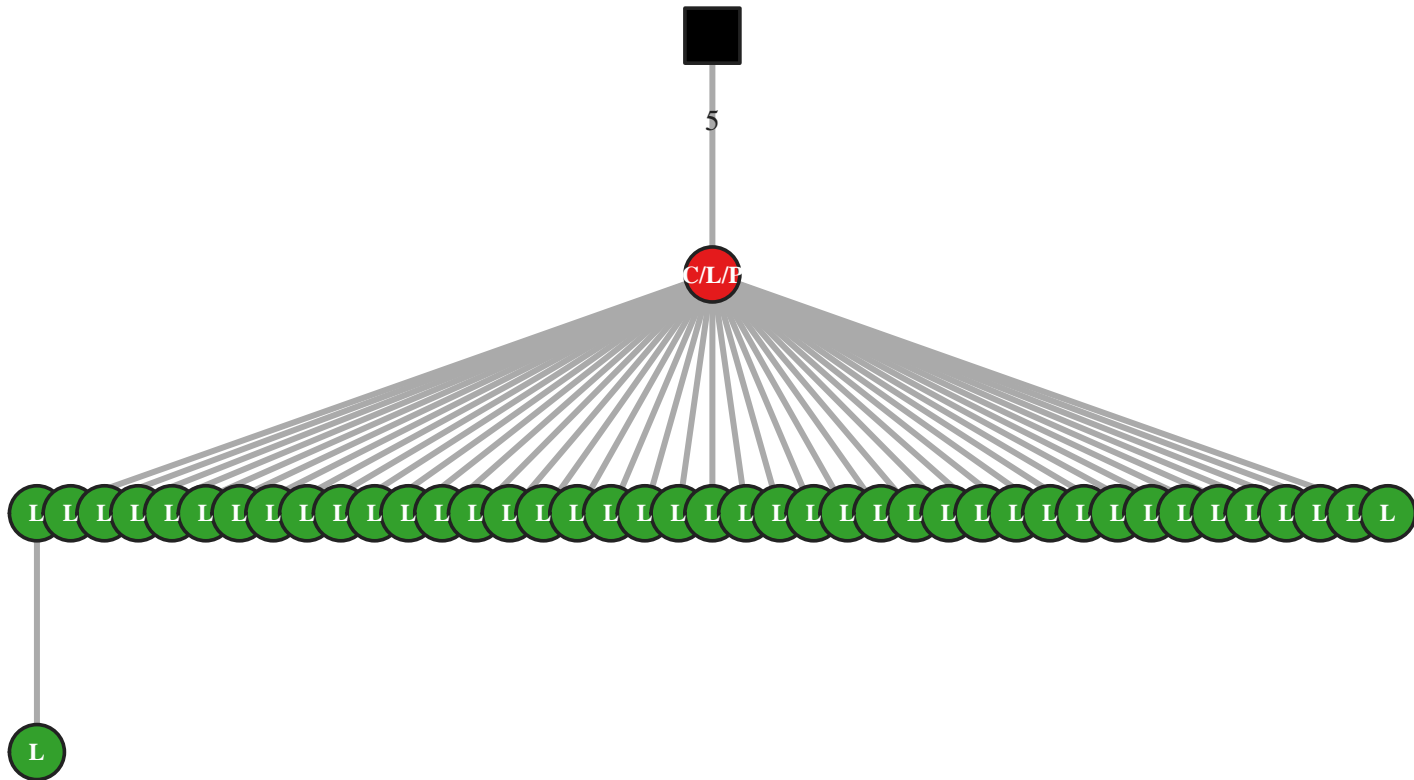

M5 IgG IGHV2-70/J3 48bp (5899)

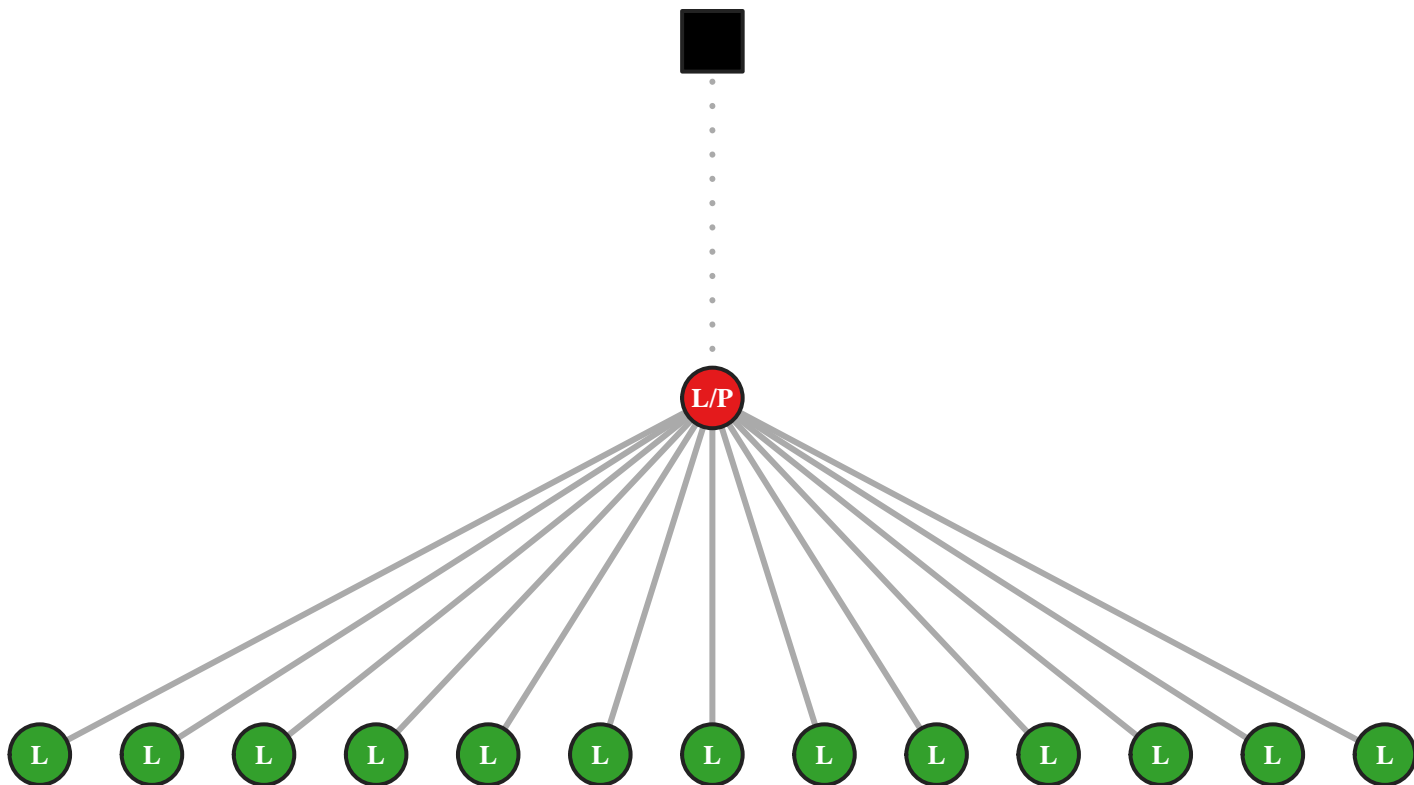

M5 IgG IGHV2-70/J3 48bp (5918)

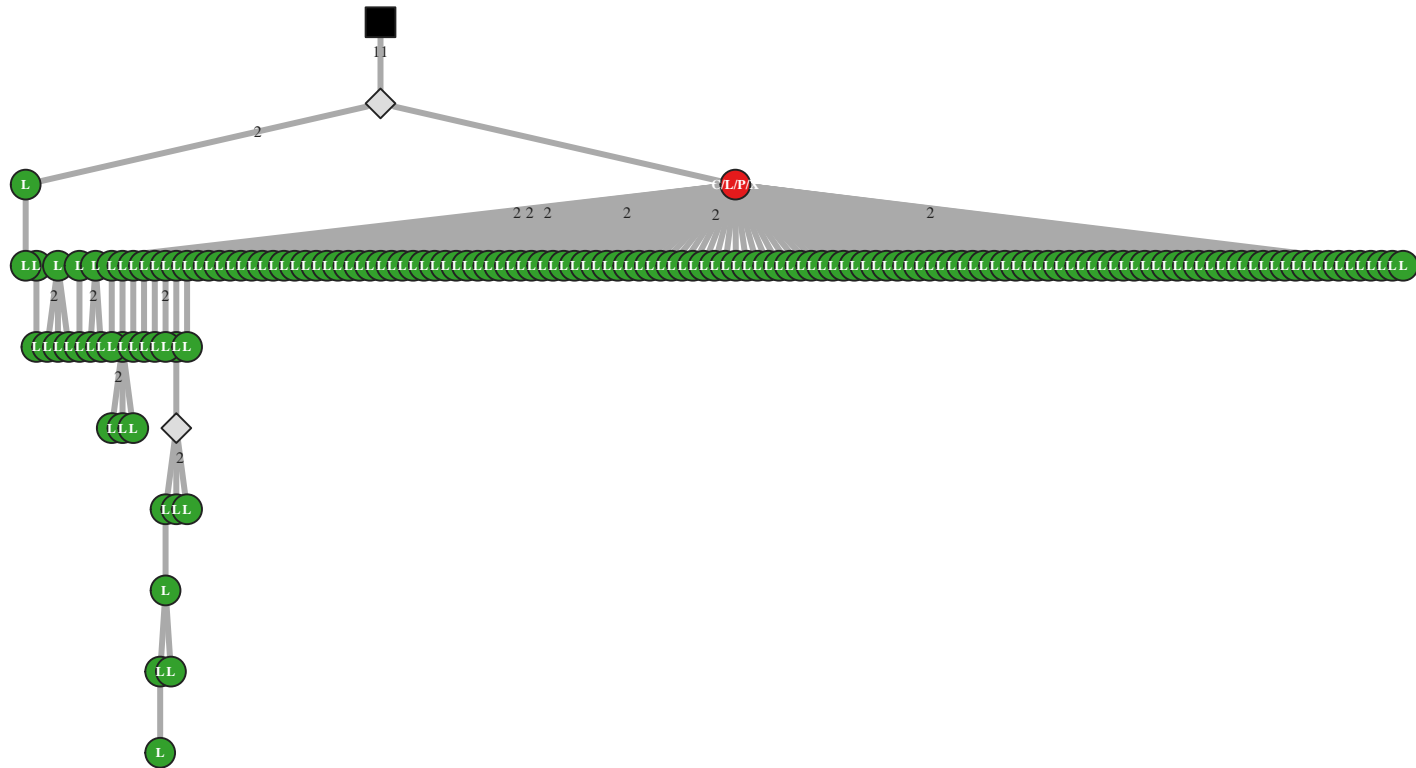

M5 IgG IGHV2-70/J3 54bp (15666)

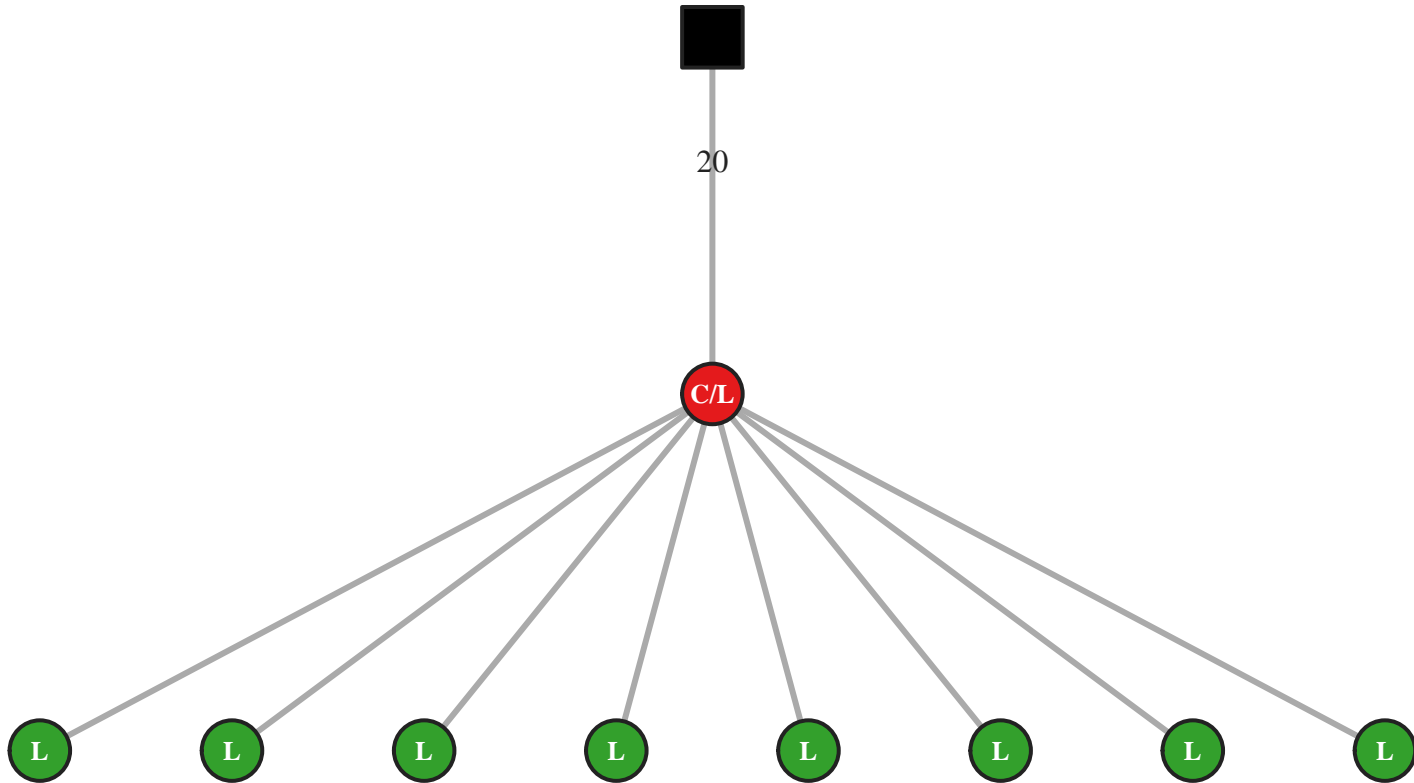

M5 IgG IGHV2-70/J3 57bp (5926)

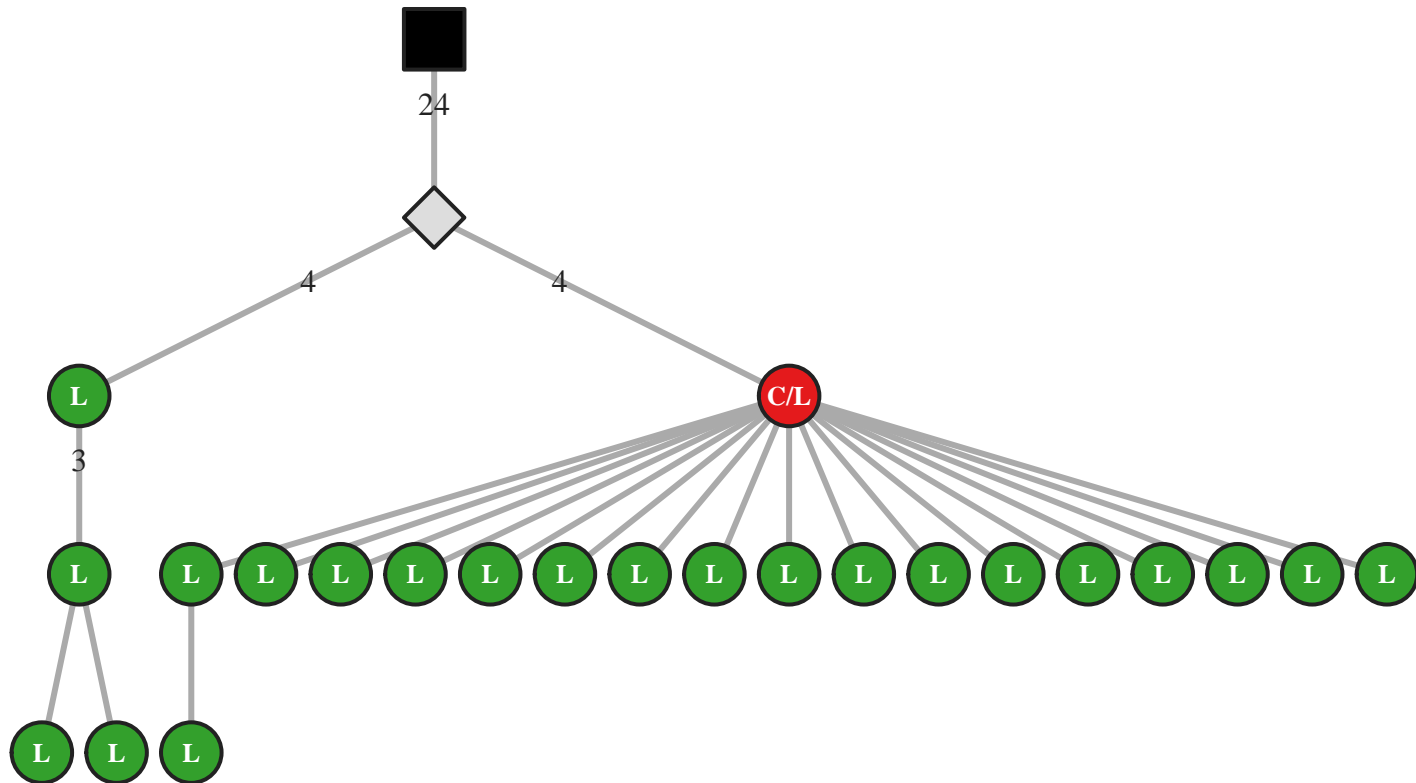

M5 IgG IGHV2-70/J3 60bp (24755)

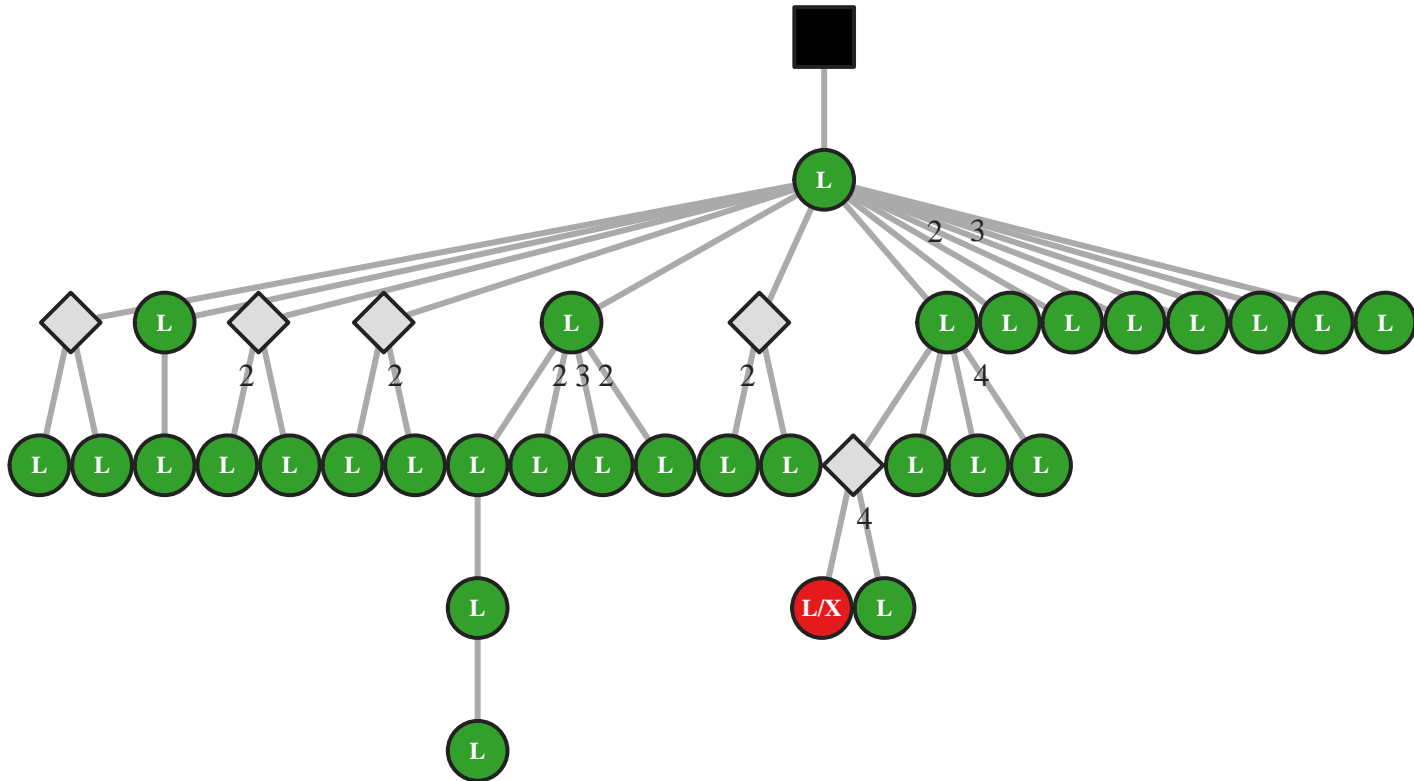

M5 IgG IGHV2-70/J3 60bp (24759)

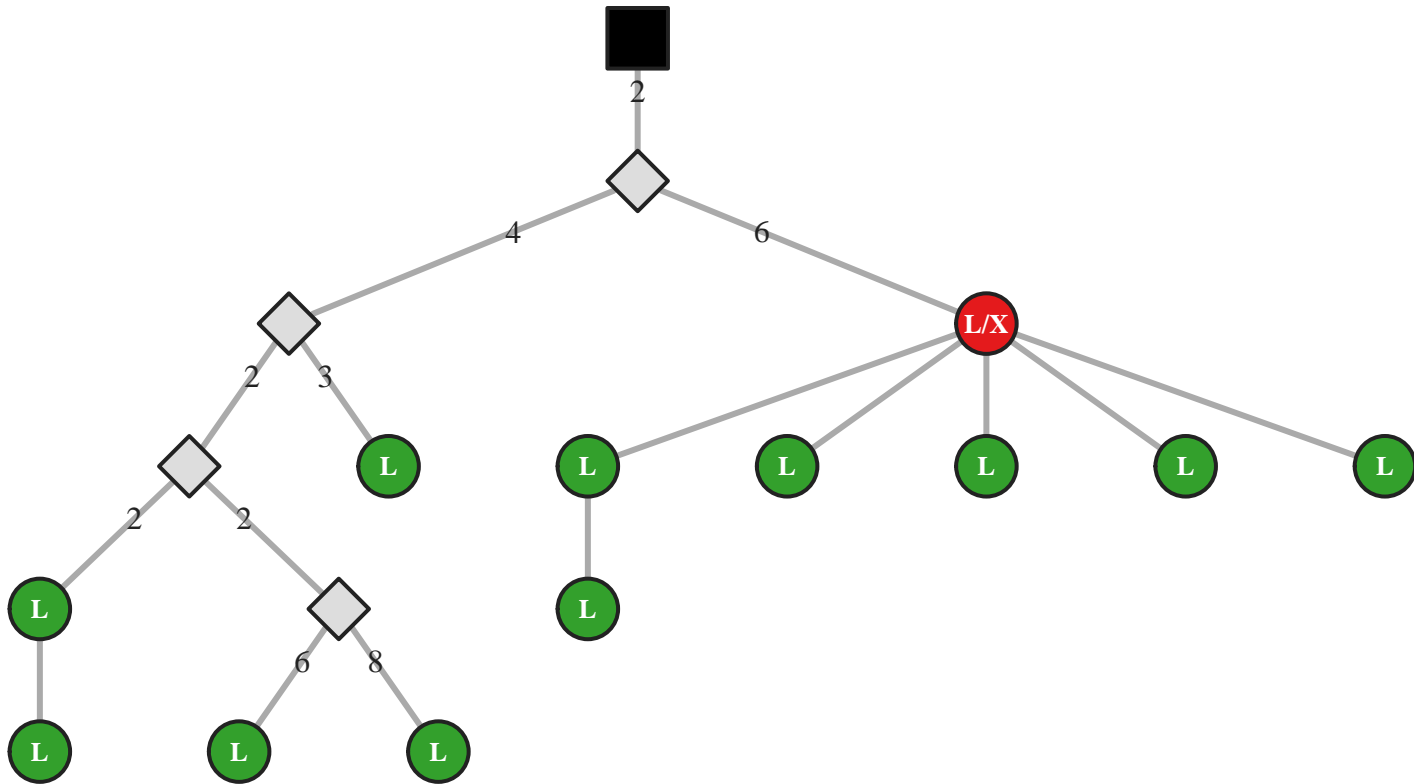

M5 IgG IGHV2-70/J3 63bp (42928)

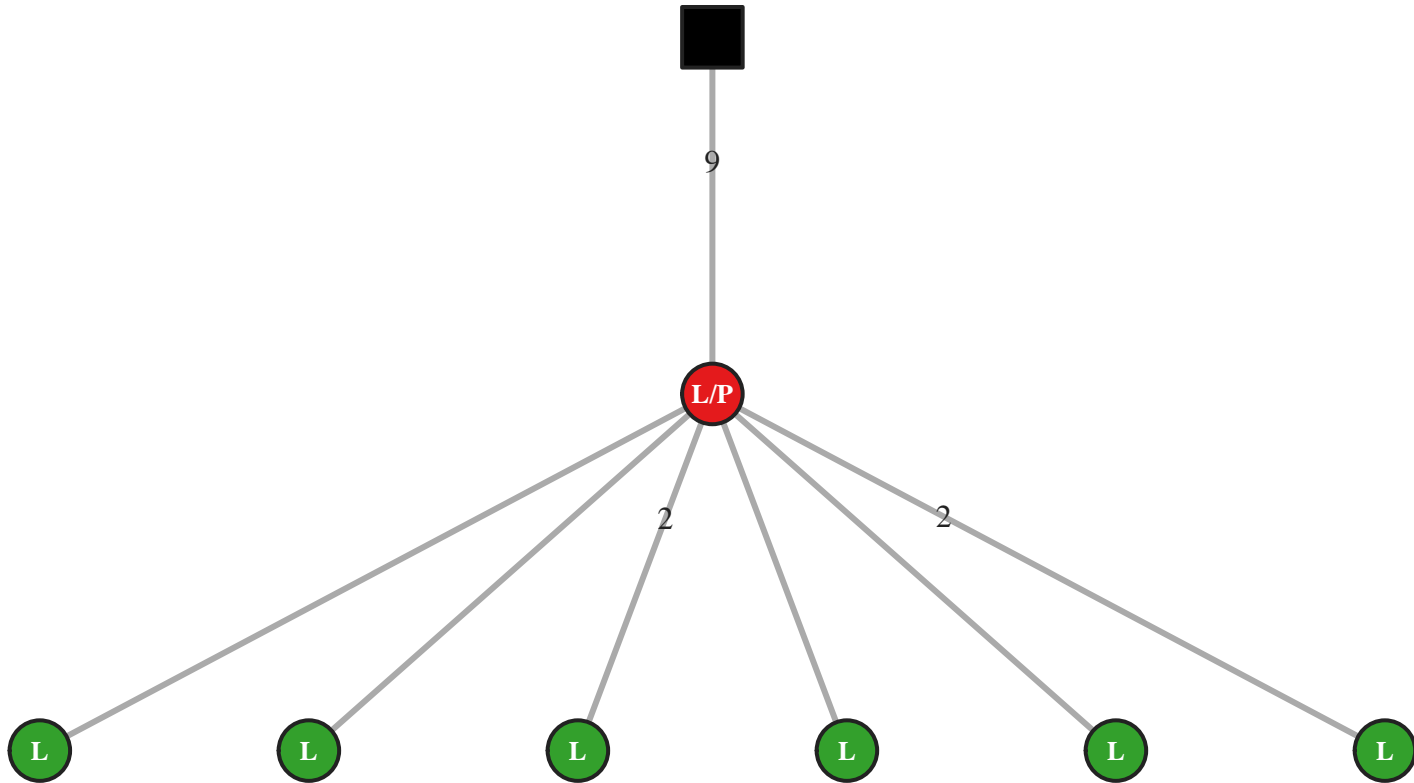

M5 IgG IGHV2-70/J4 39bp (50713)

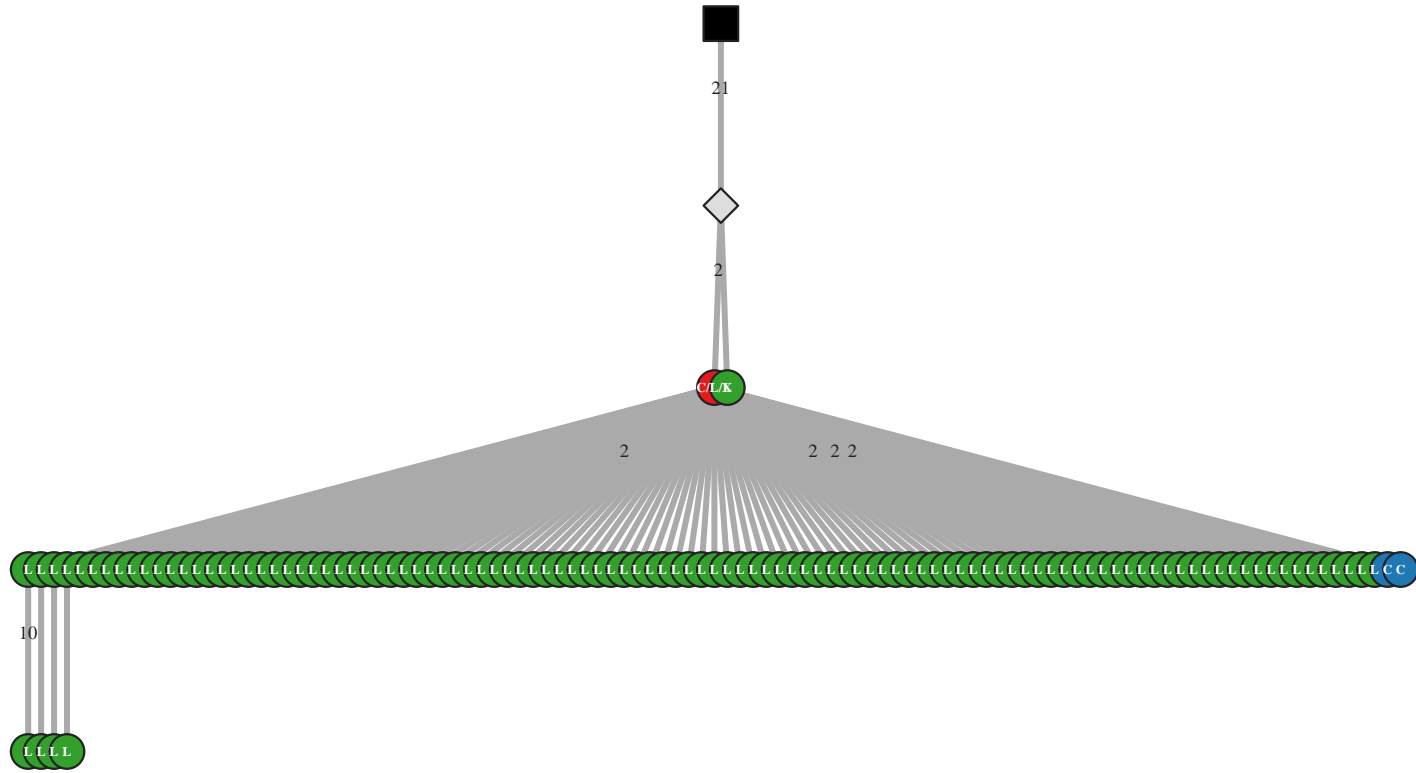

M5 IgG IGHV2-70/J4 39bp (50716)

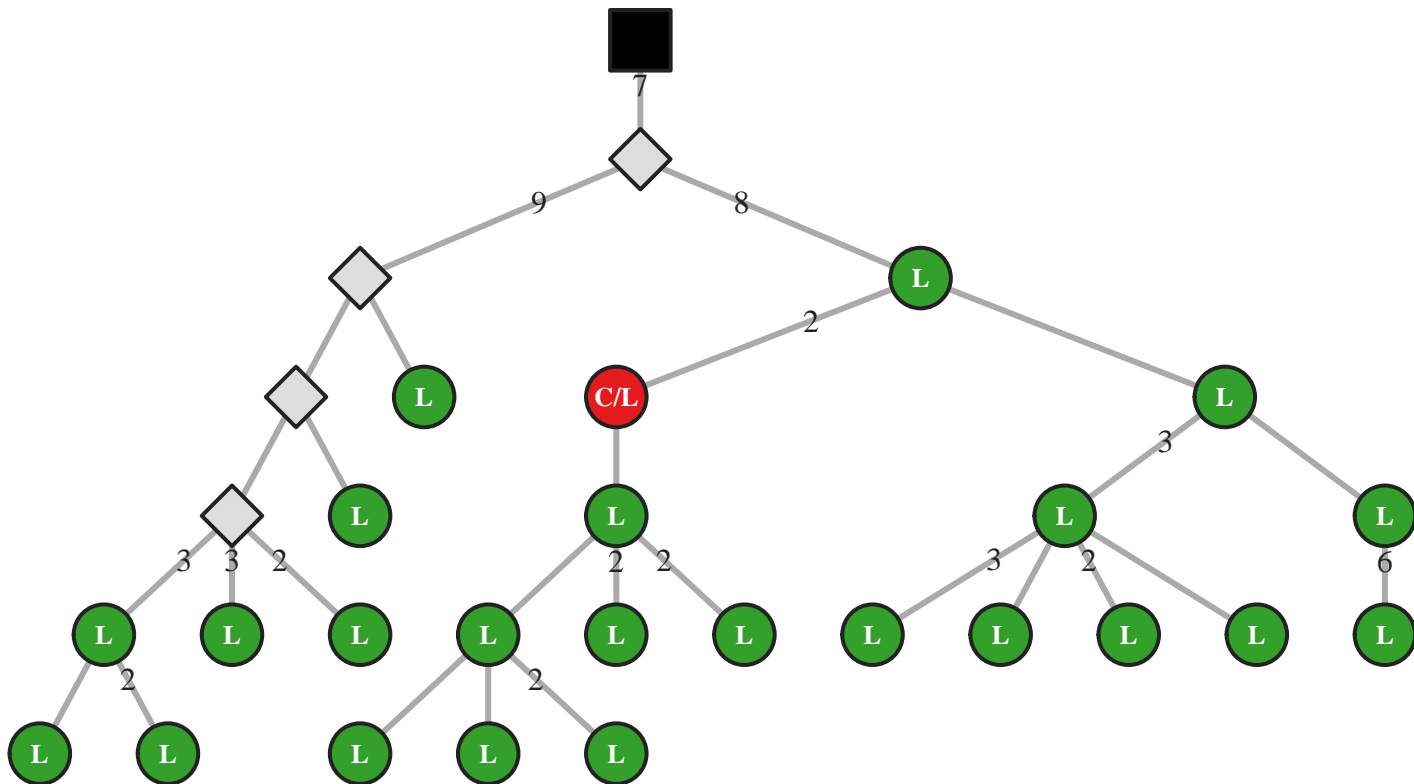

M5 IgG IGHV2-70/J4 42bp (33732)

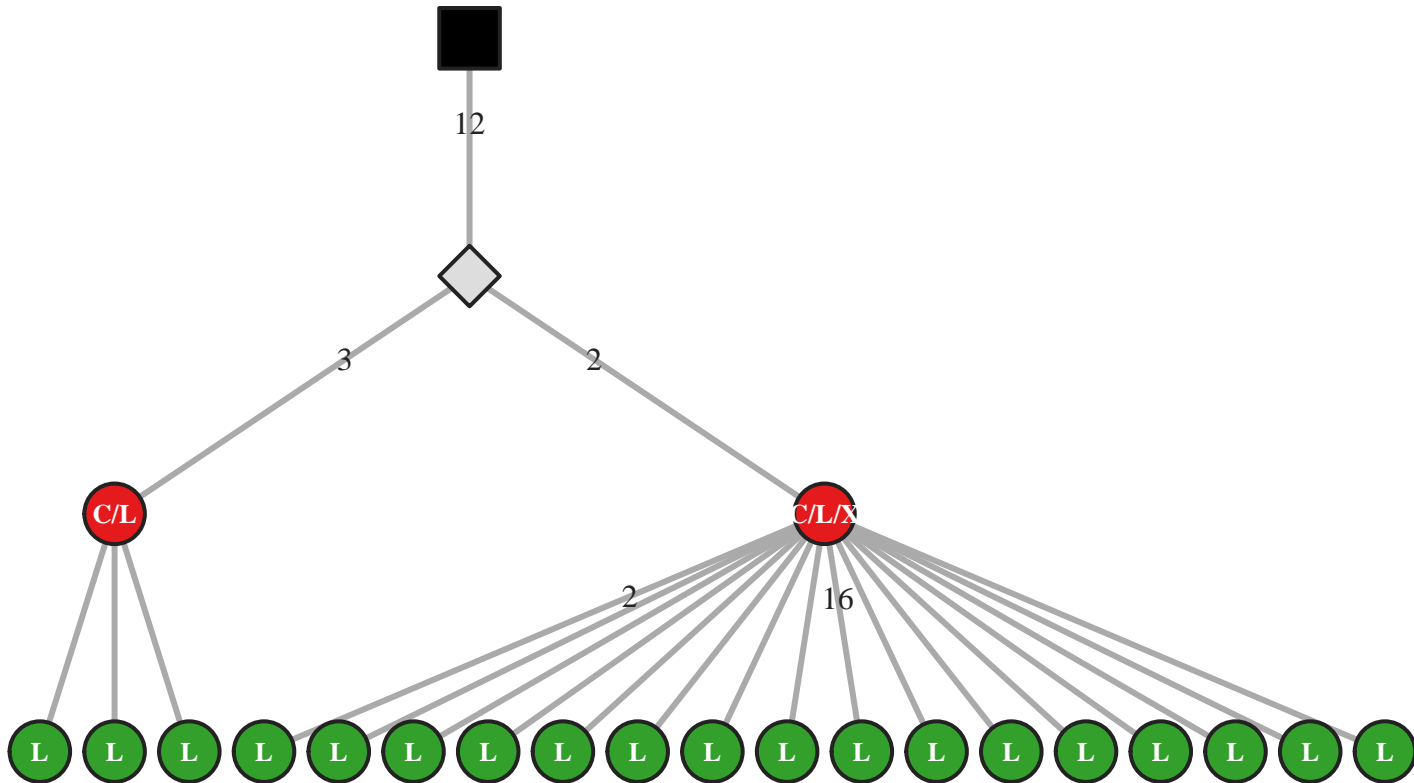

M5 IgG IGHV2-70/J4 42bp (33764)

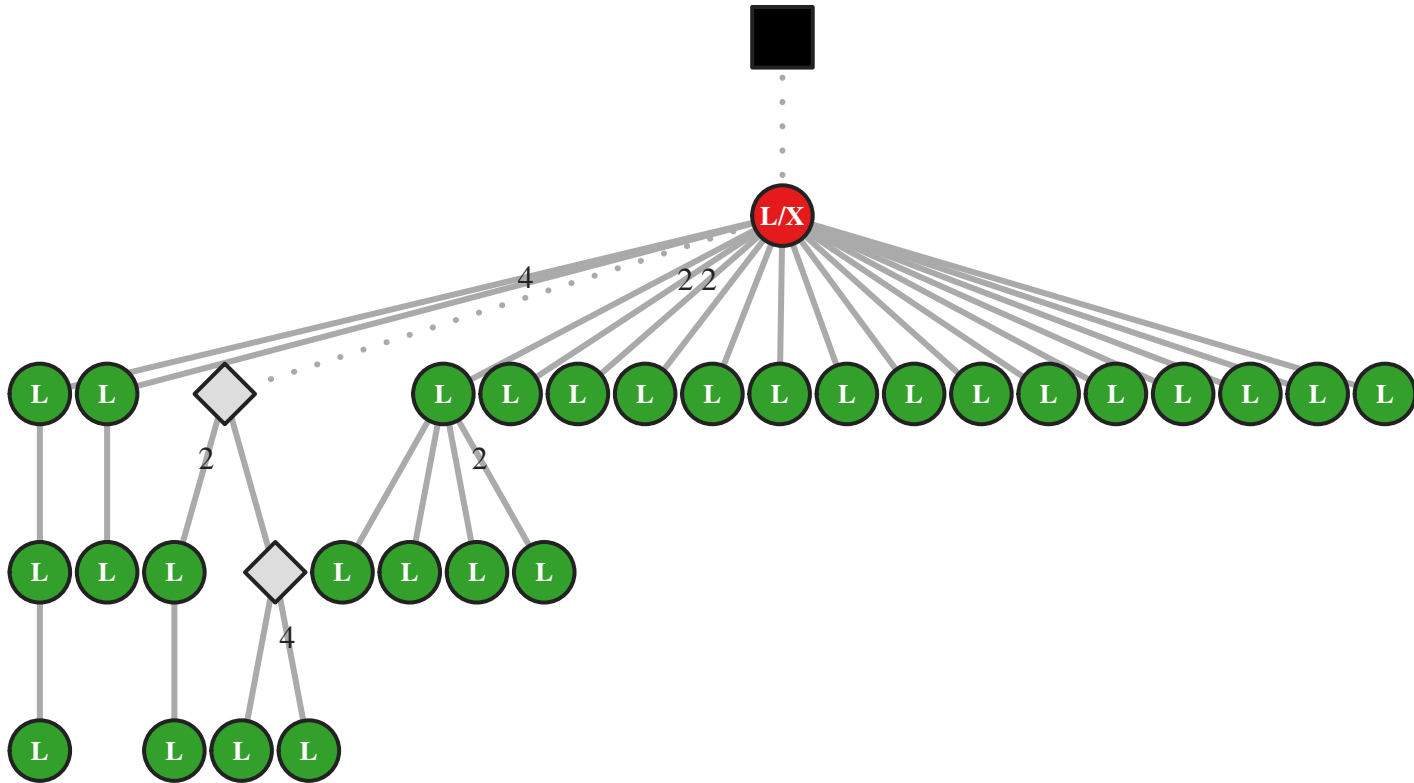

M5 IgA IGHV2-70/J4 45bp (30367)

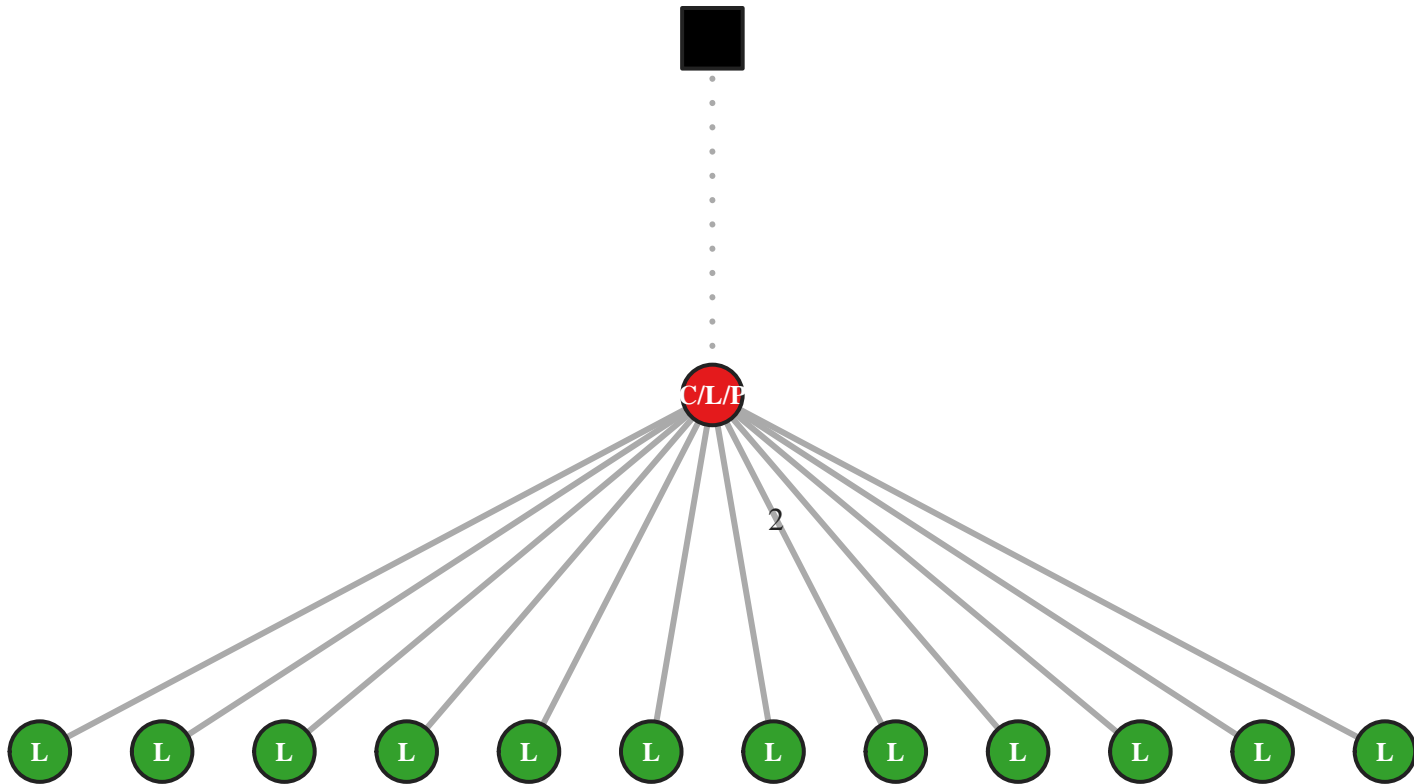

M5 IgG IGHV2-70/J4 45bp (5985)

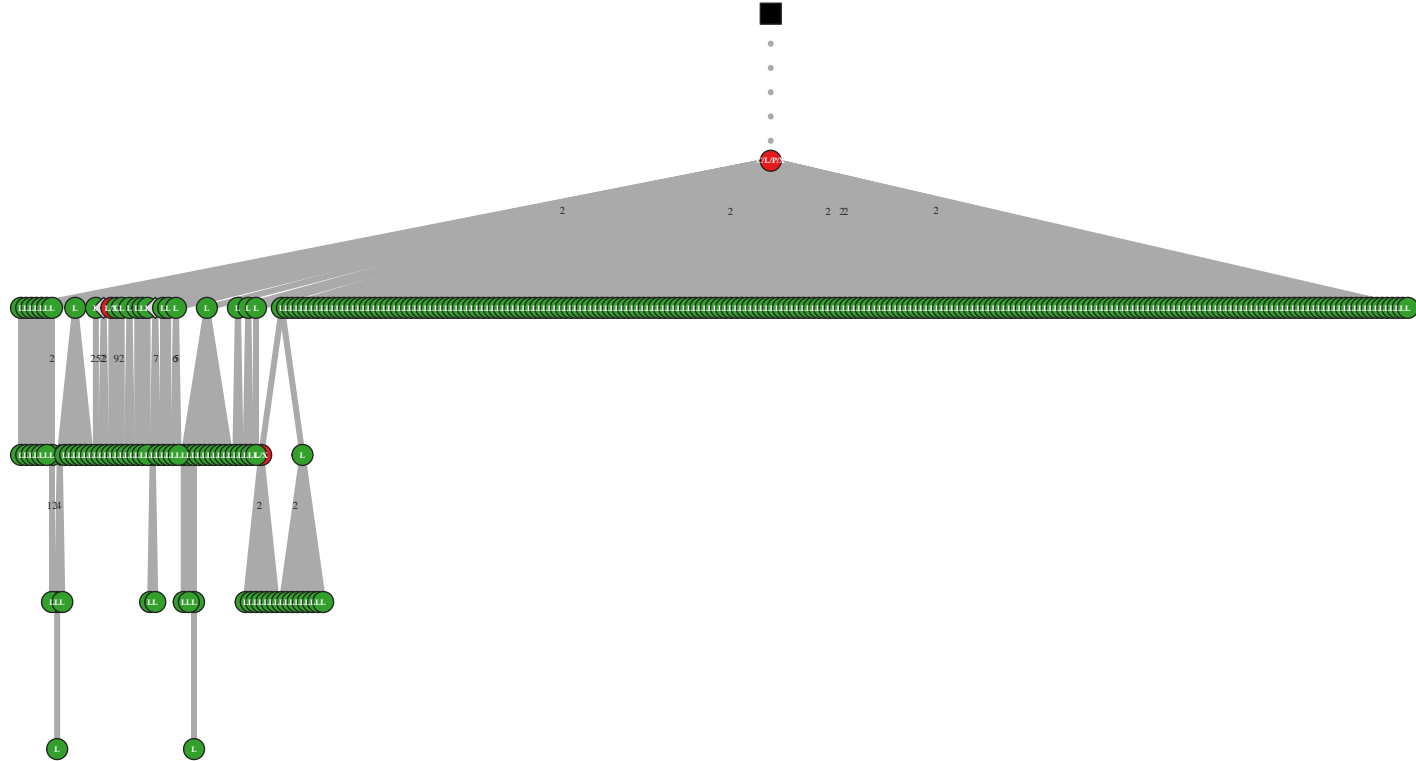

M5 IgG IGHV2-70/J4 45bp (6000)

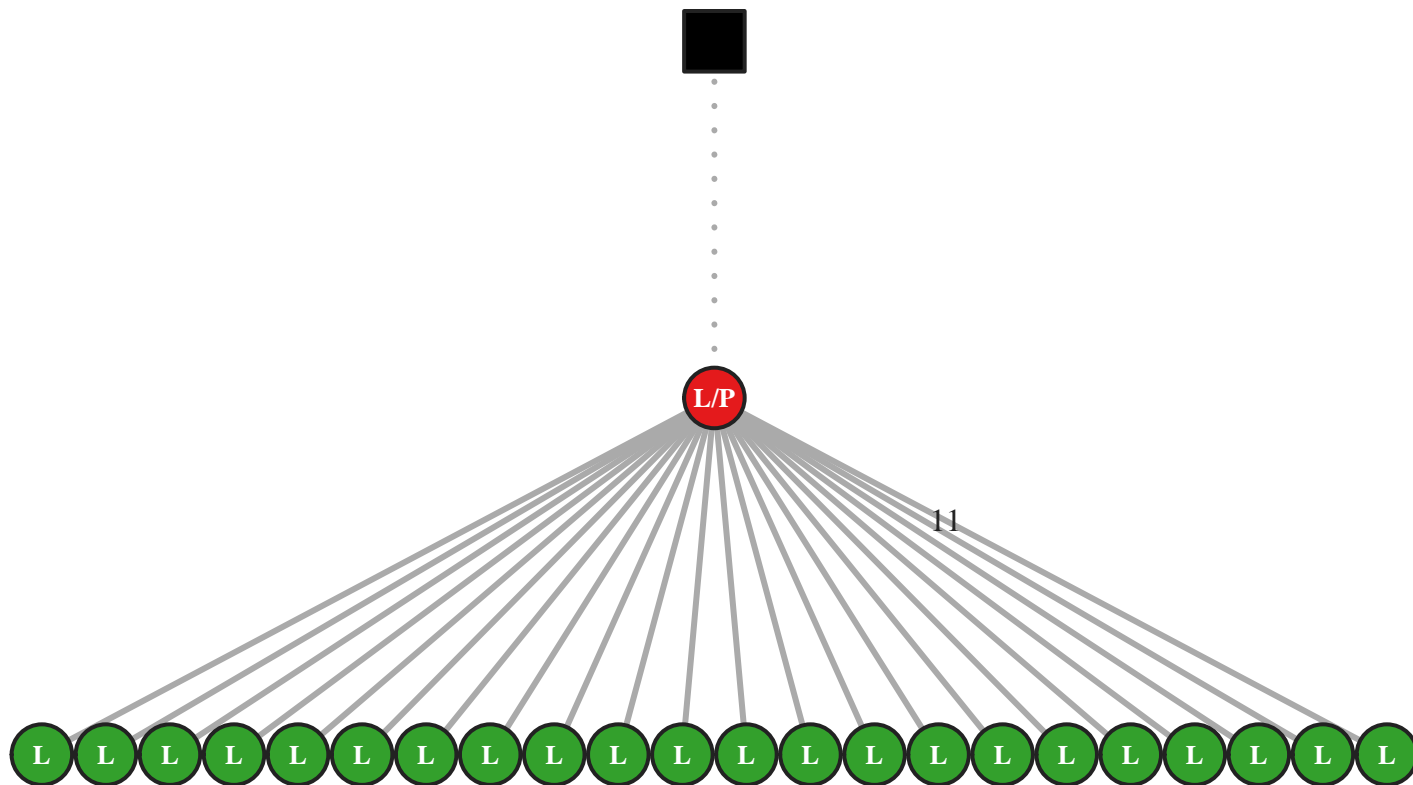

M5 IgG IGHV2-70/J4 45bp (6006)

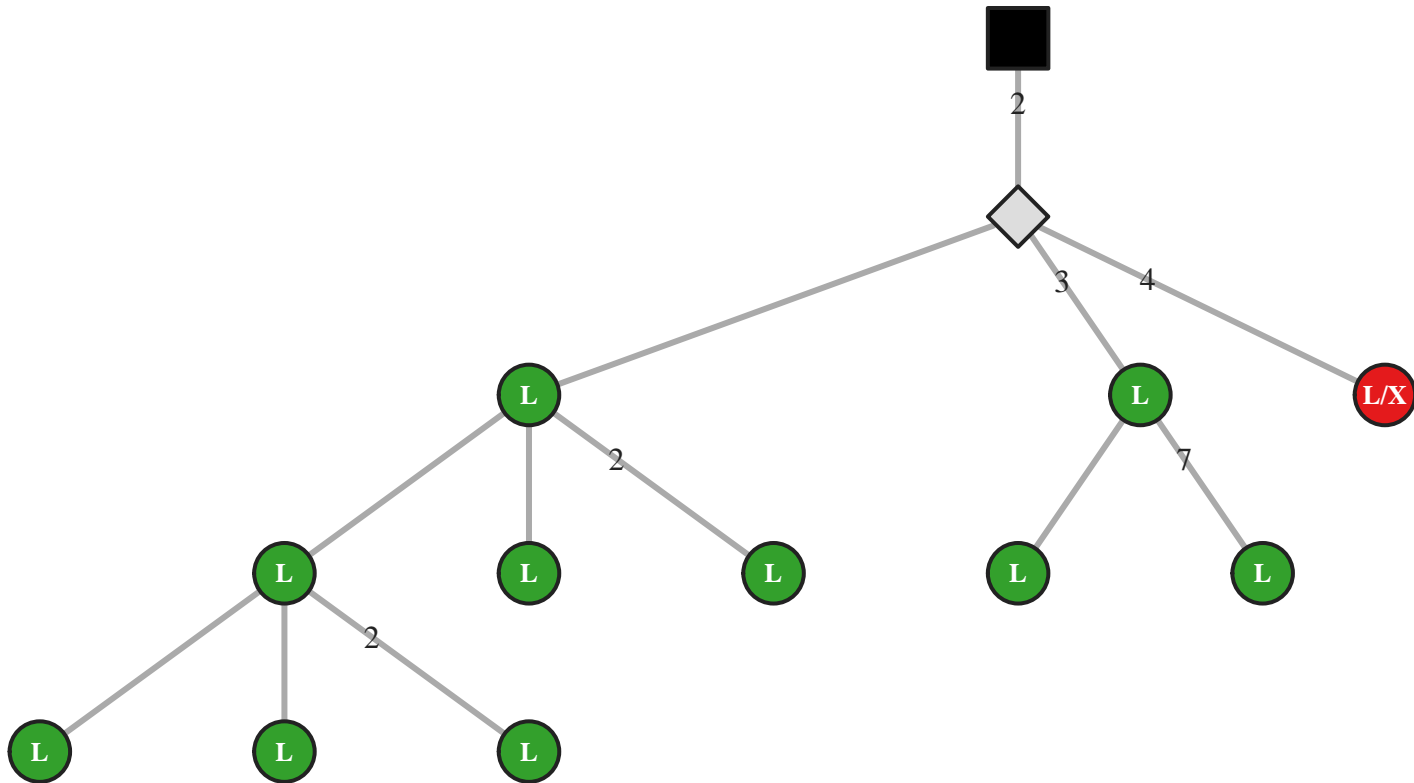

M5 IgG IGHV2-70/J4 45bp (6057)

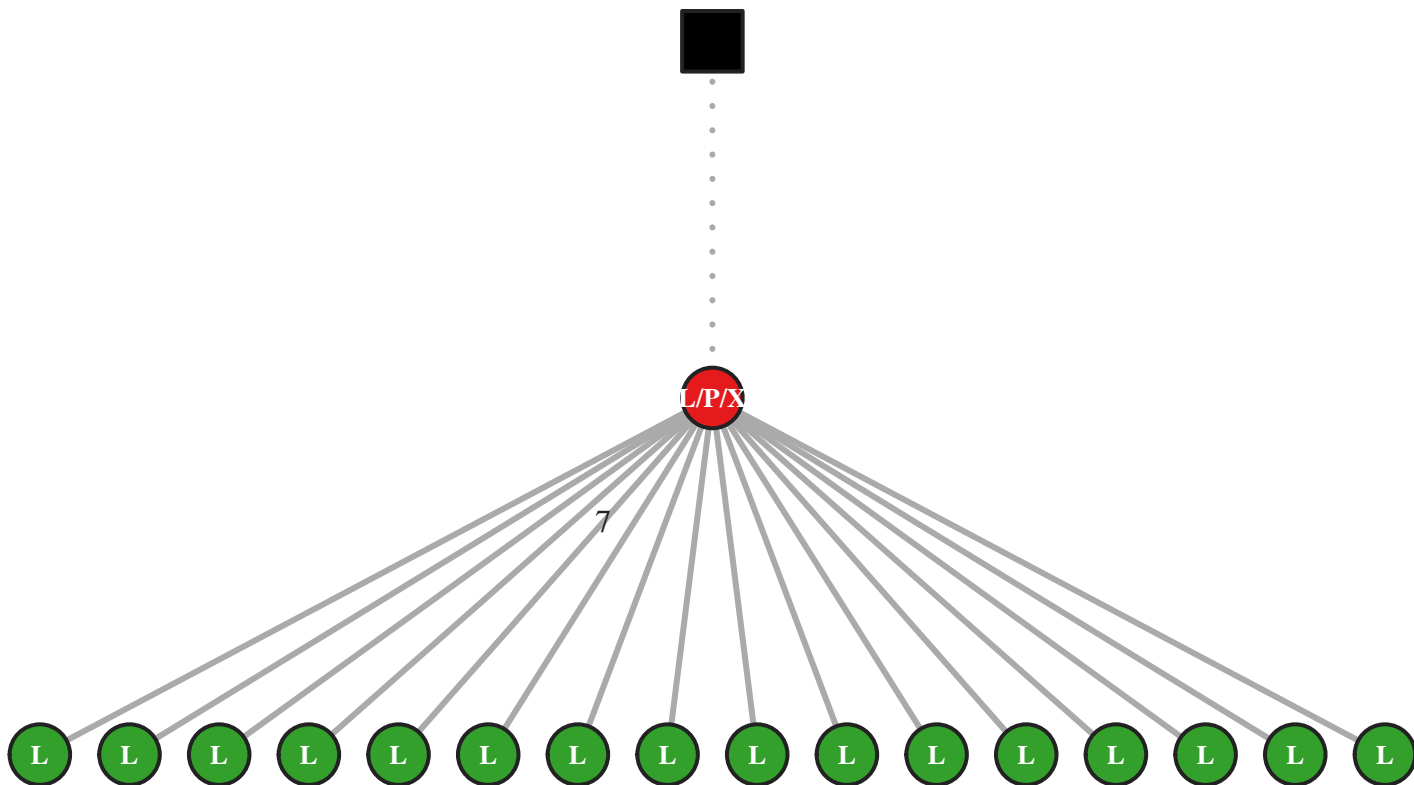

M5 IgG IGHV2-70/J4 48bp (15687)

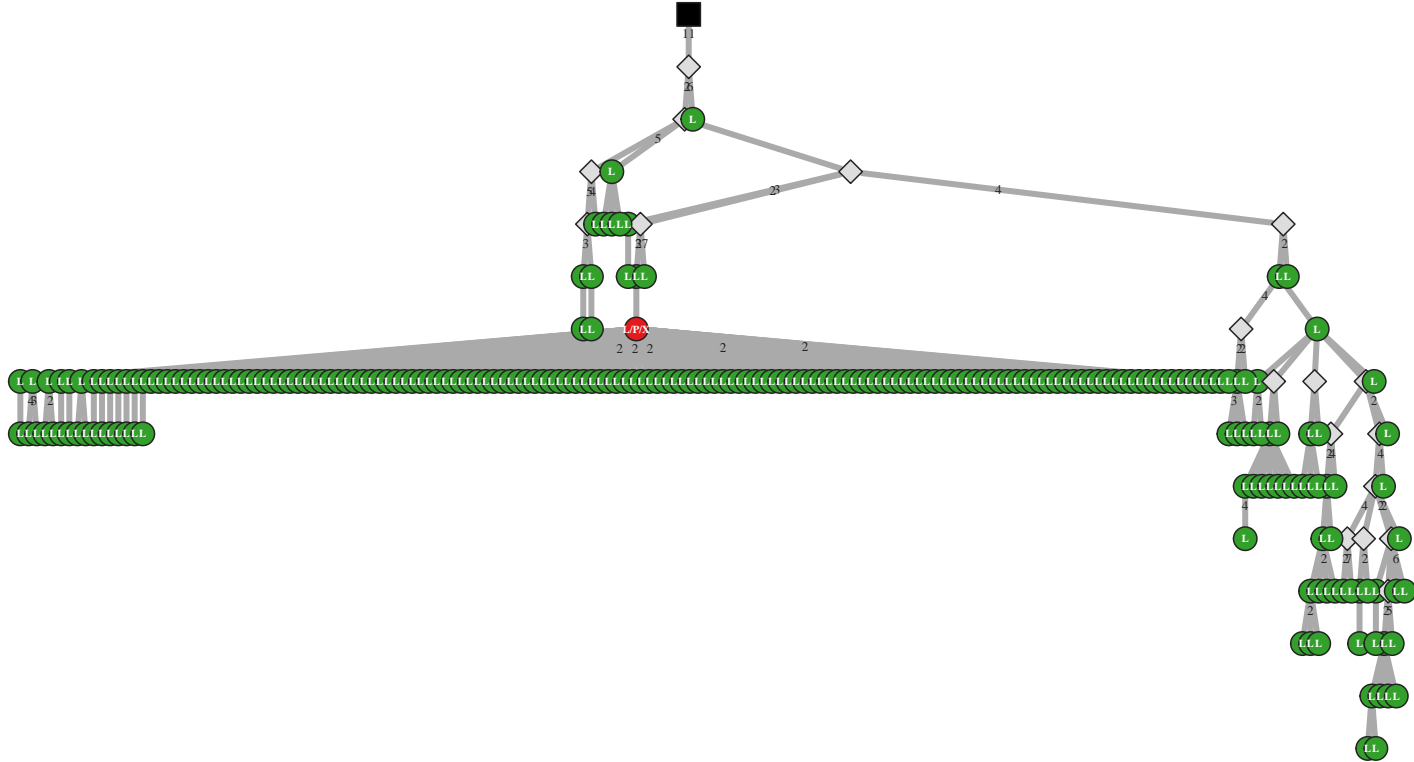

M5 IgG IGHV2-70/J4 48bp (15688)

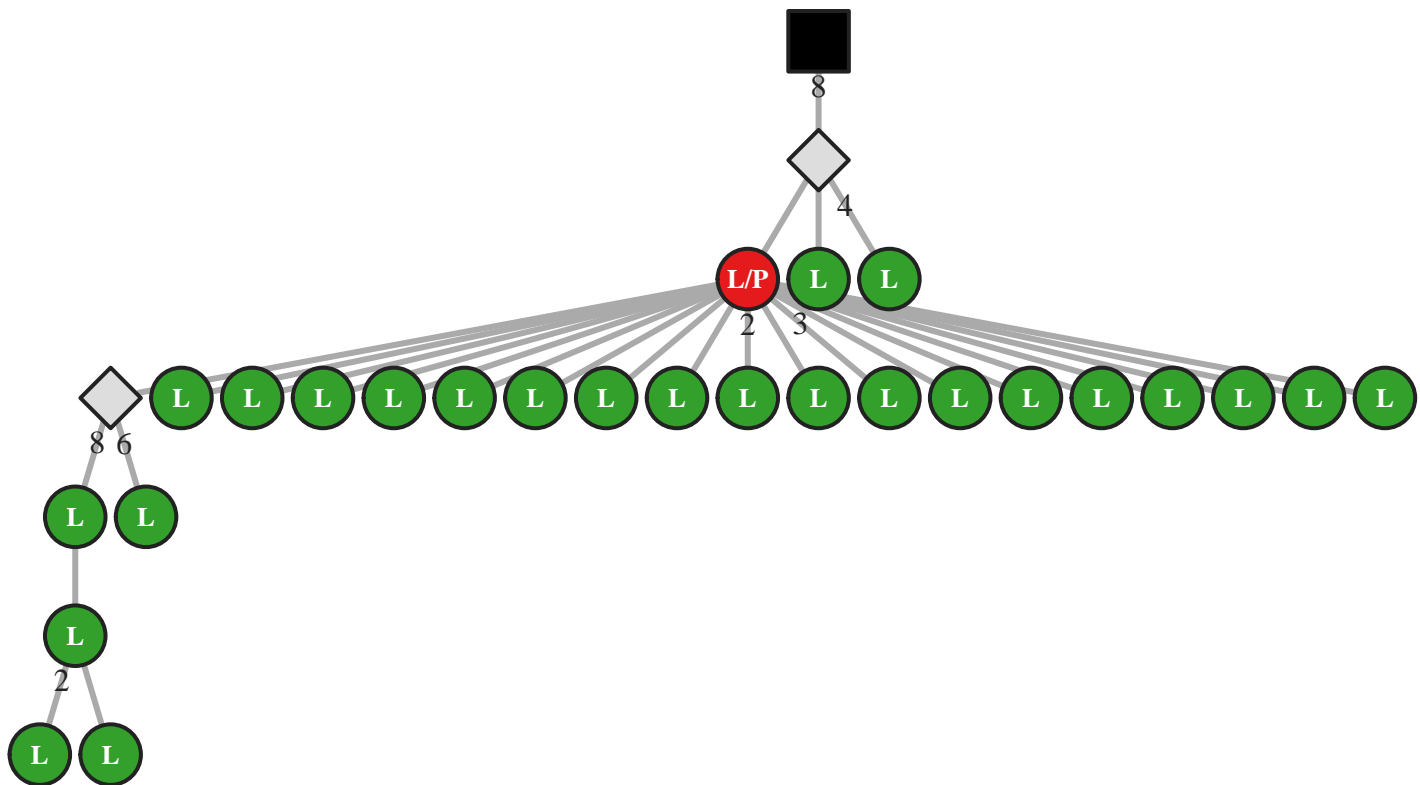

M5 IgG IGHV2-70/J4 48bp (15692)

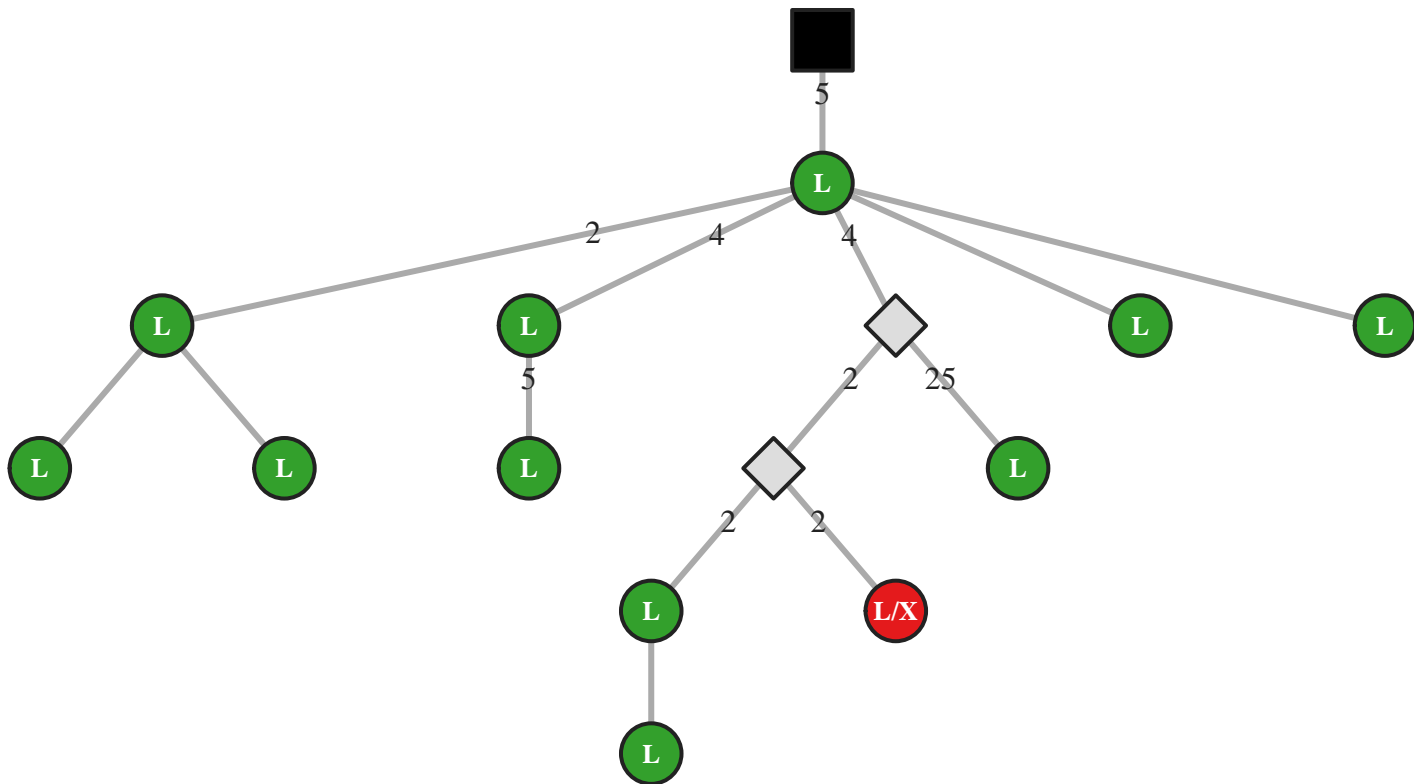

M5 IgG IGHV2-70/J4 48bp (15702)

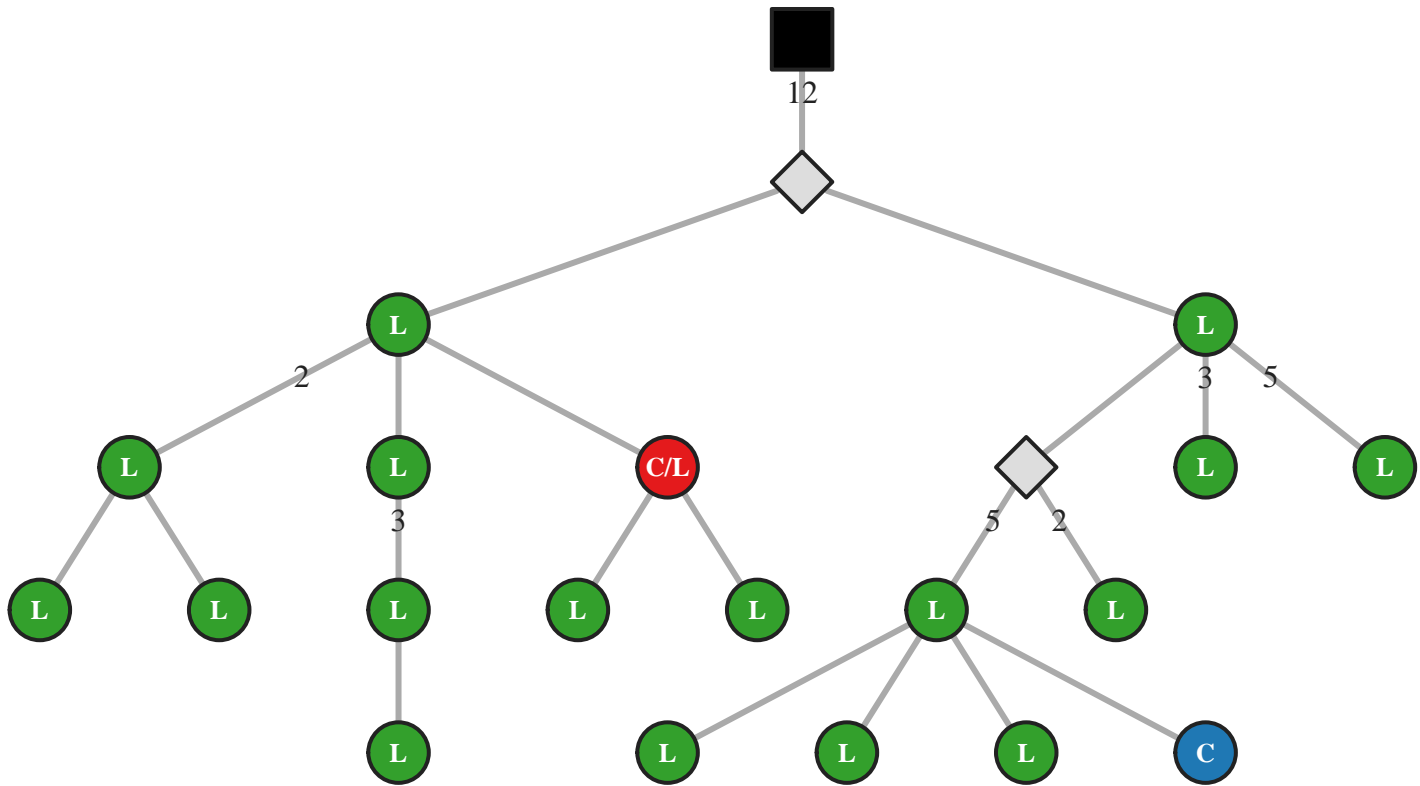

M5 IgG IGHV2-70/J4 48bp (15760)

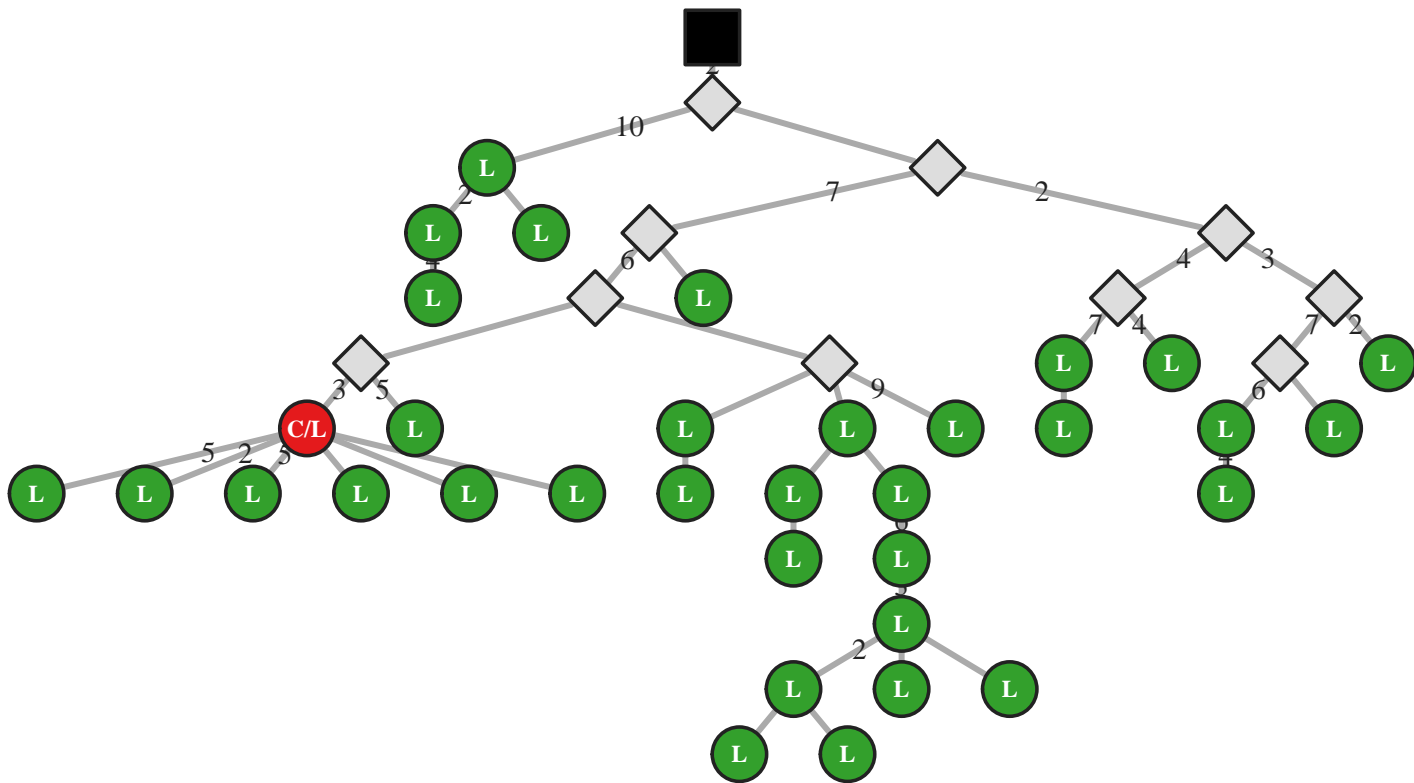

M5 IgG IGHV2-70/J4 51bp (42958)

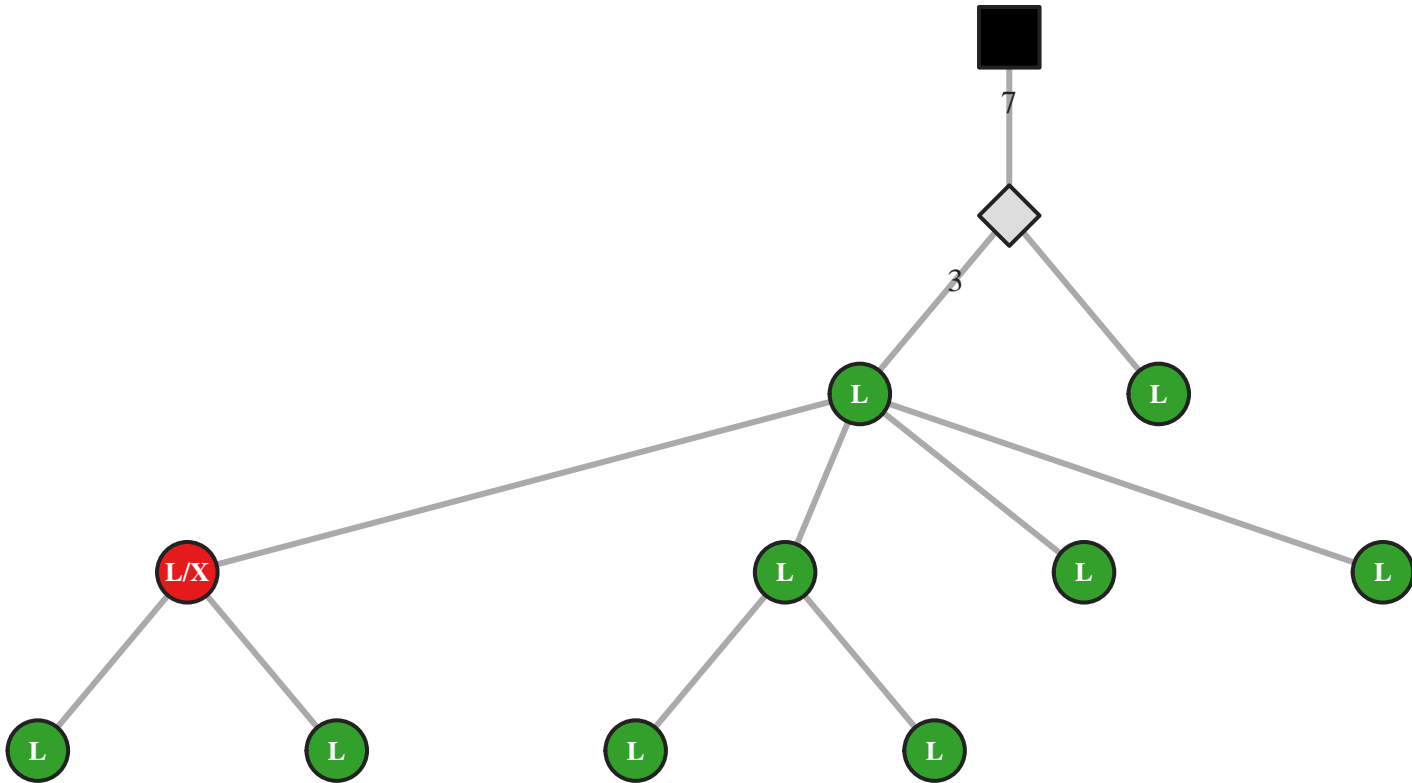

M5 IgG IGHV2-70/J4 54bp (15772)

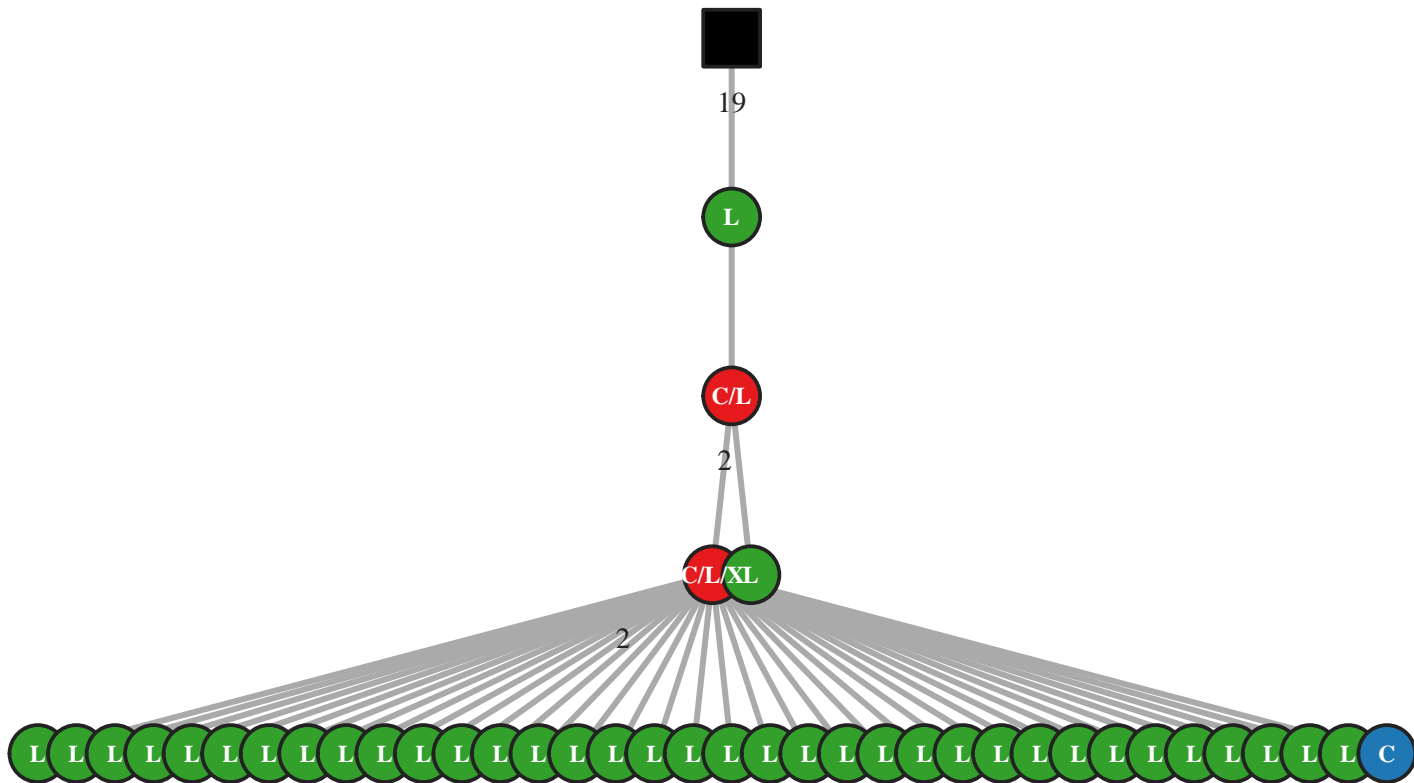

M5 IgG IGHV2-70/J4 57bp (15802)

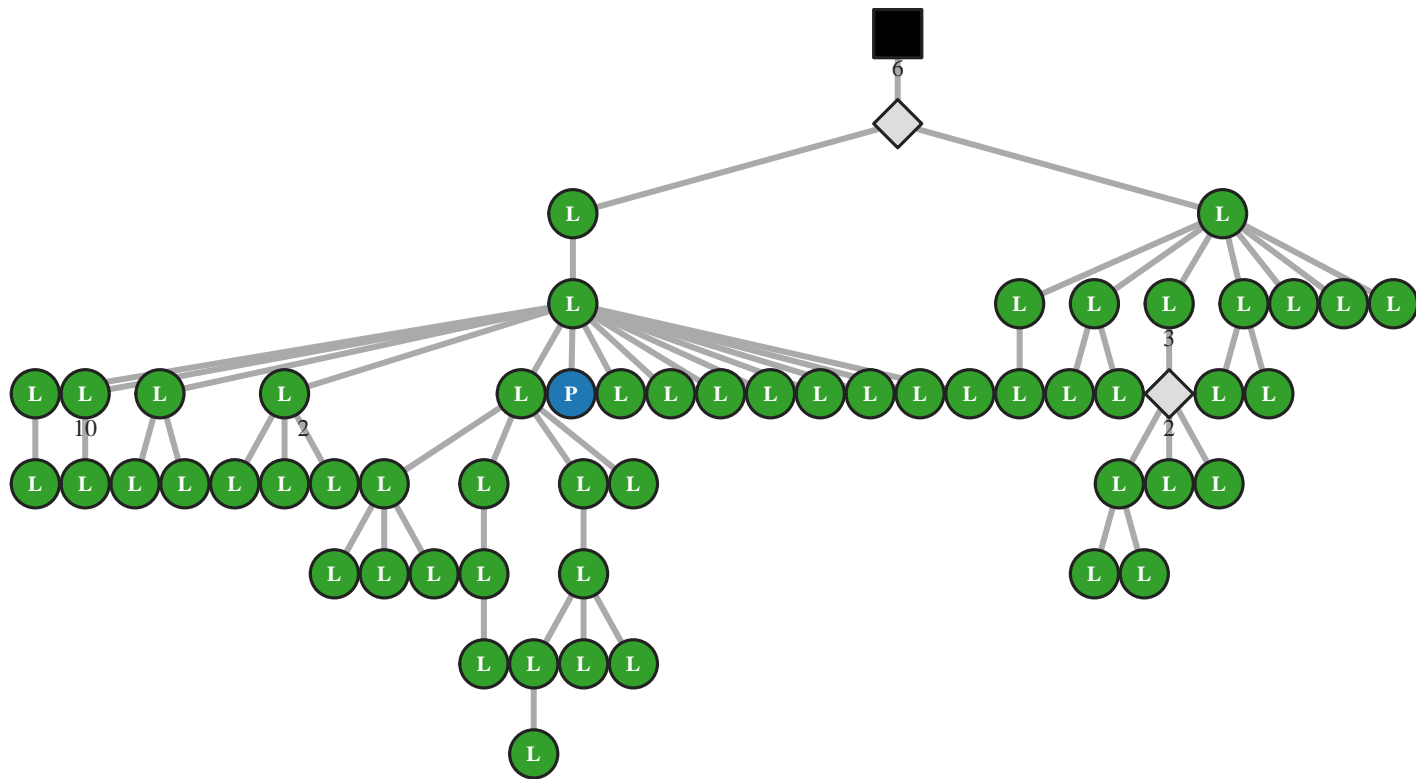

M5 IgG IGHV2-70/J4 57bp (15807)

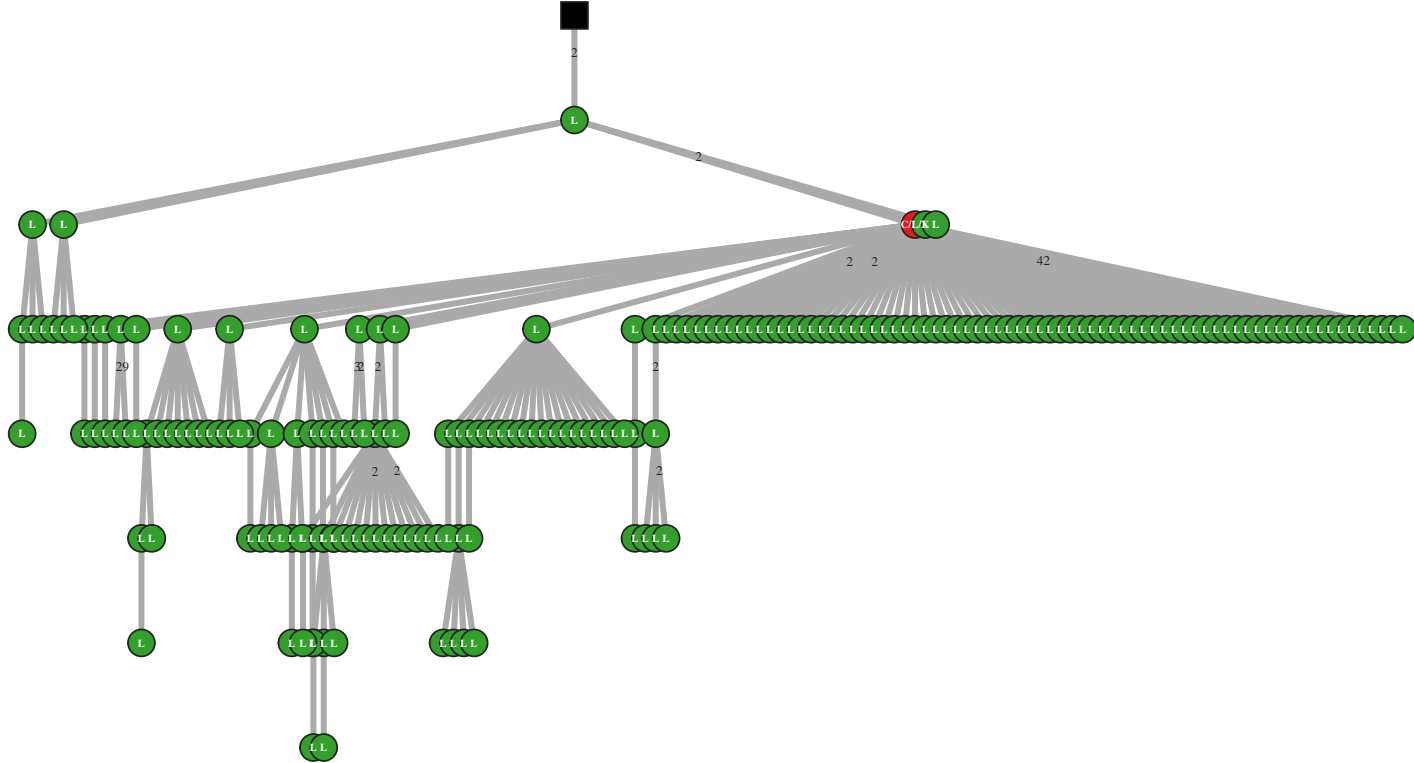

M5 IgG IGHV2-70/J4 57bp (15813)

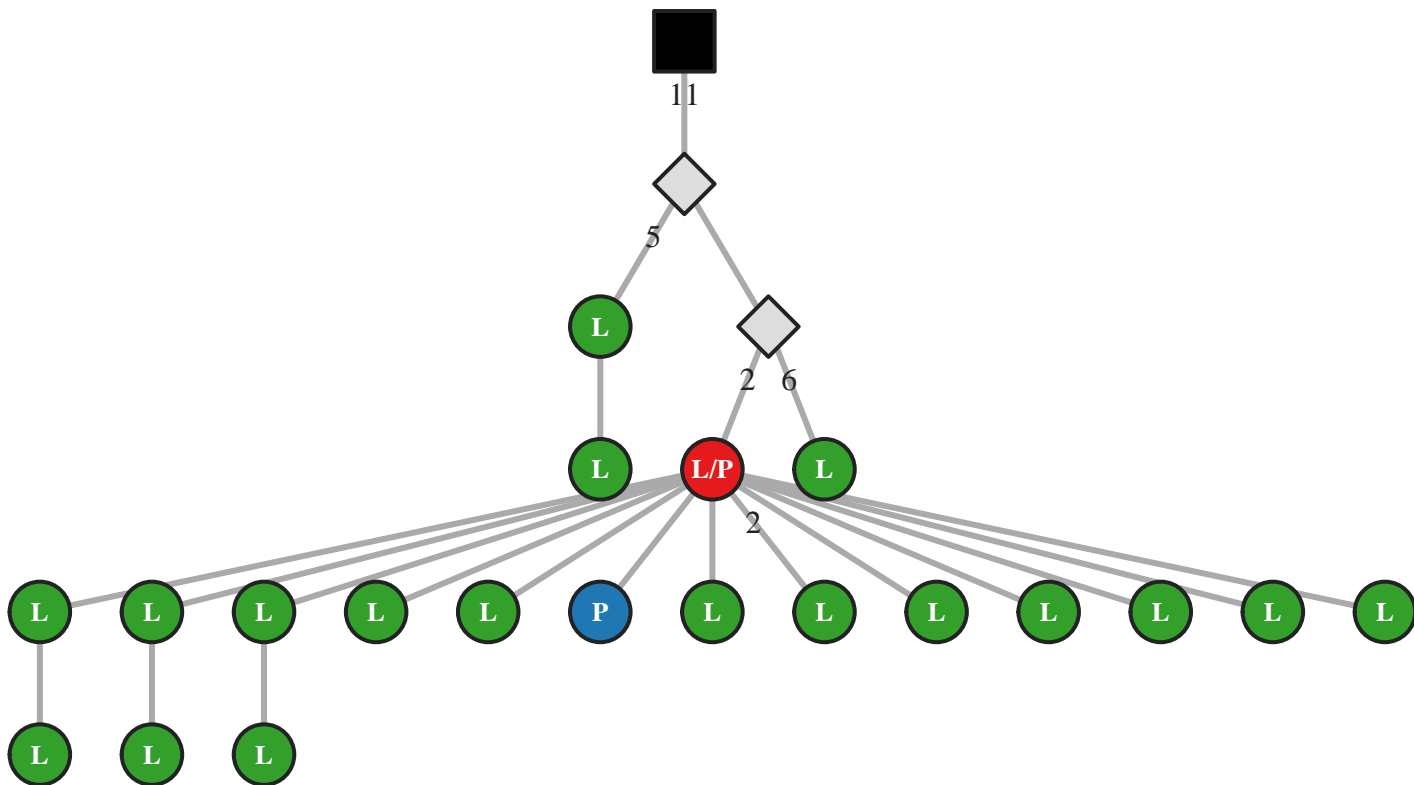

M5 IgM IGHV2-70/J4 57bp (54010)

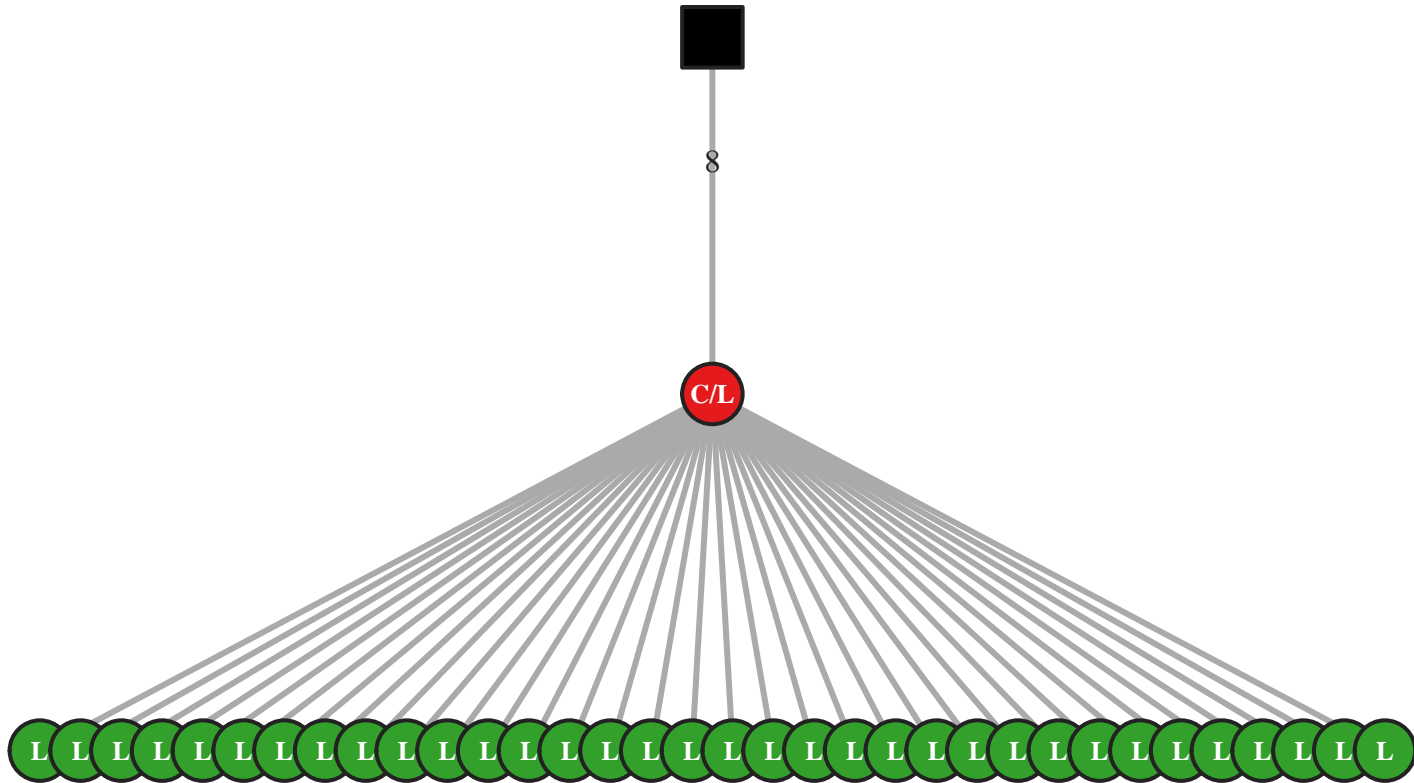

M5 IgG IGHV2-70/J4 60bp (6088)

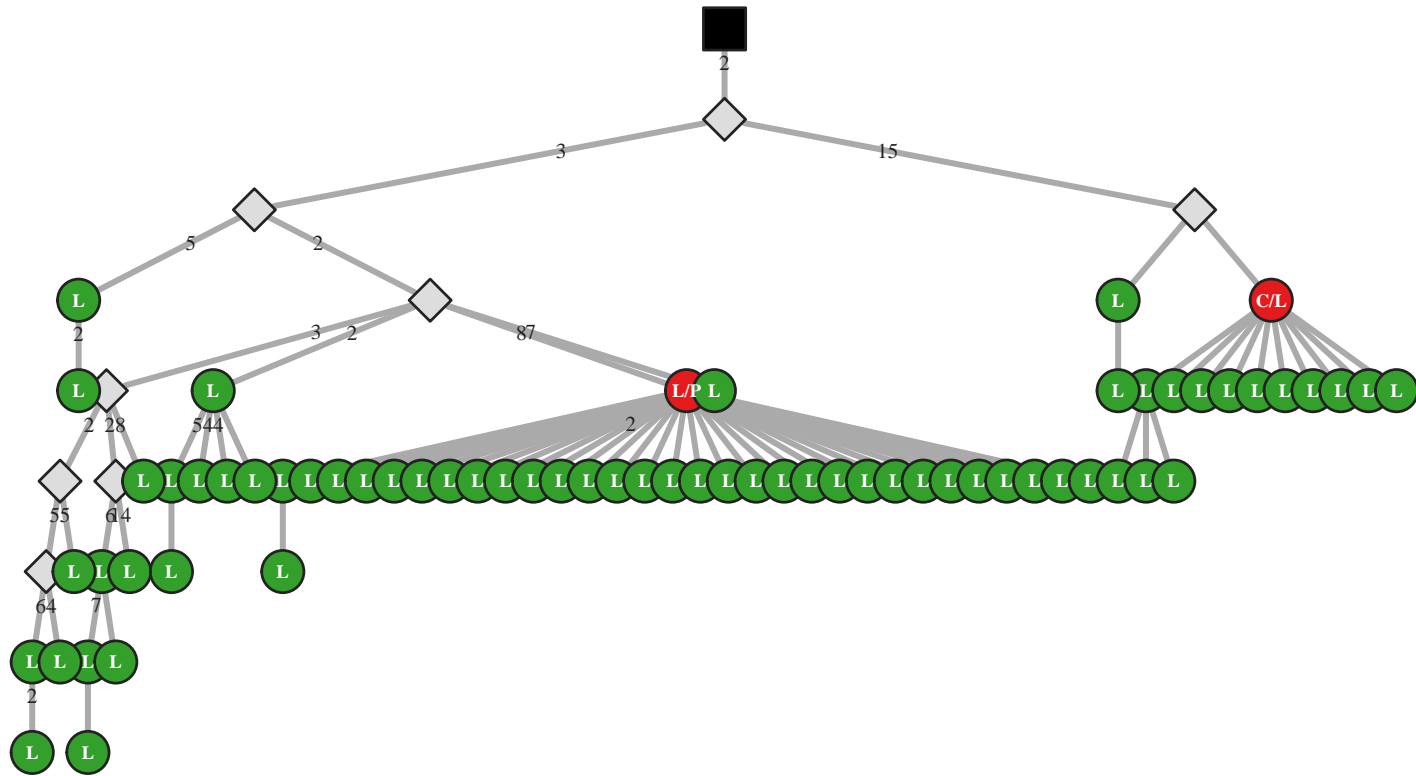

M5 IgG IGHV2-70/J4 60bp (6095)

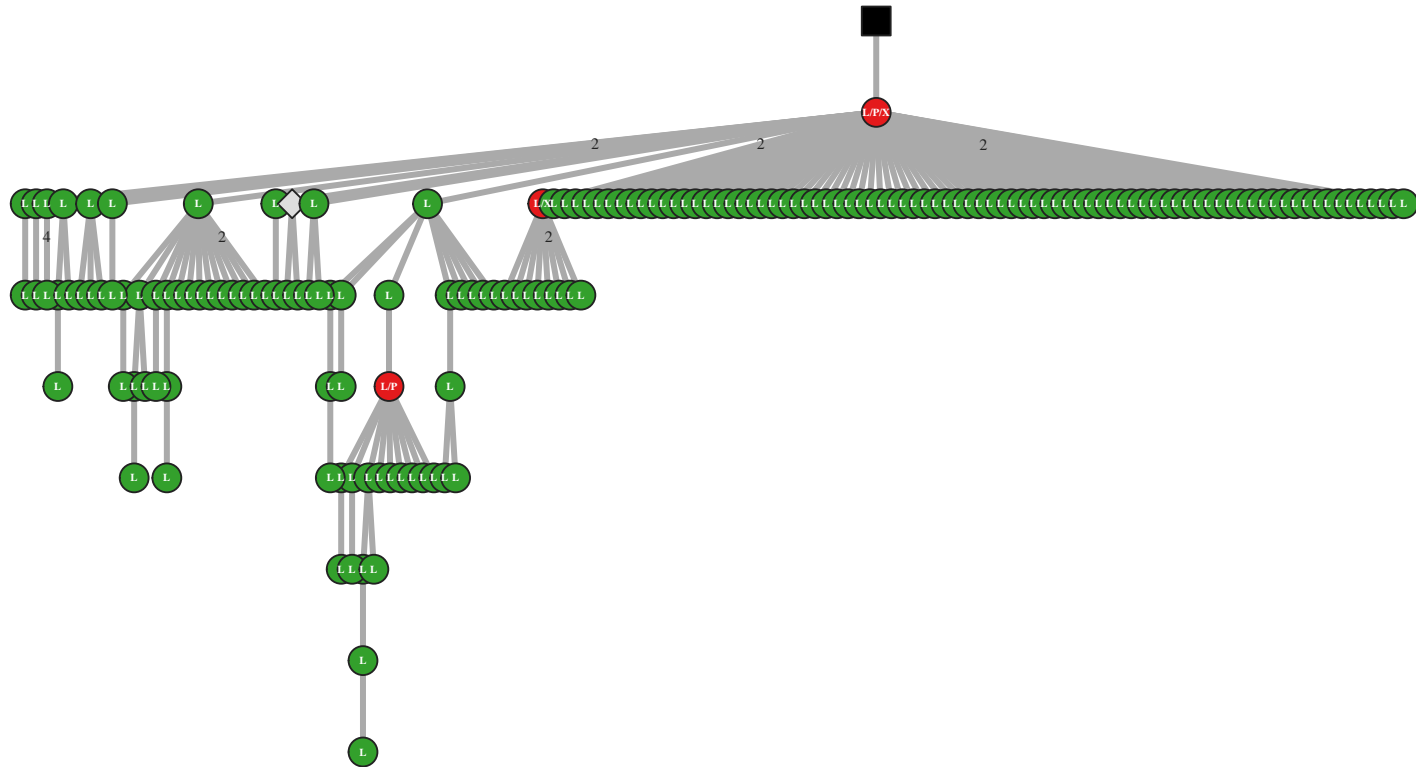

M5 IgG IGHV2-70/J4 63bp (15836)

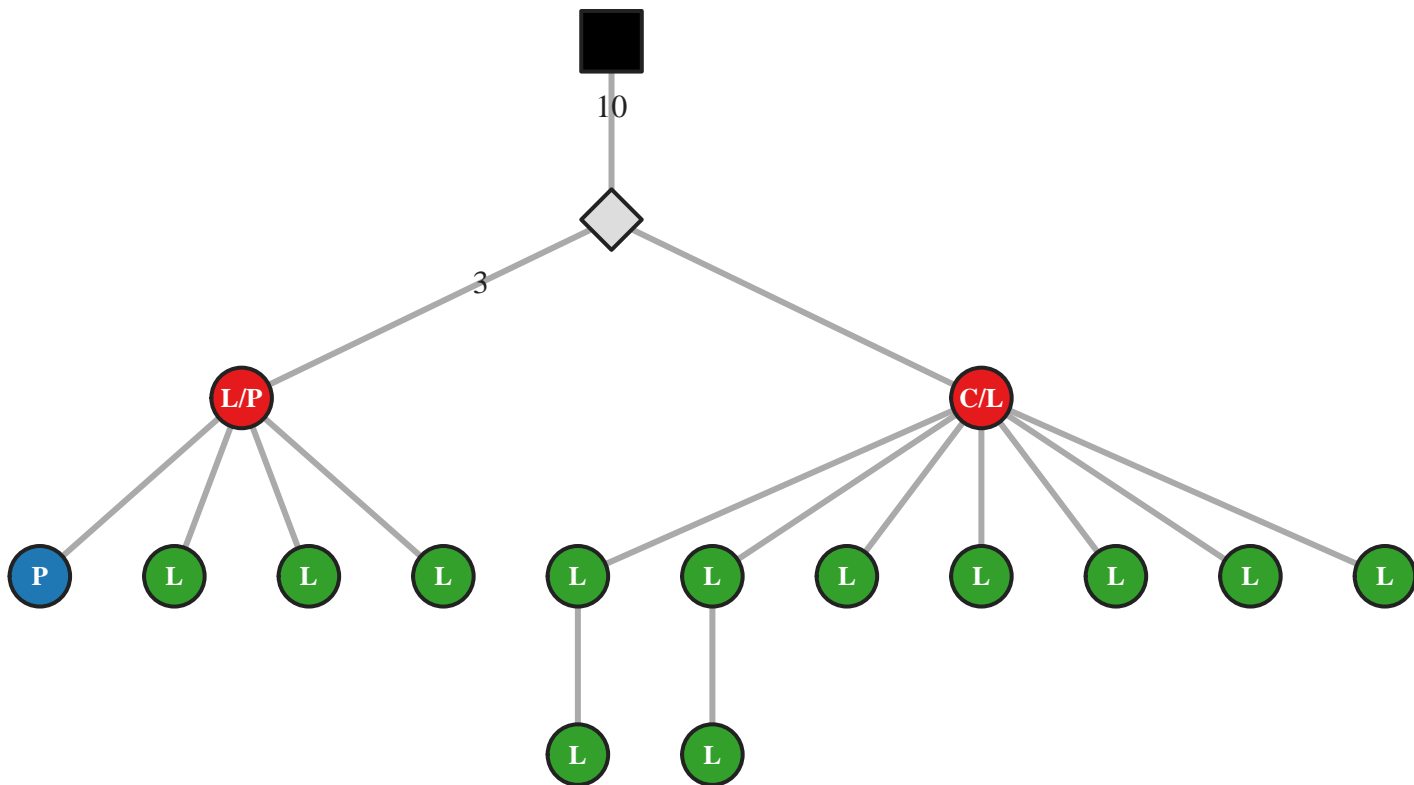

M5 IgG IGHV2-70/J6 45bp (43010)

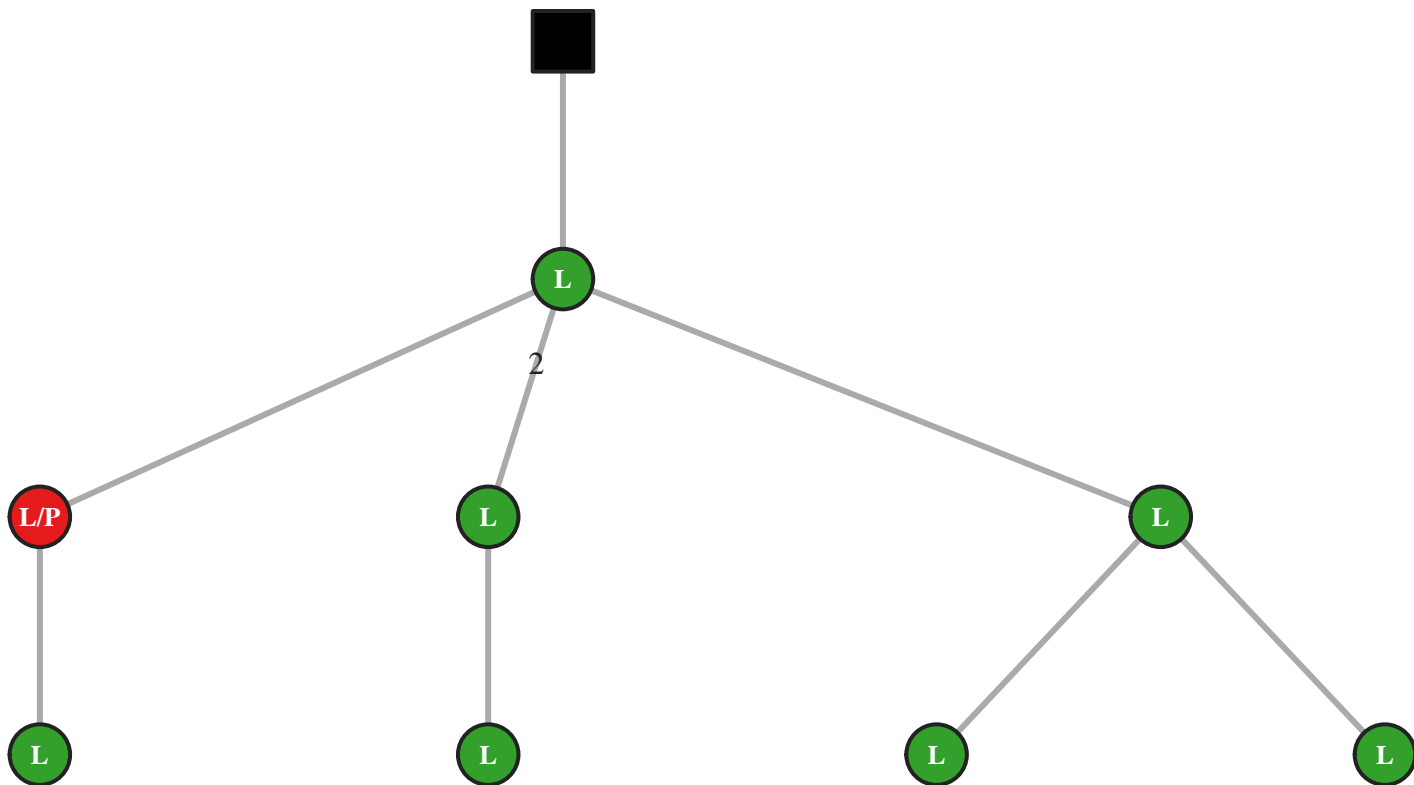

M5 IgG IGHV2-70/J6 51bp (24778)

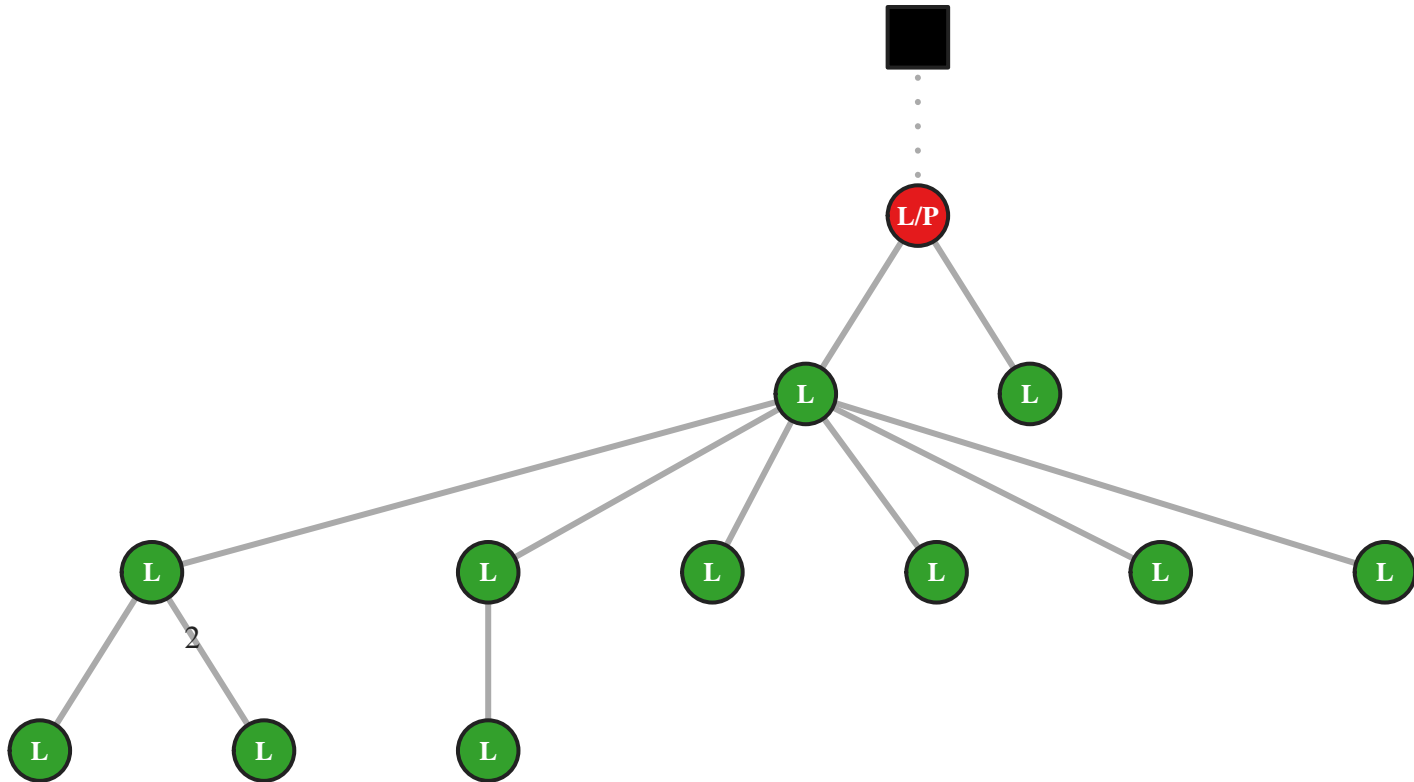

M5 IgG IGHV2-70/J6 57bp (33799)

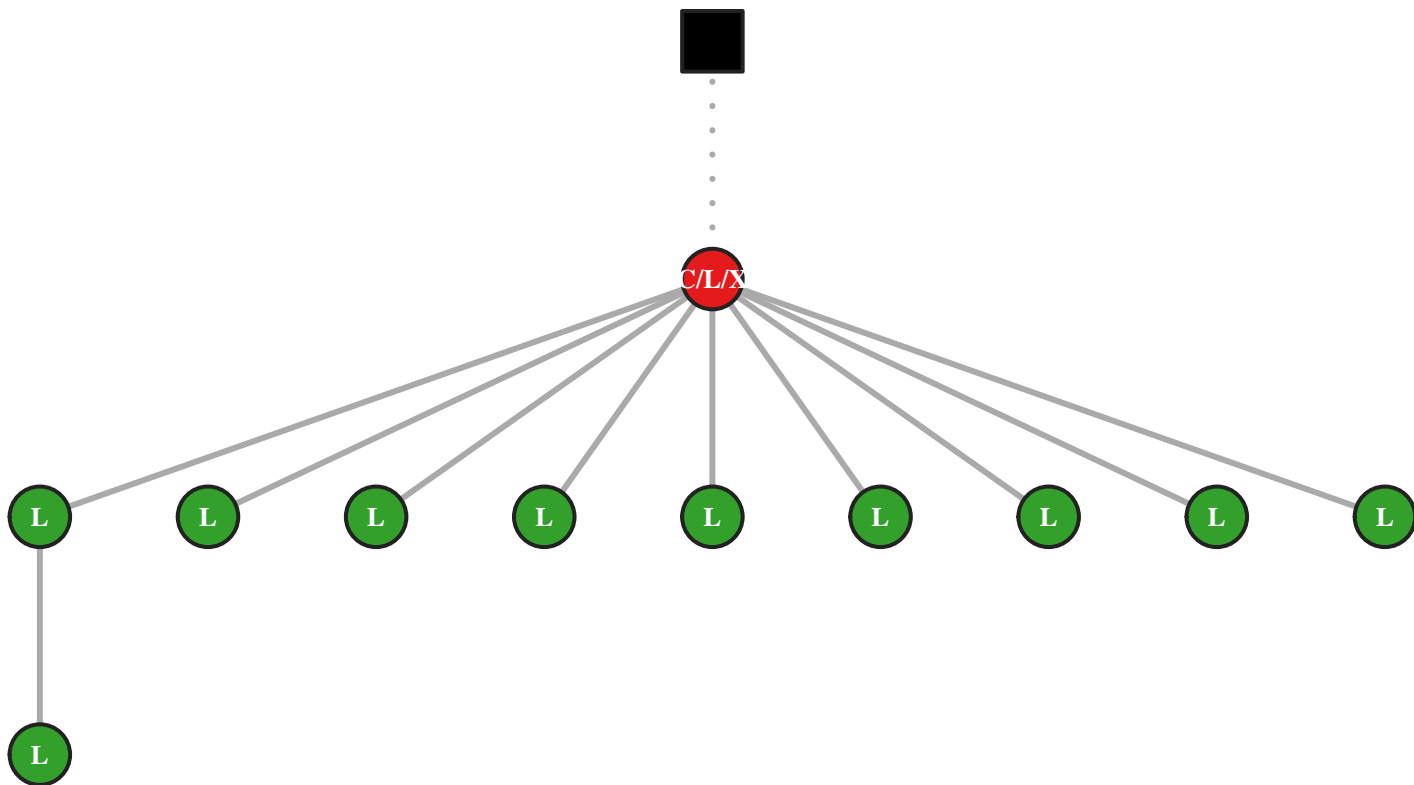

M5 IgG IGHV2-70/J6 57bp (33804)

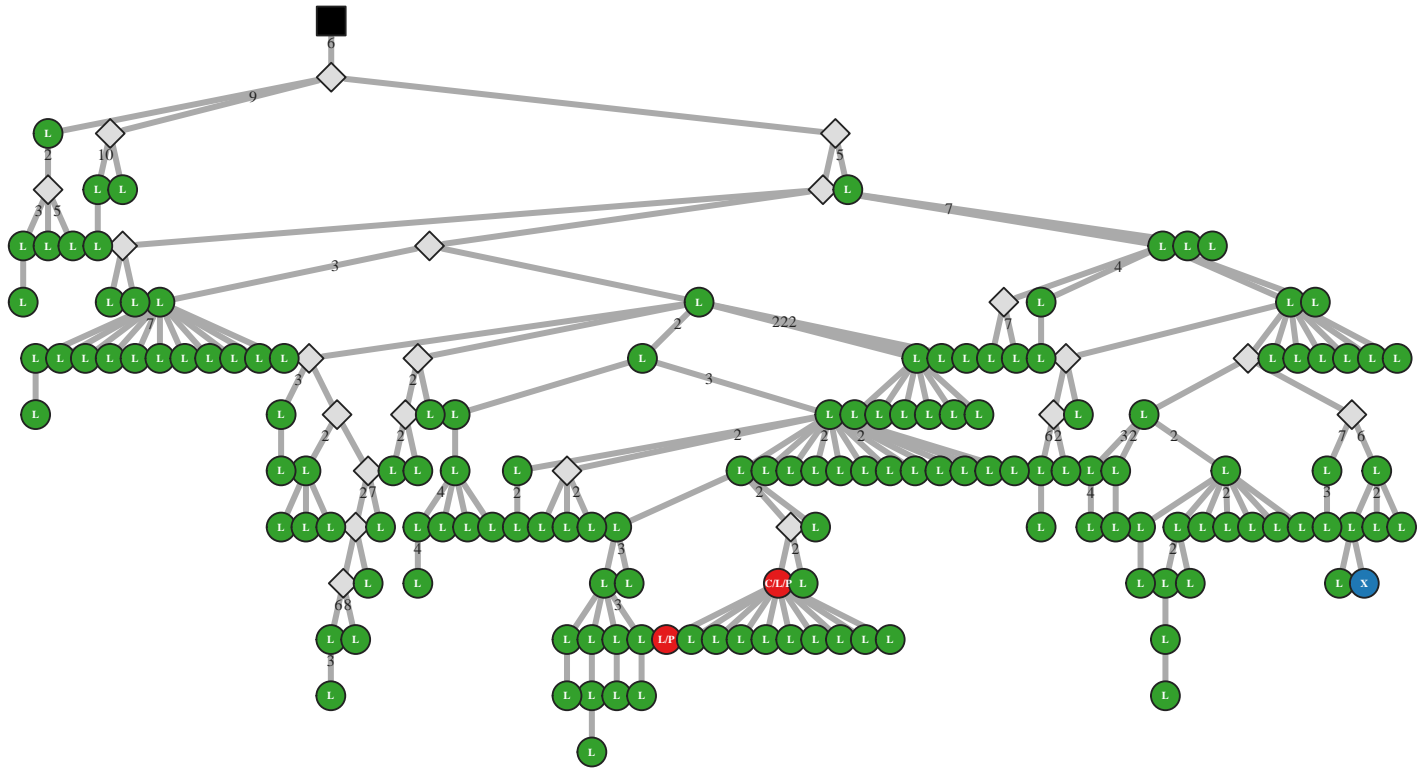

M5 IgG IGHV2-70/J6 57bp (33809)

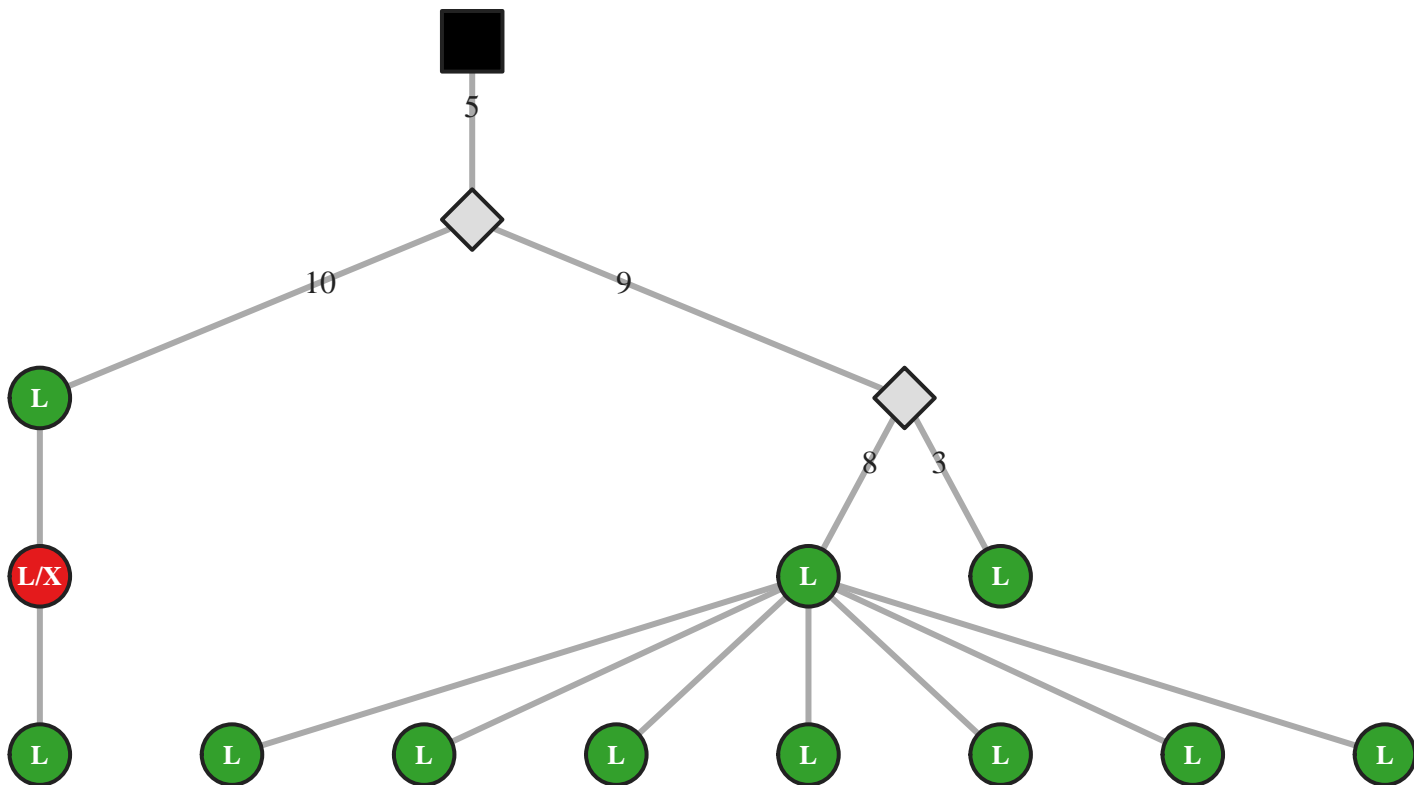

M5 IgG IGHV2-70/J6 60bp (15861)

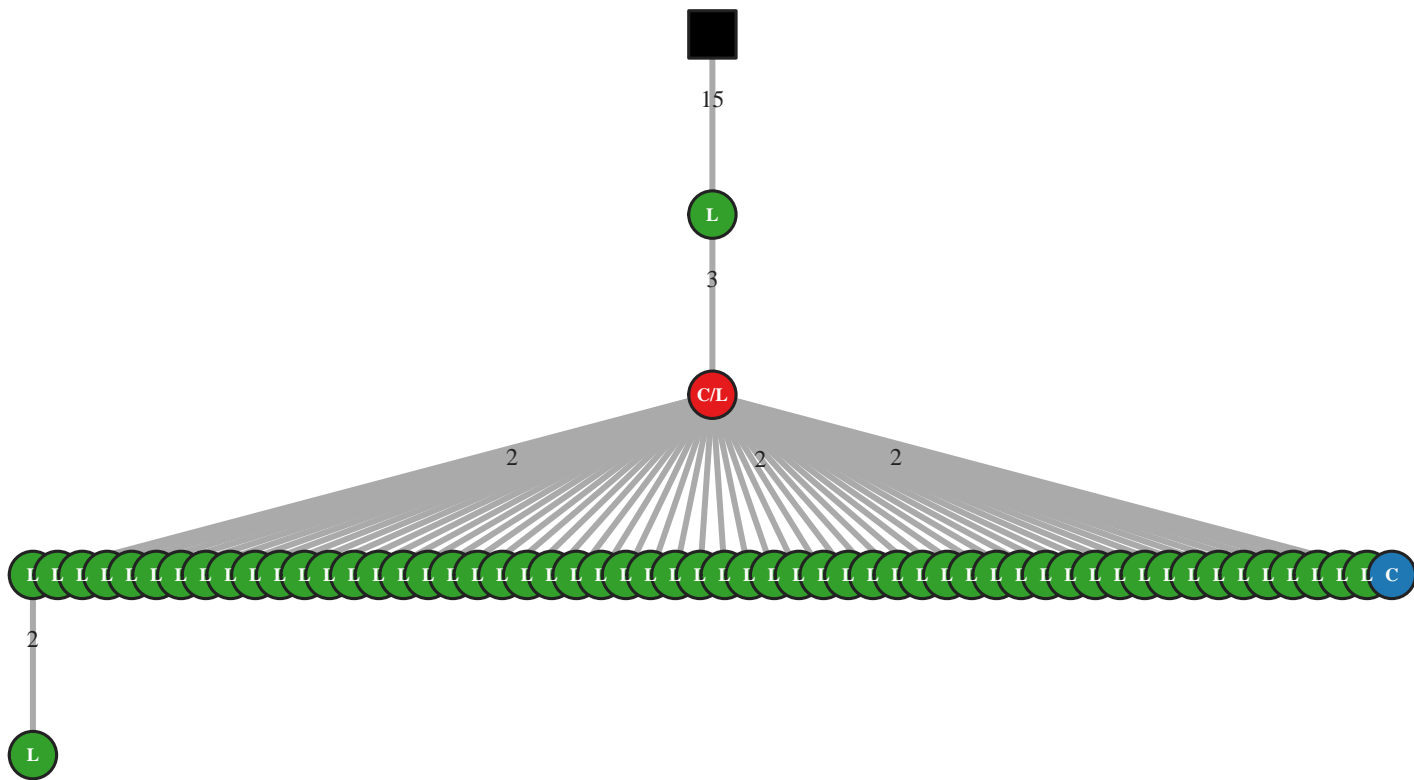

M5 IgG IGHV2-70/J6 63bp (6143)

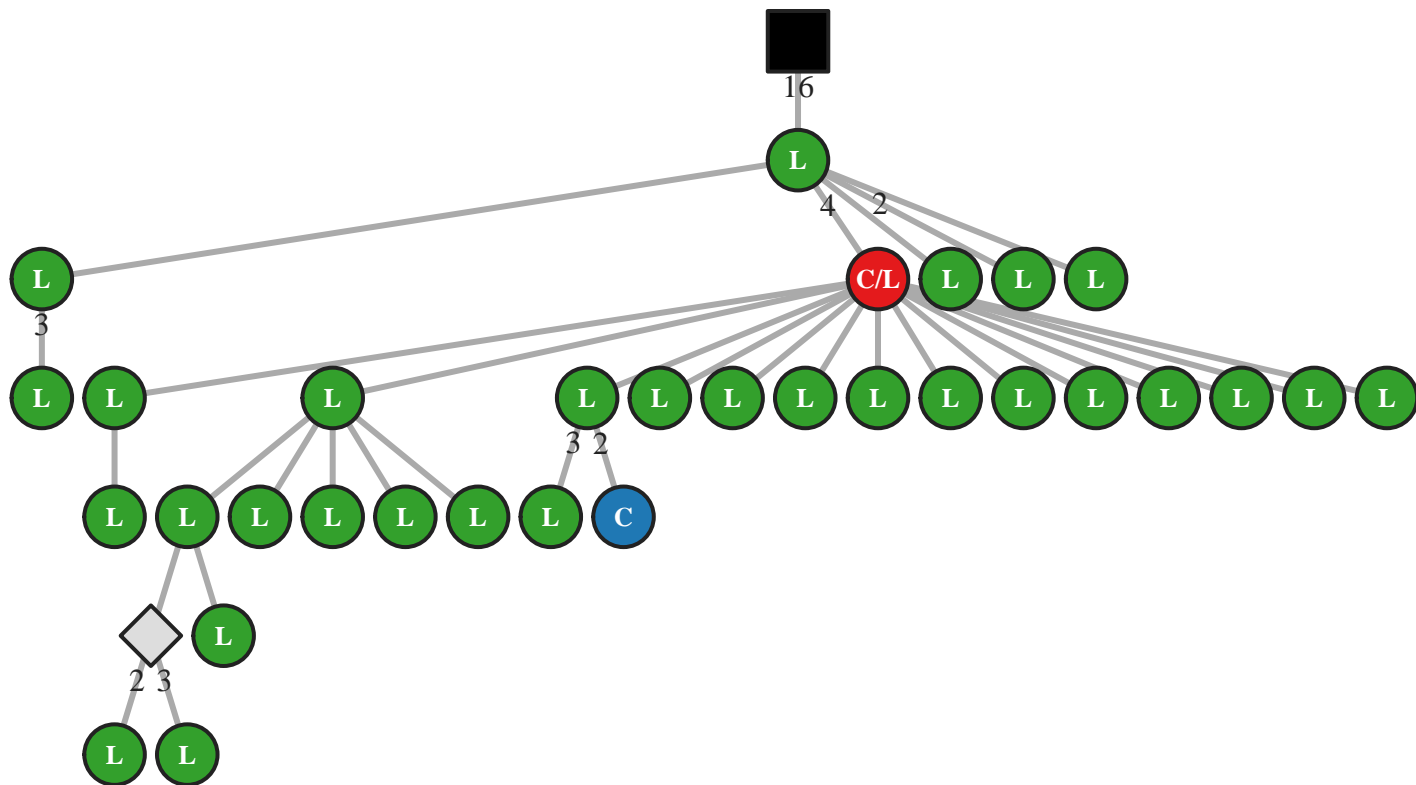

M5 IgG IGHV2-70/J6 66bp (43057)

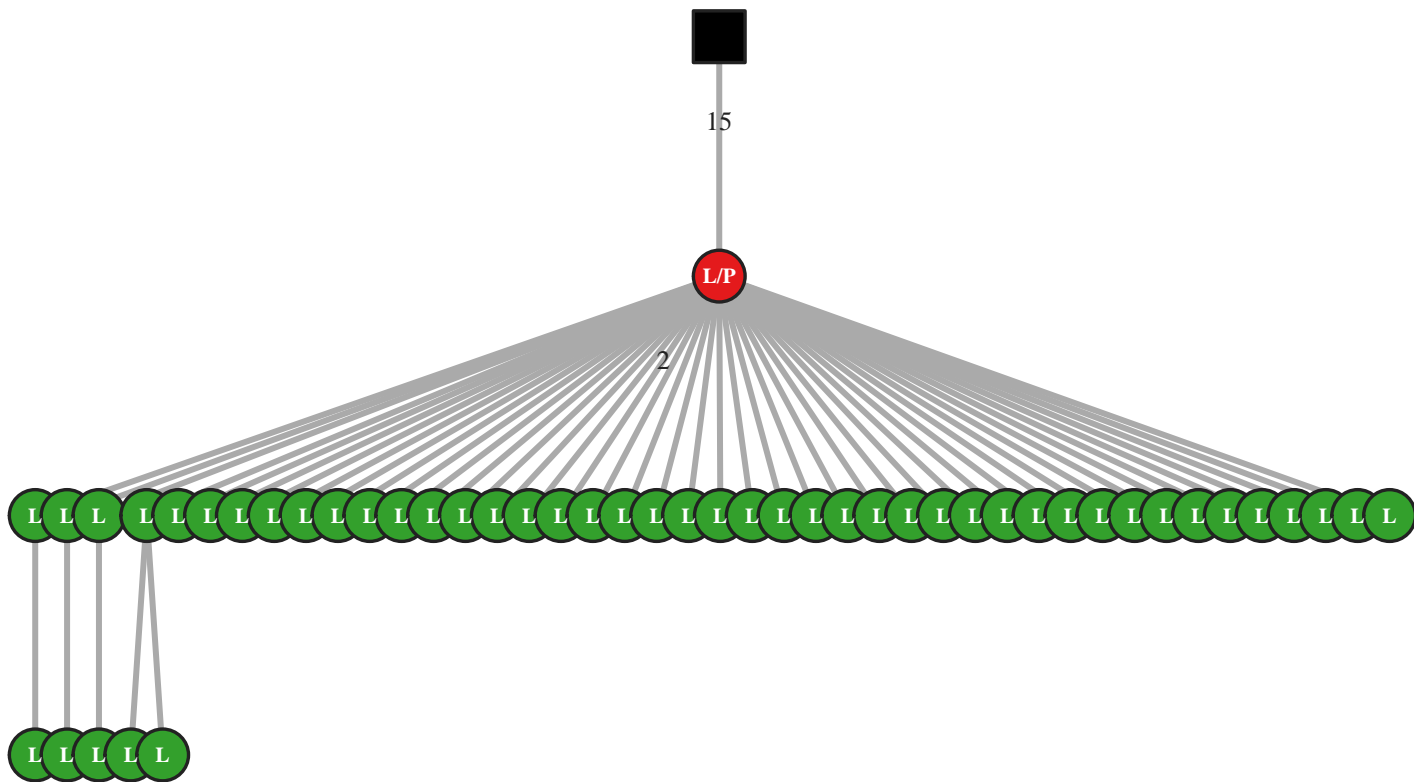

M5 IgG IGHV3-11/J1 45bp (24808)

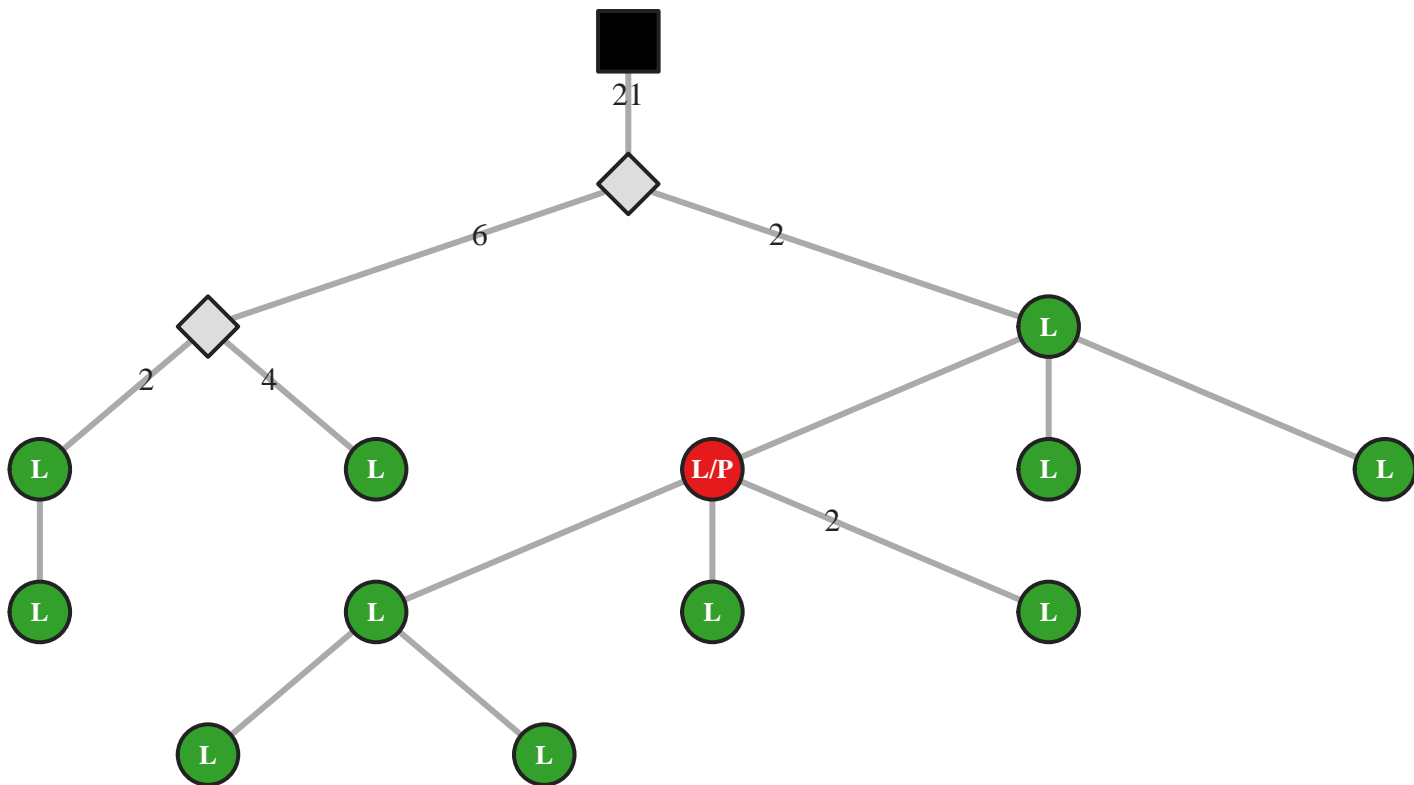

M5 IgG IGHV3-11/J3 51bp (6178)

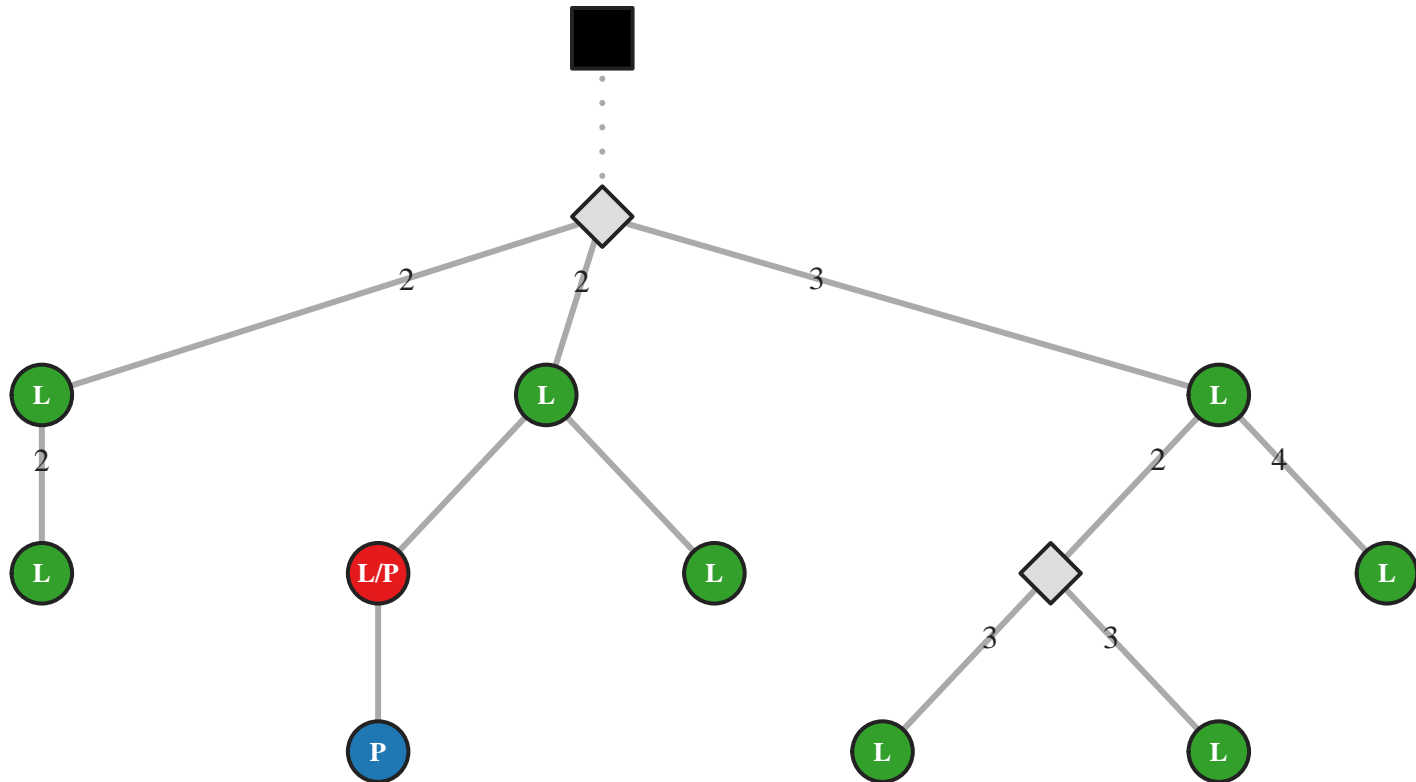

M5 IgM IGHV3-11/J3 51bp (47850)

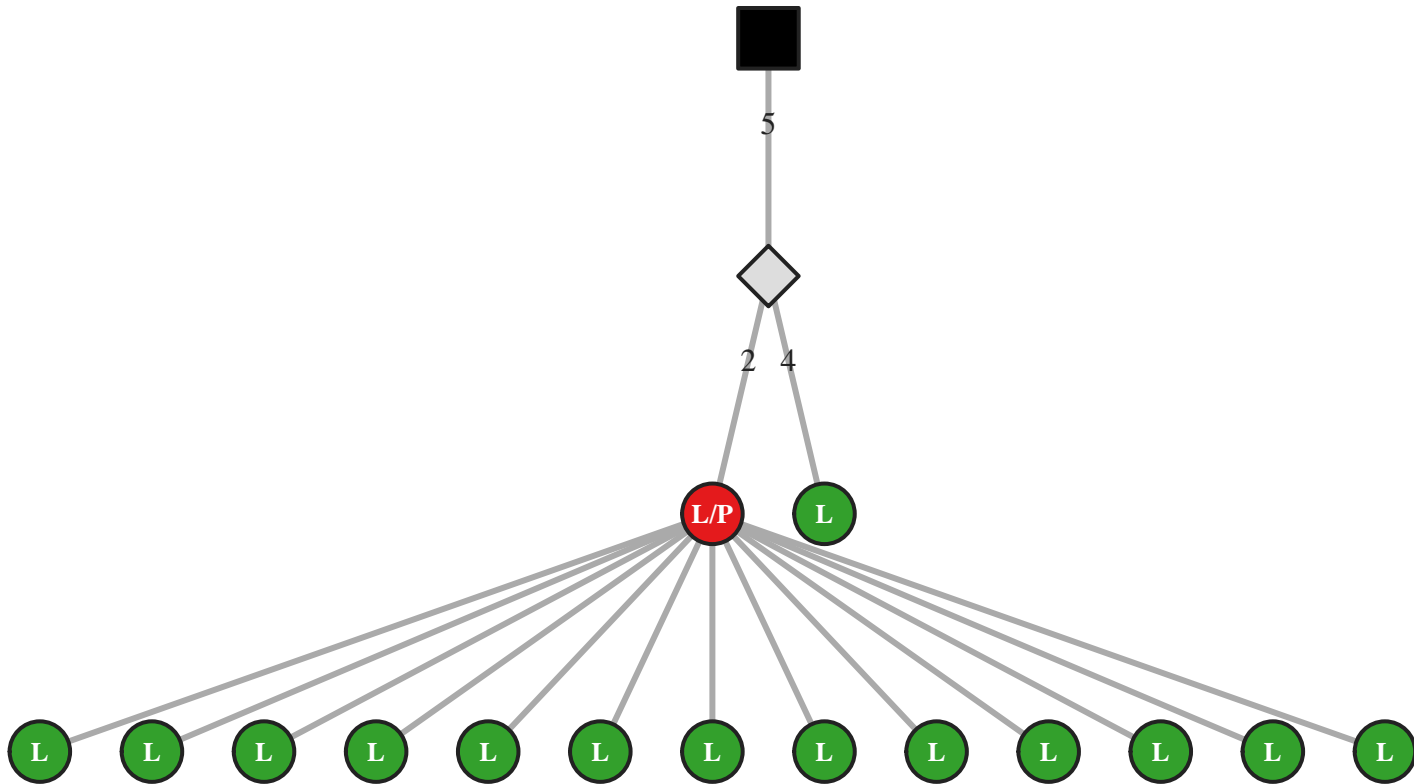

M5 IgG IGHV3-11/J3 69bp (33842)

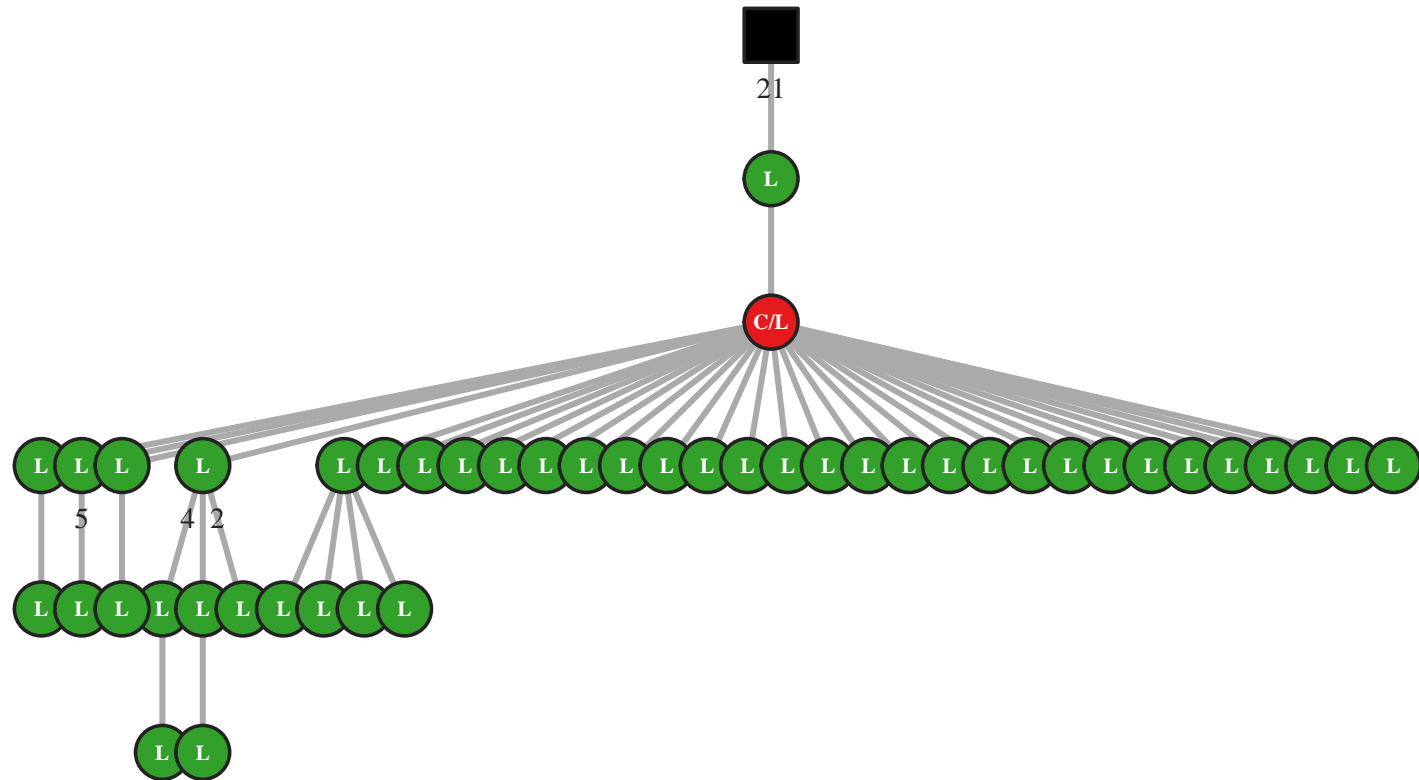

M5 IgG IGHV3-11/J4 24bp (50759)

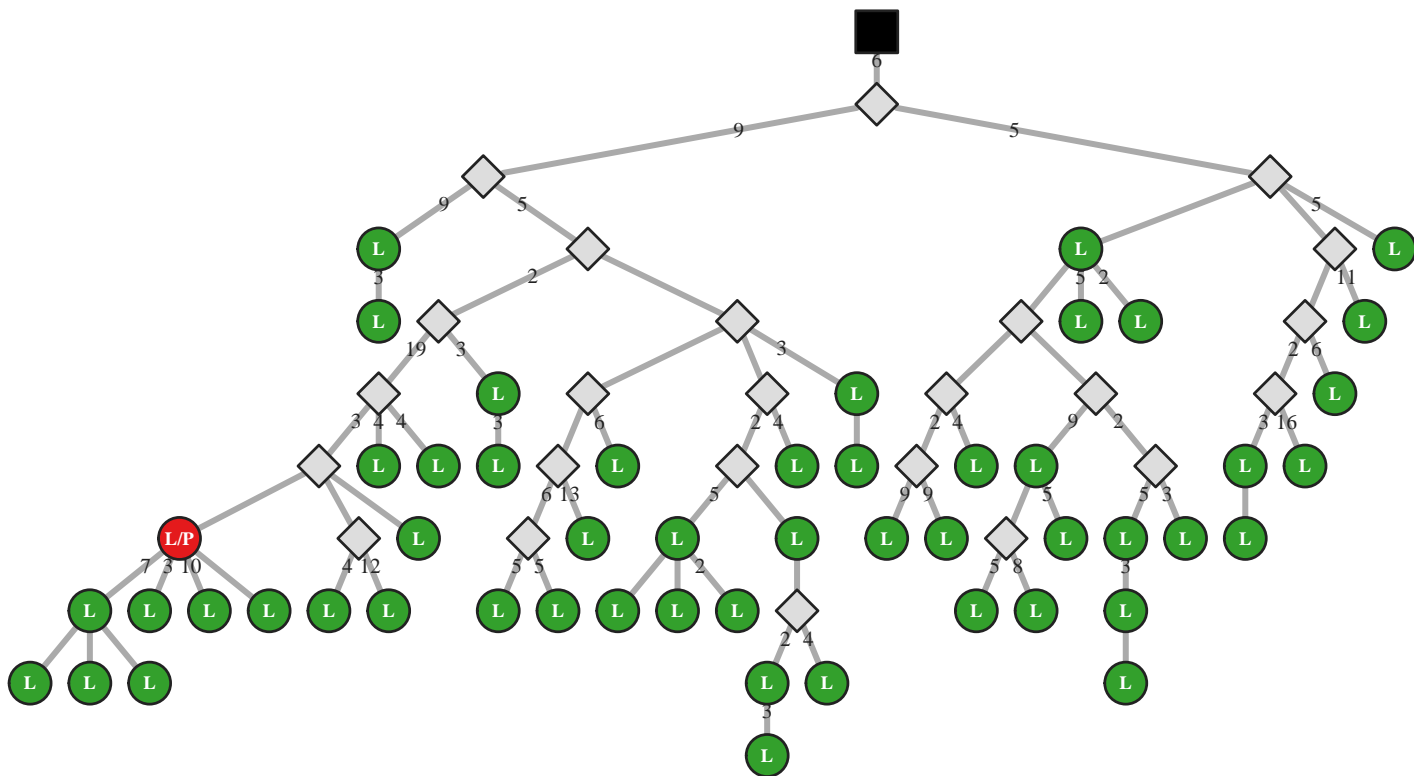

M5 IgG IGHV3-11/J4 33bp (24836)

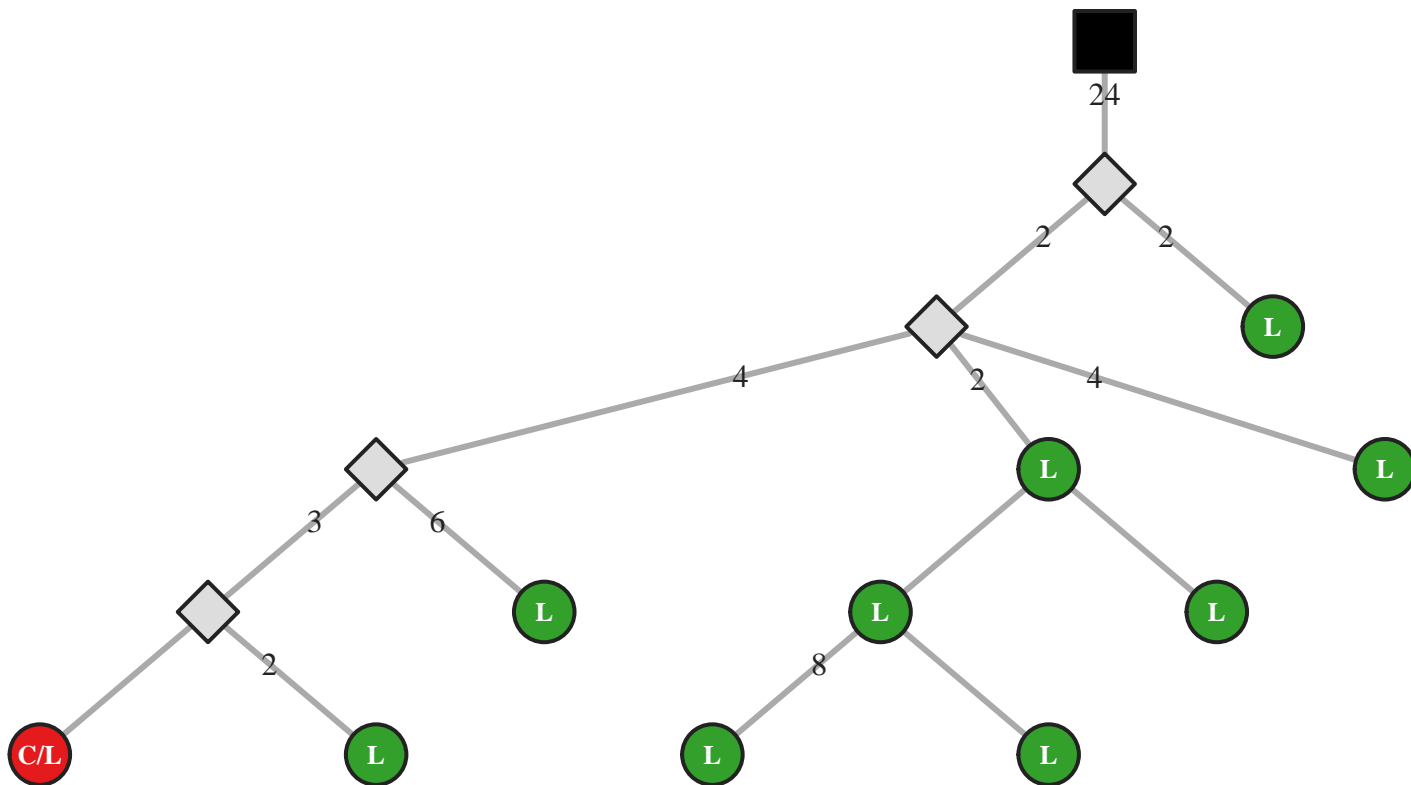

M5 IgG IGHV3-11/J4 33bp (24845)

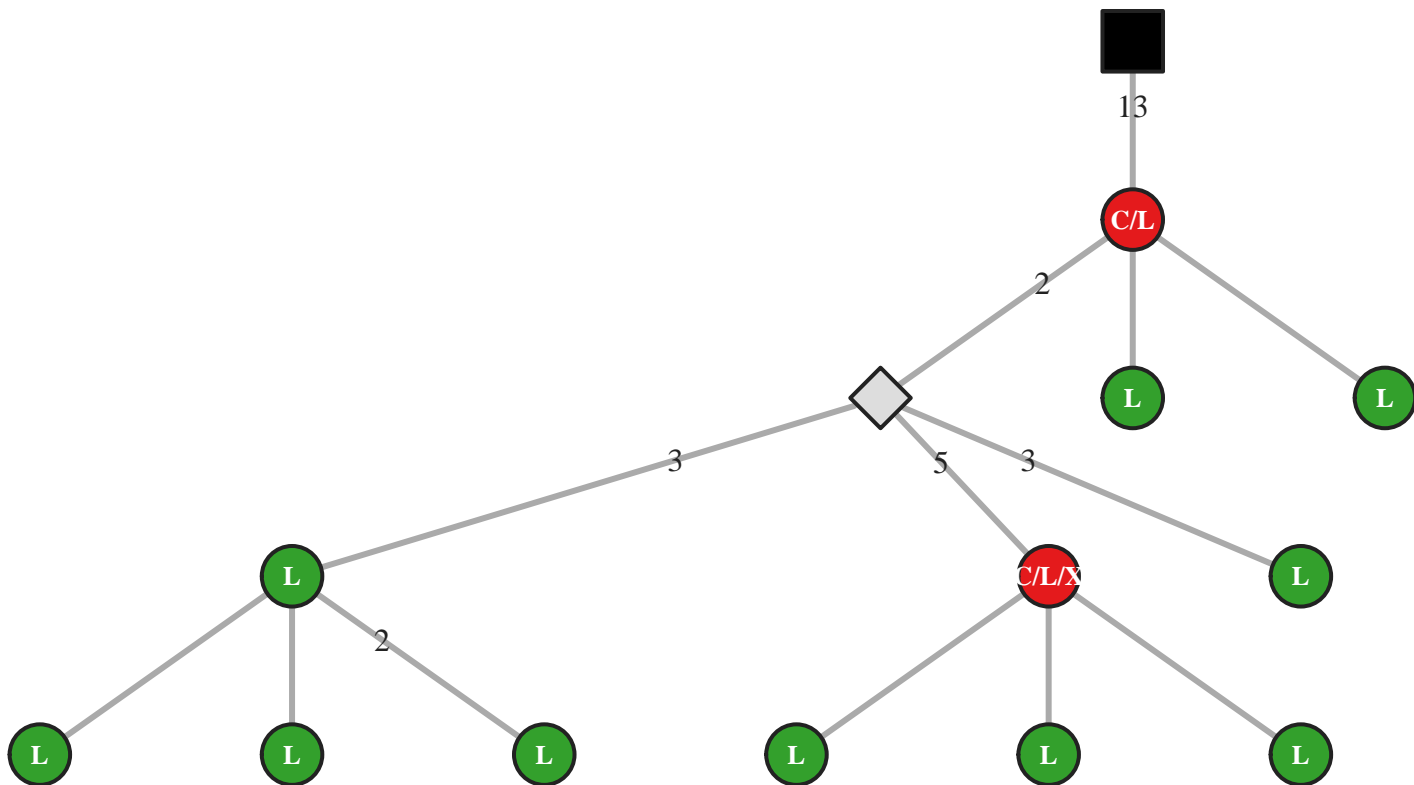

M5 IgG IGHV3-11/J4 36bp (15903)

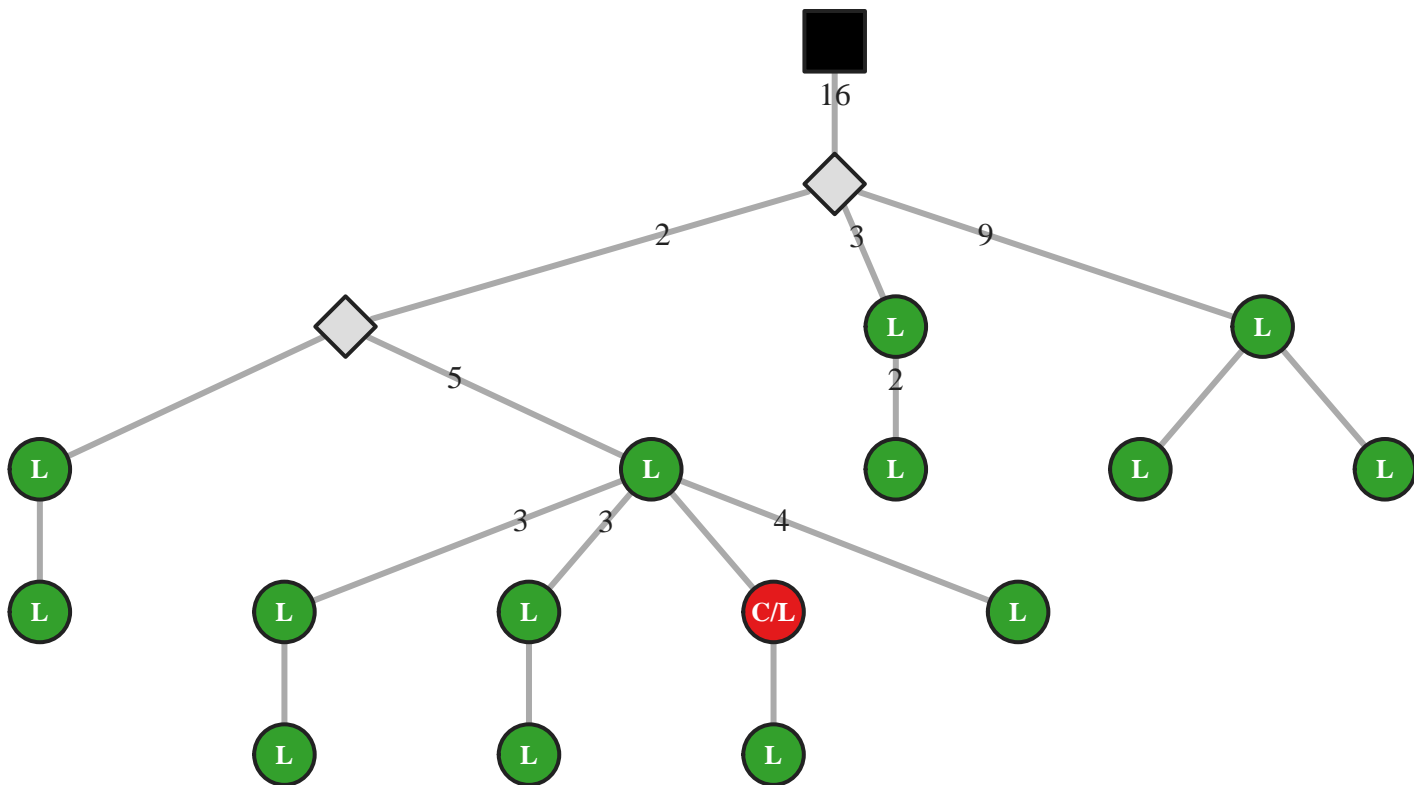

M5 IgG IGHV3-11/J4 36bp (15906)

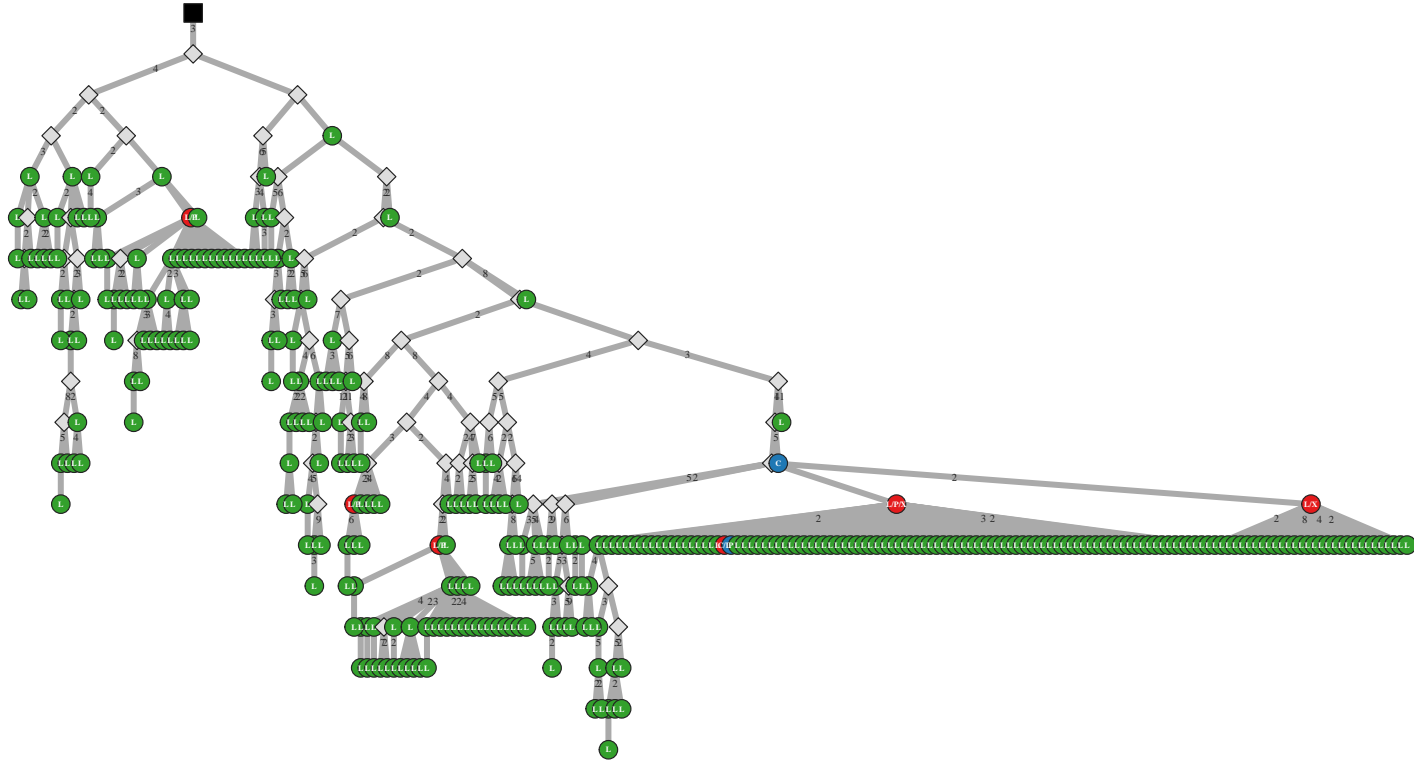

M5 IgG IGHV3-11/J4 36bp (15941)

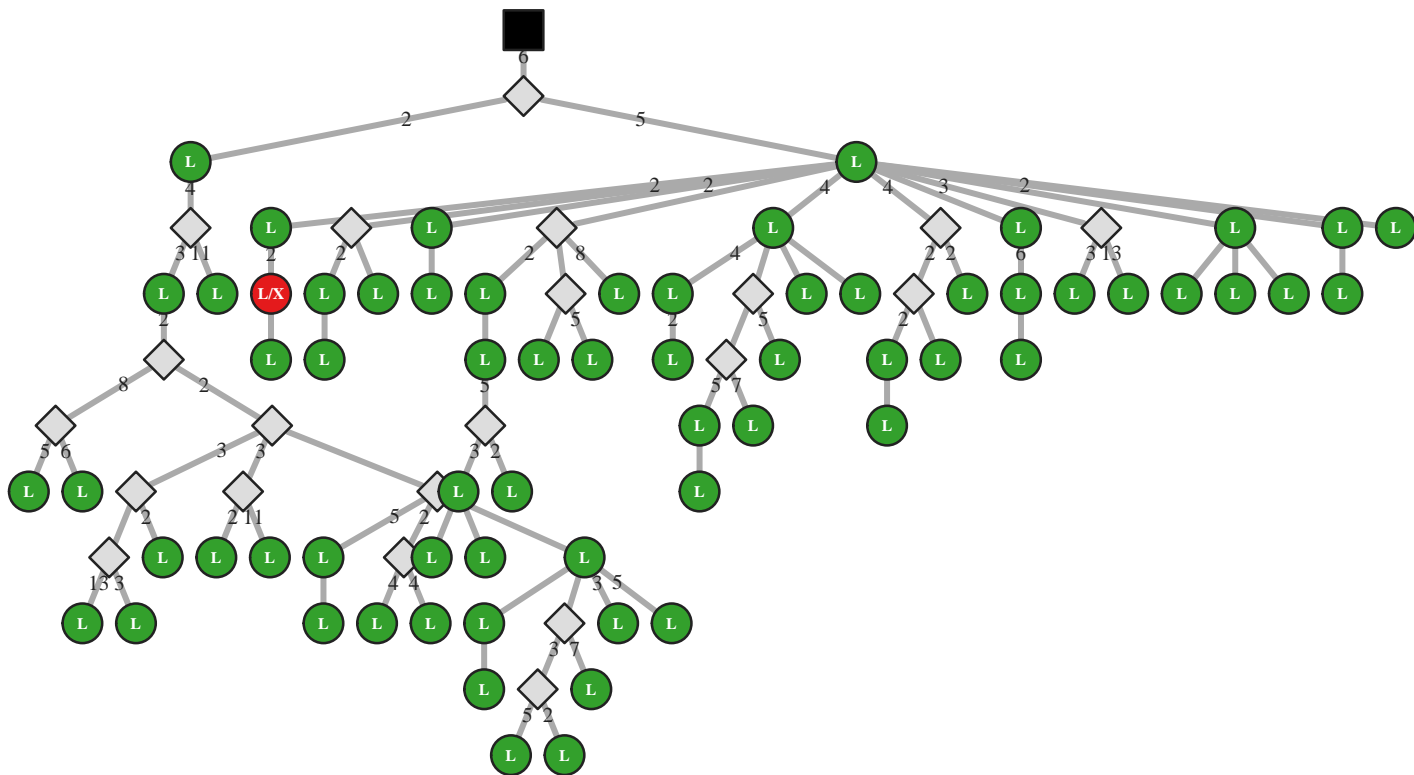

M5 IgG IGHV3-11/J4 36bp (15943)

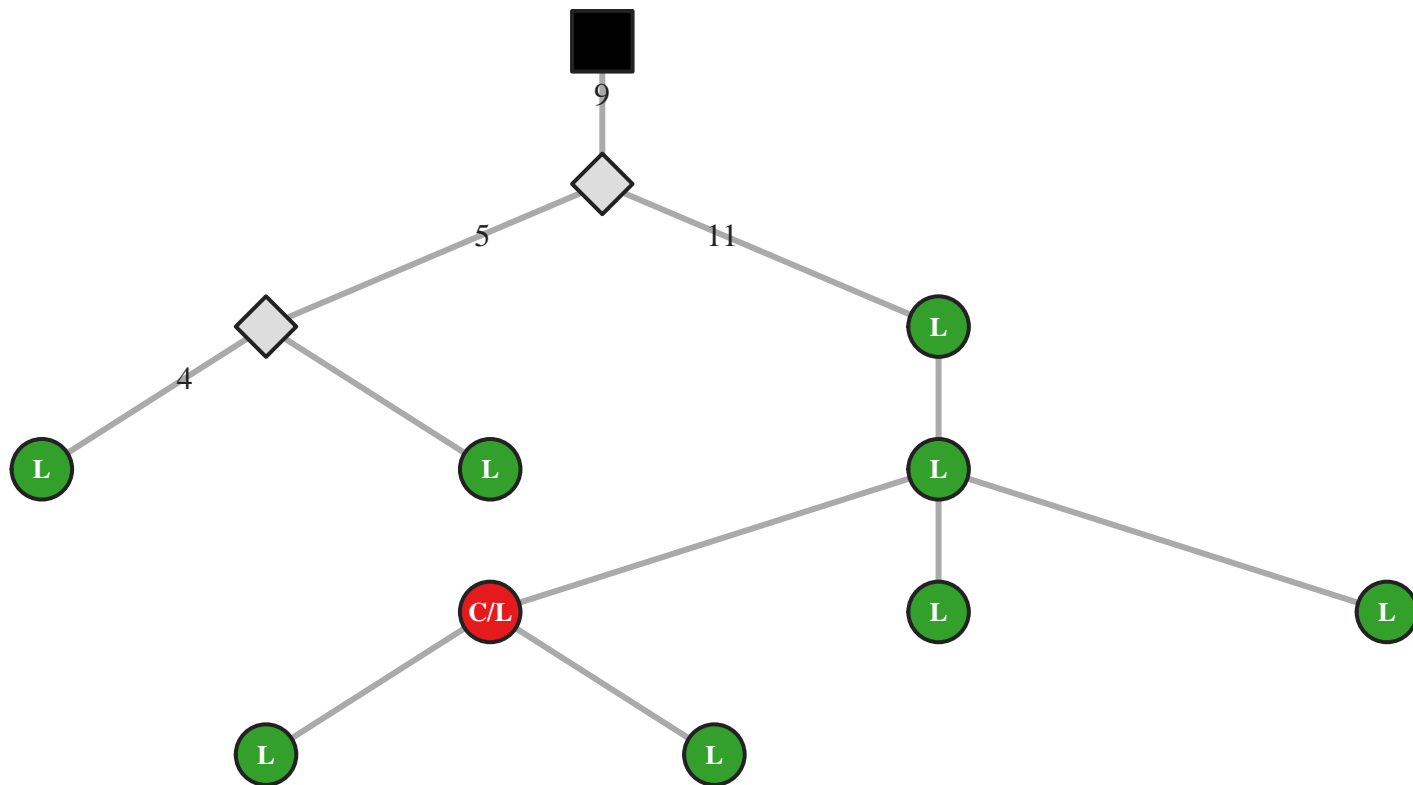

M5 IgA IGHV3-11/J4 39bp (2524)

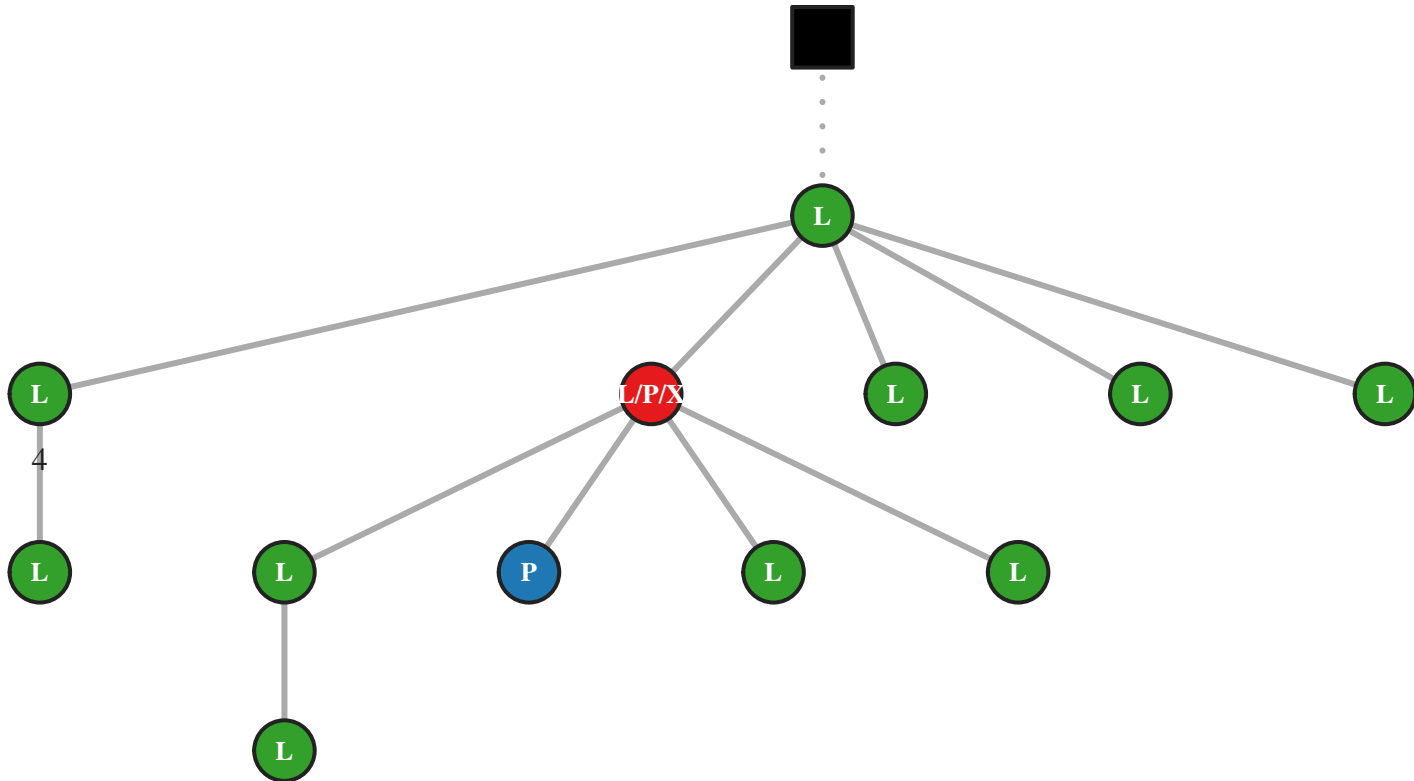

M5 IgG IGHV3-11/J4 39bp (50822)

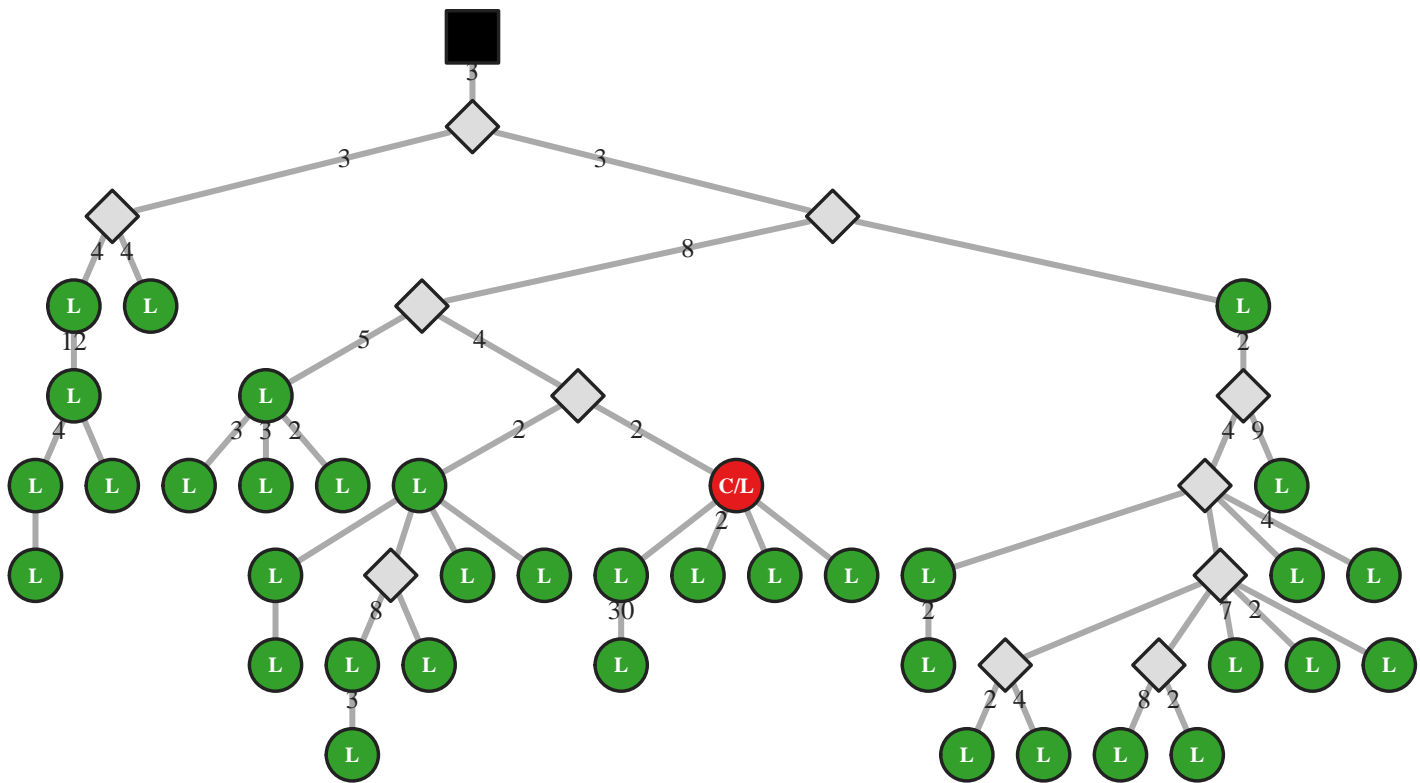

M5 IgG IGHV3-11/J4 39bp (50823)

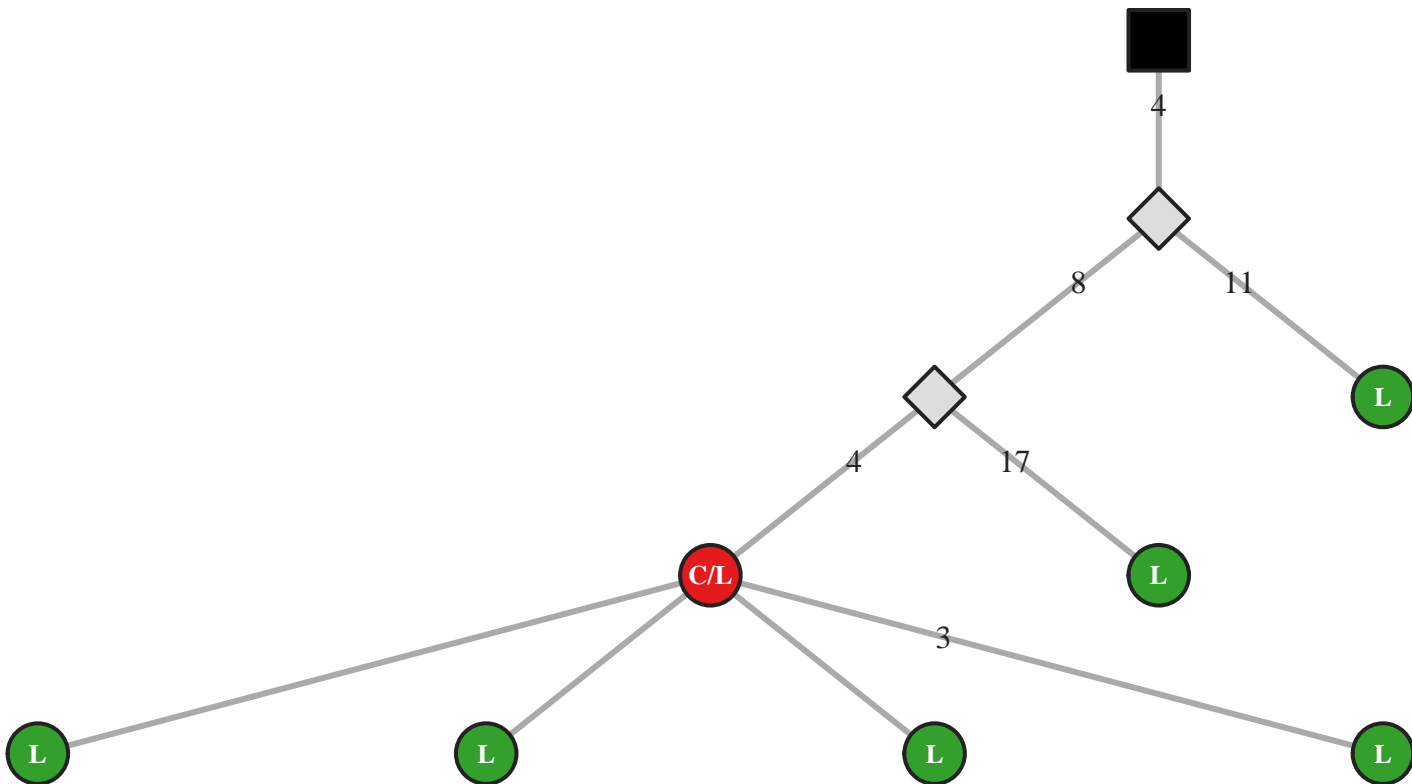

M5 IgG IGHV3-11/J4 42bp (24967)

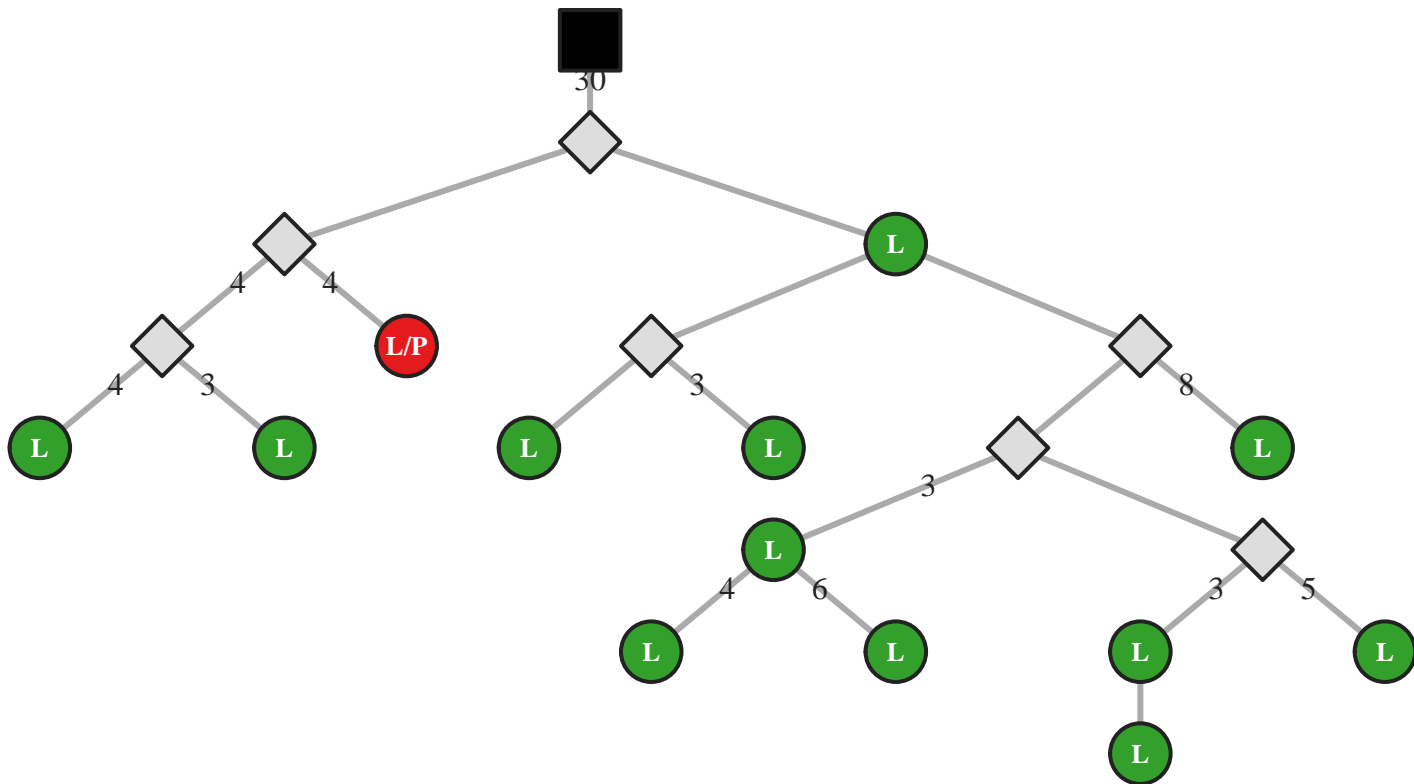

M5 IgG IGHV3-11/J4 45bp (50825)

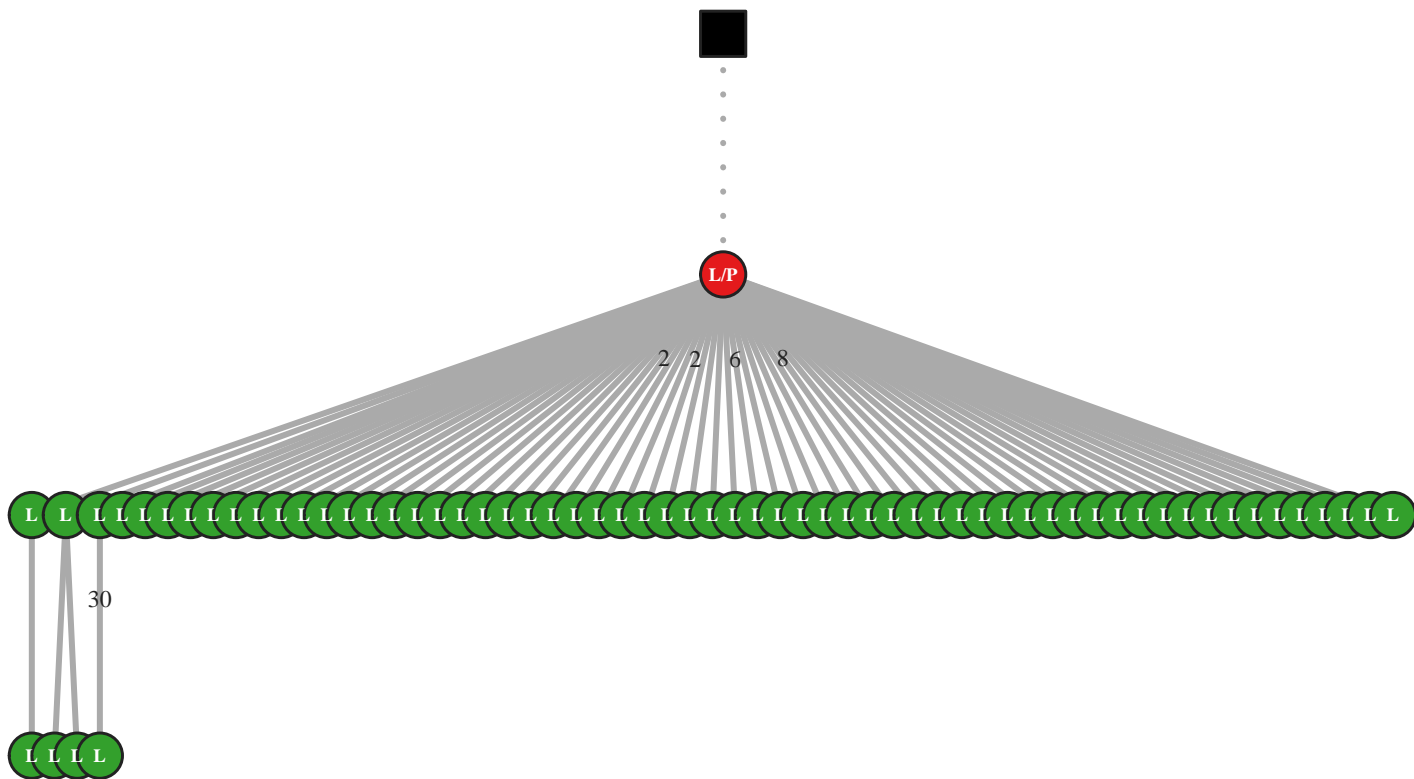

M5 IgG IGHV3-11/J4 45bp (50879)

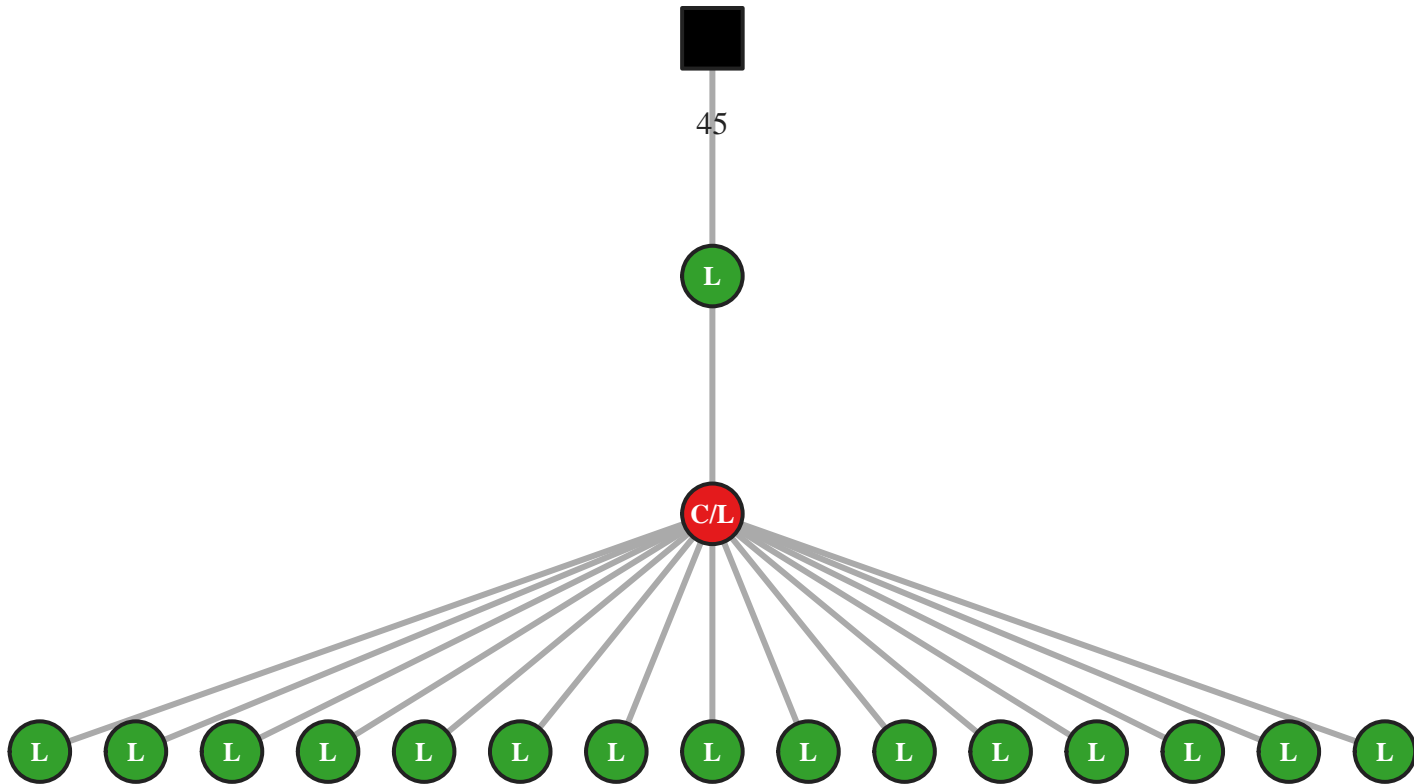

M5 IgA IGHV3-11/J4 48bp (21587)

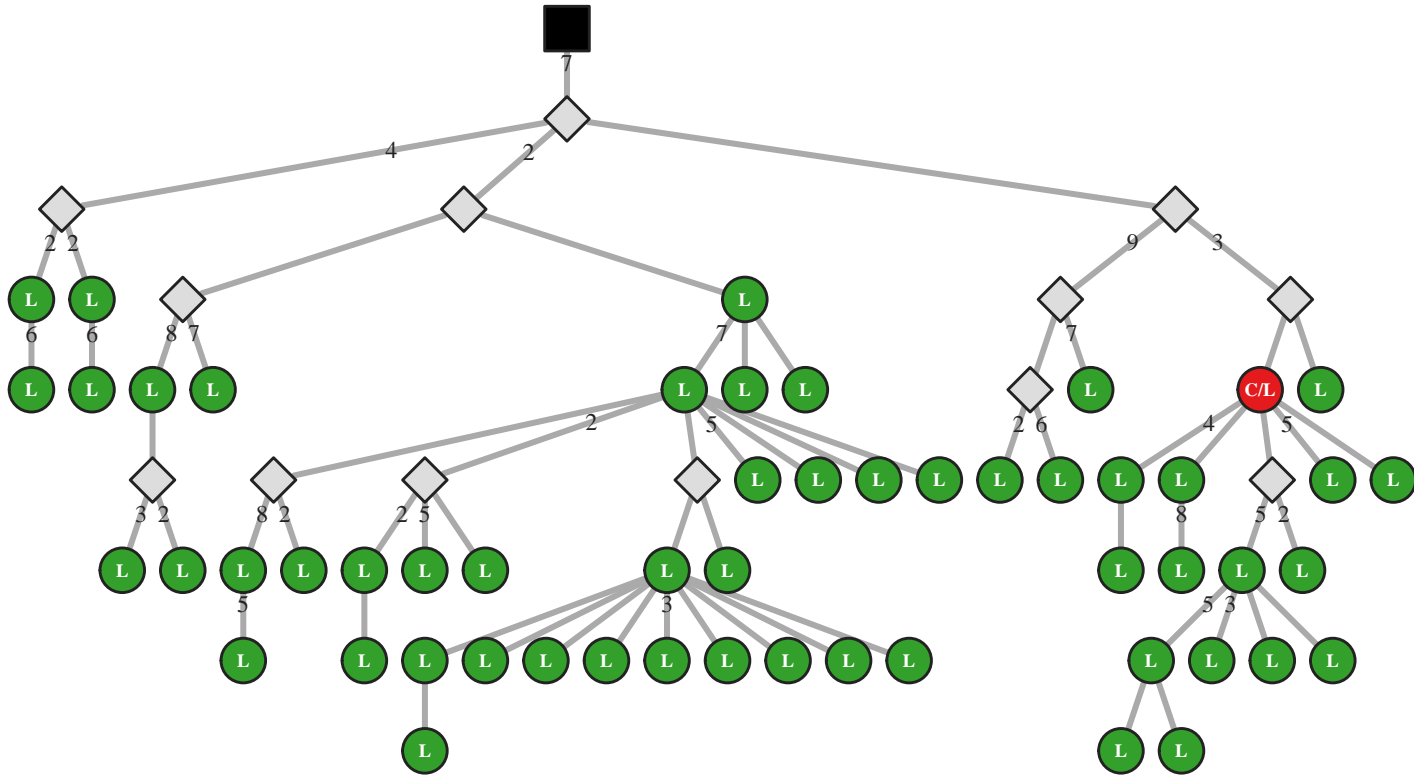

M5 IgG IGHV3-11/J4 48bp (50901)

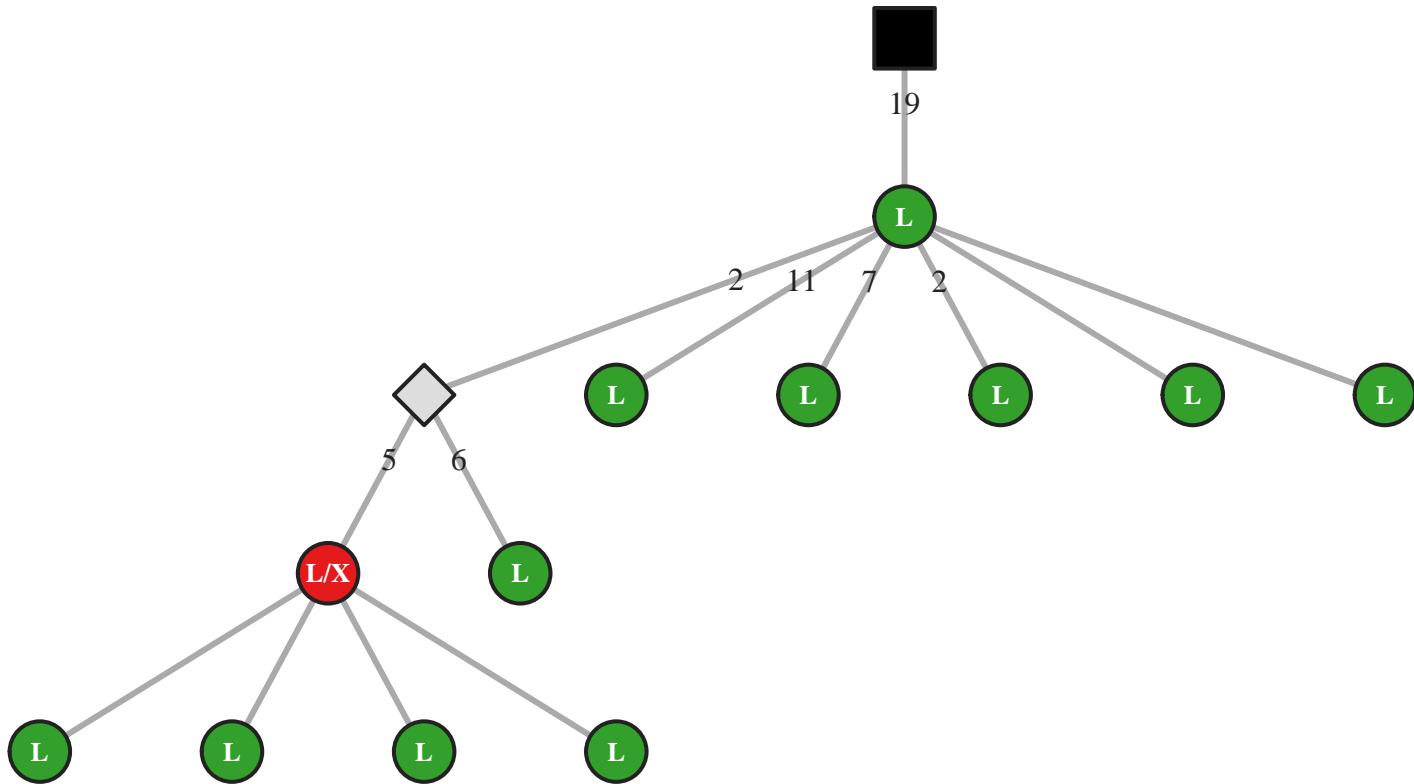

M5 IgG IGHV3-11/J4 51bp (43100)

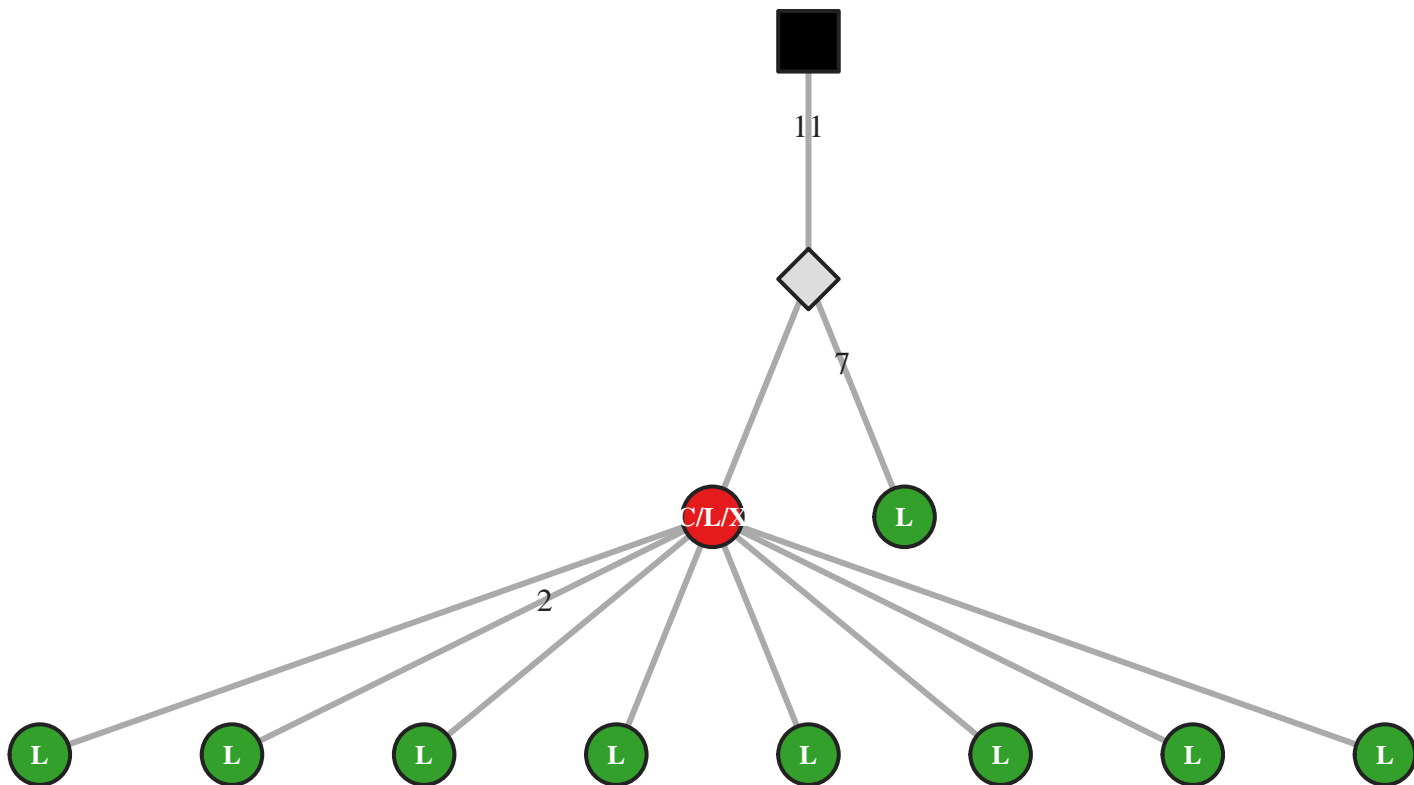

M5 IgG IGHV3-11/J4 51bp (43164)

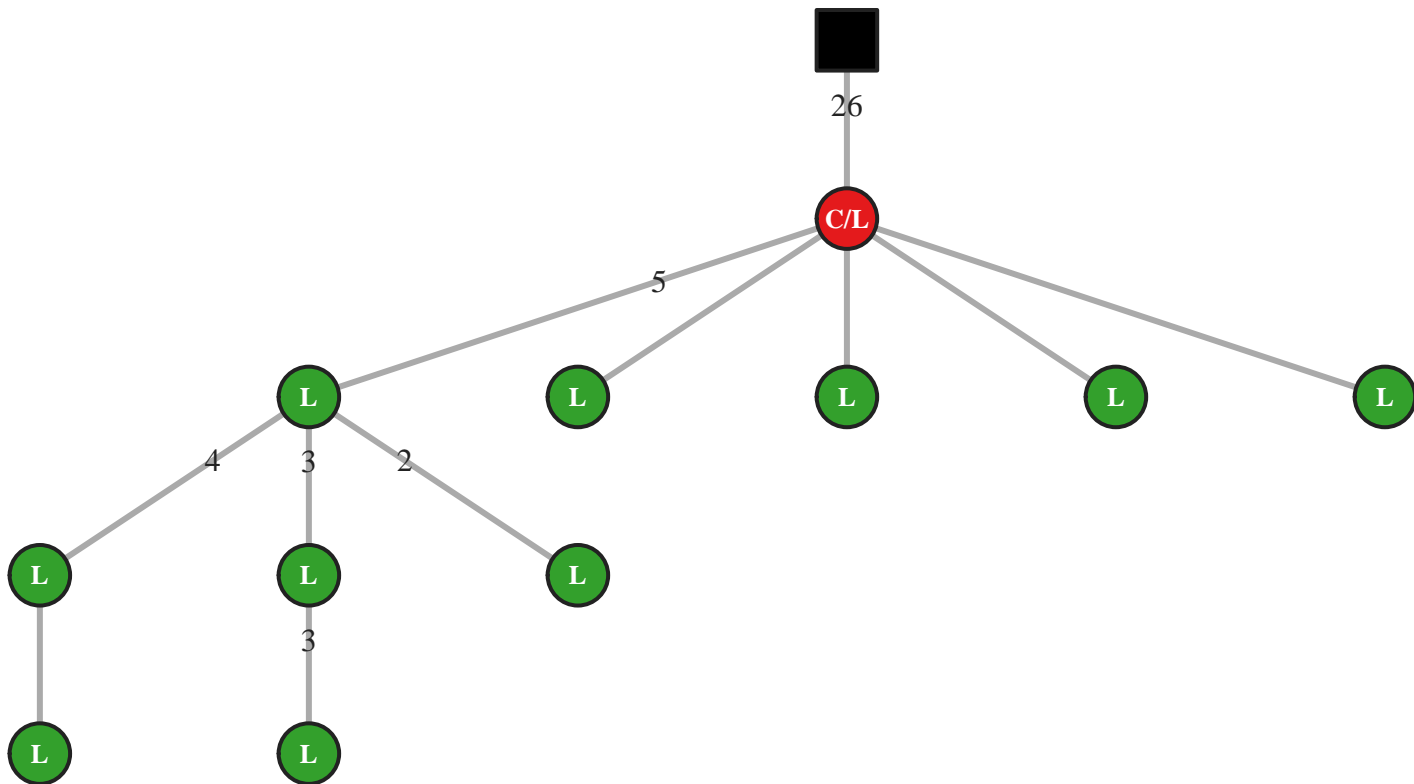

M5 IgG IGHV3-11/J4 51bp (43166)

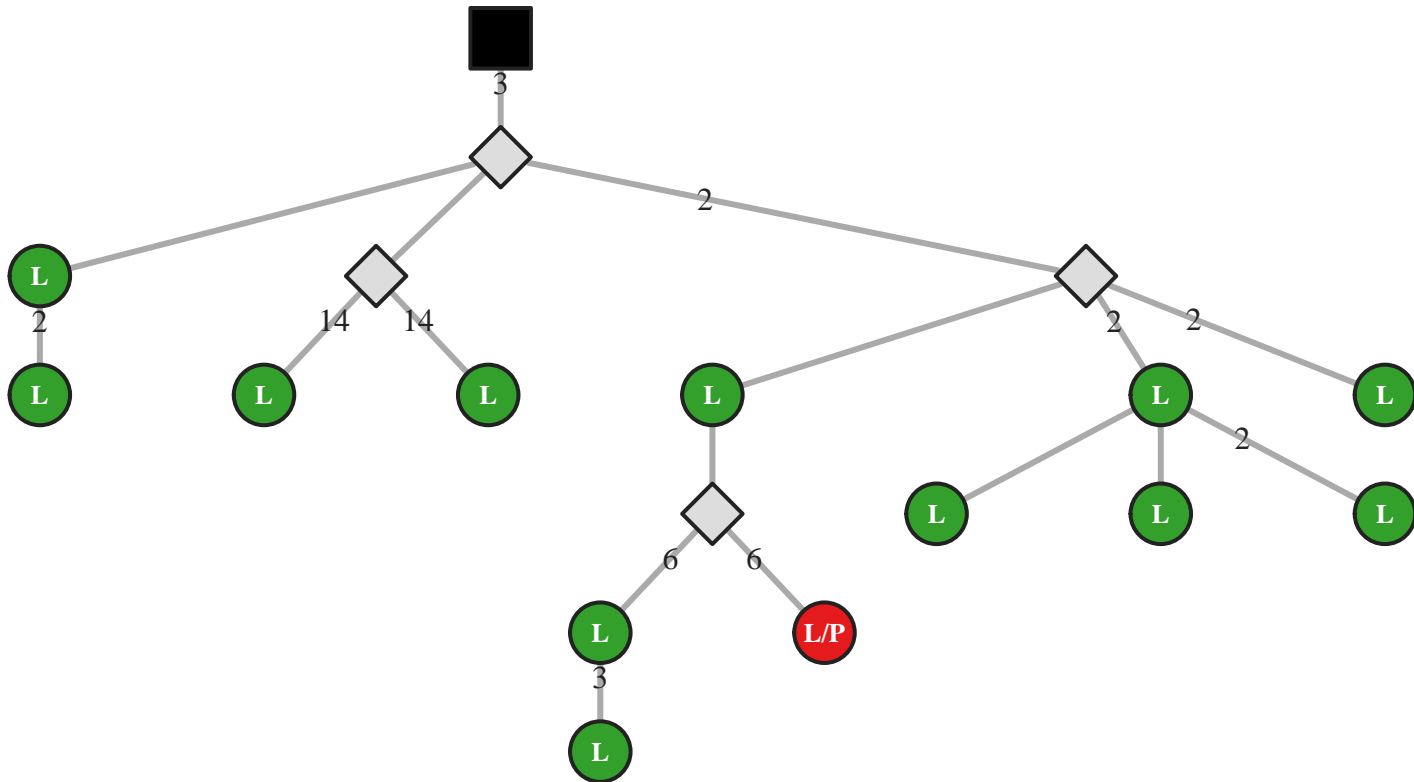

M5 IgA IGHV3-11/J4 54bp (2540)

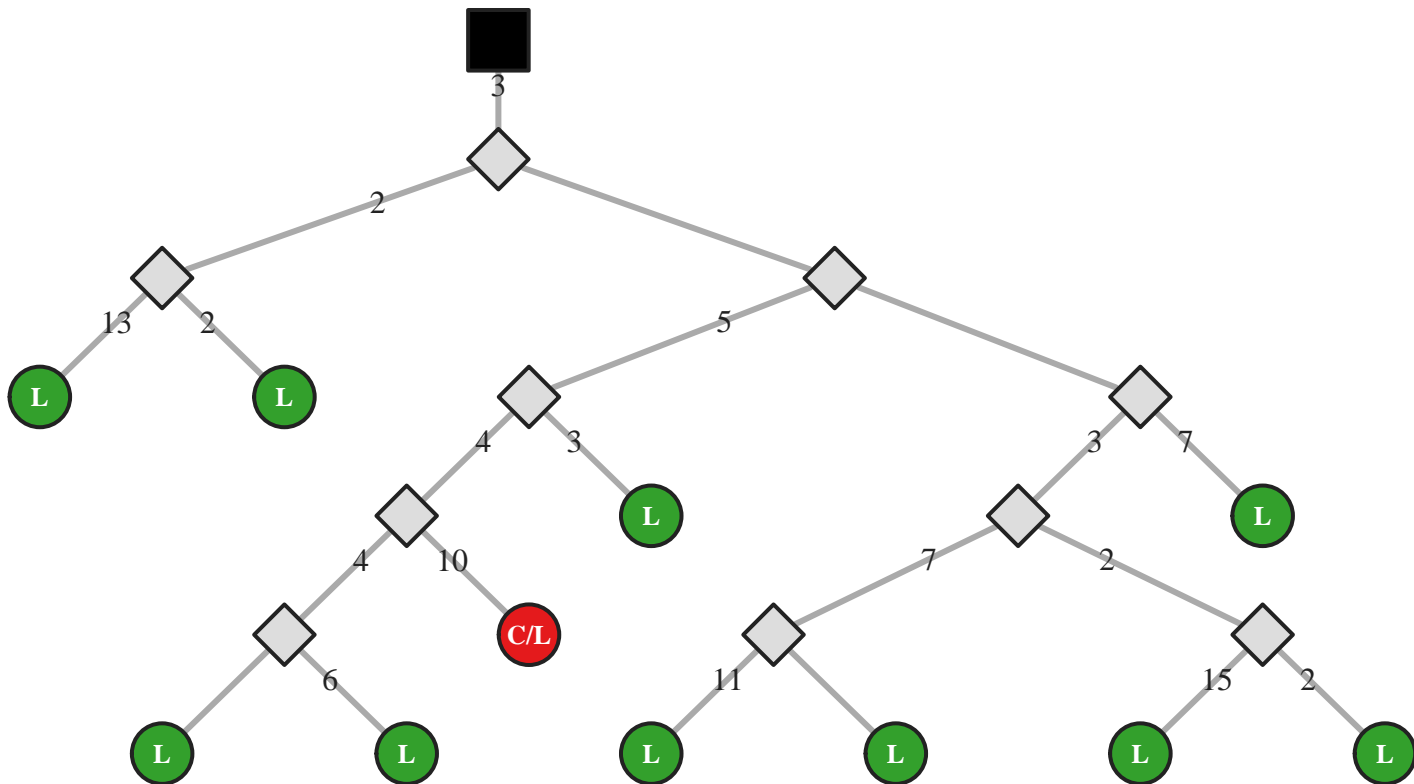

M5 IgG IGHV3-11/J4 54bp (15950)

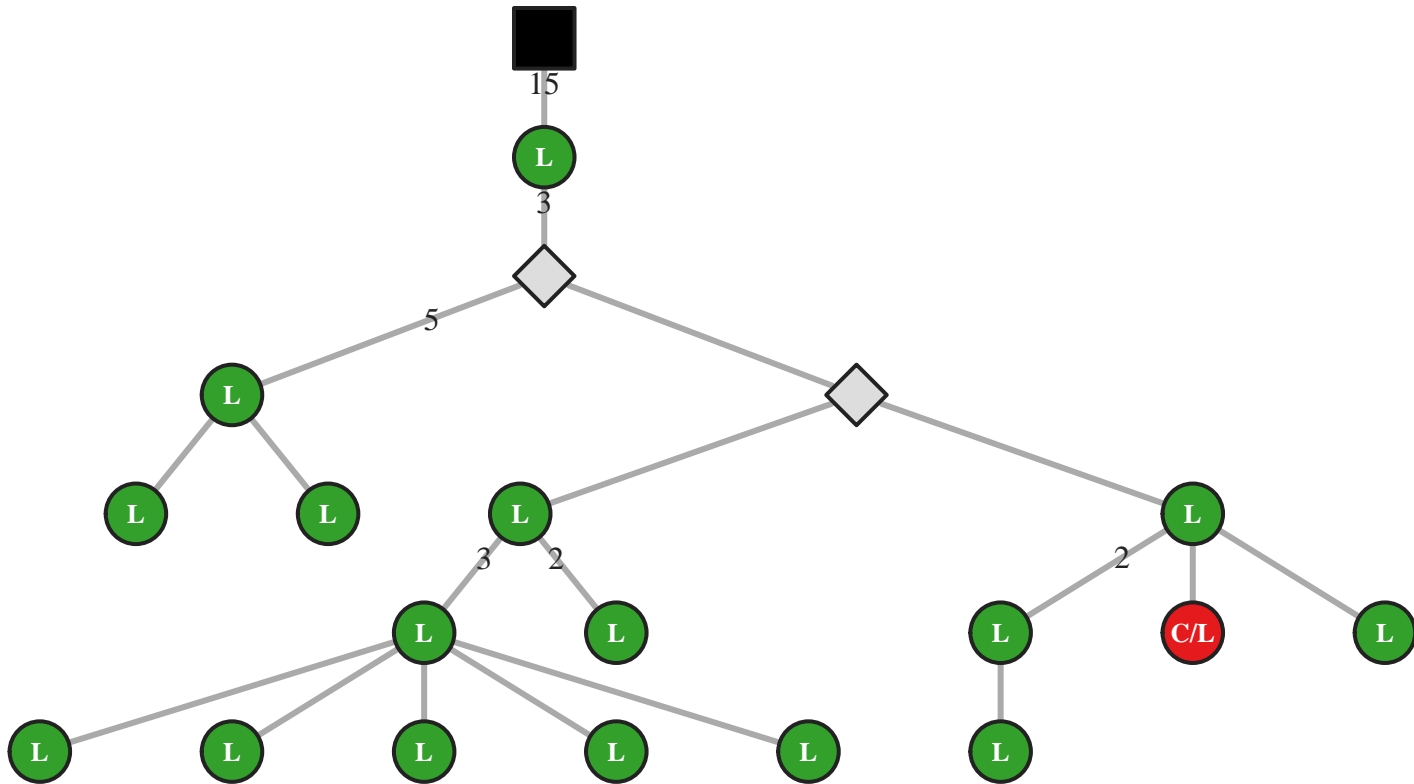

M5 IgG IGHV3-11/J4 54bp (15985)

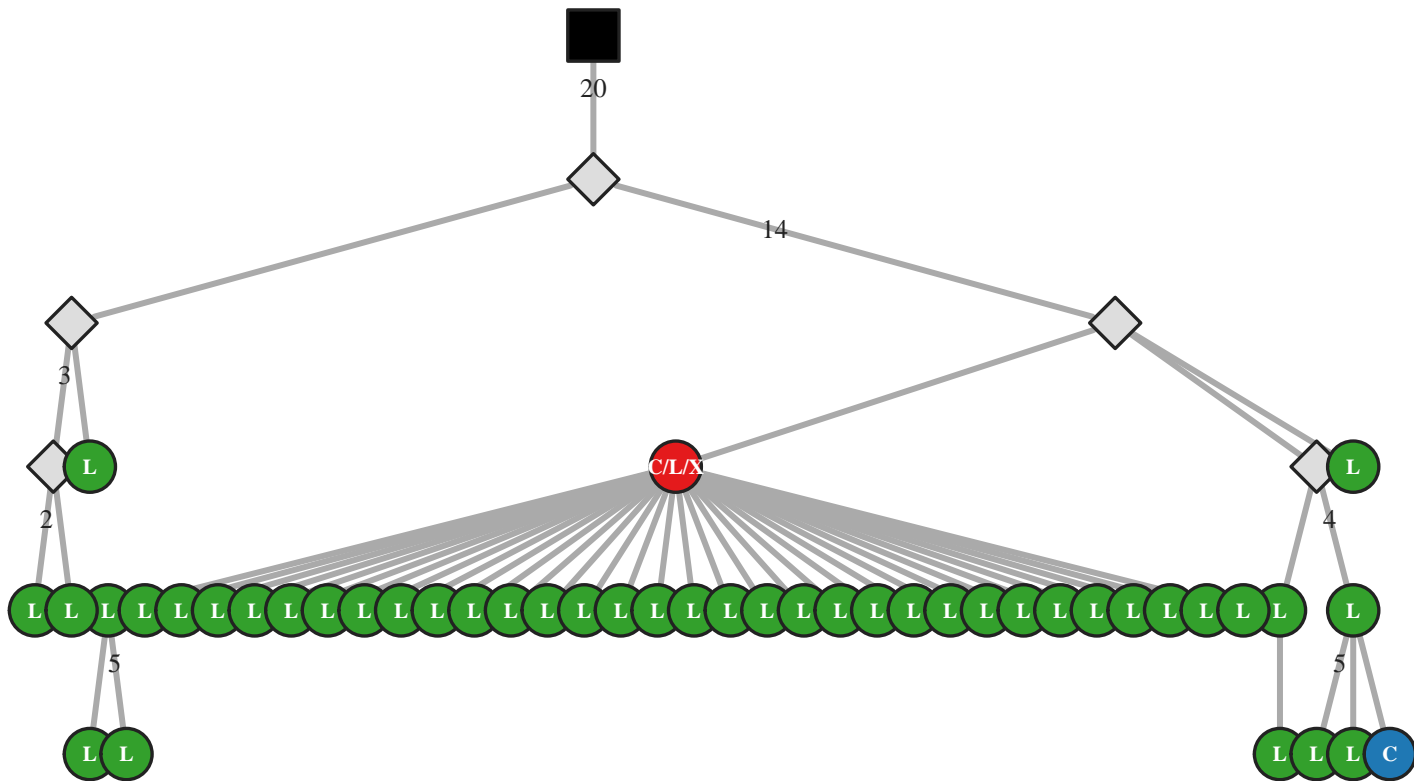

M5 IgG IGHV3-11/J4 63bp (16021)

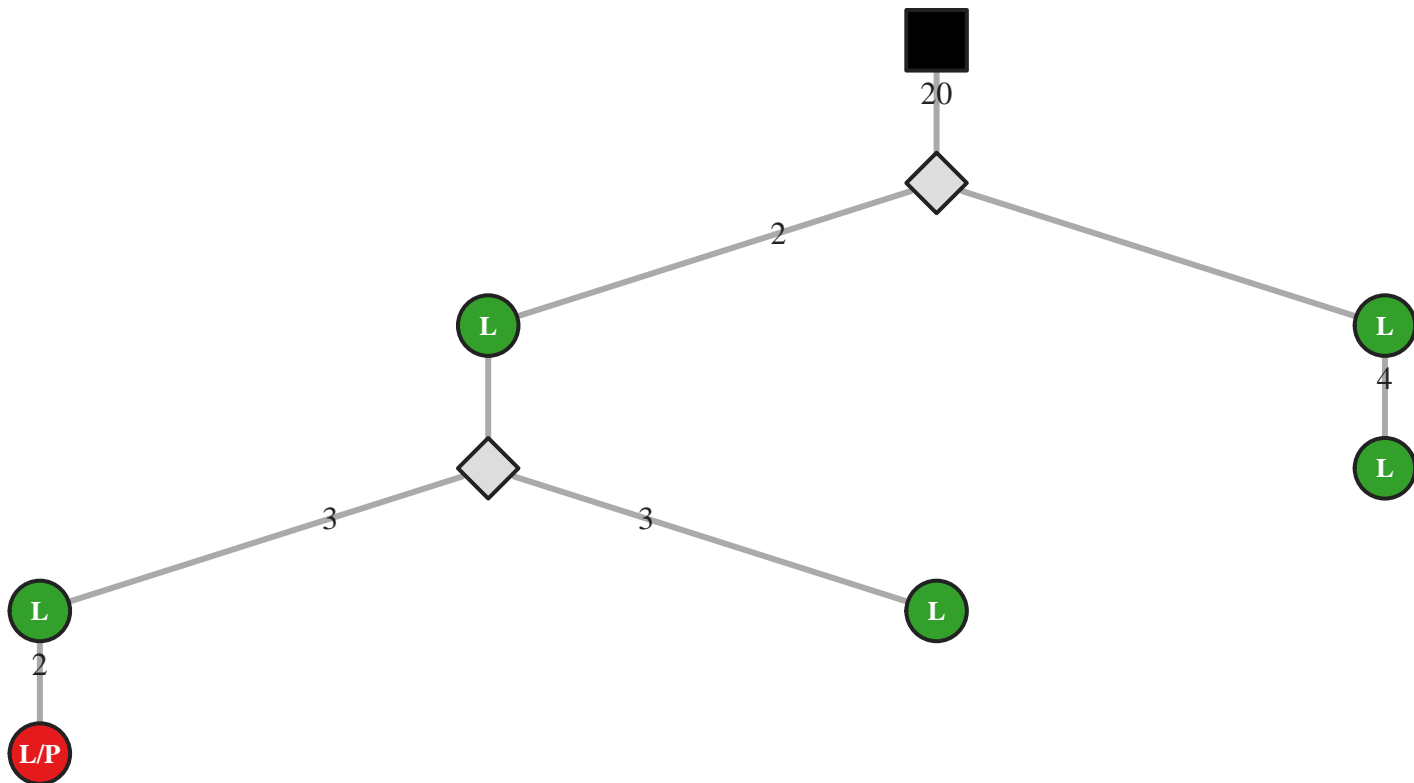

M5 IgG IGHV3-11/J4 66bp (50976)

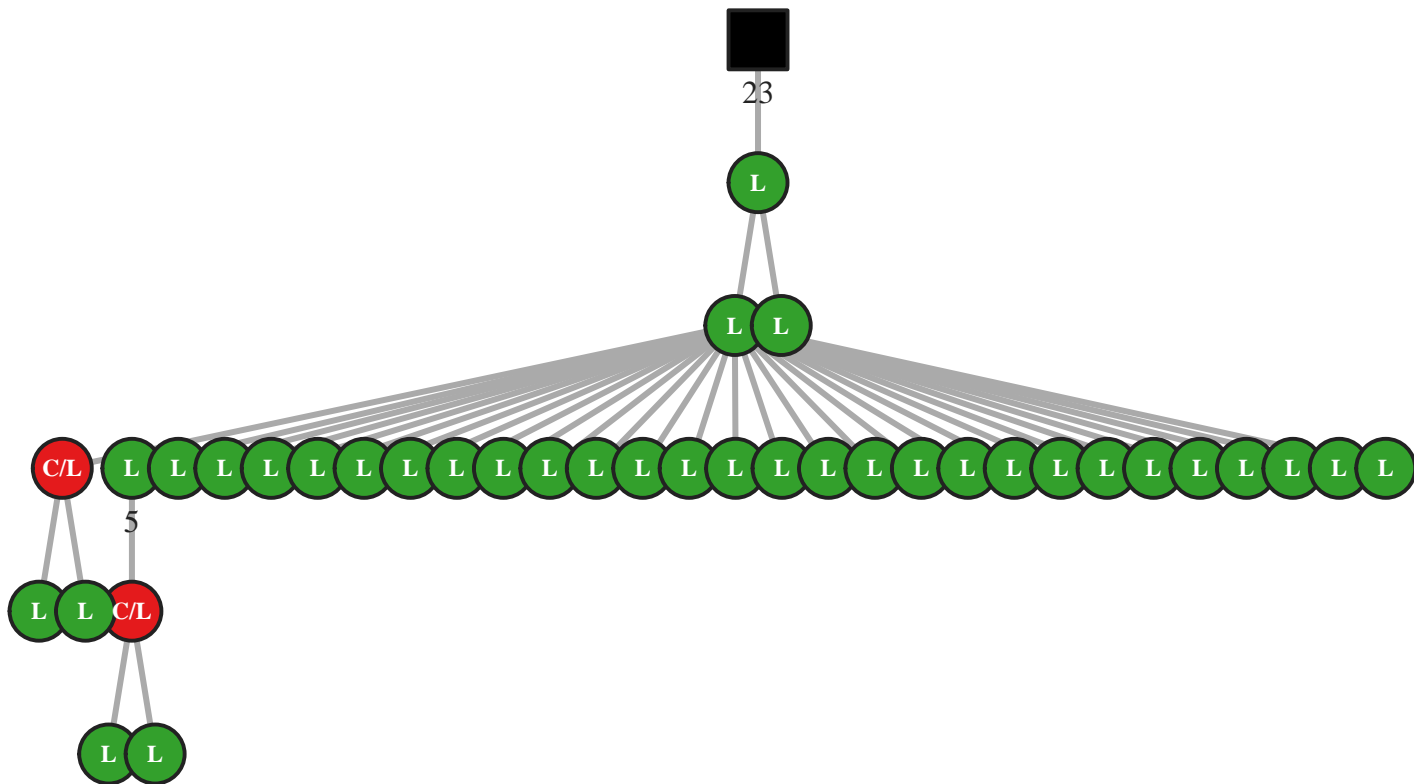

M5 IgG IGHV3-11/J5 51bp (43230)

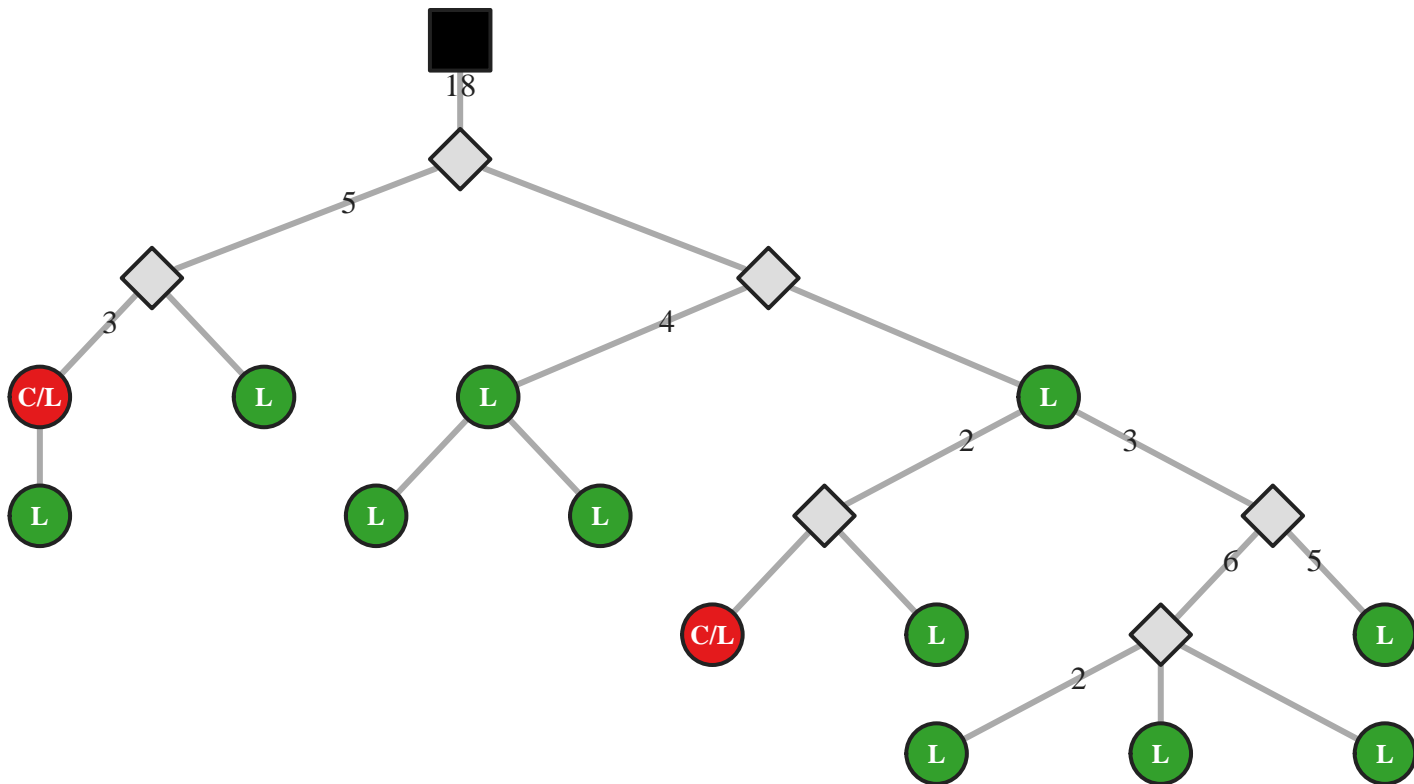

M5 IgG IGHV3-11/J5 60bp (33872)

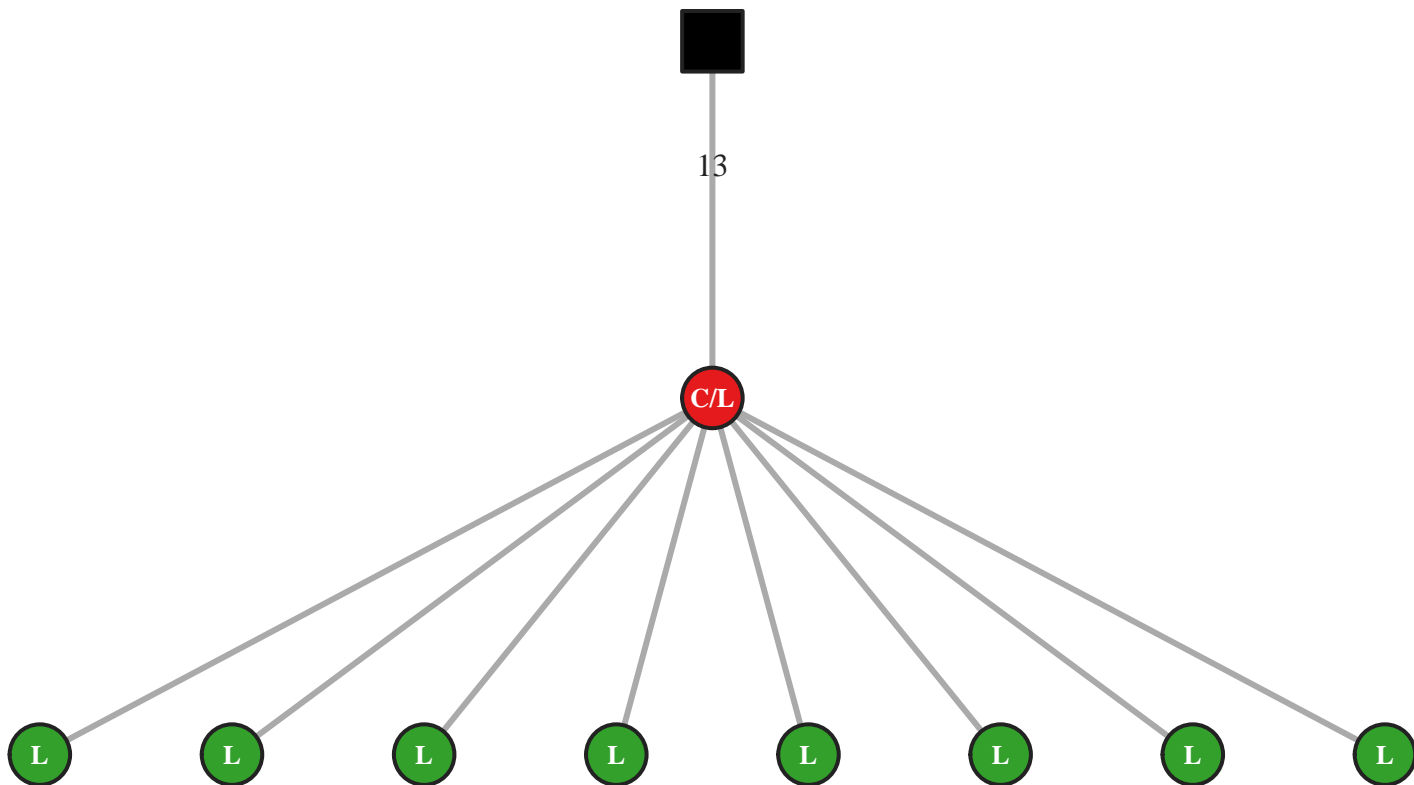

M5 IgG IGHV3-11/J6 48bp (50987)

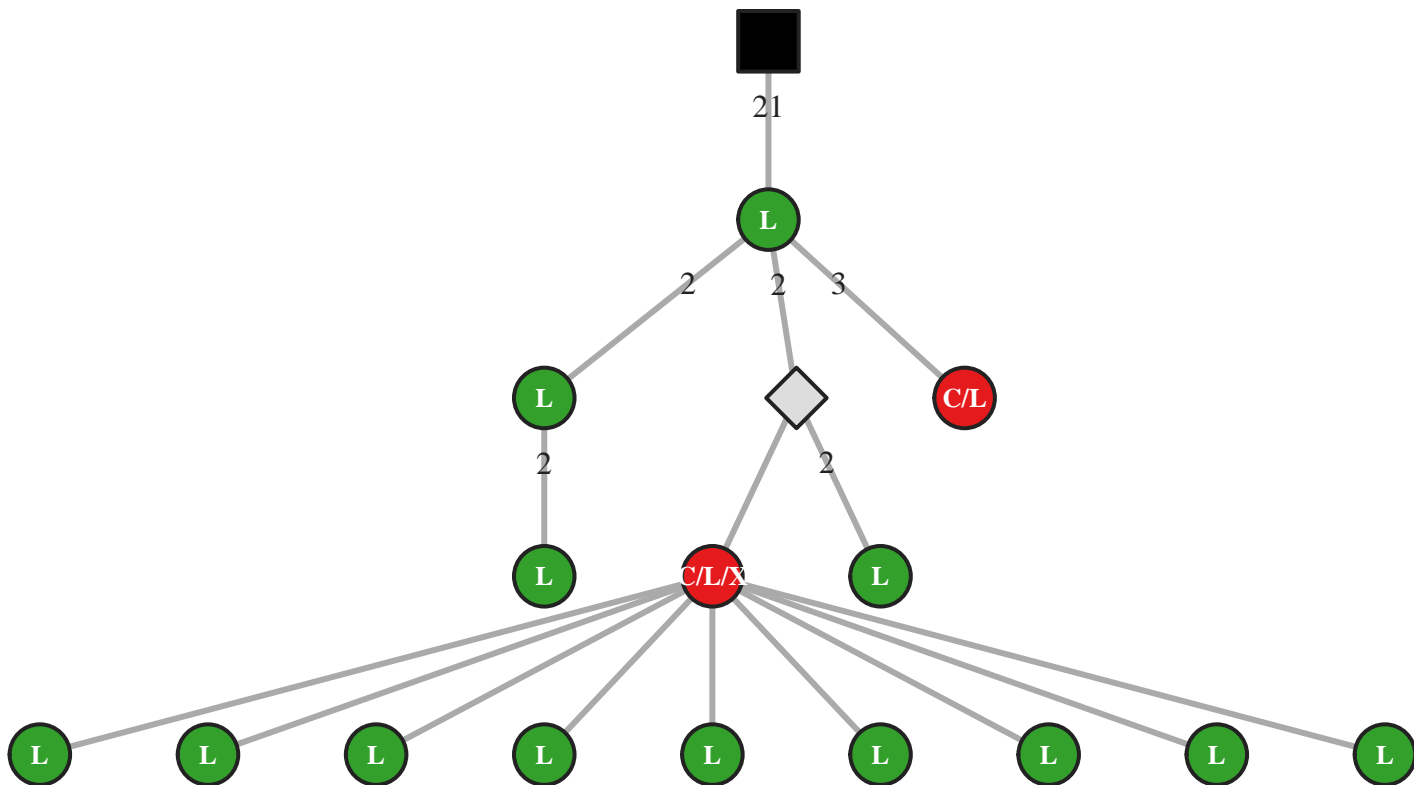

M5 IgA IGHV3-11/J6 54bp (30440)

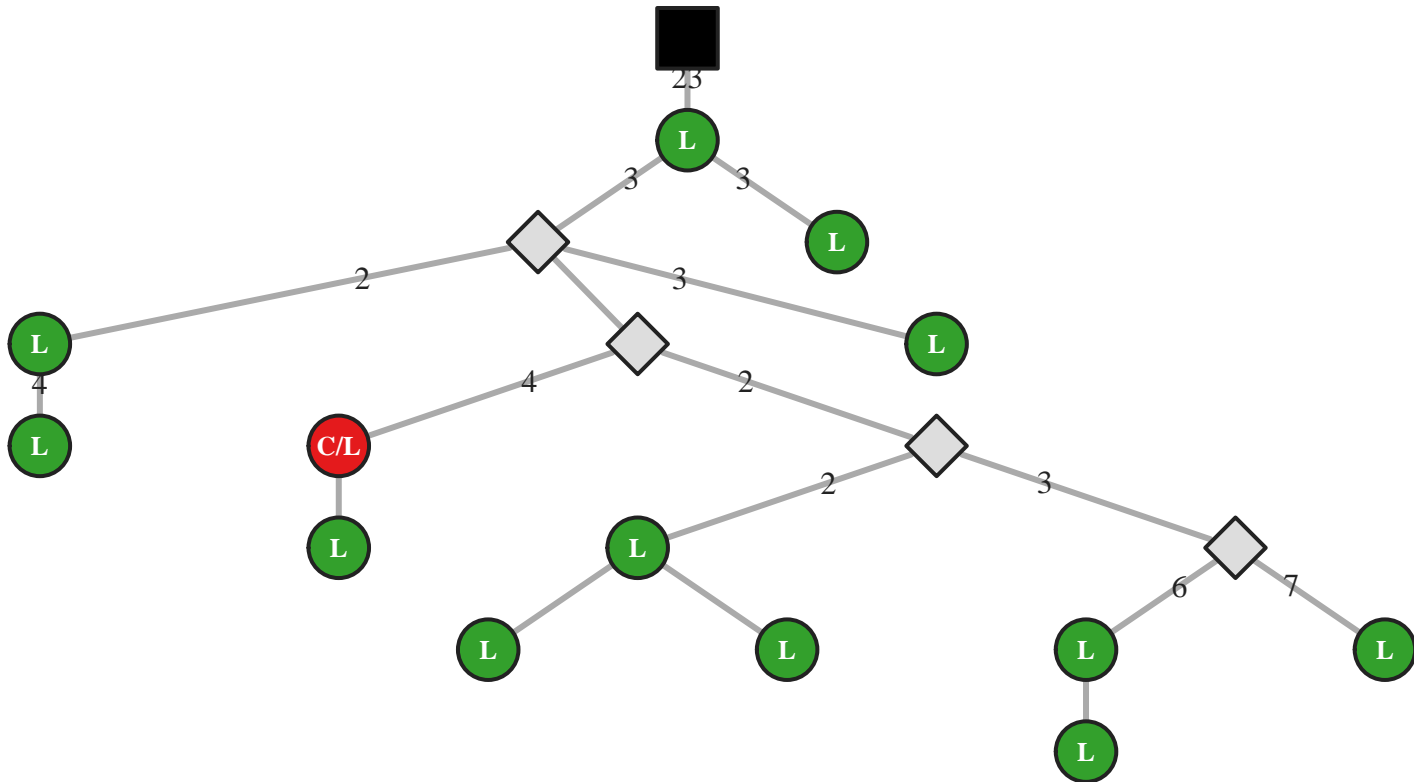

M5 IgG IGHV3-11/J6 60bp (16035)

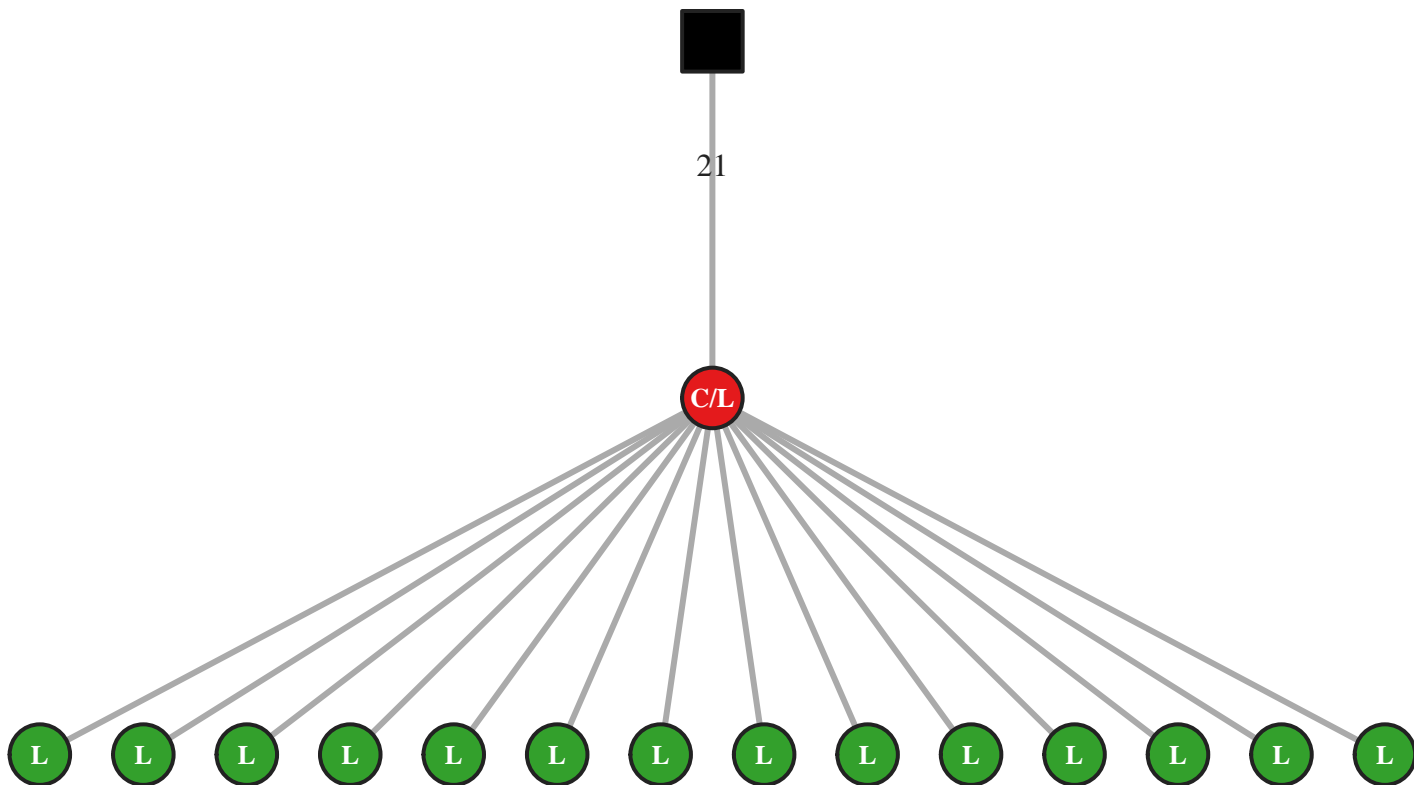

M5 IgG IGHV3-11/J6 60bp (16047)

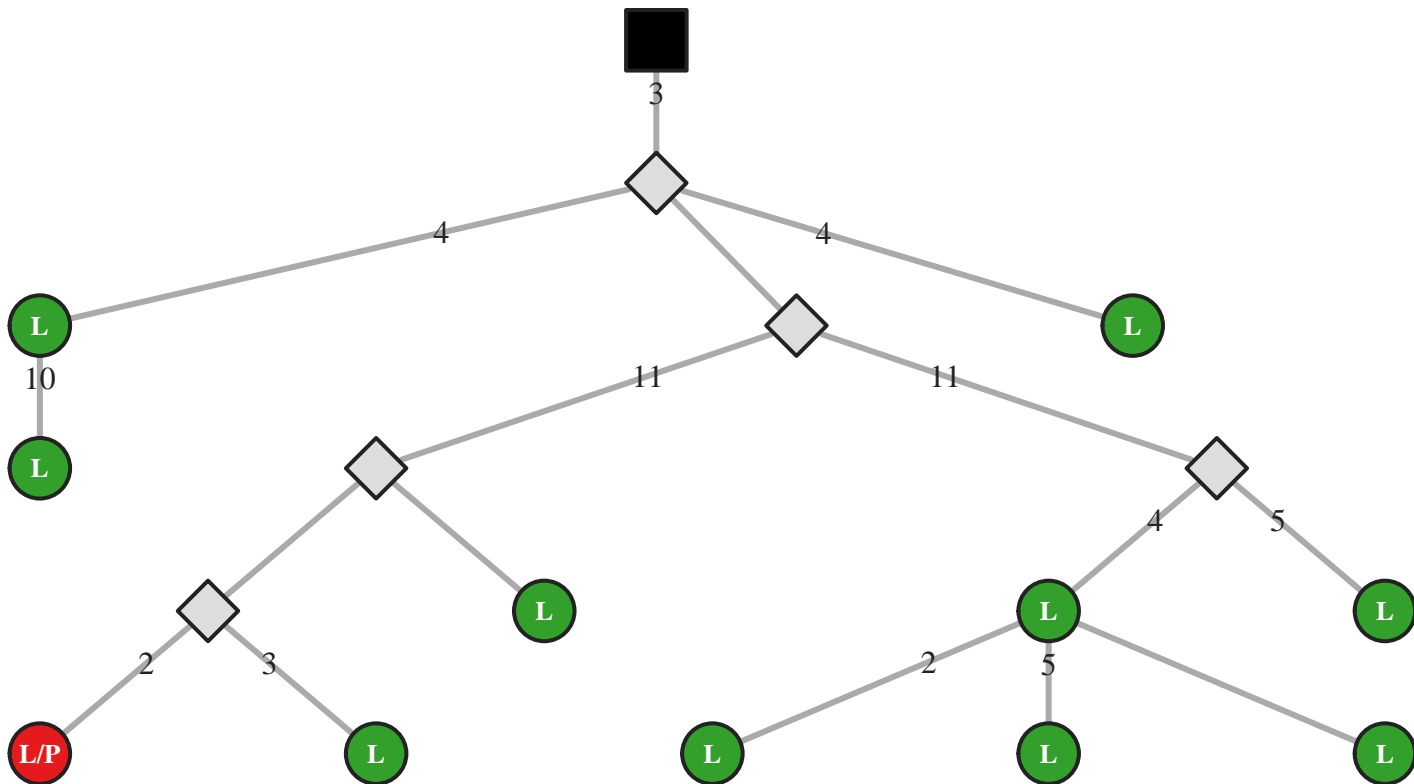

M5 IgG IGHV3-11/J6 63bp (16085)

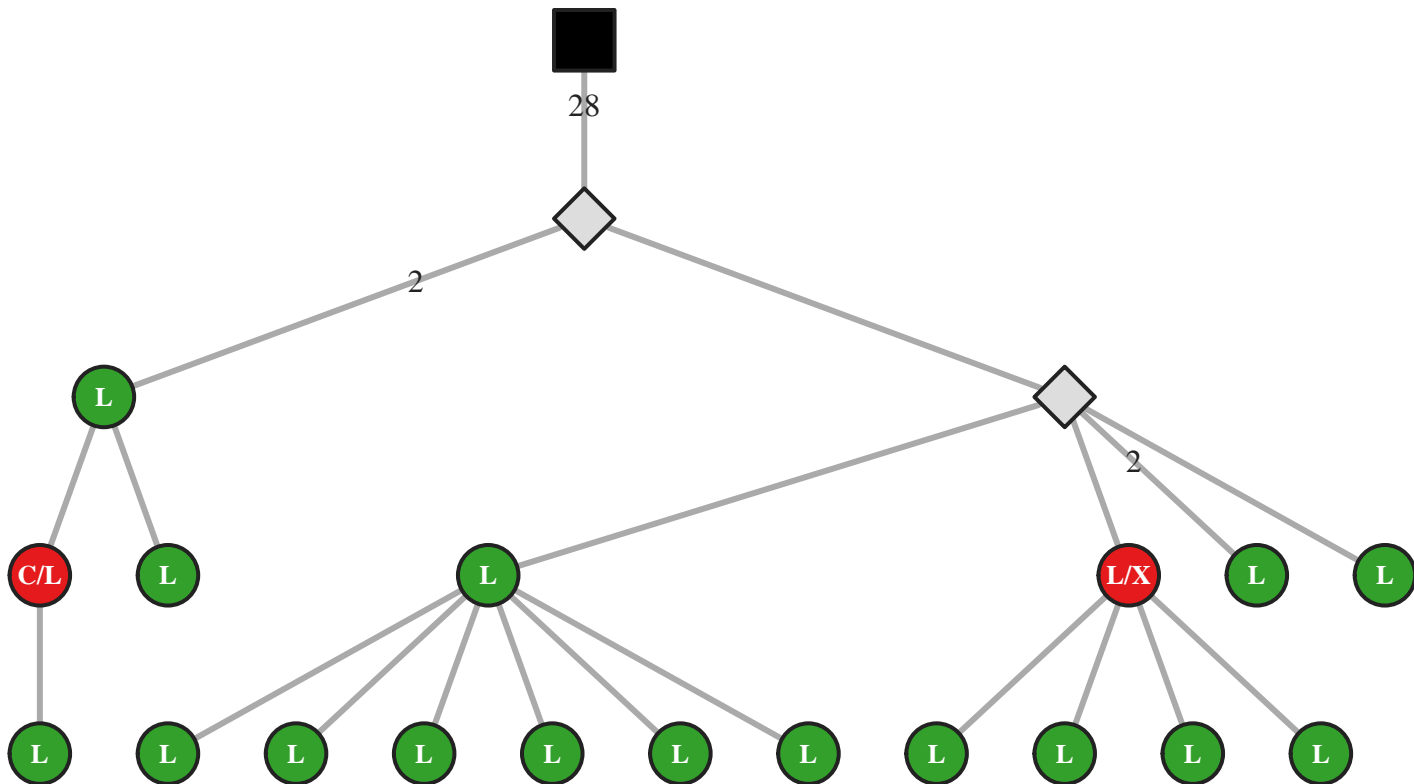

M5 IgG IGHV3-11/J6 63bp (16098)

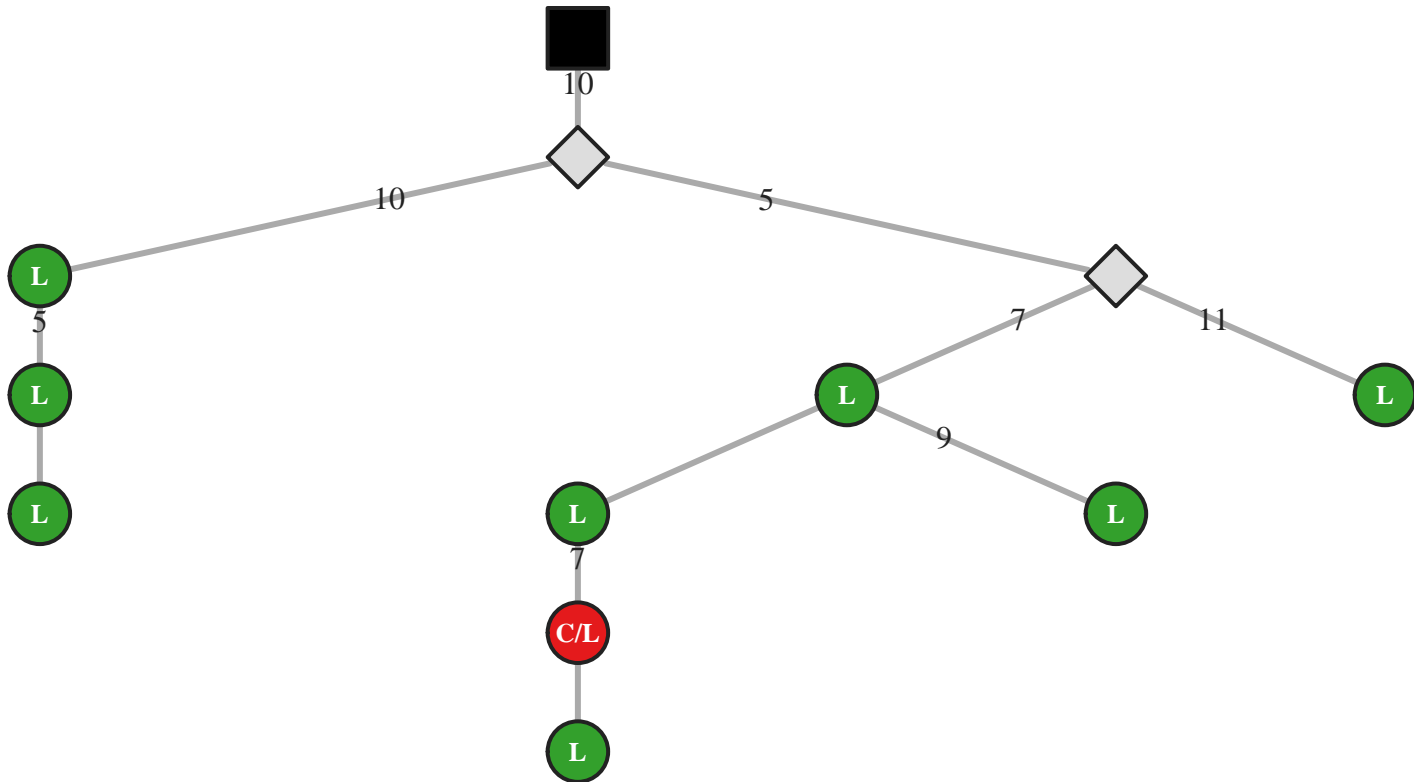

M5 IgM IGHV3-13/J4 39bp (11271)

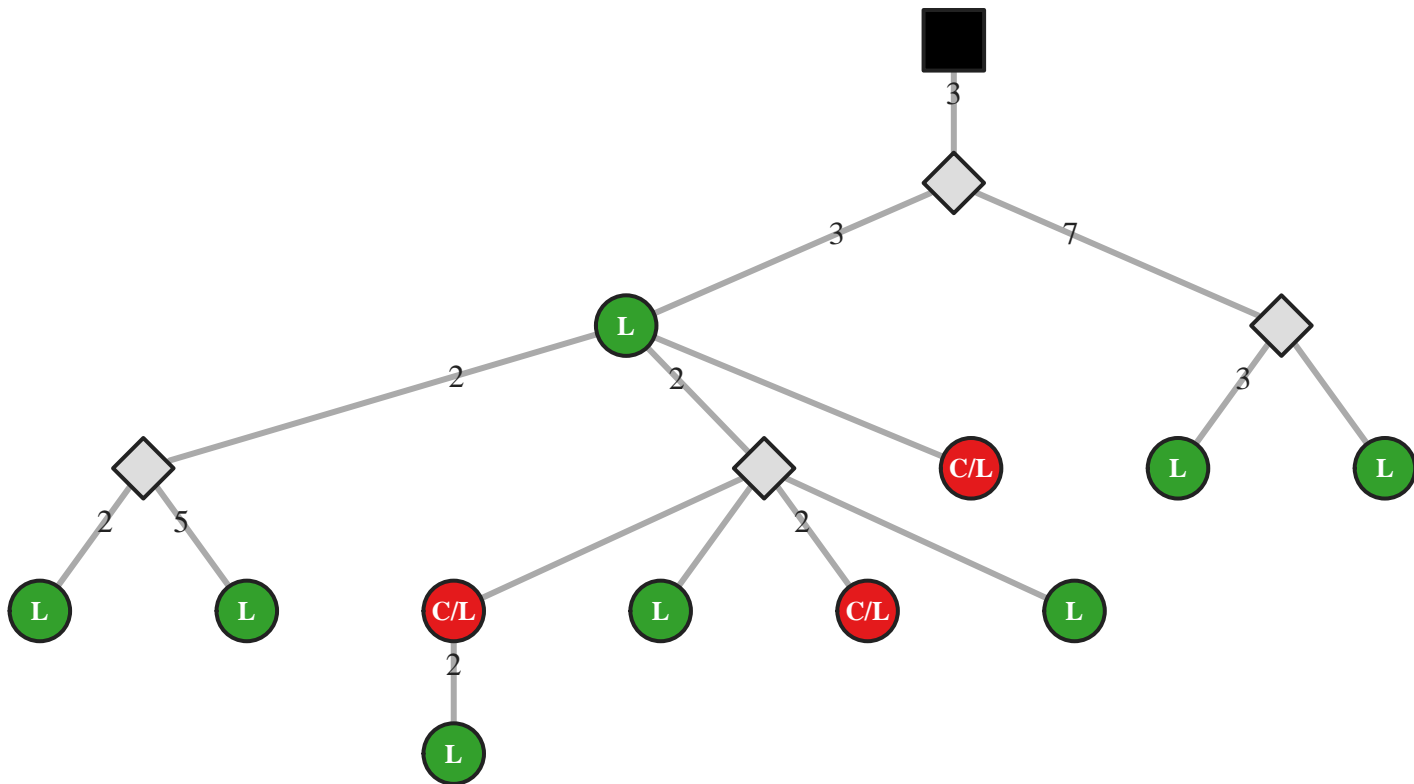

M5 IgM IGHV3-13/J4 54bp (20580)

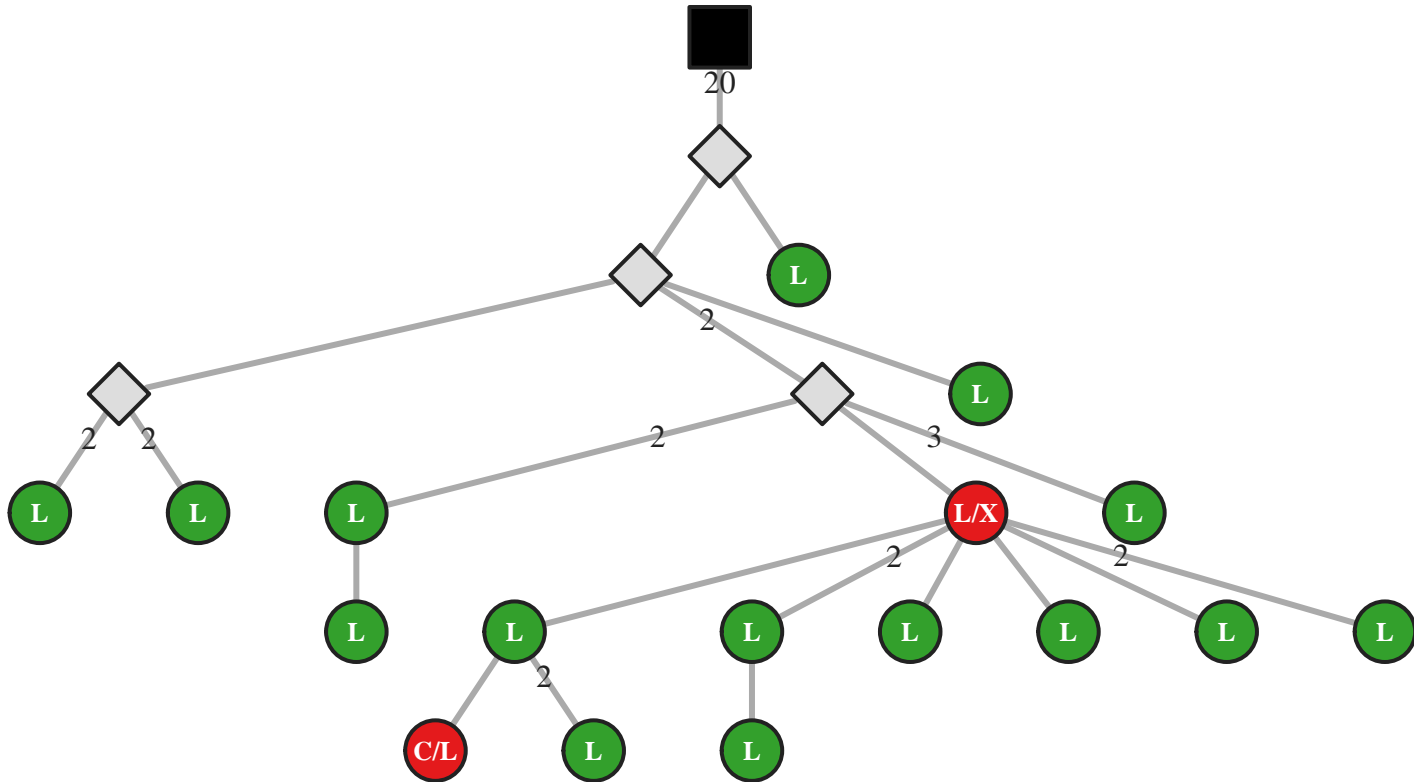

M5 IgM IGHV3-13/J6 57bp (20588)

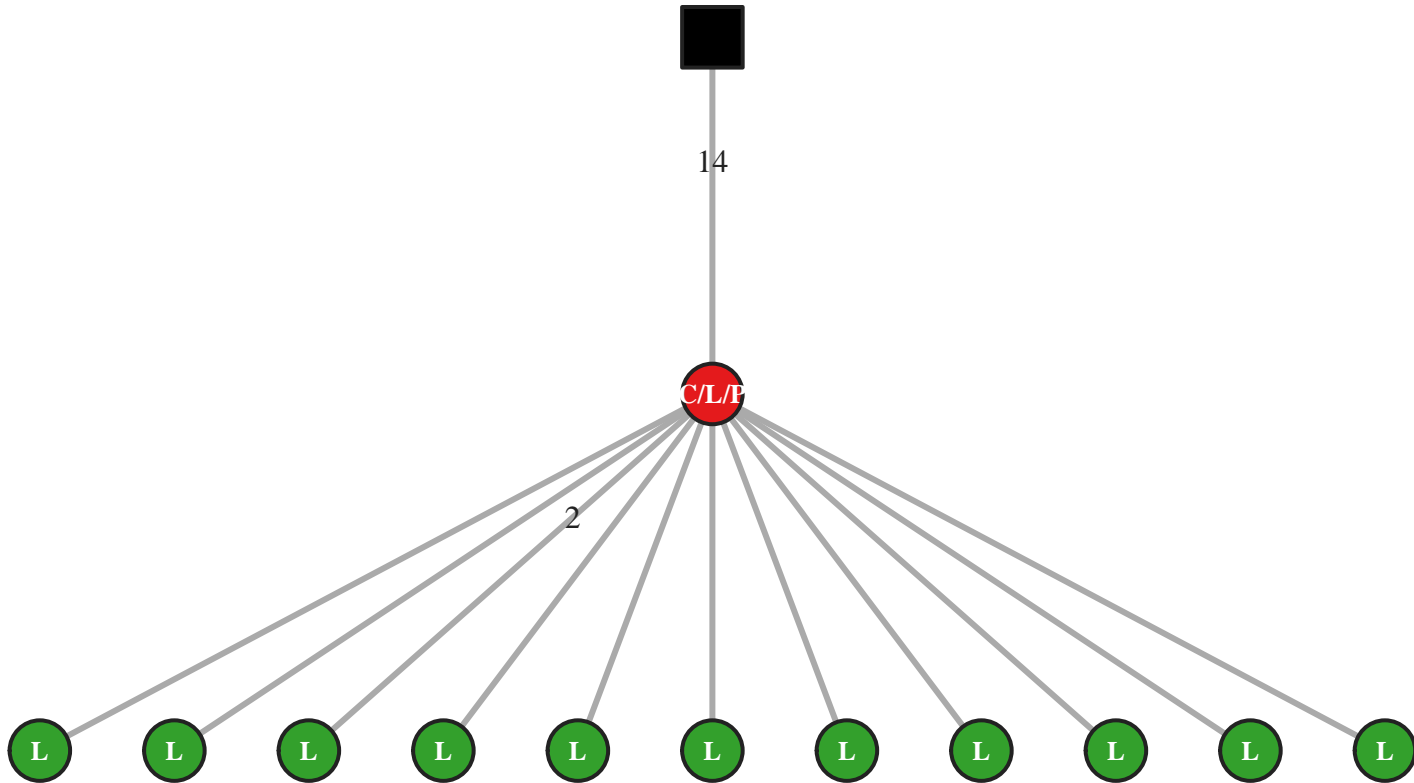

M5 IgG IGHV3-15/J3 30bp (25035)

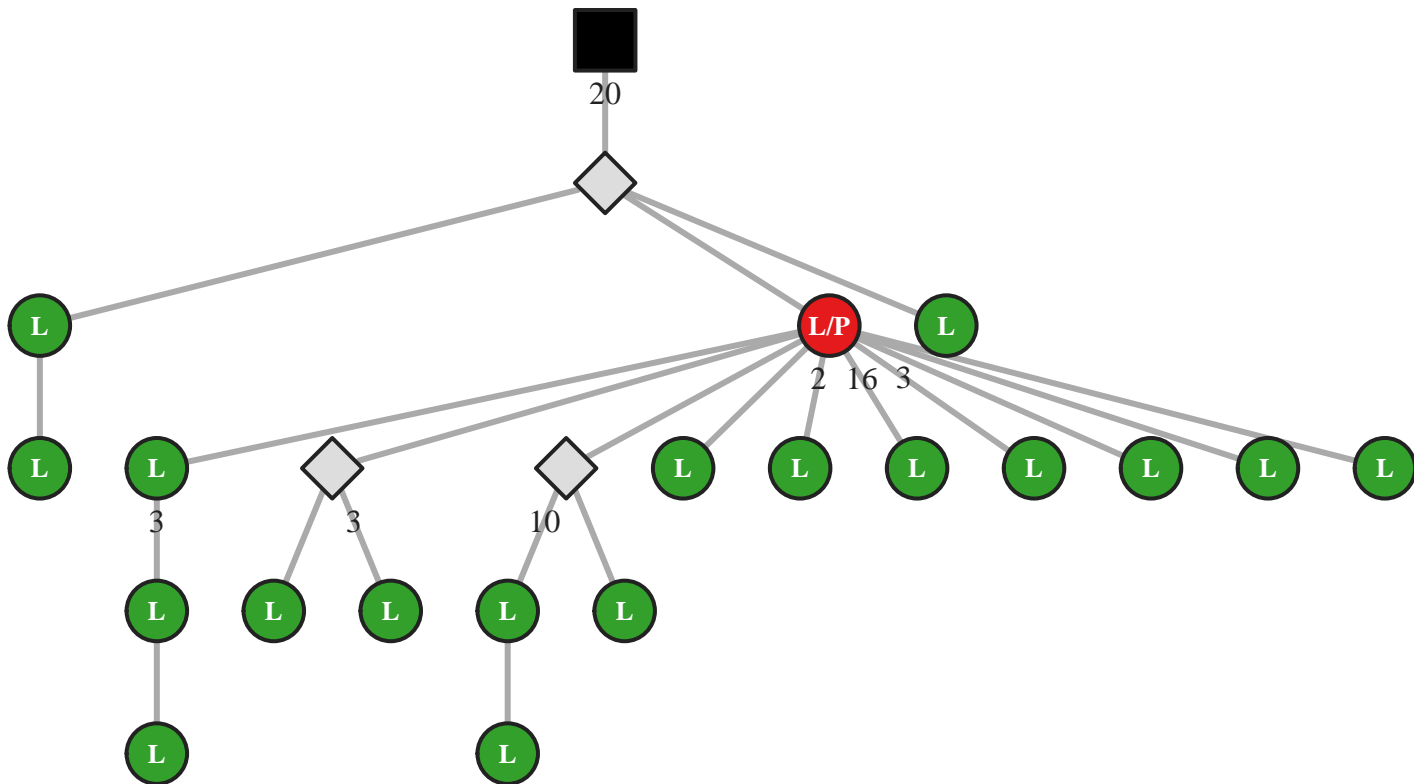

M5 IgG IGHV3-15/J4 27bp (25051)

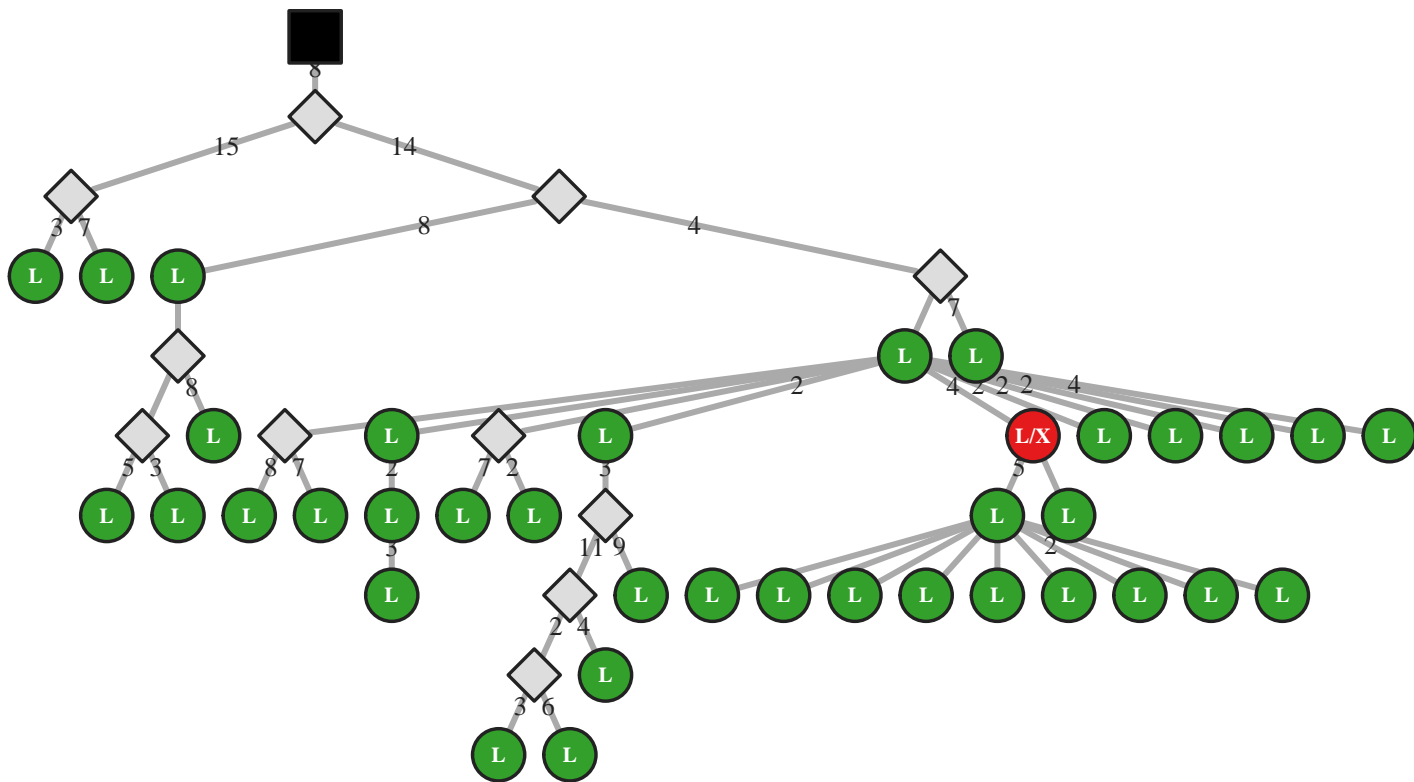

M5 IgA IGHV3-15/J4 33bp (12207)

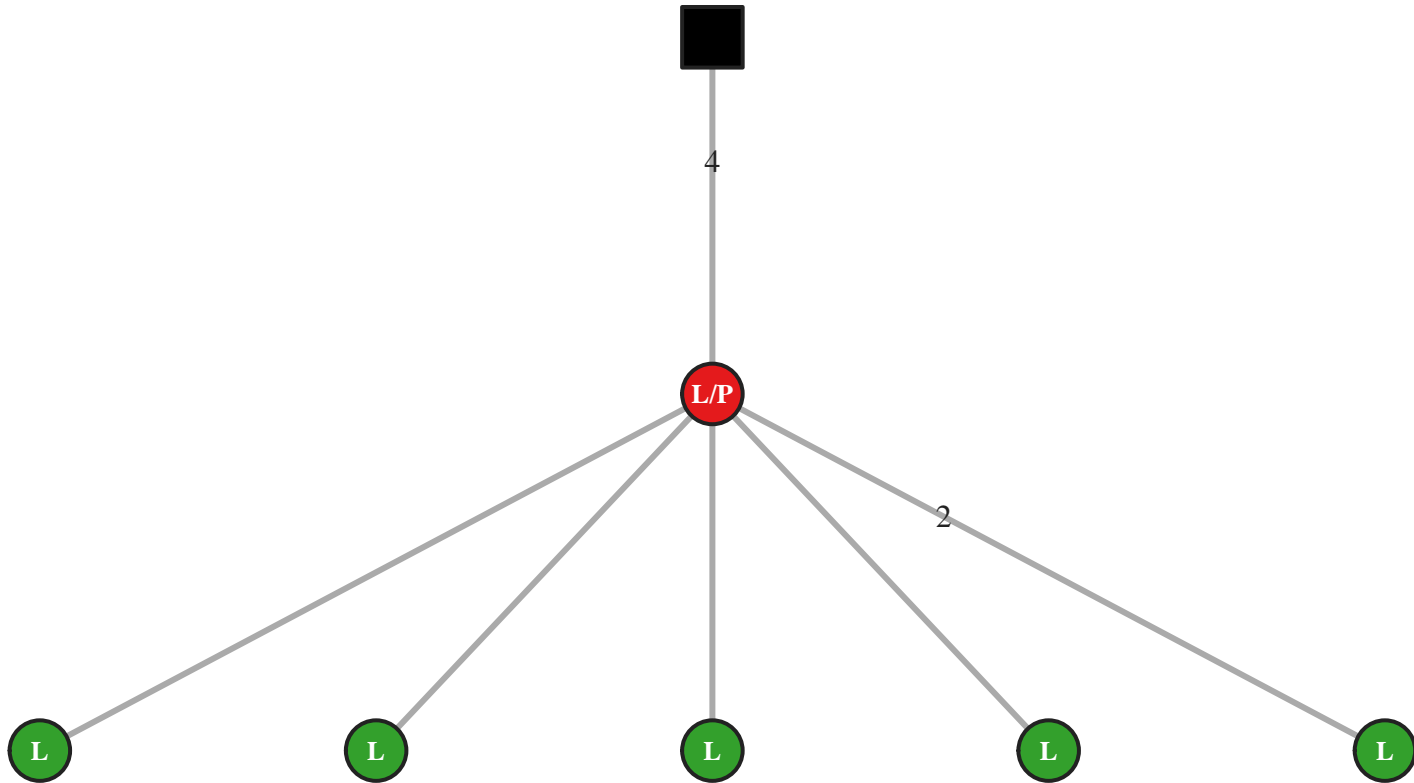

M5 IgG IGHV3-15/J4 36bp (16183)

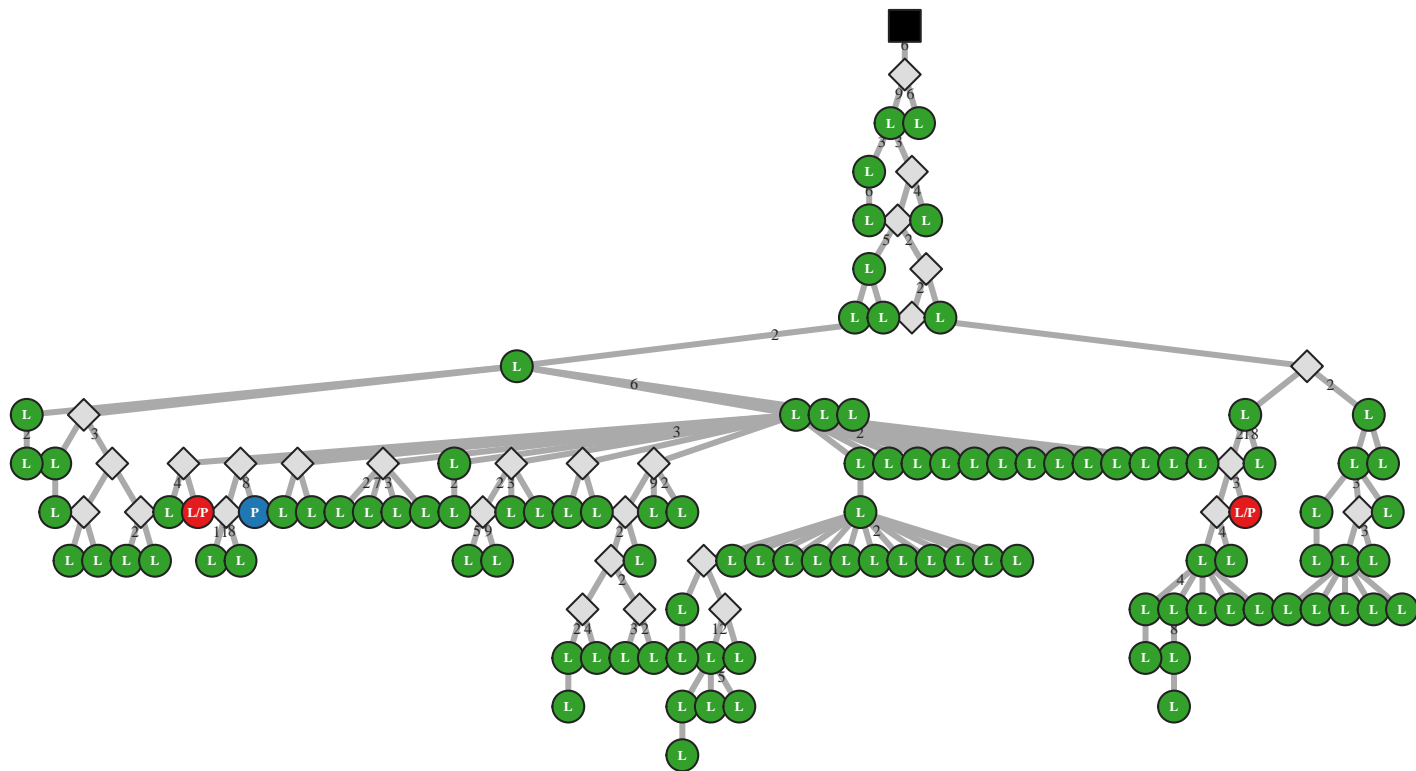

M5 IgG IGHV3-15/J4 39bp (25065)

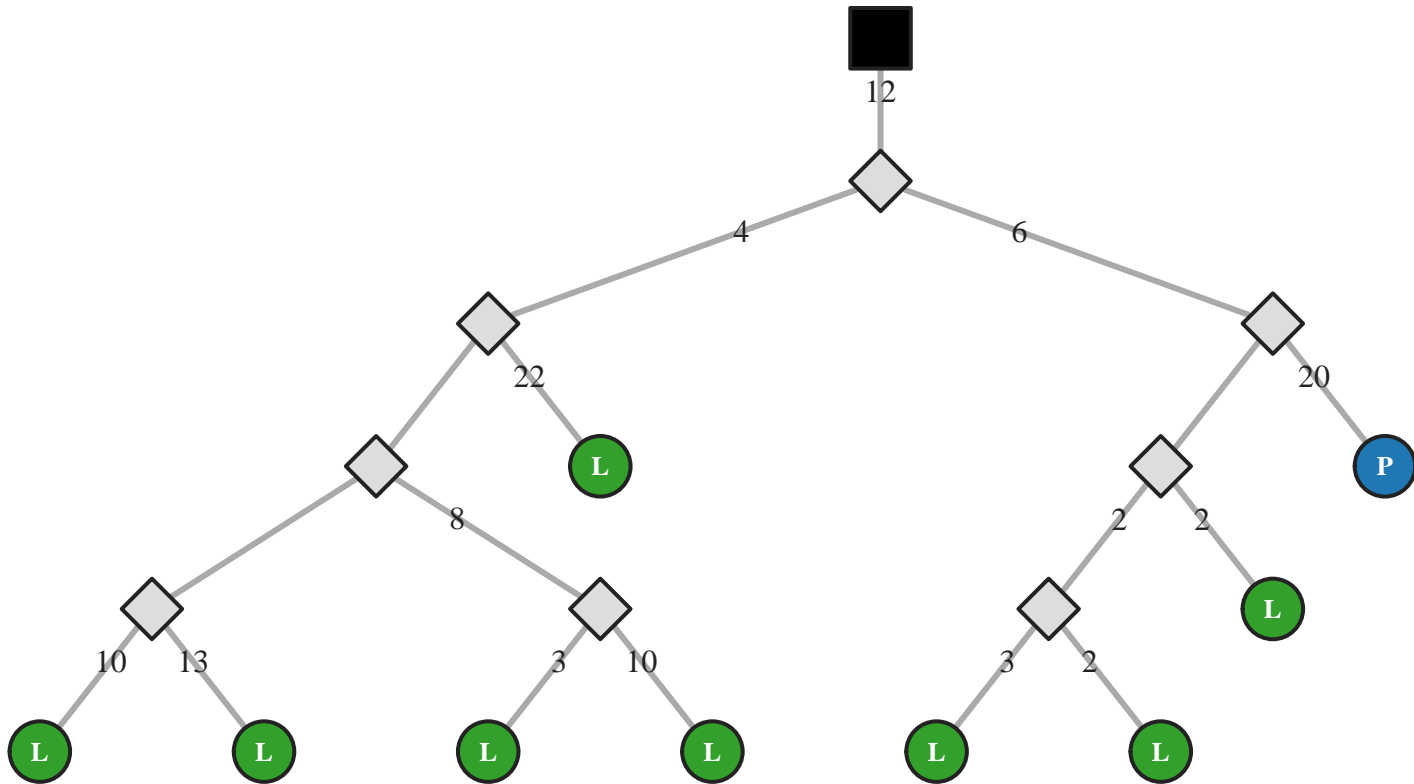

M5 IgG IGHV3-15/J4 42bp (16193)

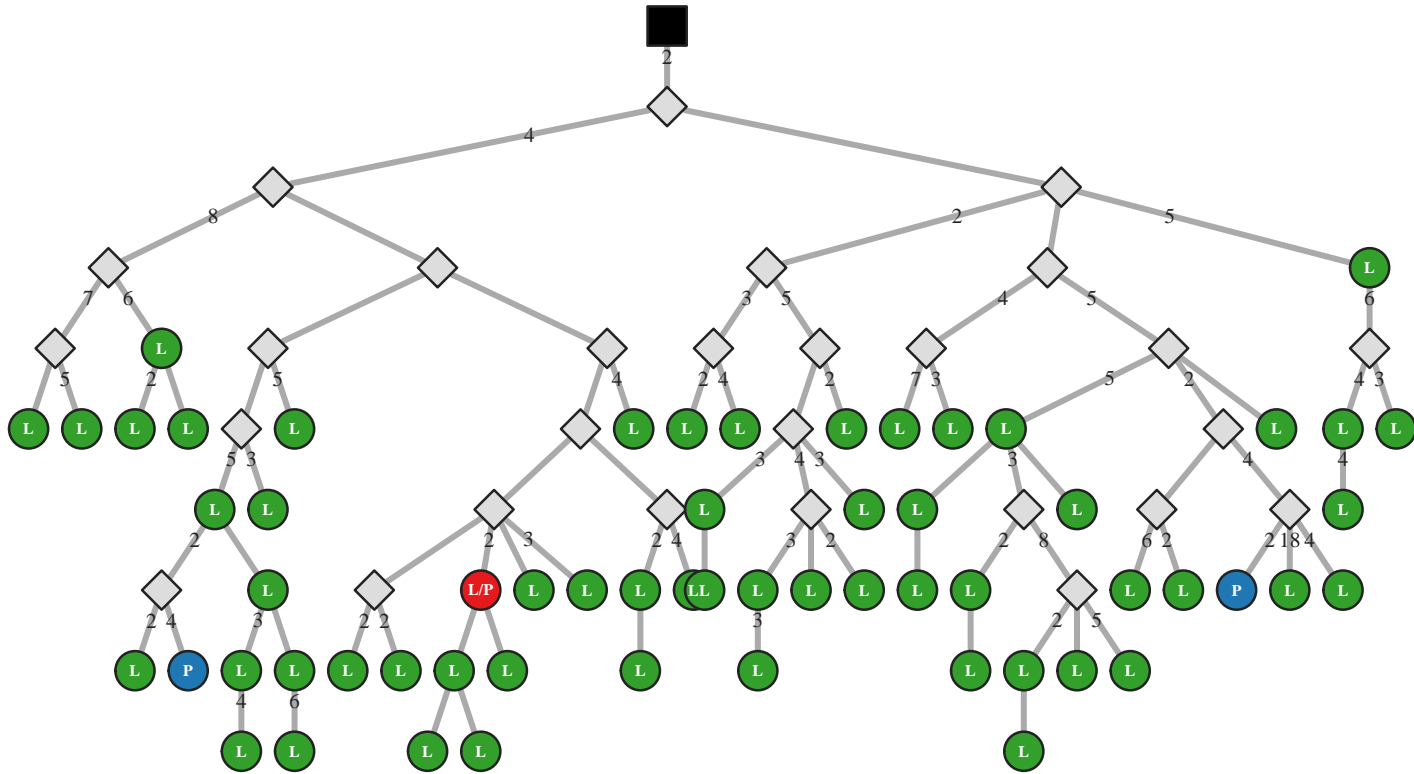

M5 IgG IGHV3-15/J4 42bp (16235)

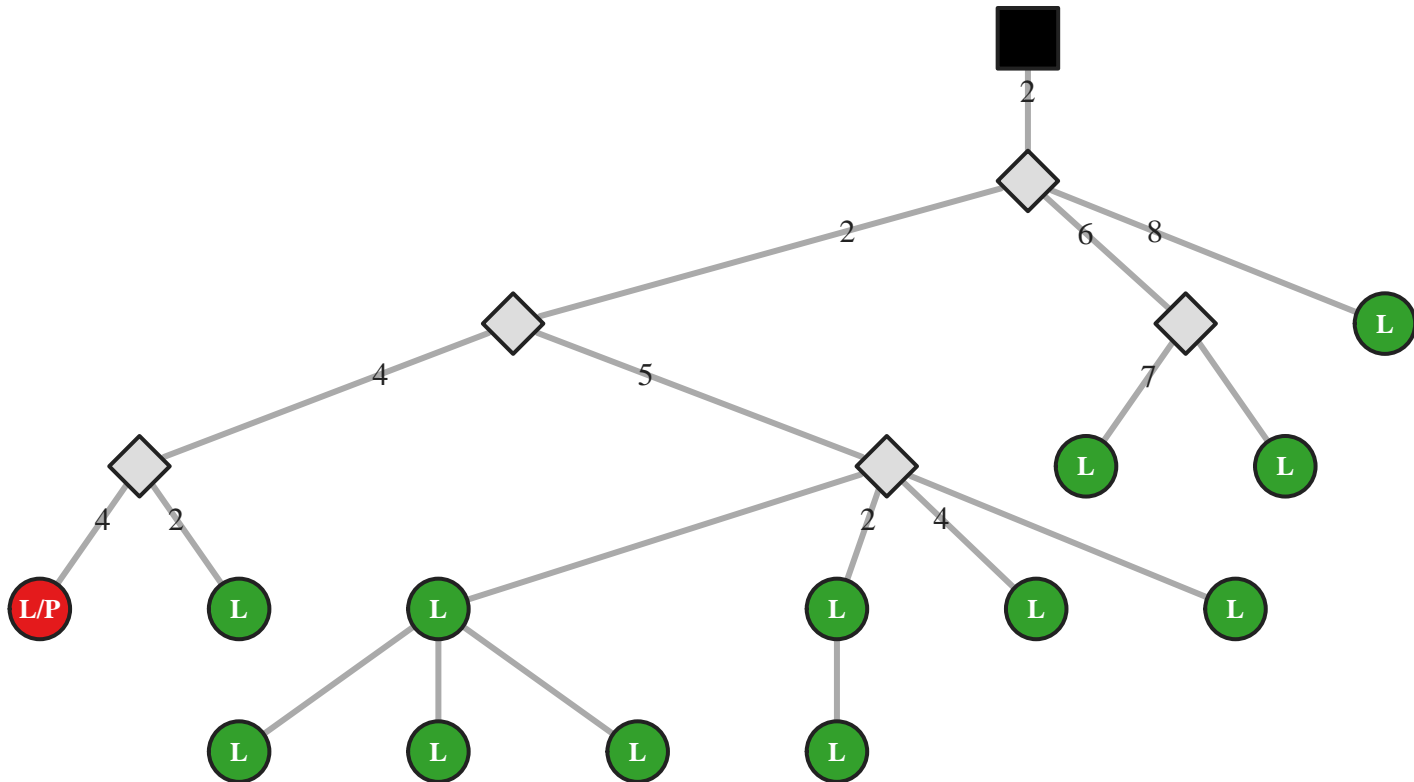

M5 IgA IGHV3-15/J4 45bp (12218)

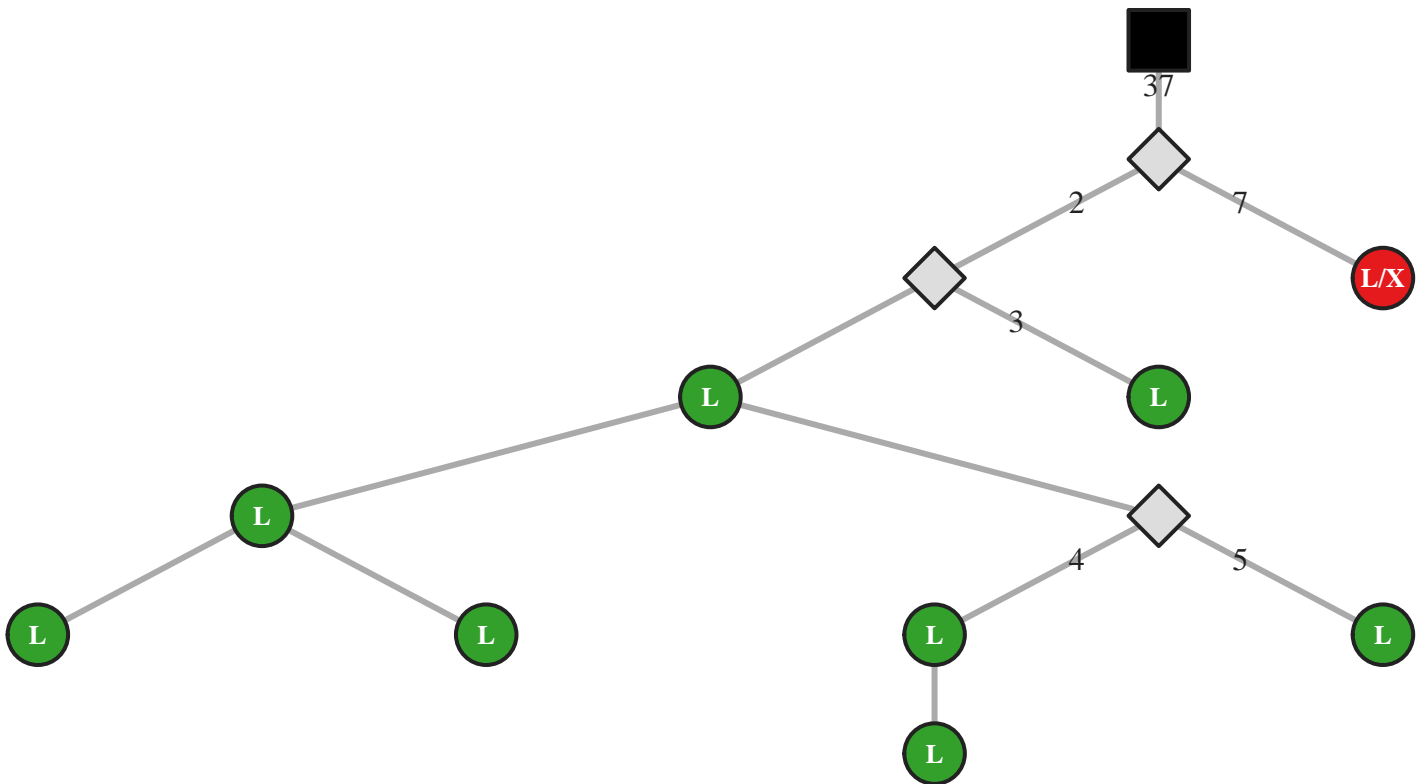

M5 IgG IGHV3-15/J4 45bp (16259)

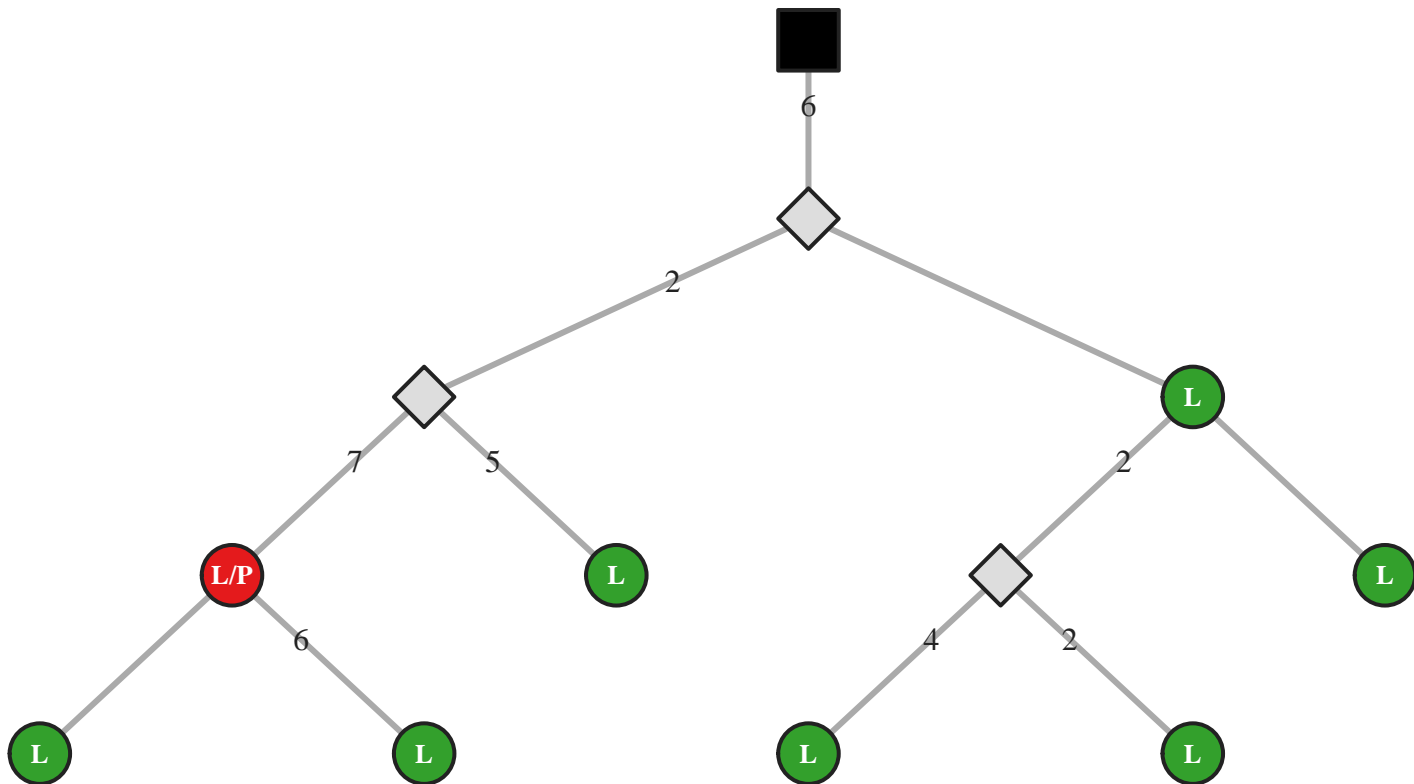

M5 IgA IGHV3-15/J4 48bp (48716)

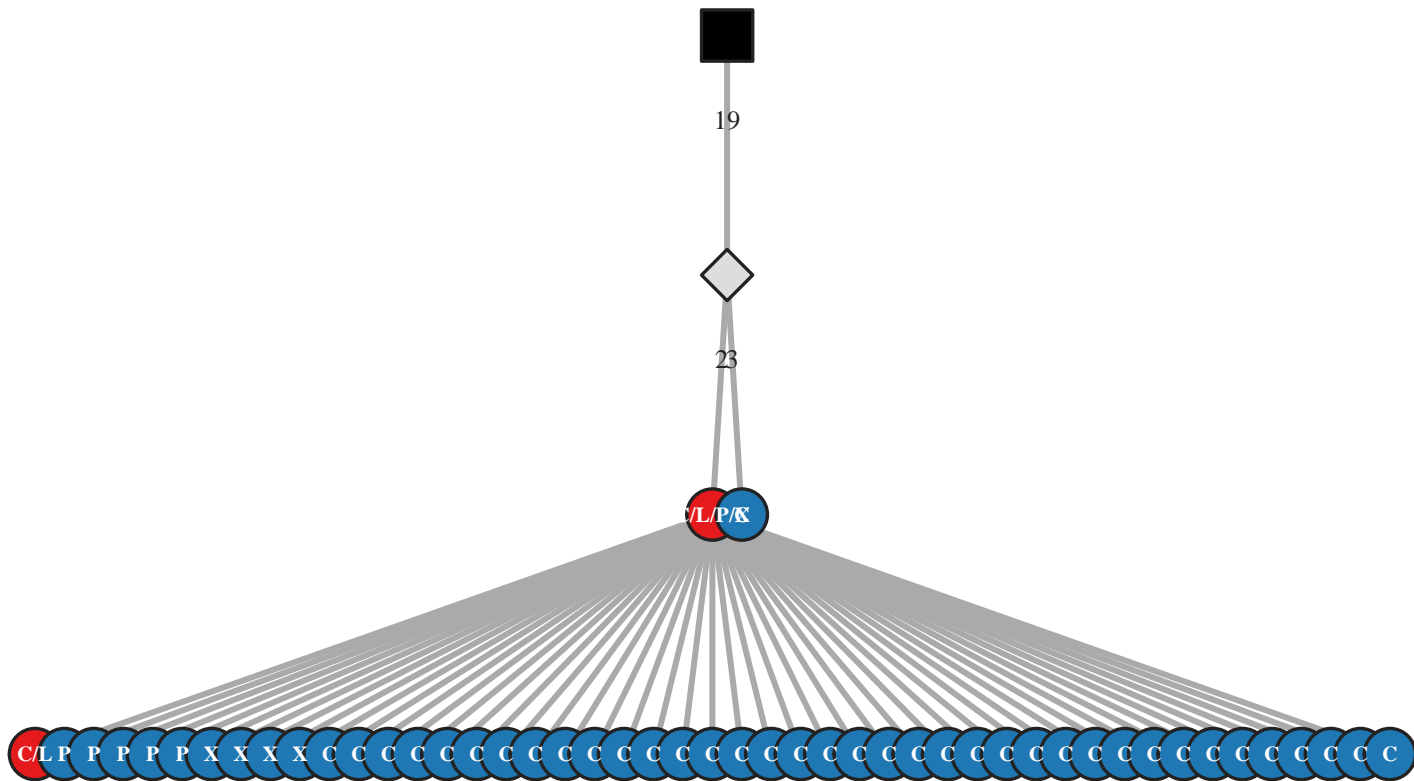

M5 IgA IGHV3-15/J4 48bp (48720)

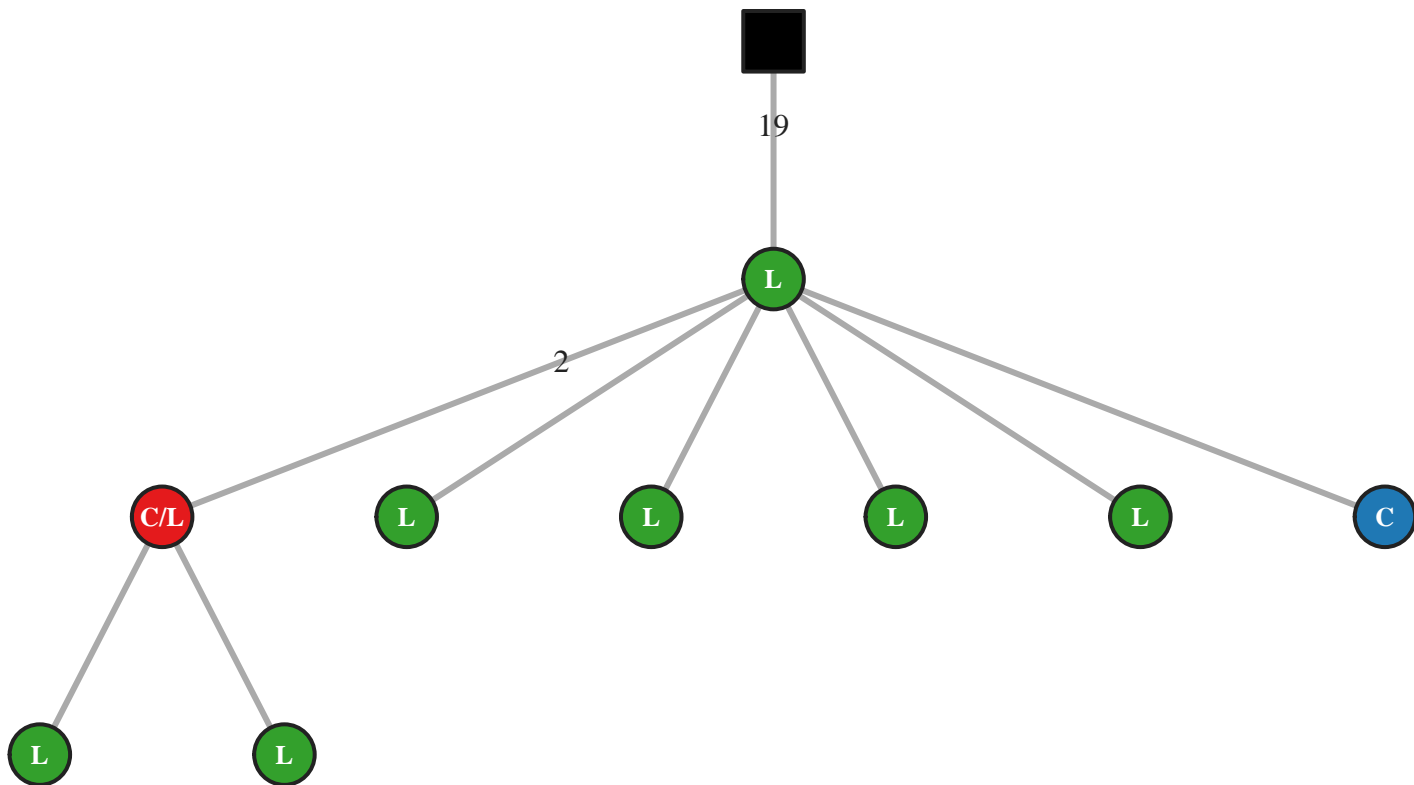

M5 IgG IGHV3-15/J4 48bp (51124)

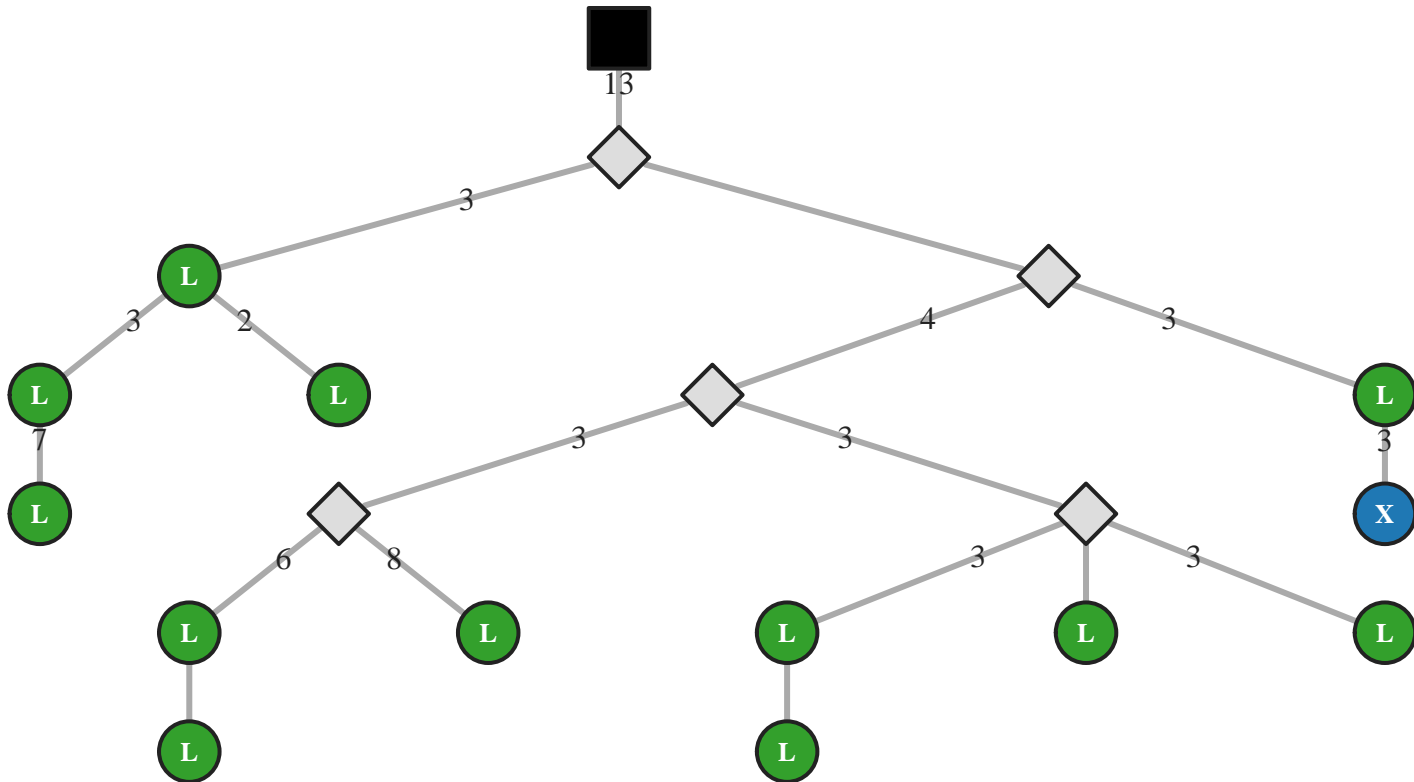

M5 IgG IGHV3-15/J4 51bp (51148)

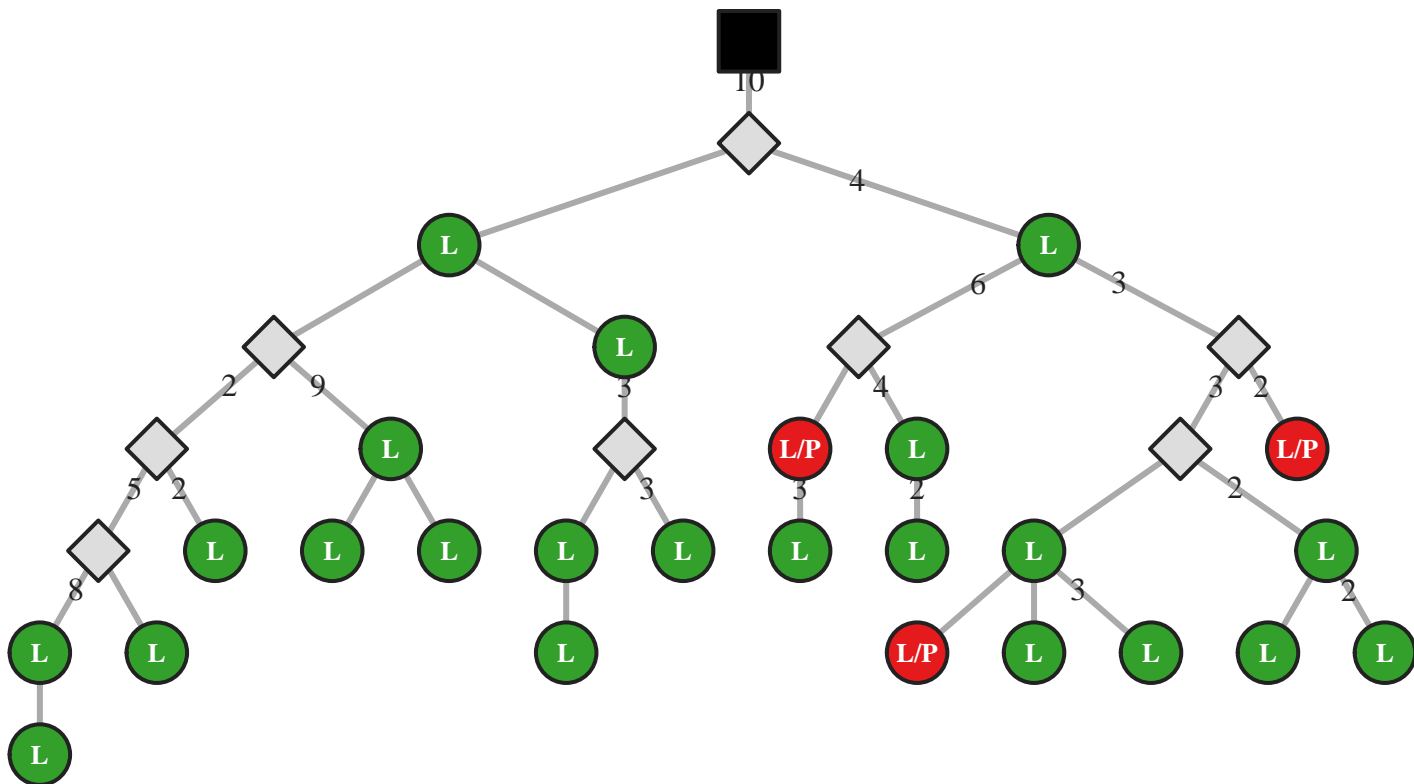

M5 IgG IGHV3-15/J4 54bp (43384)

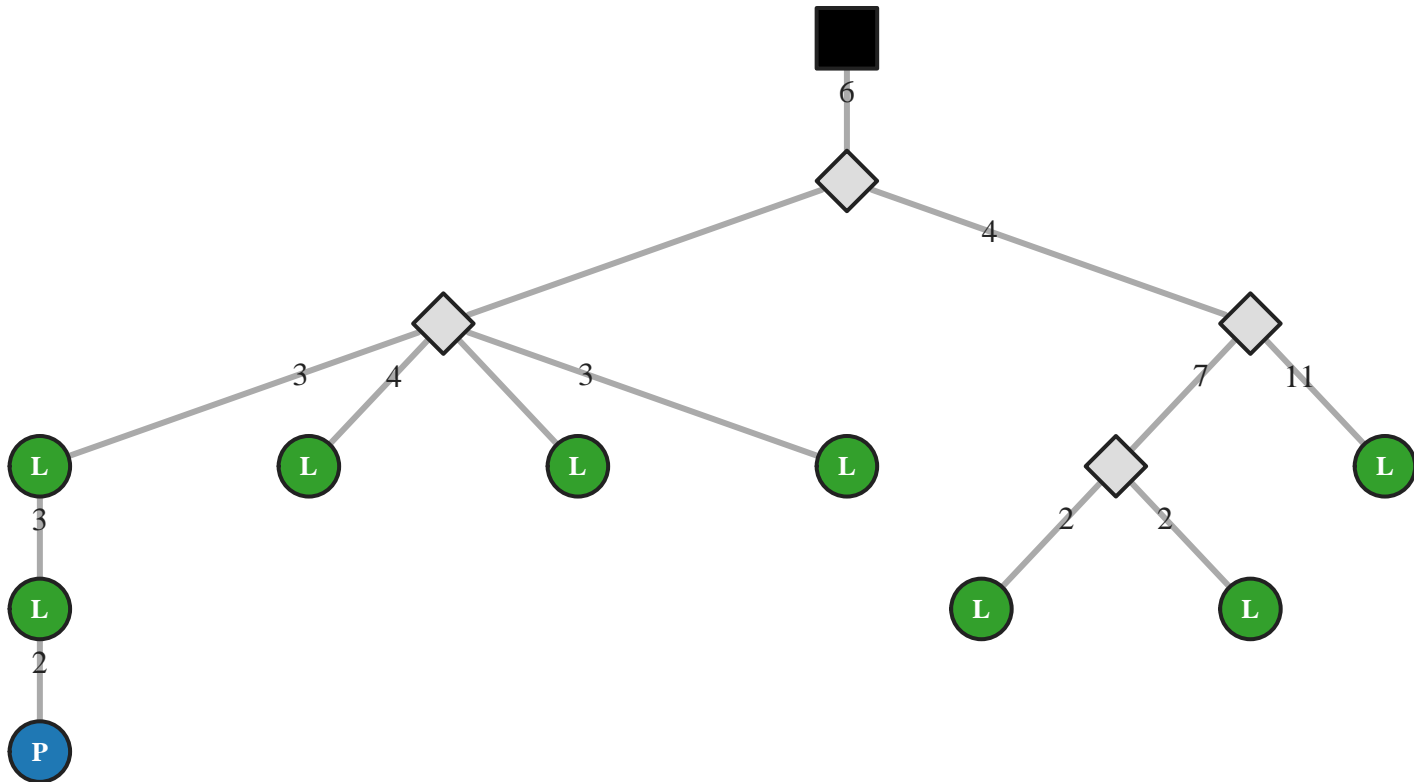

M5 IgG IGHV3-15/J4 54bp (43403)

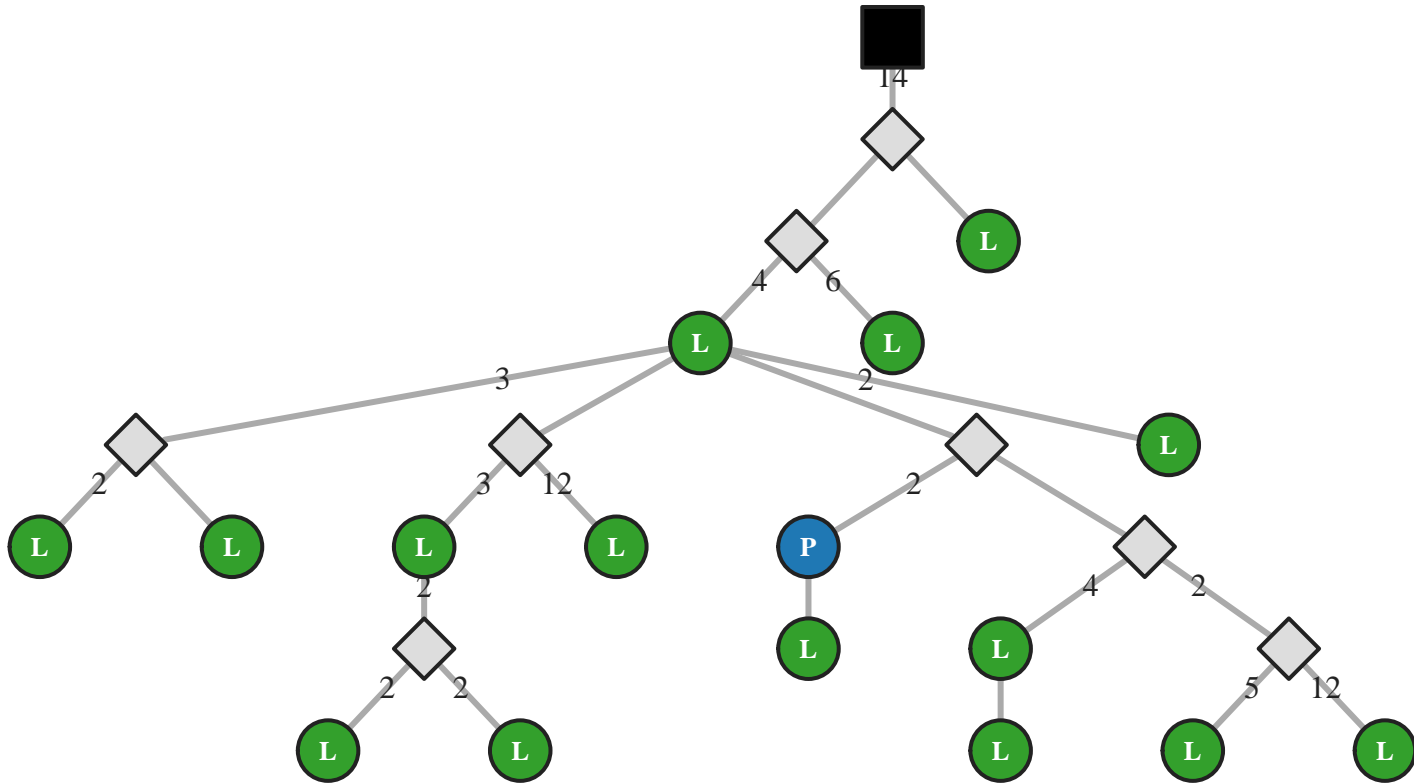

M5 IgG IGHV3-15/J4 60bp (6412)

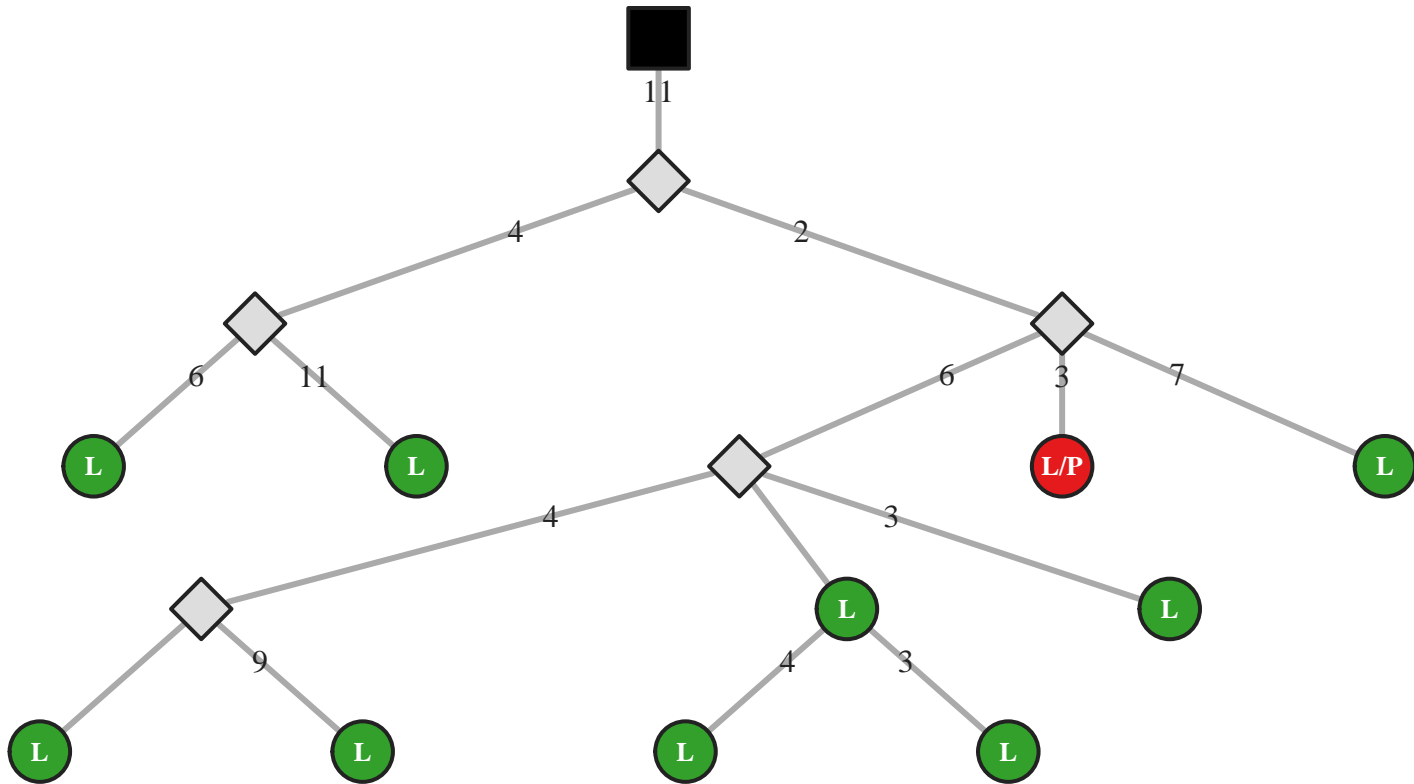

M5 IgG IGHV3-15/J6 45bp (34010)

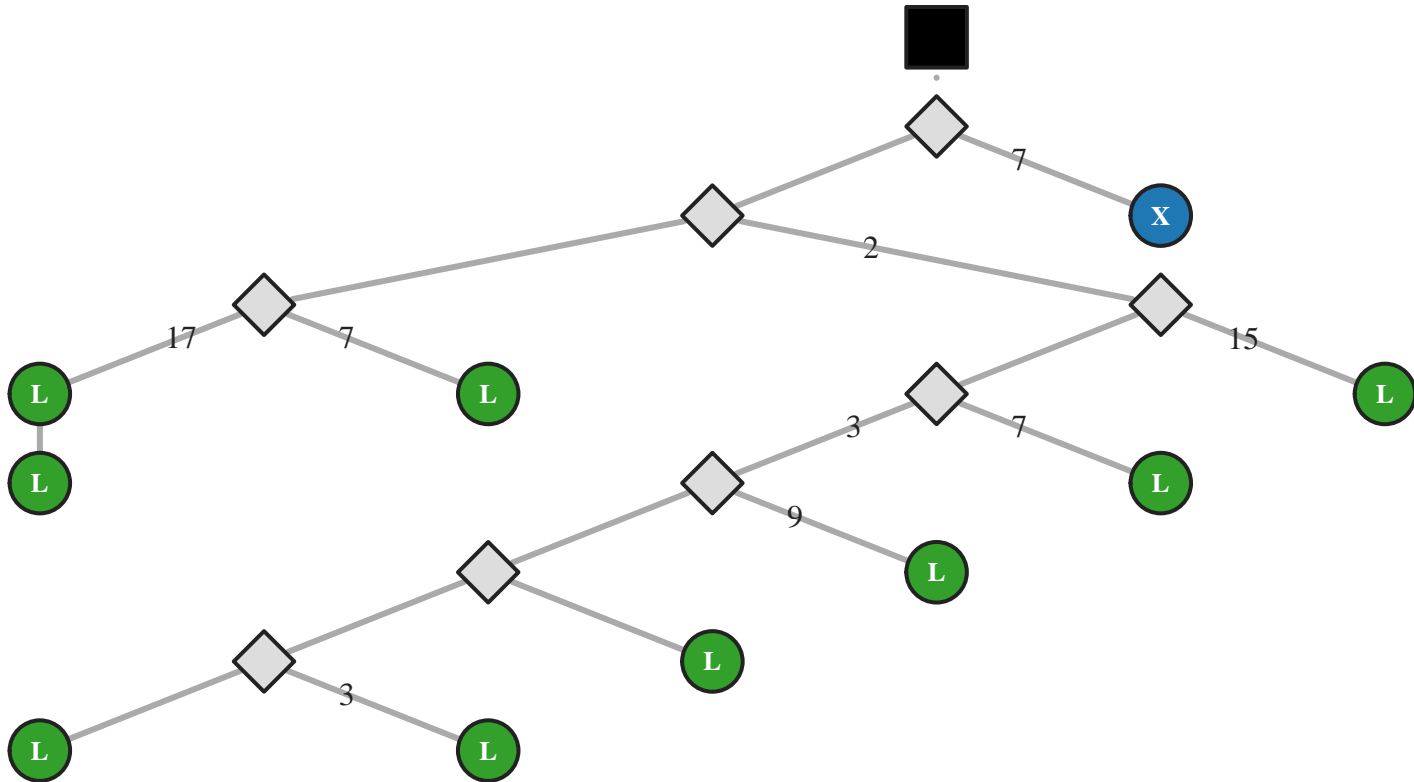

M5 IgG IGHV3-15/J6 51bp (16305)

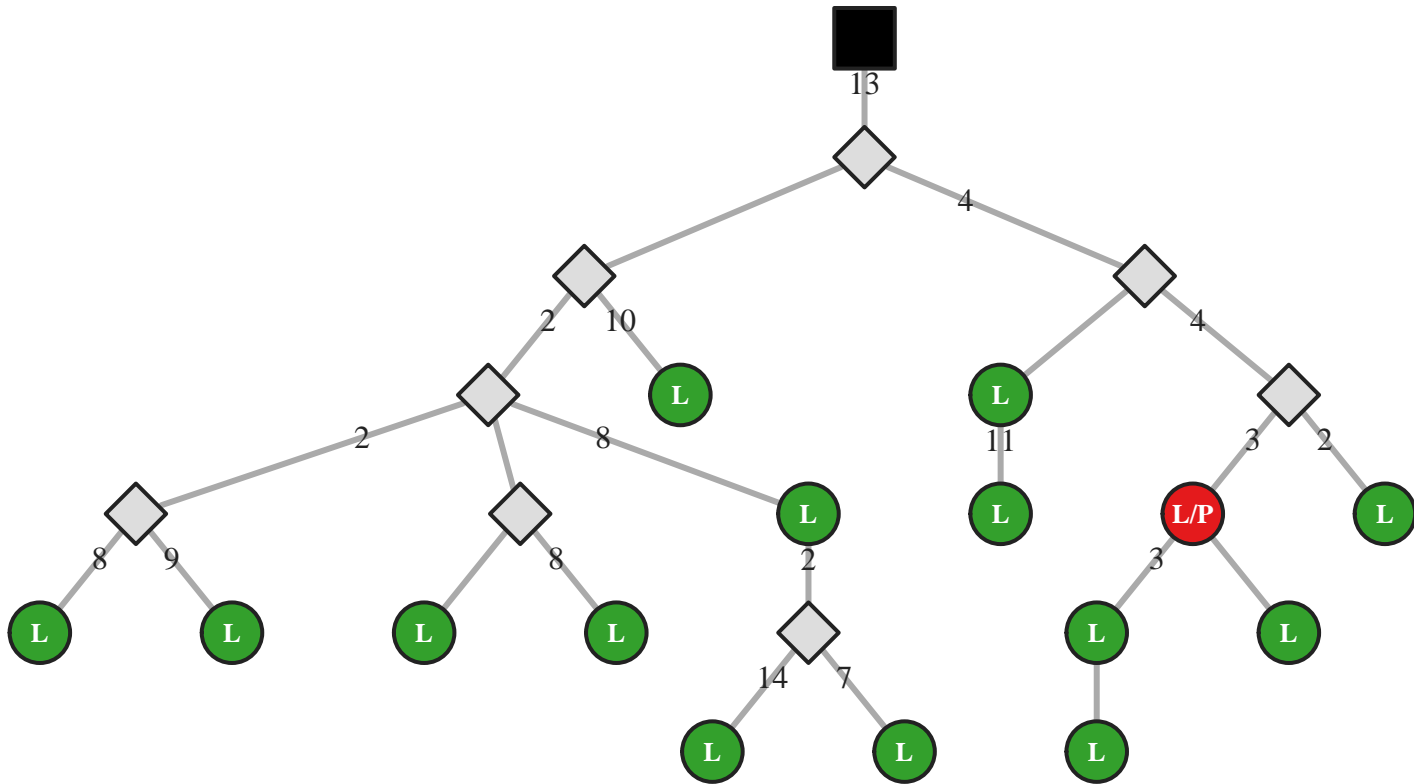

M5 IgG IGHV3-15/J6 54bp (6451)

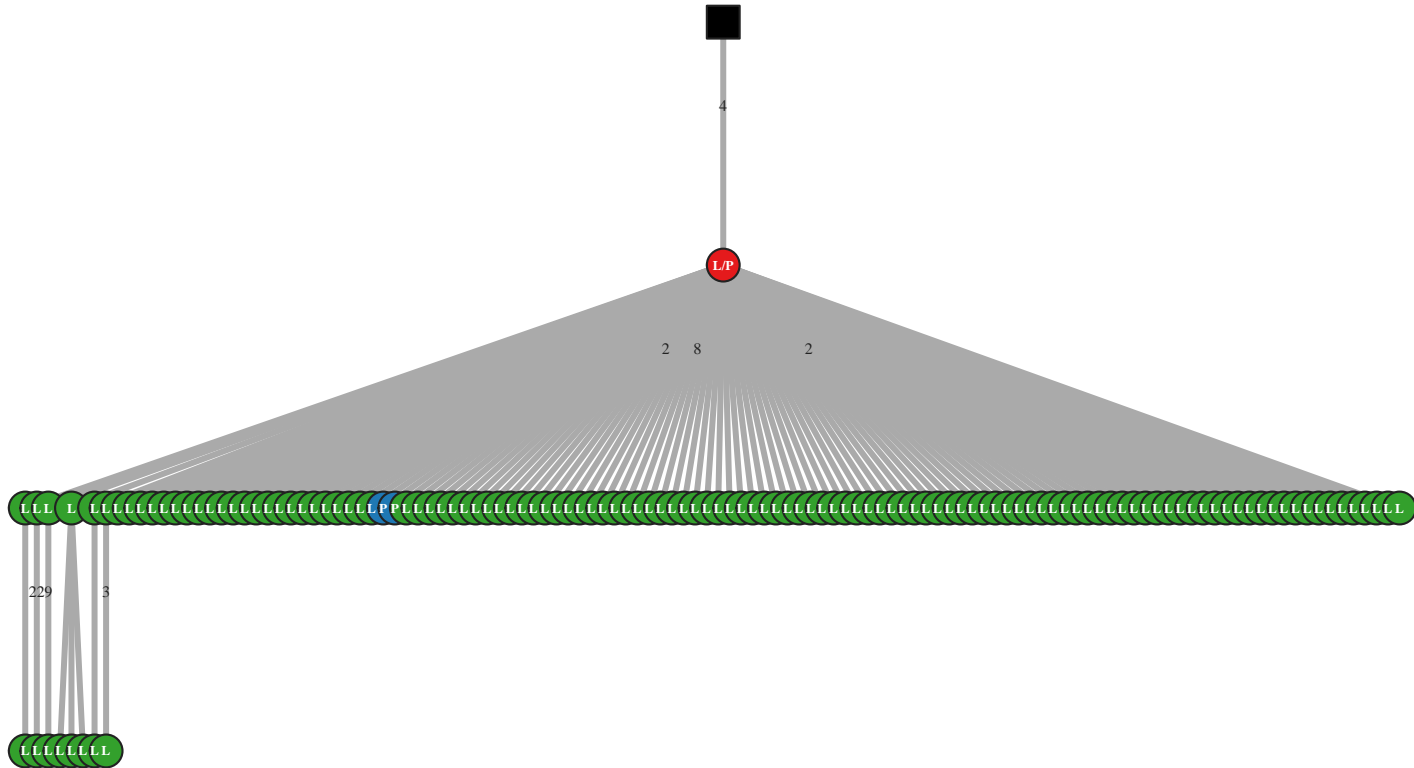

M5 IgG IGHV3-15/J6 60bp (34022)

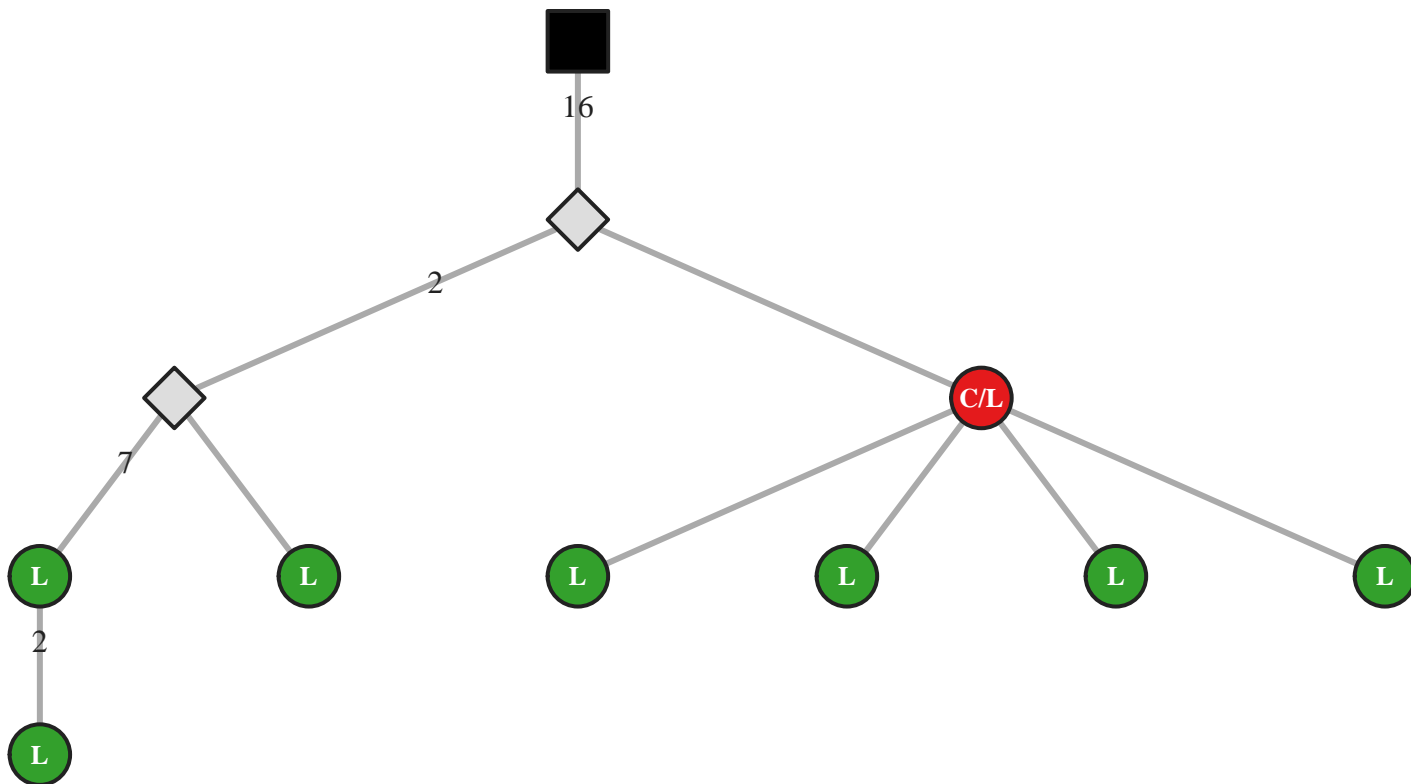

M5 IgG IGHV3-20/J3 51bp (43473)

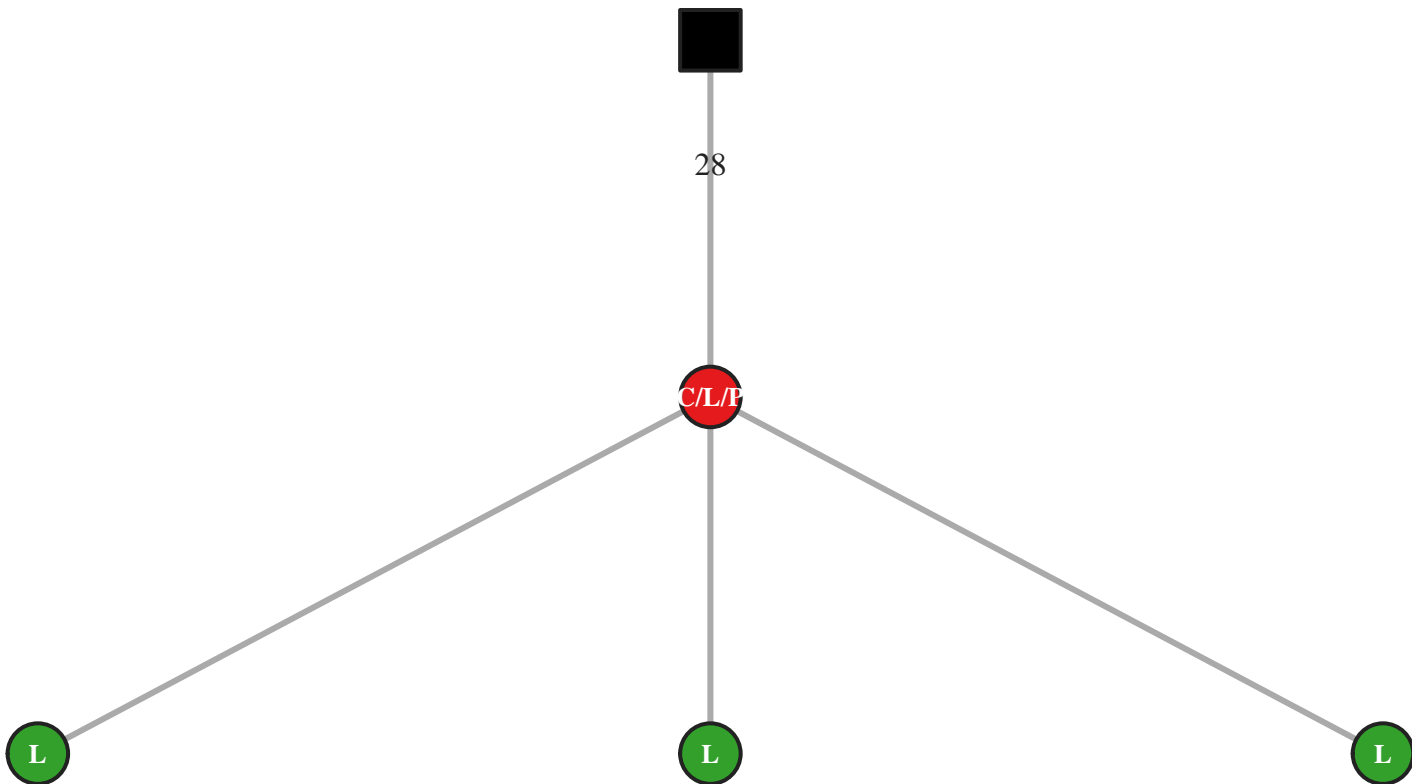

M5 IgG IGHV3-20/J4 51bp (34041)

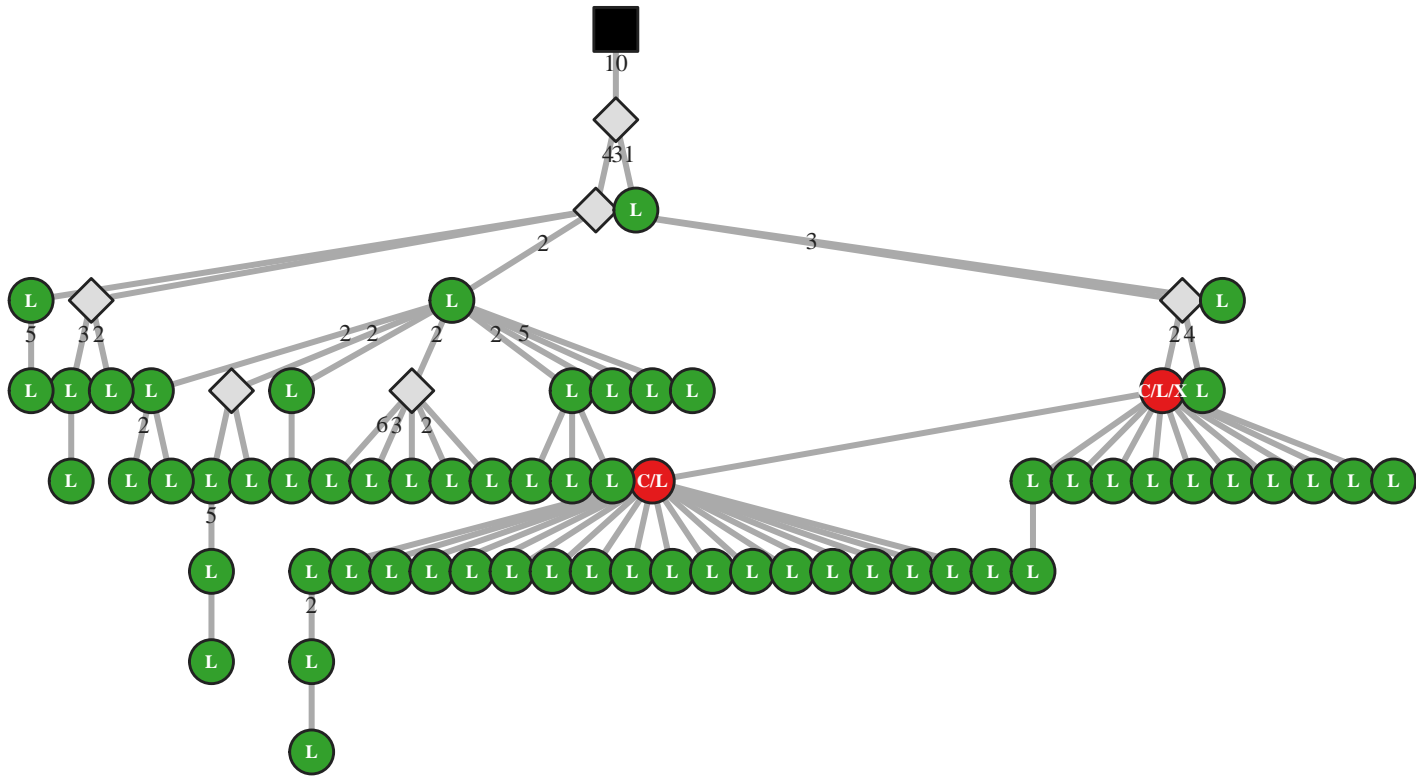

M5 IgG IGHV3-20/J6 66bp (43479)

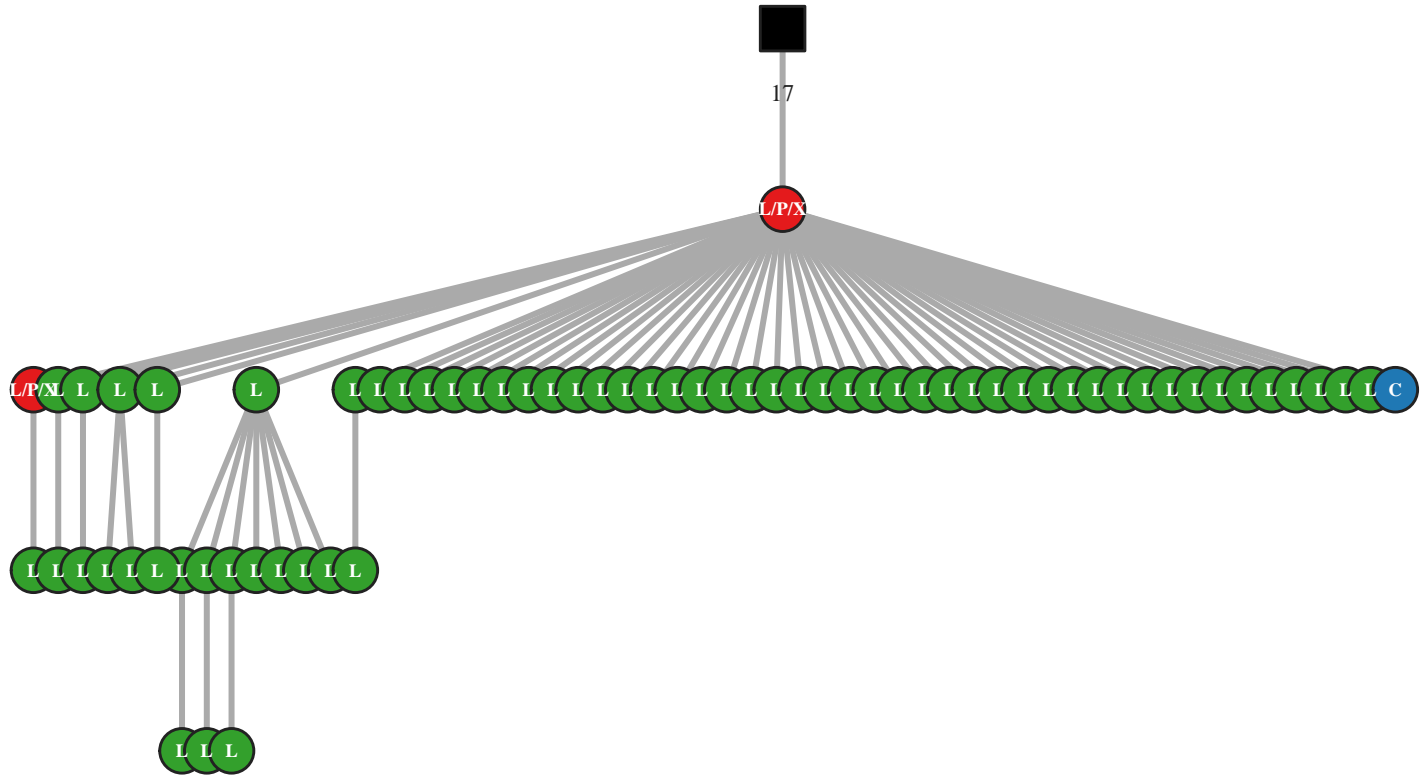

M5 IgG IGHV3-20/J6 66bp (43480)

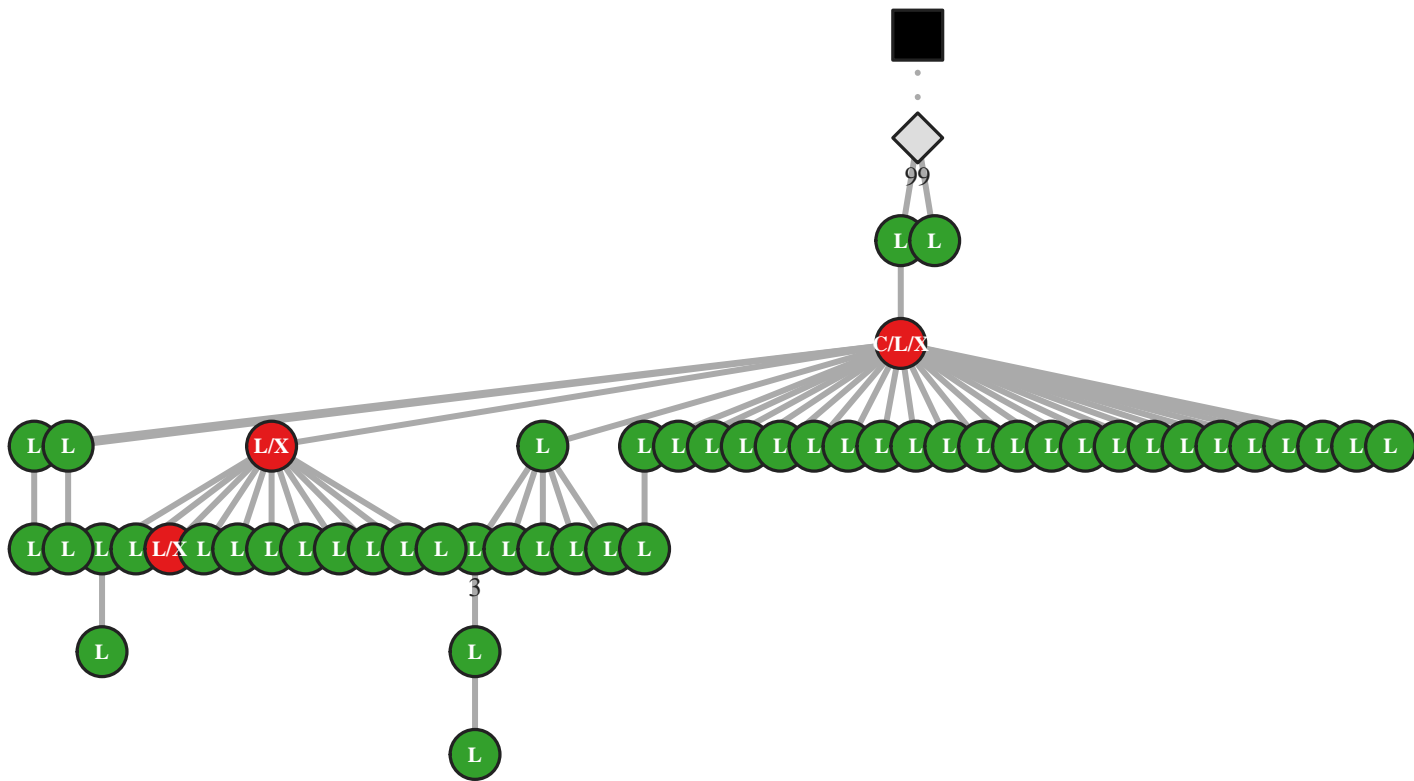

M5 IgG IGHV3-21/J1 36bp (16335)

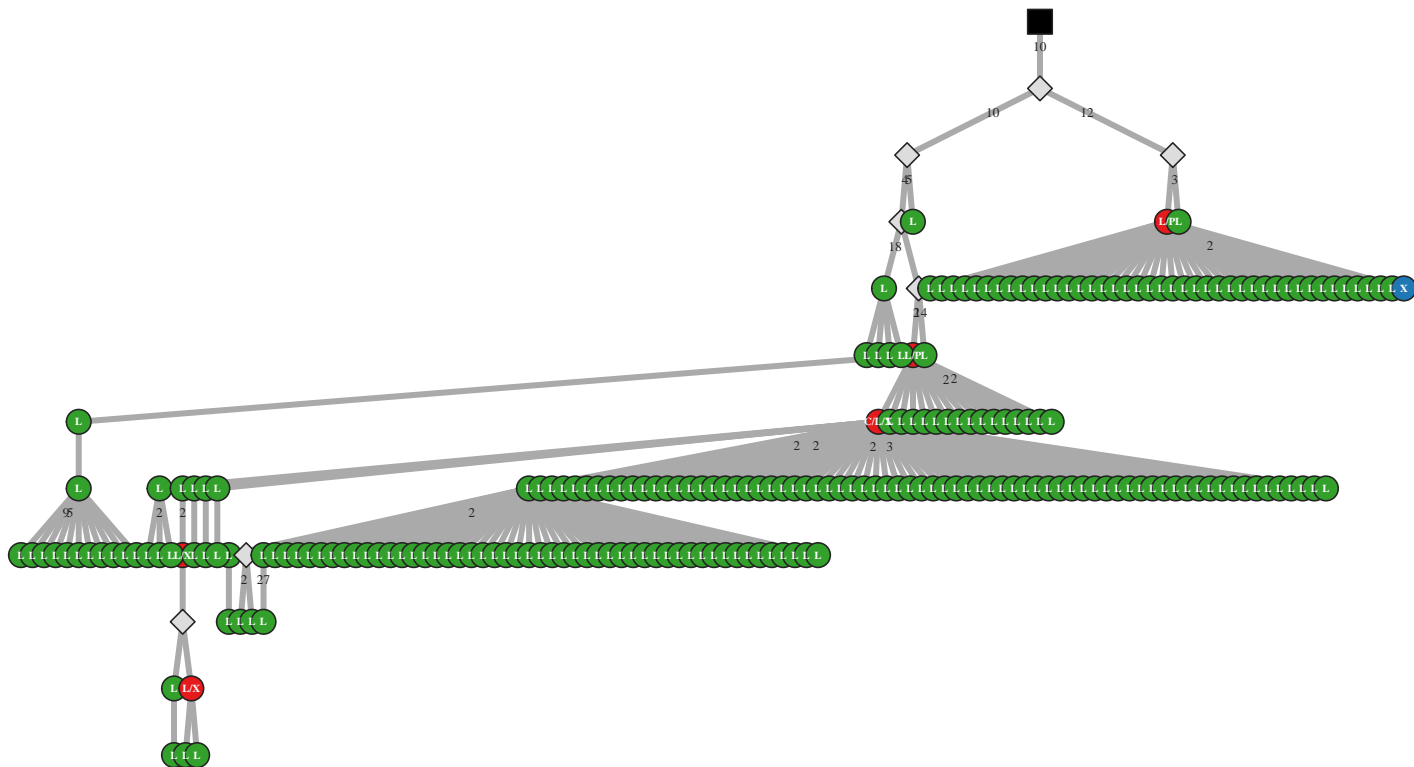

M5 IgG IGHV3-21/J1 48bp (43482)

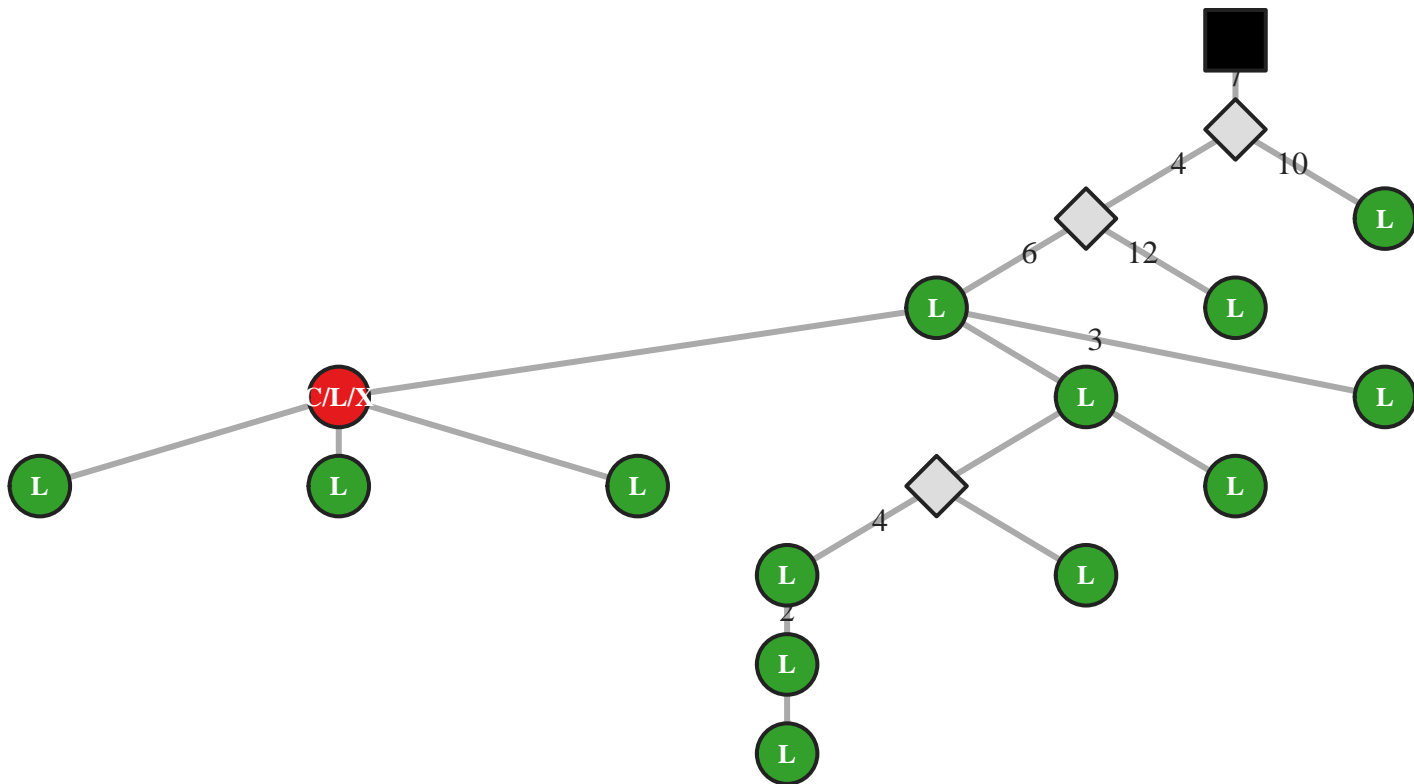

M5 IgG IGHV3-21/J3 33bp (34051)

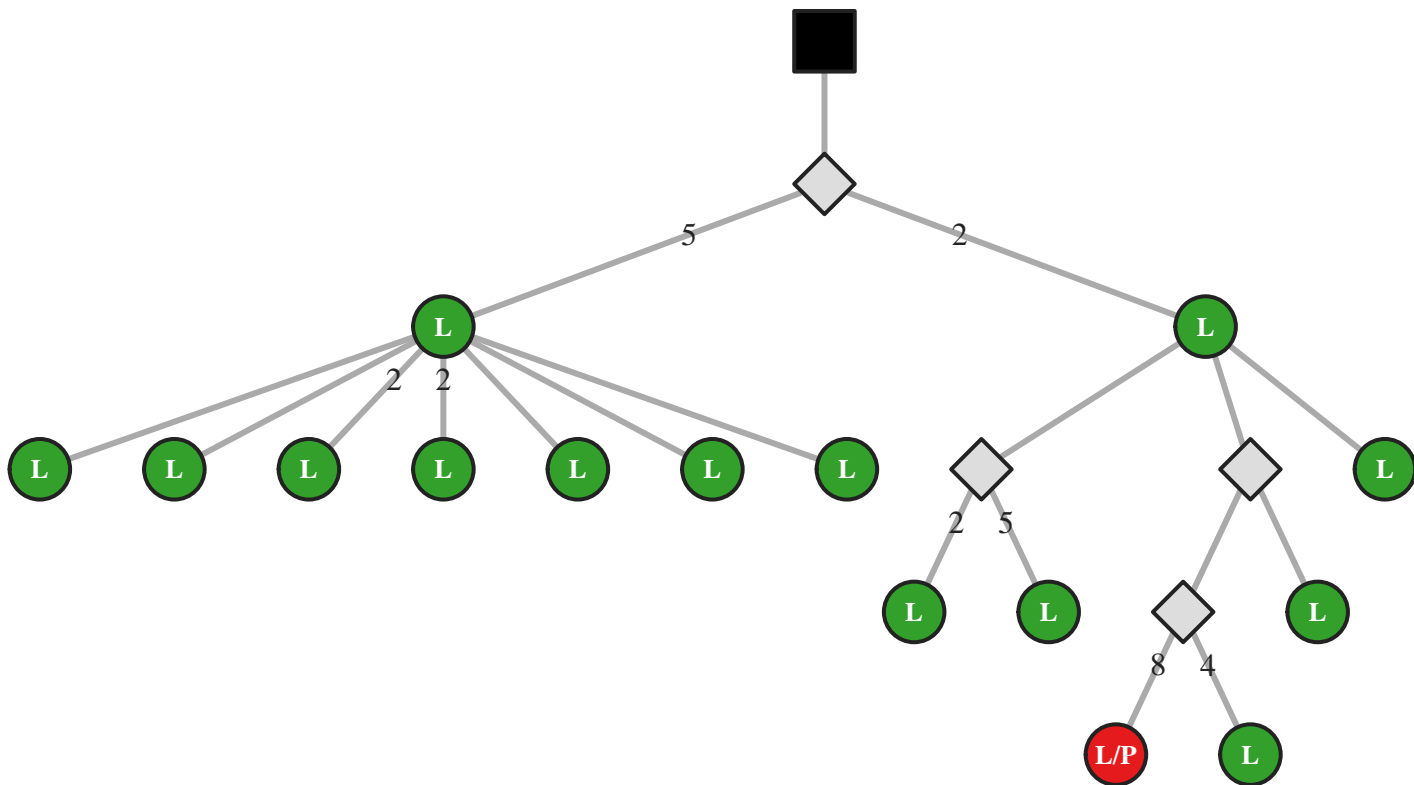

M5 IgG IGHV3-21/J3 45bp (25139)

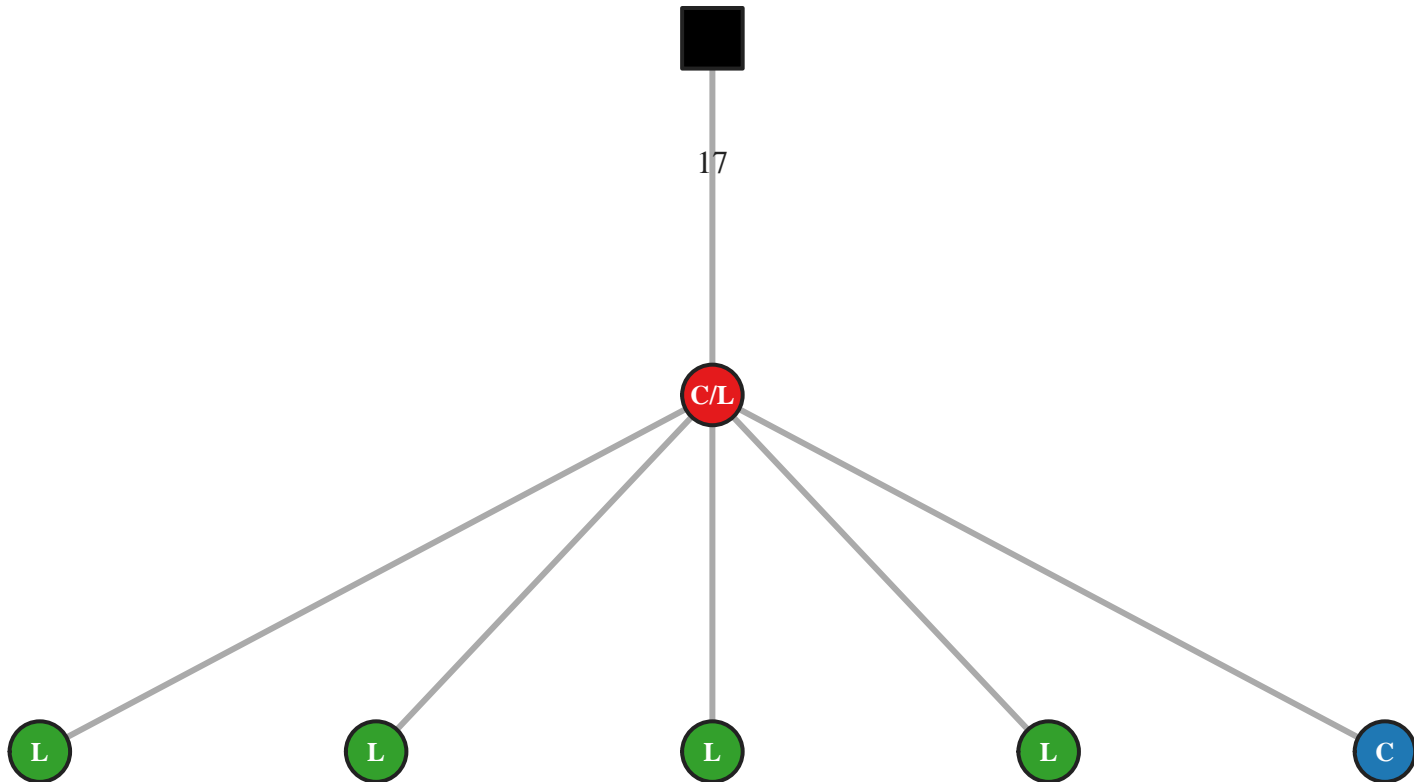

M5 IgG IGHV3-21/J3 48bp (16352)

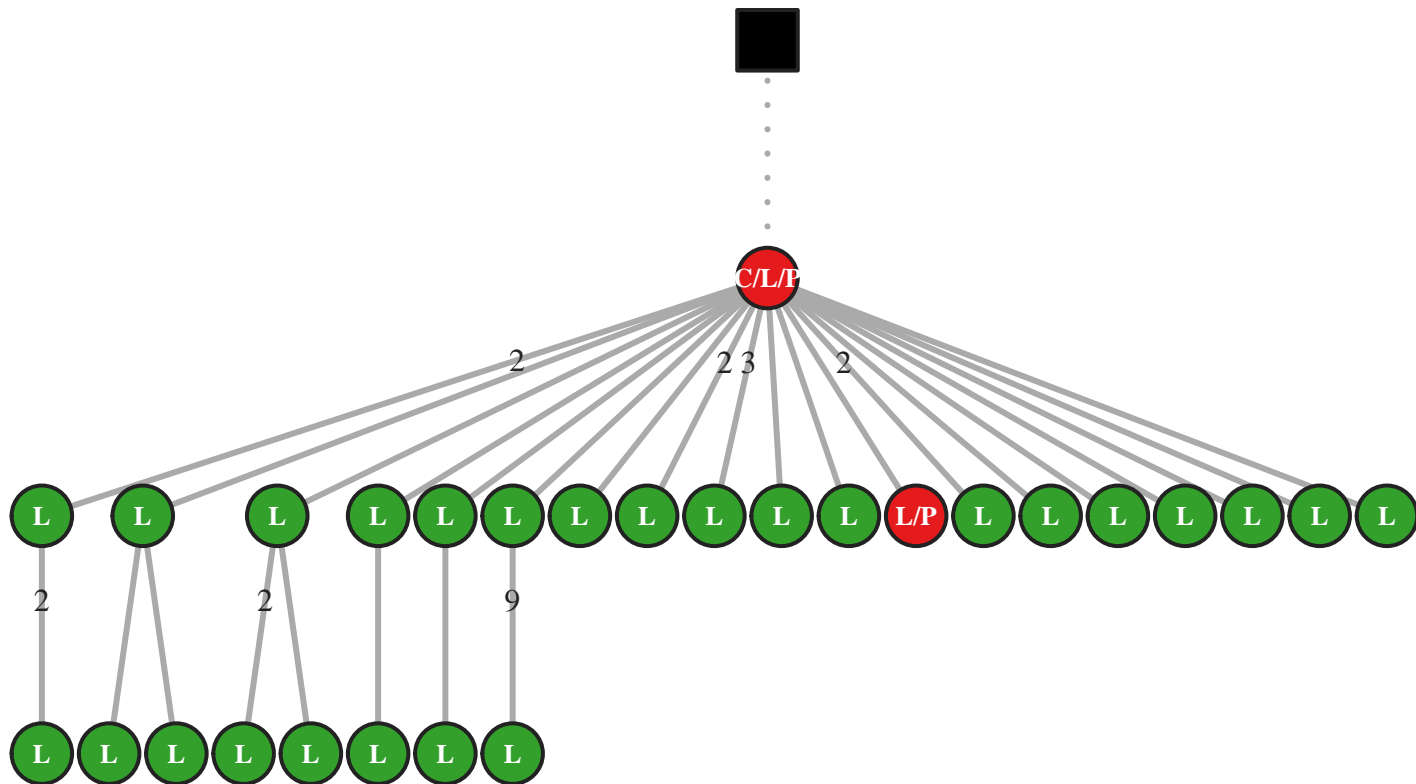

M5 IgG IGHV3-21/J3 60bp (16365)

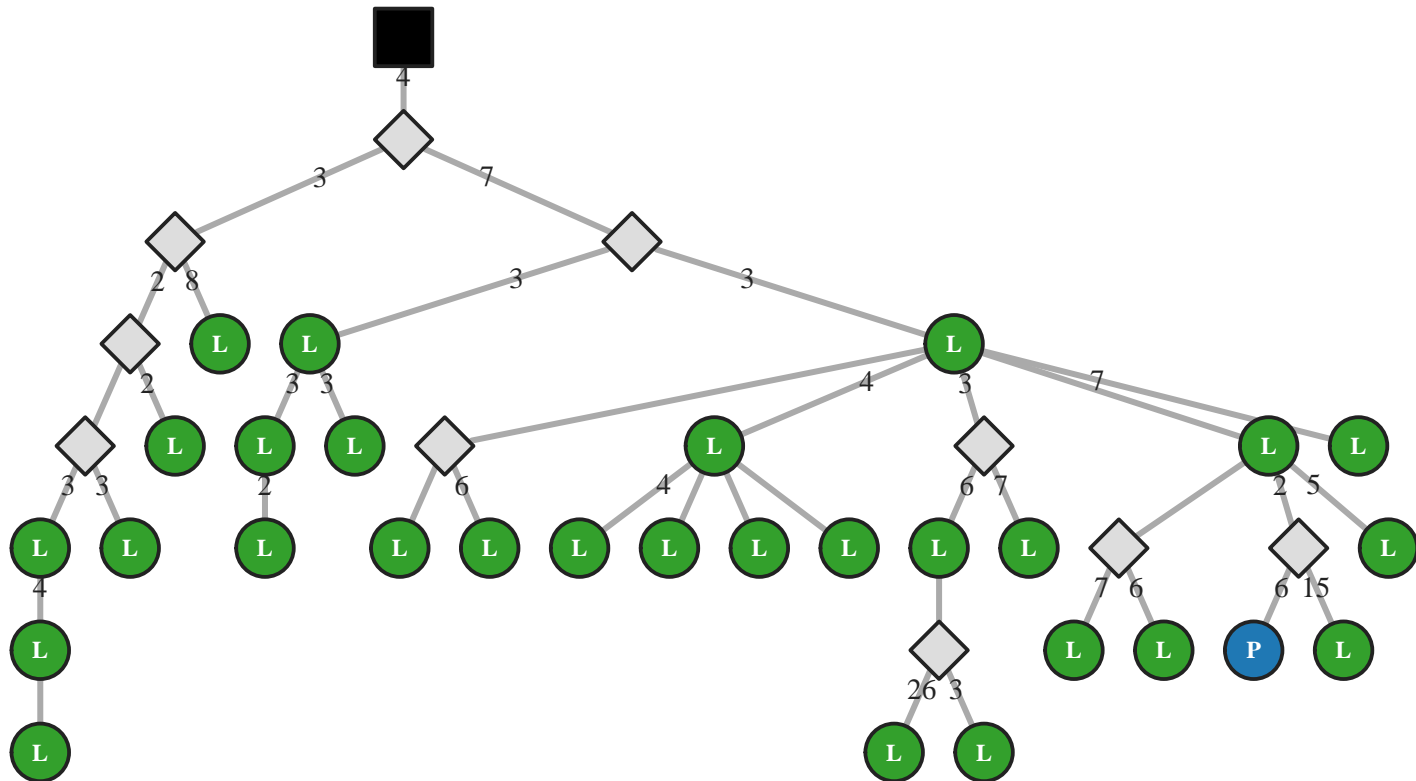

M5 IgG IGHV3-21/J3 63bp (6485)

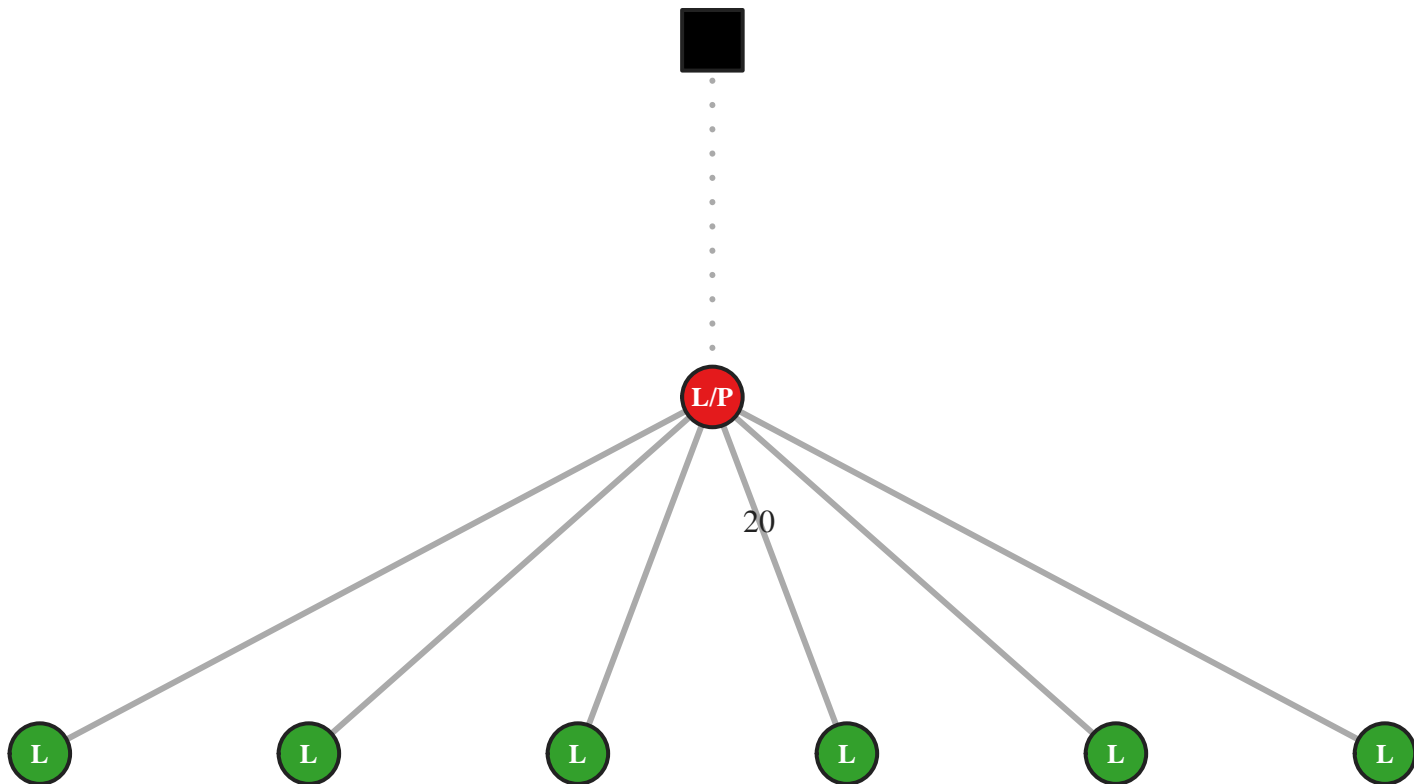

M5 IgG IGHV3-21/J3 63bp (6495)

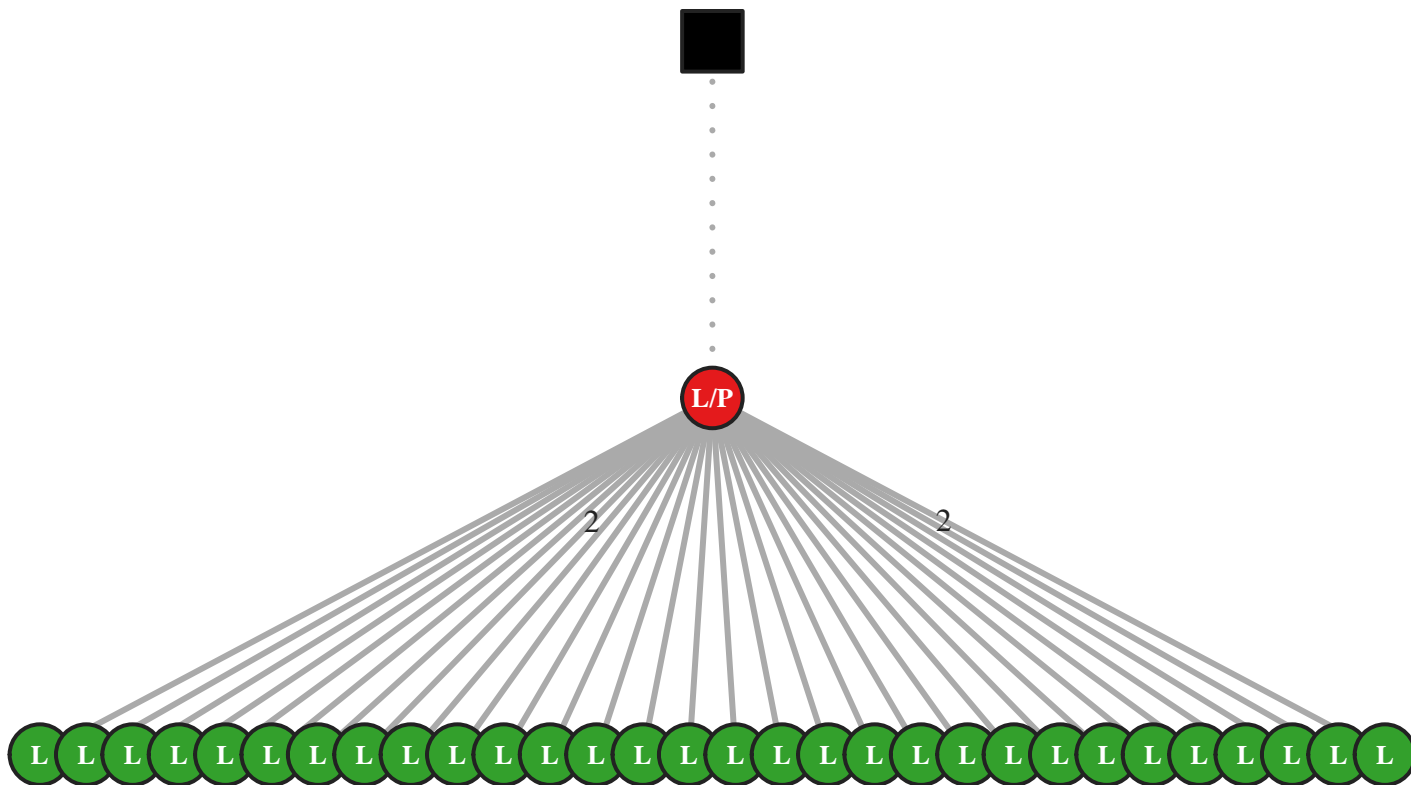

M5 IgG IGHV3-21/J3 69bp (16382)

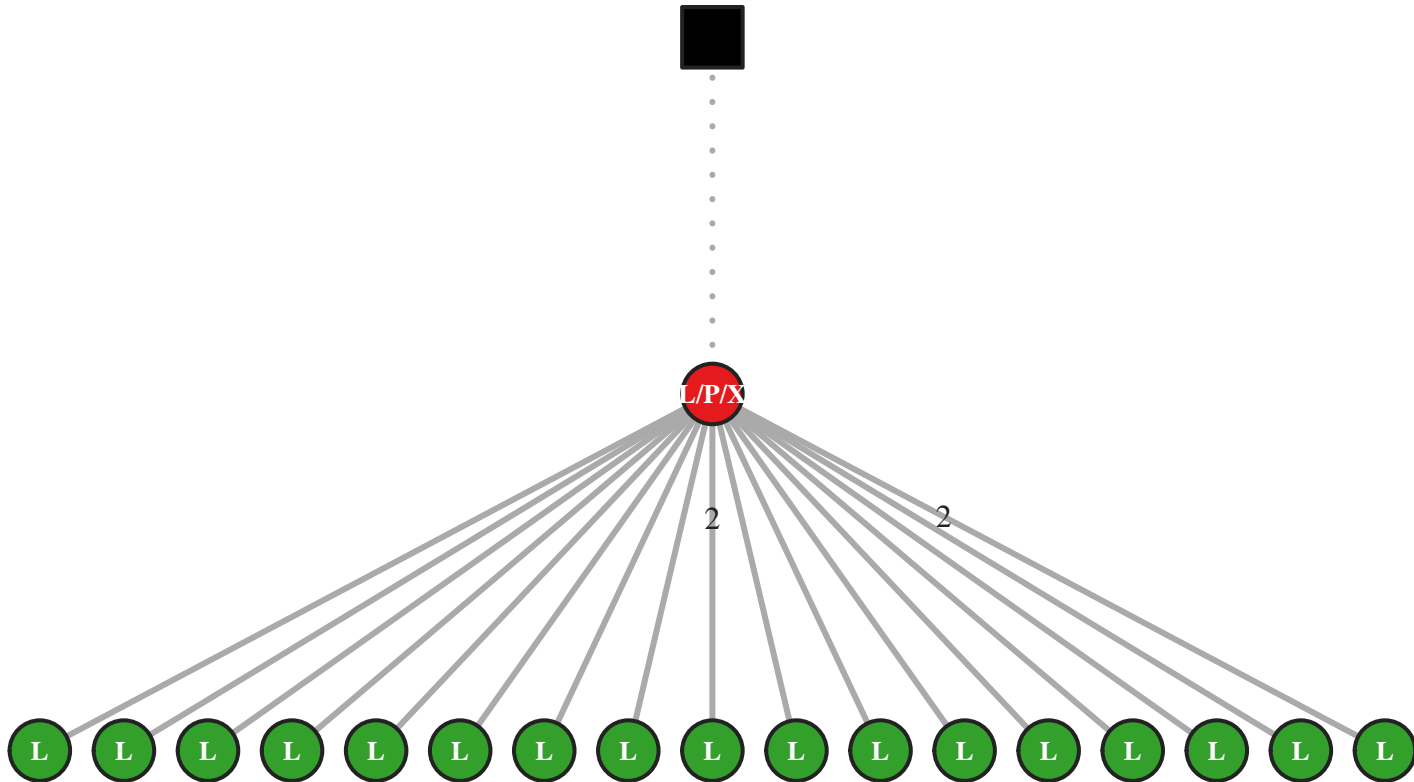

M5 IgG IGHV3-21/J4 30bp (34076)

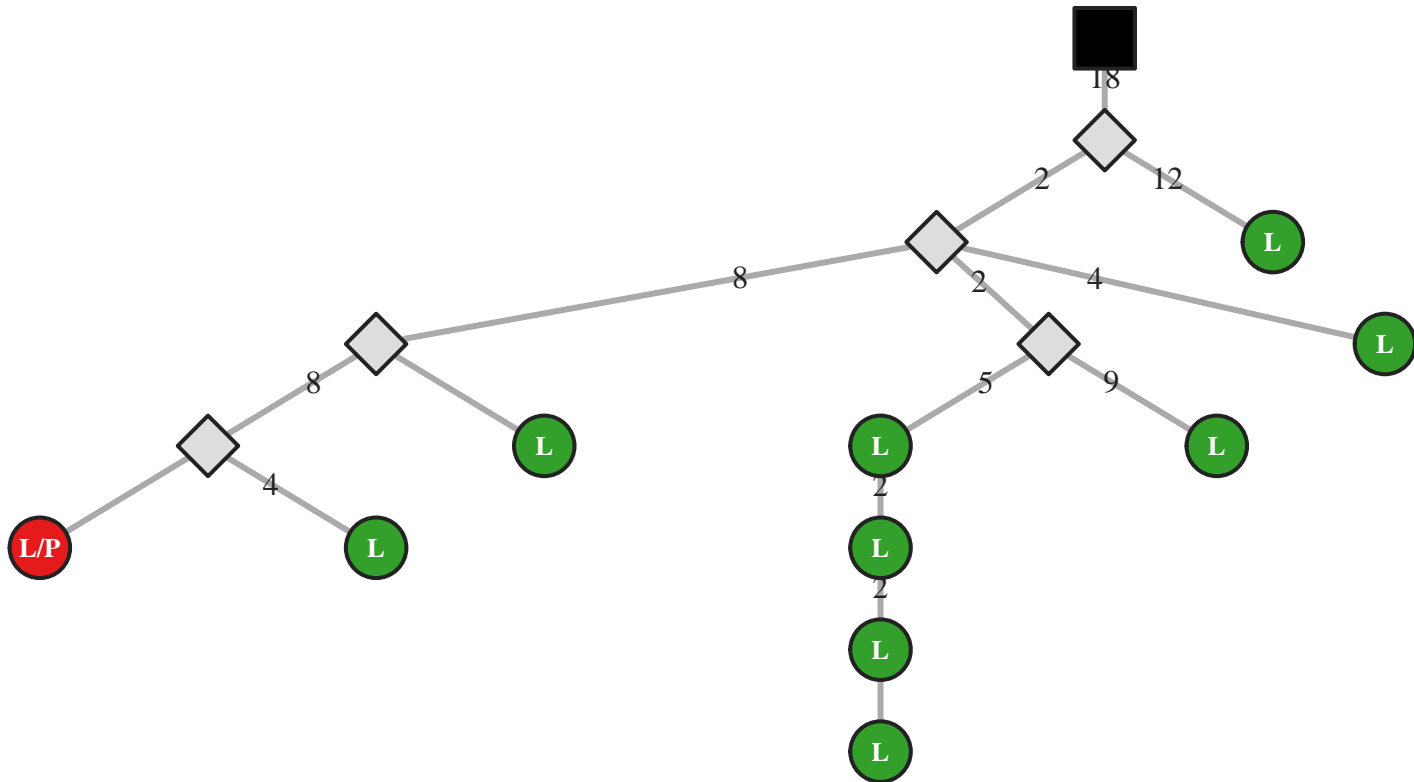

M5 IgG IGHV3-21/J4 39bp (25215)

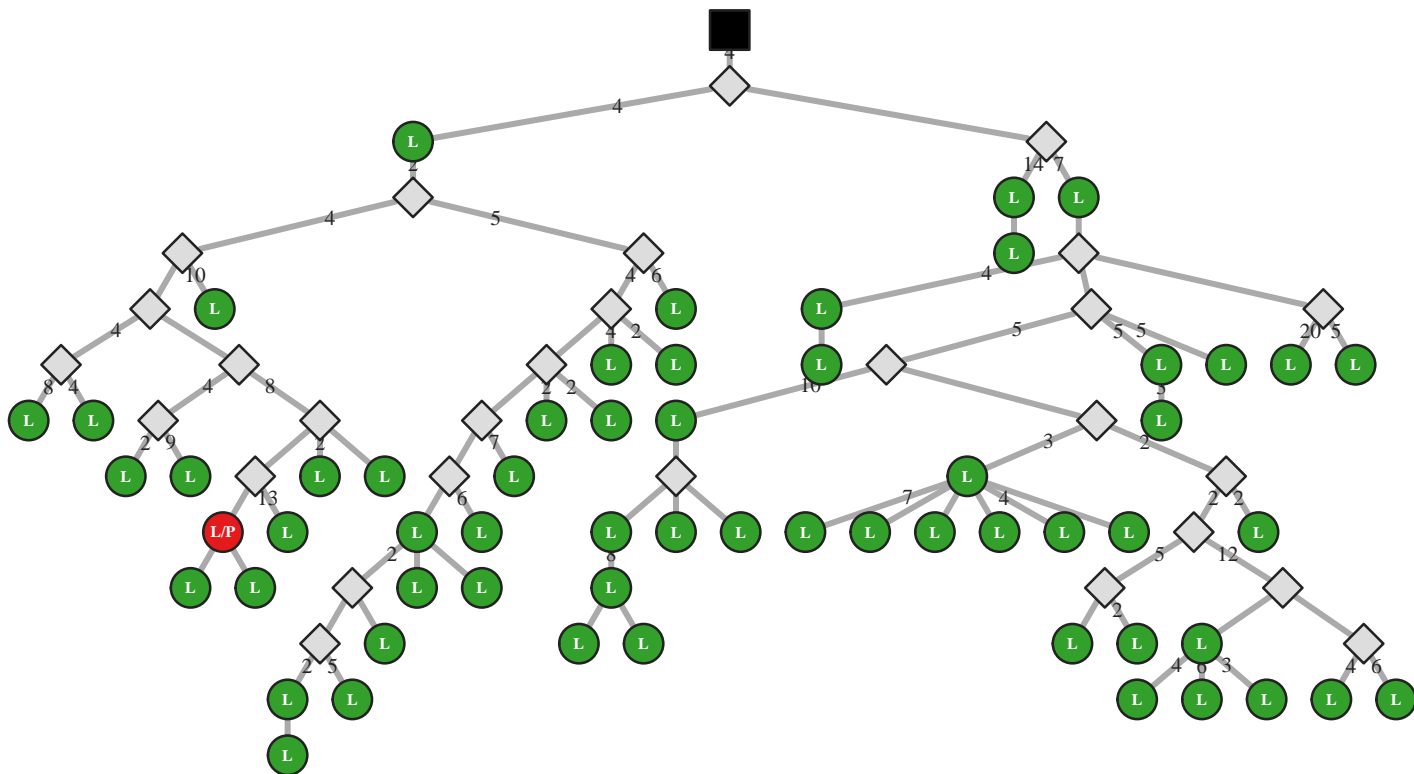

M5 IgG IGHV3-21/J4 39bp (25266)

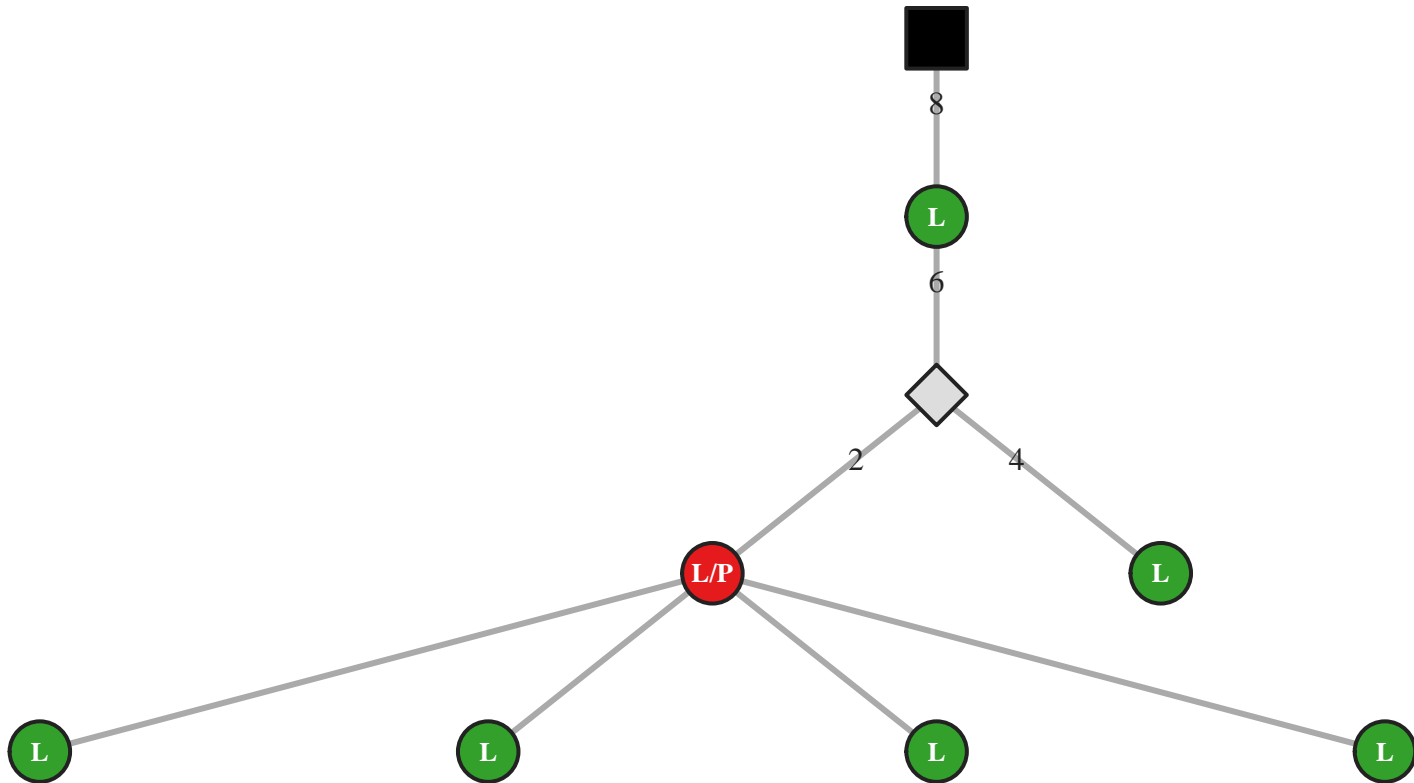

M5 IgG IGHV3-21/J4 42bp (51291)

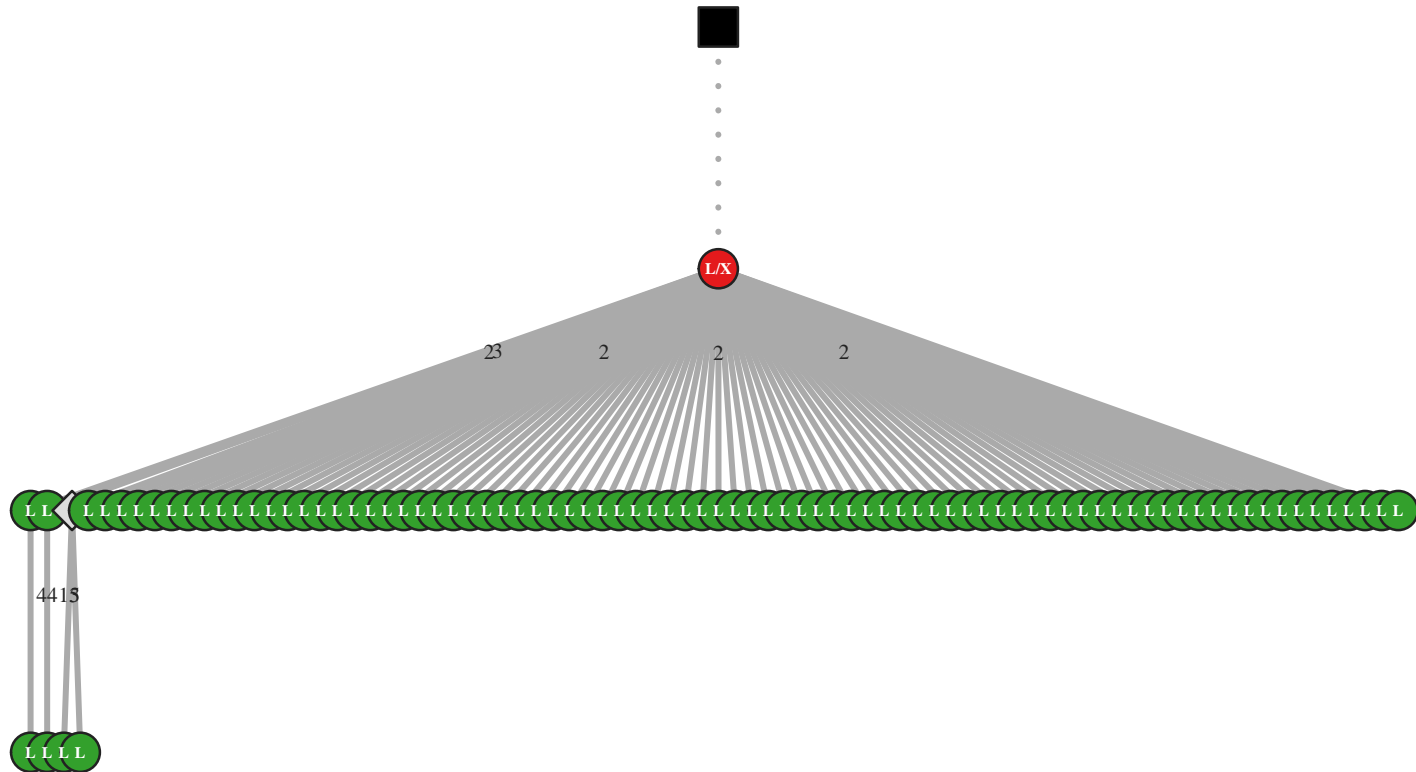

M5 IgG IGHV3-21/J4 42bp (51301)

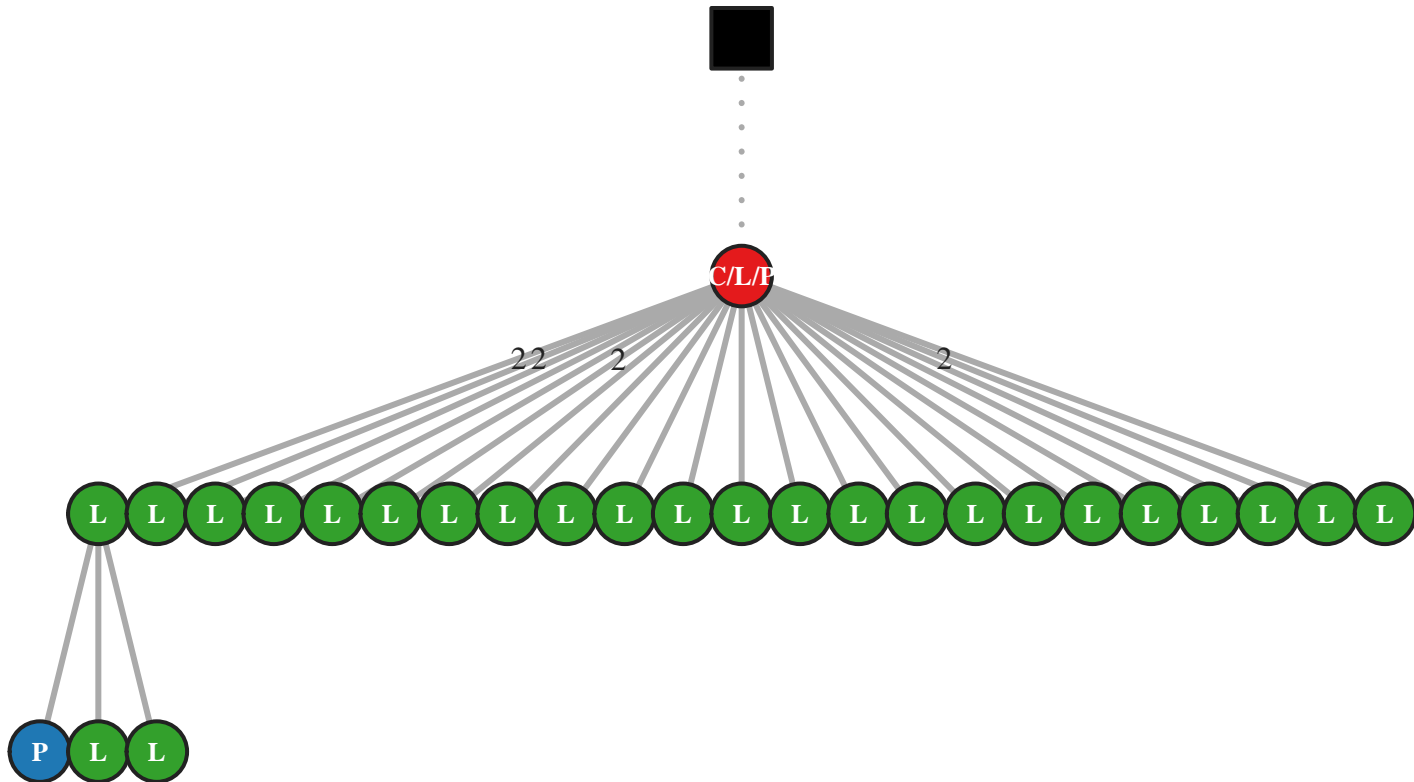

M5 IgG IGHV3-21/J4 42bp (51337)

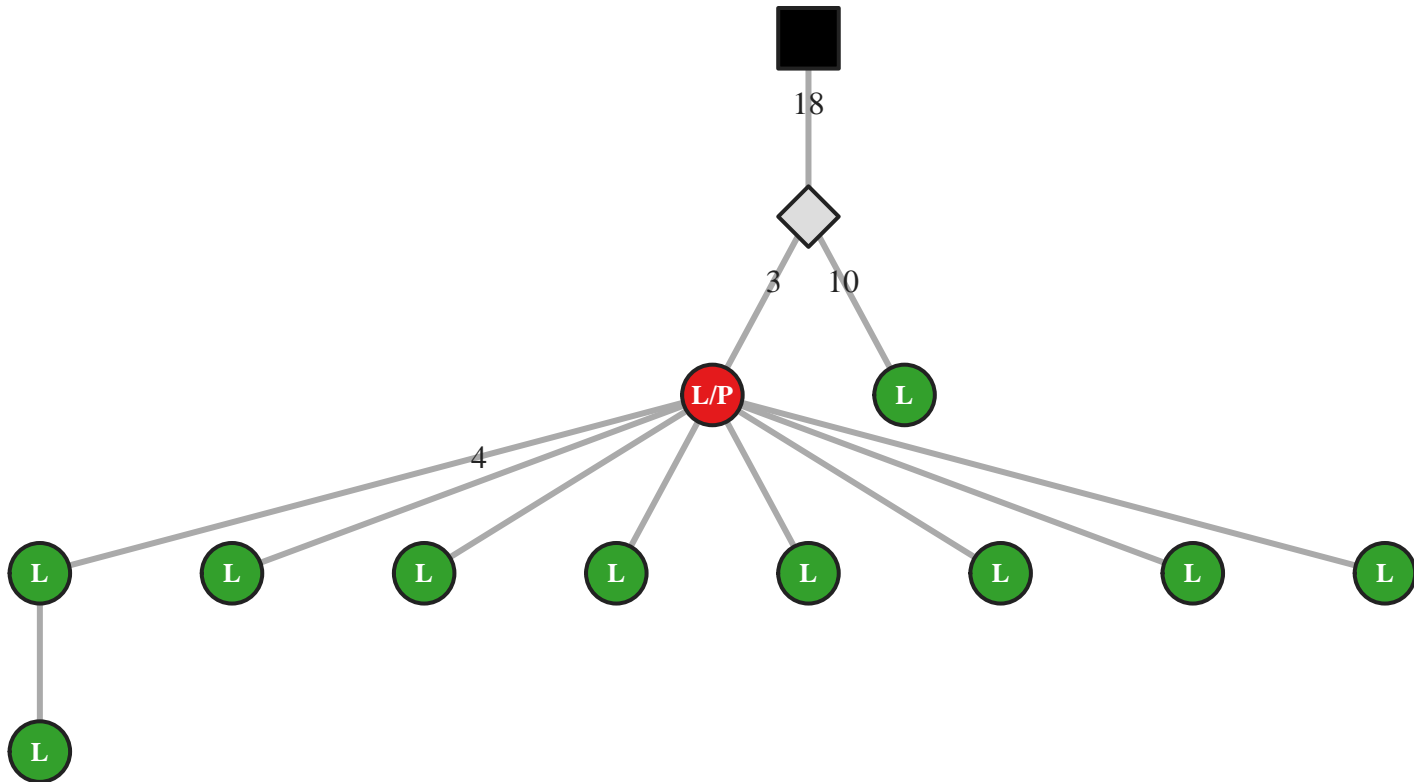

M5 IgG IGHV3-21/J4 42bp (51341)

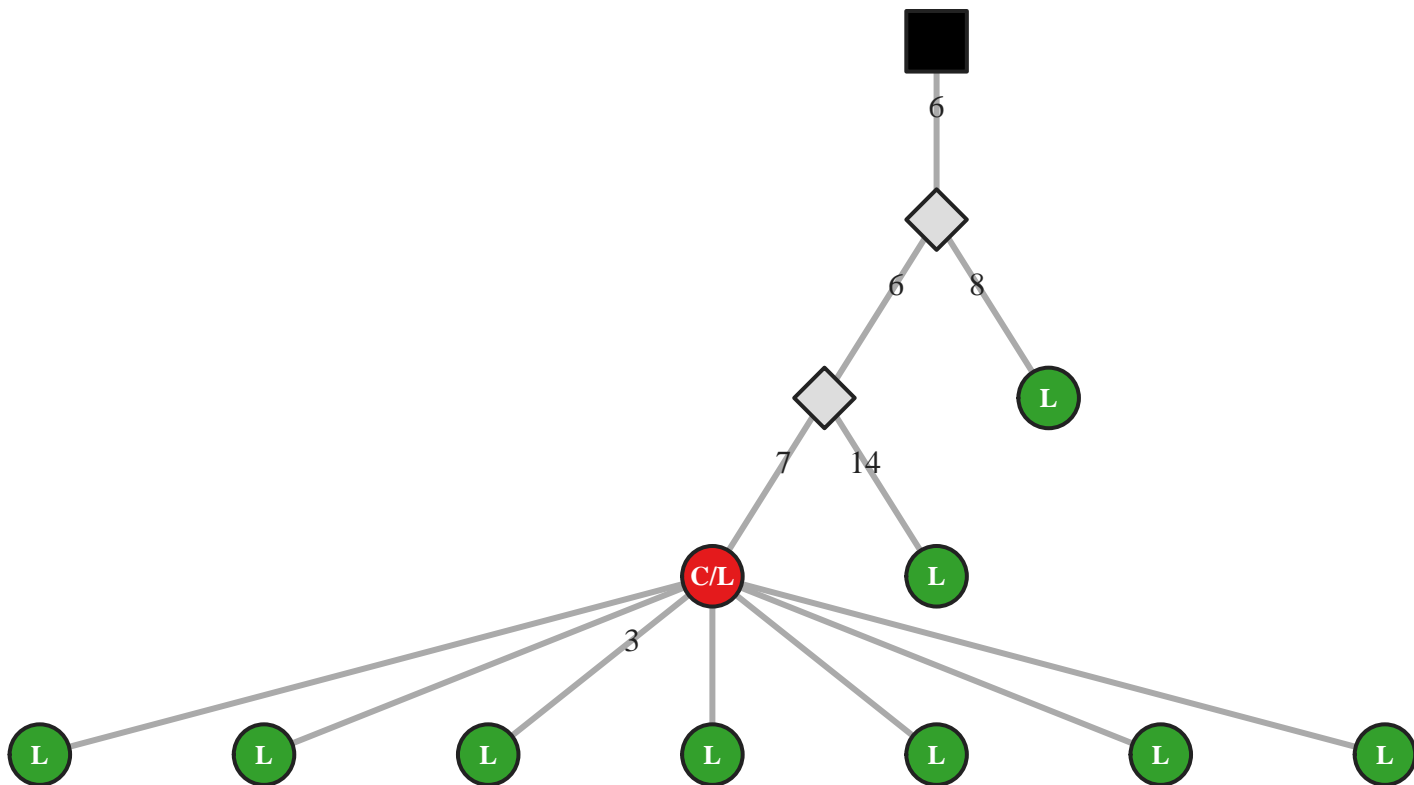

M5 IgG IGHV3-21/J4 42bp (51343)

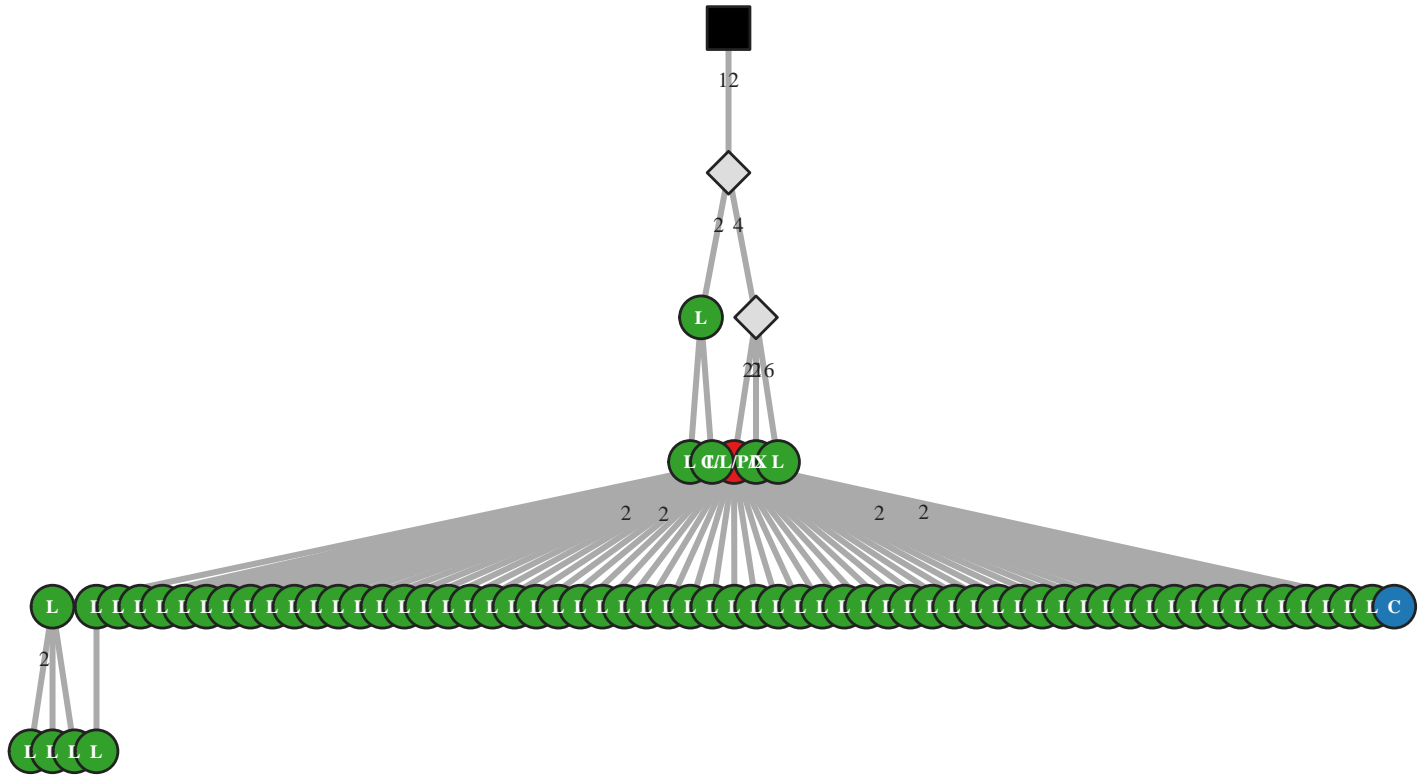

M5 IgG IGHV3-21/J4 45bp (16426)

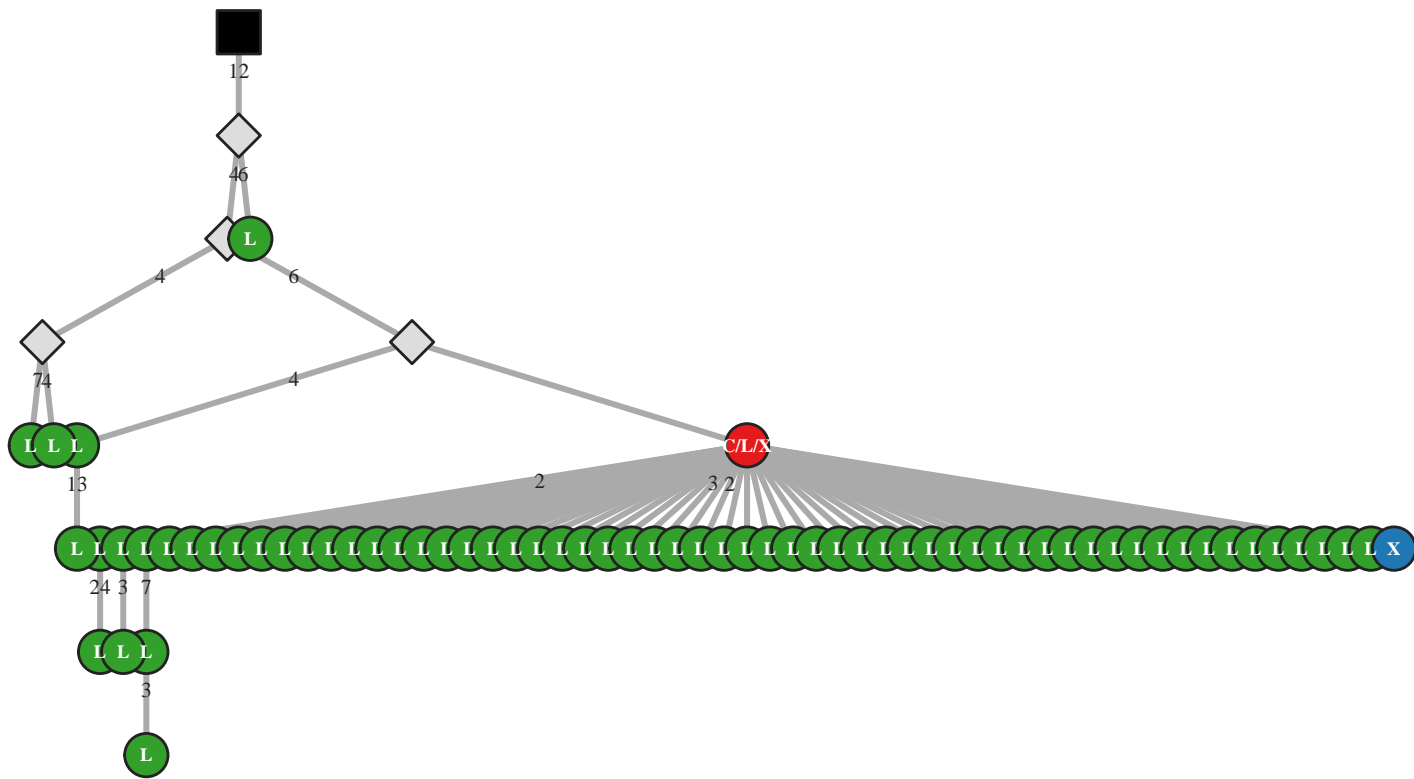

M5 IgG IGHV3-21/J4 45bp (16431)

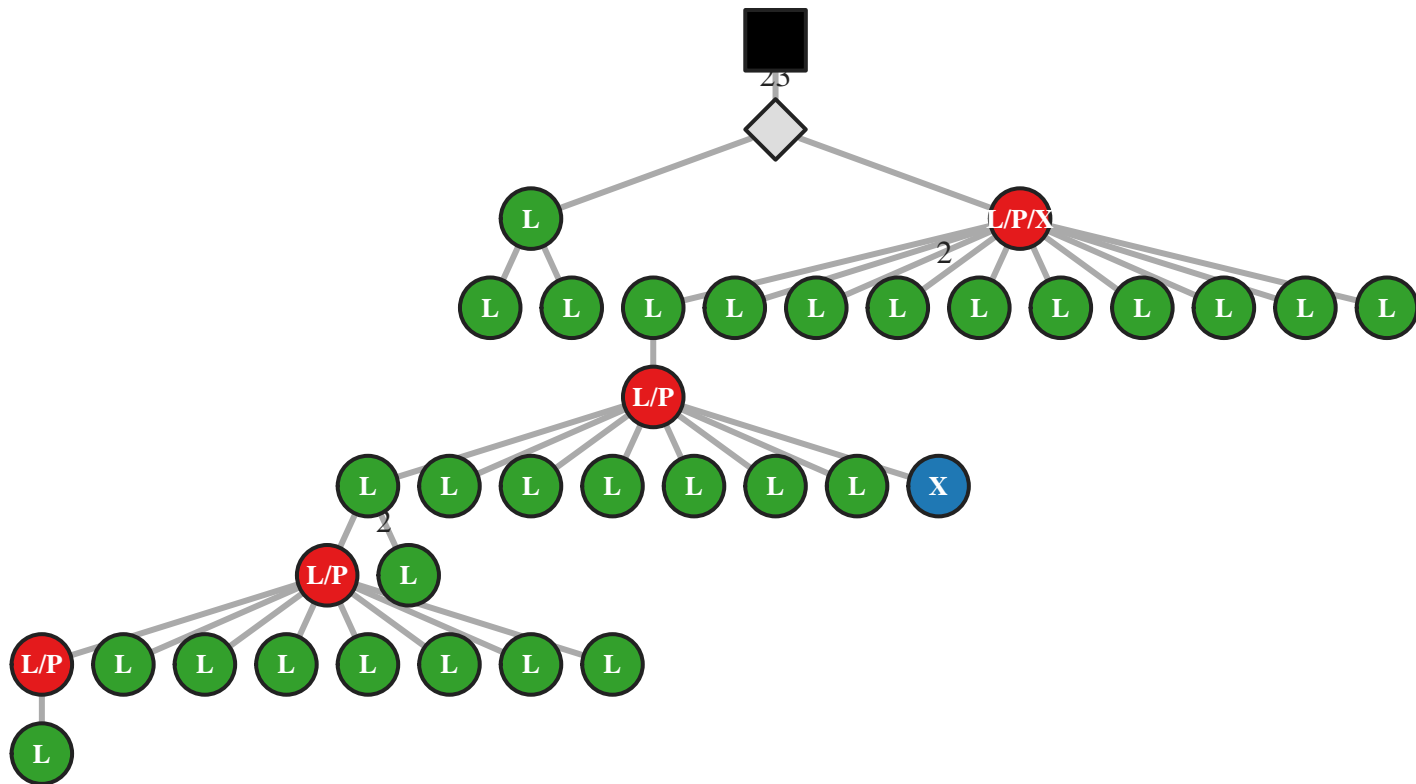

M5 IgG IGHV3-21/J4 45bp (16432)

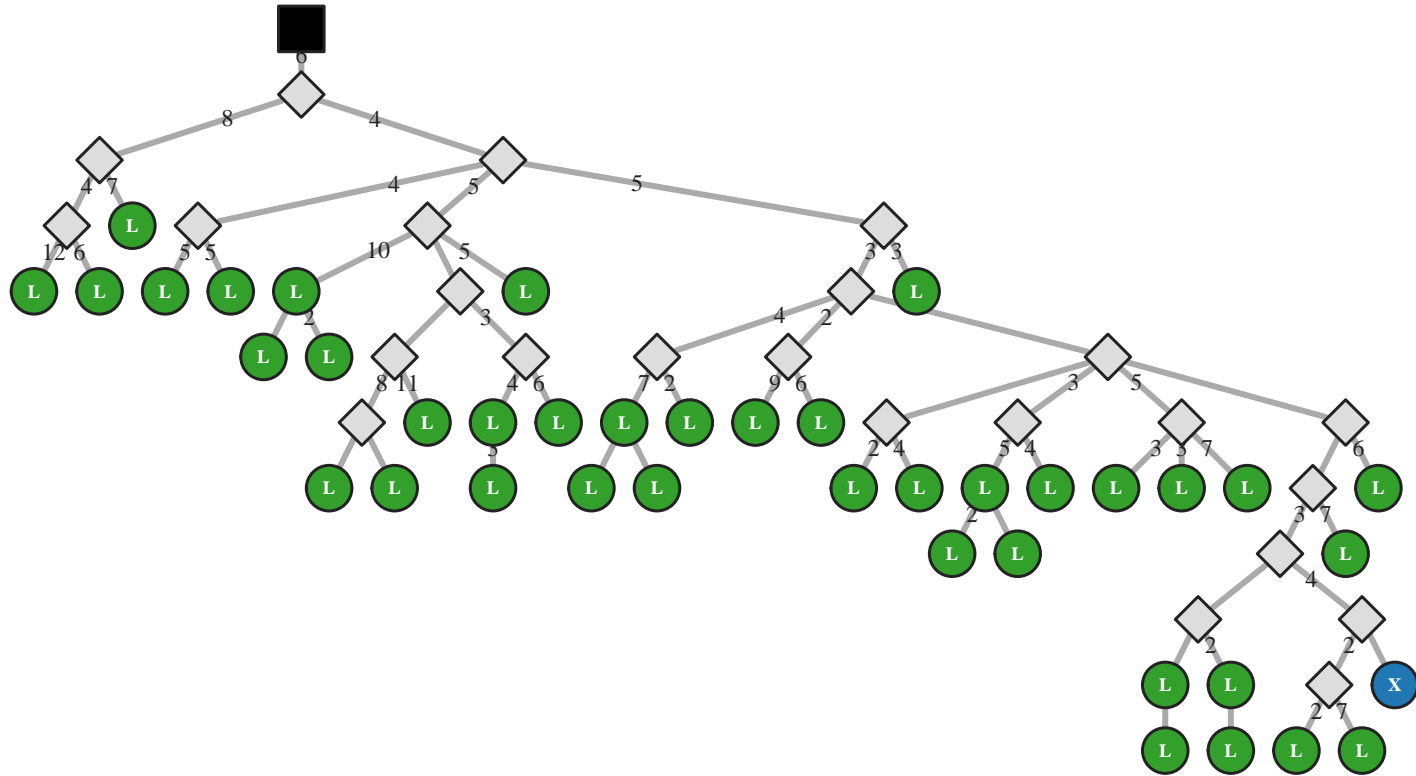

M5 IgG IGHV3-21/J4 45bp (16441)

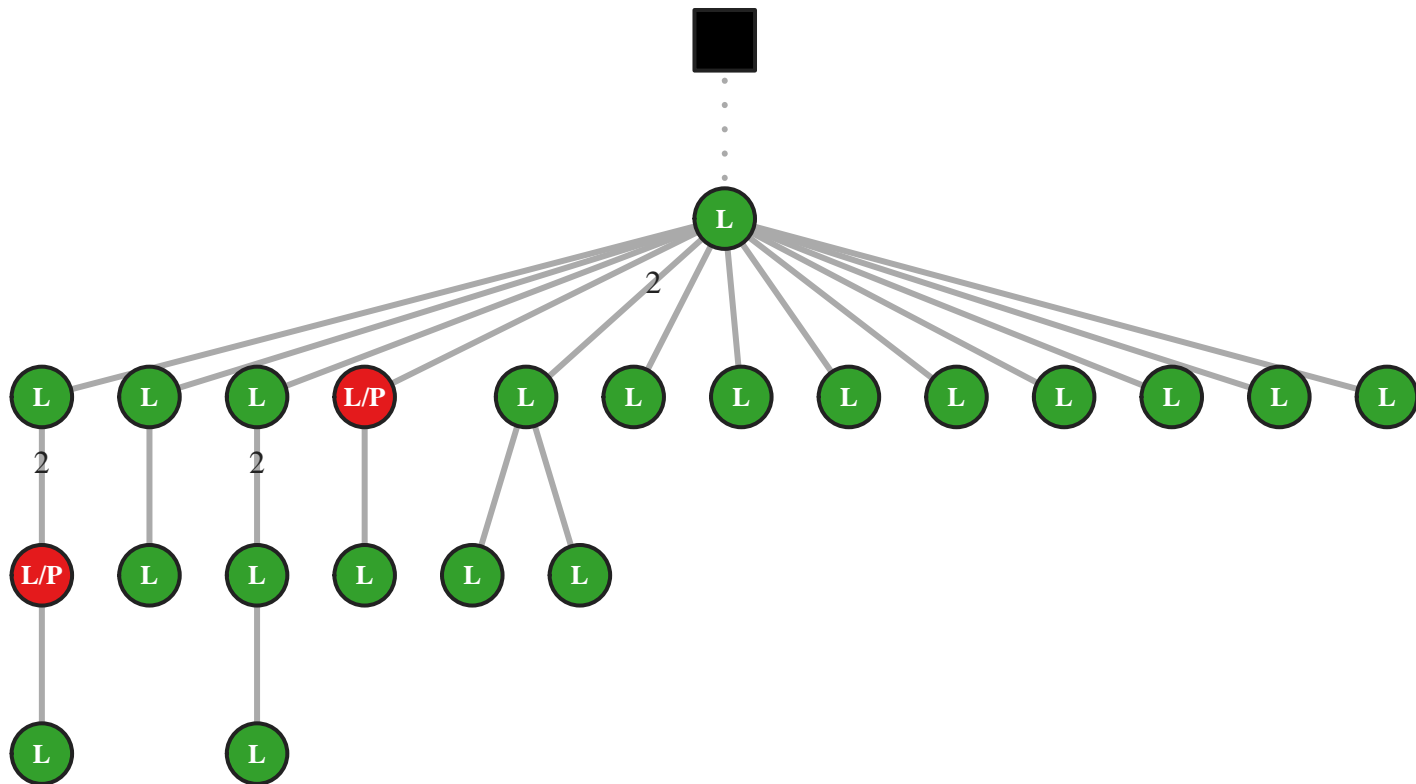

M5 IgG IGHV3-21/J4 45bp (16497)

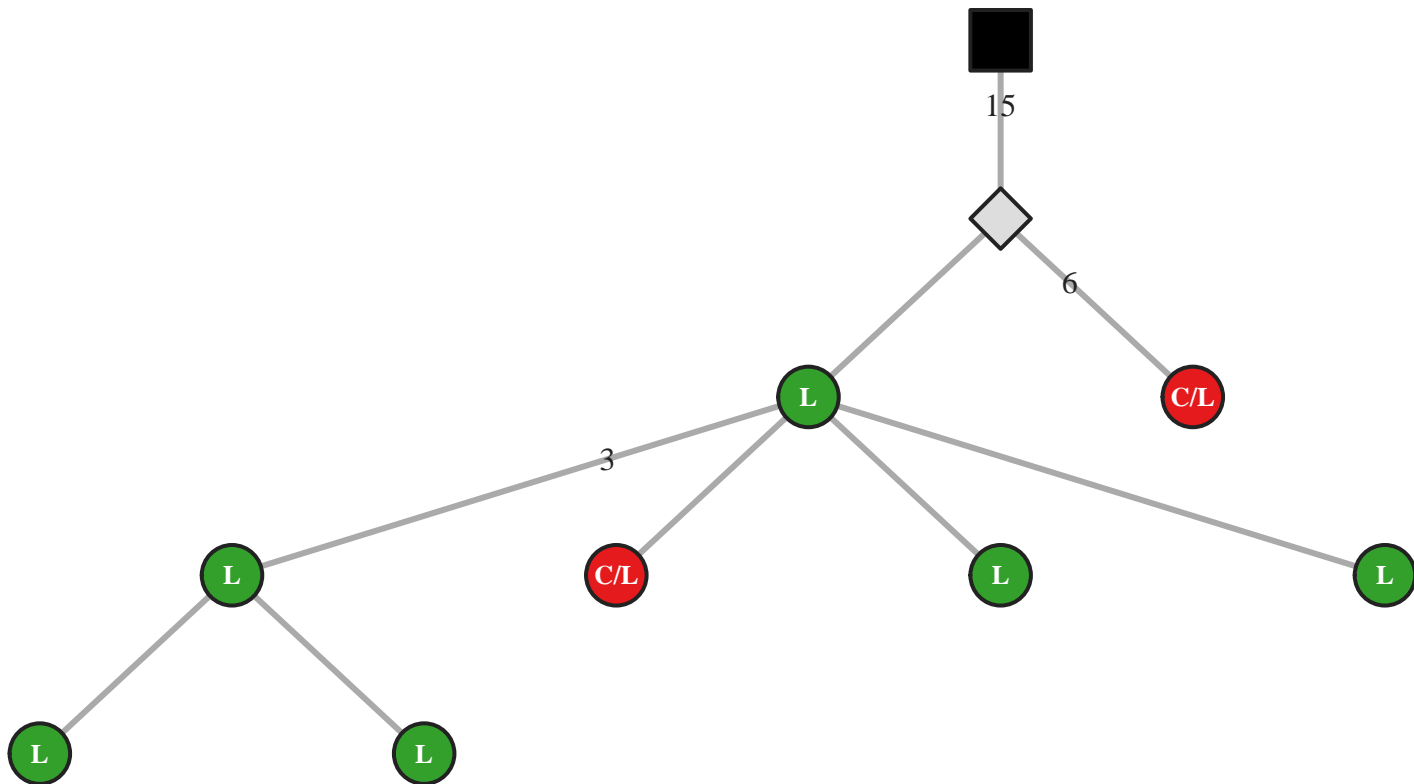

M5 IgG IGHV3-21/J4 45bp (16500)

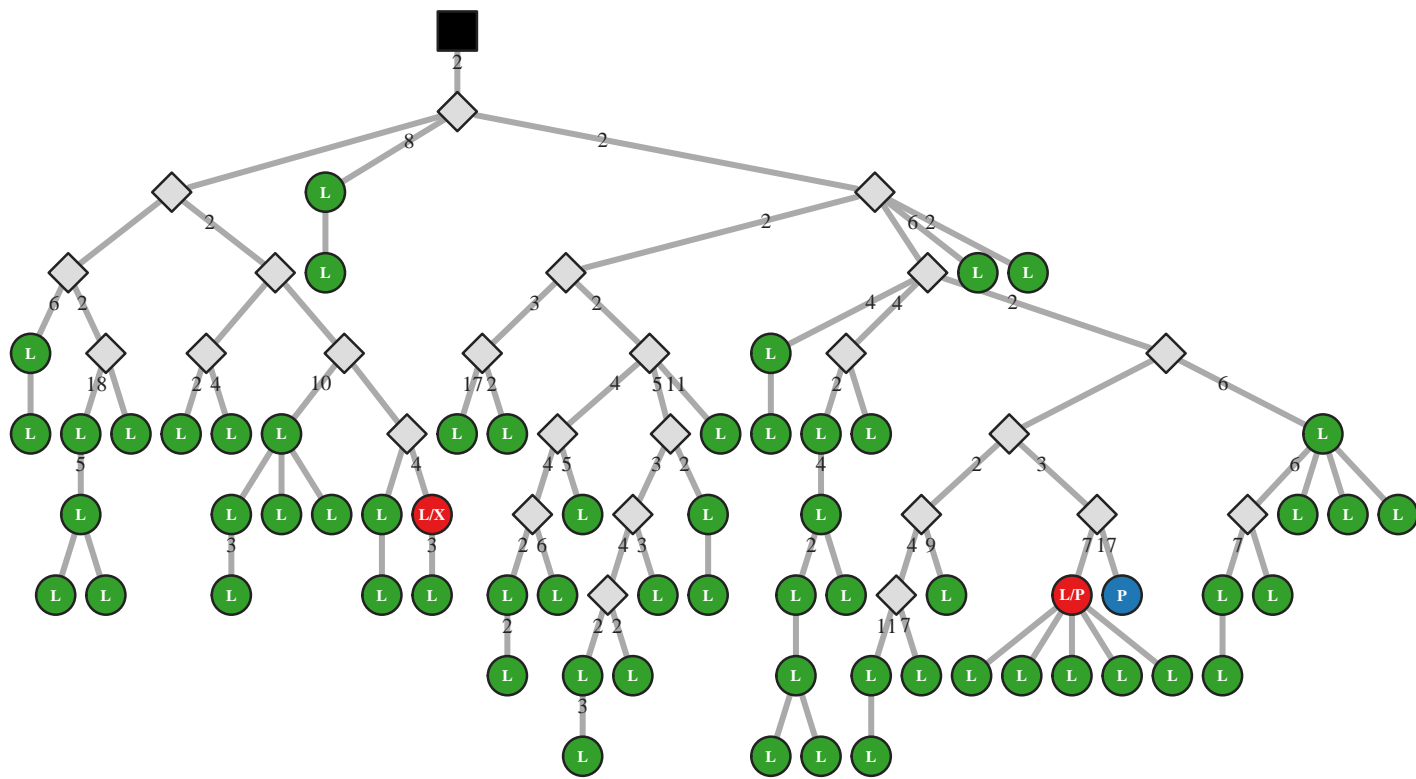

M5 IgG IGHV3-21/J4 45bp (16501)

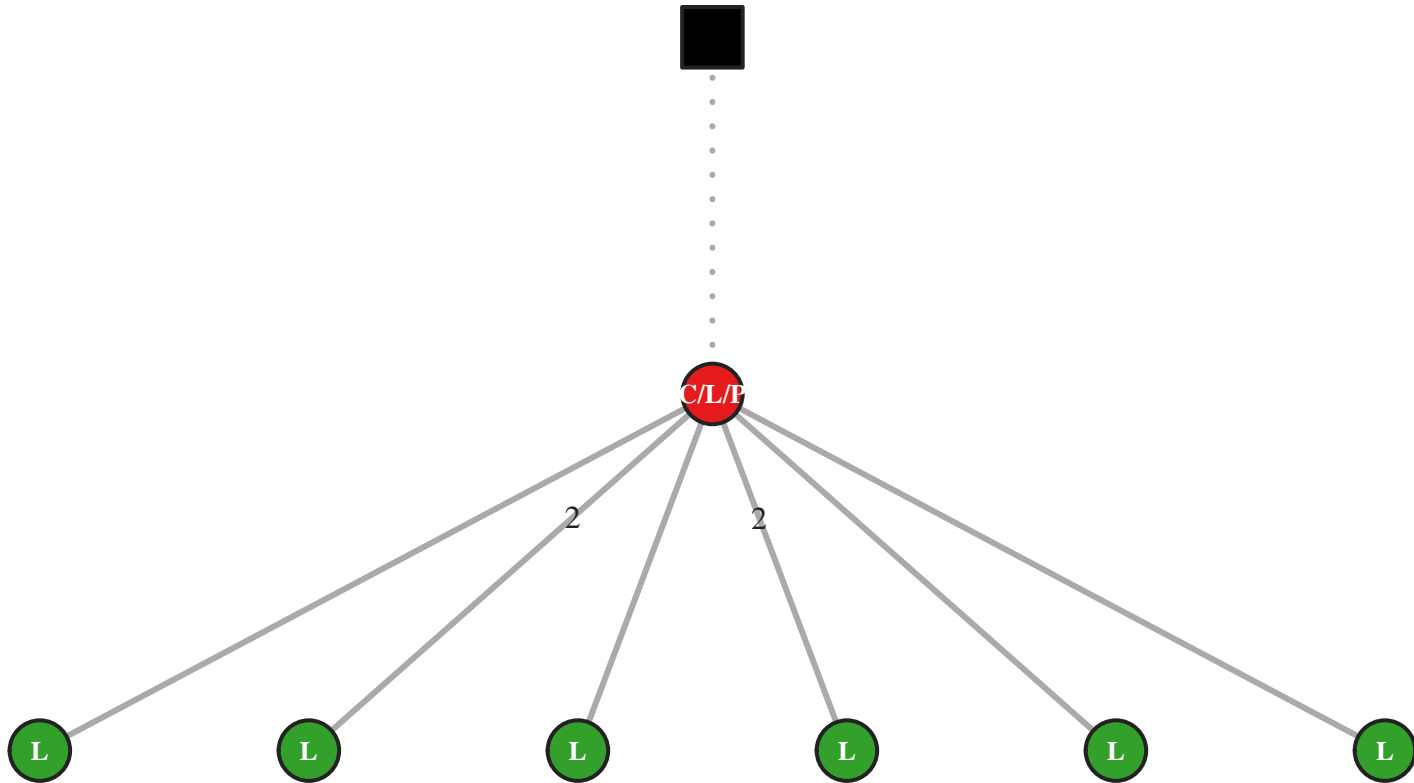

M5 IgG IGHV3-21/J4 48bp (25344)

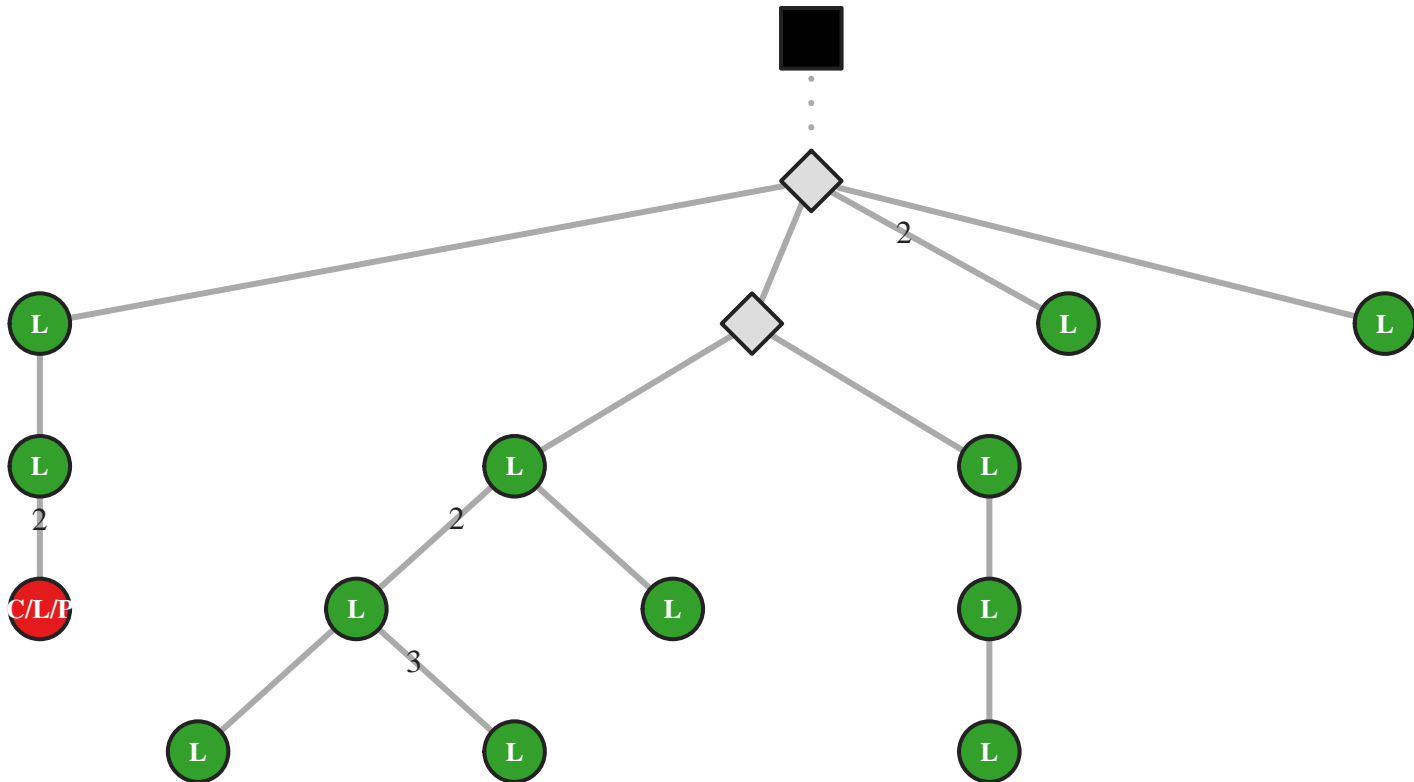

M5 IgG IGHV3-21/J4 48bp (25355)

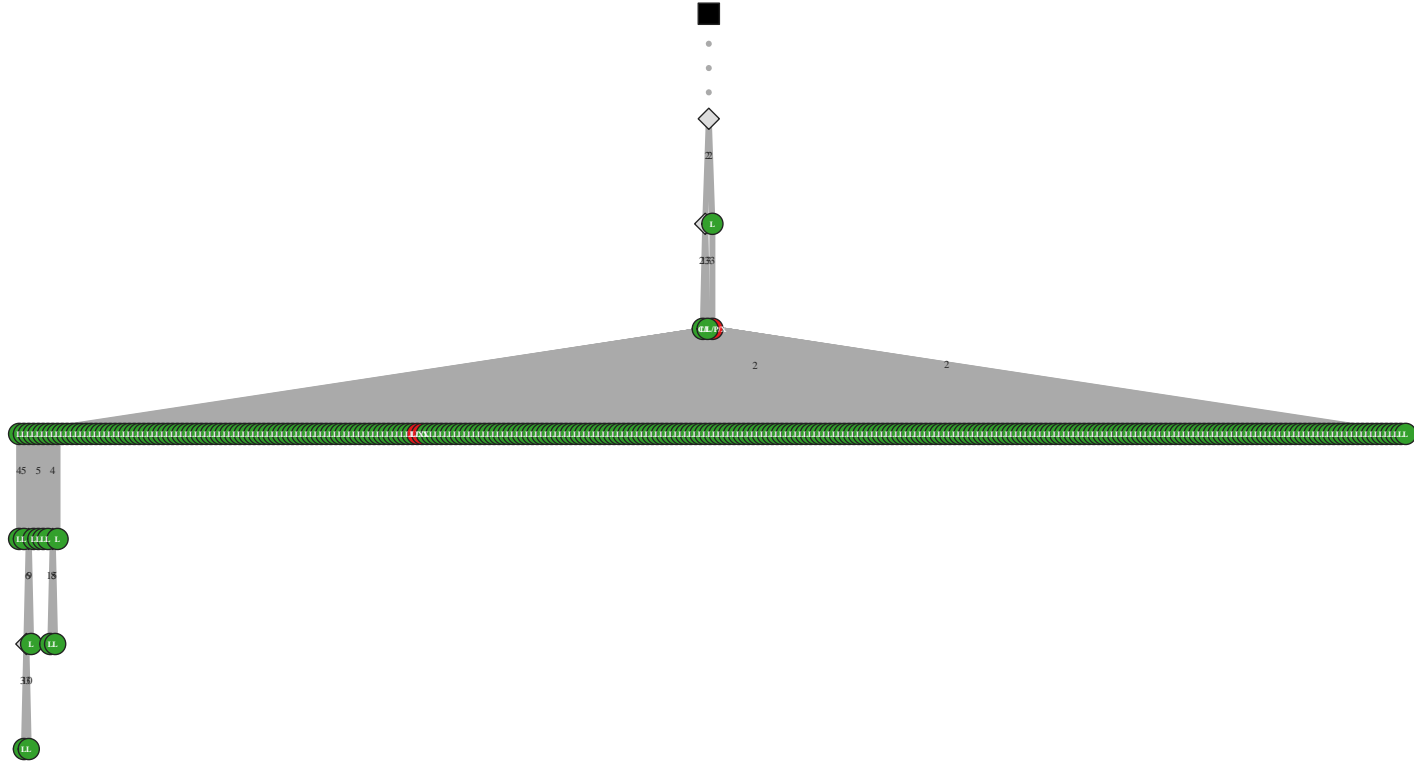

M5 IgG IGHV3-21/J4 48bp (25363)

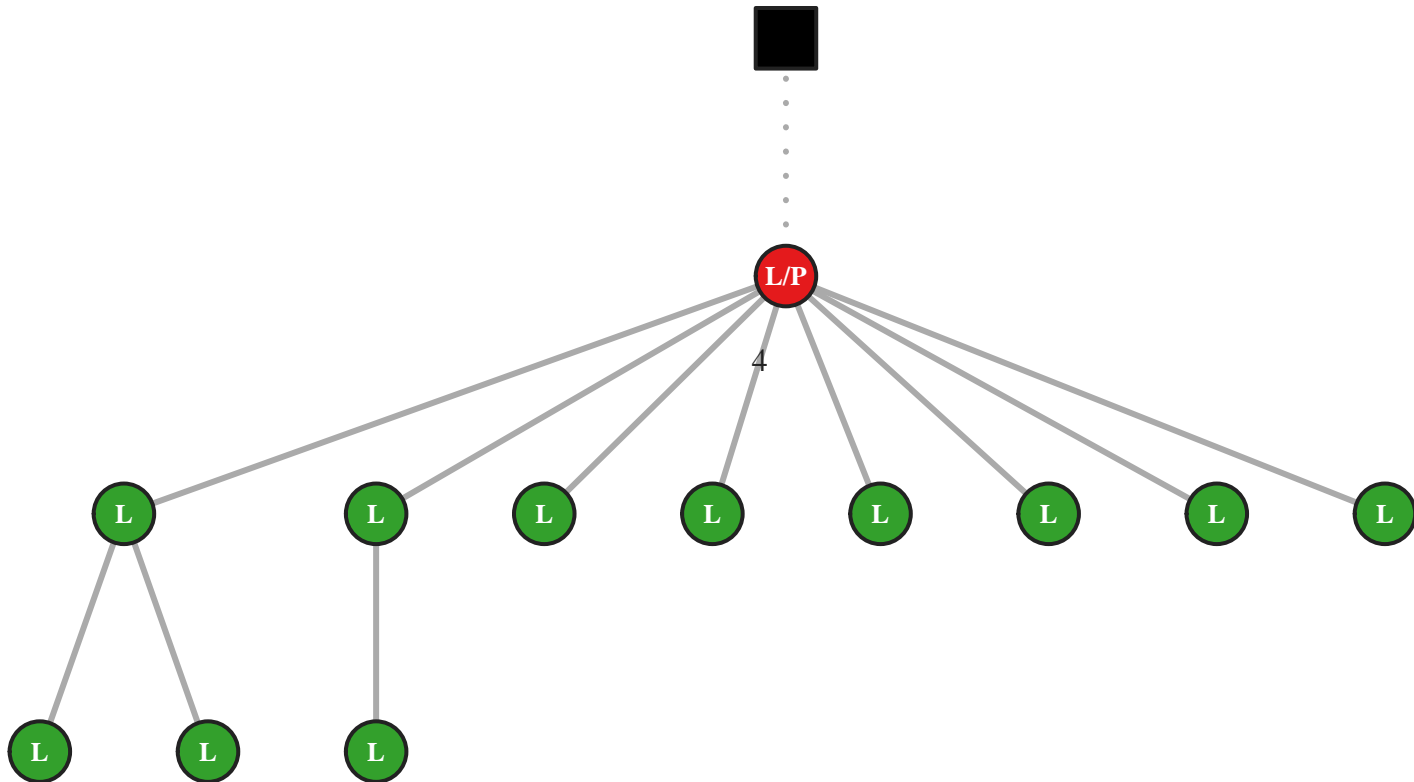

M5 IgG IGHV3-21/J4 48bp (25366)

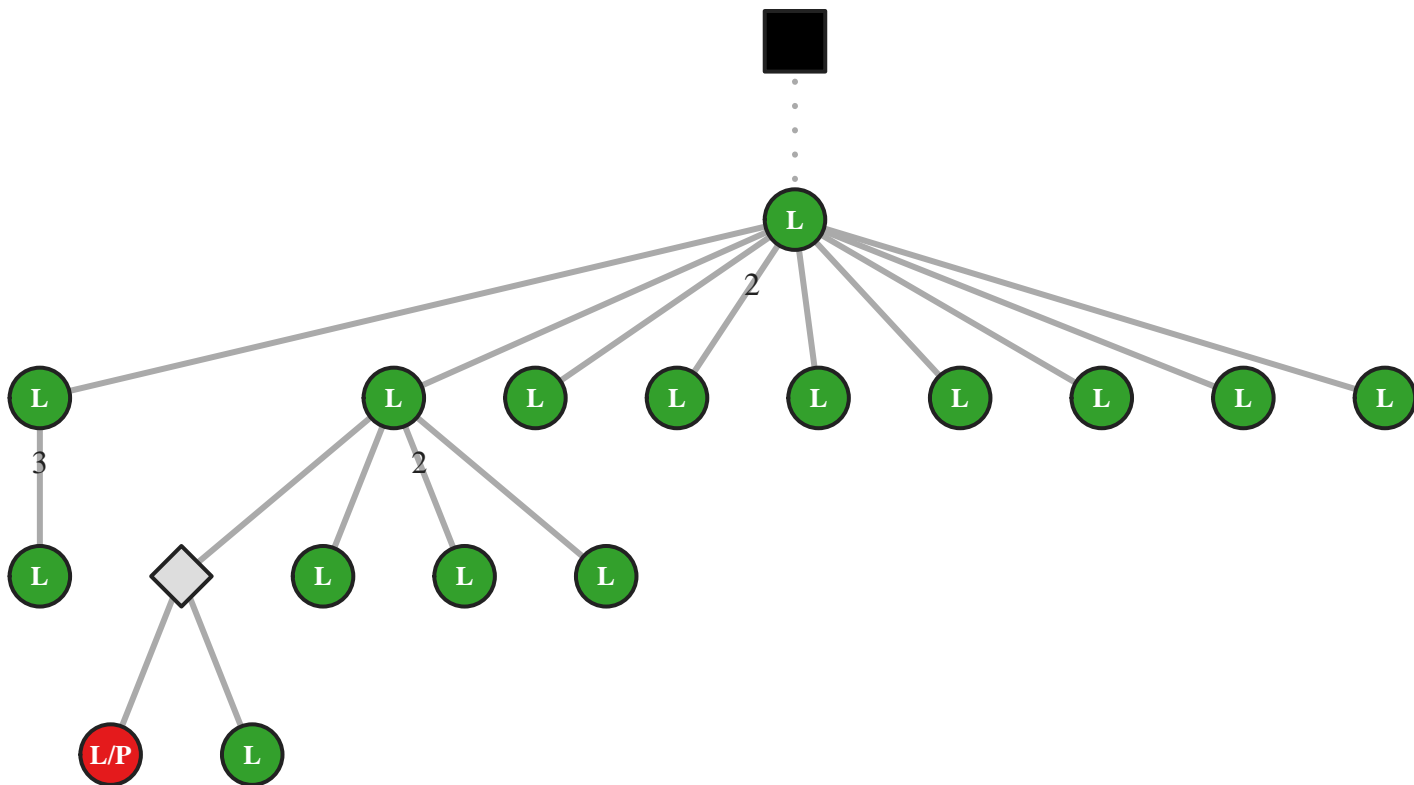

M5 IgG IGHV3-21/J4 48bp (25377)

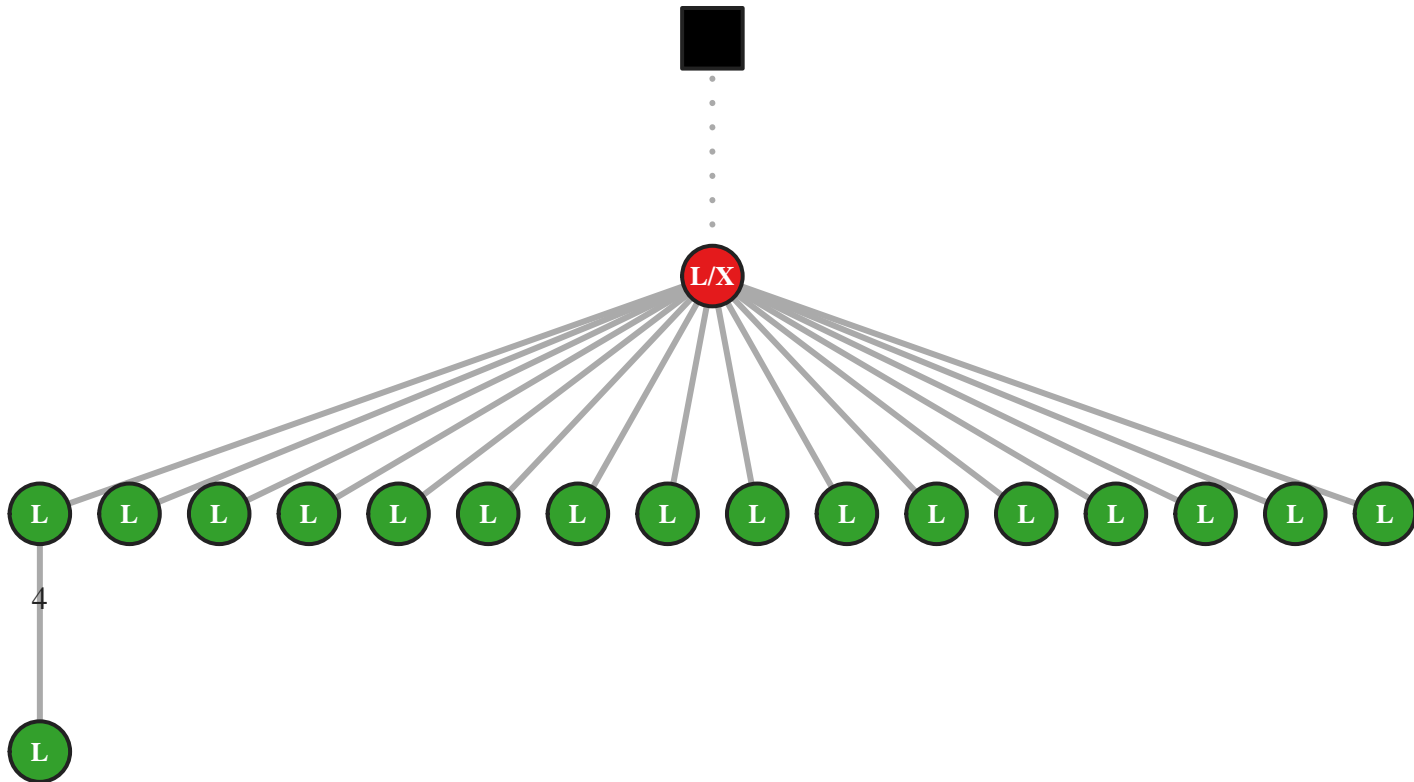

M5 IgG IGHV3-21/J4 48bp (25390)

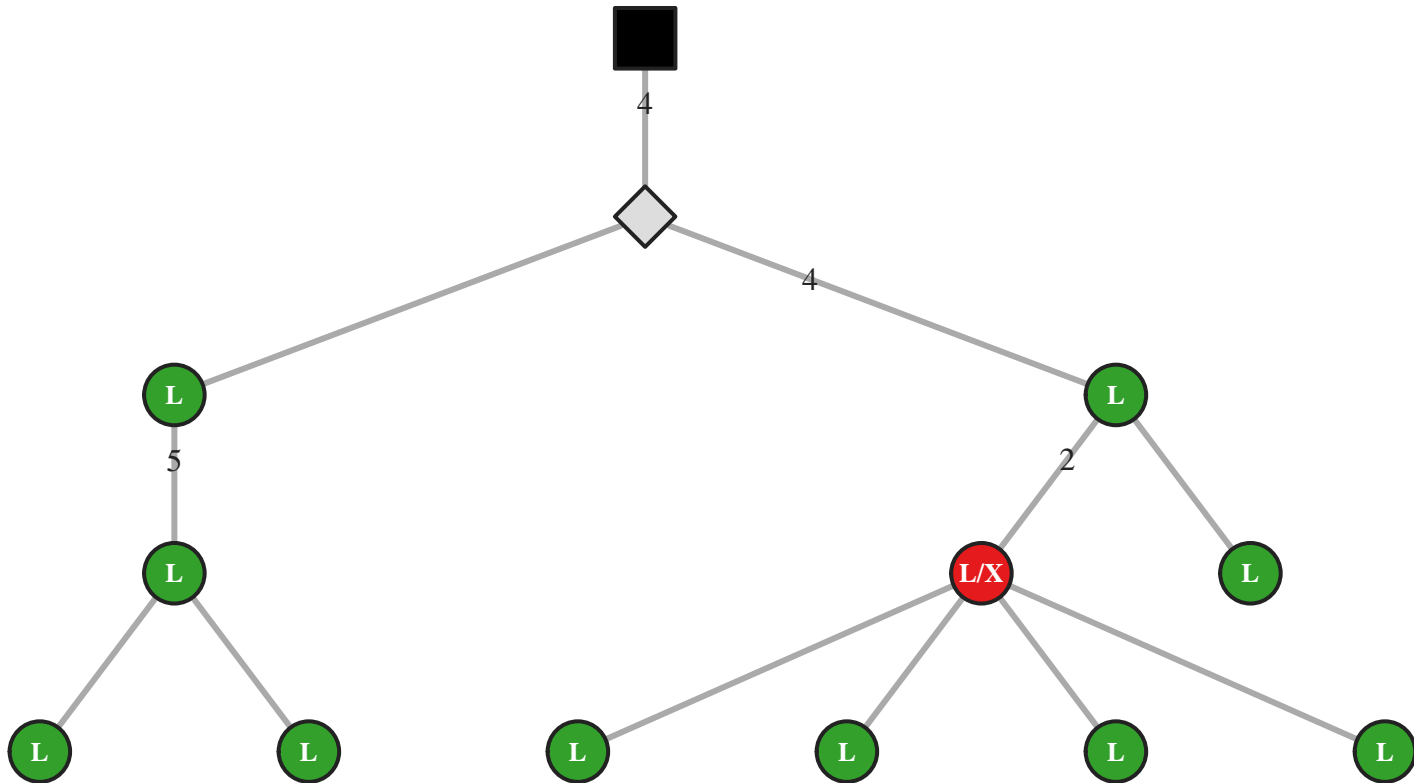

M5 IgG IGHV3-21/J4 48bp (25402)

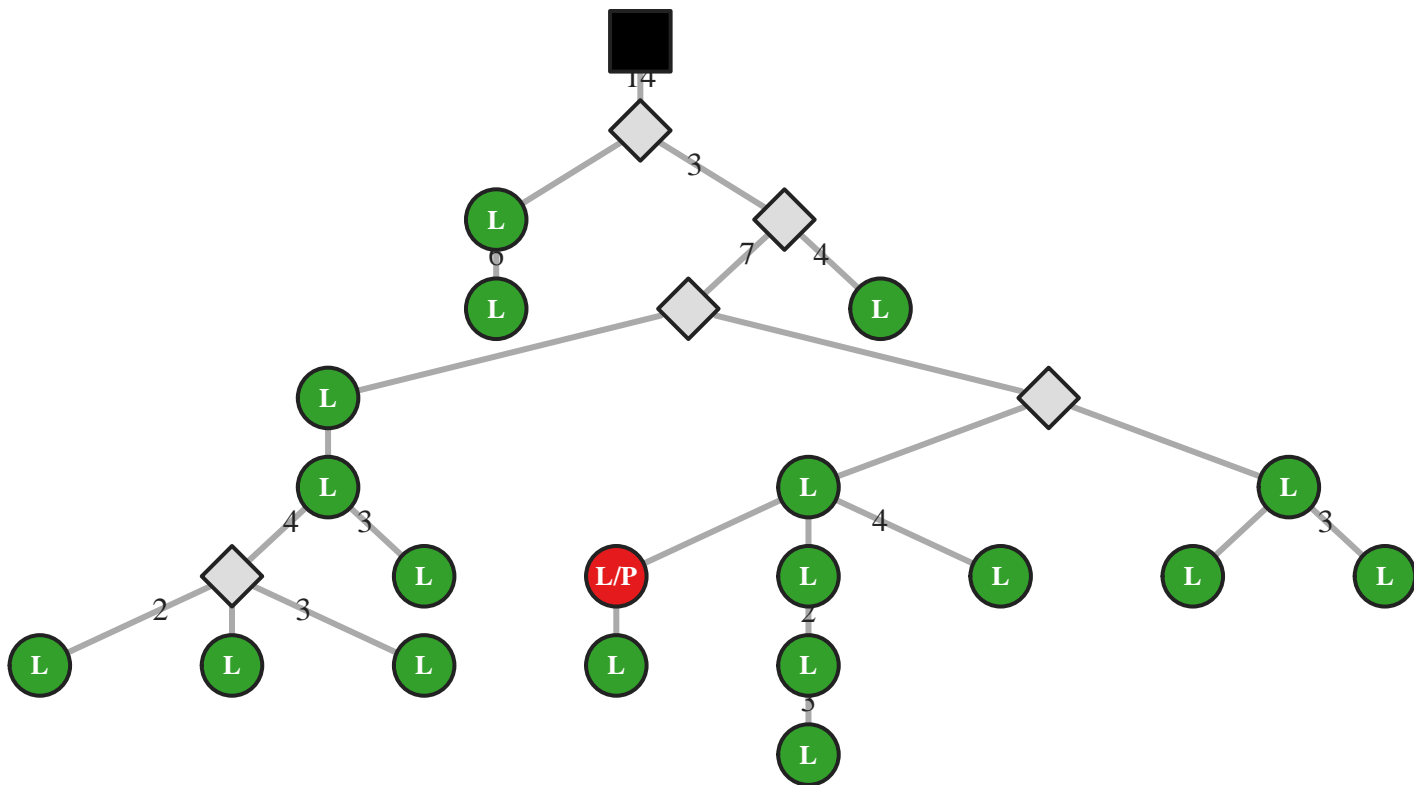

M5 IgM IGHV3-21/J4 48bp (37741)

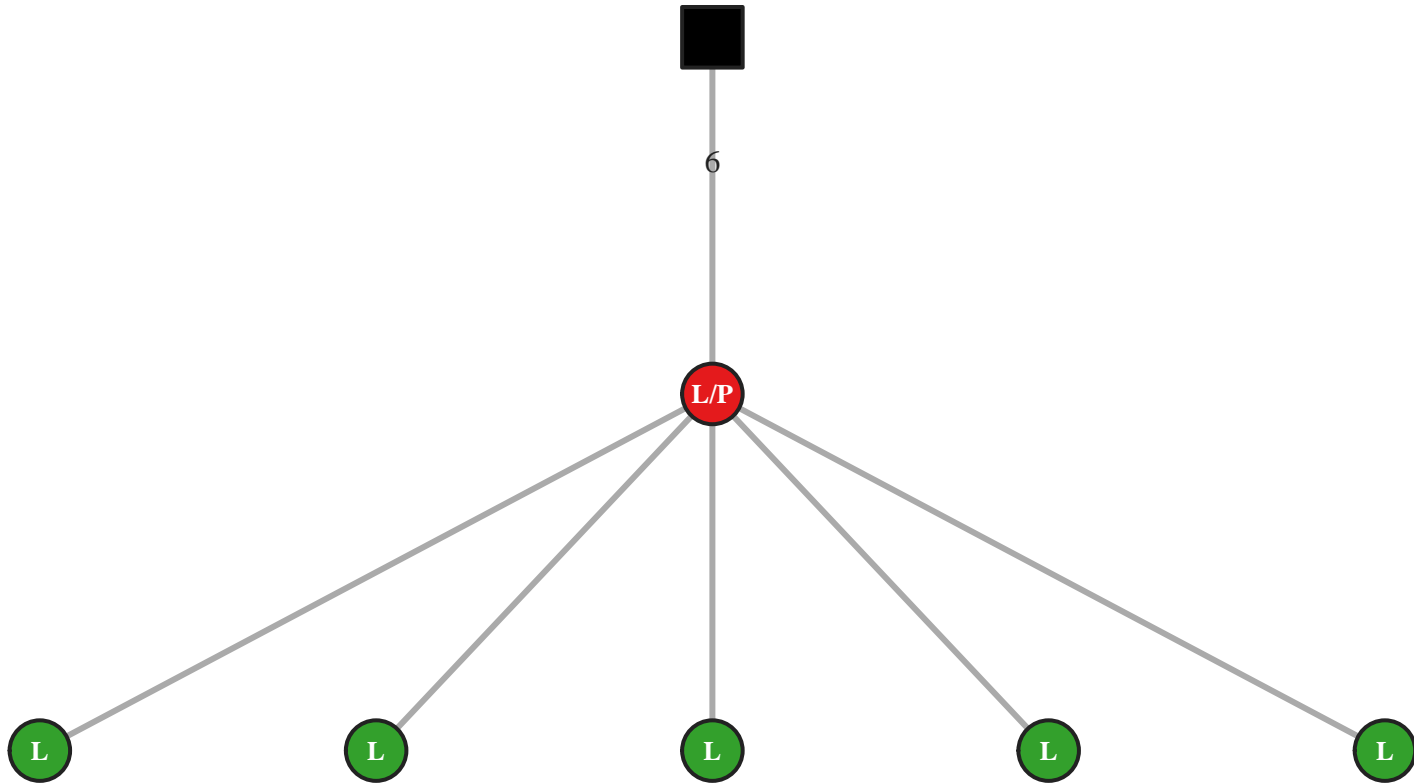

M5 IgA IGHV3-21/J4 51bp (48728)

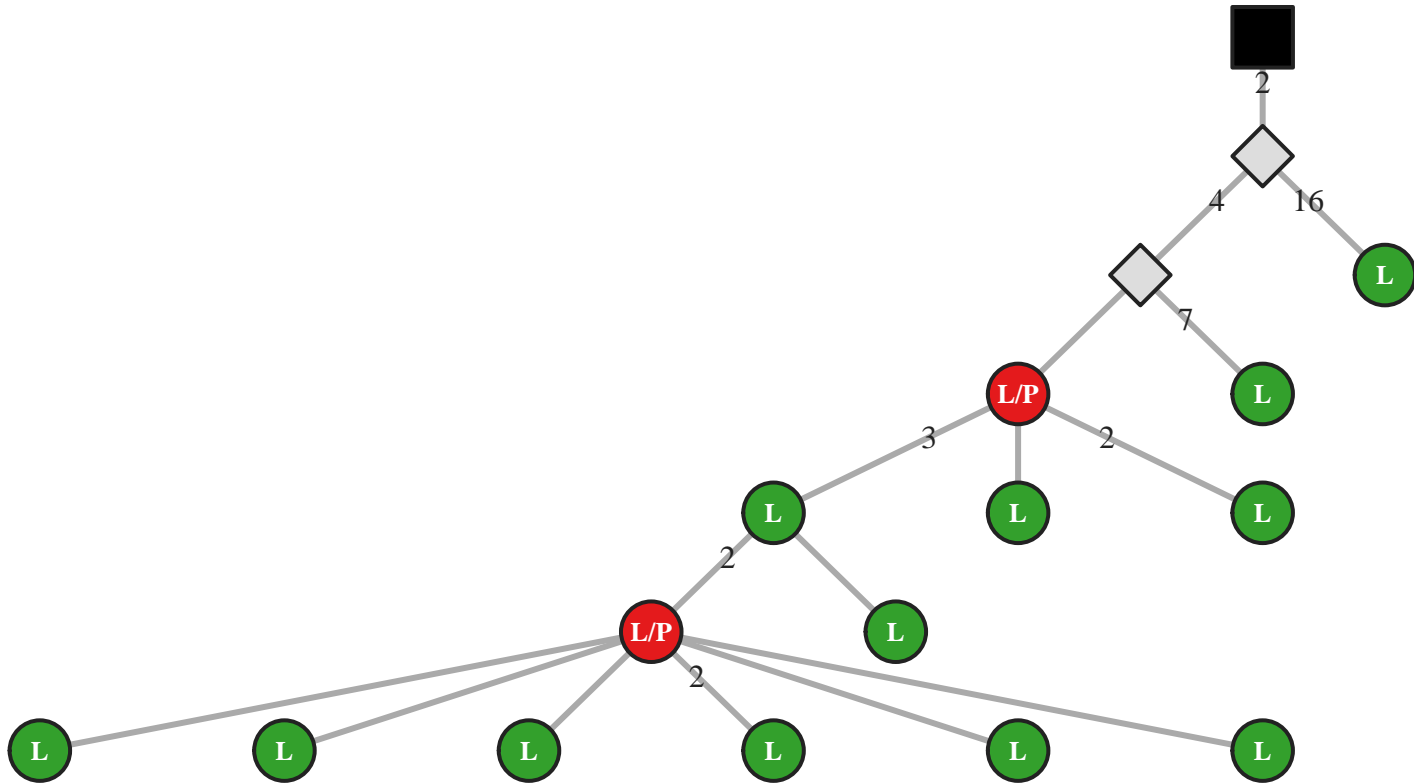

M5 IgG IGHV3-21/J4 51bp (16568)

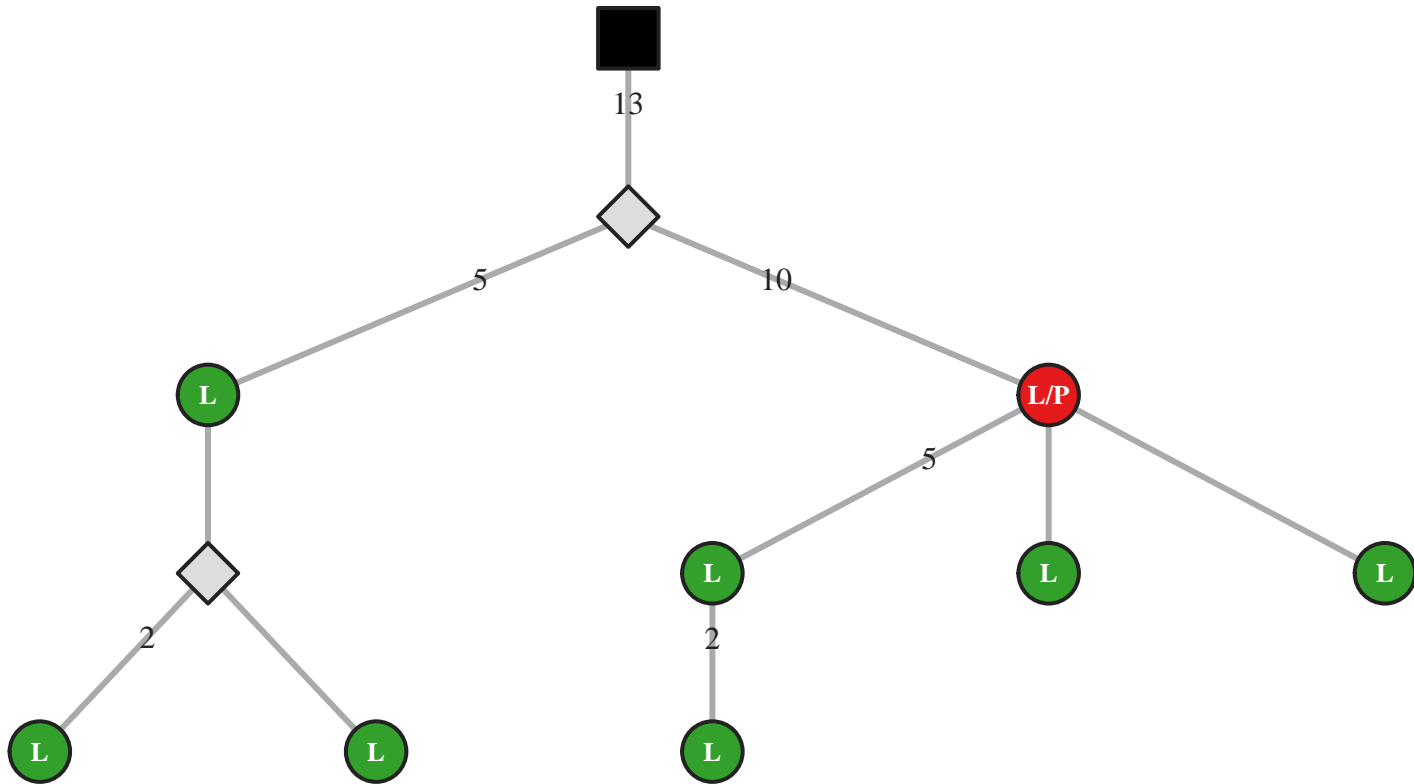

M5 IgG IGHV3-21/J4 51bp (16581)

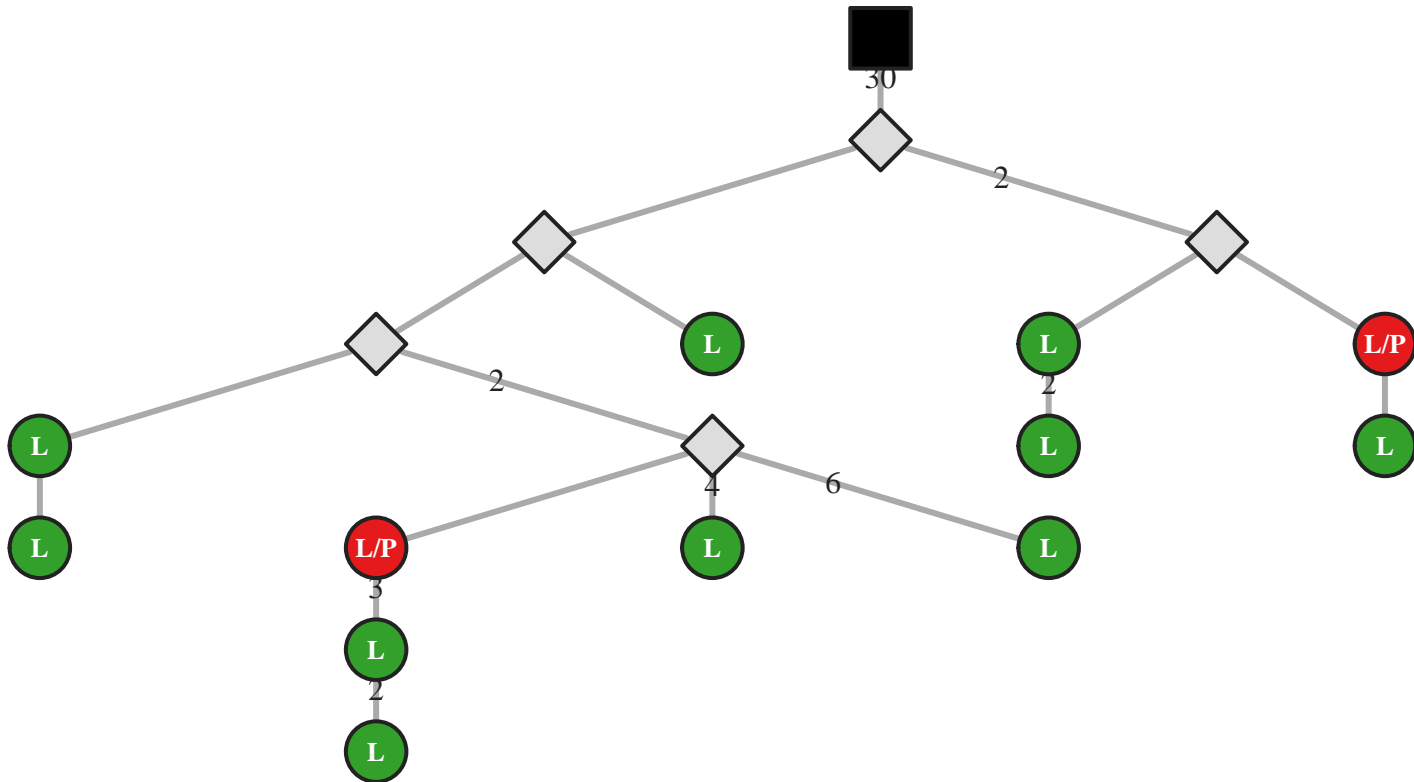

M5 IgG IGHV3-21/J4 51bp (16585)

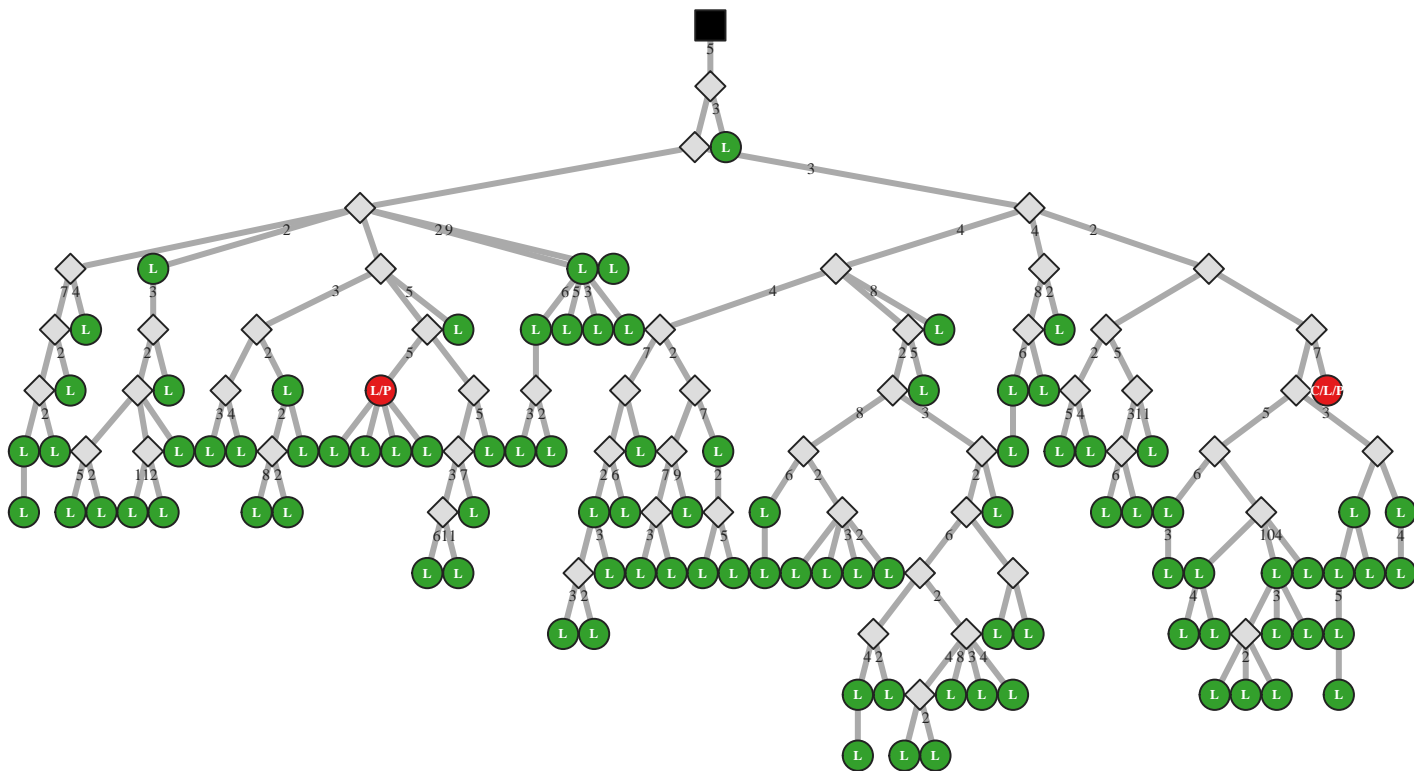

M5 IgG IGHV3-21/J4 51bp (16634)

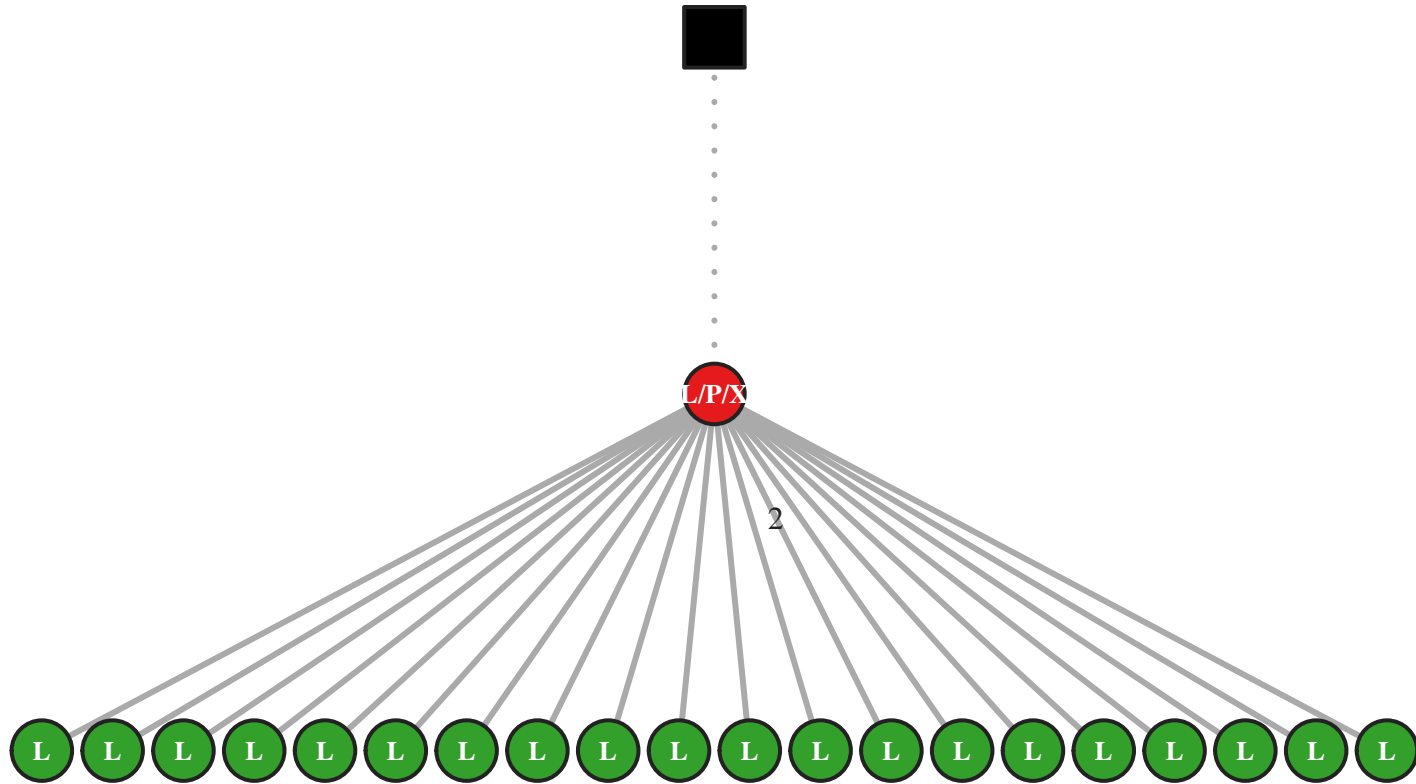

M5 IgG IGHV3-21/J4 51bp (16647)

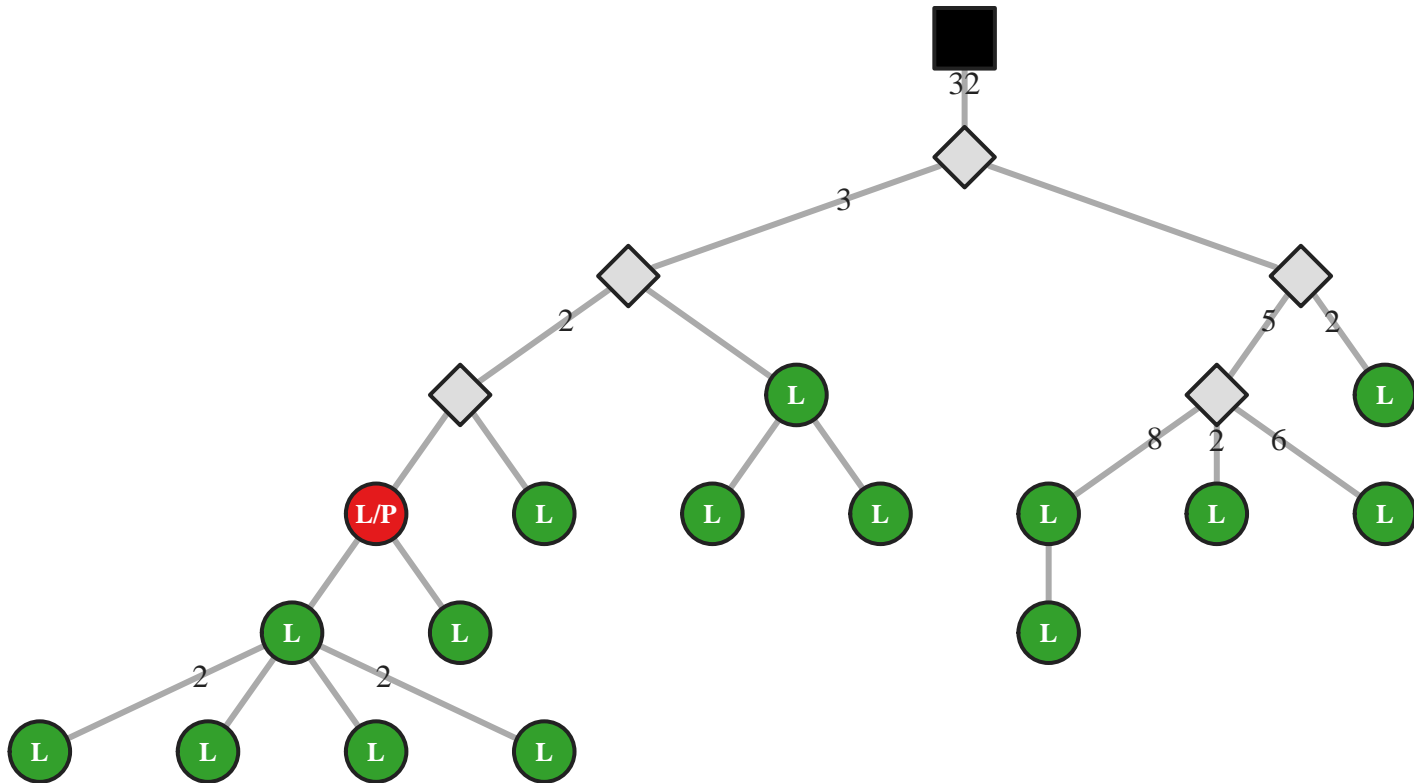

M5 IgG IGHV3-21/J4 54bp (25427)

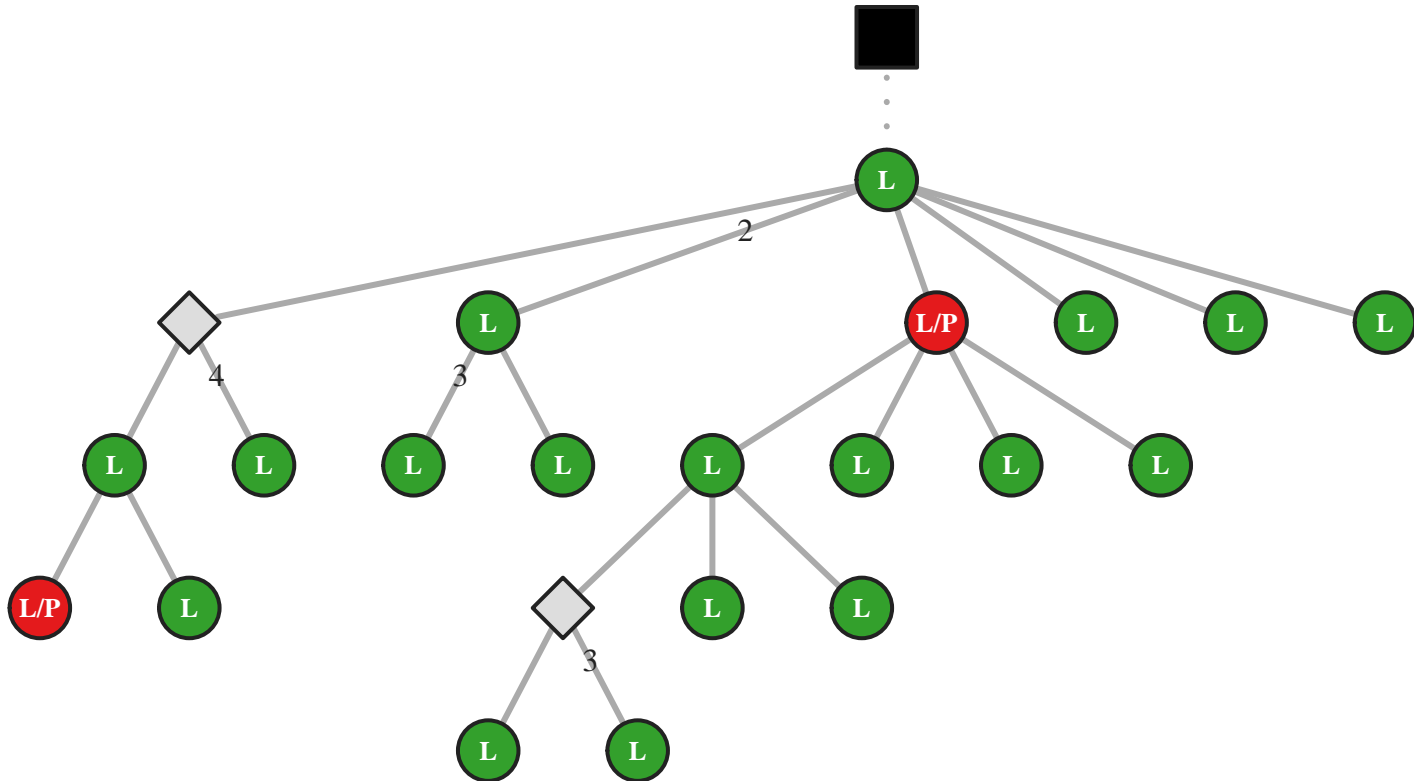

M5 IgG IGHV3-21/J4 54bp (25465)

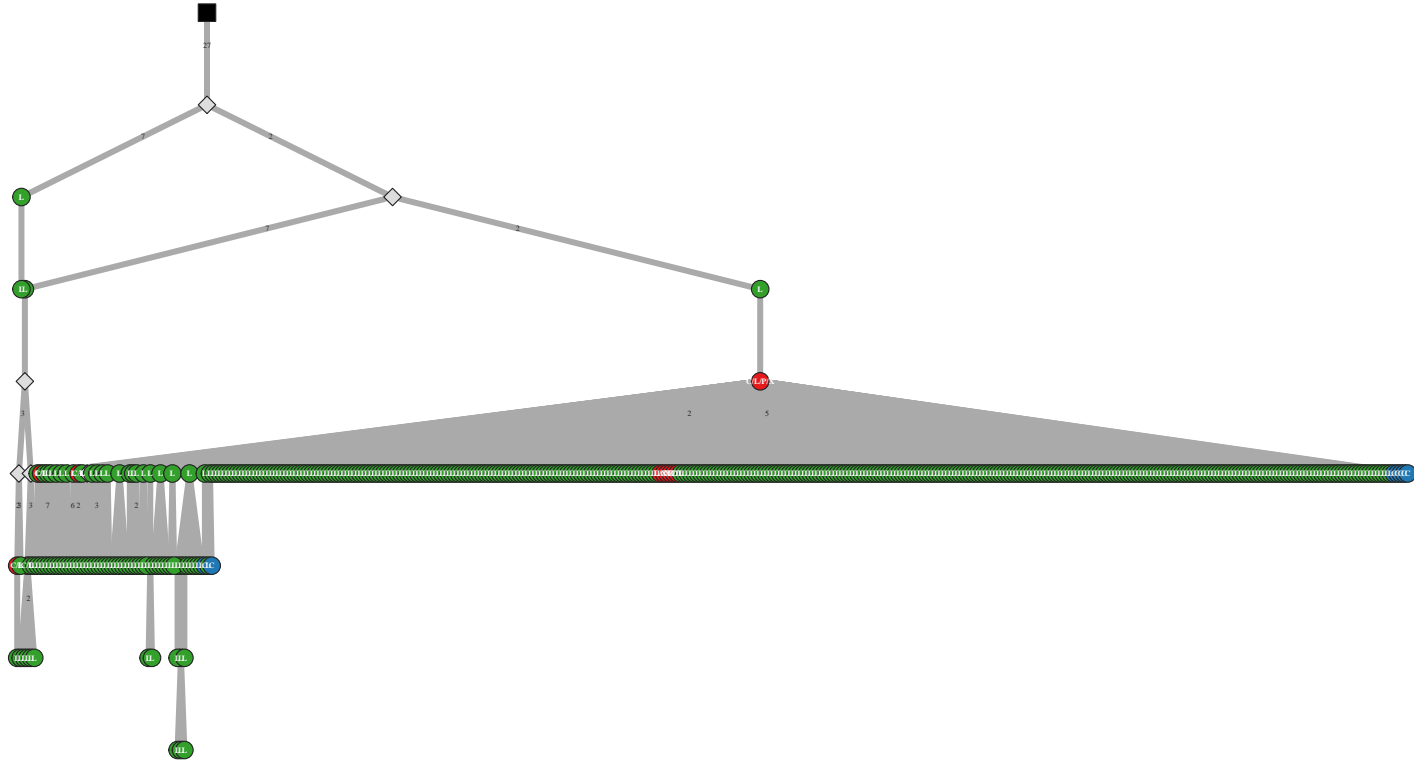

M5 IgG IGHV3-21/J4 57bp (34126)

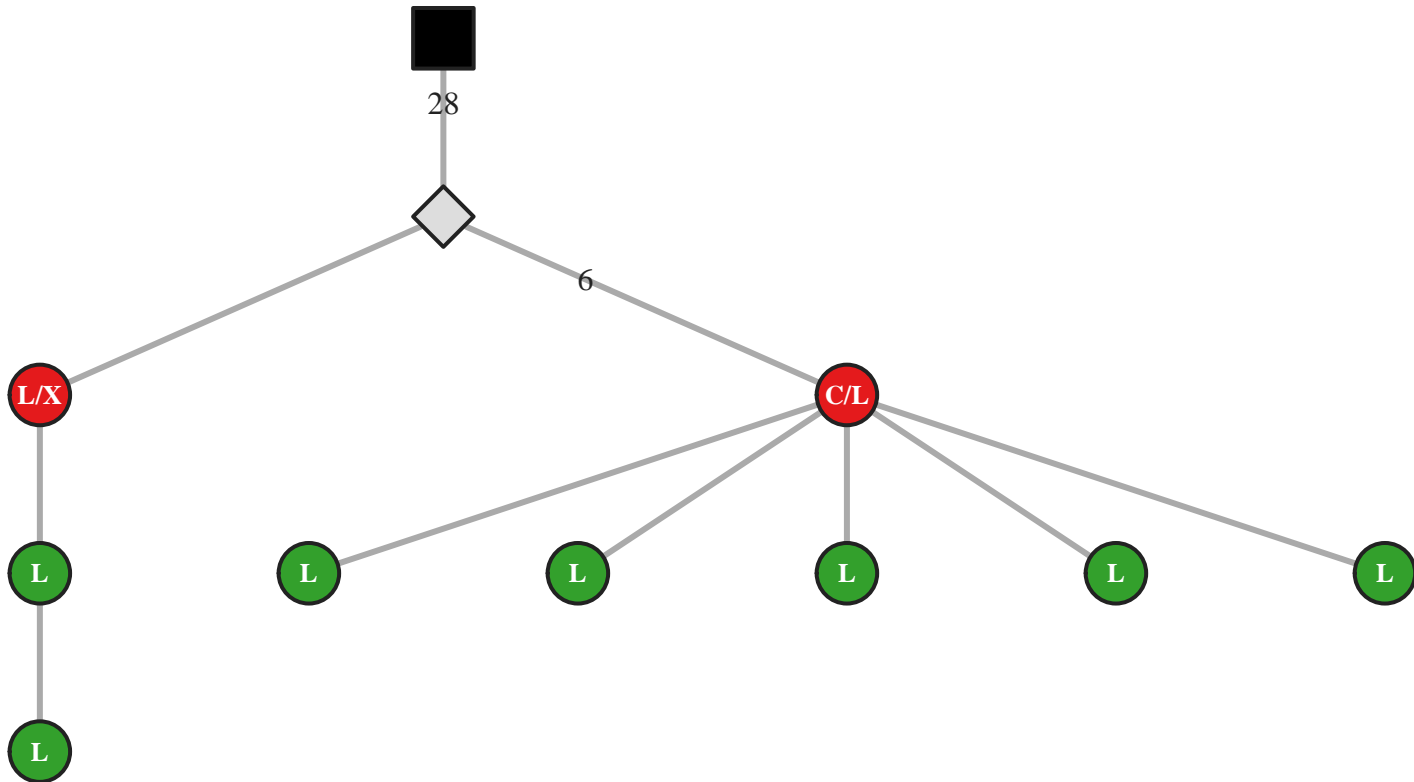

M5 IgG IGHV3-21/J4 63bp (51443)

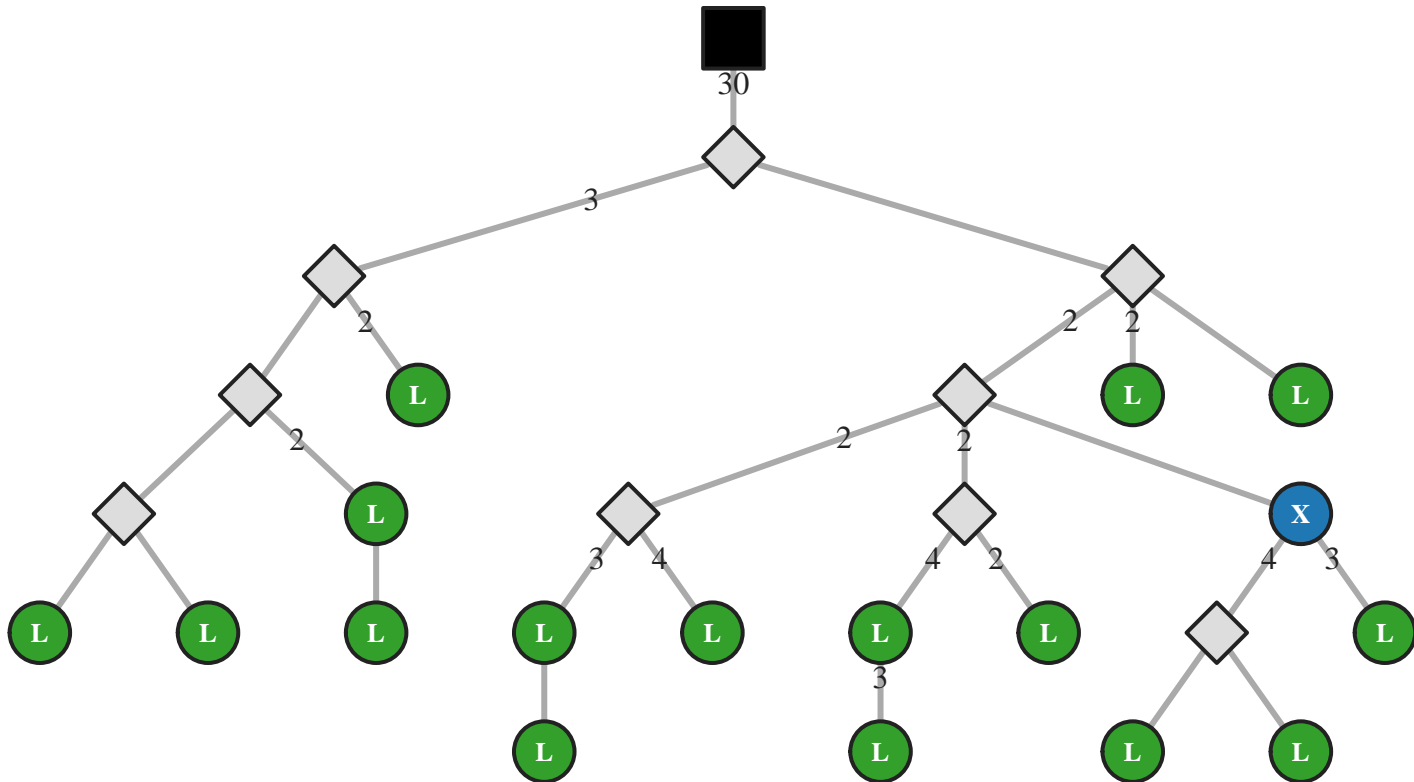

M5 IgG IGHV3-21/J4 69bp (25516)

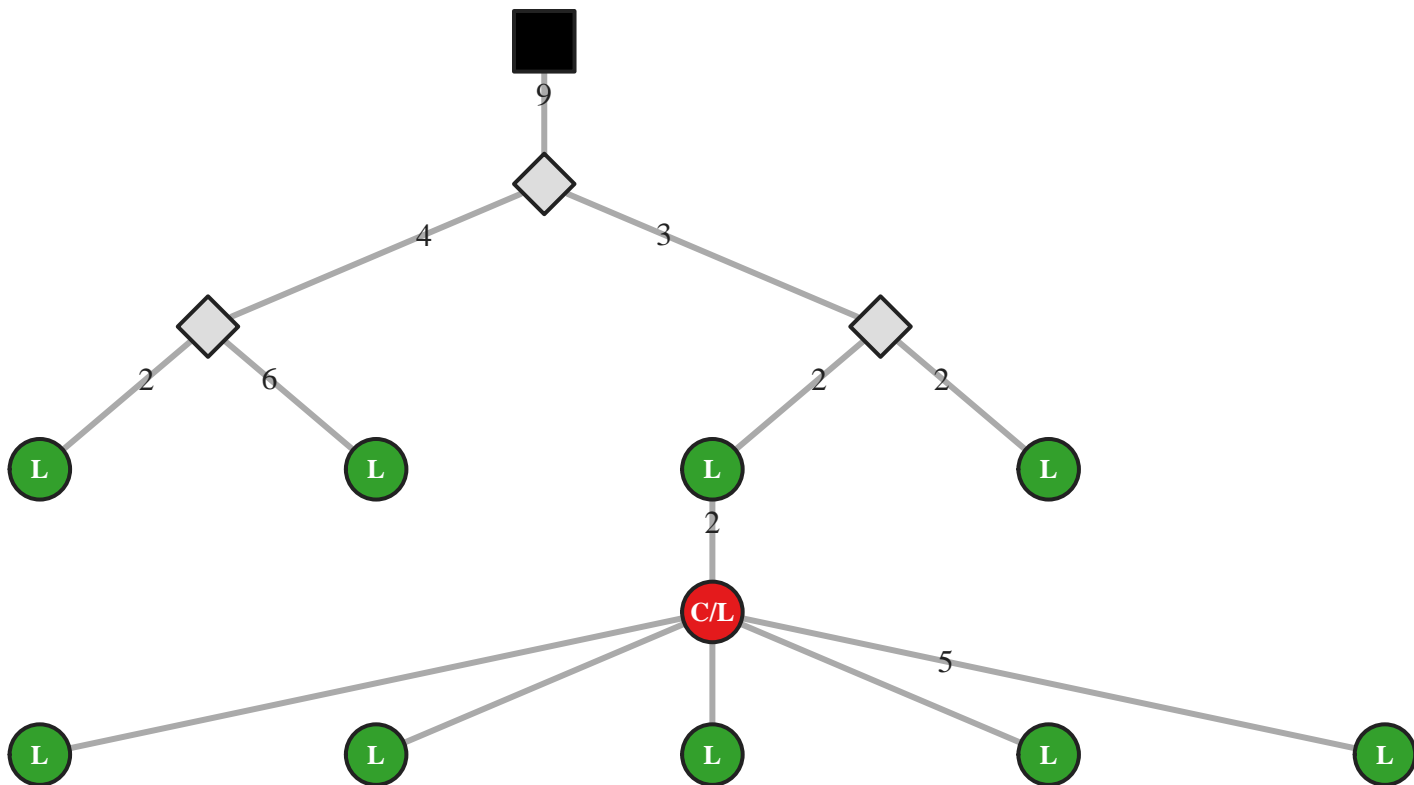

M5 IgG IGHV3-21/J5 33bp (51453)

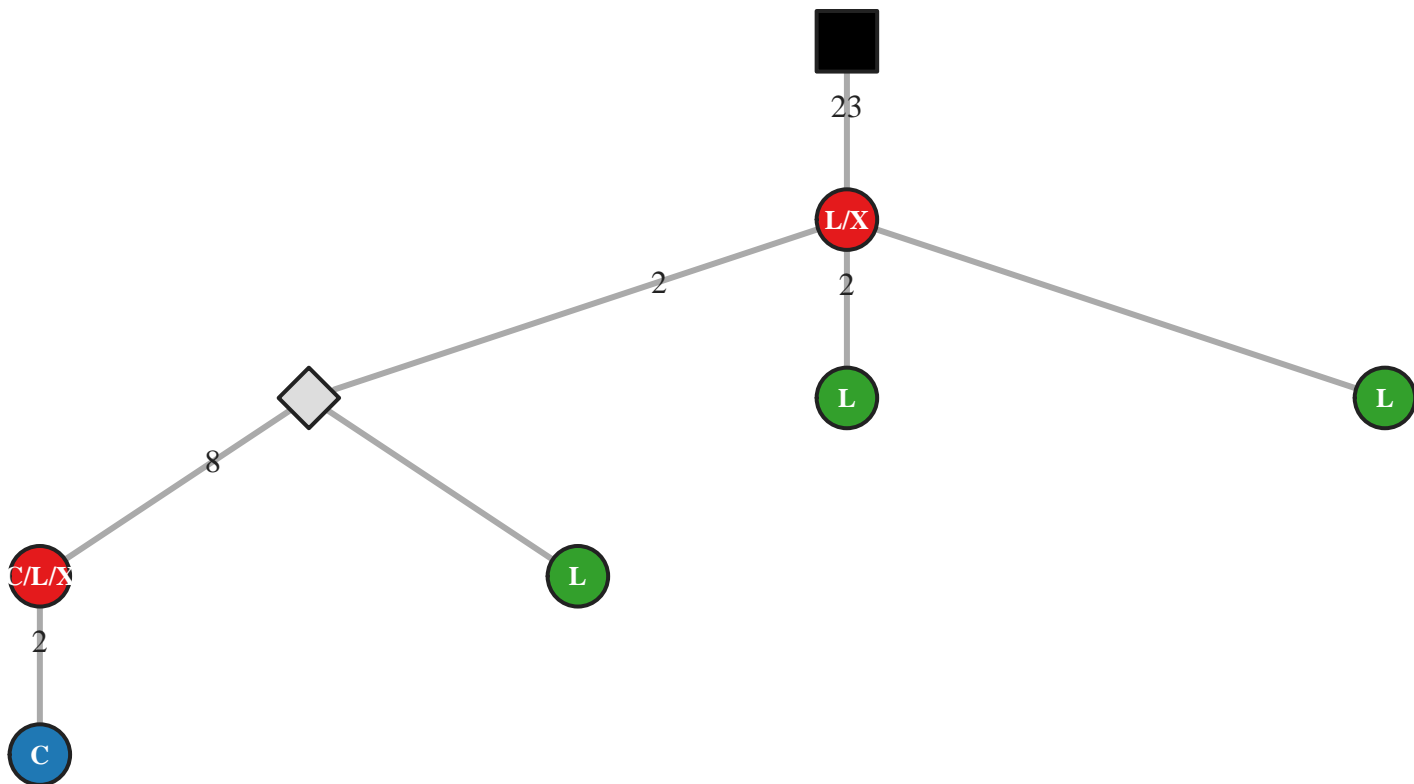

M5 IgG IGHV3-21/J5 33bp (51454)

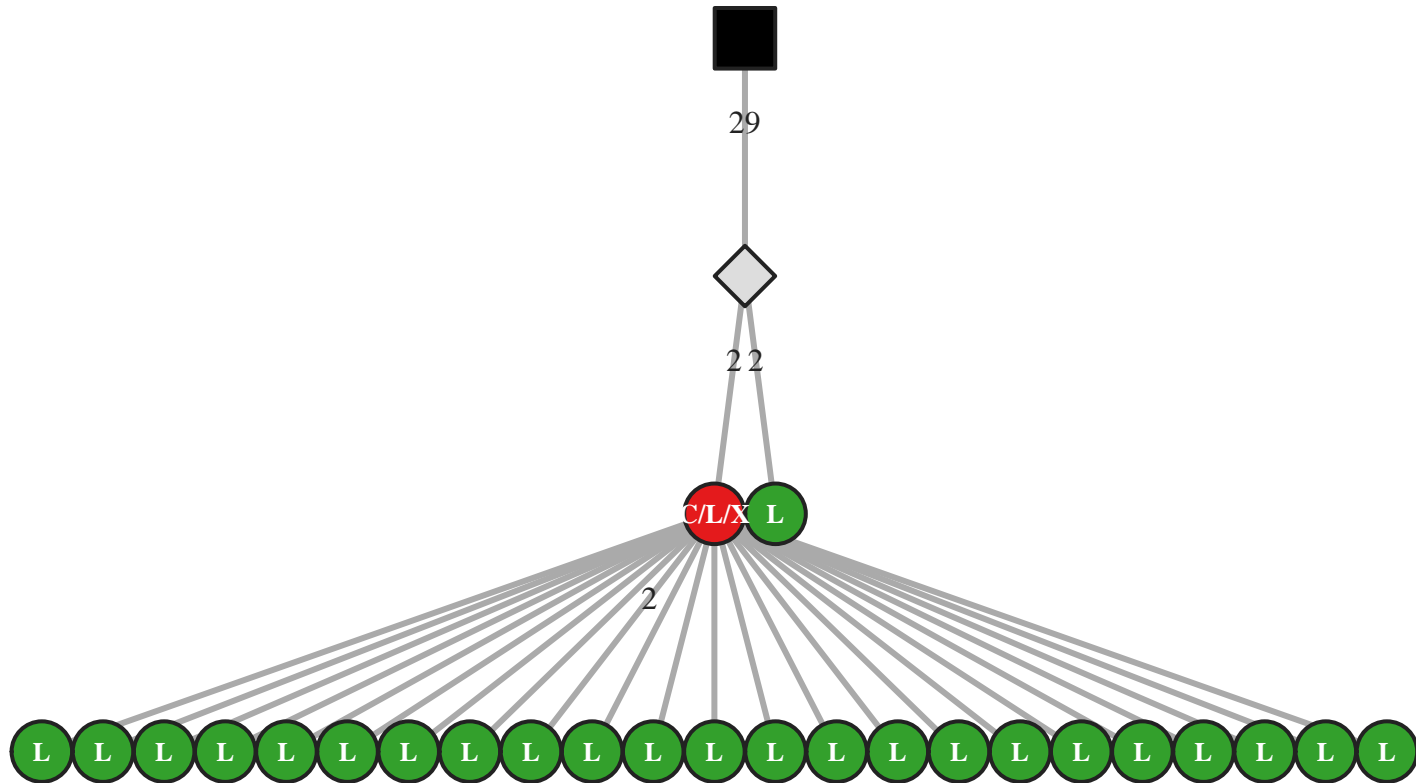

M5 IgA IGHV3-21/J5 48bp (2657)

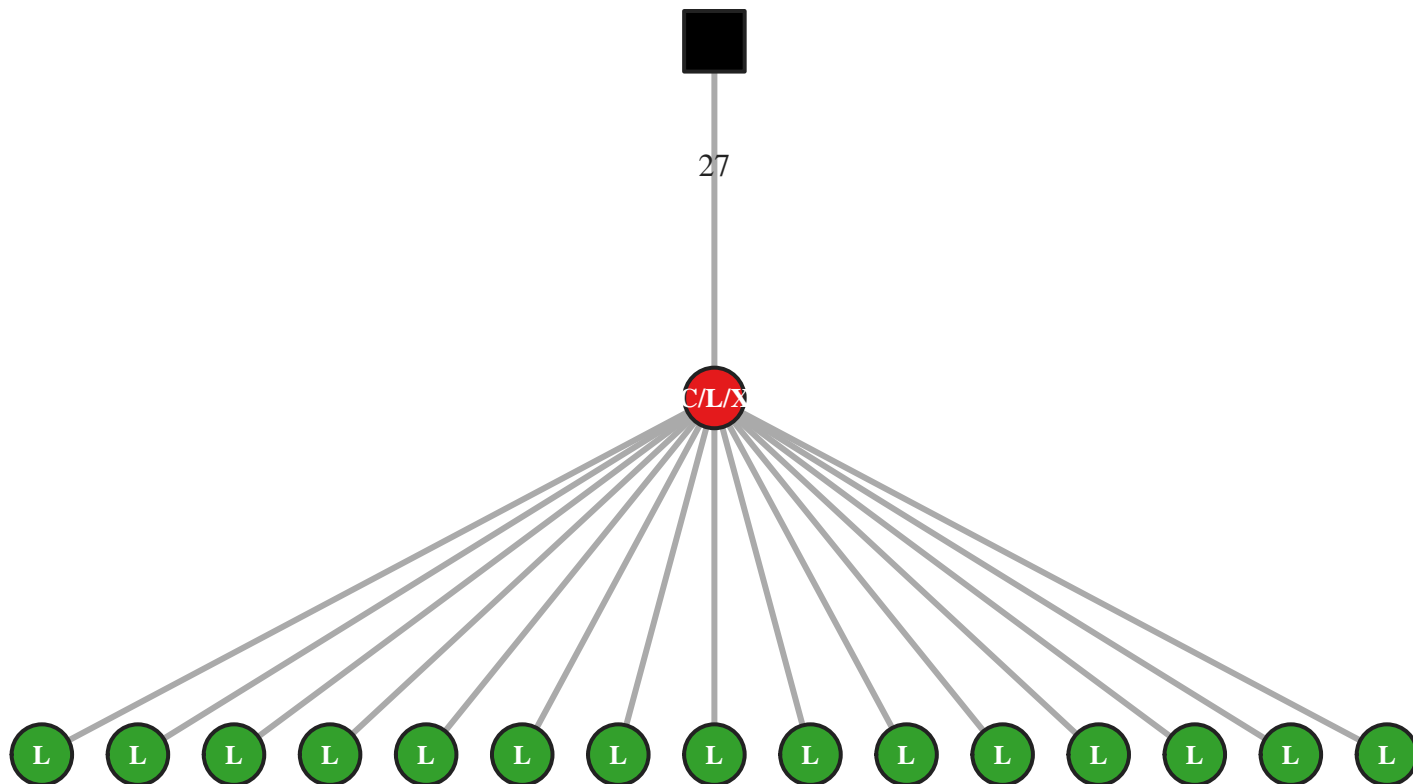

M5 IgG IGHV3-21/J5 48bp (25550)

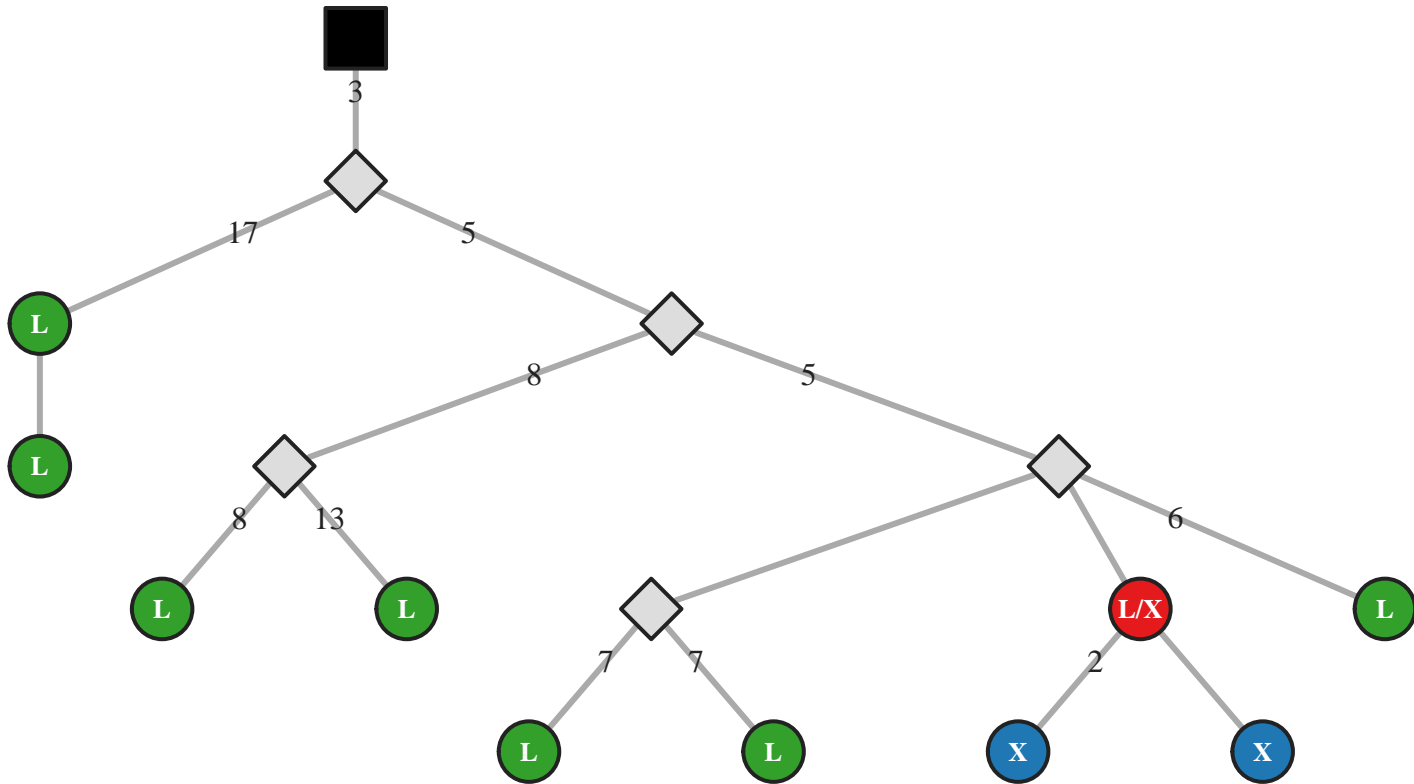

M5 IgG IGHV3-21/J5 48bp (25552)

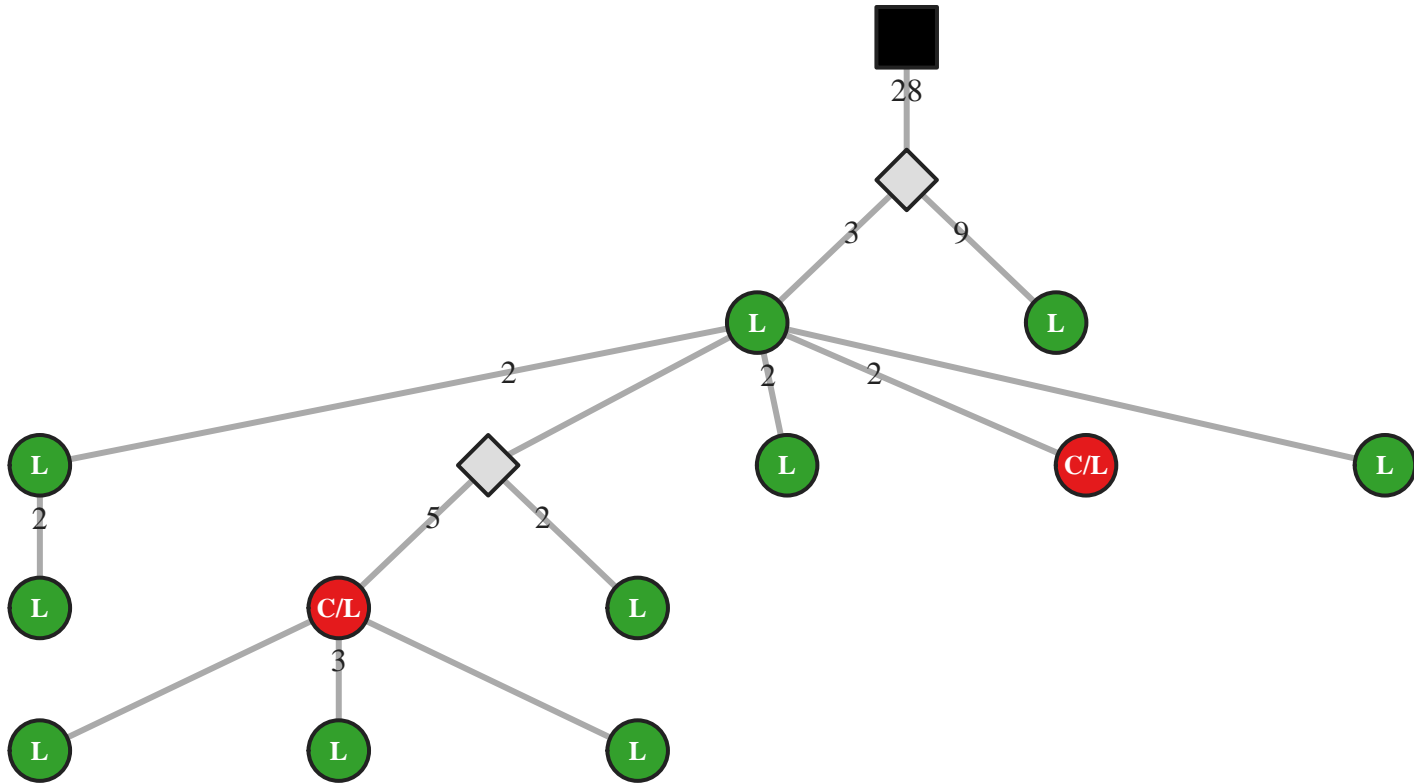

M5 IgG IGHV3-21/J6 36bp (34155)

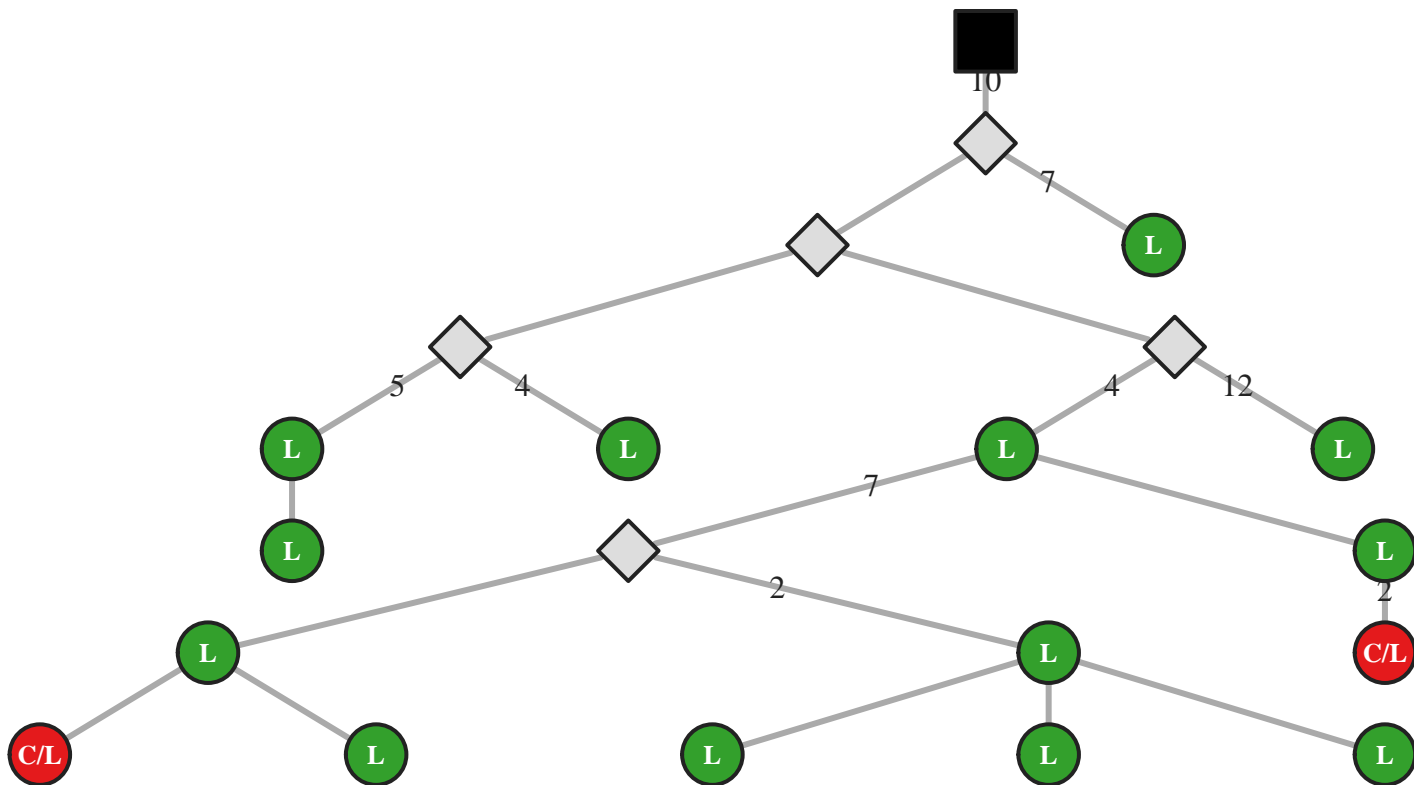

M5 IgG IGHV3-21/J6 48bp (34185)

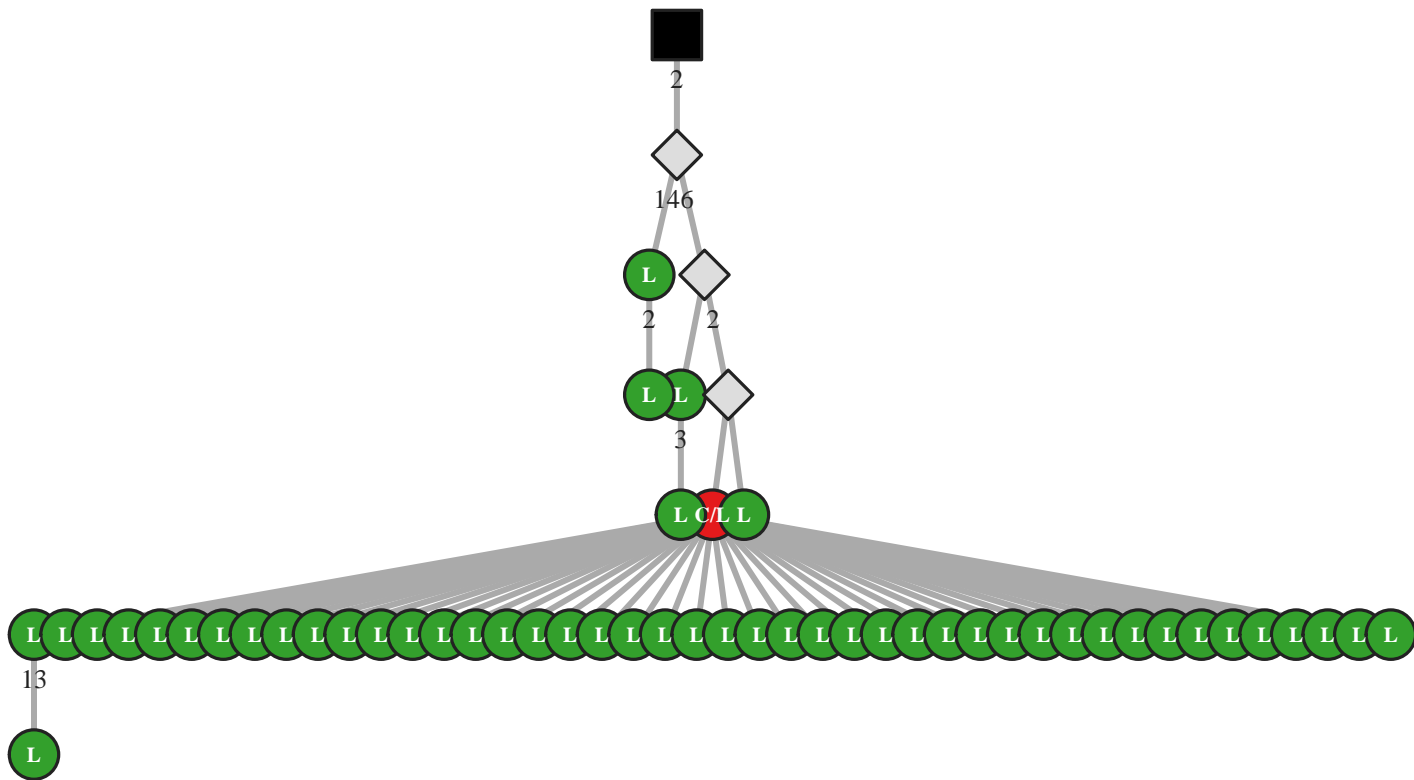

M5 IgG IGHV3-21/J6 57bp (25644)

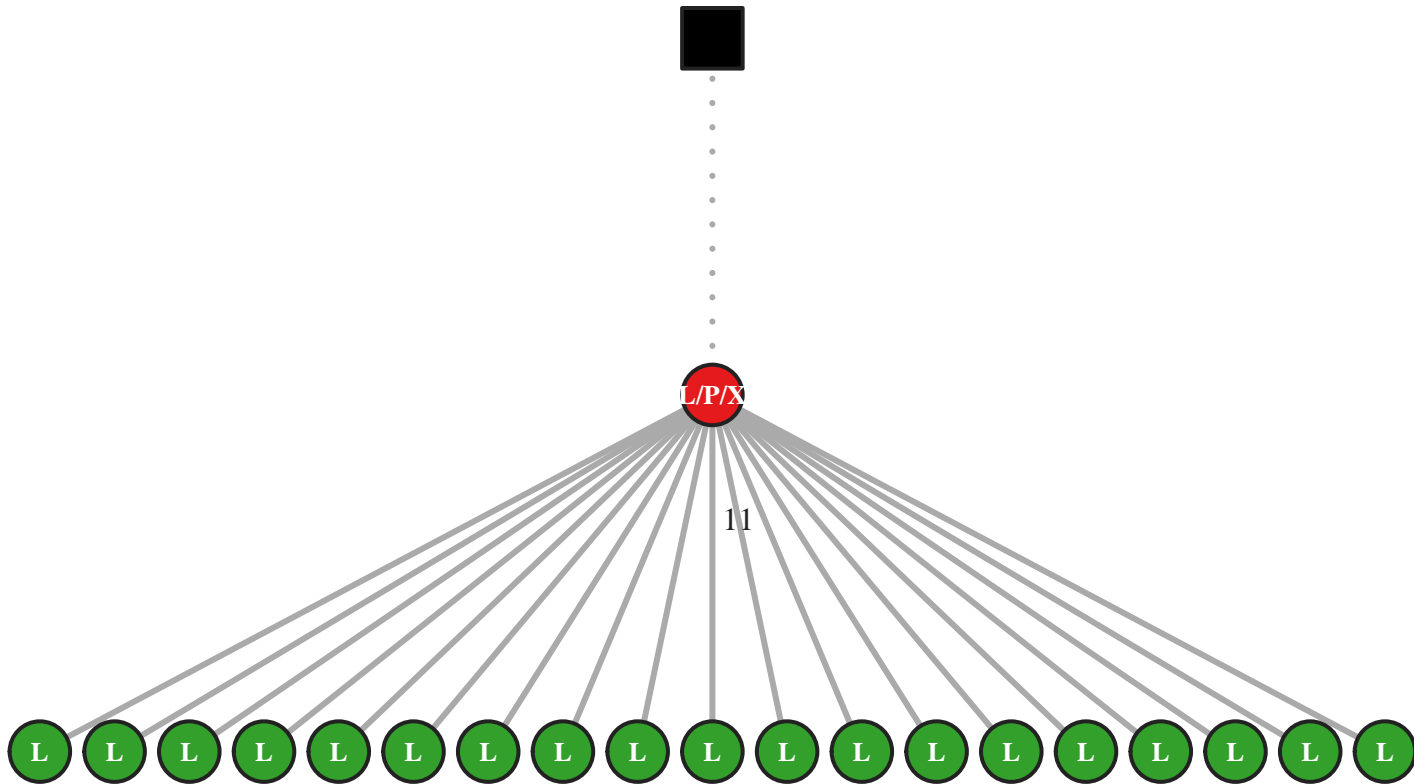

M5 IgG IGHV3-21/J6 57bp (25650)

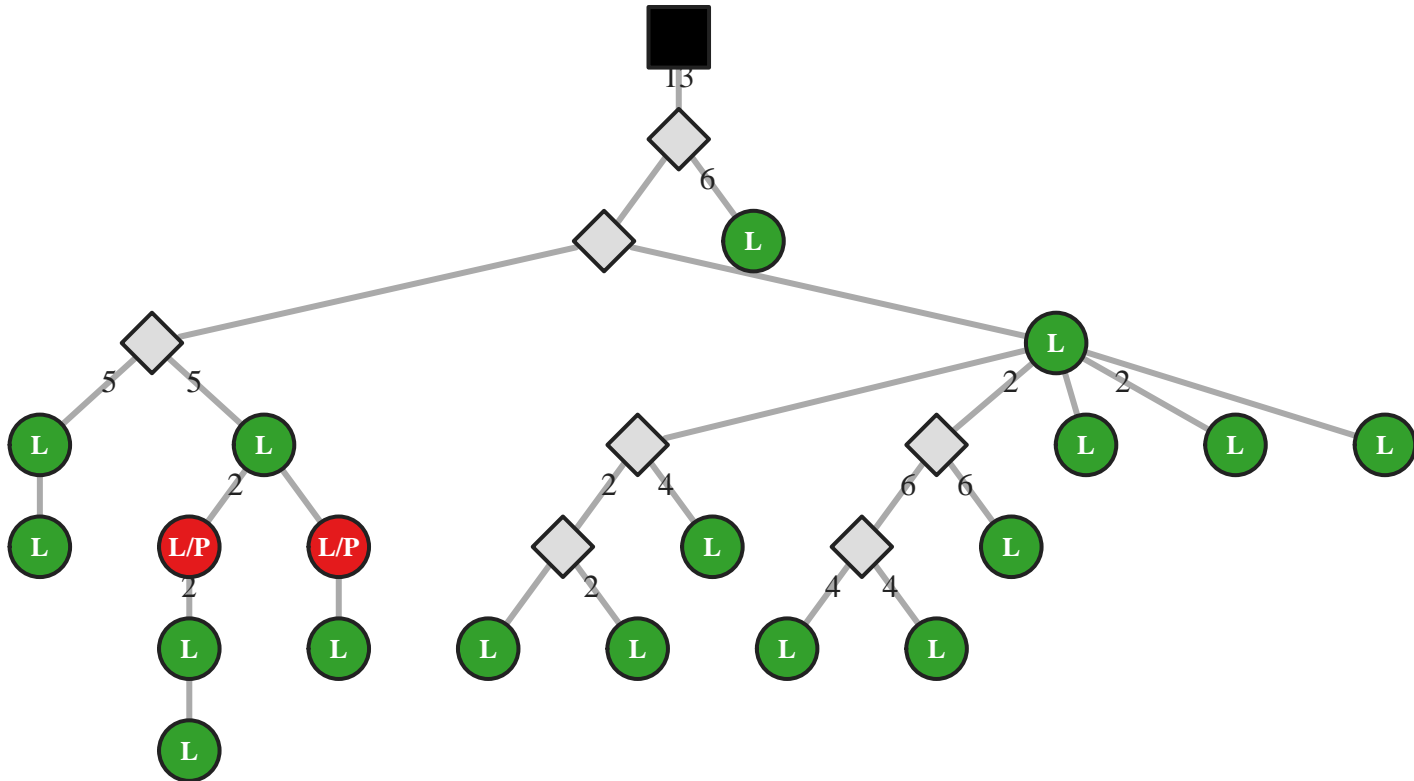

M5 IgG IGHV3-21/J6 60bp (6584)

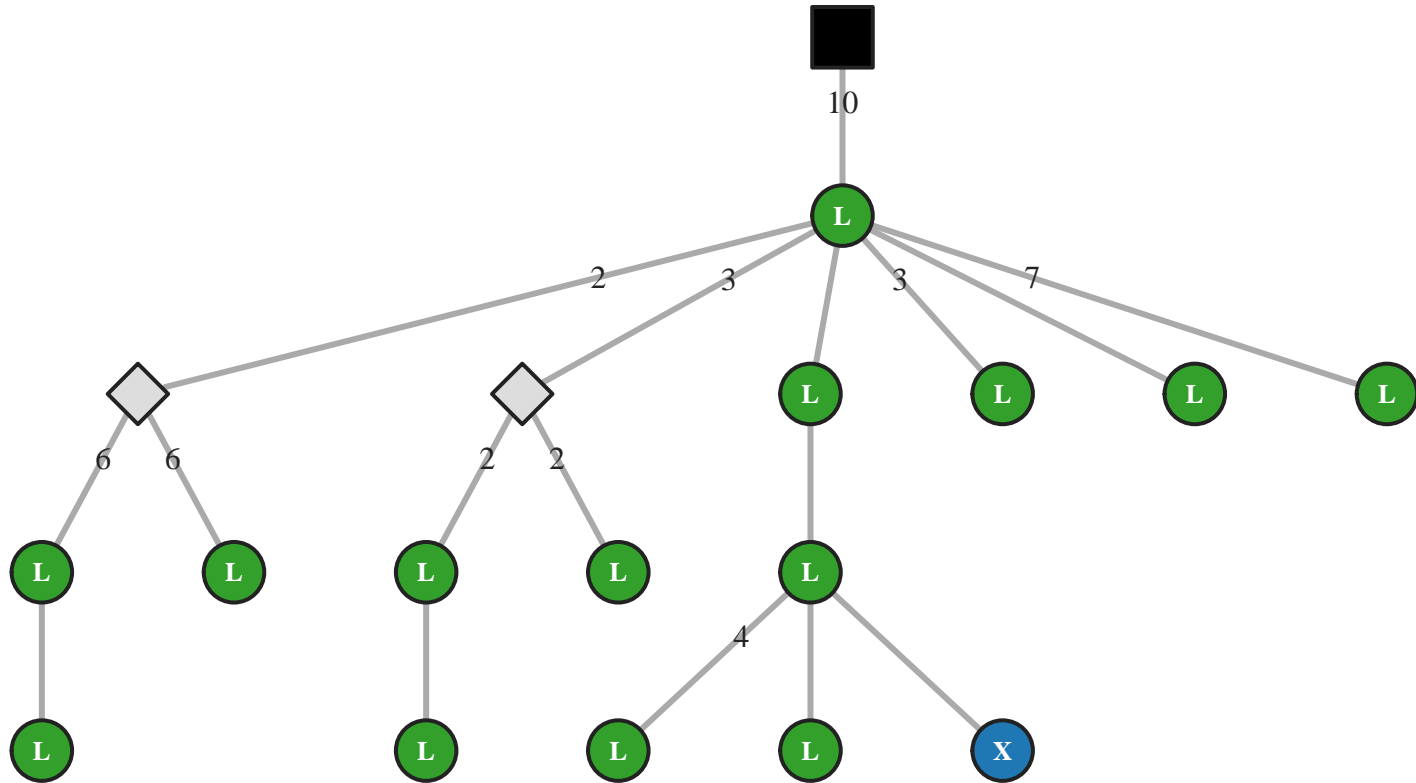

M5 IgG IGHV3-21/J6 63bp (43601)

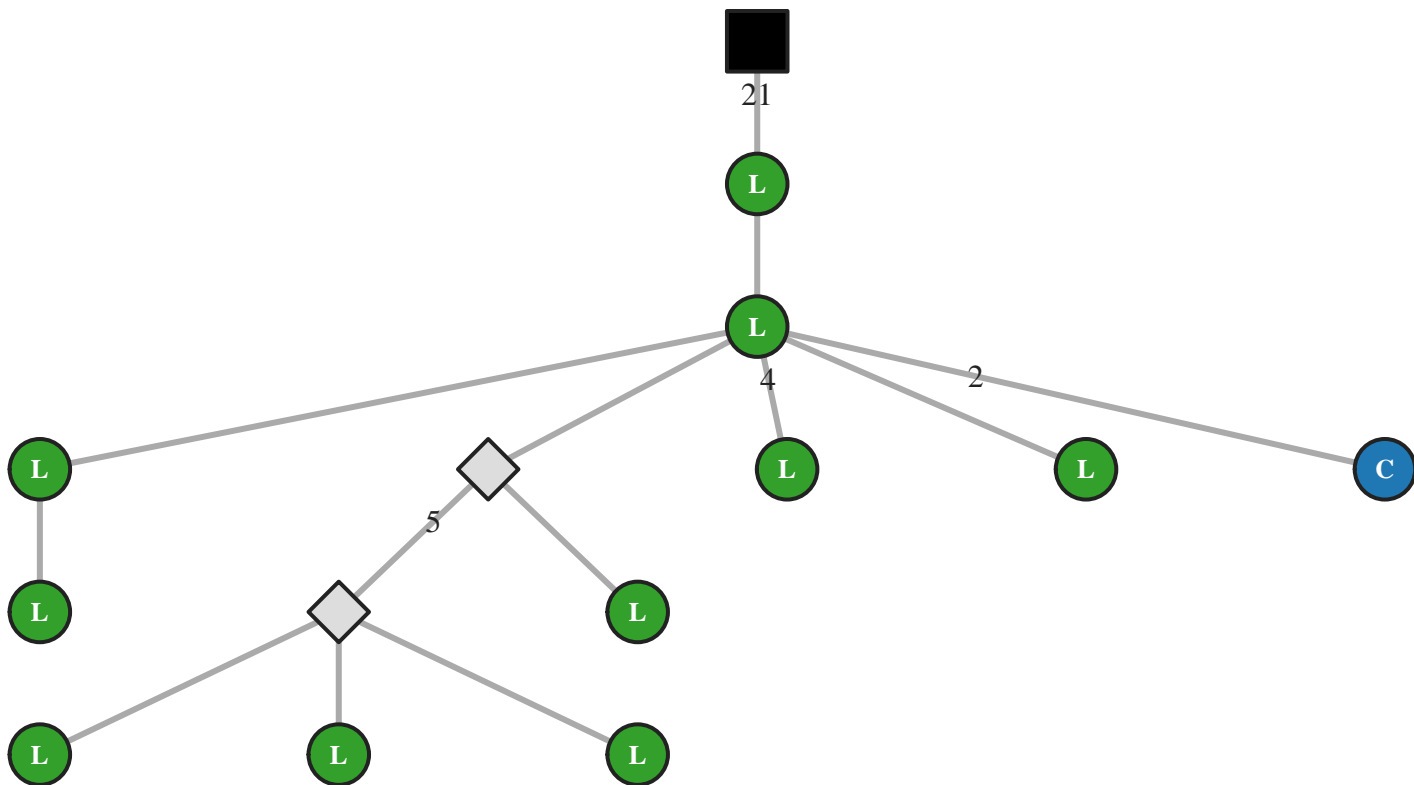

M5 IgG IGHV3-21/J6 66bp (34194)

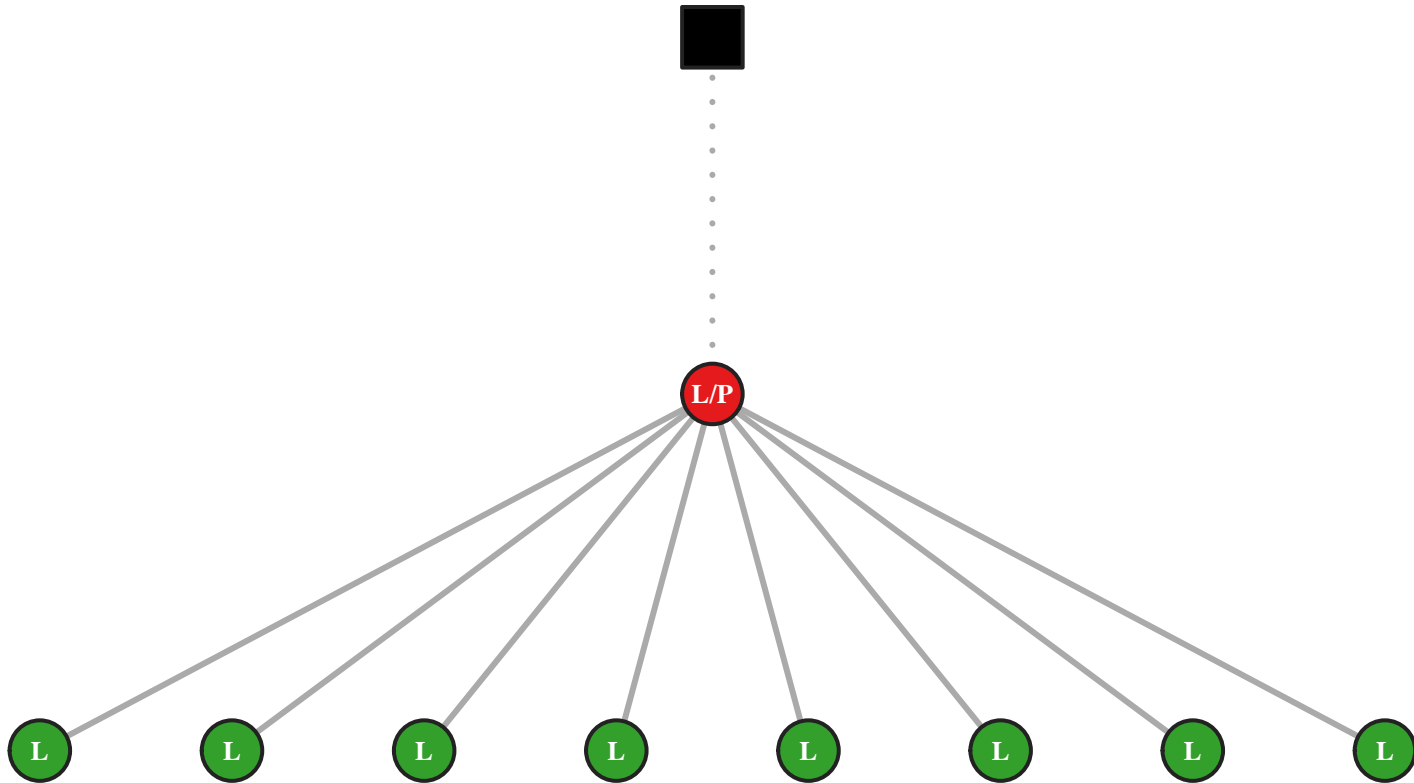

M5 IgG IGHV3-21/J6 81bp (51462)

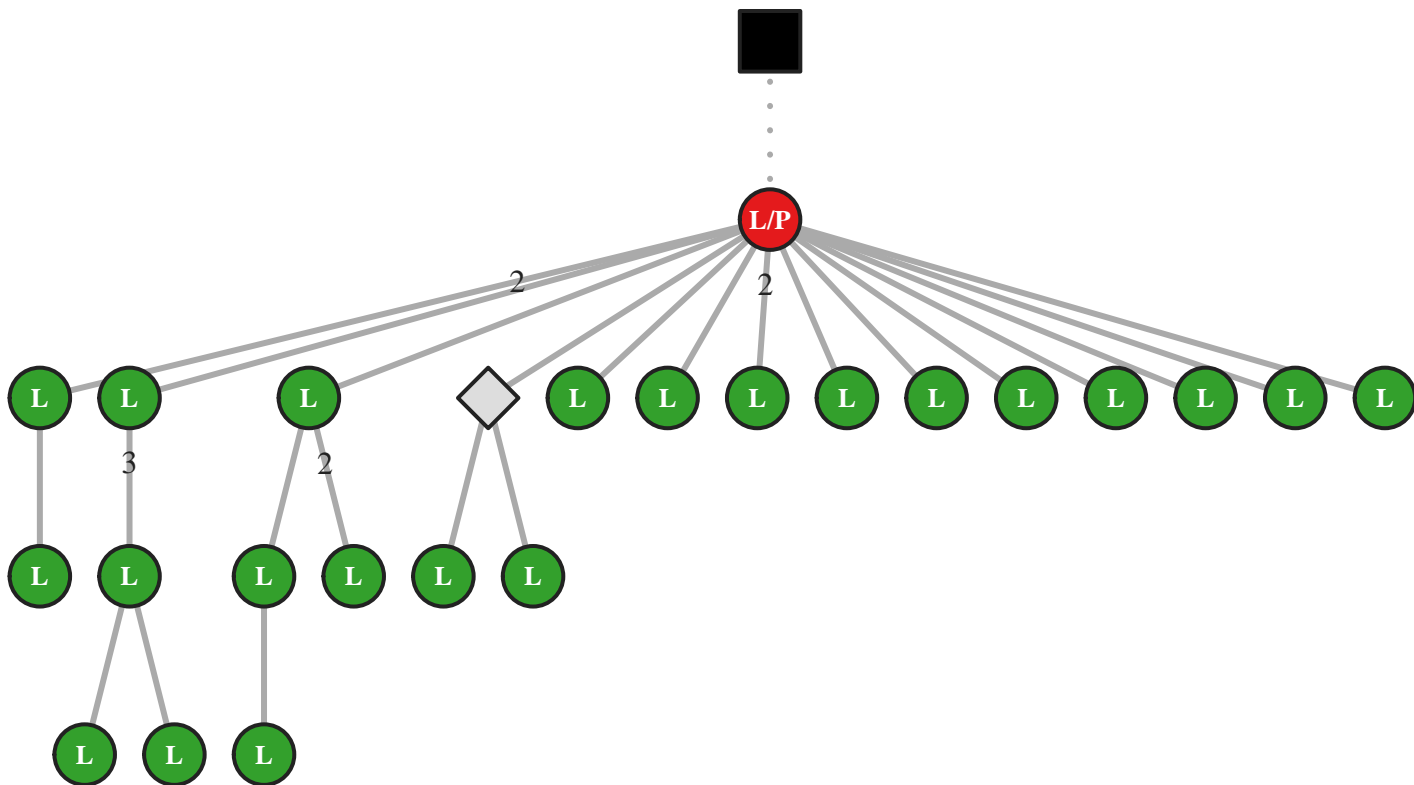

M5 IgG IGHV3-21/J6 81bp (51466)

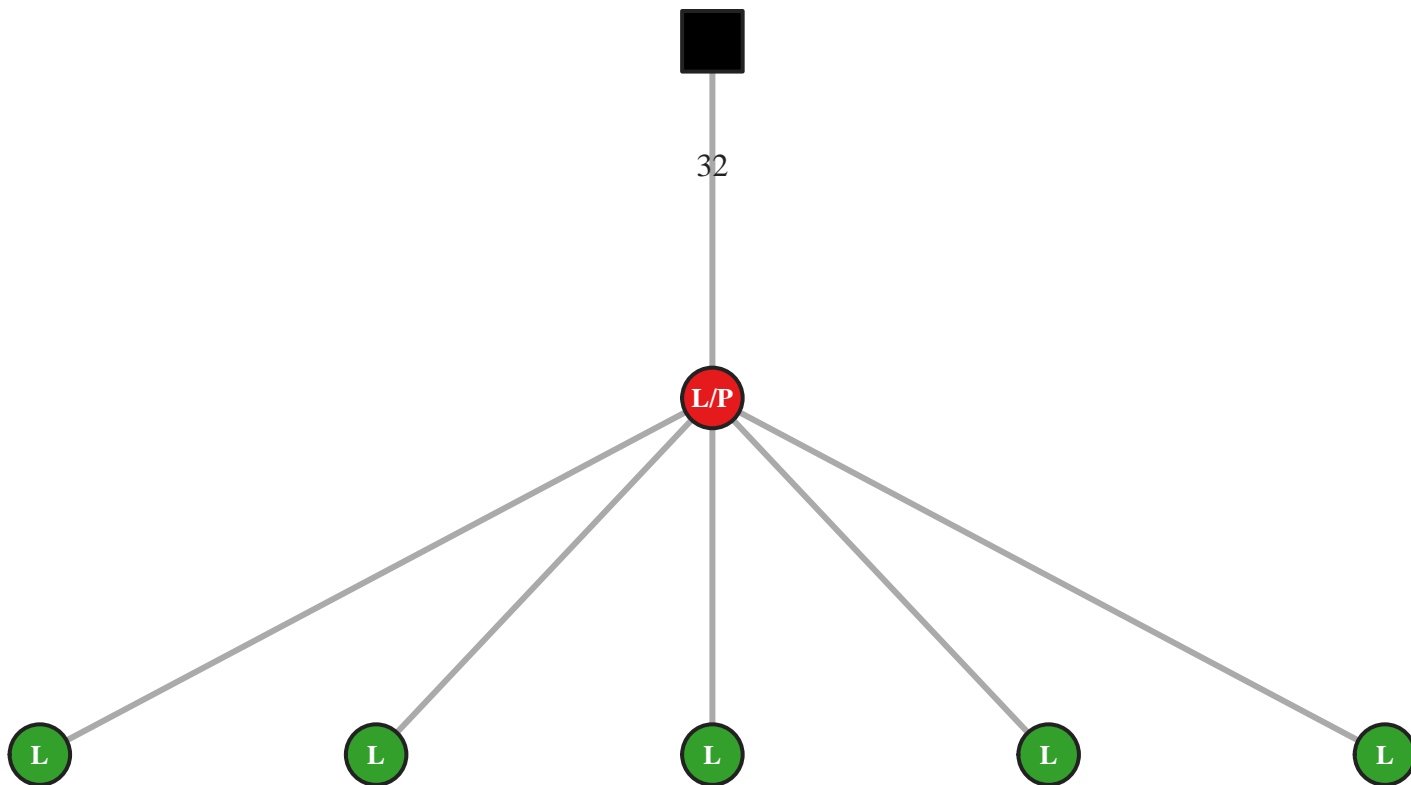

M5 IgG IGHV3-23/J1 57bp (51478)

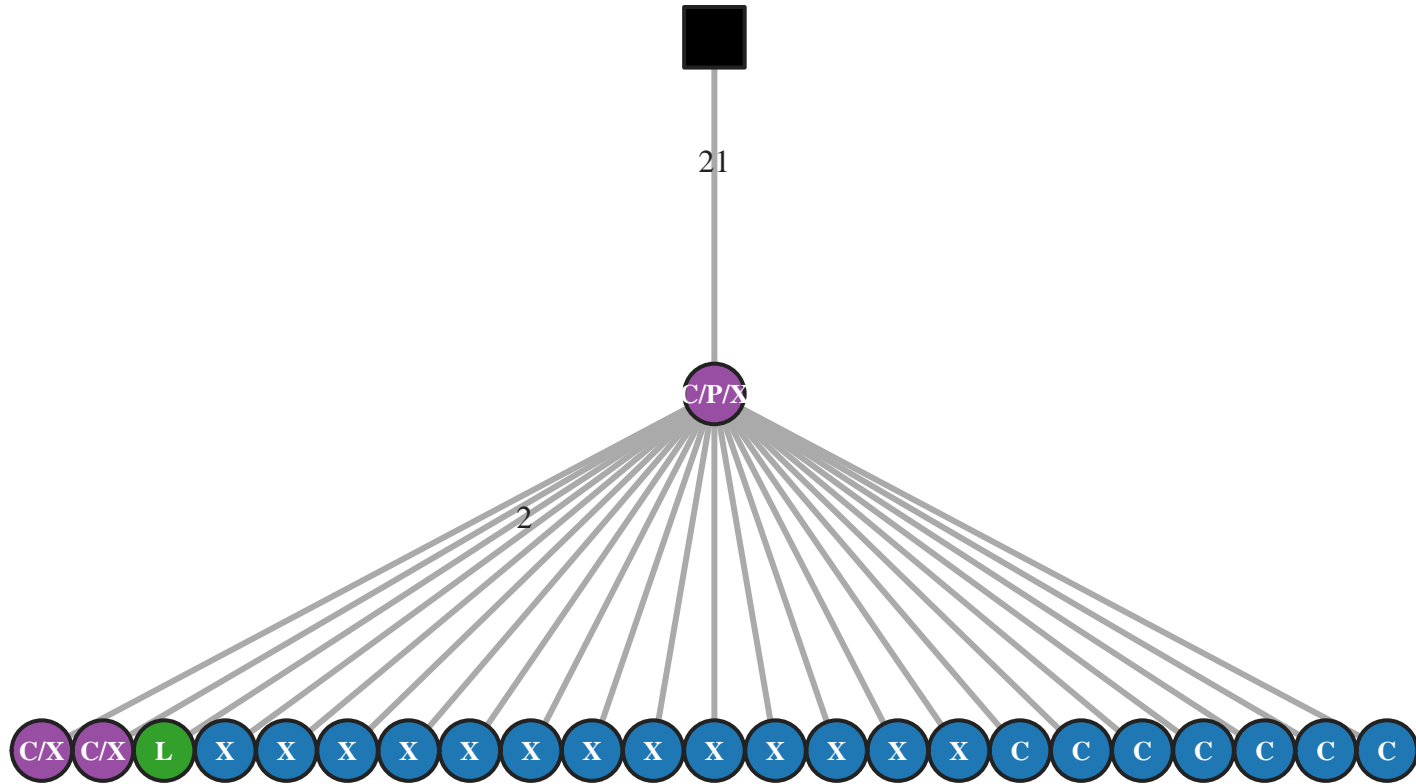

M5 IgG IGHV3-23/J2 51bp (6592)

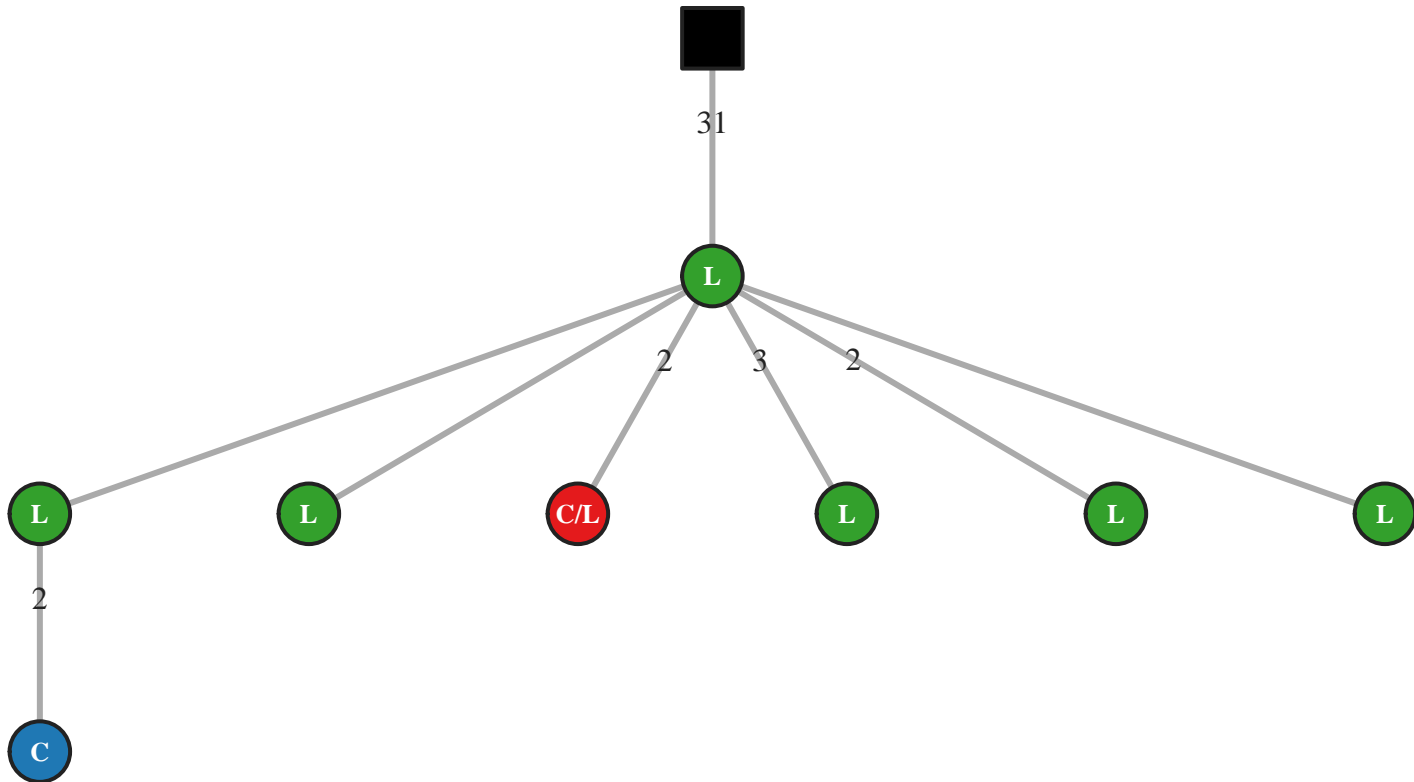

M5 IgG IGHV3-23/J2 51bp (6595)

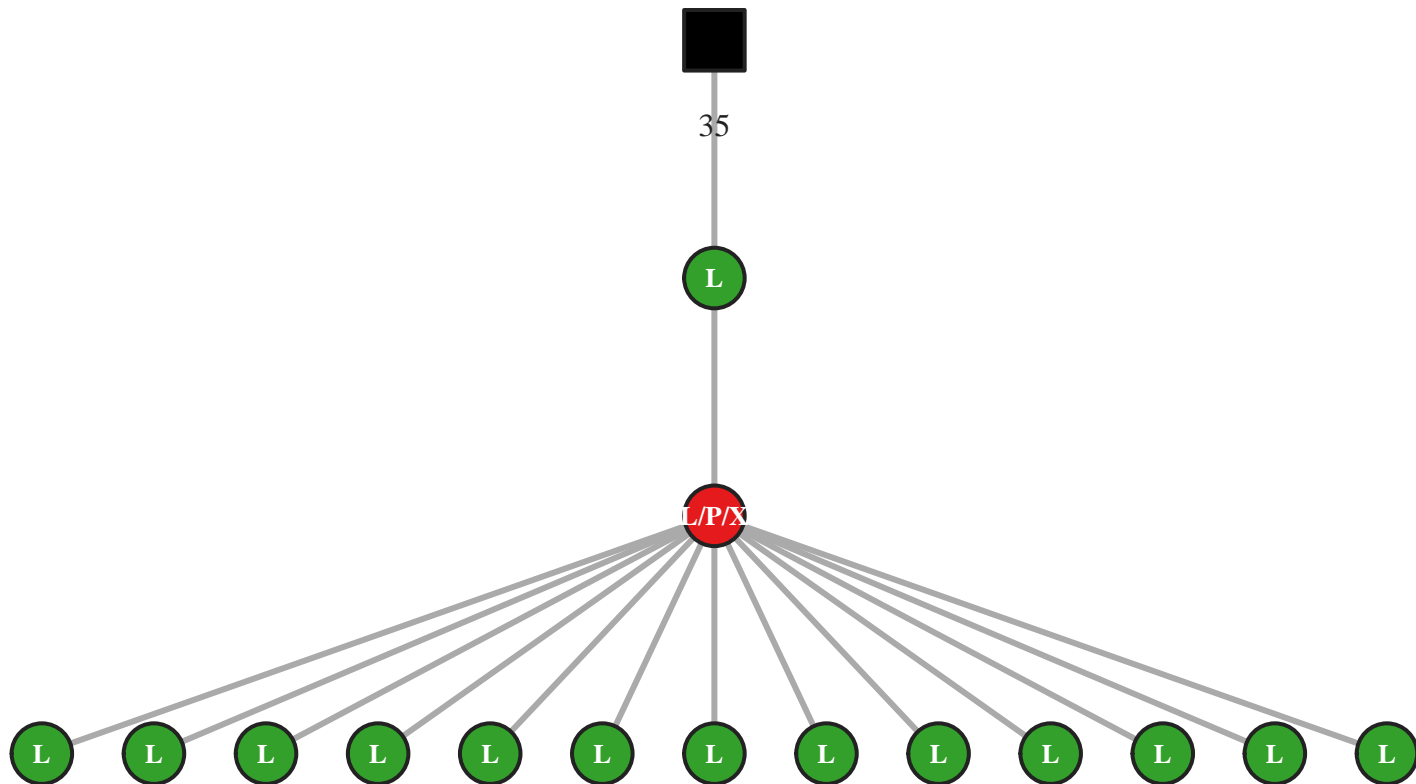

M5 IgG IGHV3-23/J3 63bp (43666)

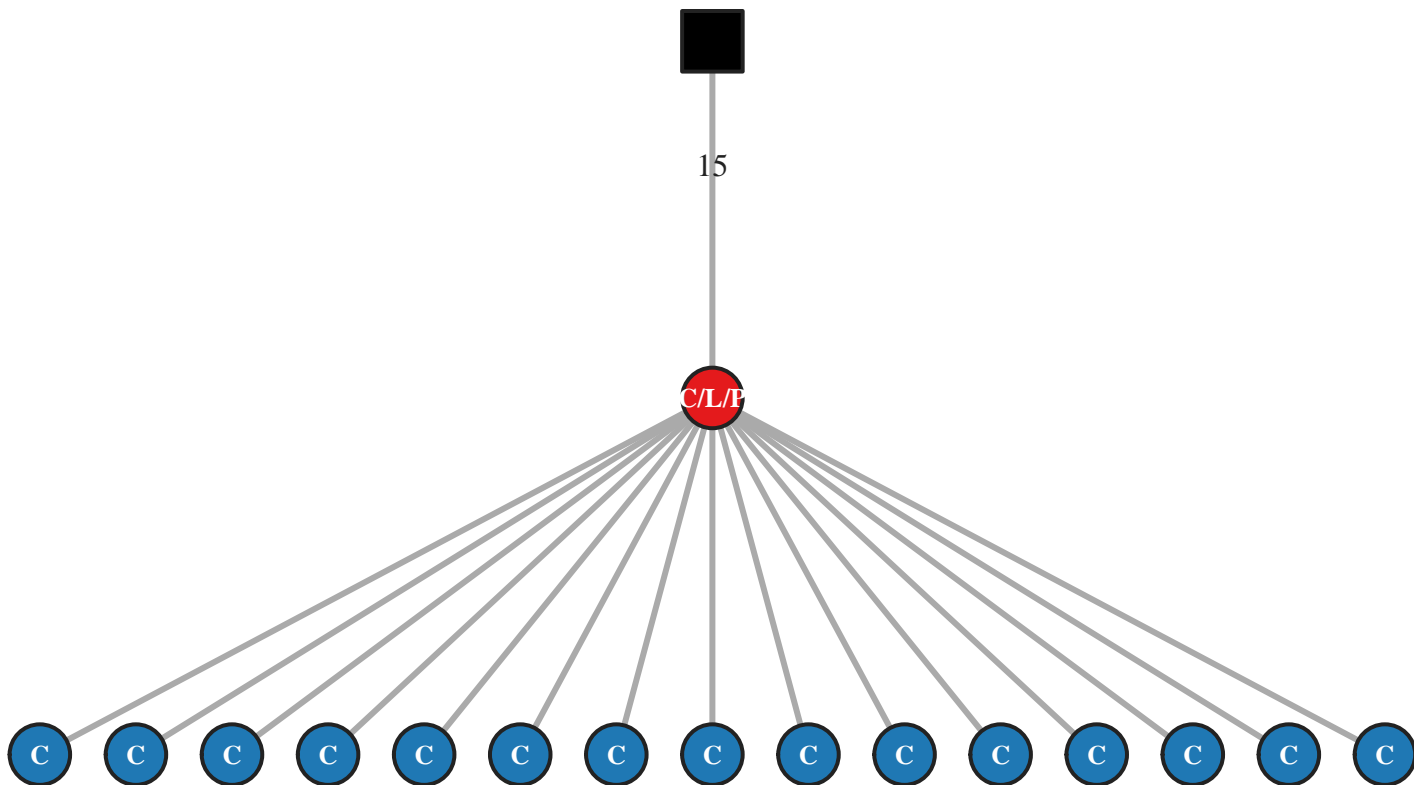

M5 IgG IGHV3-23/J4 24bp (43676)

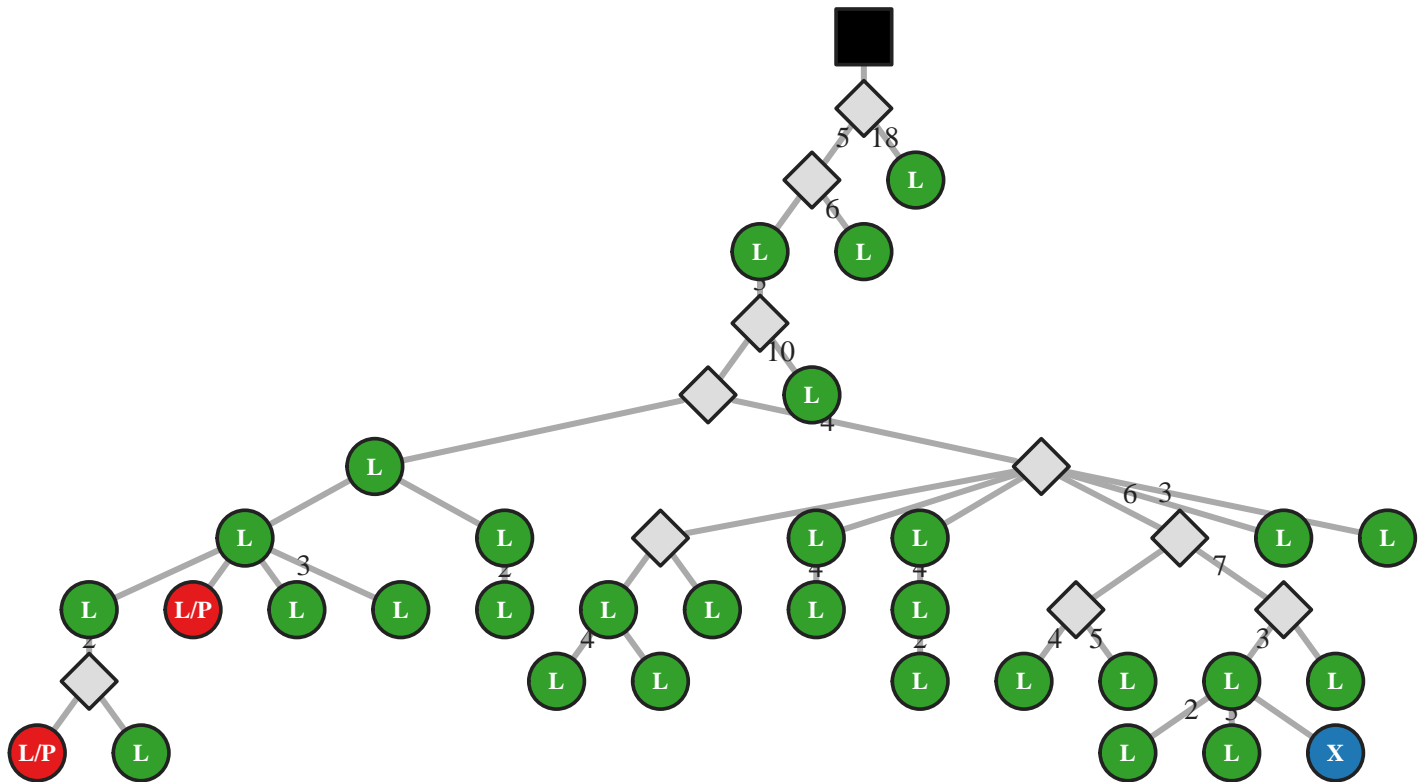

M5 IgG IGHV3-23/J4 27bp (43686)

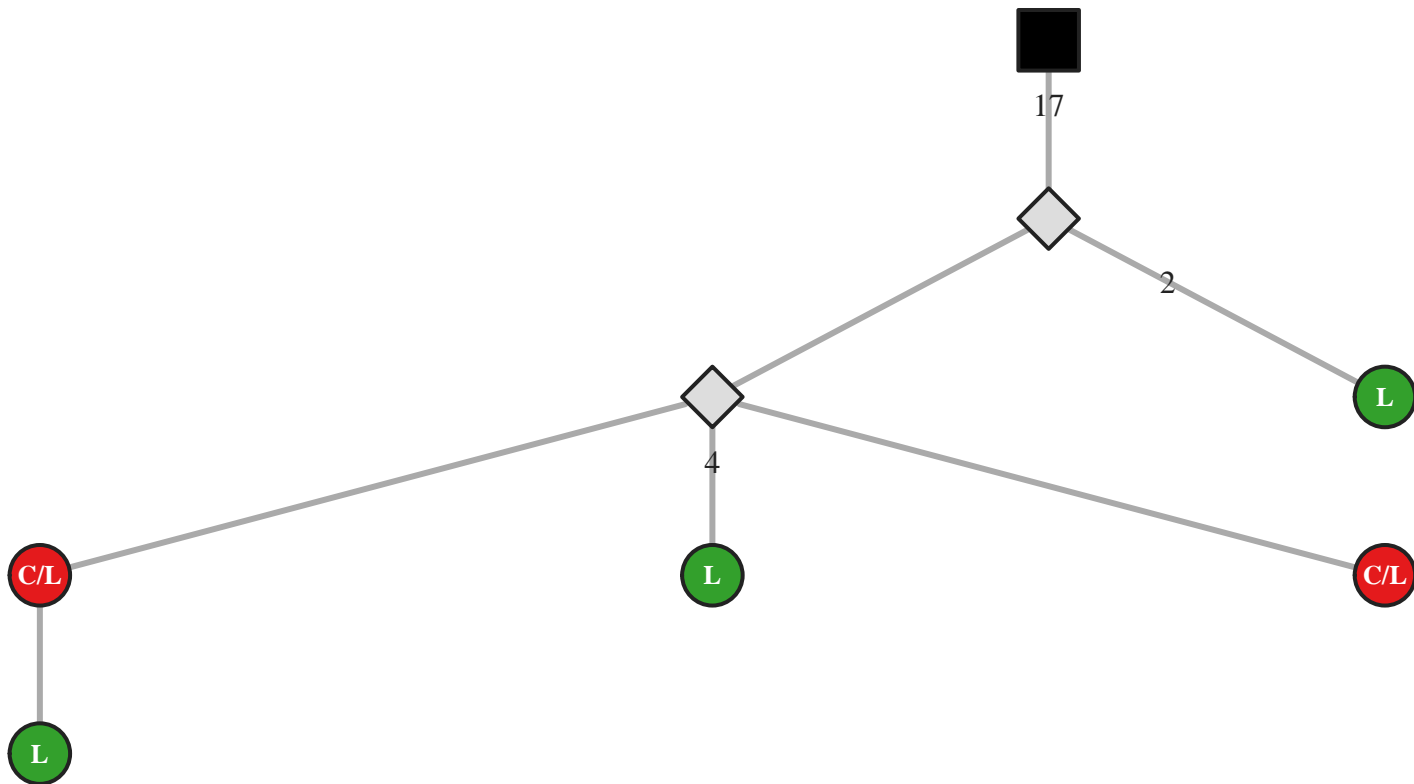

M5 IgG IGHV3-23/J4 30bp (16760)

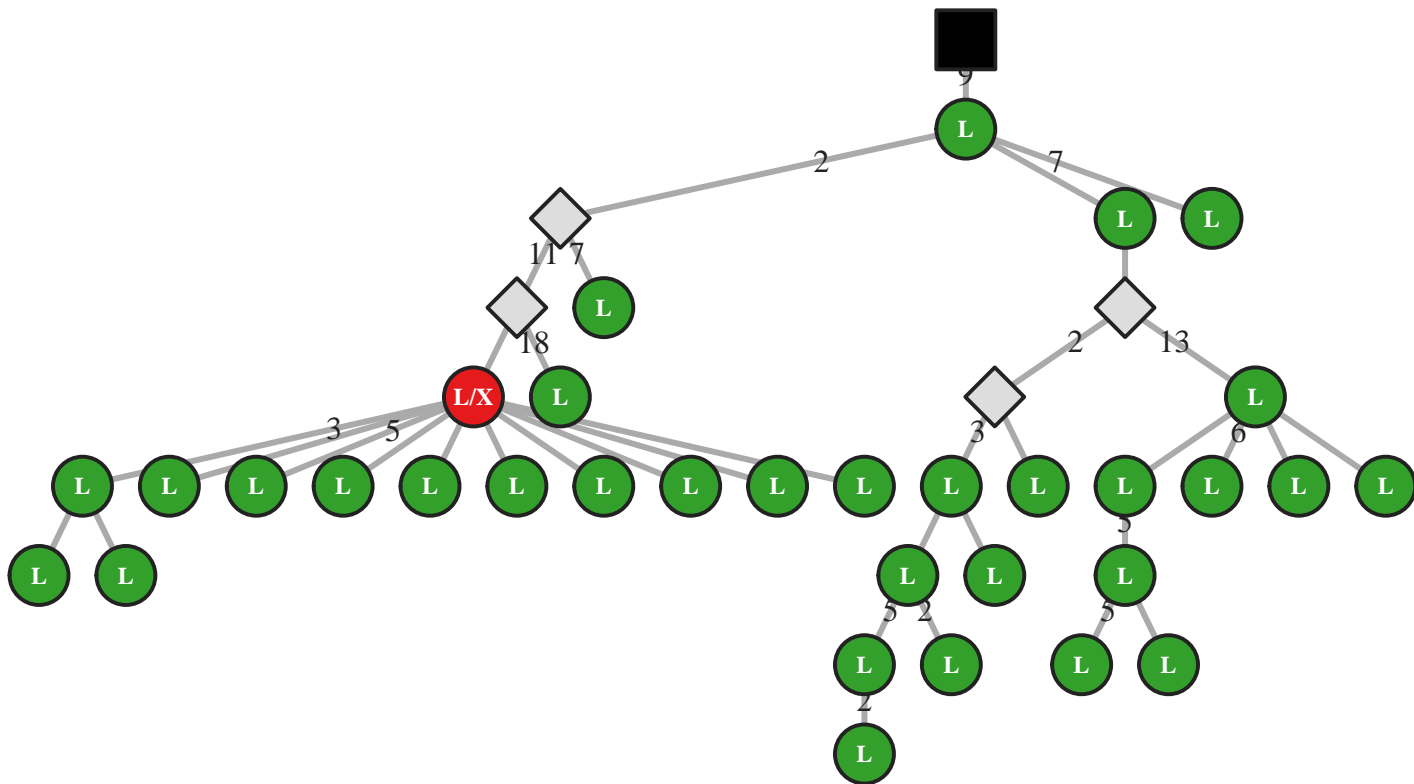

M5 IgG IGHV3-23/J4 33bp (25710)

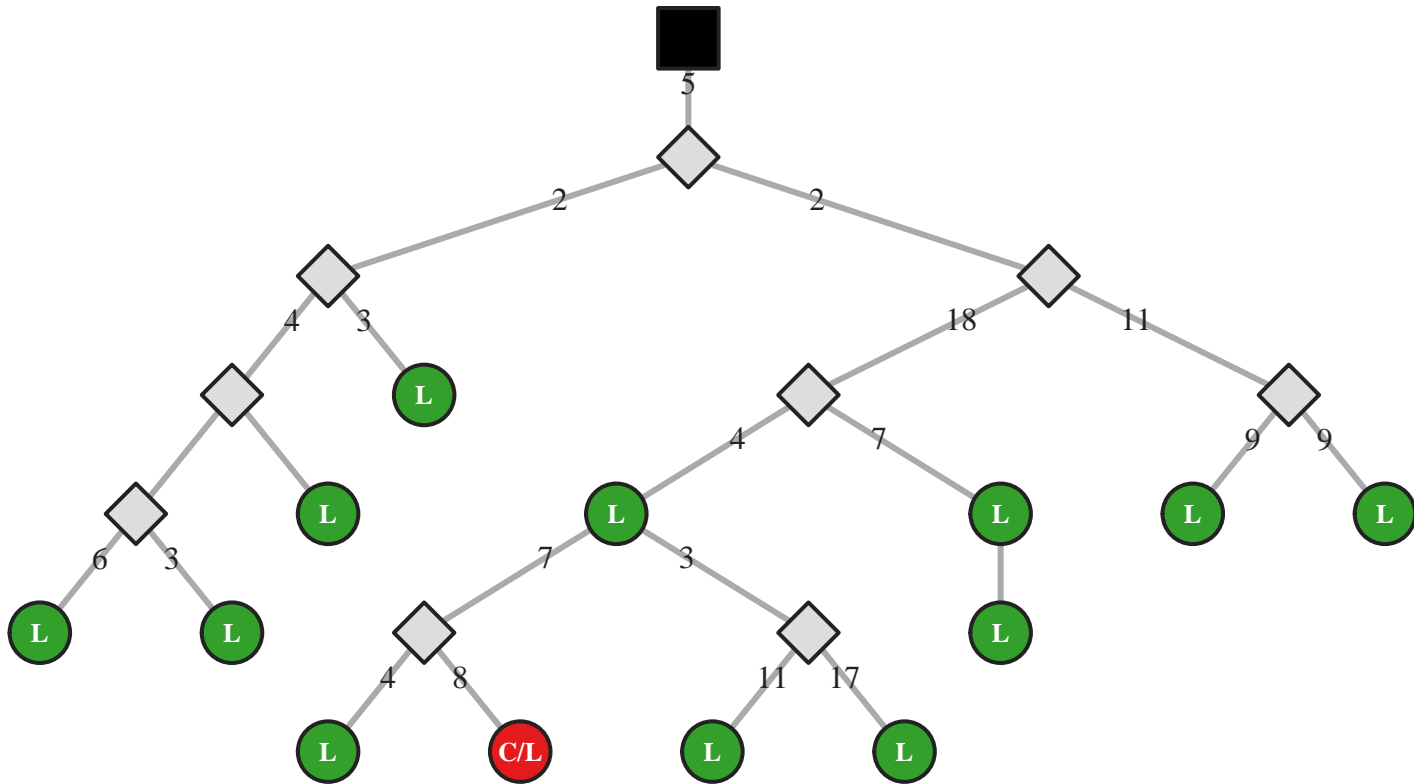

M5 IgG IGHV3-23/J4 33bp (25718)

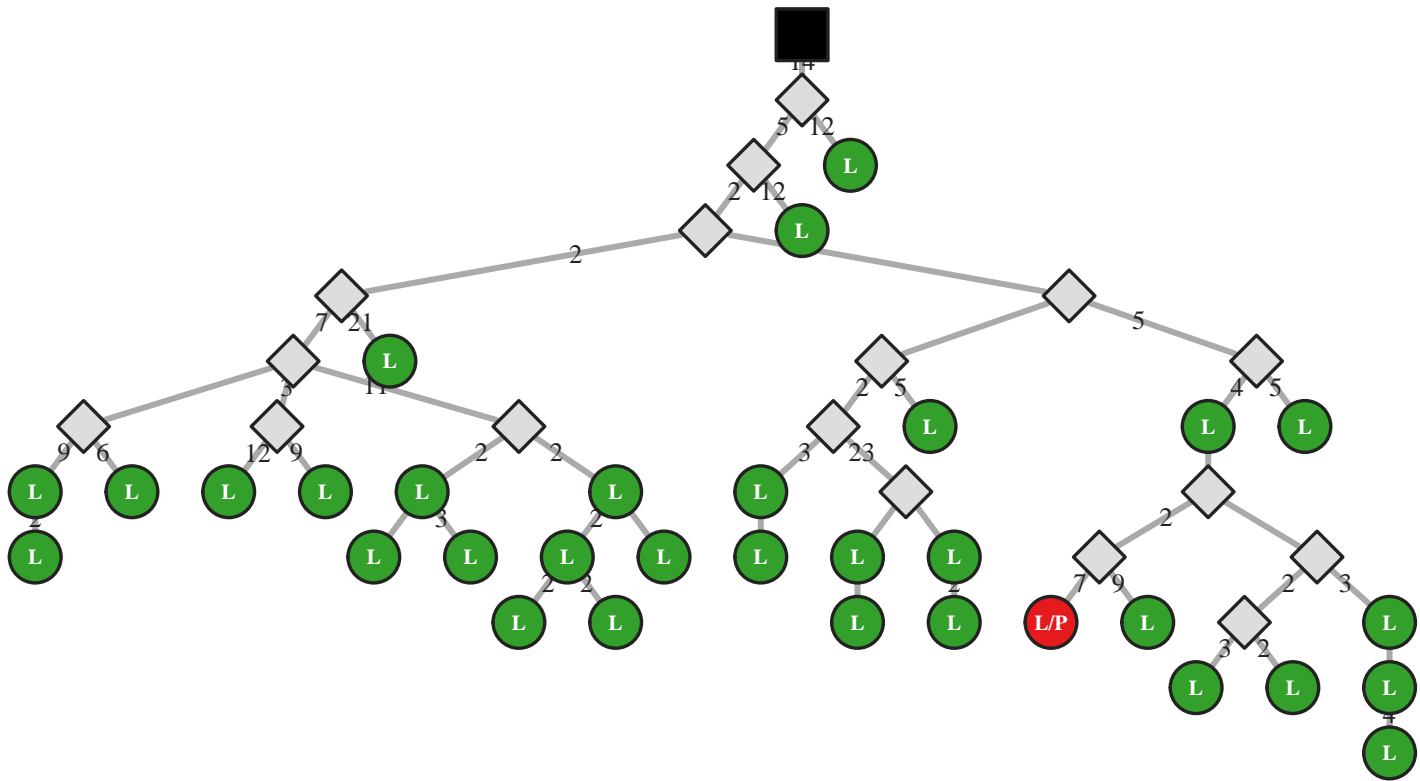

M5 IgA IGHV3-23/J4 36bp (12307)

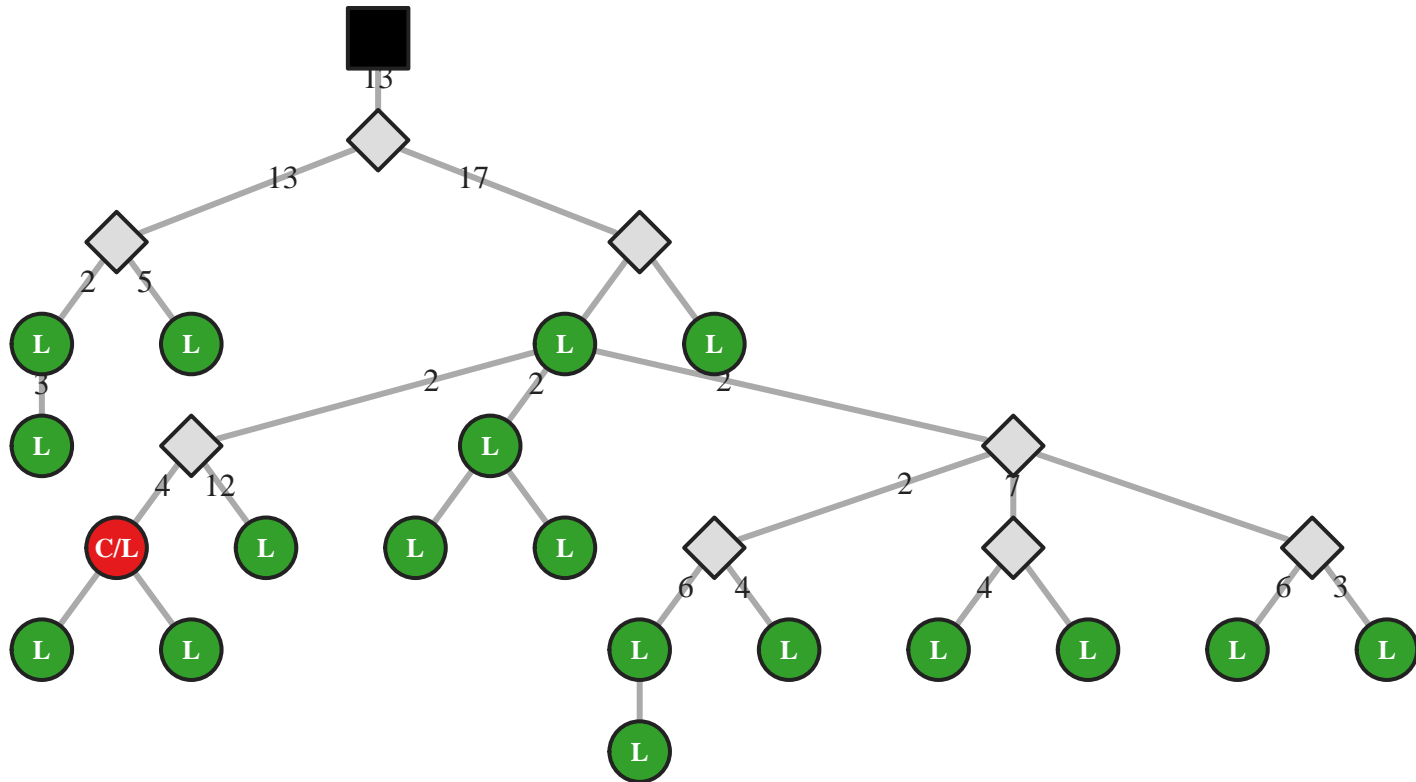

M5 IgA IGHV3-23/J4 39bp (12317)

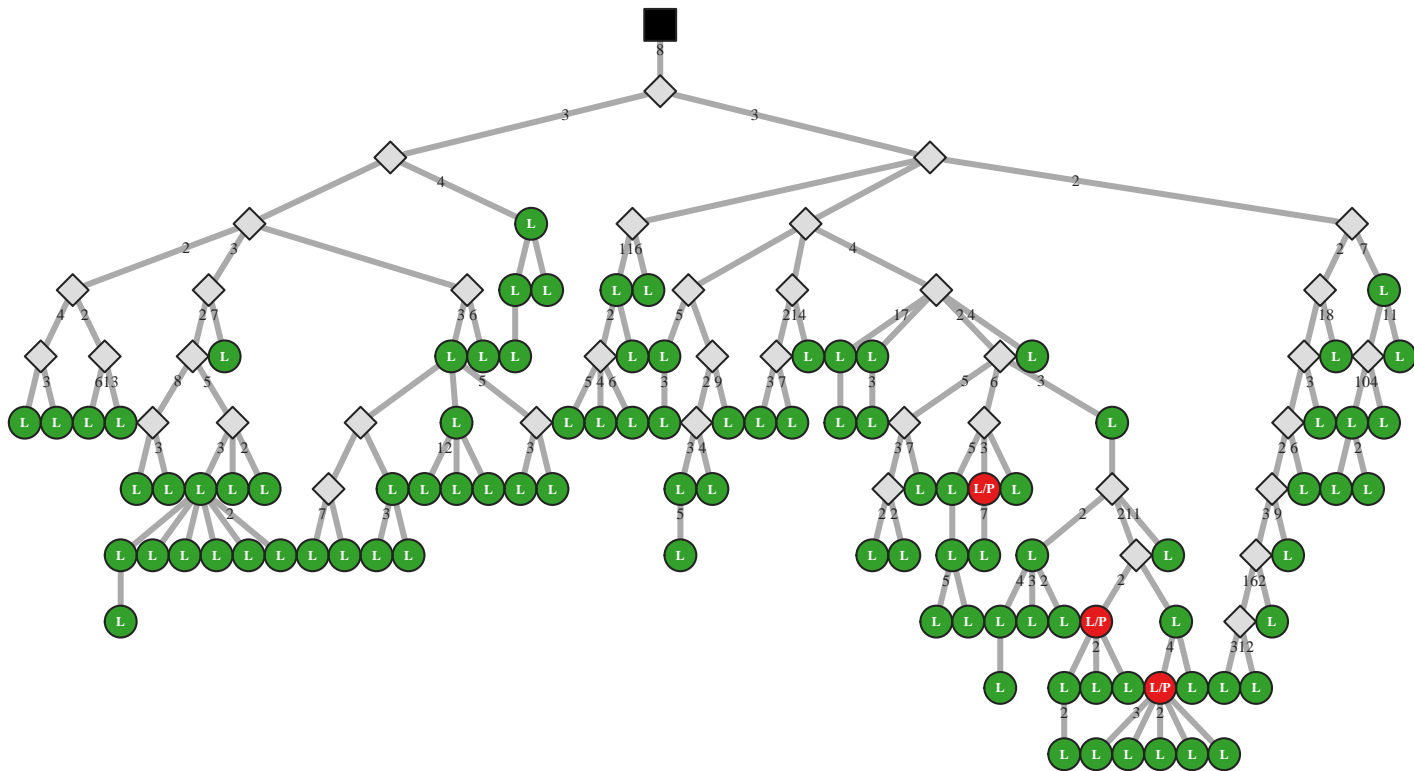

M5 IgG IGHV3-23/J4 39bp (43694)

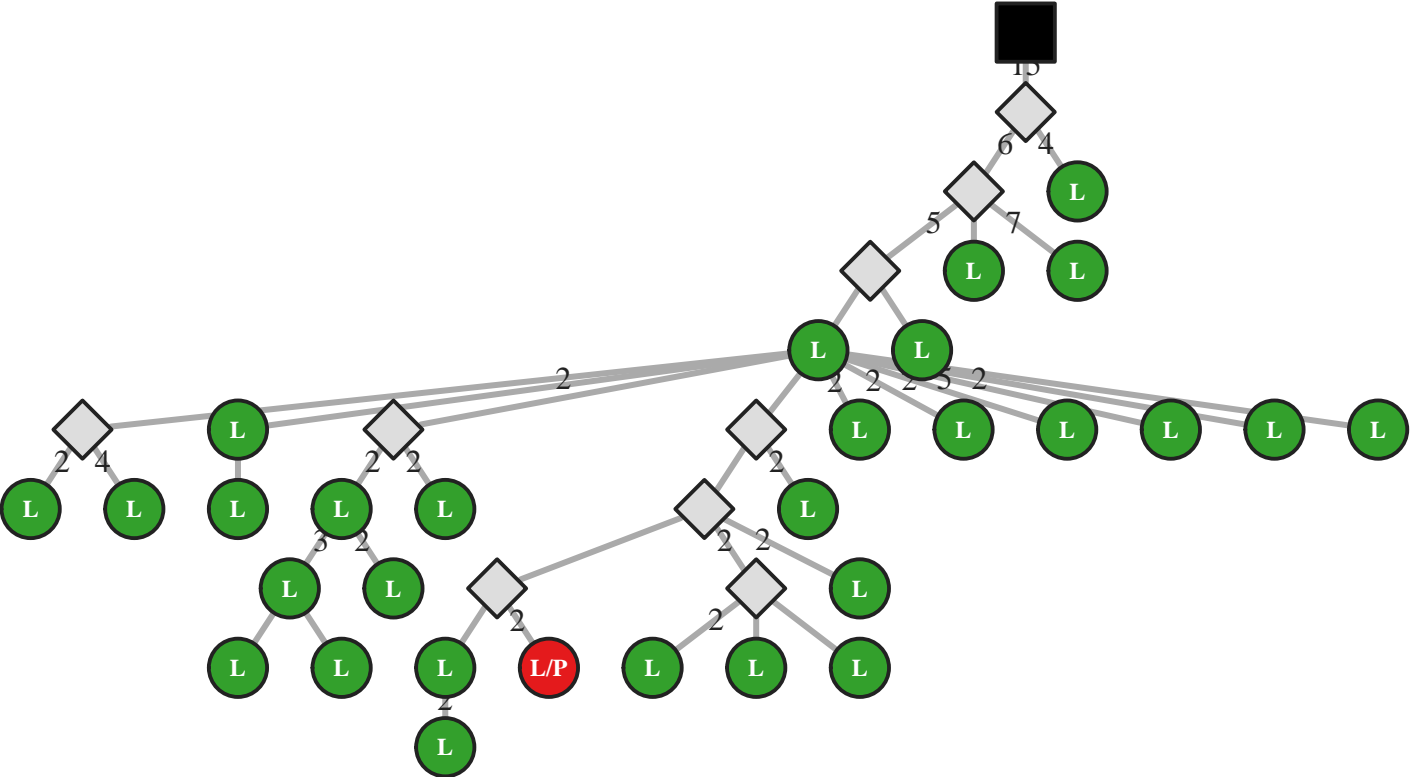

M5 IgG IGHV3-23/J4 39bp (43700)

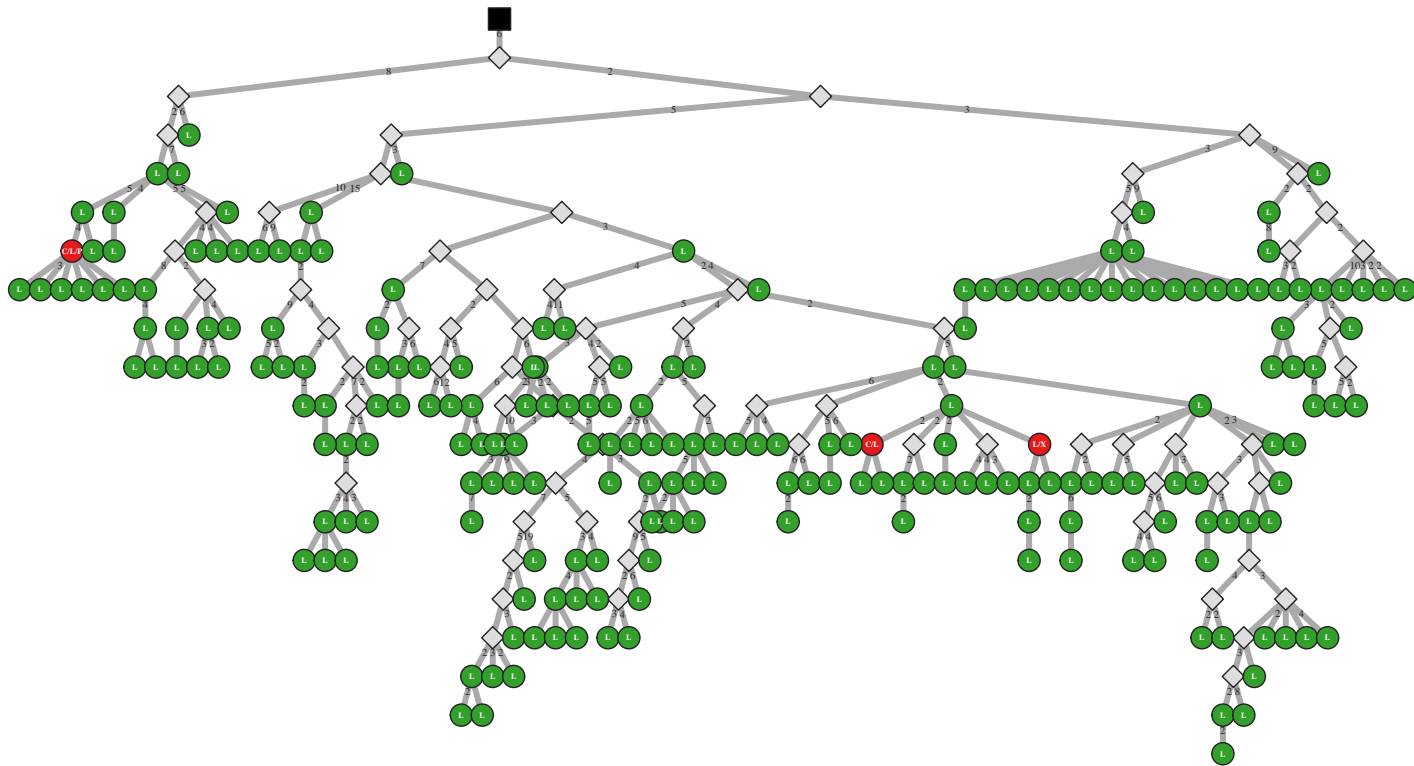

M5 IgG IGHV3-23/J4 39bp (43711)

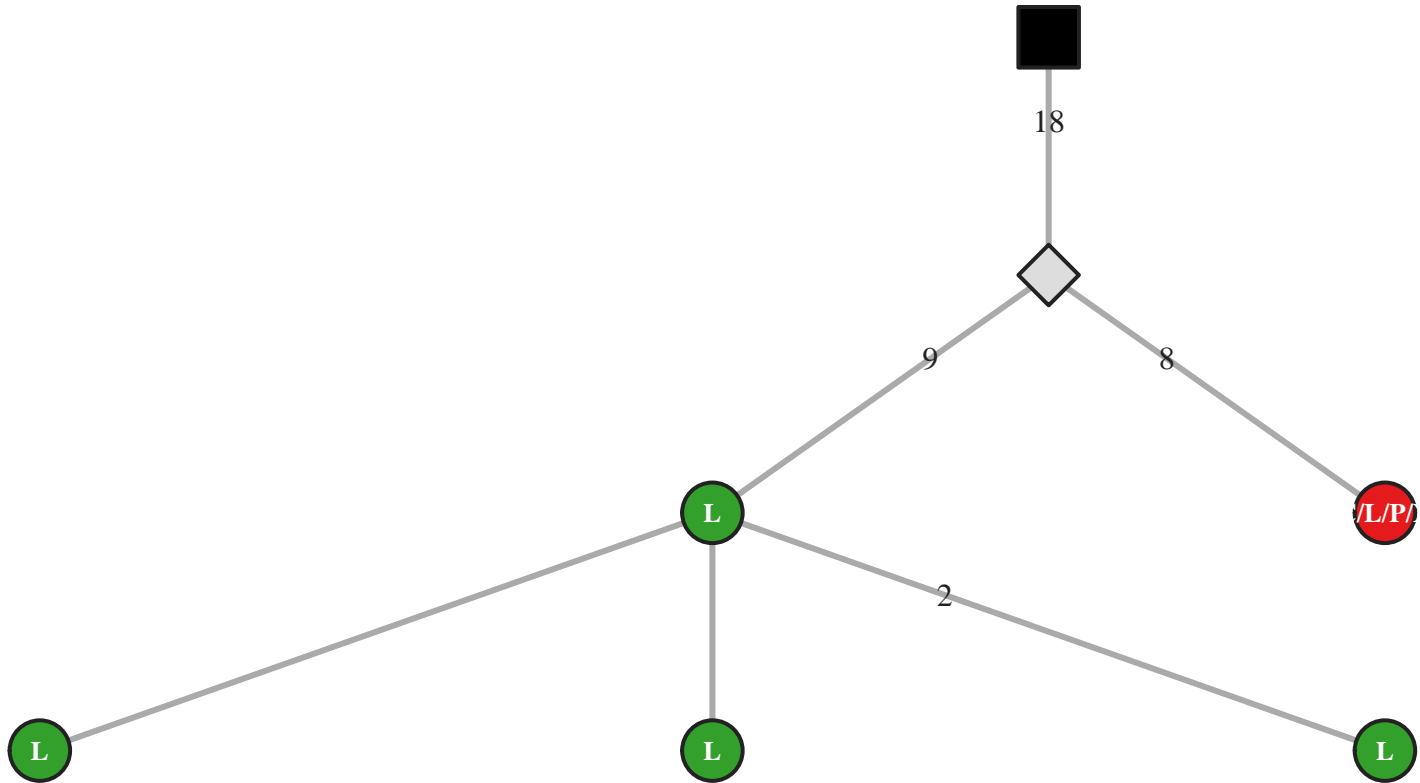

M5 IgG IGHV3-23/J4 39bp (43727)

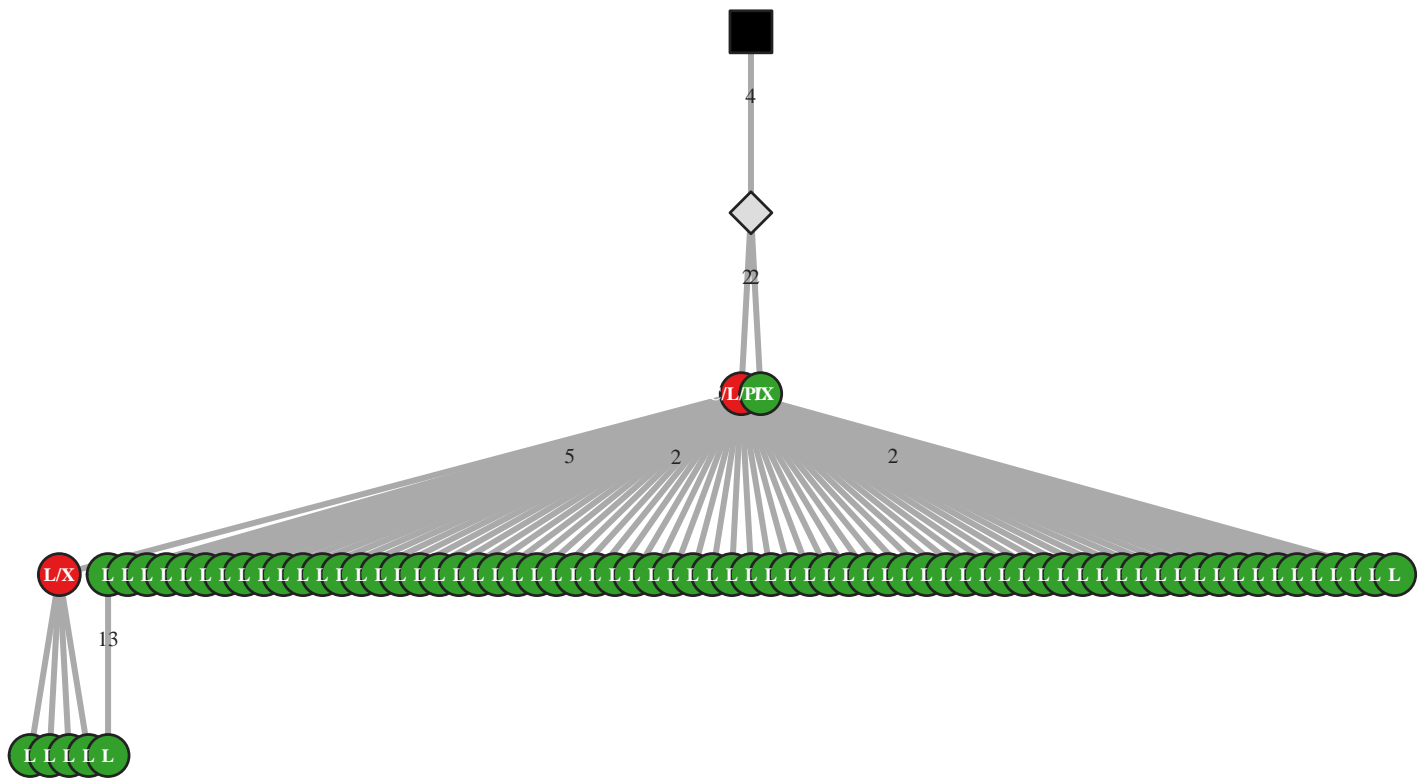

M5 IgG IGHV3-23/J4 39bp (43736)

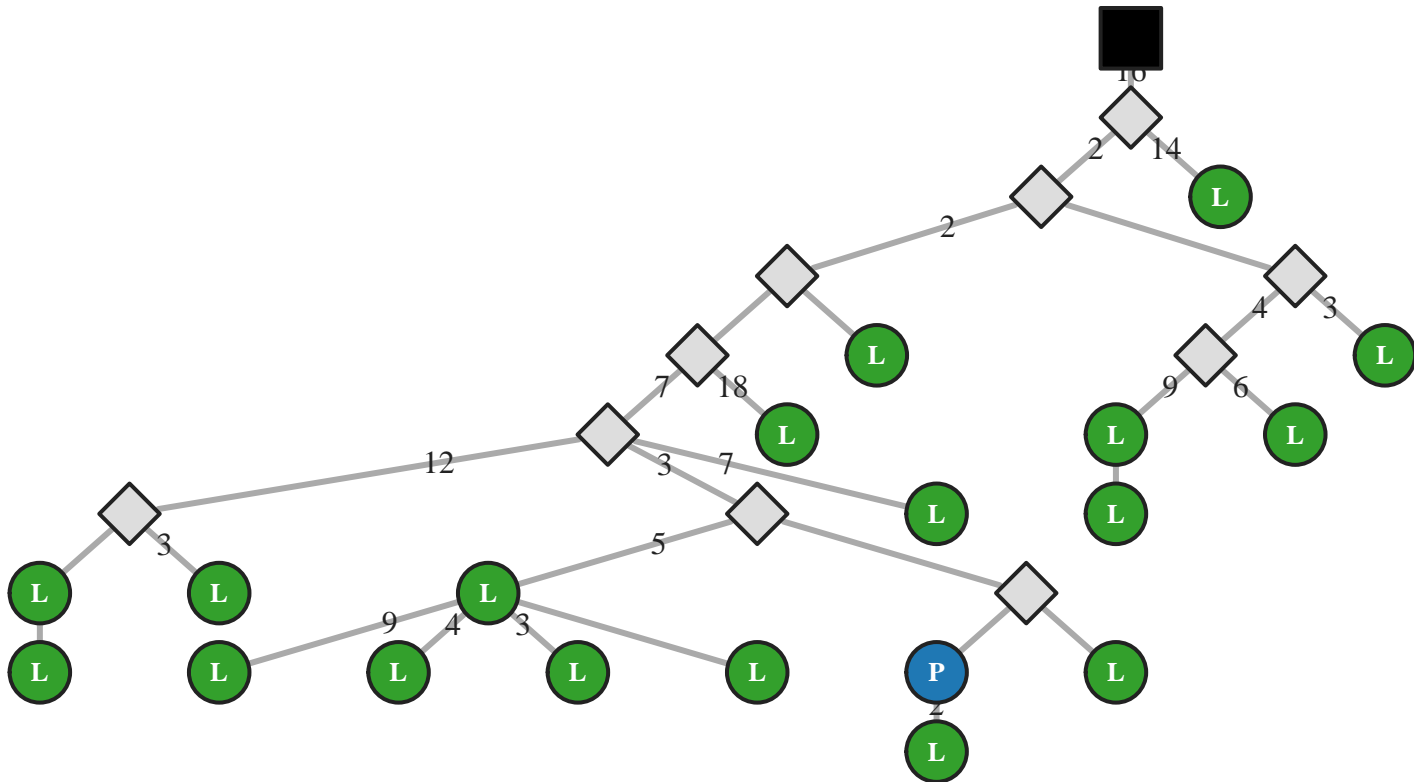

M5 IgG IGHV3-23/J4 42bp (43759)

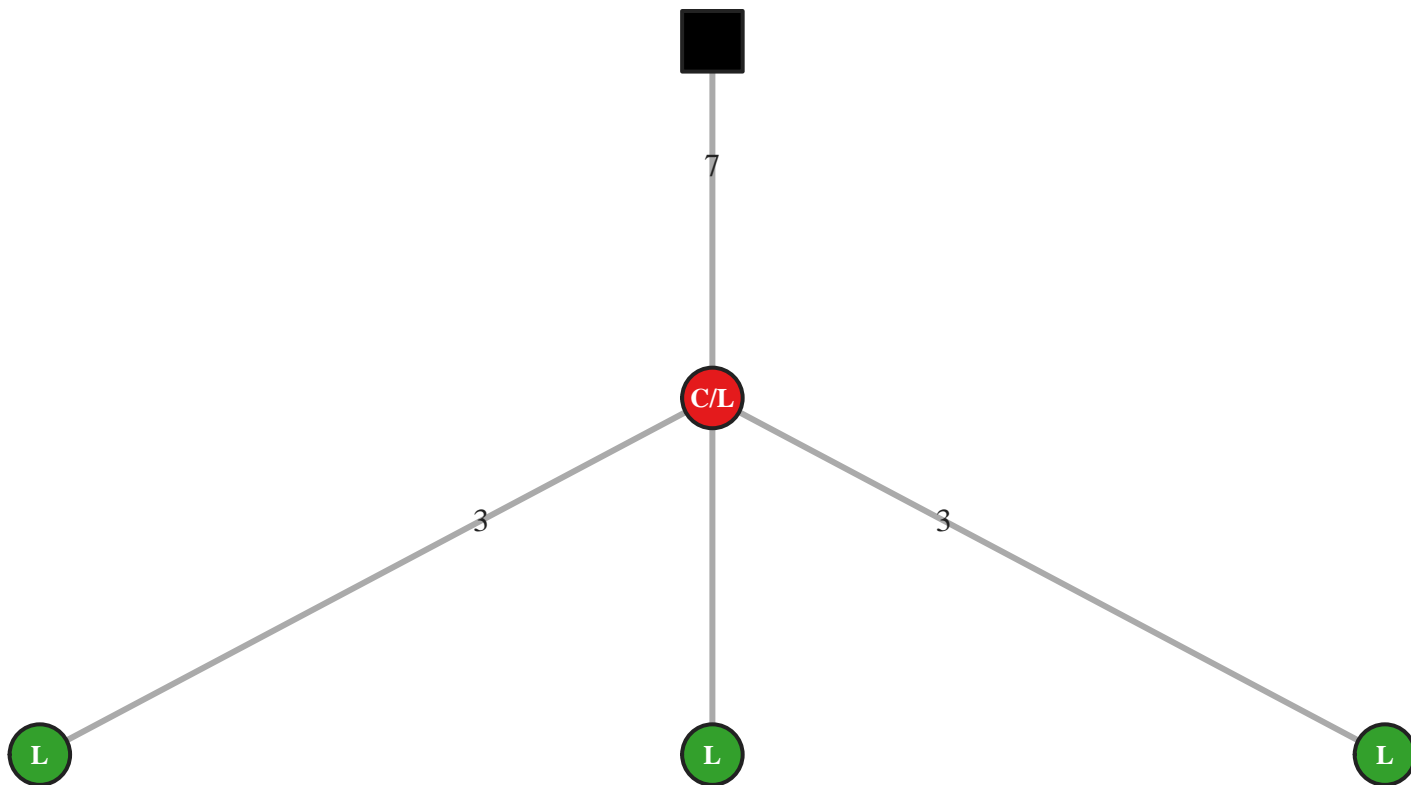

M5 IgG IGHV3-23/J4 45bp (51505)

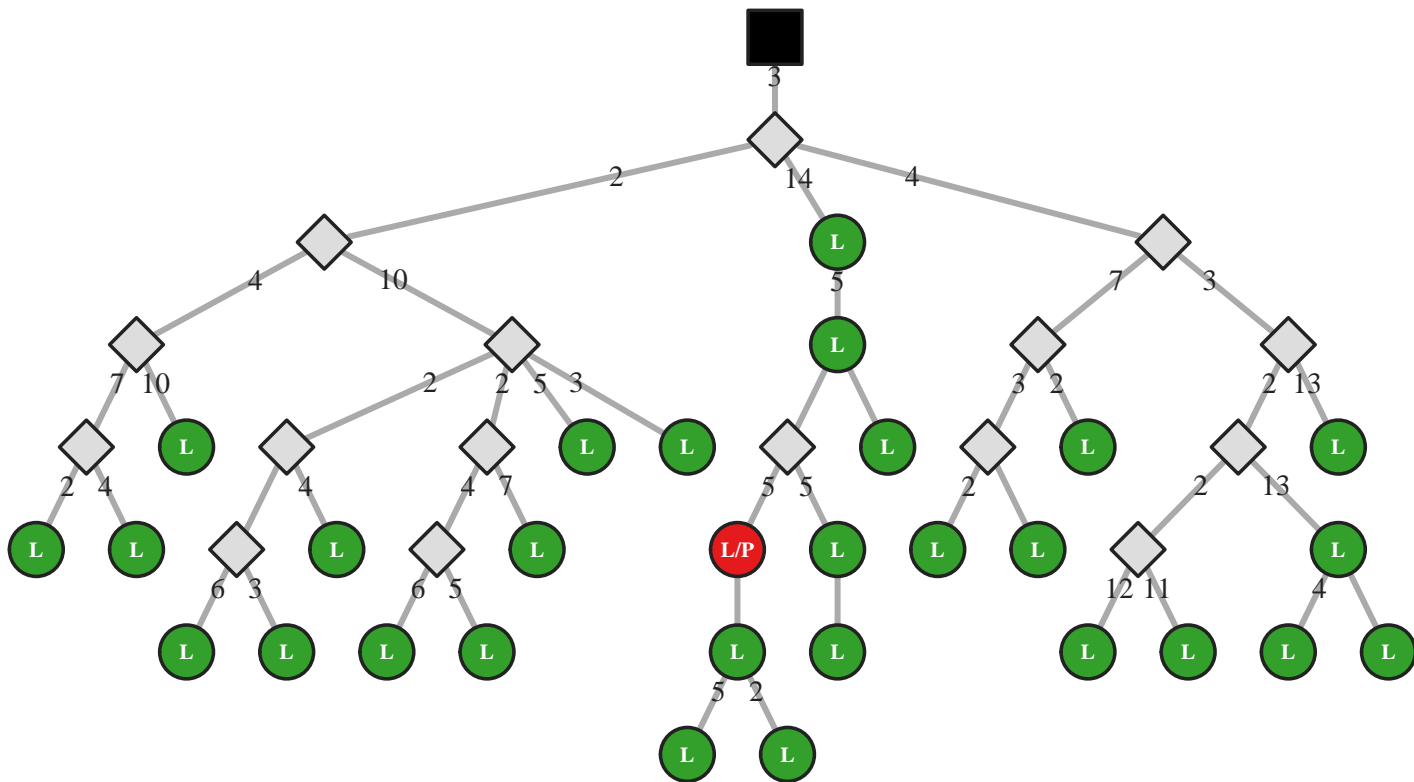

M5 IgG IGHV3-23/J4 45bp (51590)

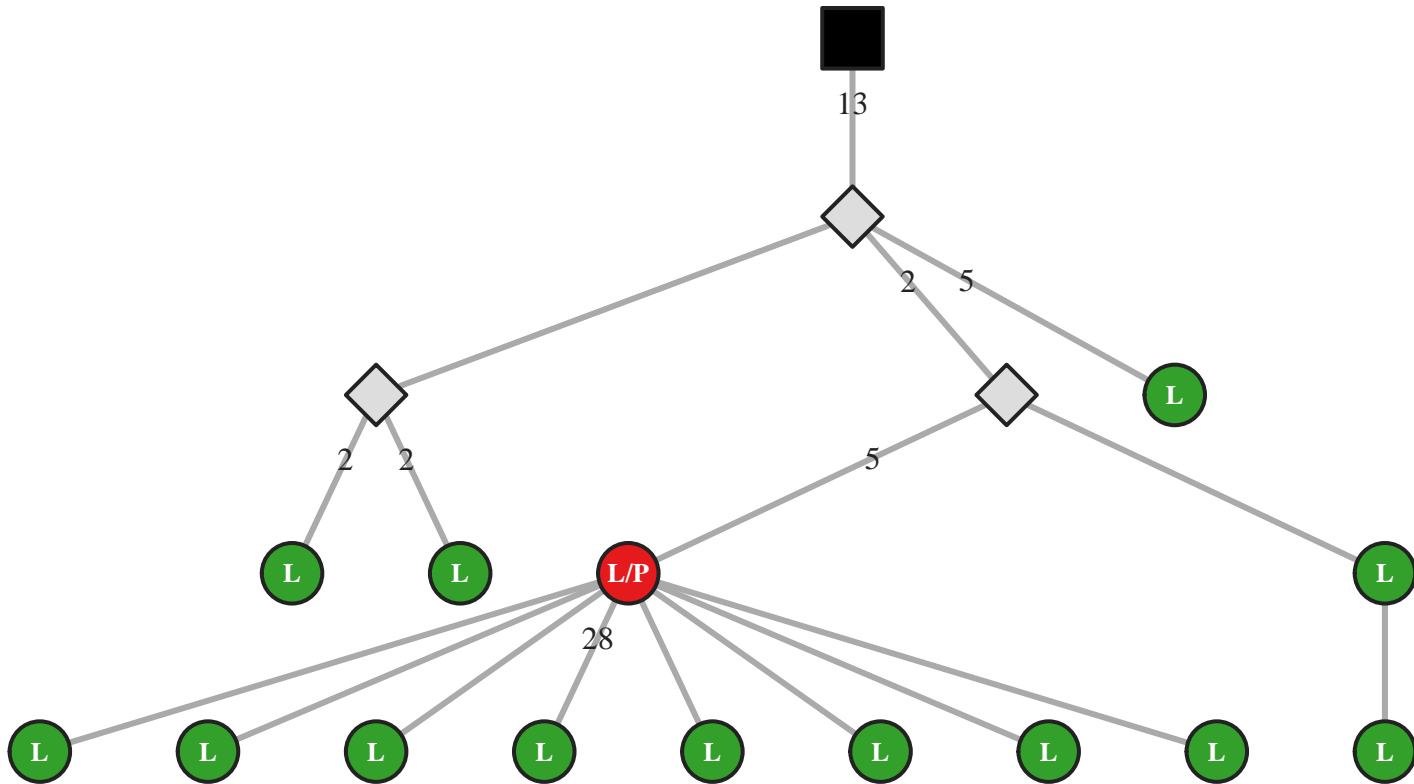

M5 IgG IGHV3-23/J4 45bp (51591)

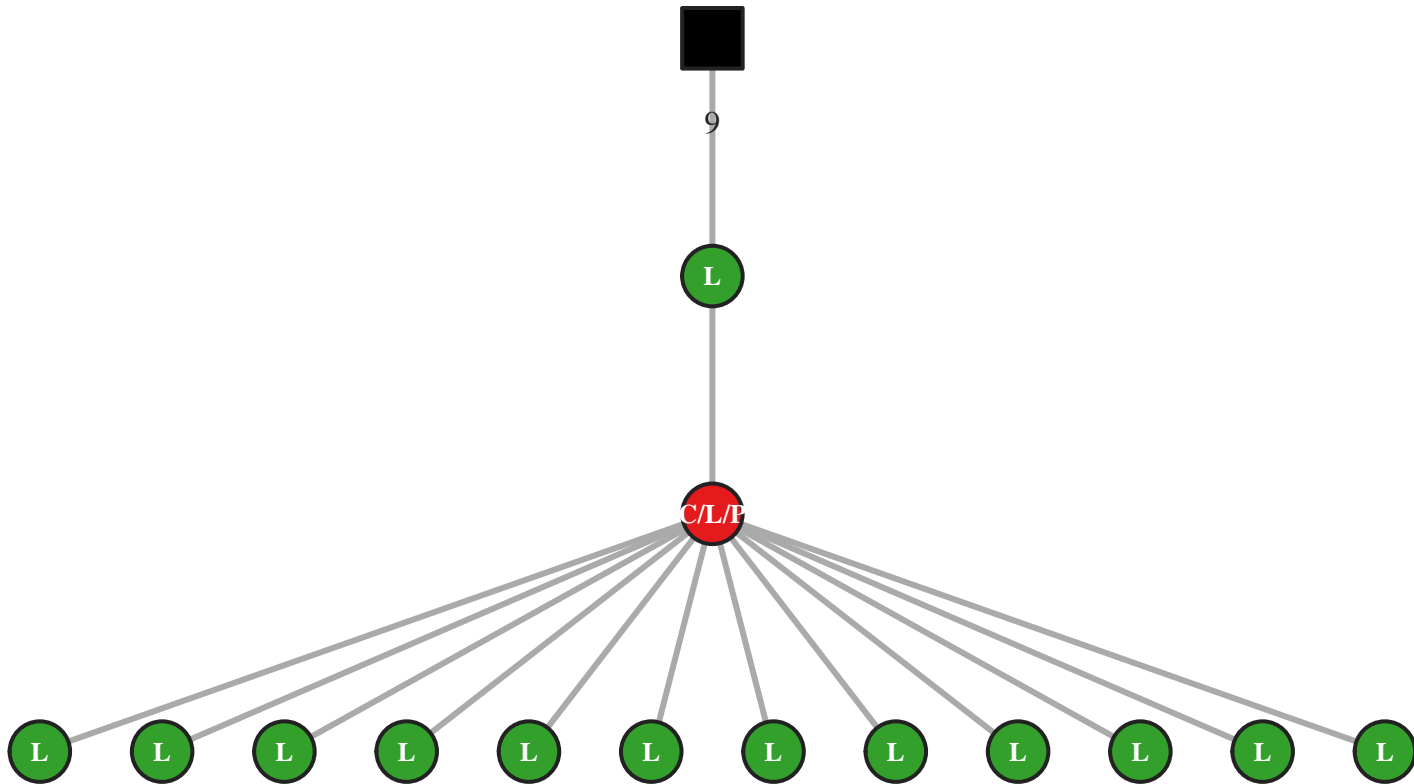

M5 IgG IGHV3-23/J4 48bp (6642)

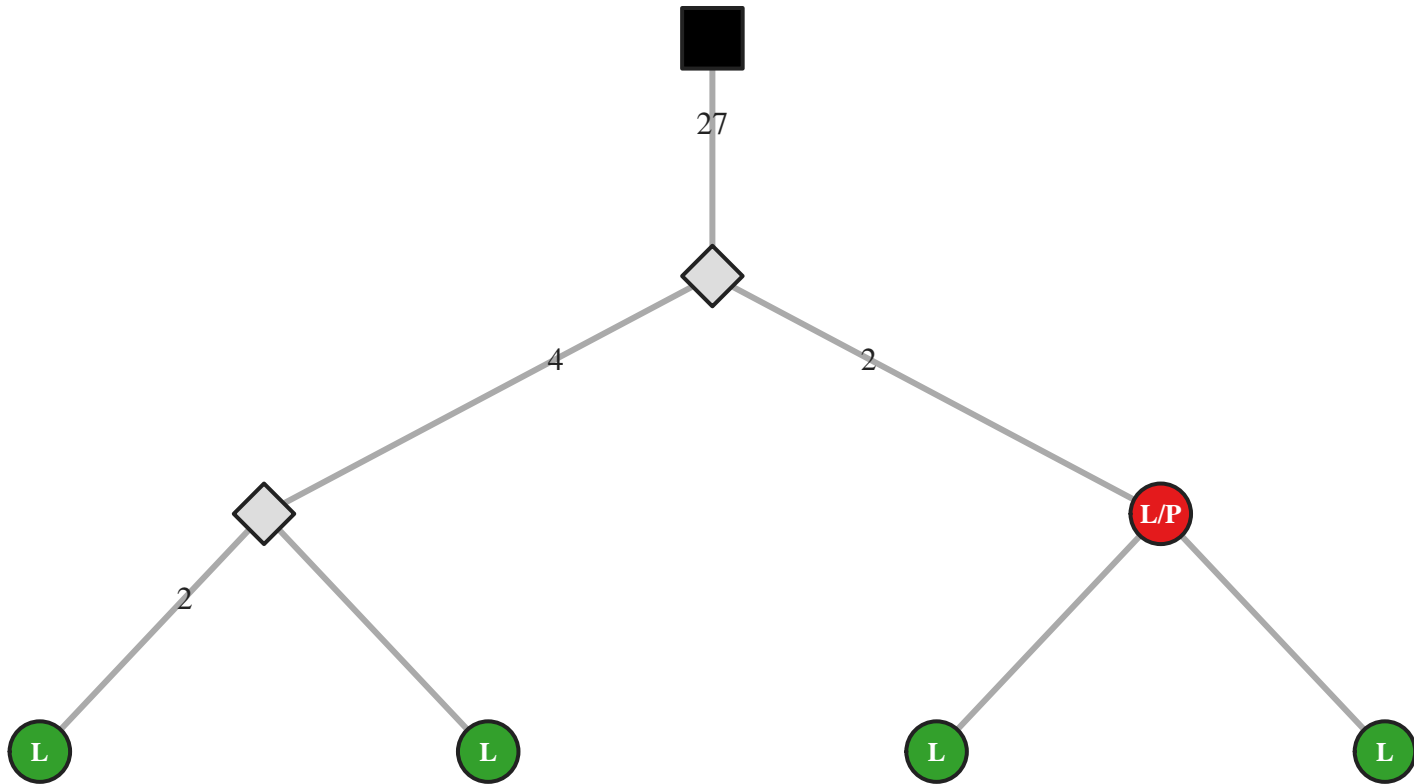

M5 IgG IGHV3-23/J4 48bp (6710)

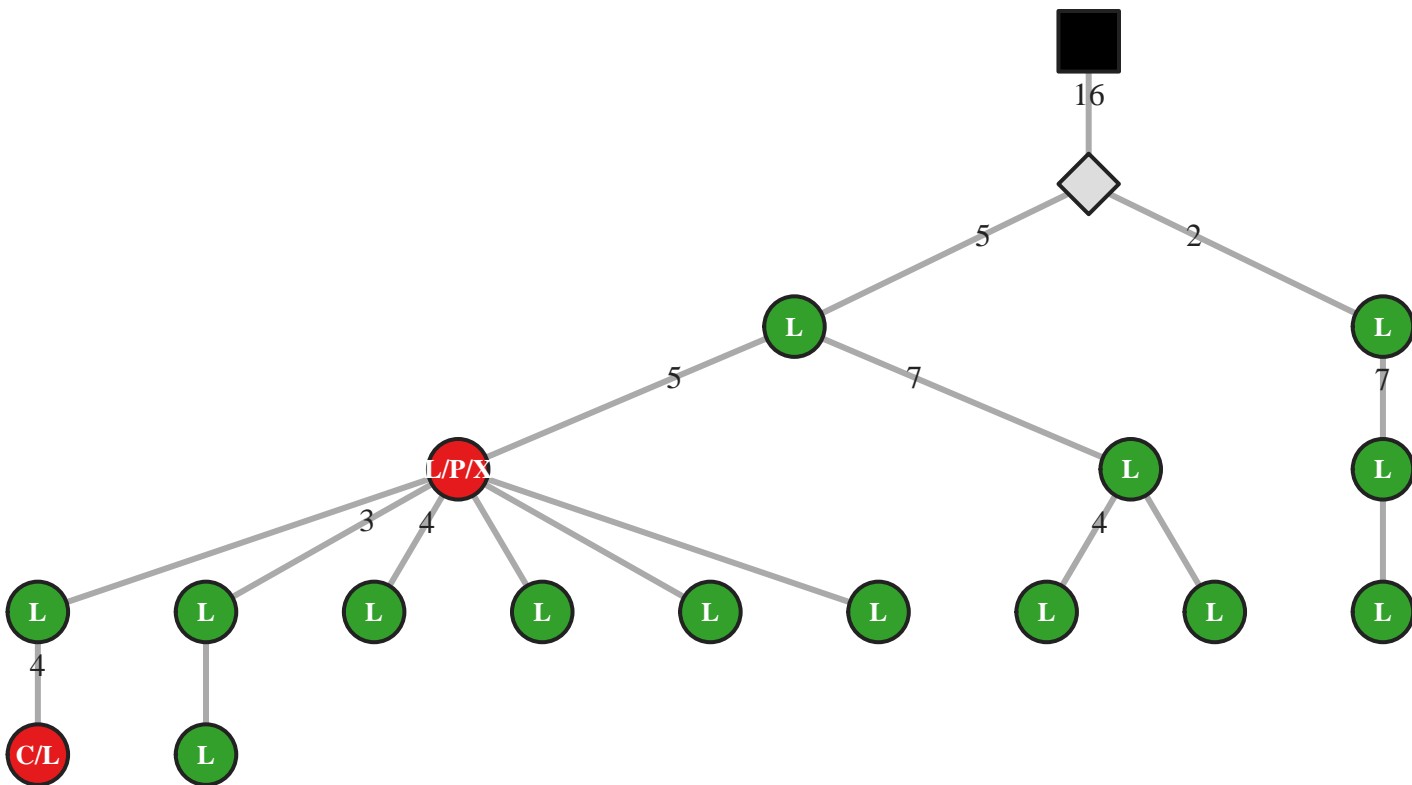

M5 IgG IGHV3-23/J4 48bp (6712)

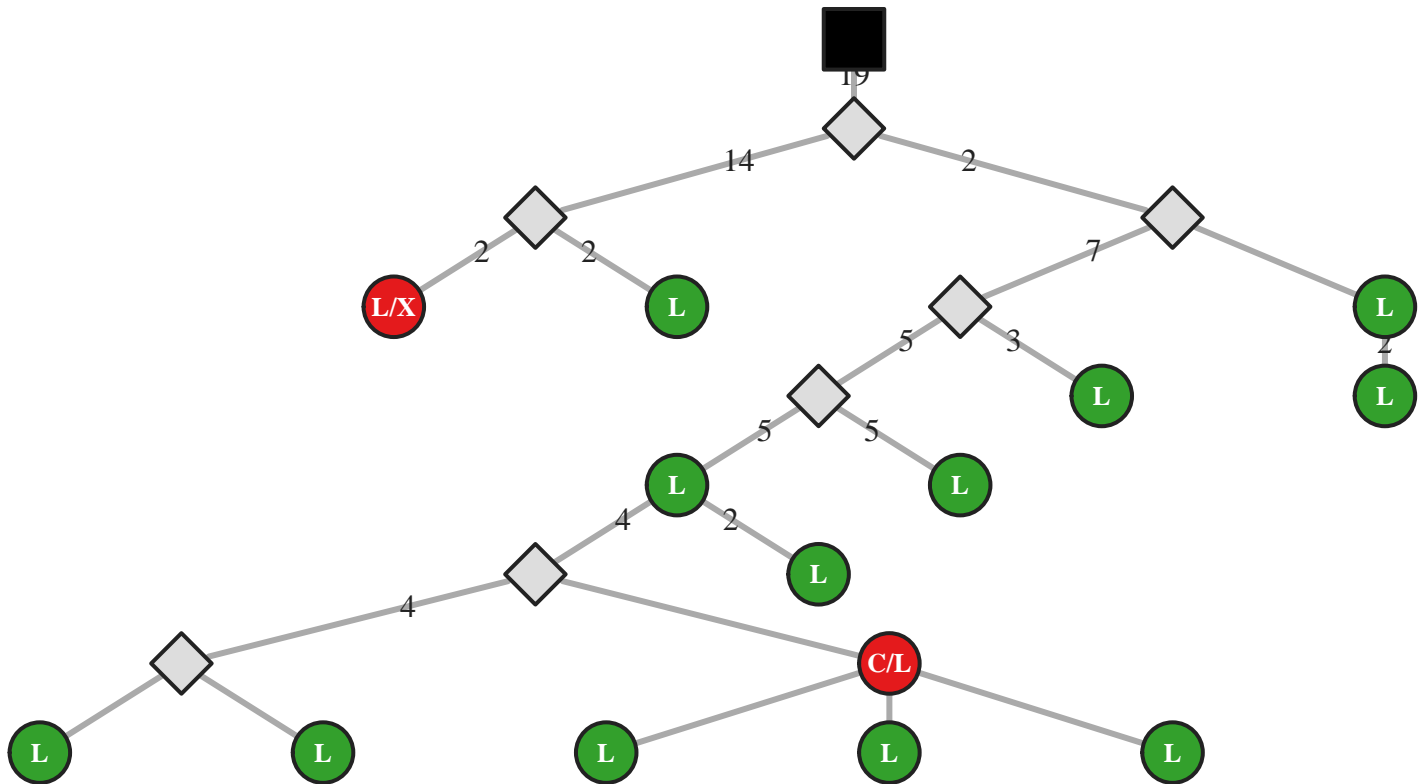

M5 IgG IGHV3-23/J4 48bp (6722)

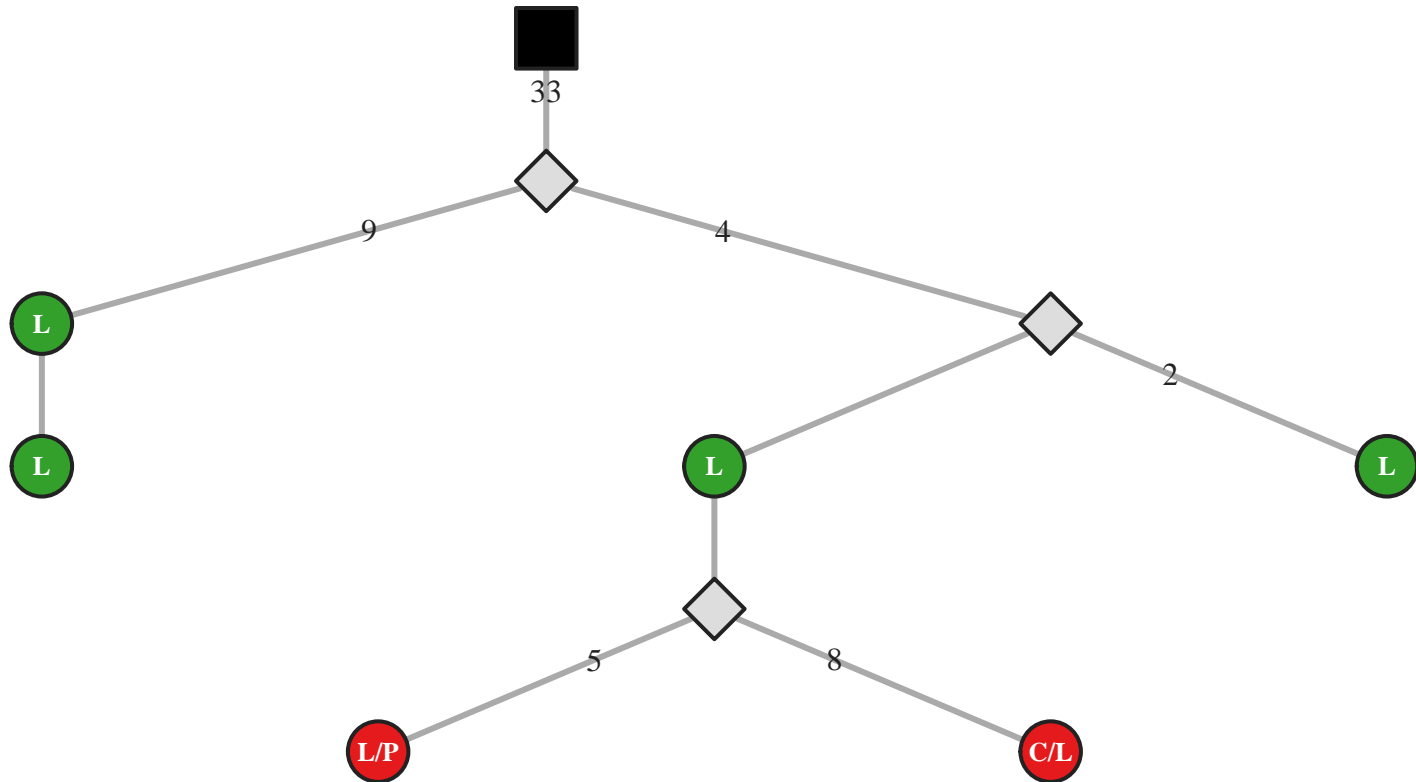

M5 IgG IGHV3-23/J4 51bp (6854)

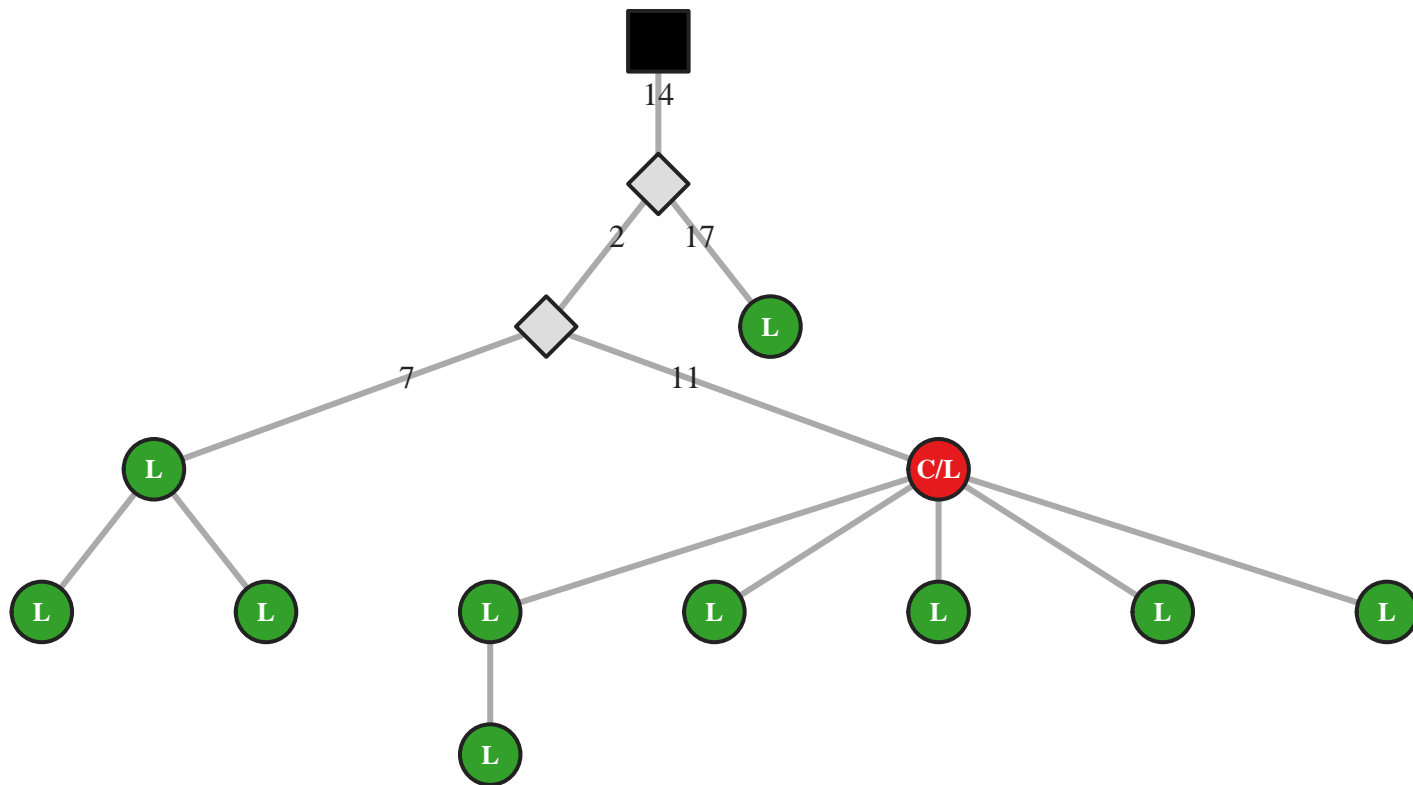

M5 IgG IGHV3-23/J4 51bp (6882)

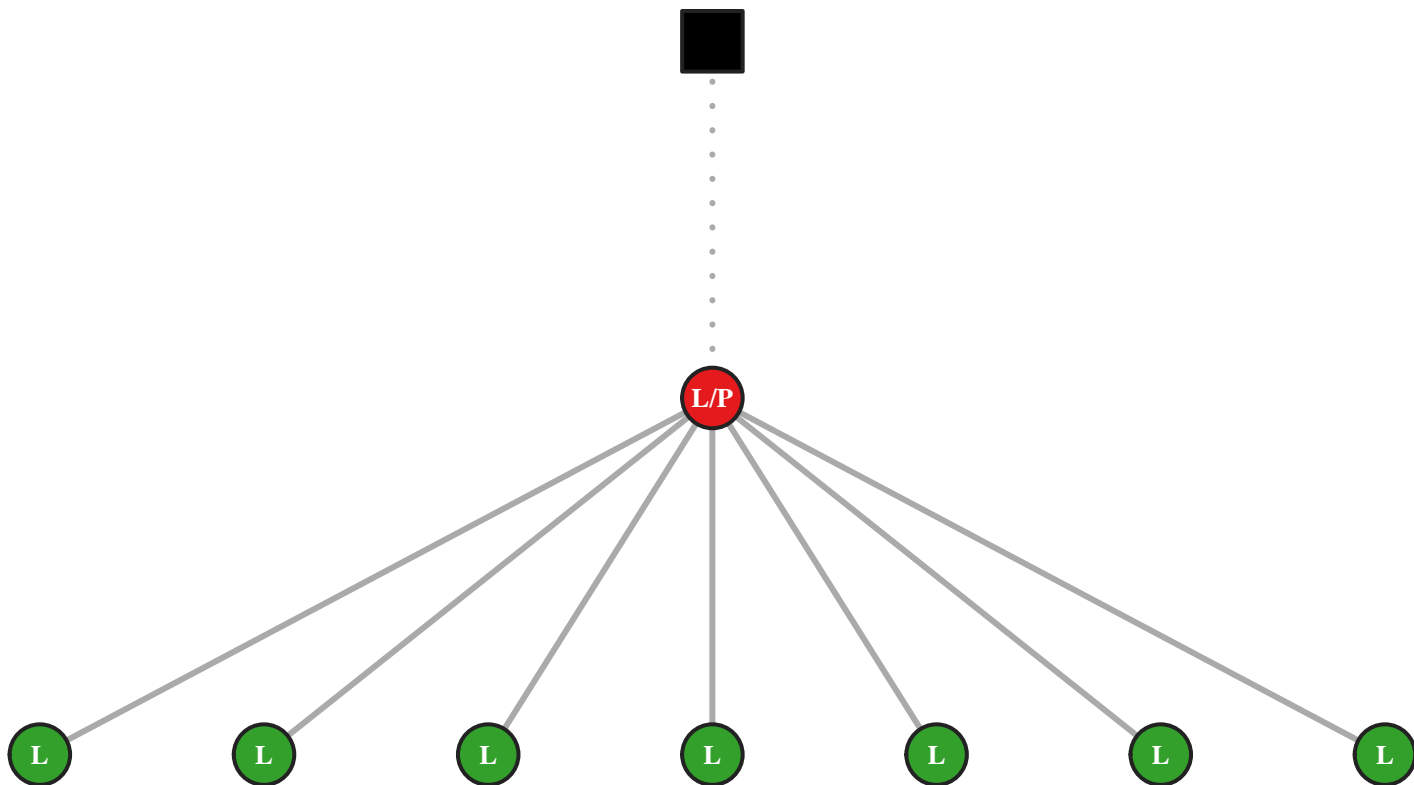

M5 IgG IGHV3-23/J4 54bp (25788)

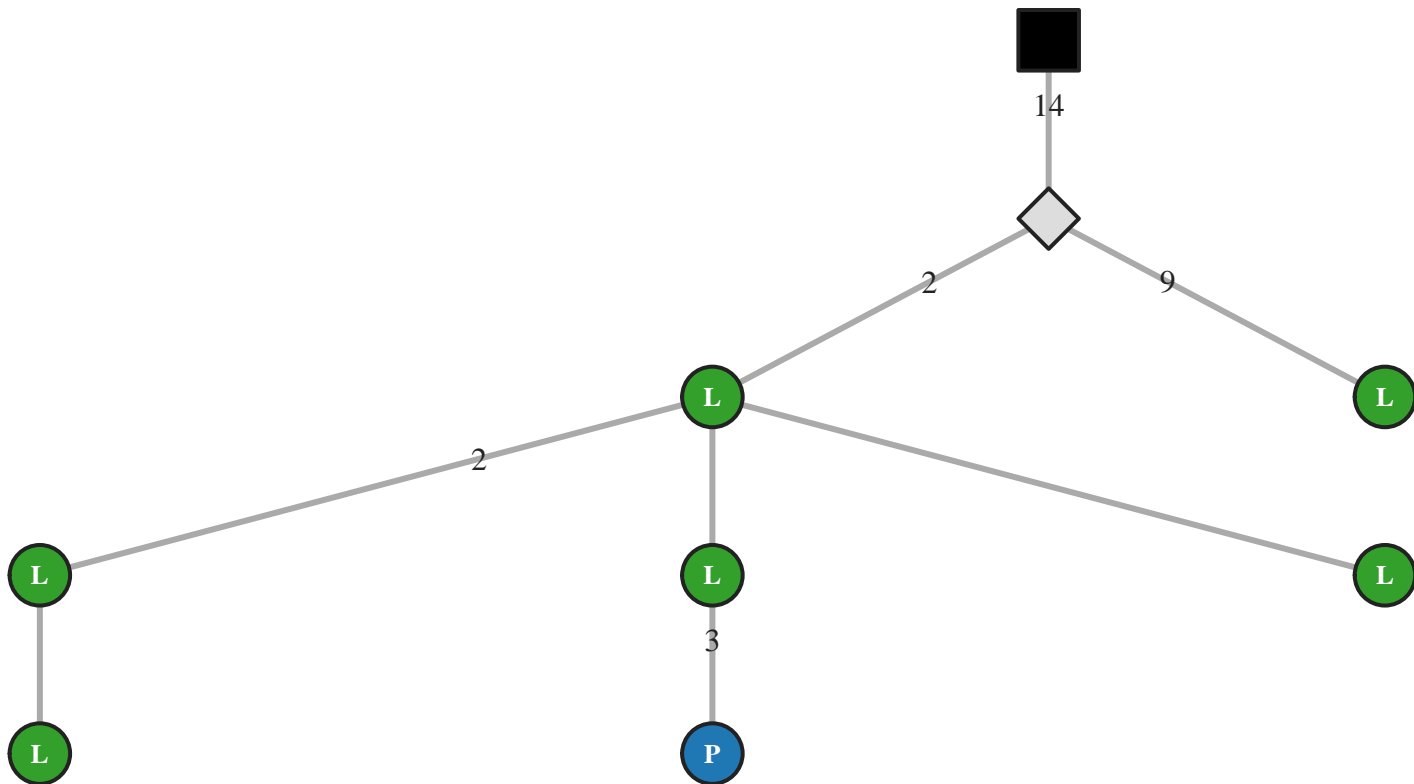

M5 IgG IGHV3-23/J4 54bp (25798)

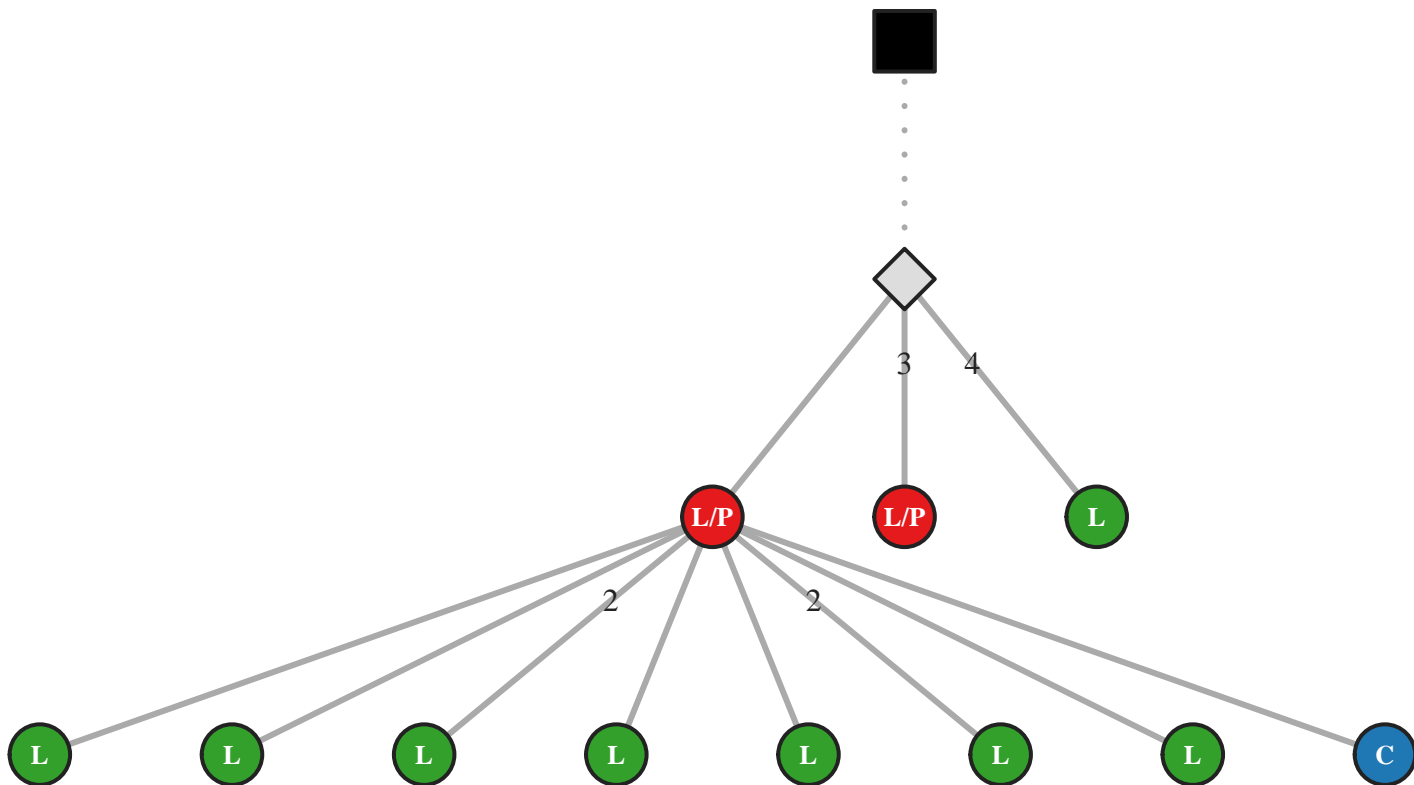

M5 IgA IGHV3-23/J4 72bp (2698)

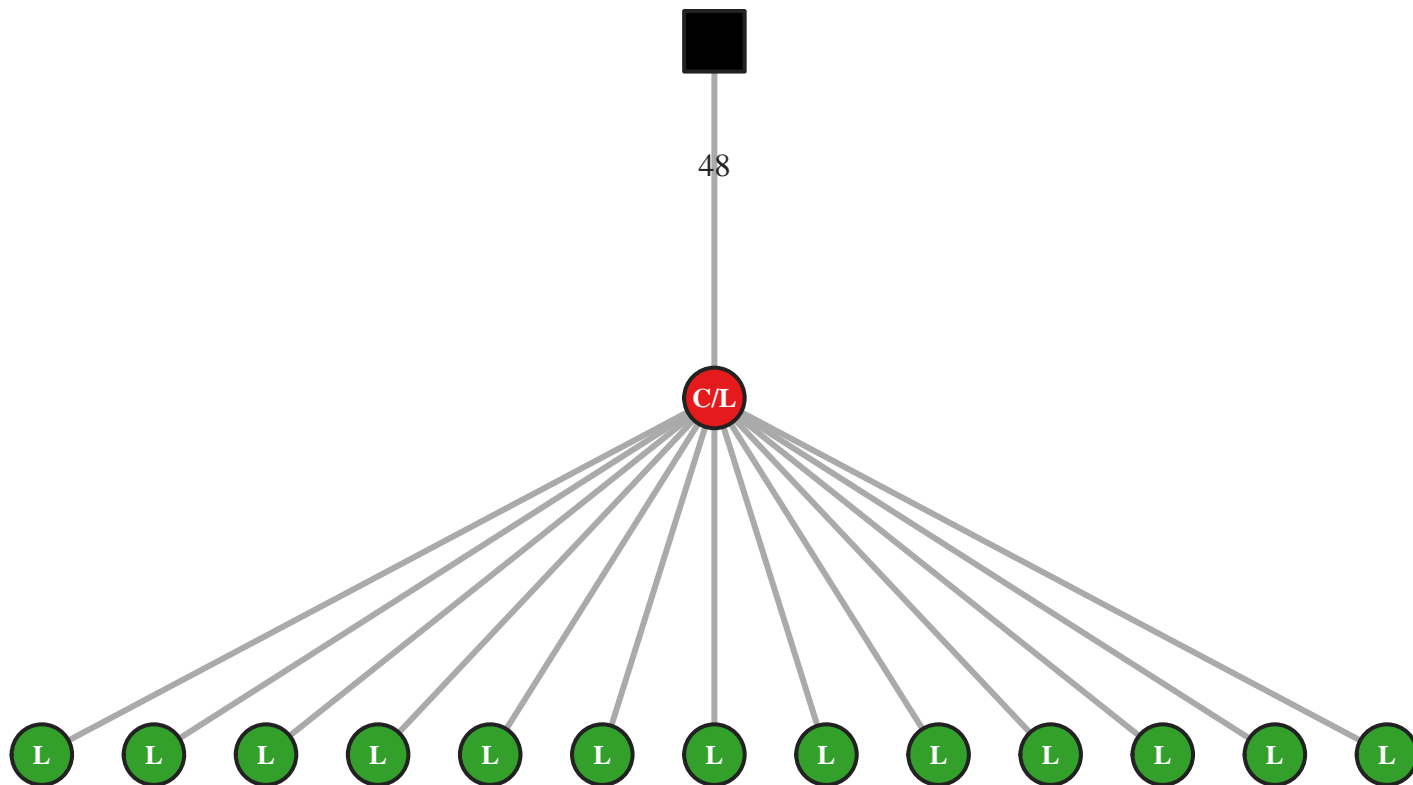

M5 IgM IGHV3-23/J5 33bp (47925)

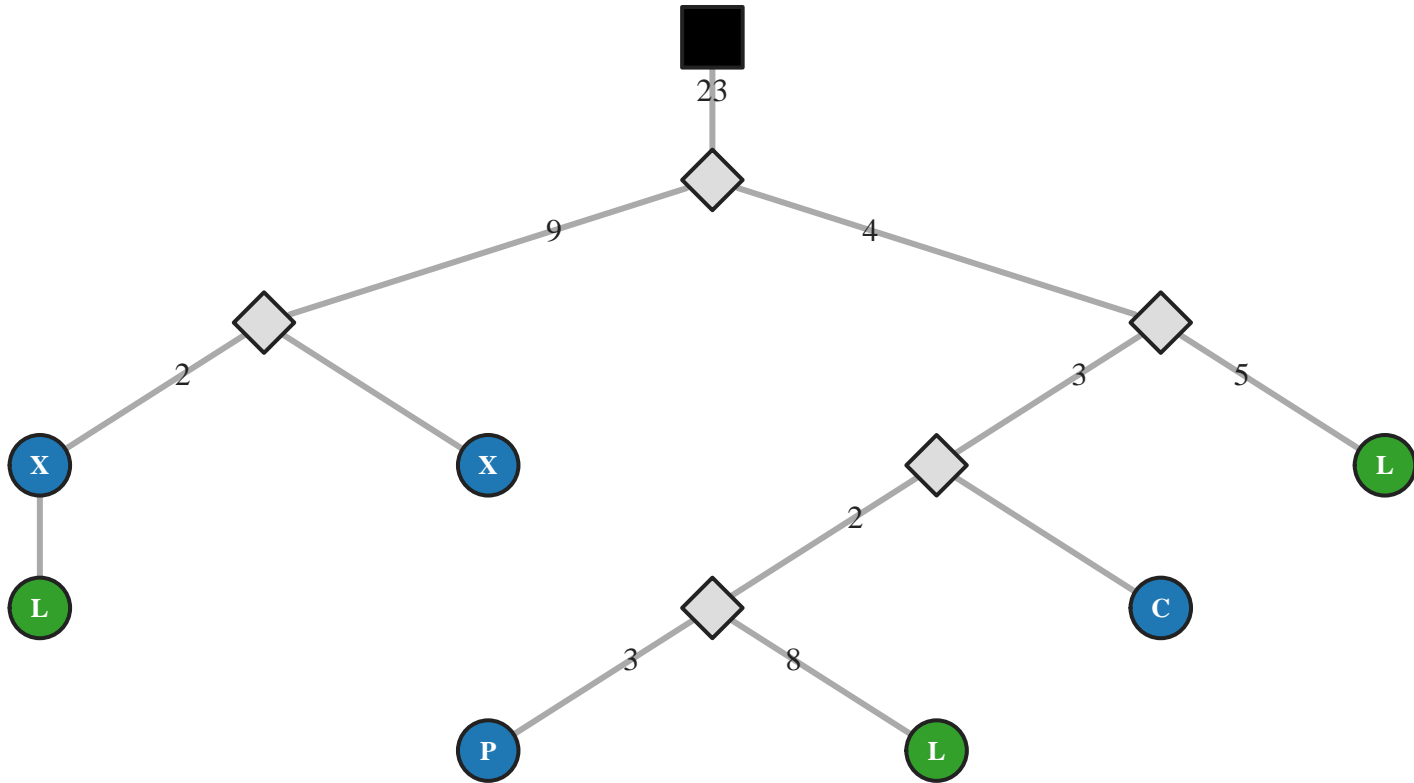

M5 IgG IGHV3-23/J5 36bp (25832)

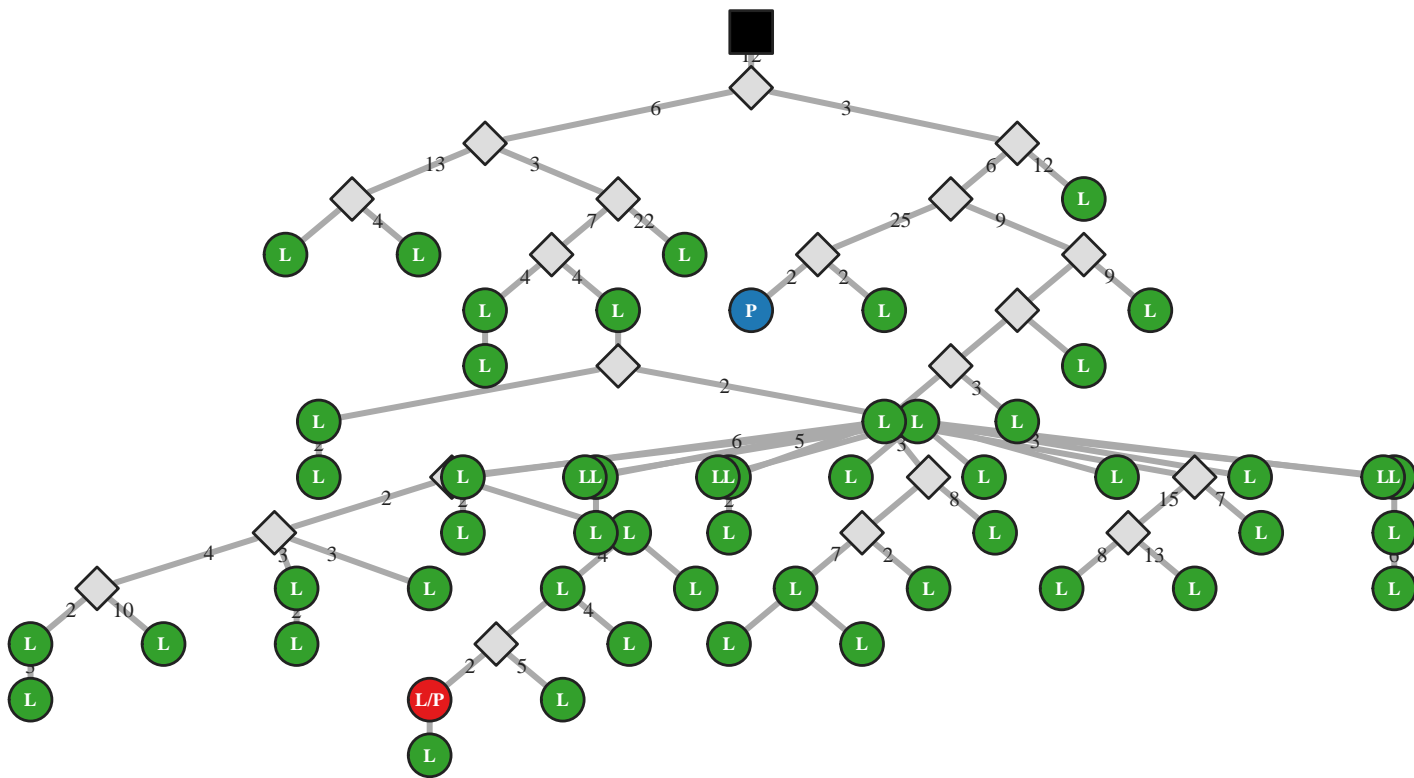

M5 IgG IGHV3-23/J5 51bp (7024)

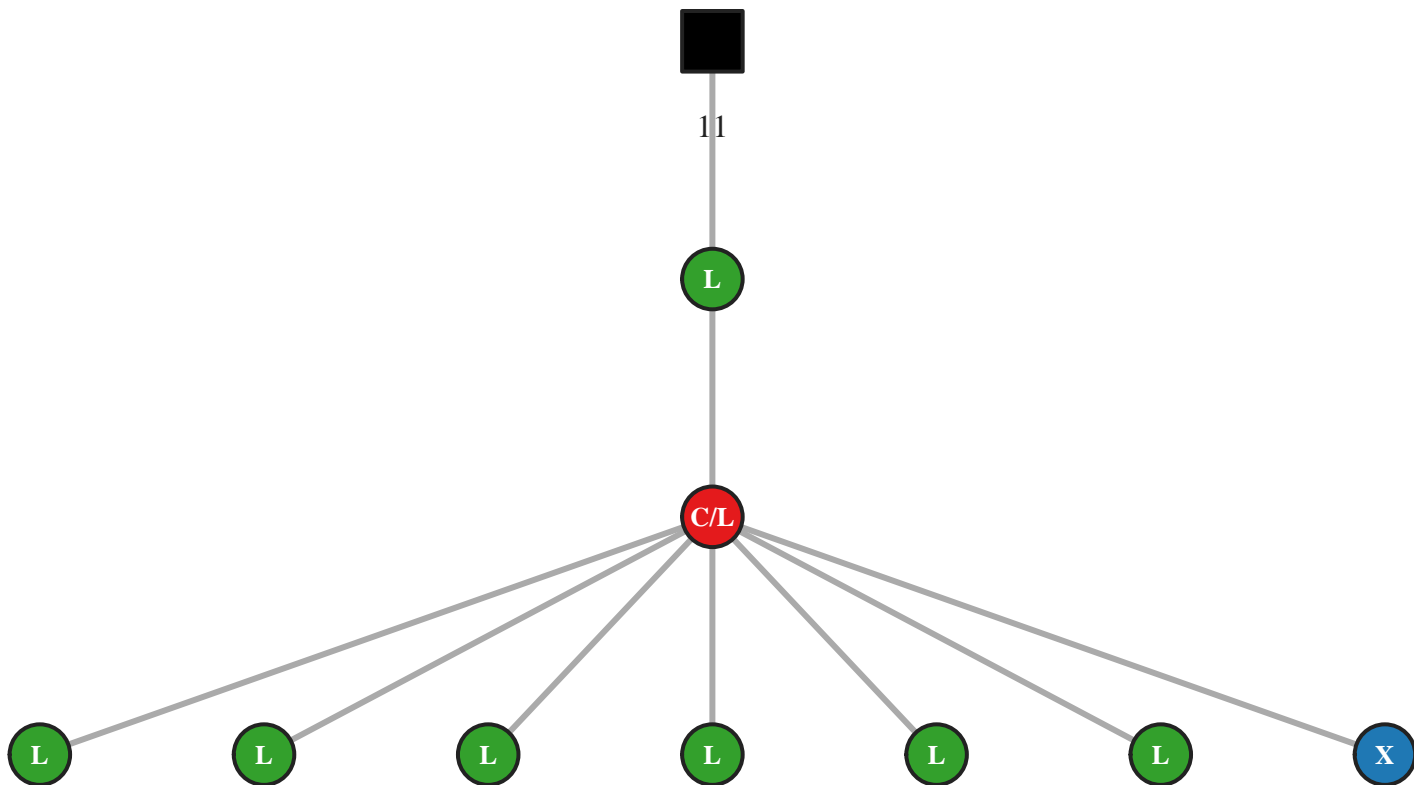

M5 IgM IGHV3-23/J5 51bp (20738)

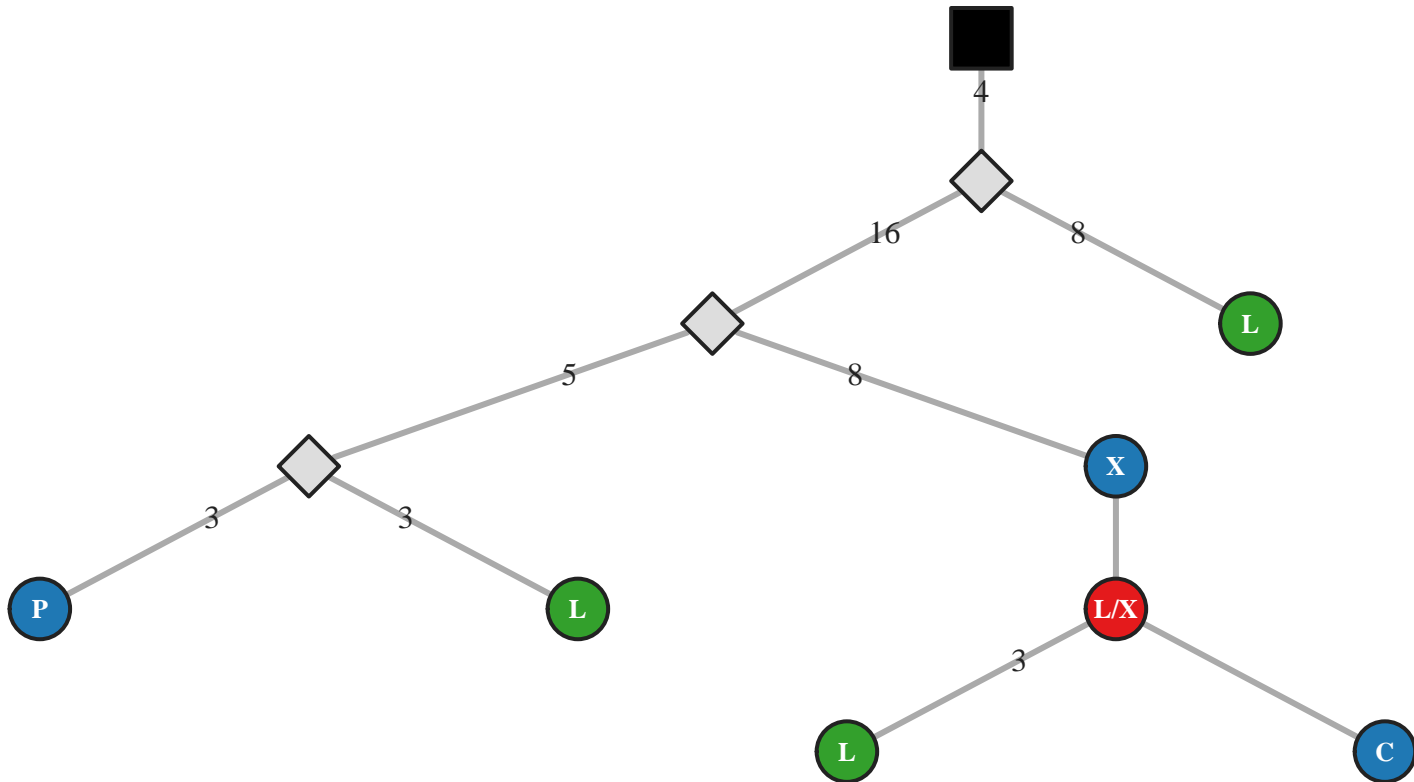

M5 IgG IGHV3-23/J6 42bp (43840)

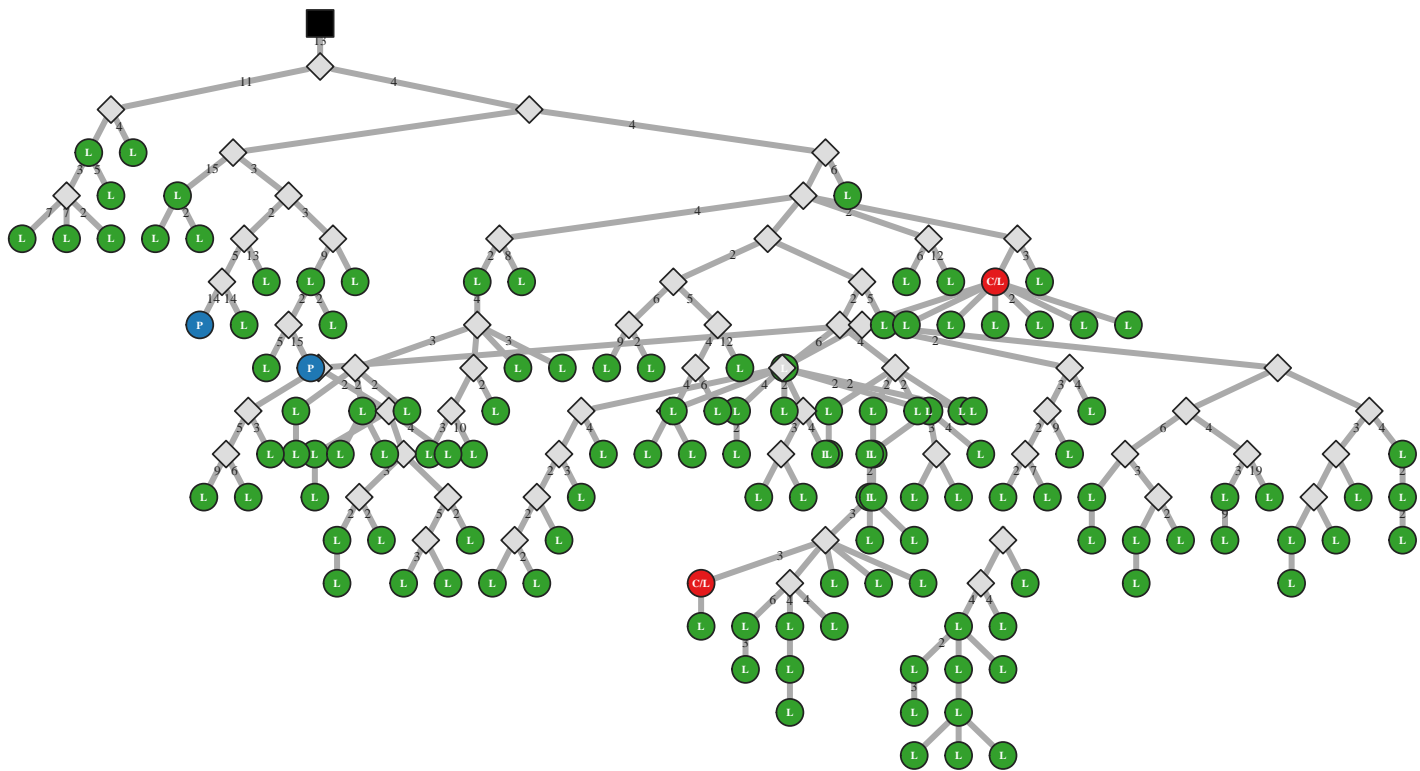

M5 IgG IGHV3-23/J6 45bp (7033)

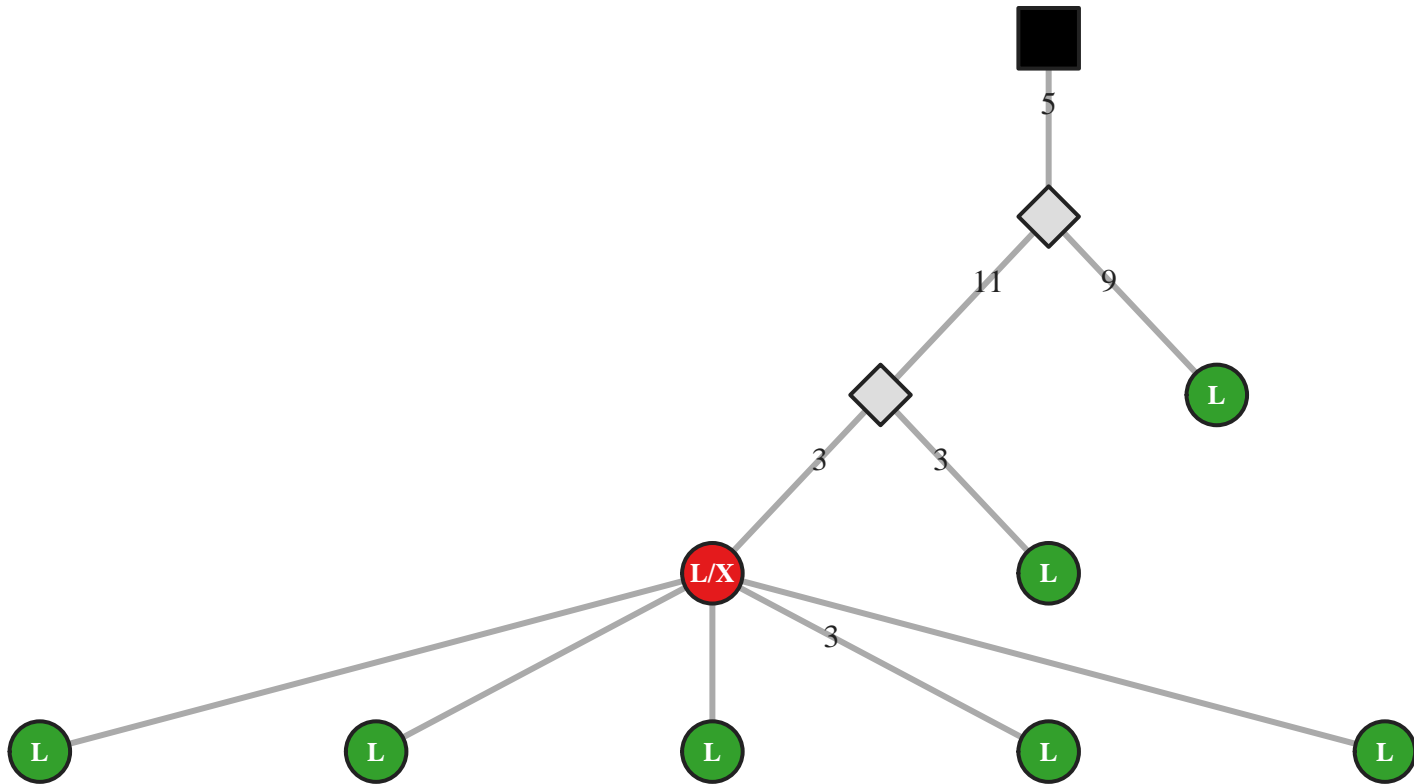

M5 IgG IGHV3-23/J6 51bp (43850)

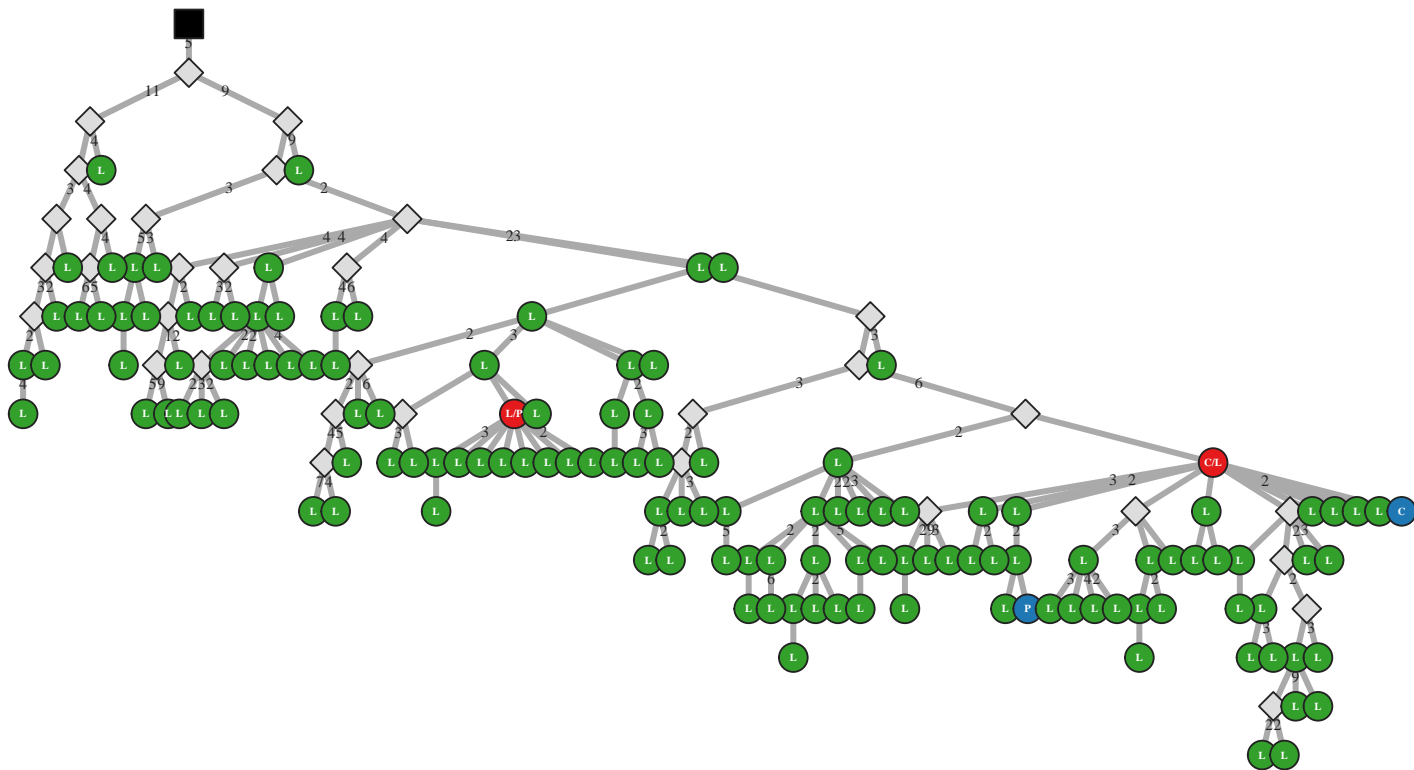

M5 IgG IGHV3-23/J6 51bp (43865)

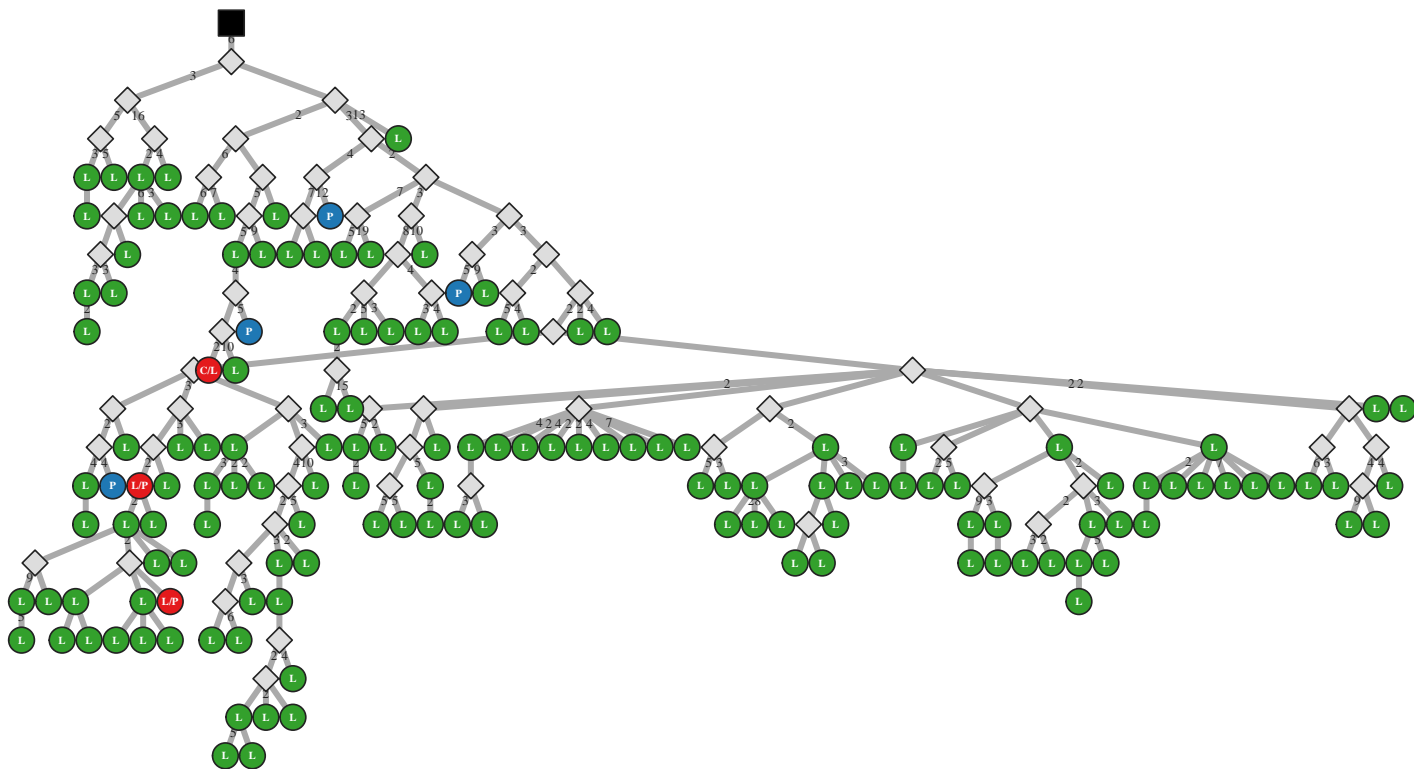

M5 IgG IGHV3-23/J6 57bp (16872)

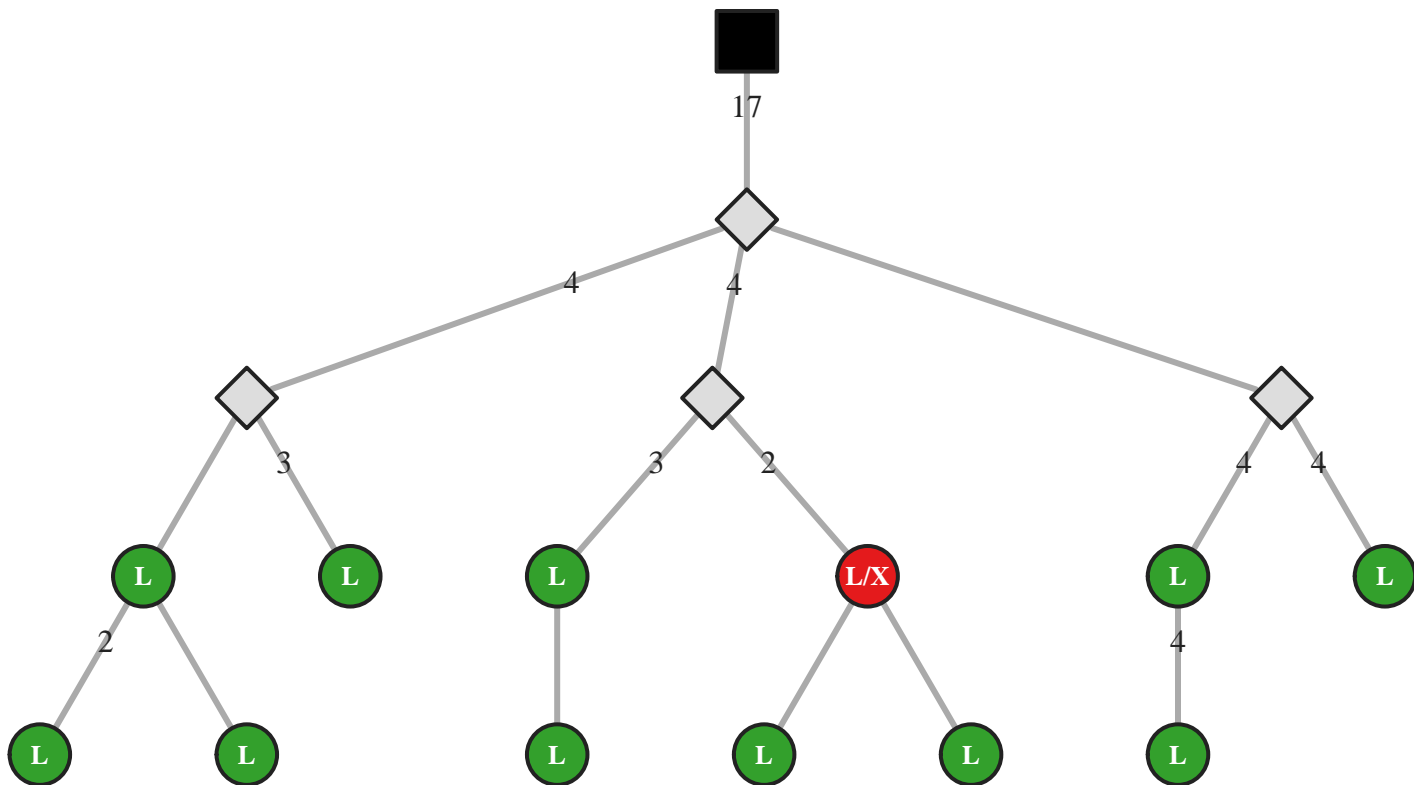

M5 IgA IGHV3-23/J6 60bp (38715)

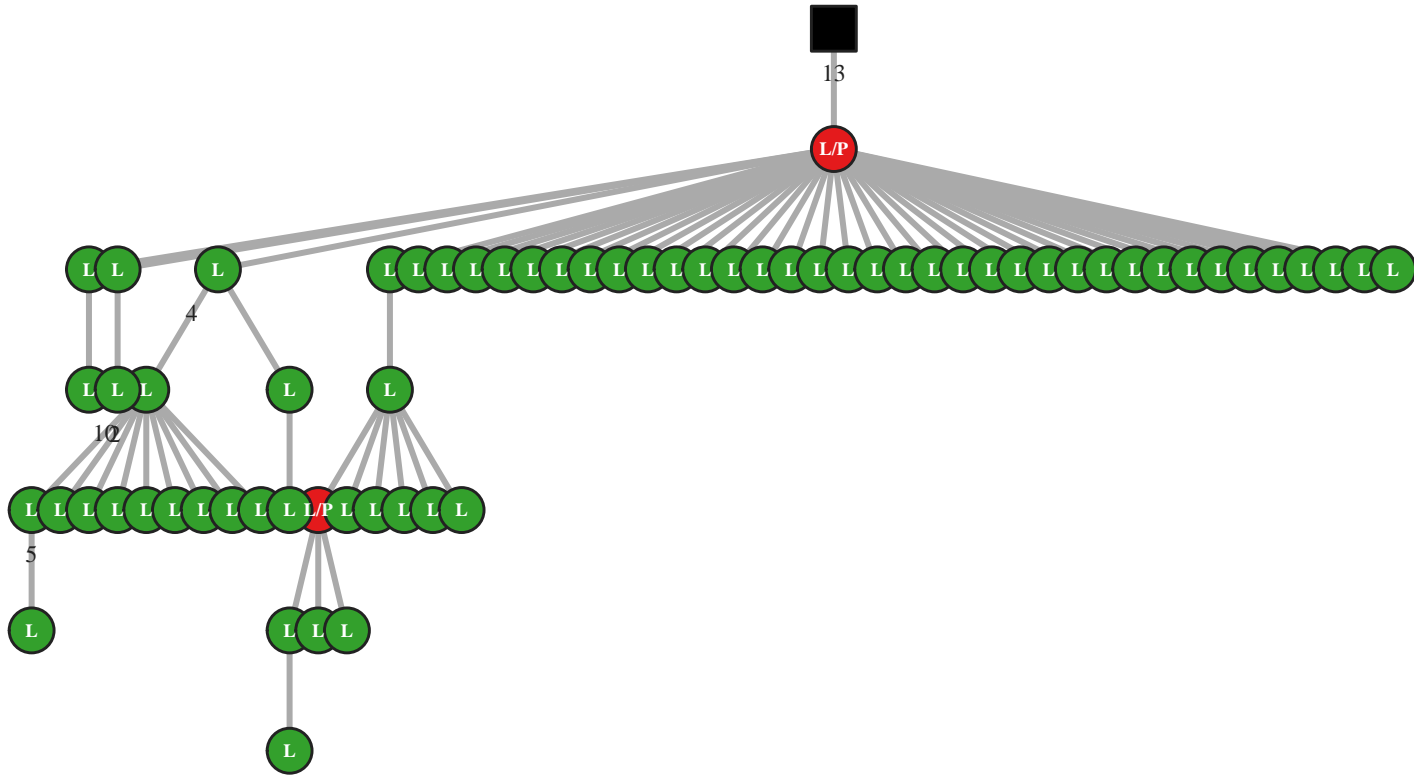

M5 IgG IGHV3-23/J6 60bp (43877)

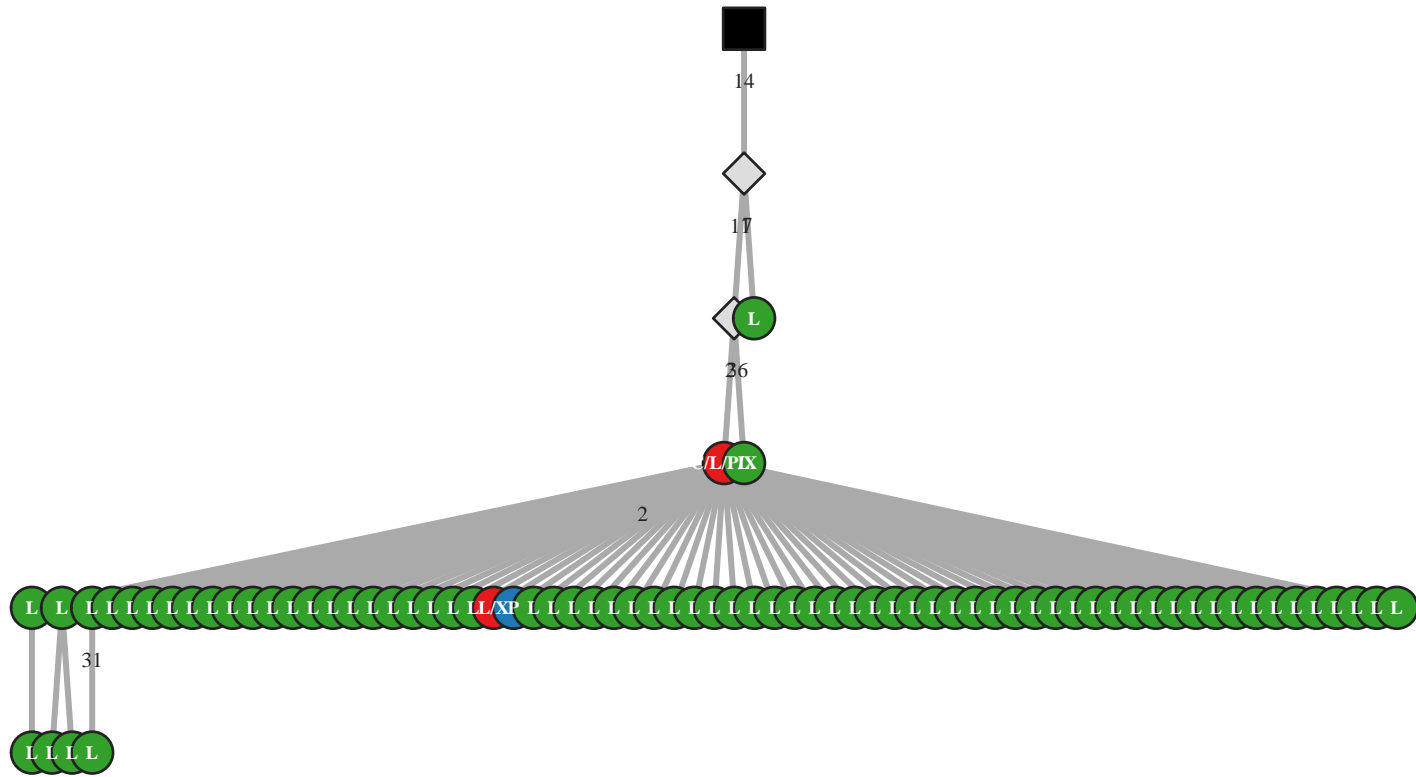

M5 IgA IGHV3-23/J6 69bp (12362)

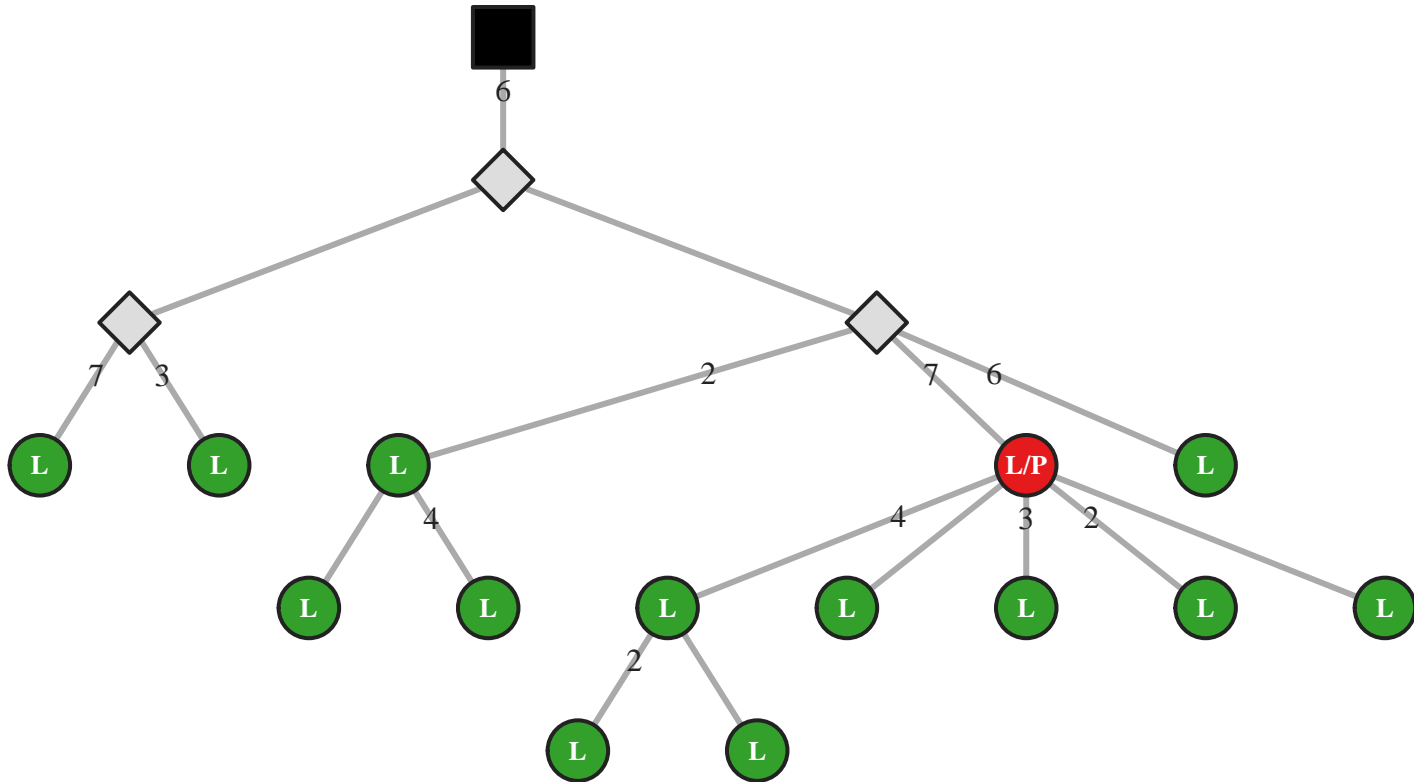

M5 IgA IGHV3-30/J1 36bp (21685)

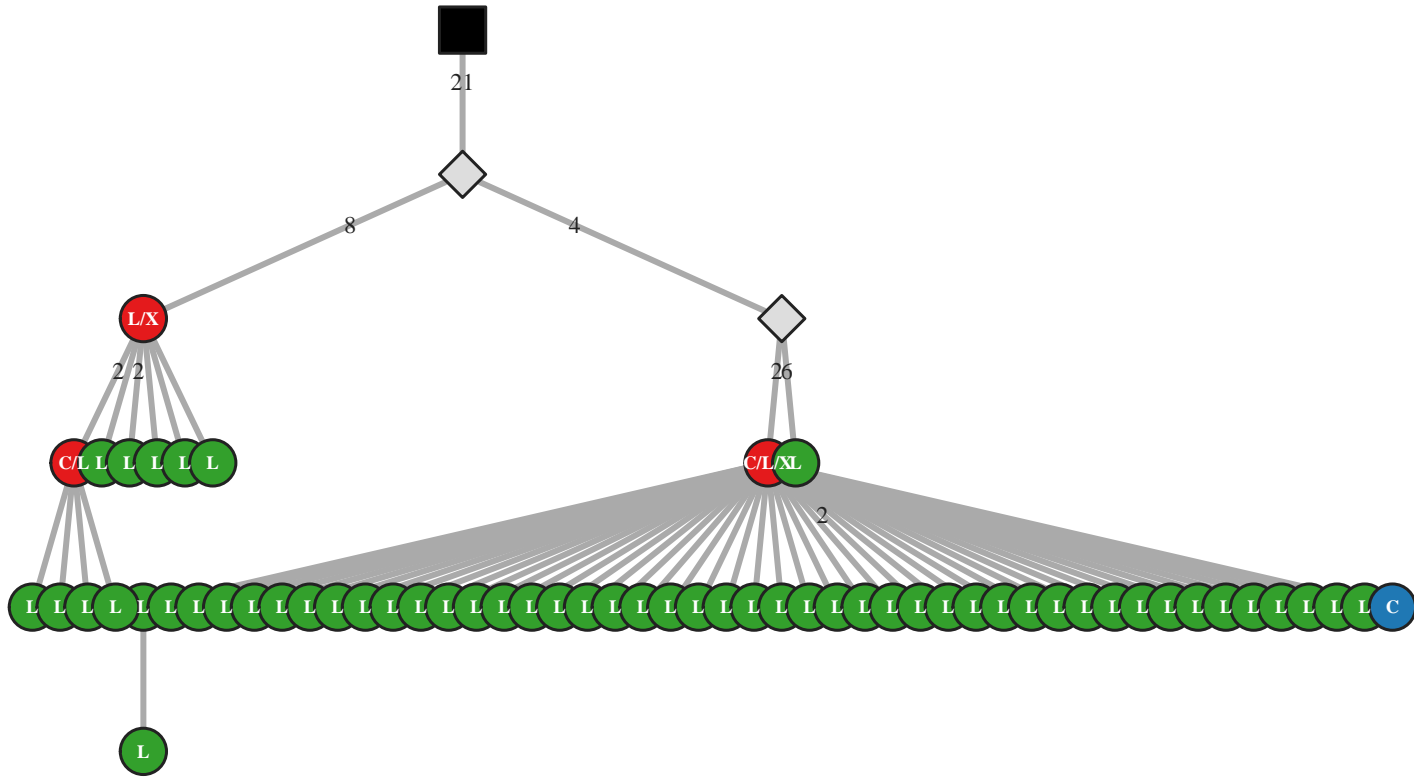

M5 IgG IGHV3-30/J1 48bp (35045)

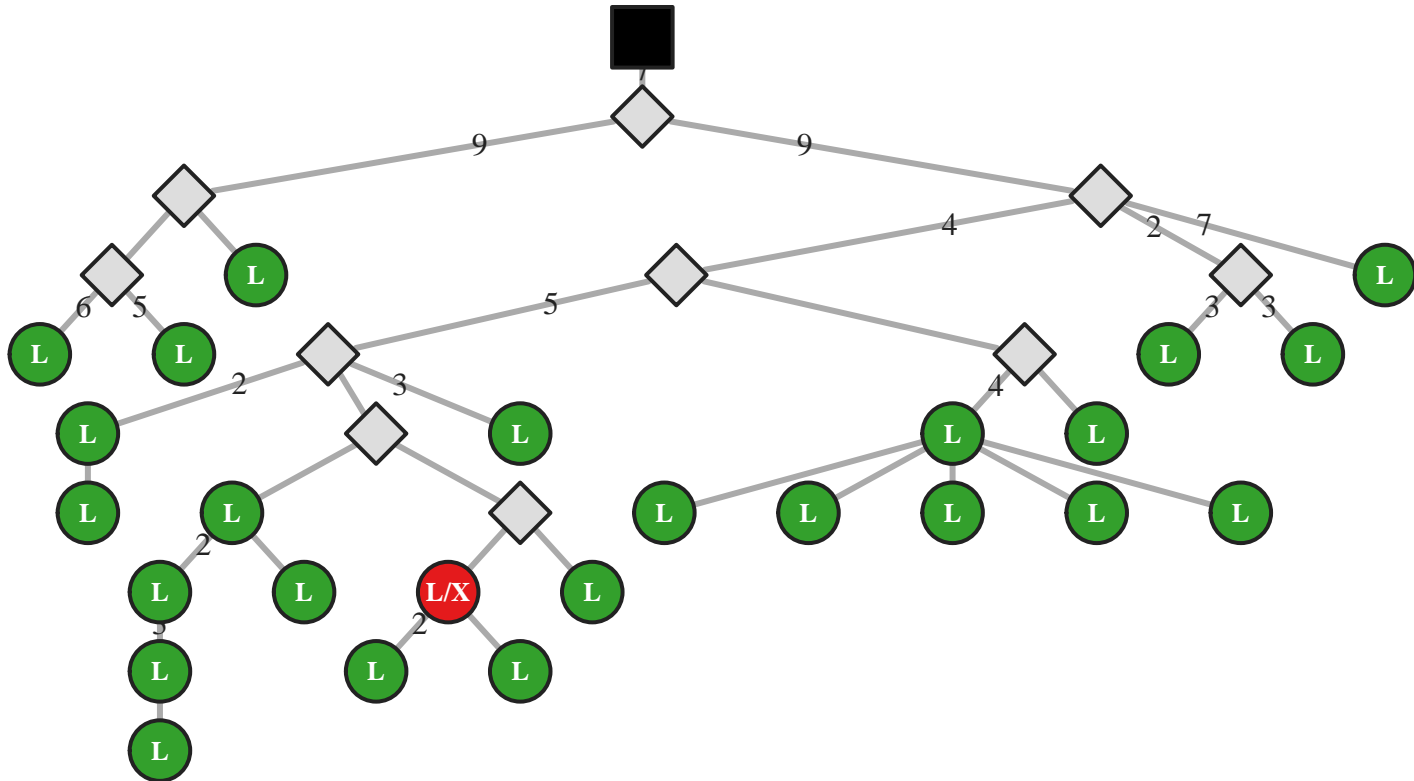

M5 IgG IGHV3-30/J2 54bp (35072)

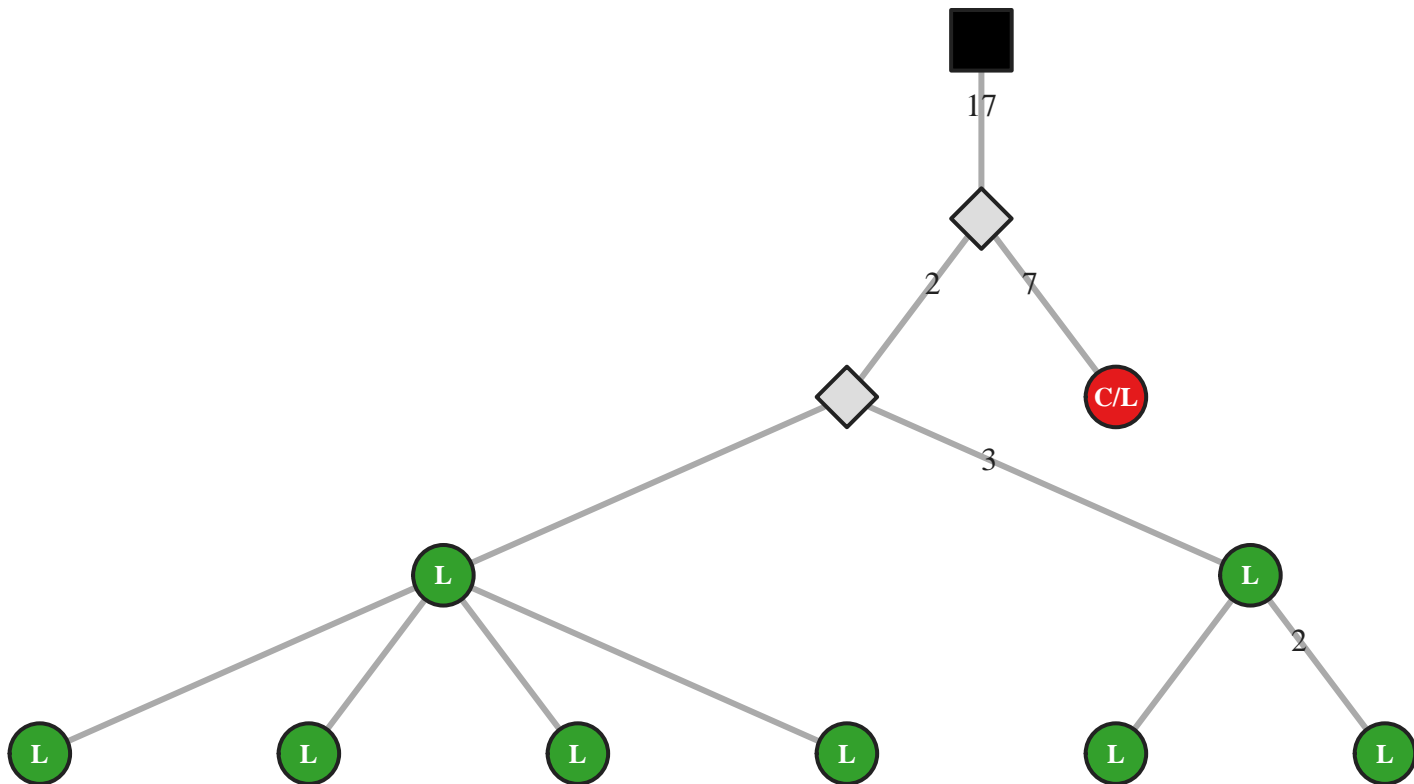

M5 IgG IGHV3-30/J3 39bp (34753)

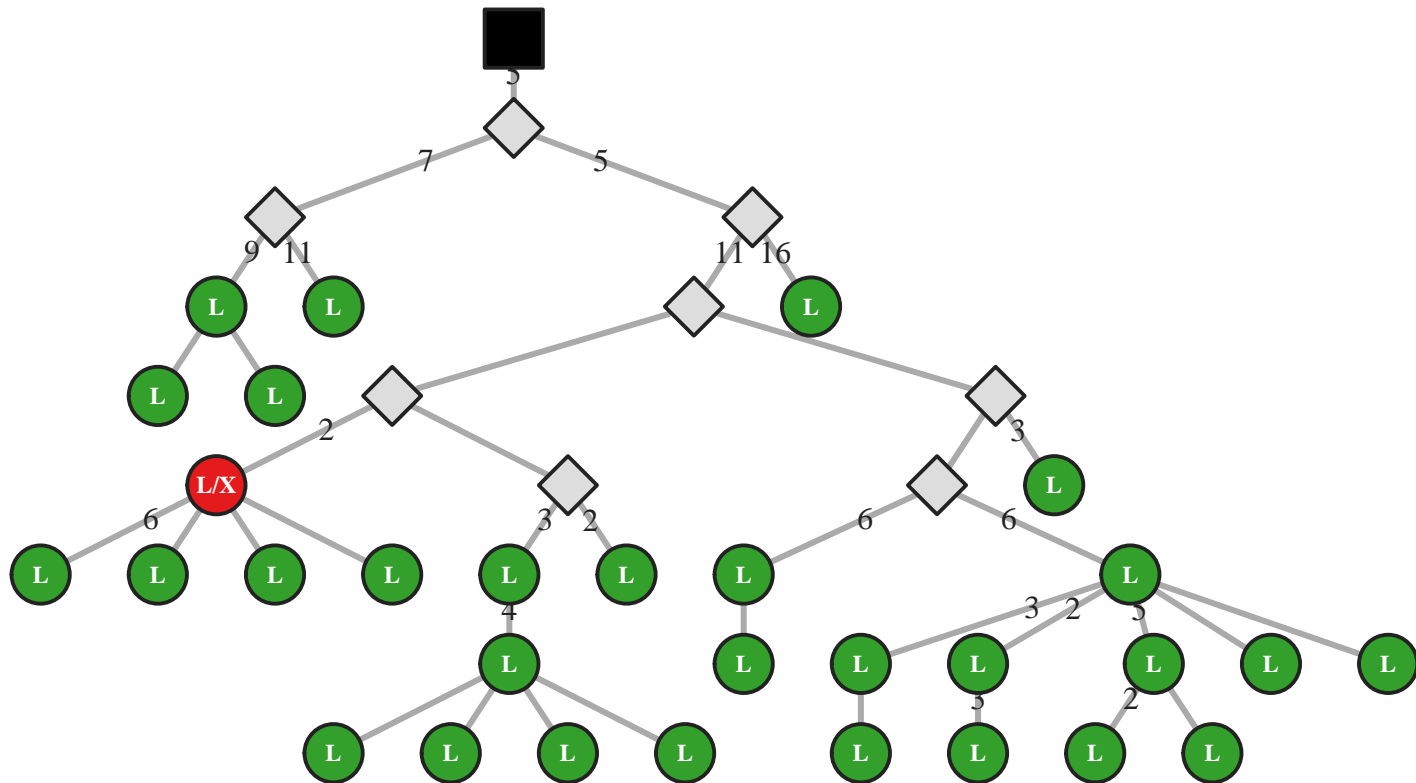

M5 IgG IGHV3-30/J3 45bp (51882)

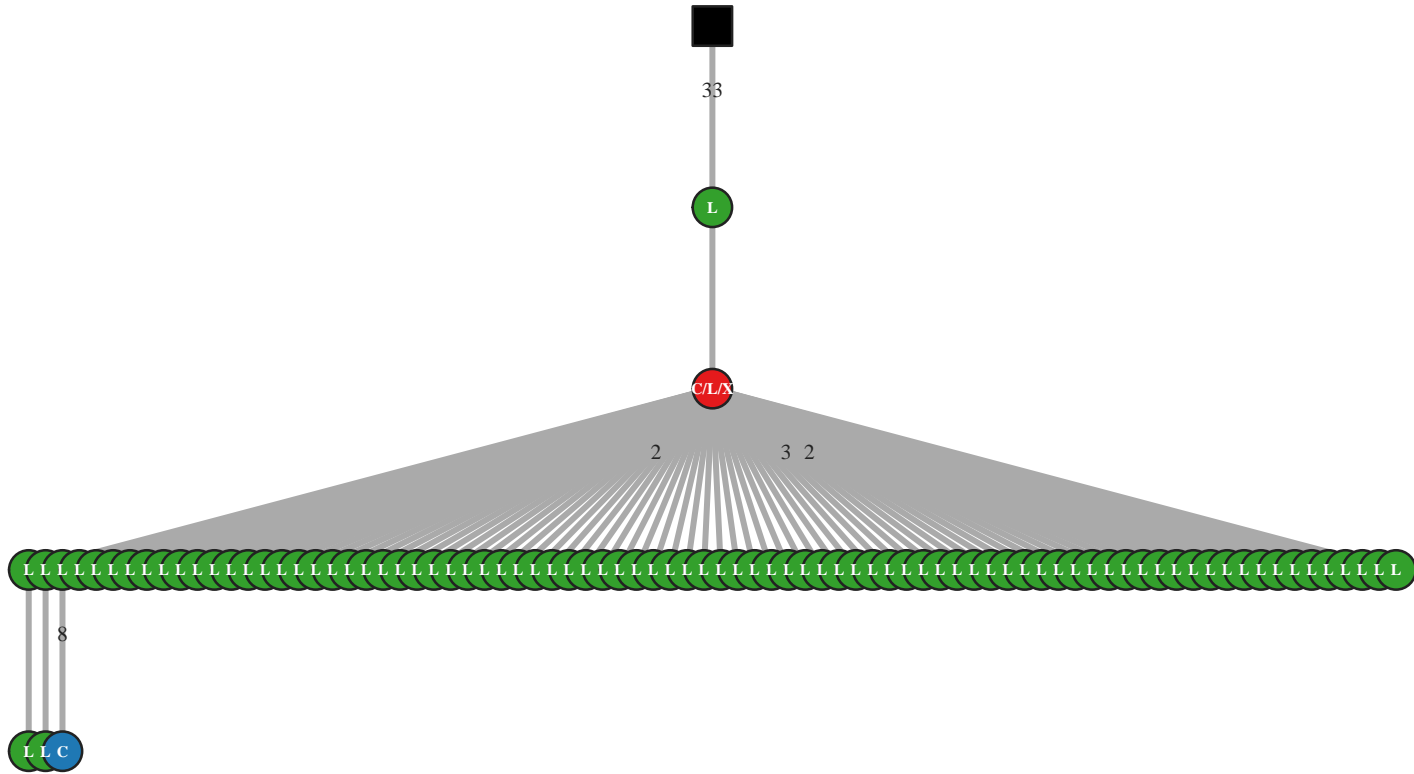

M5 IgG IGHV3-30/J3 48bp (7103)

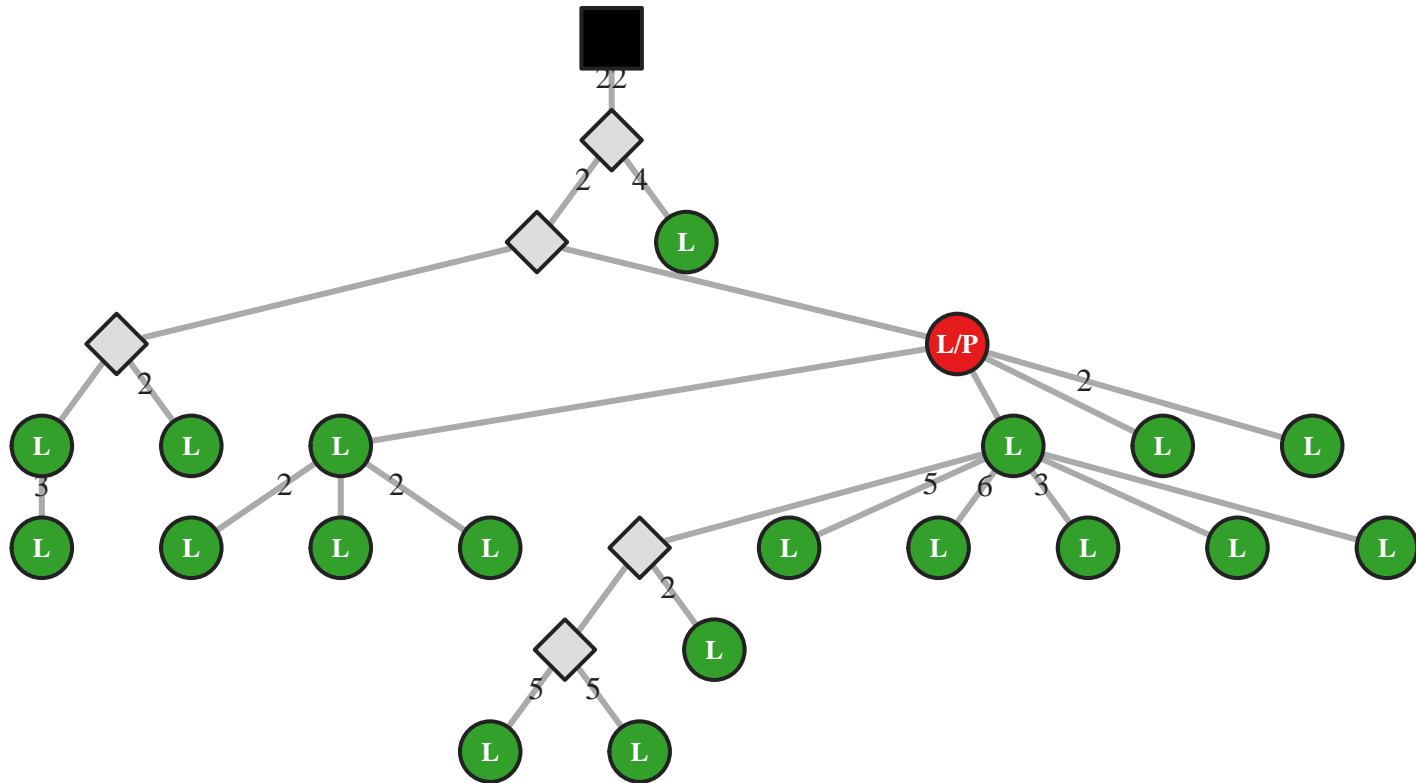

M5 IgG IGHV3-30/J3 51bp (34766)

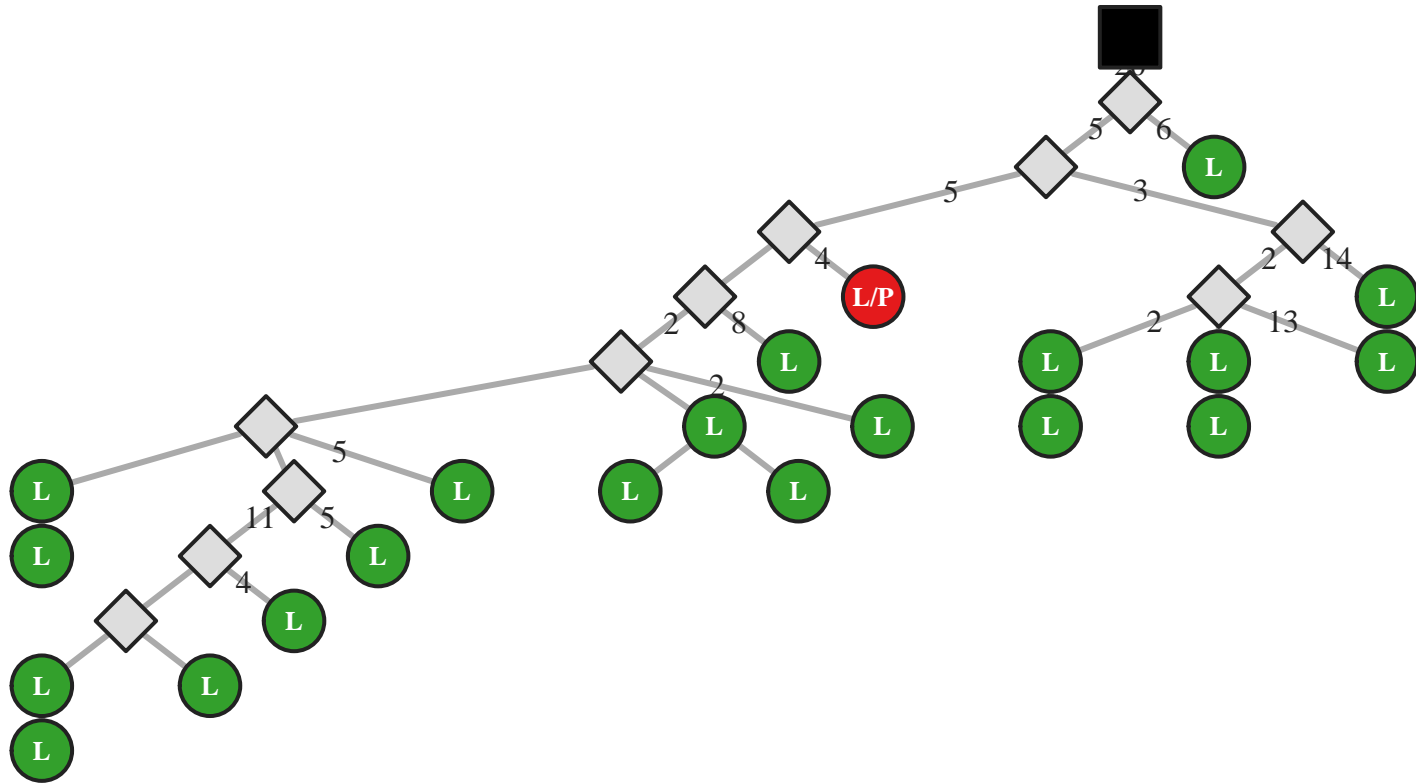

M5 IgG IGHV3-30/J3 51bp (34767)

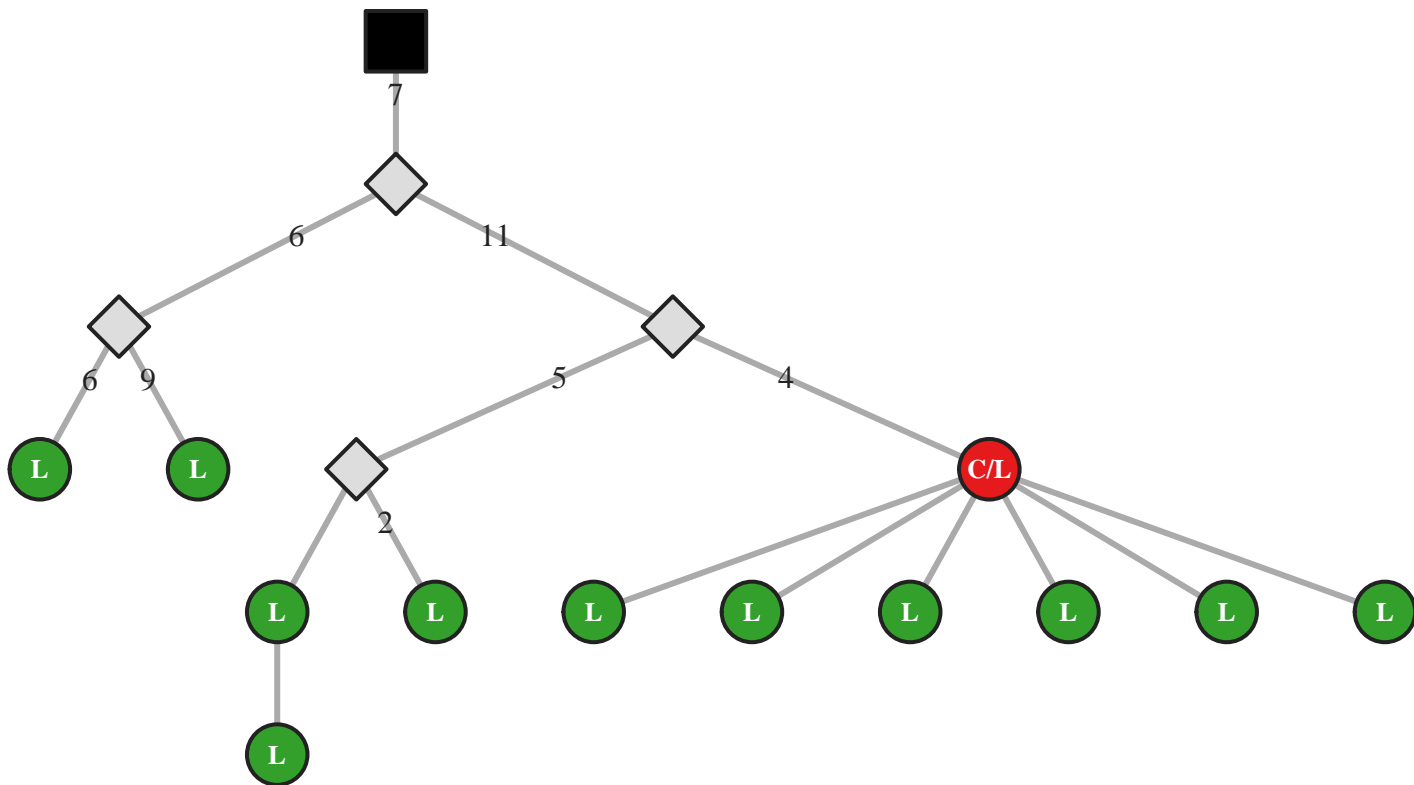

M5 IgG IGHV3-30/J3 51bp (34768)

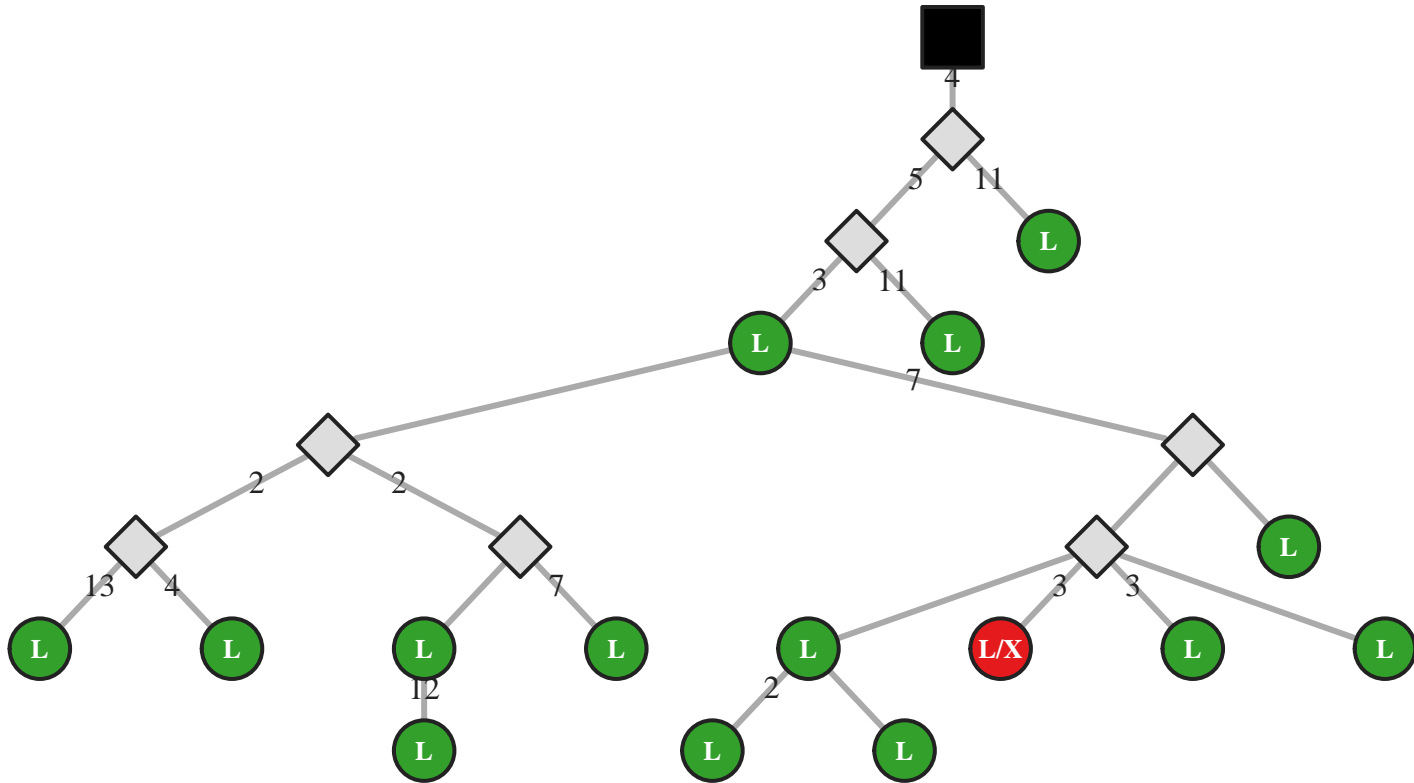

M5 IgG IGHV3-30/J3 51bp (34773)

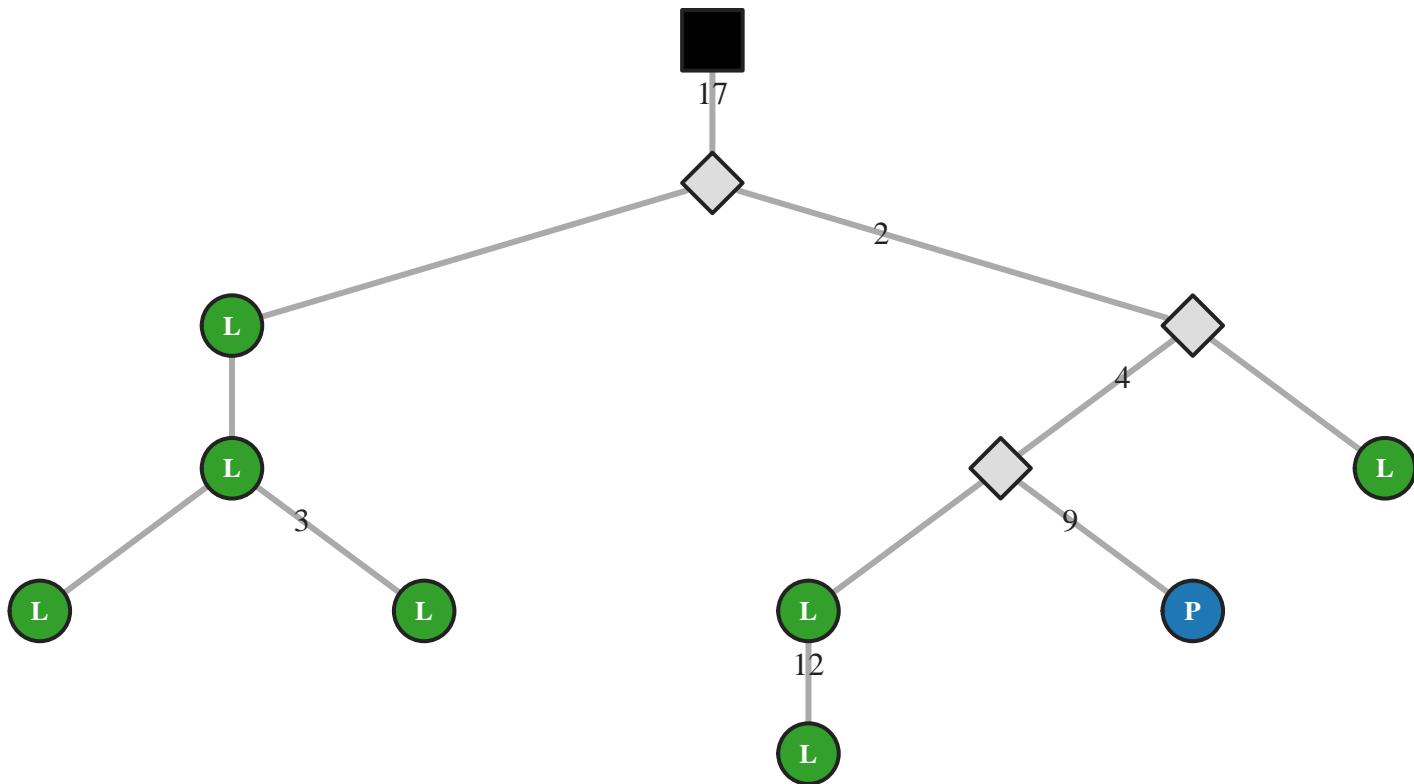

M5 IgG IGHV3-30/J3 51bp (34815)

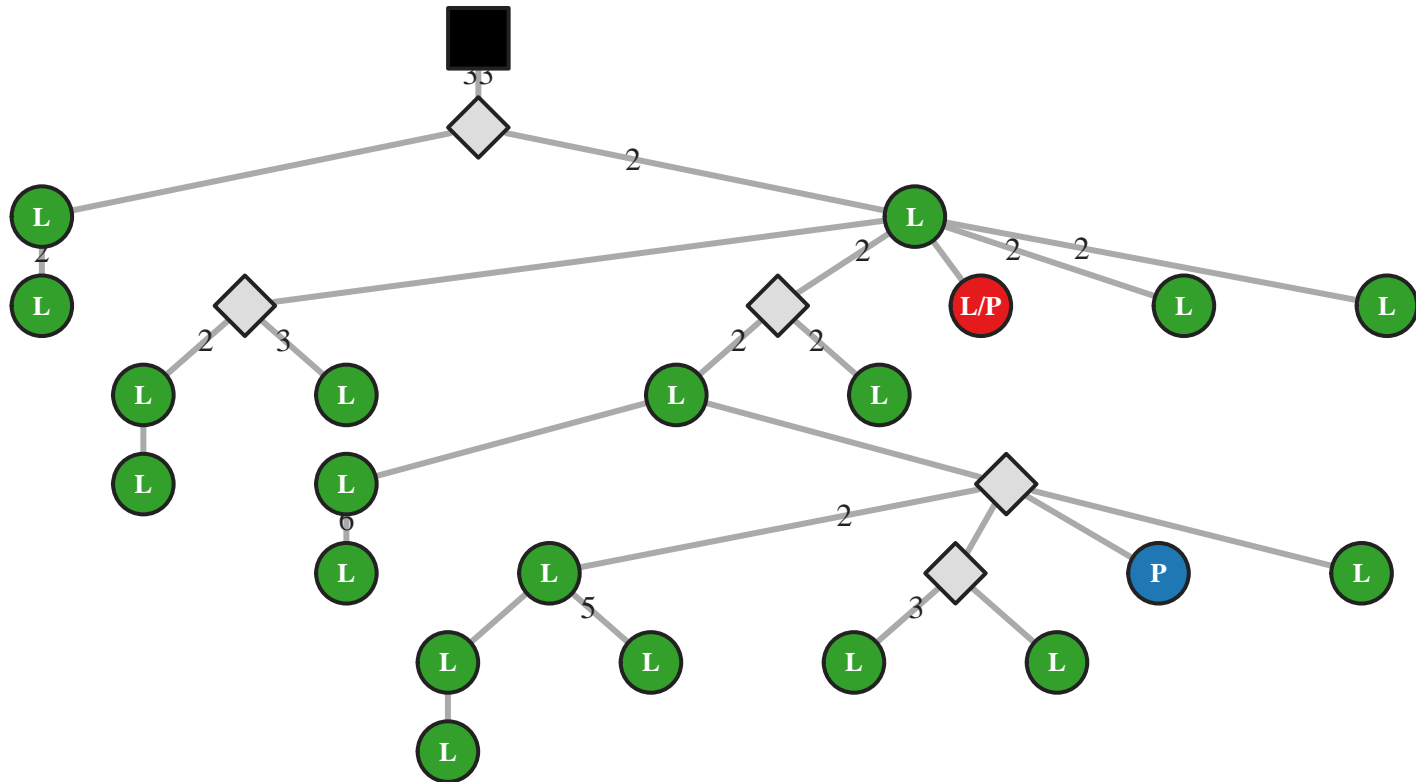

M5 IgG IGHV3-30/J3 54bp (26427)

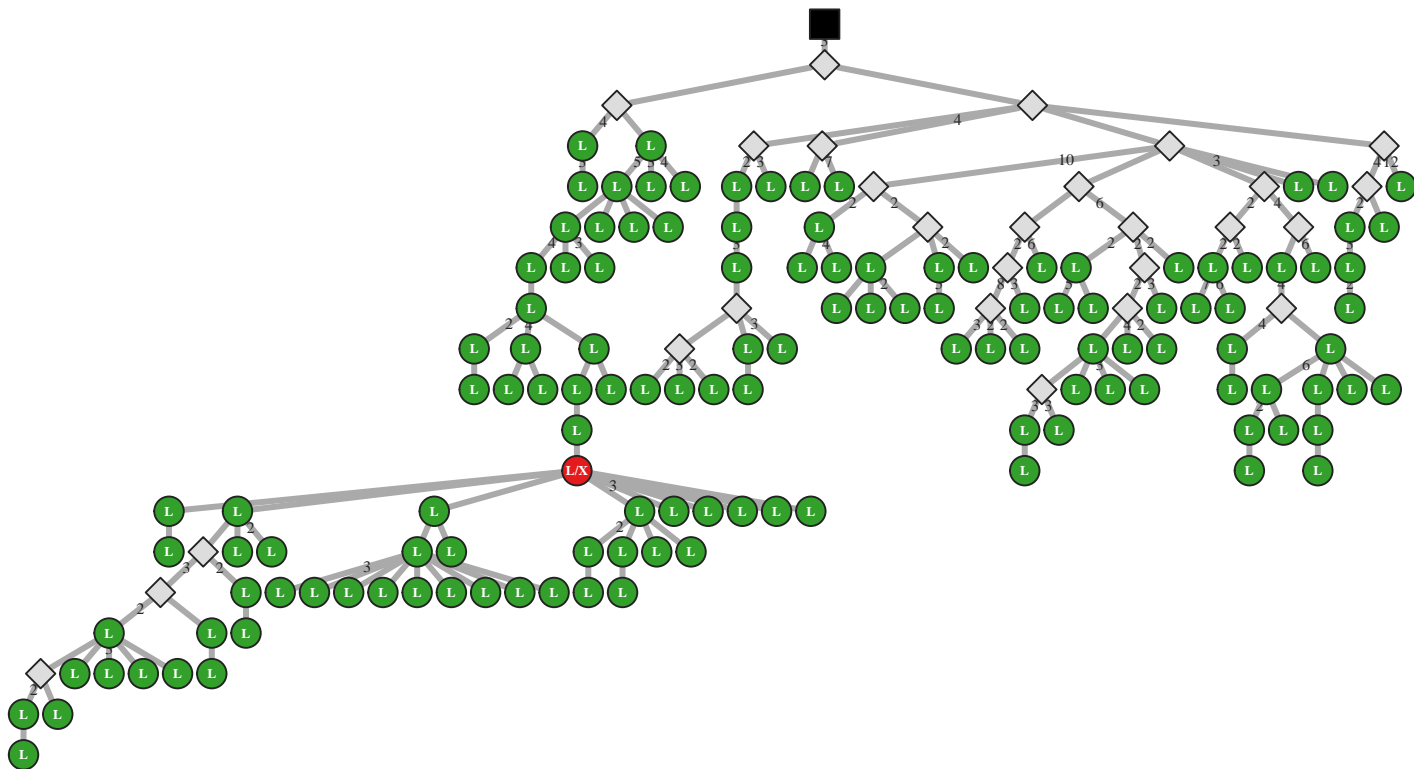

M5 IgG IGHV3-30/J3 57bp (26445)

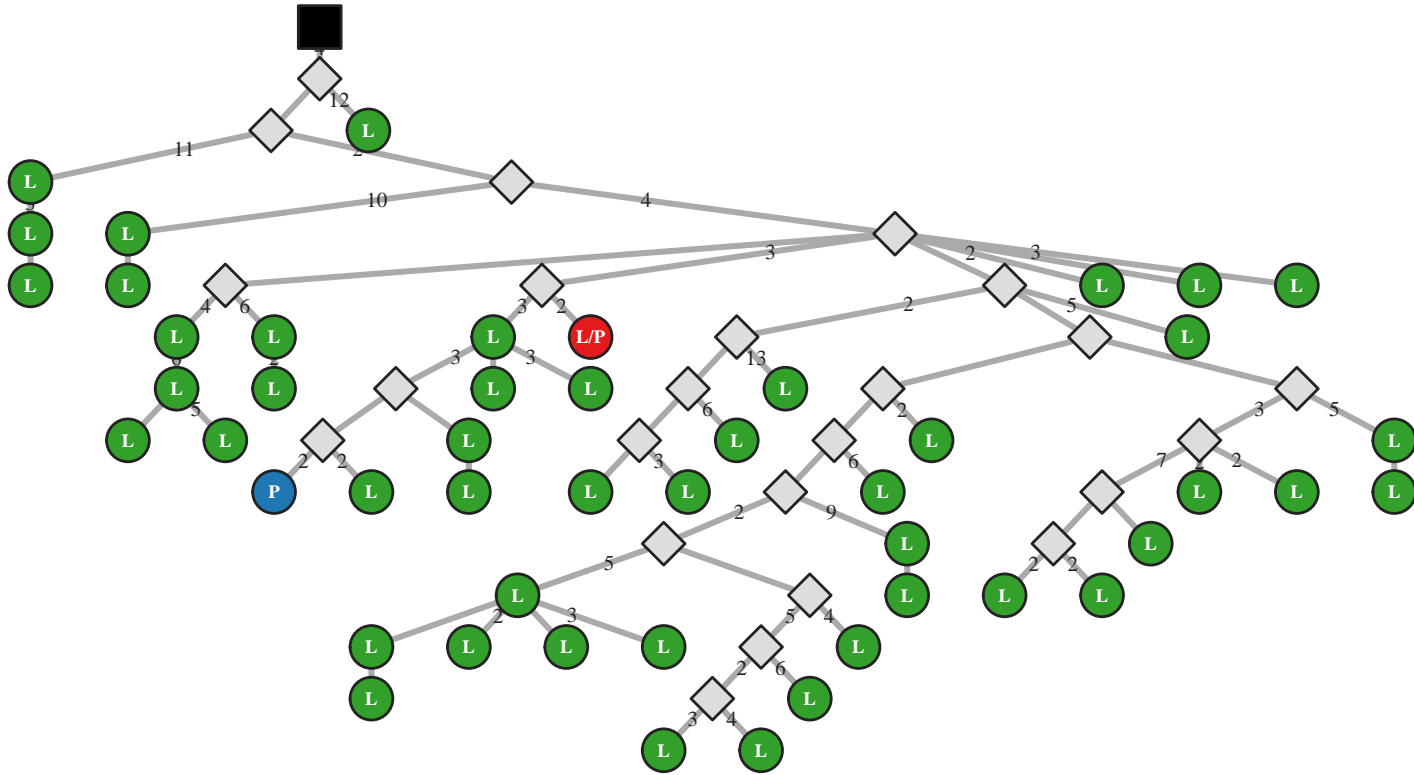

M5 IgG IGHV3-30/J3 63bp (8013)

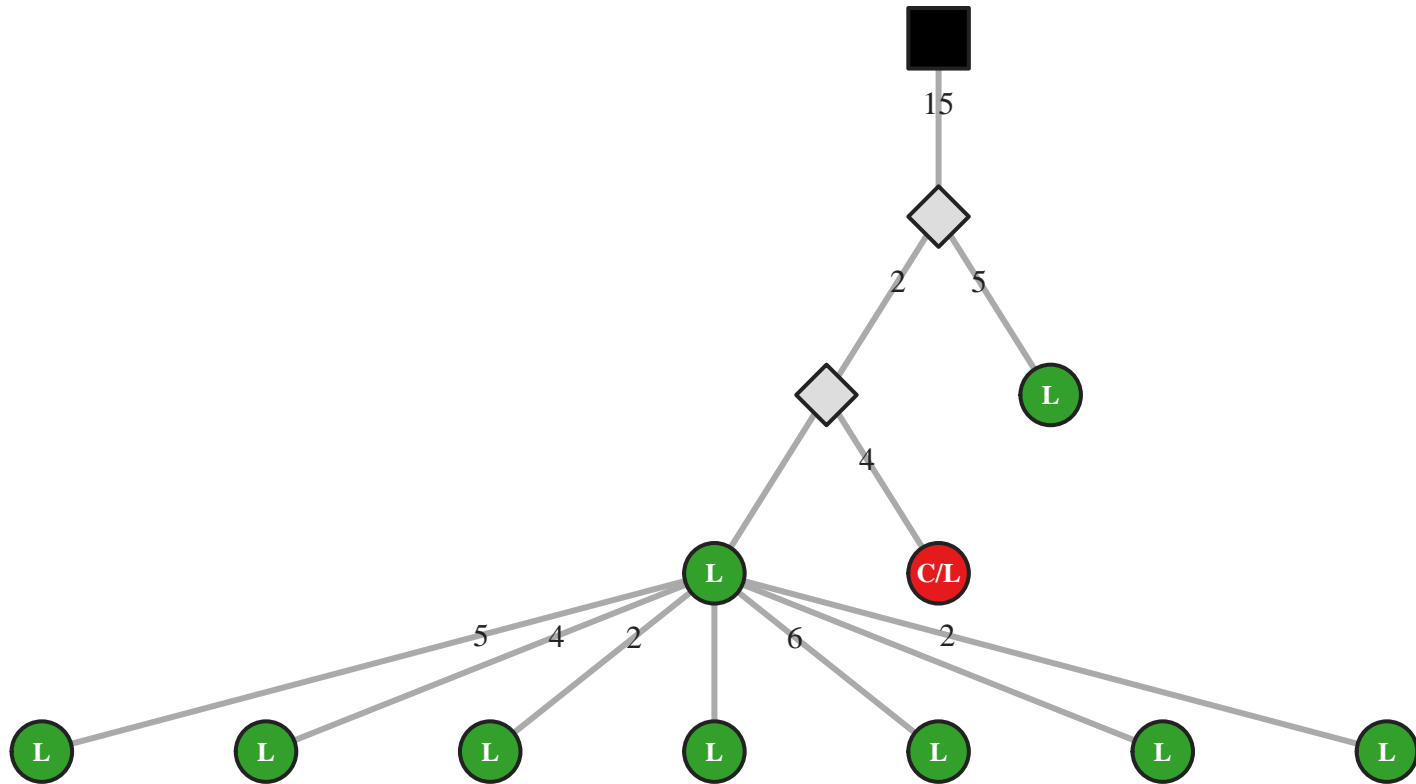

M5 IgG IGHV3-30/J3 72bp (51888)

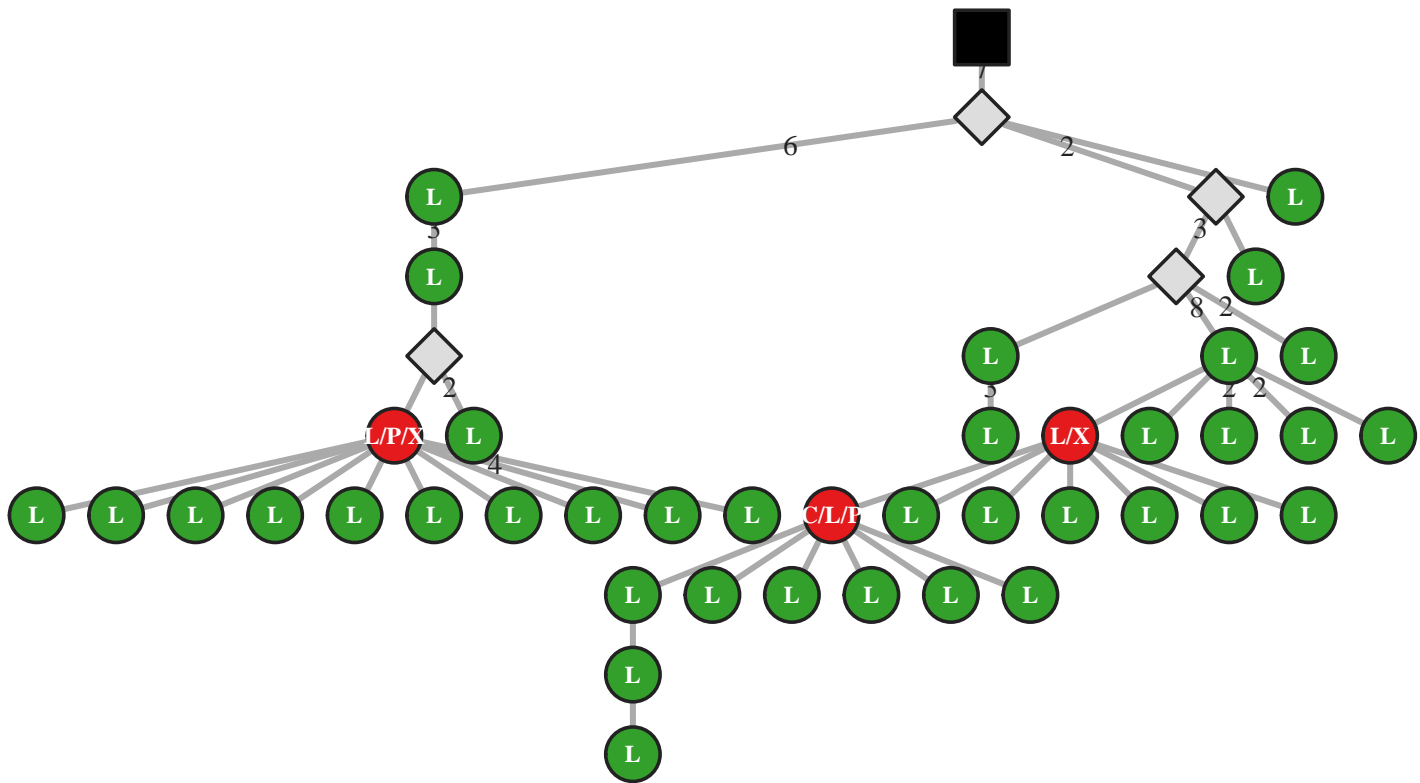

M5 IgG IGHV3-30/J4 27bp (26474)

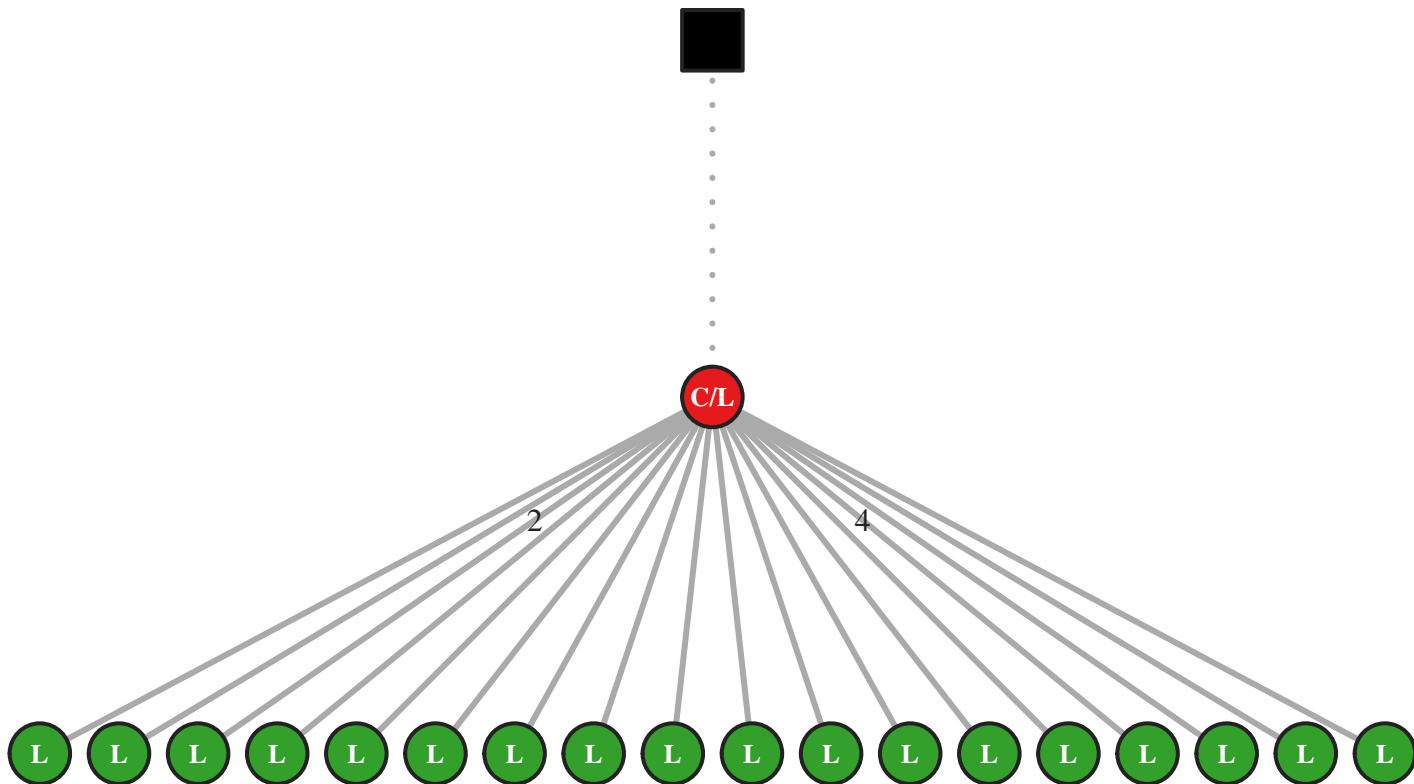

M5 IgG IGHV3-30/J4 33bp (7762)

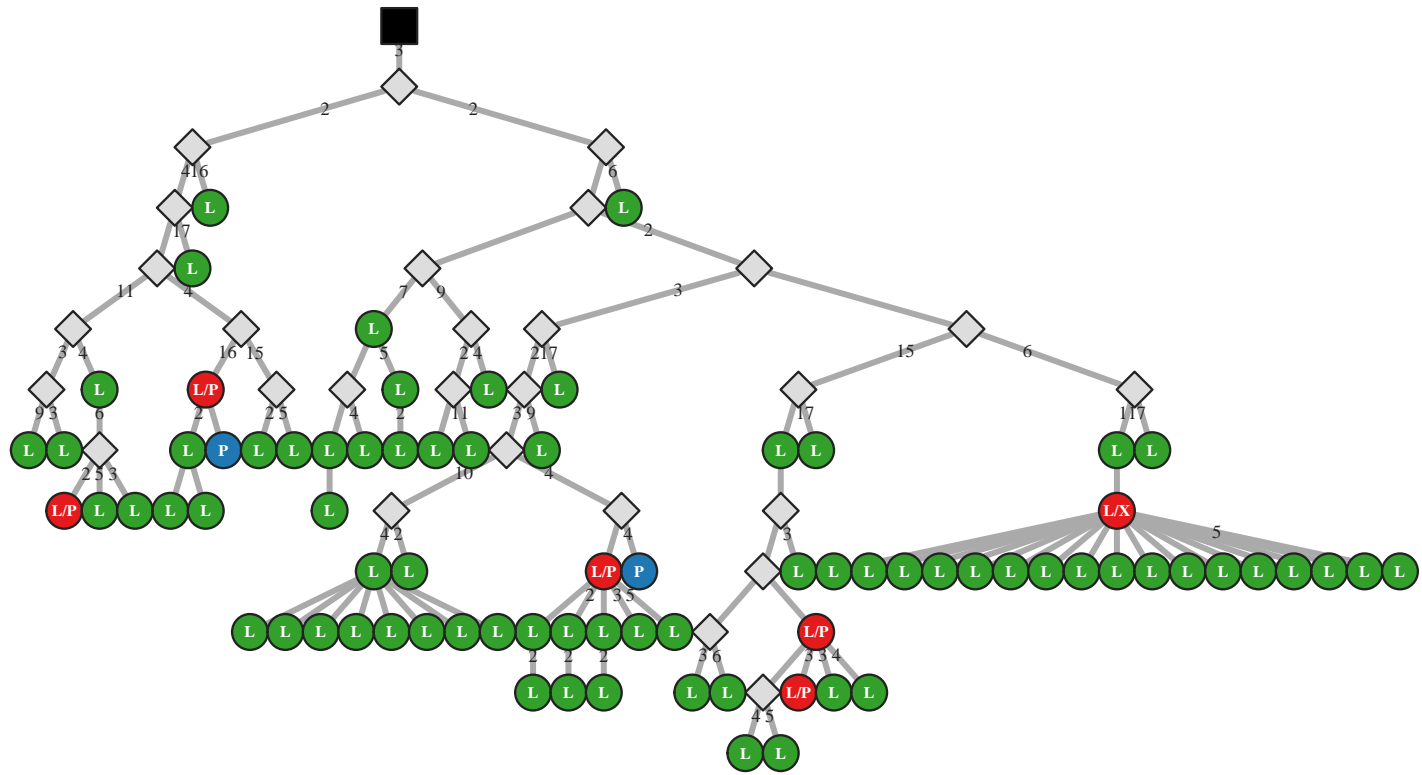

M5 IgG IGHV3-30/J4 36bp (34367)

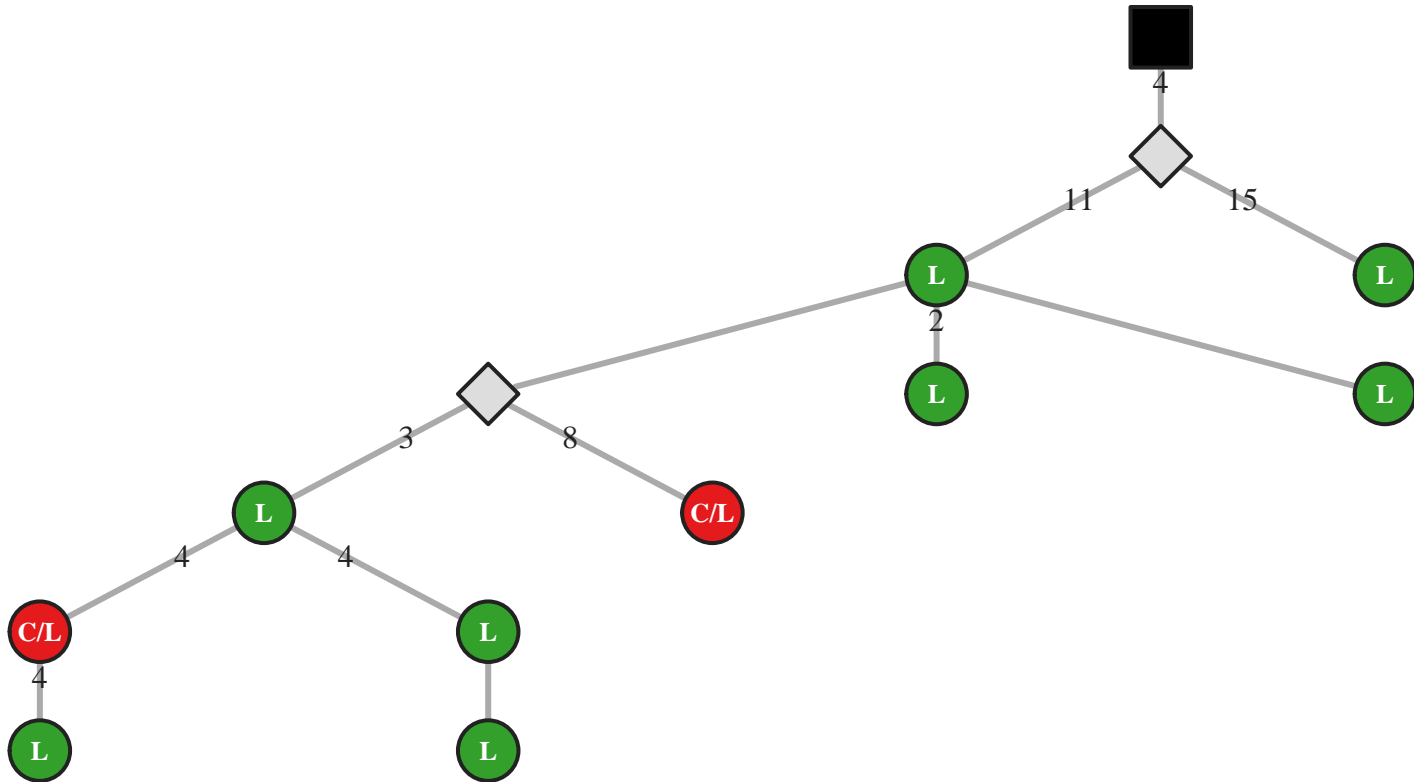

M5 IgM IGHV3-30/J4 36bp (11401)

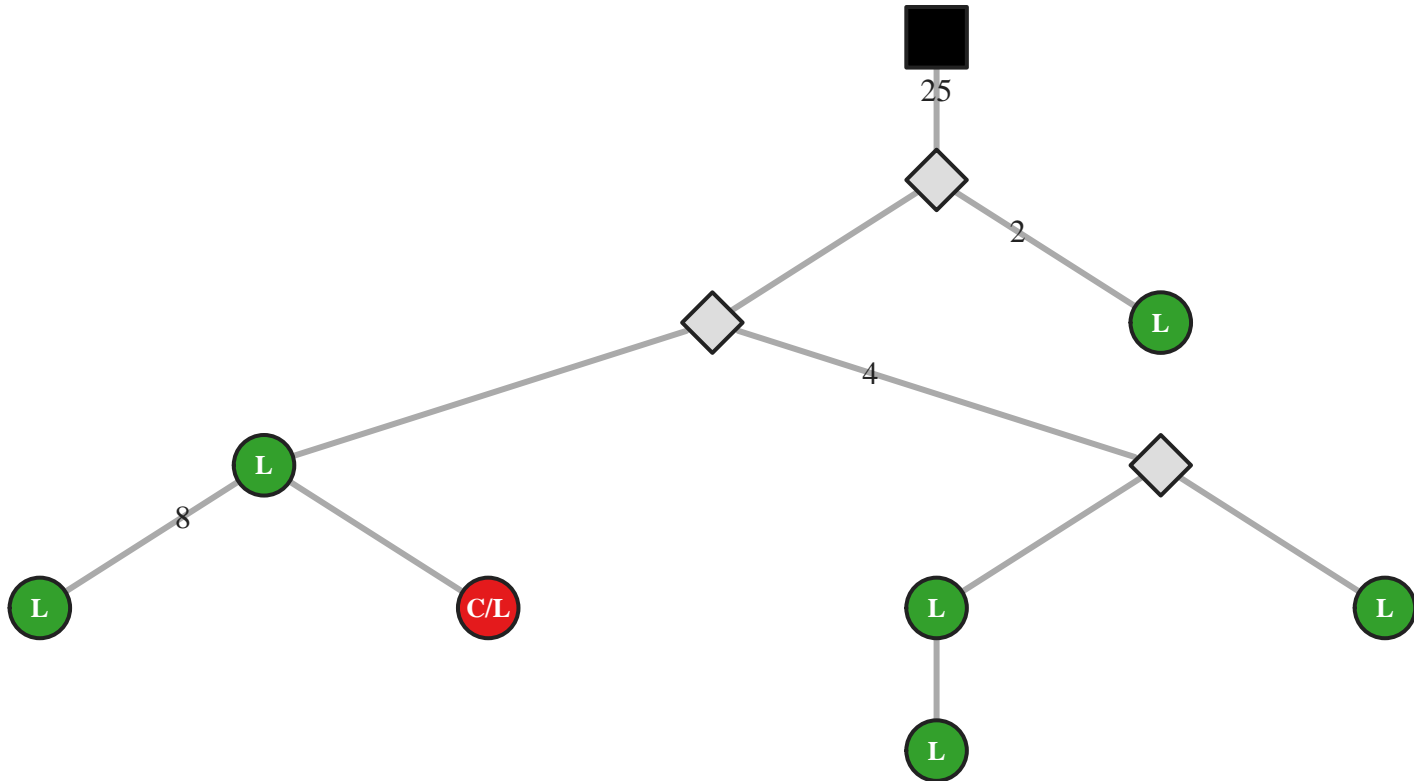

M5 IgG IGHV3-30/J4 39bp (7198)

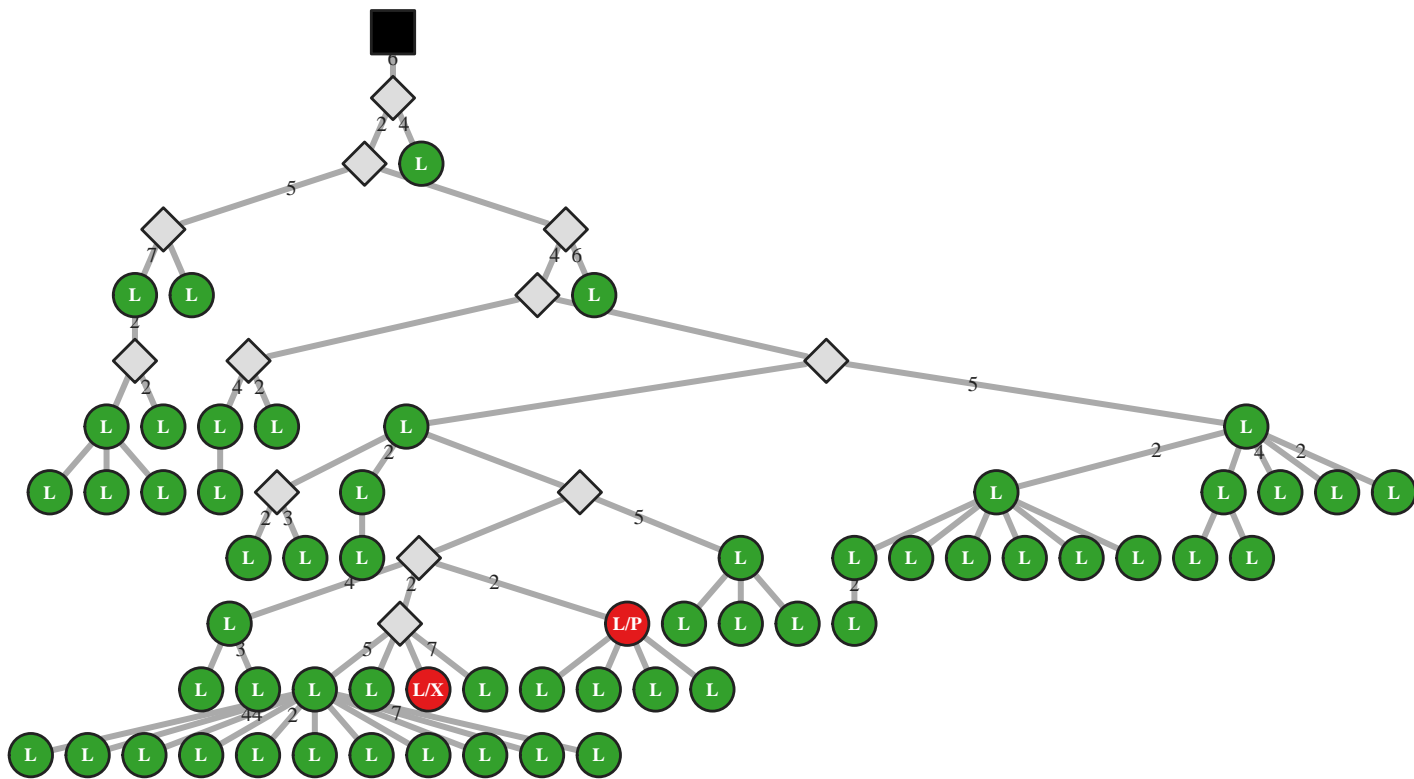

M5 IgG IGHV3-30/J4 39bp (7203)

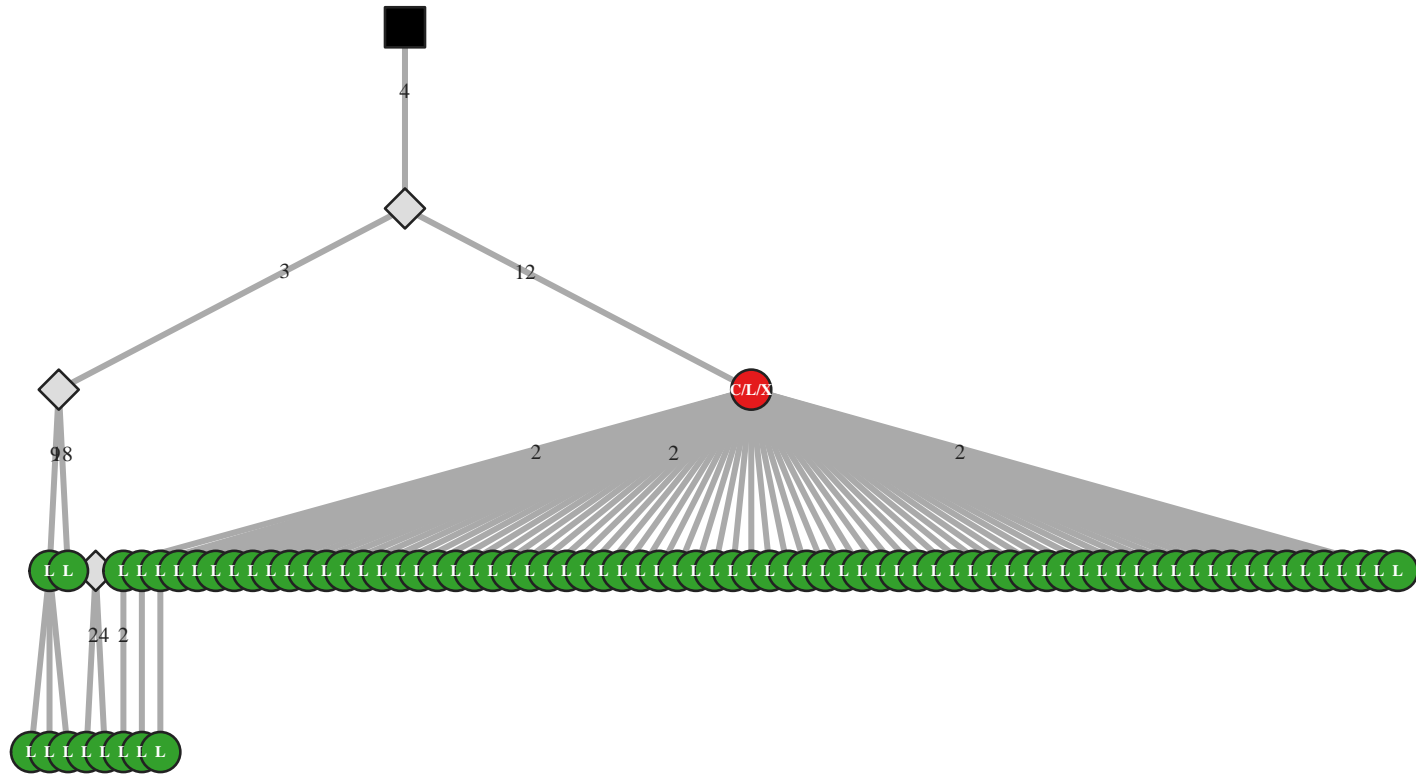

M5 IgG IGHV3-30/J4 39bp (7210)

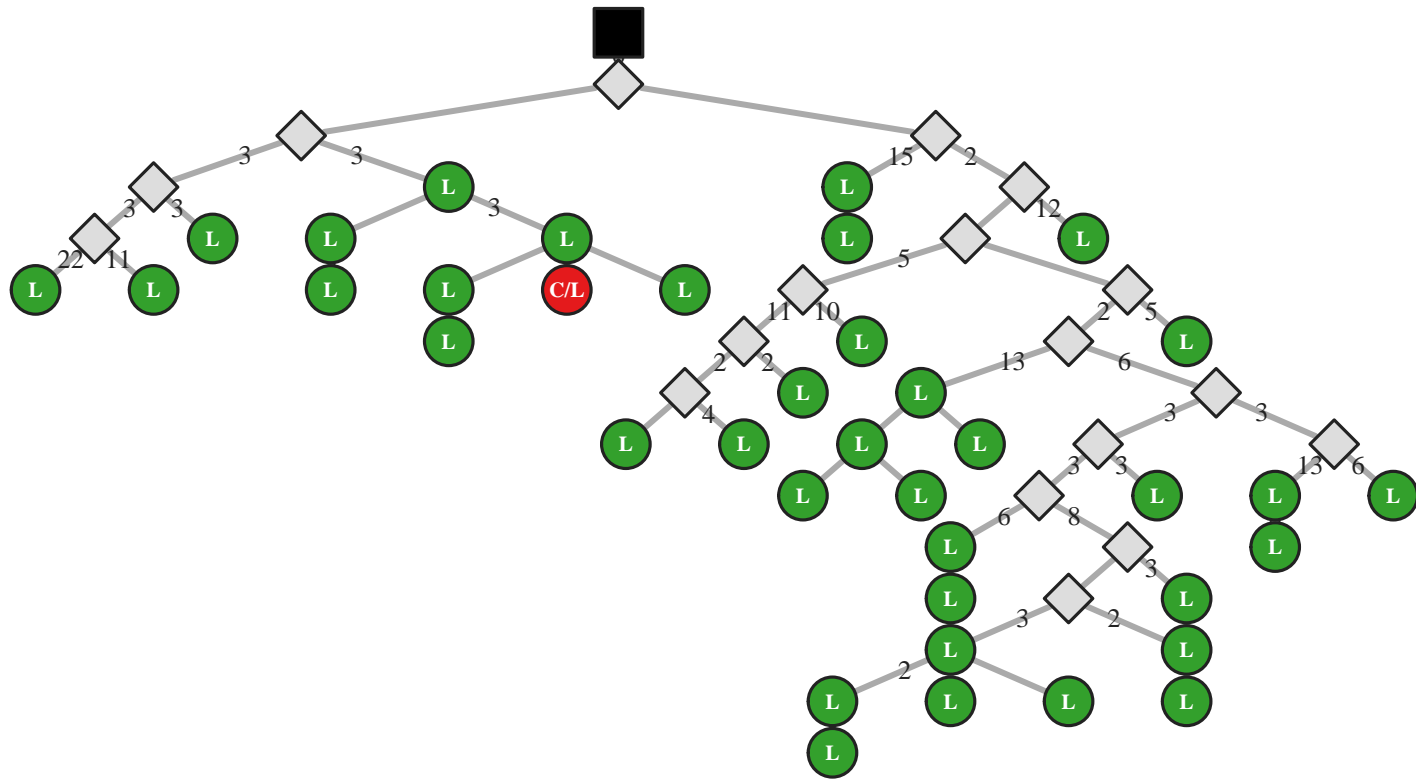

M5 IgG IGHV3-30/J4 42bp (43923)

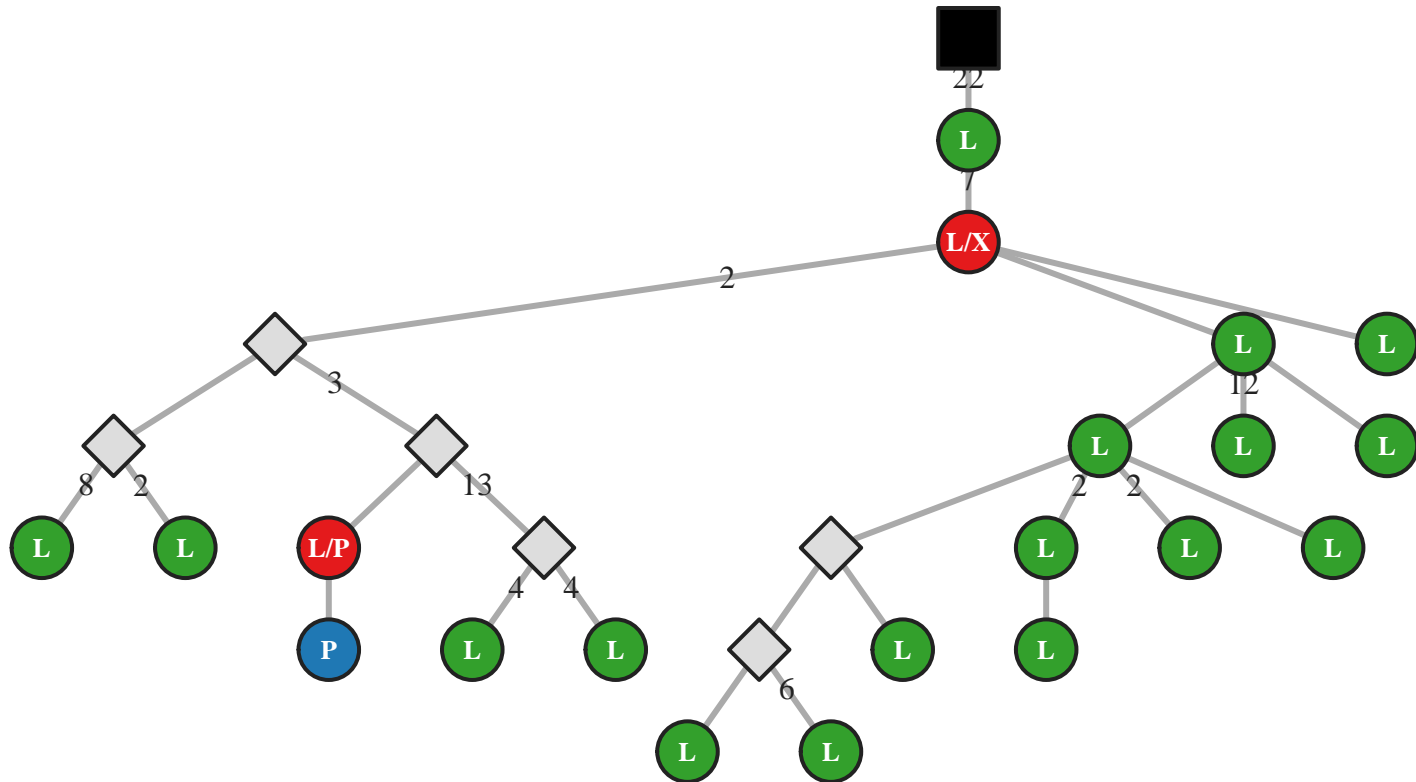

M5 IgG IGHV3-30/J4 42bp (44038)

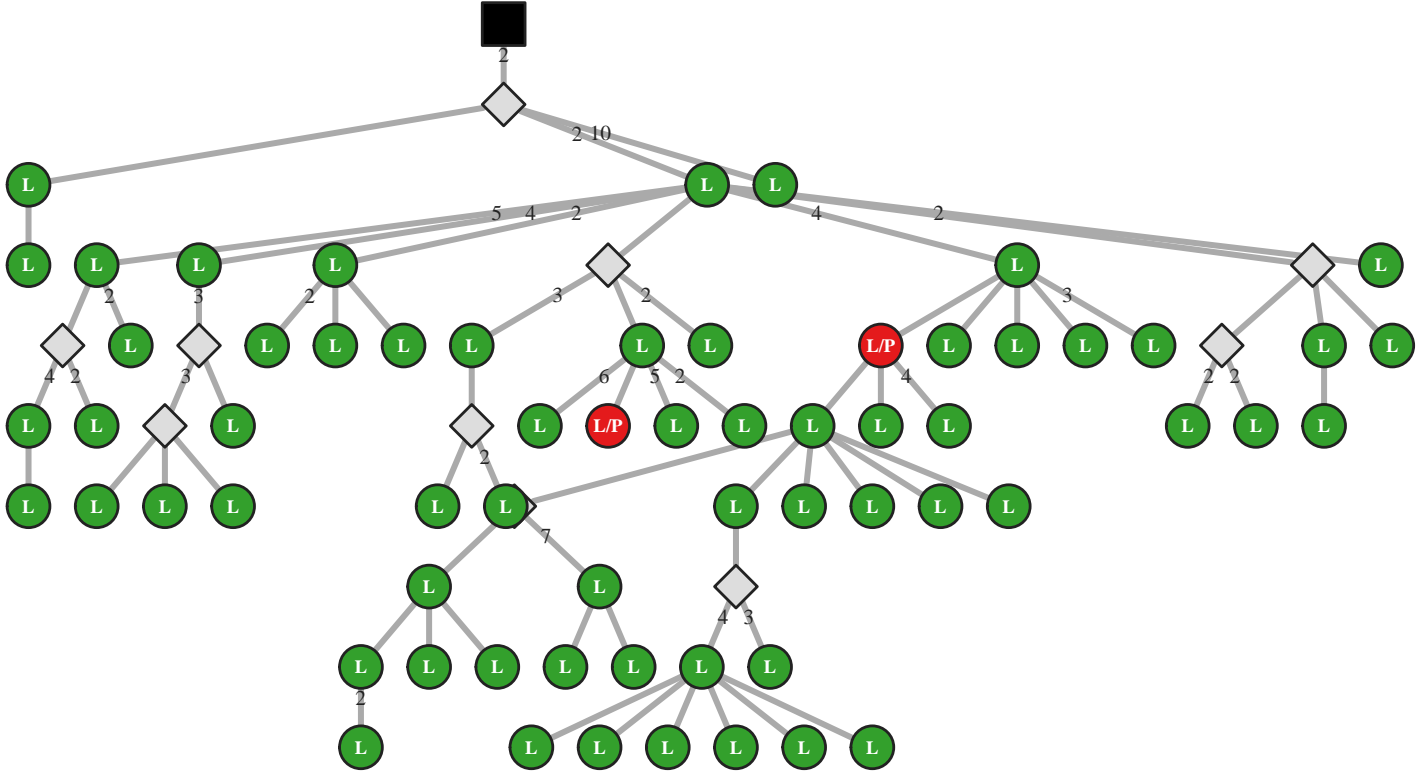

M5 IgG IGHV3-30/J4 42bp (44075)

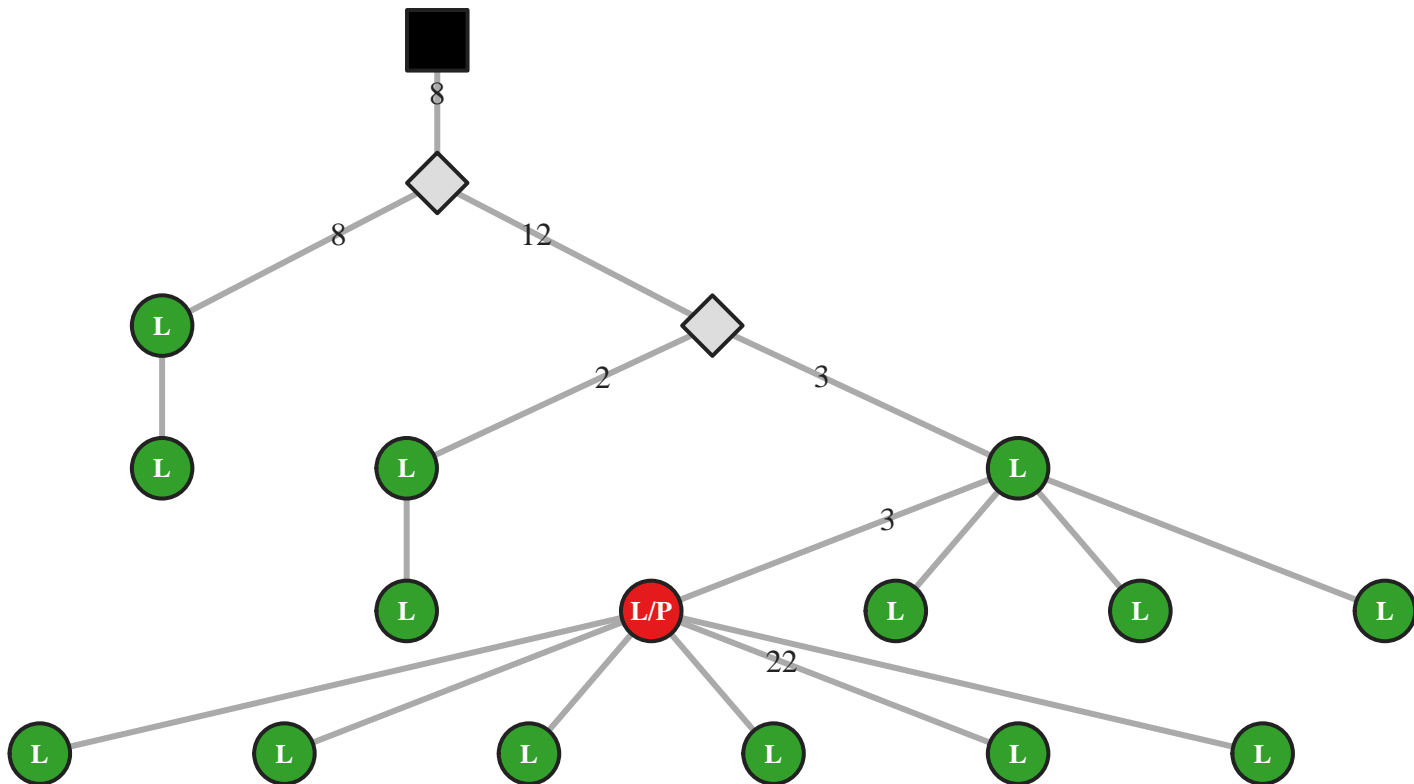

M5 IgG IGHV3-30/J4 42bp (44105)

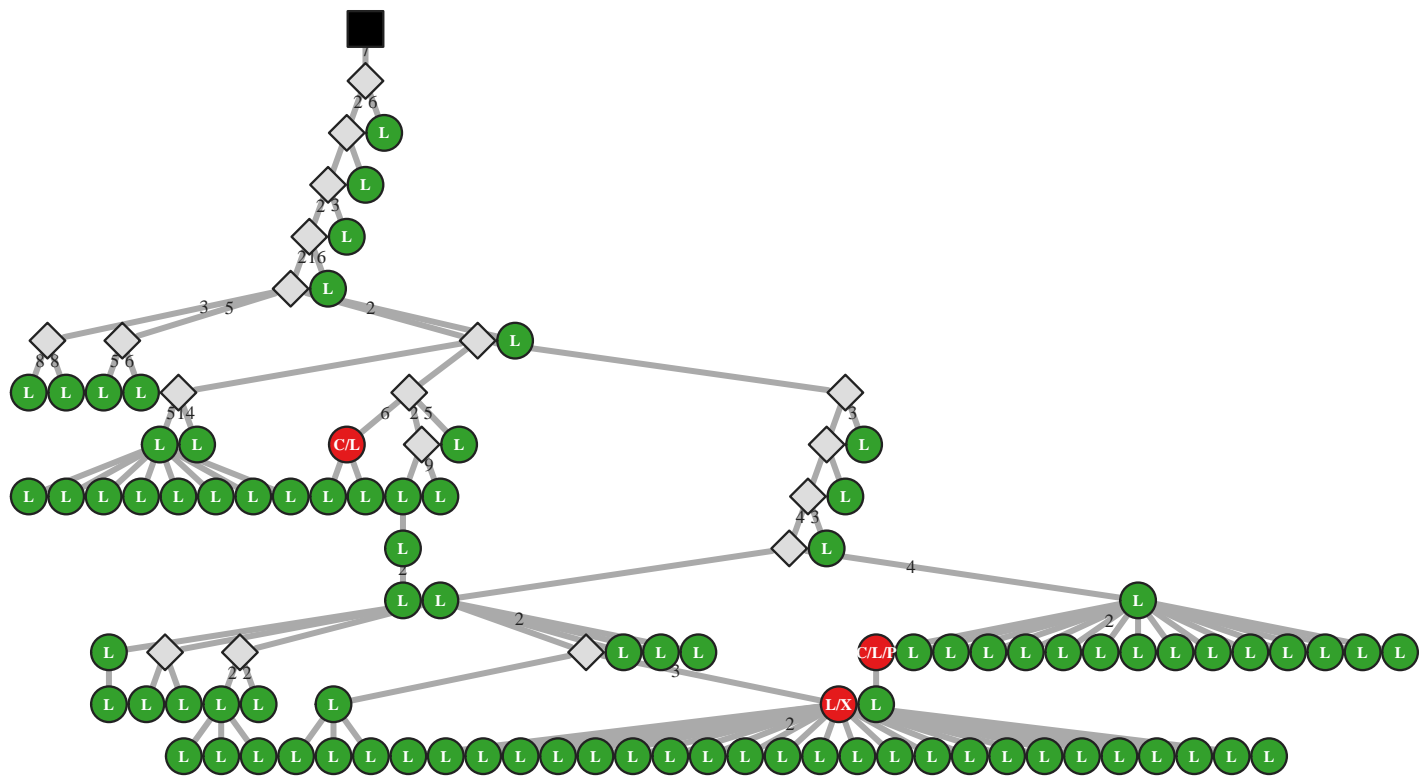

M5 IgG IGHV3-30/J4 42bp (44112)

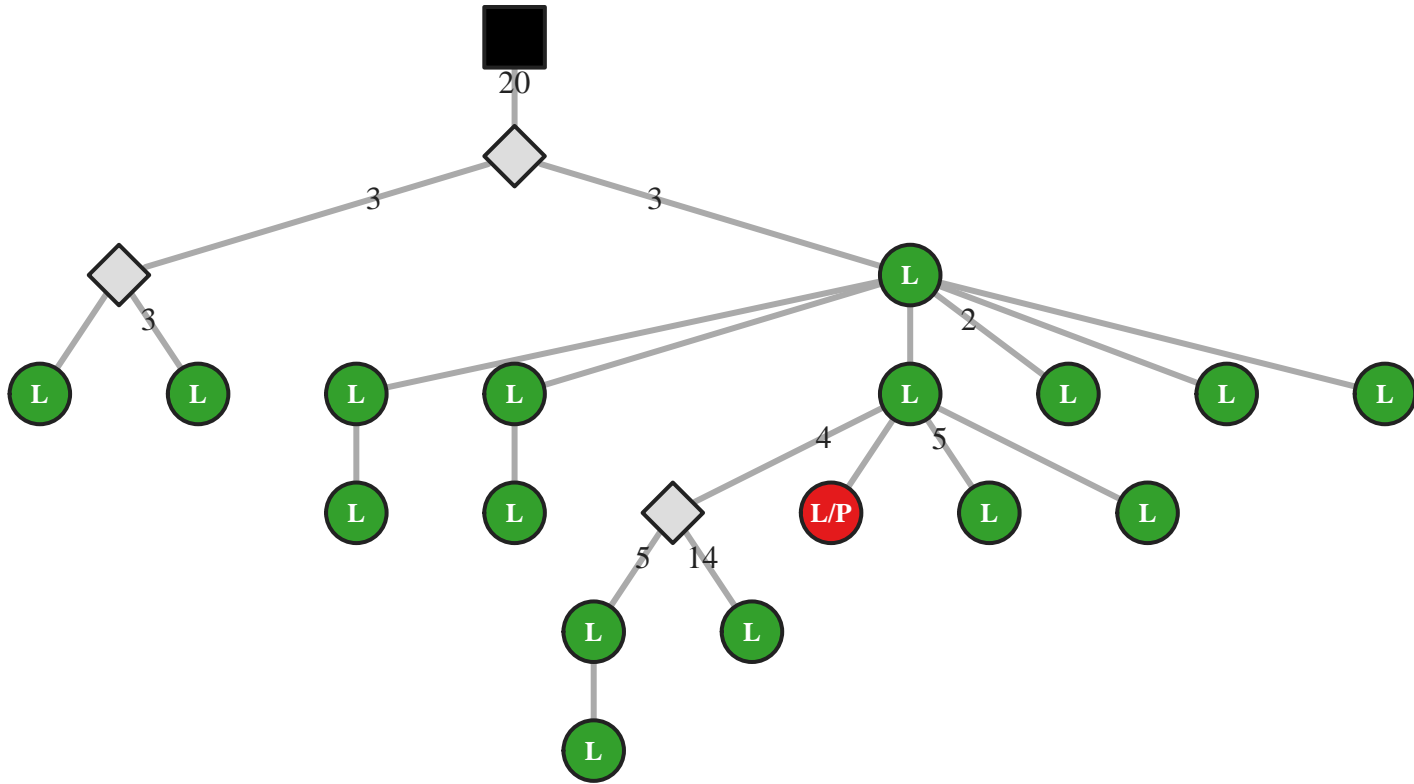

M5 IgA IGHV3-30/J4 45bp (2724)

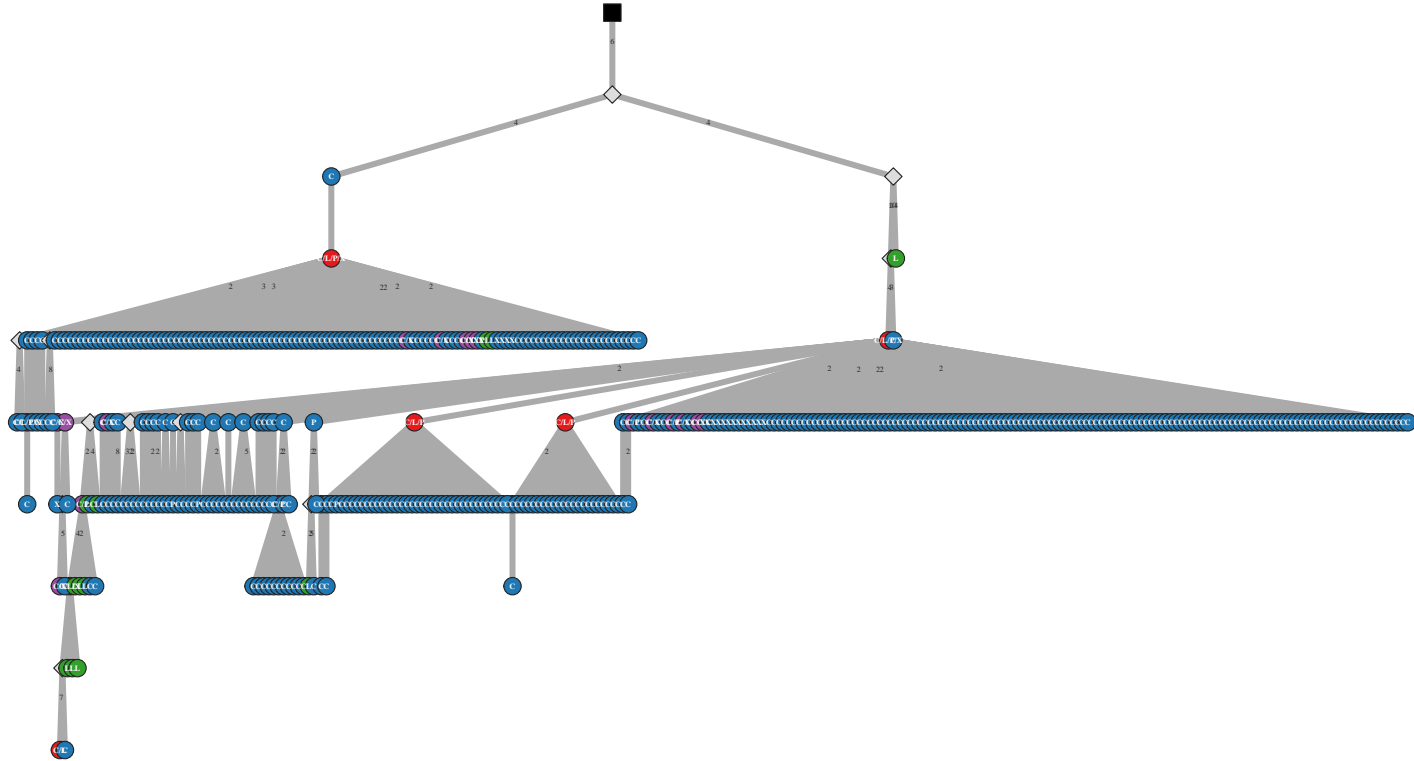

M5 IgA IGHV3-30/J4 45bp (2740)

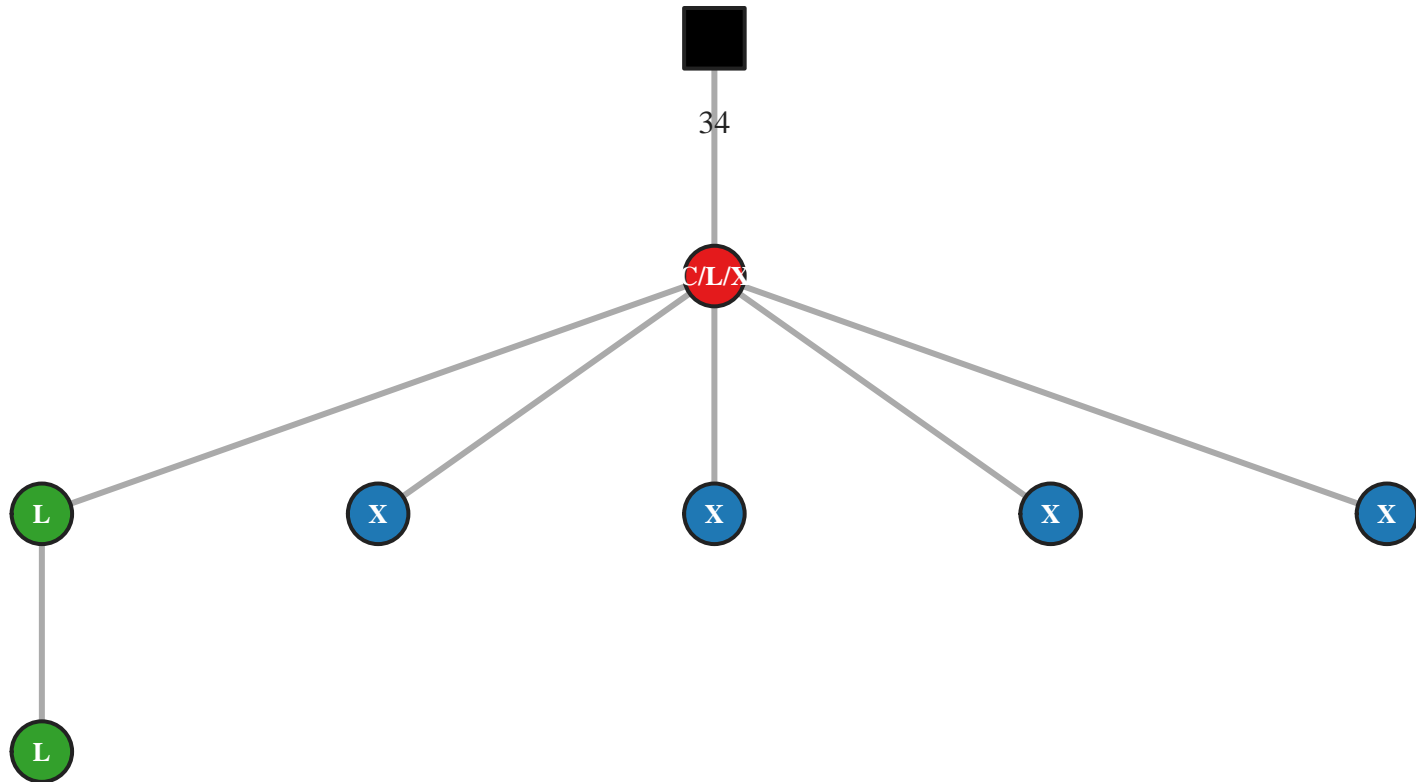

M5 IgA IGHV3-30/J4 45bp (2751)

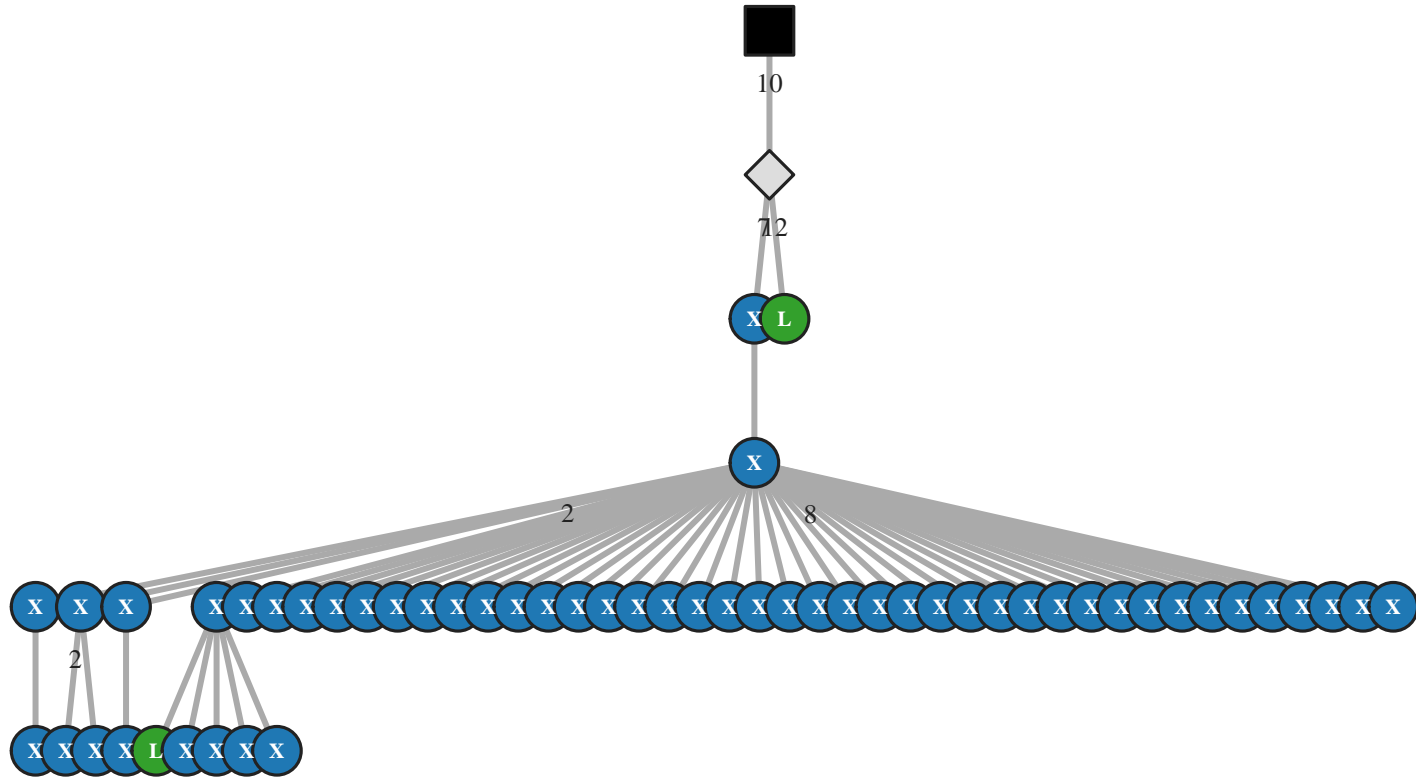

M5 IgG IGHV3-30/J4 45bp (16930)

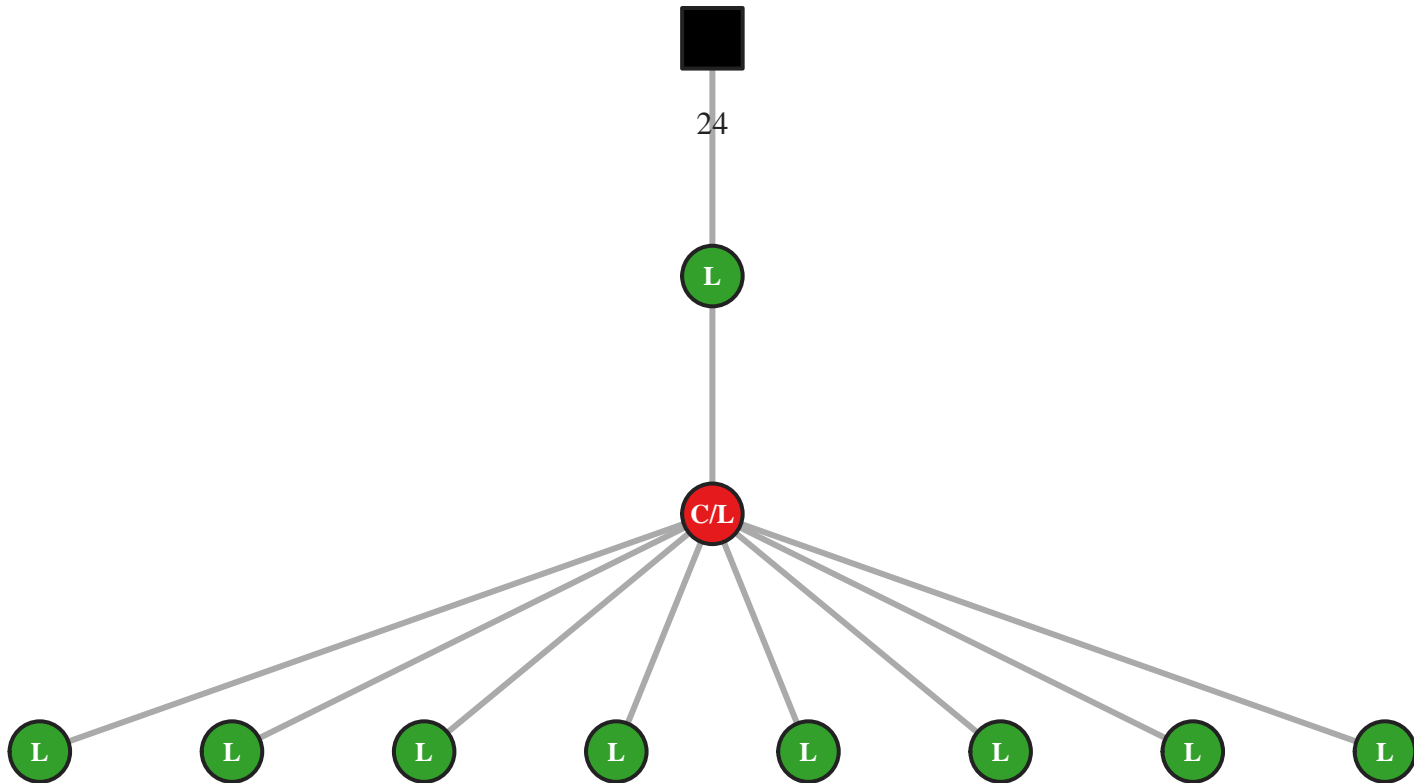

M5 IgG IGHV3-30/J4 45bp (16969)

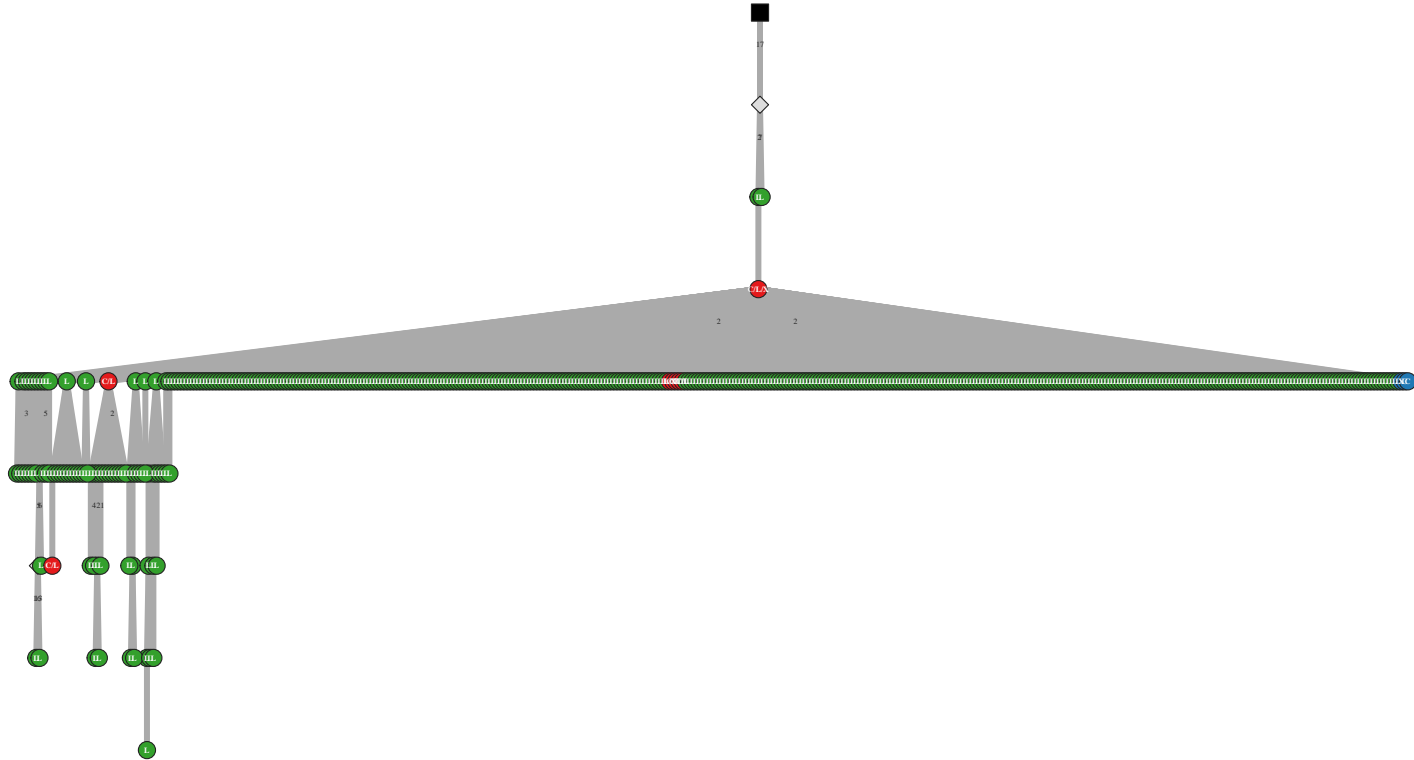

M5 IgG IGHV3-30/J4 45bp (16974)

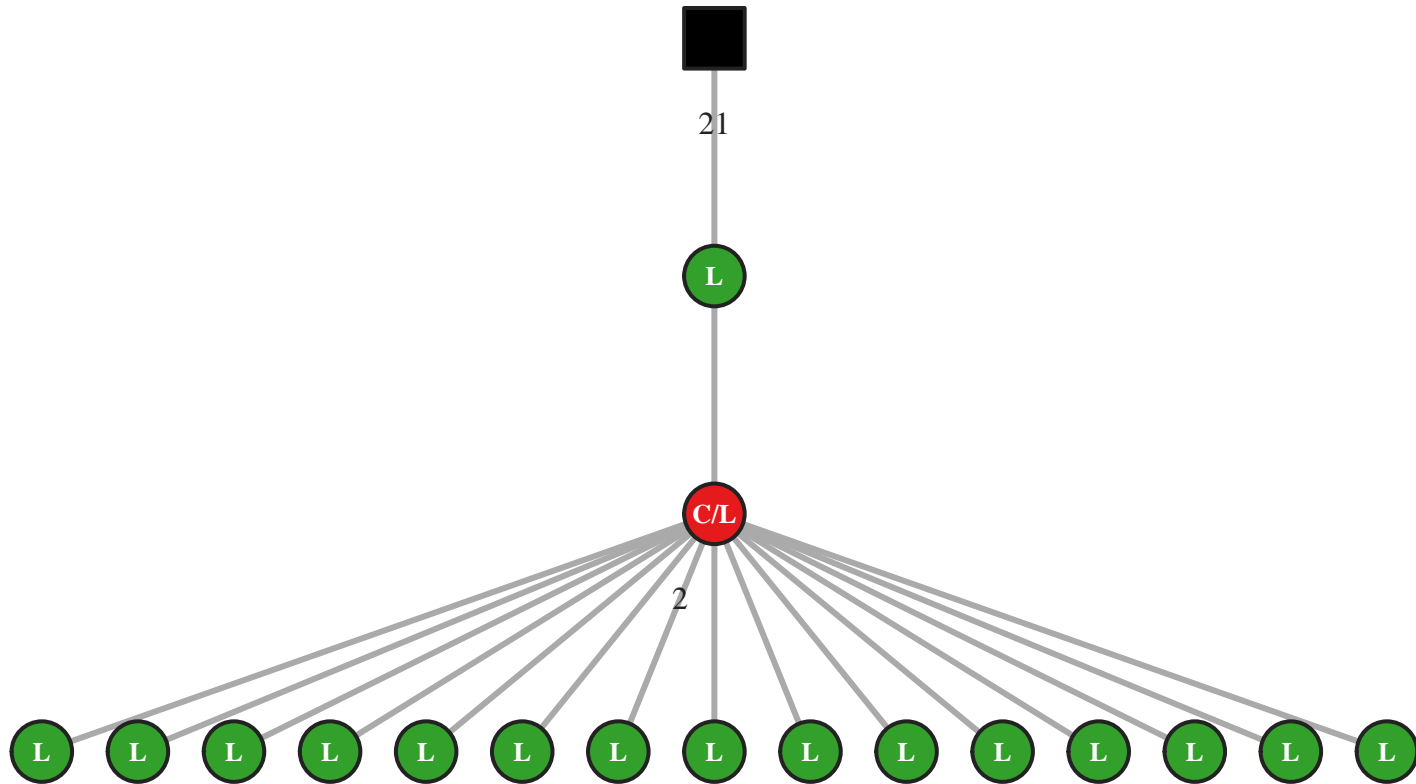

M5 IgG IGHV3-30/J4 45bp (17028)

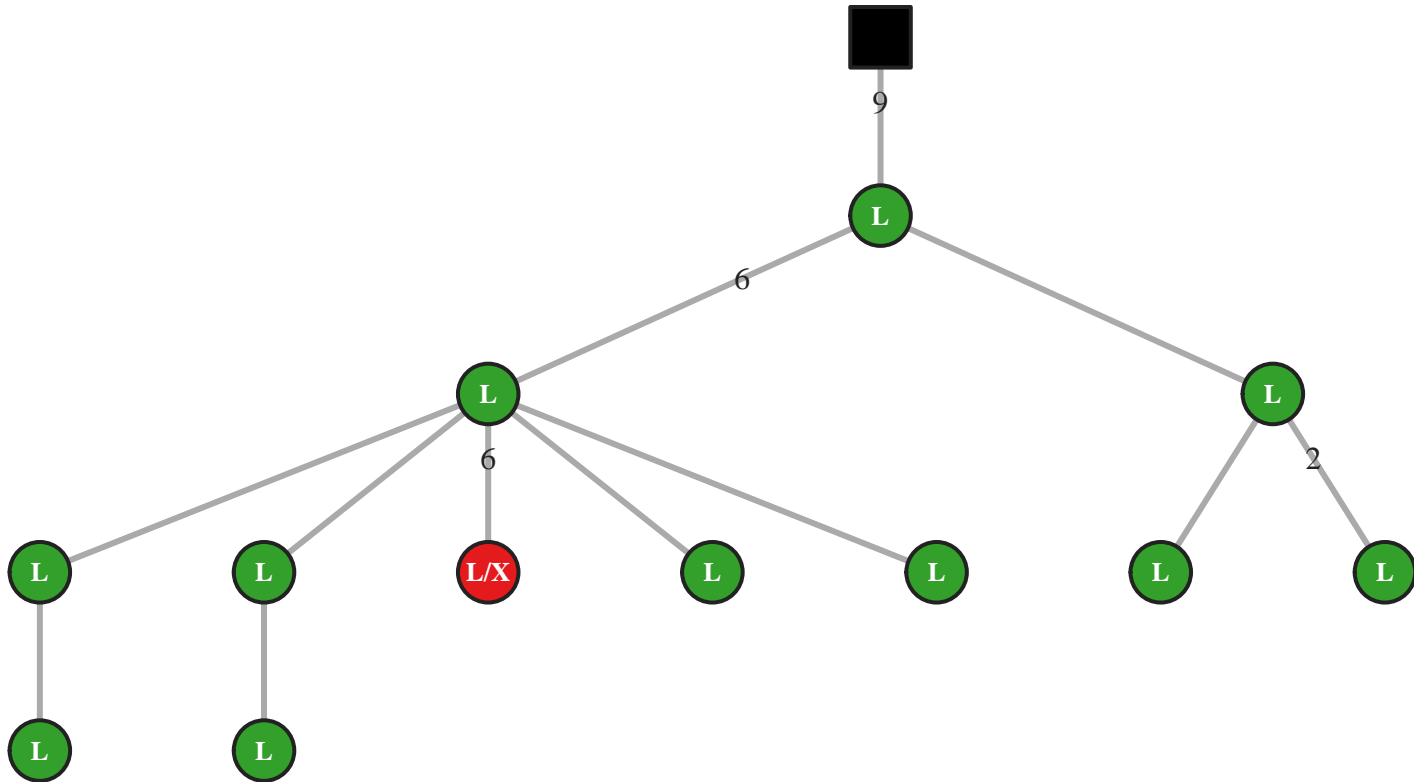

M5 IgG IGHV3-30/J4 45bp (17036)

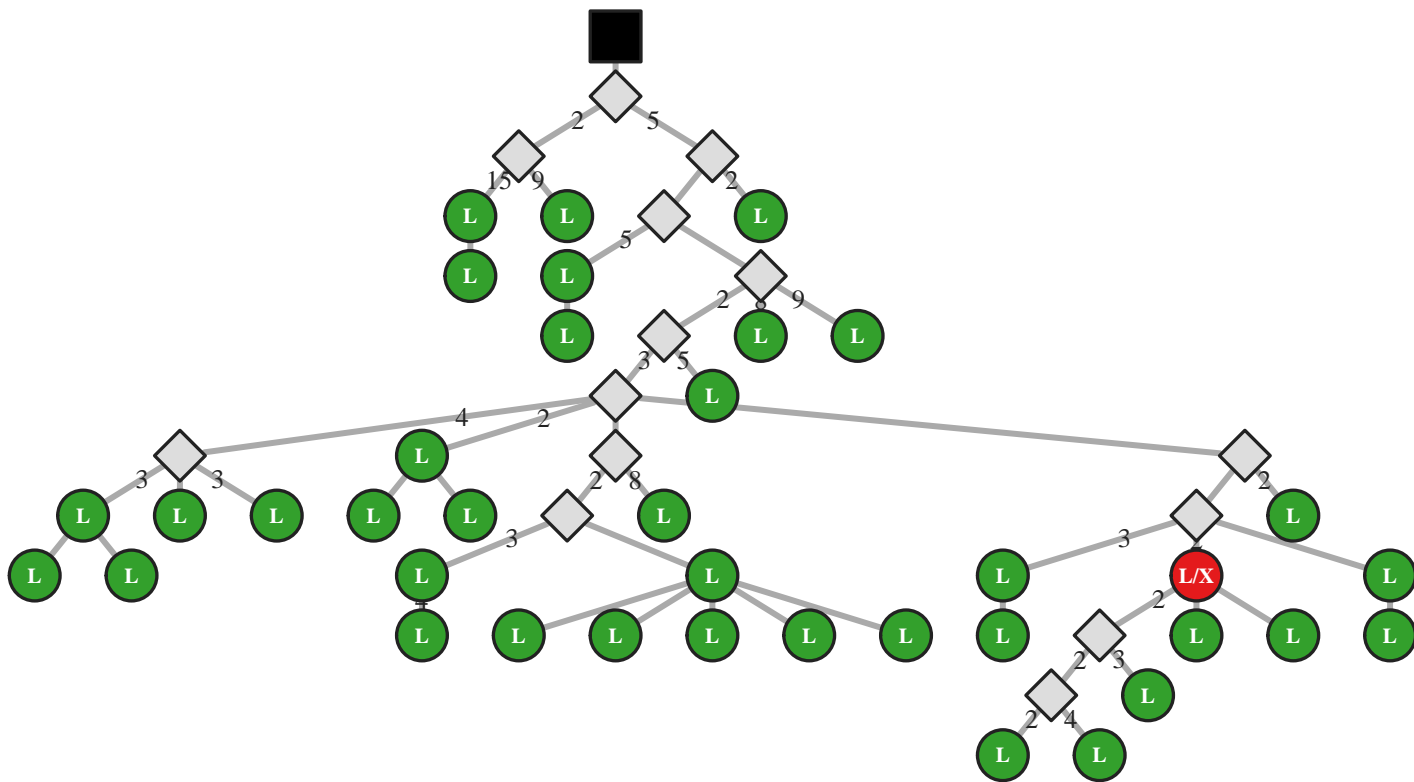

M5 IgG IGHV3-30/J4 45bp (17080)

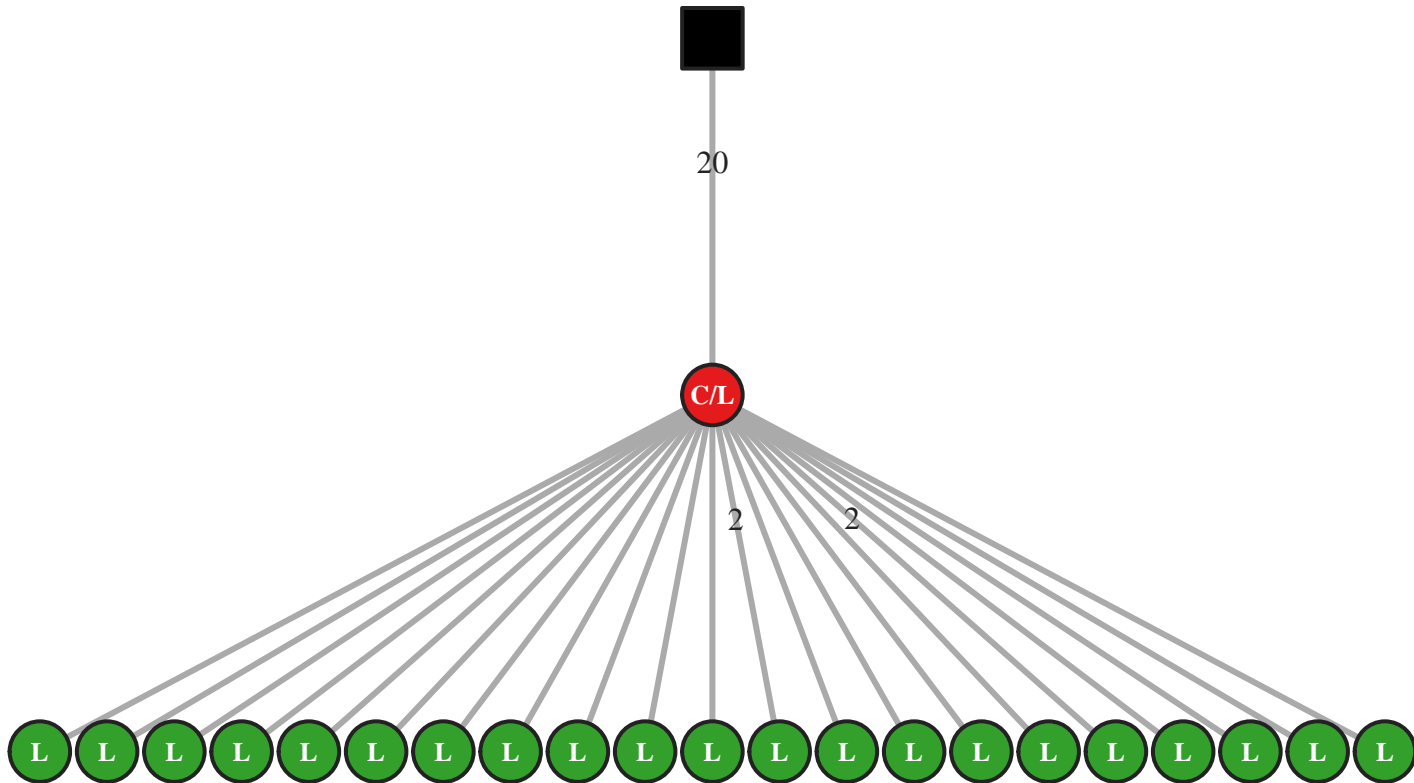

M5 IgG IGHV3-30/J4 45bp (17285)

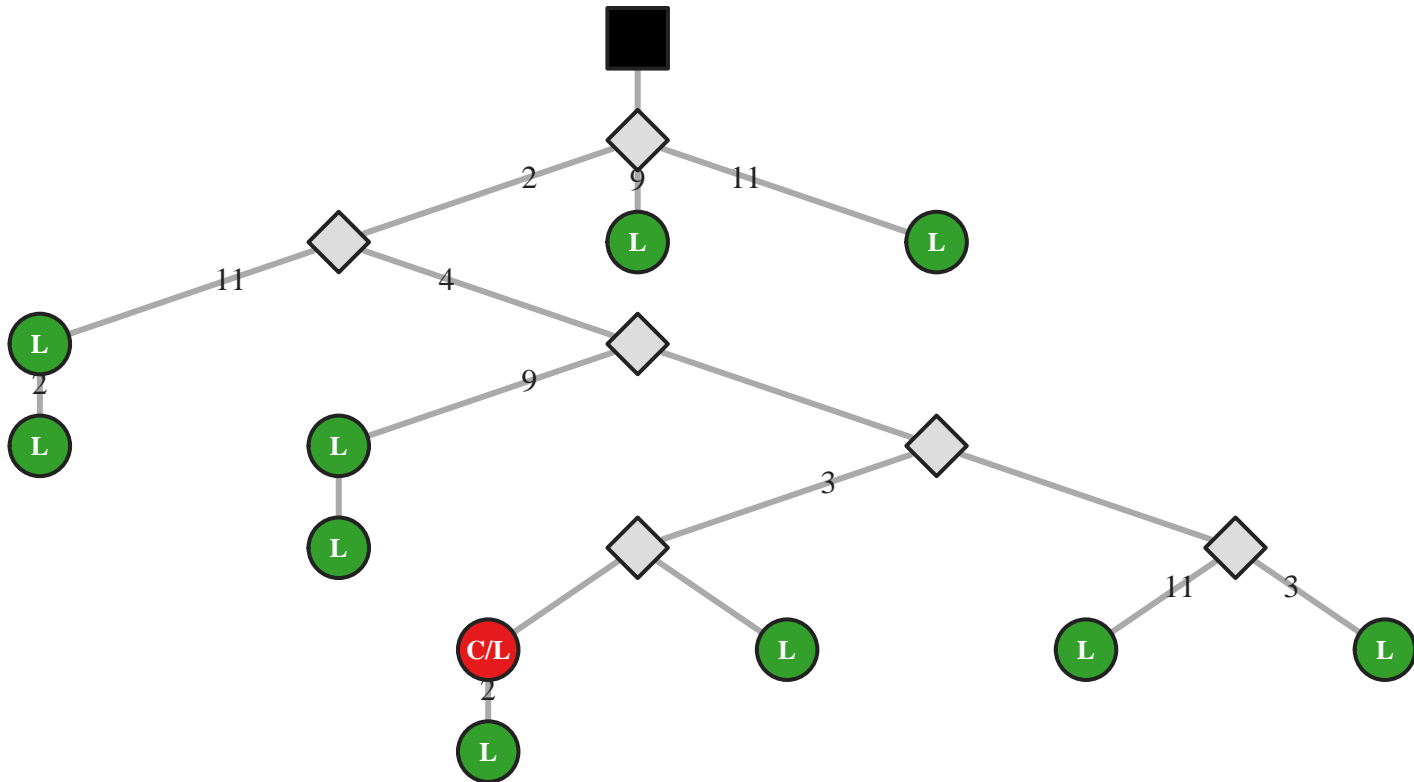

M5 IgG IGHV3-30/J4 45bp (17287)

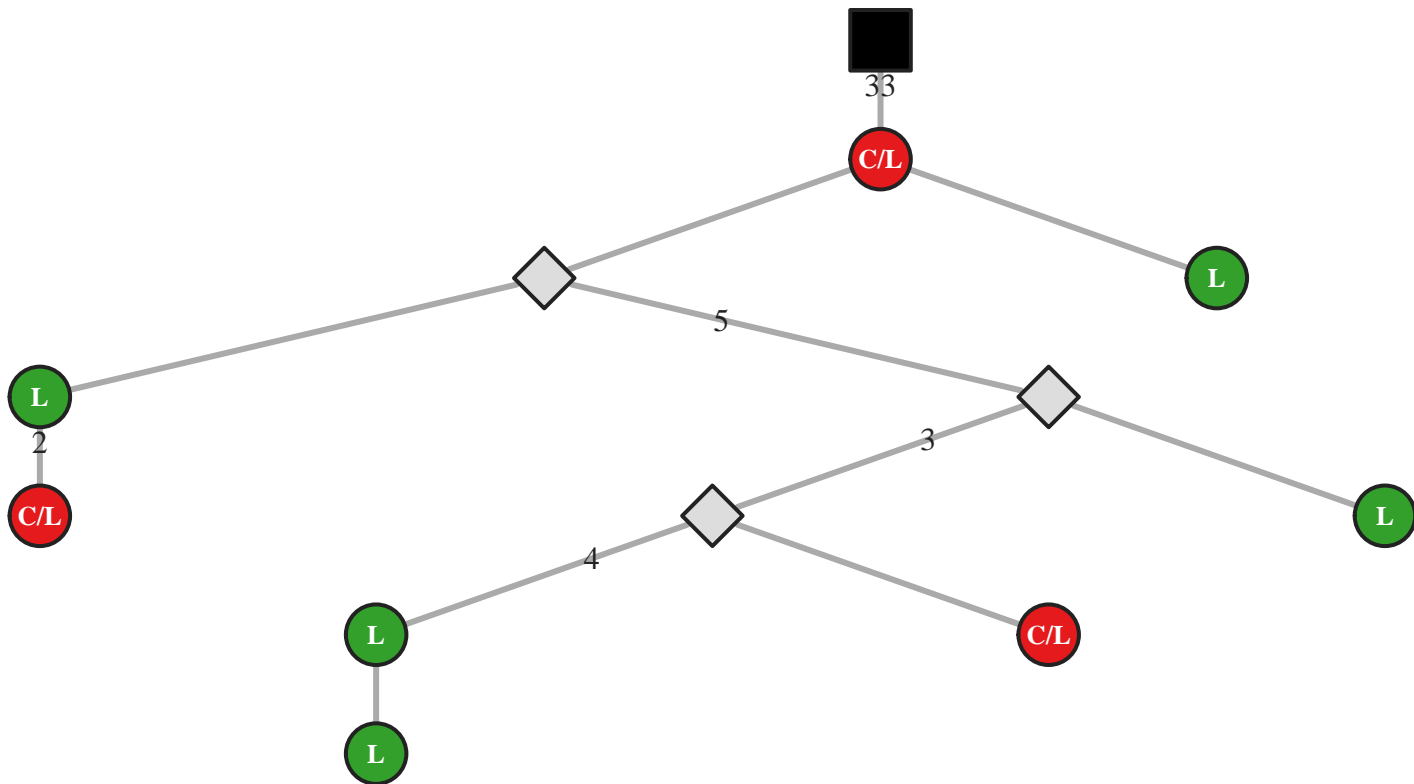

M5 IgG IGHV3-30/J4 45bp (17290)

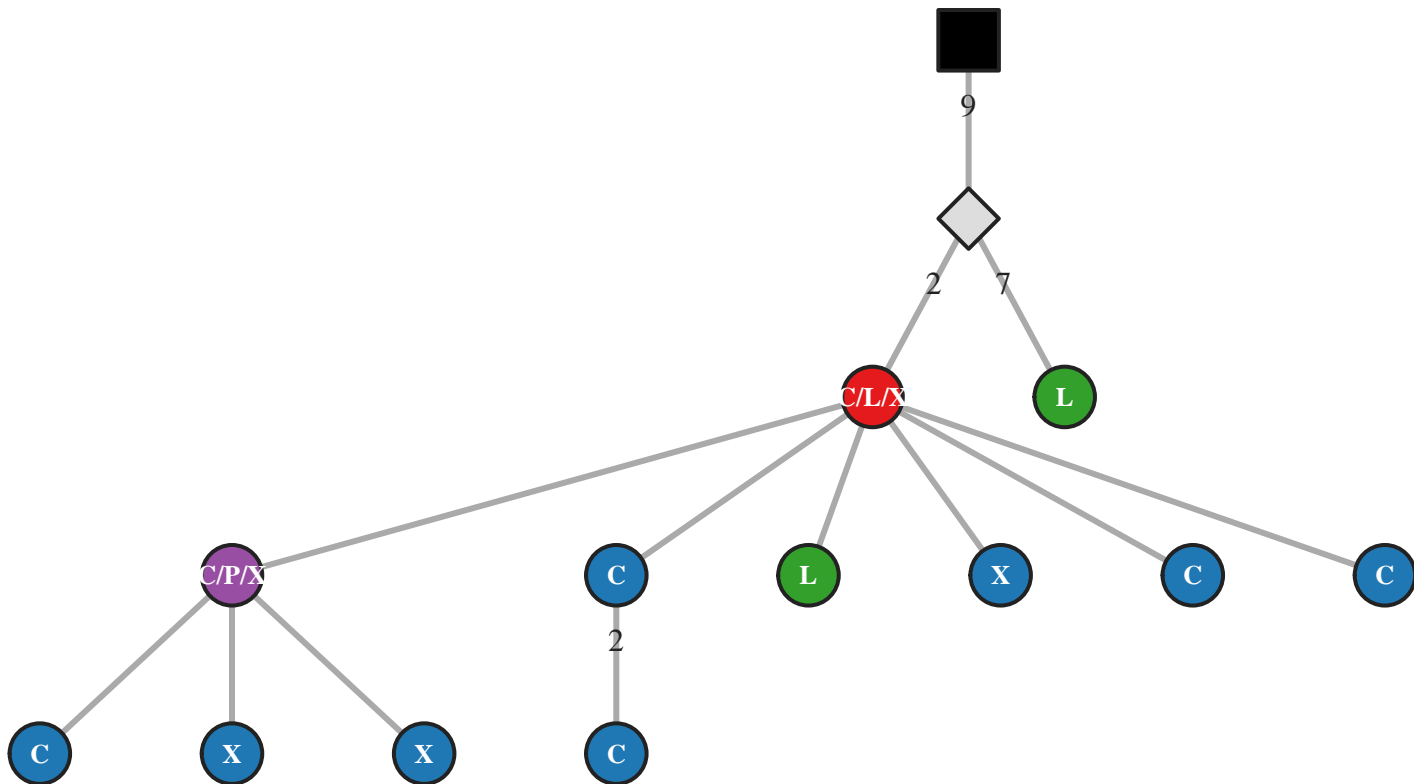

M5 IgM IGHV3-30/J4 45bp (11365)

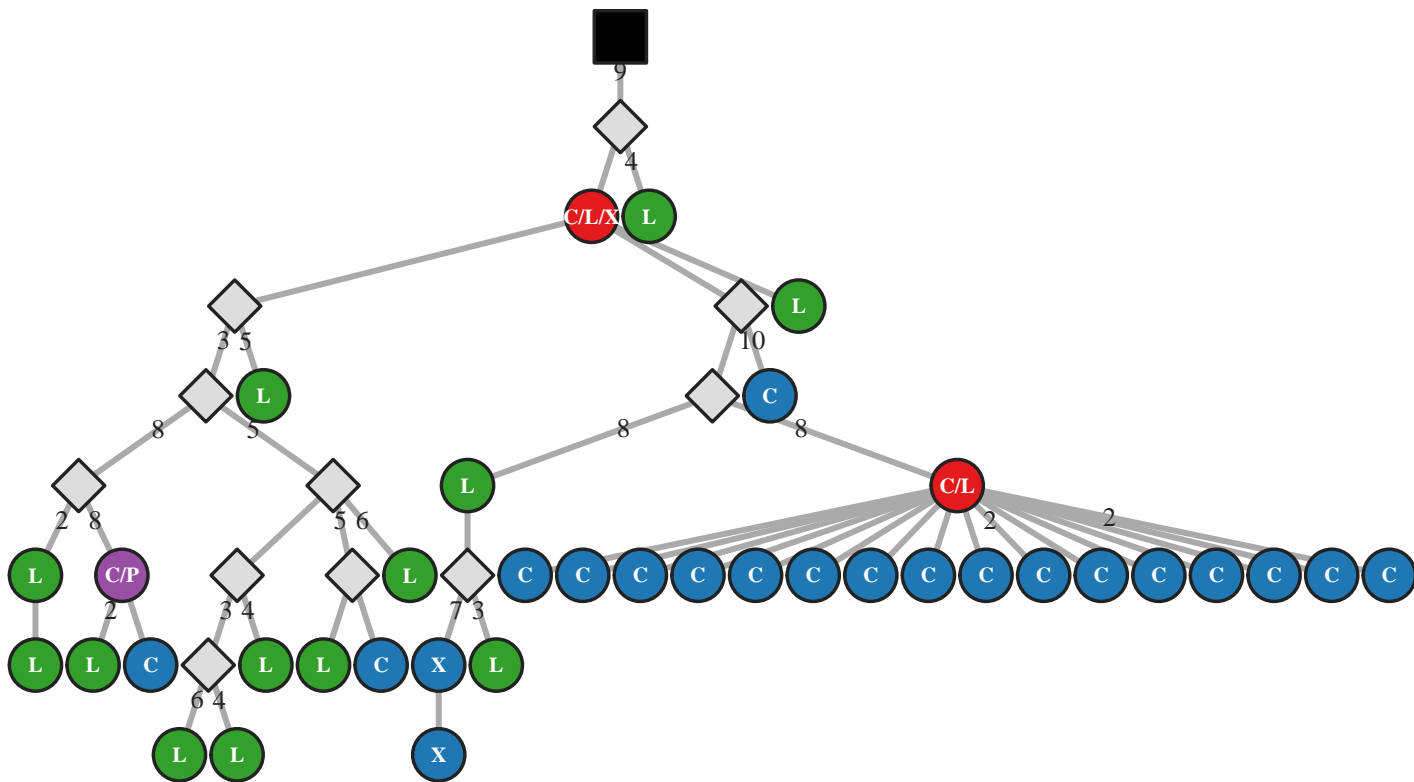

M5 IgA IGHV3-30/J4 48bp (2753)

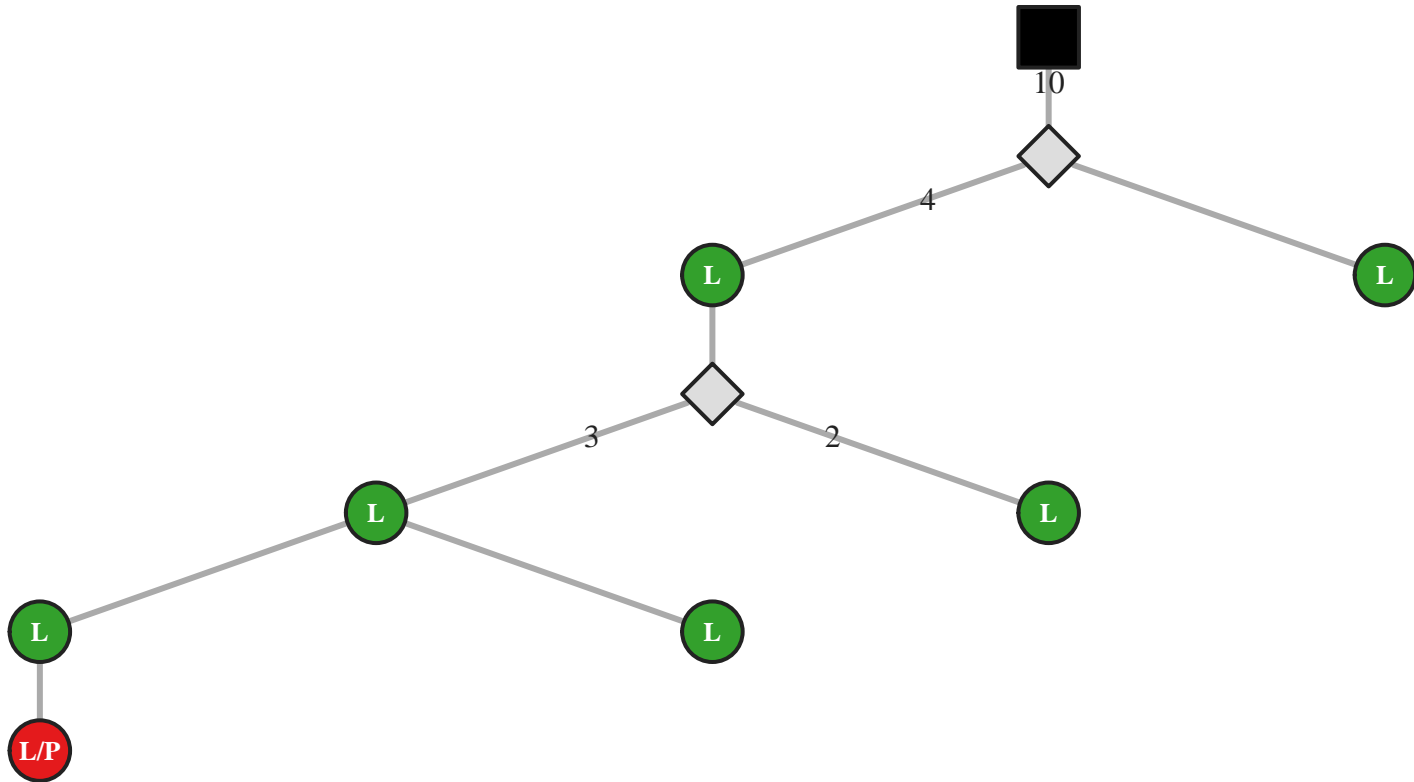

M5 IgG IGHV3-30/J4 48bp (7373)

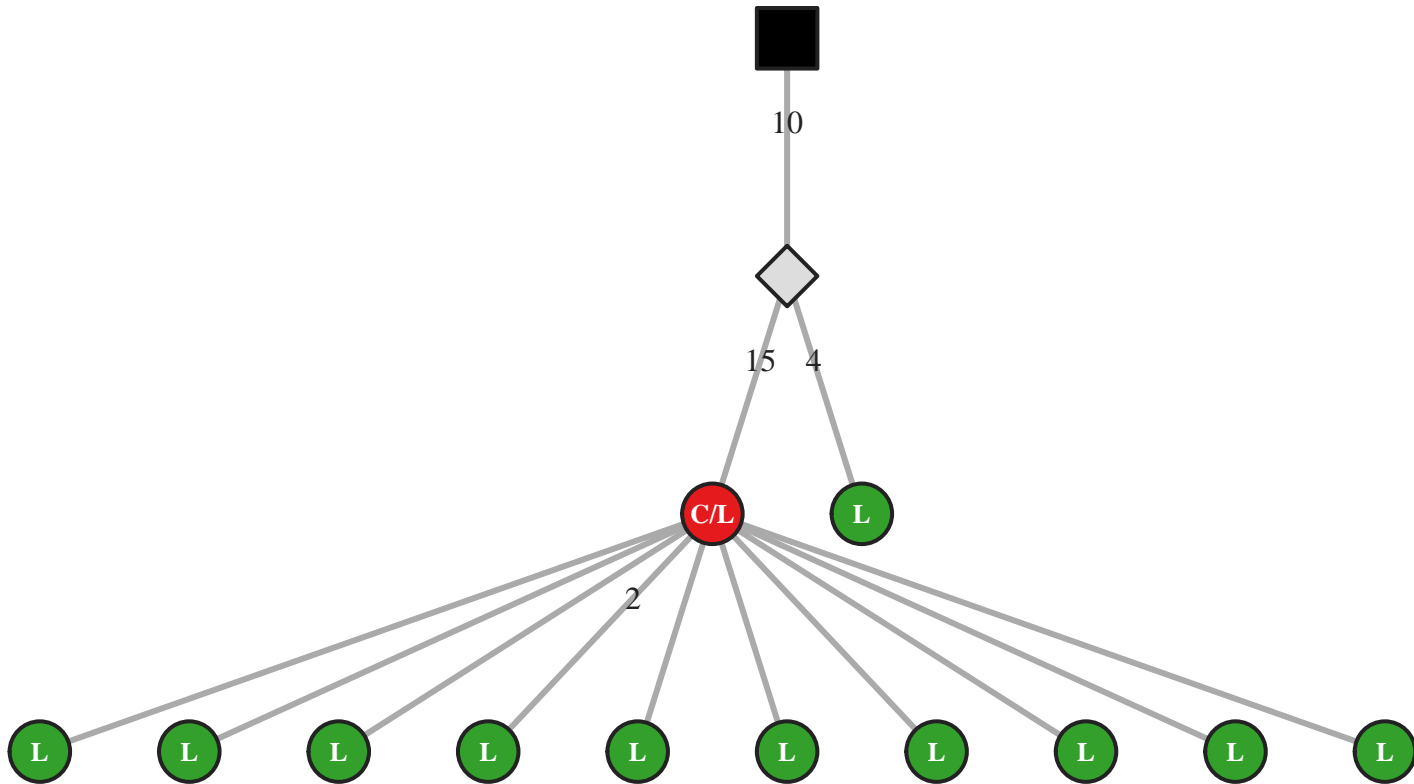

M5 IgG IGHV3-30/J4 48bp (7411)

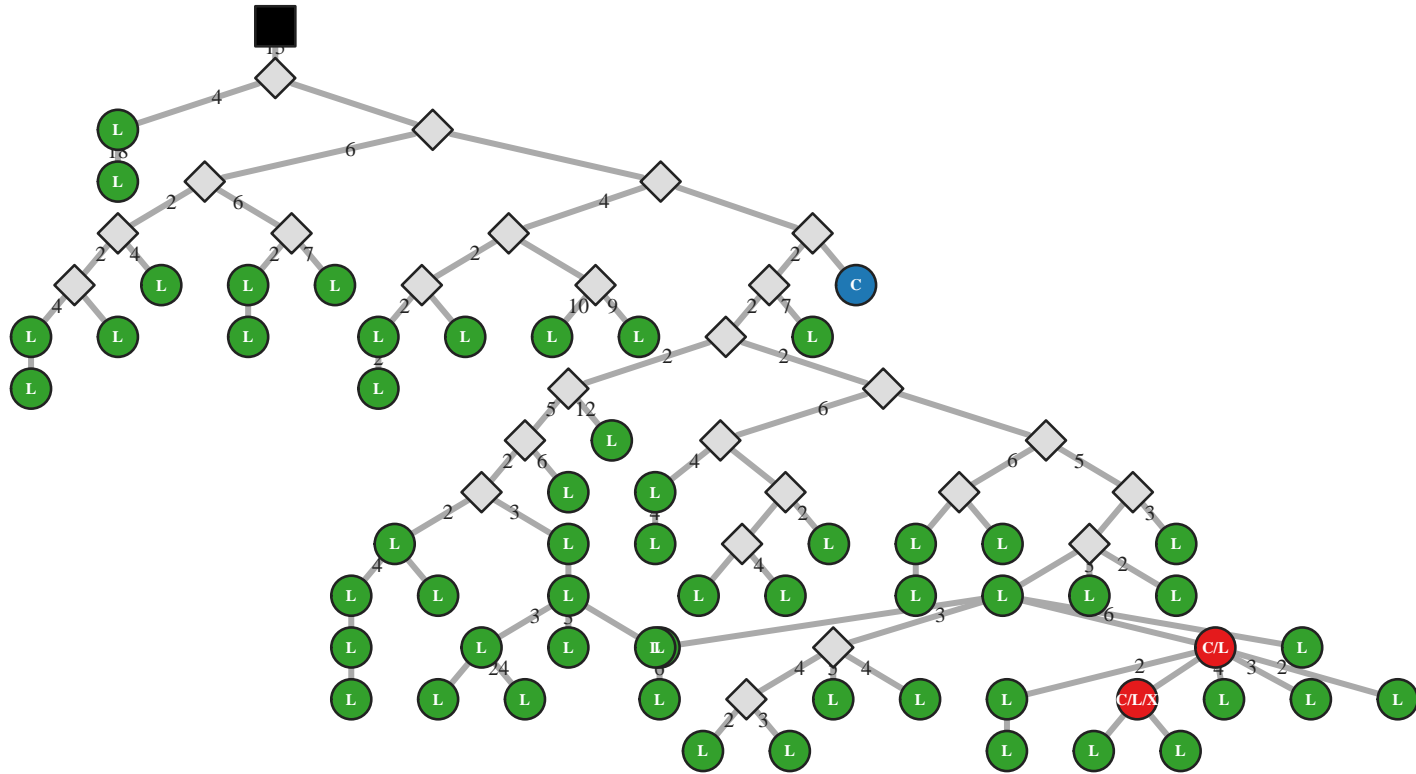

M5 IgG IGHV3-30/J4 48bp (7448)

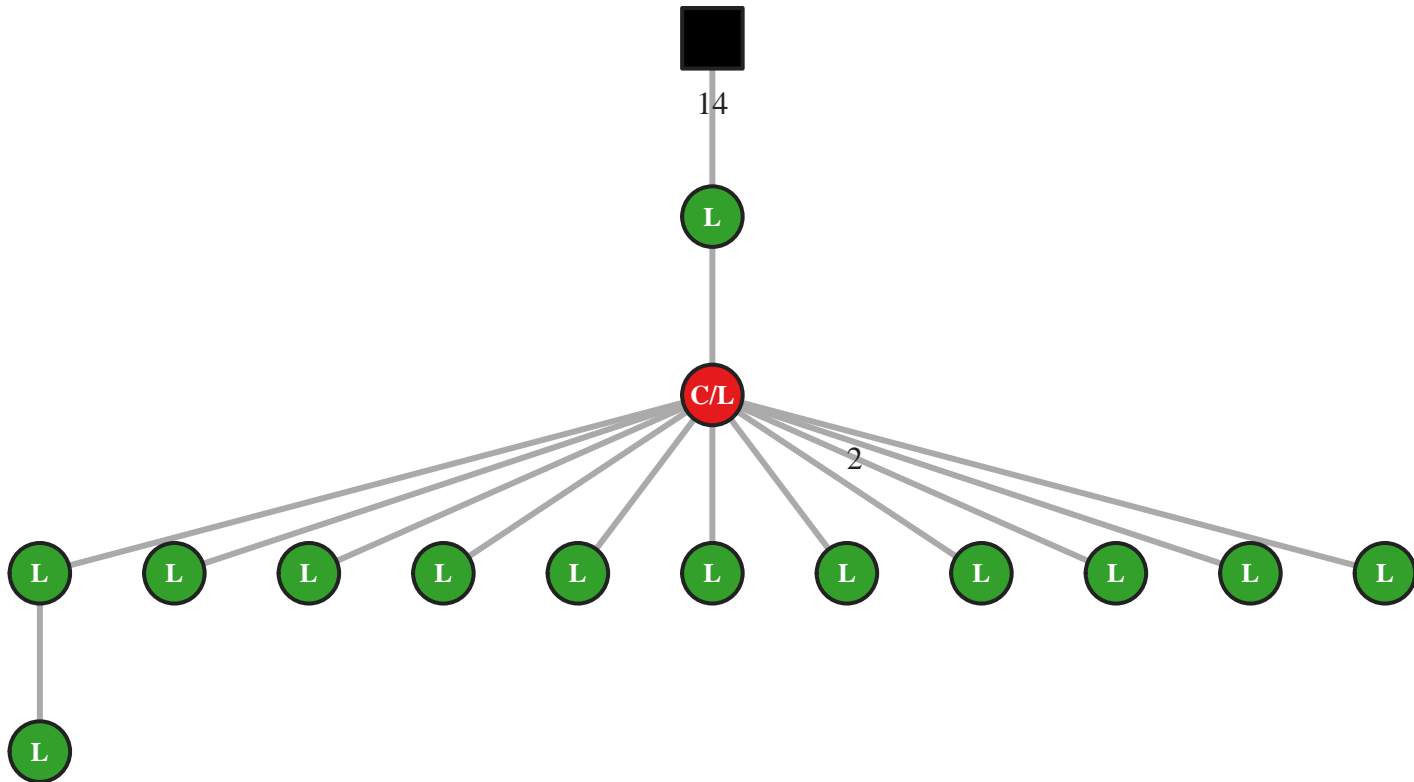

M5 IgG IGHV3-30/J4 48bp (7683)

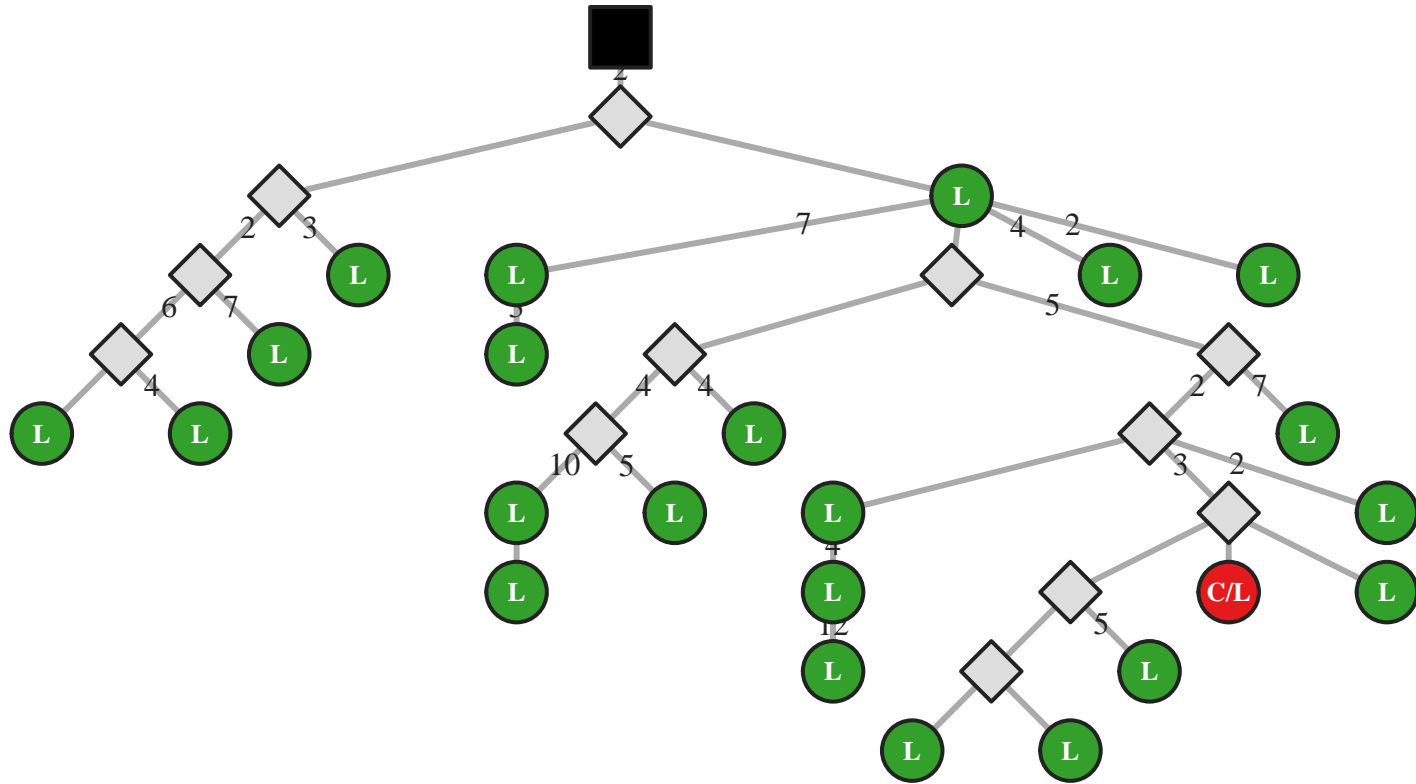

M5 IgA IGHV3-30/J4 51bp (21694)

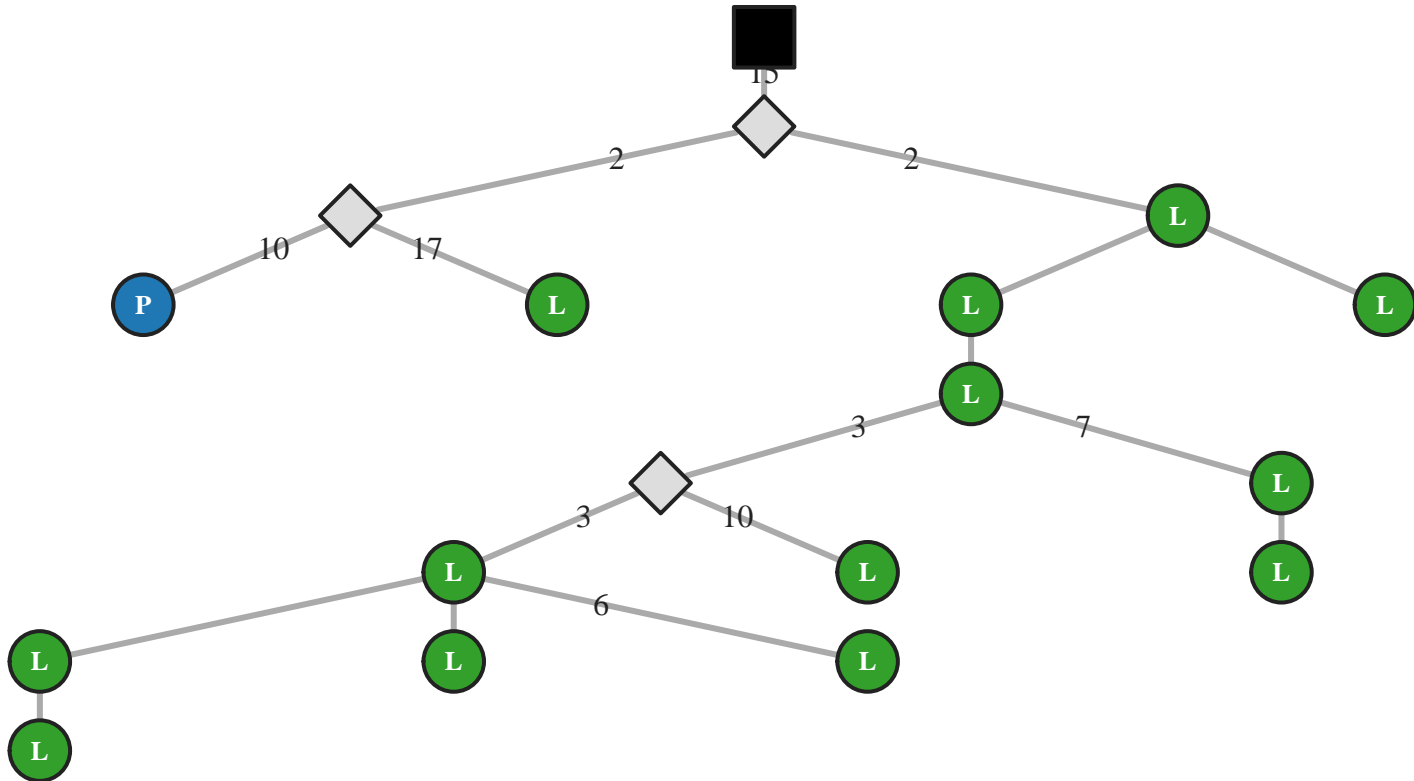

M5 IgA IGHV3-30/J4 51bp (21696)

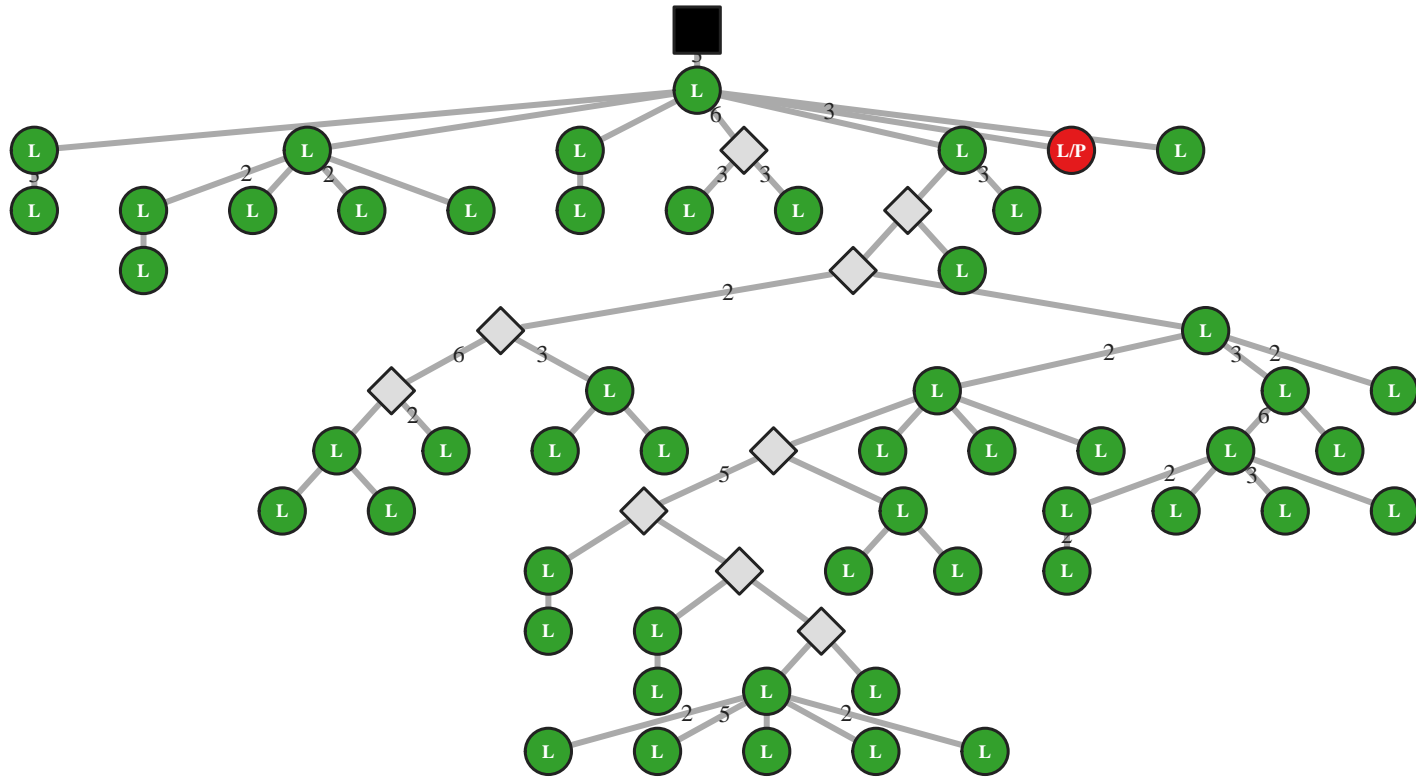

M5 IgG IGHV3-30/J4 51bp (44165)

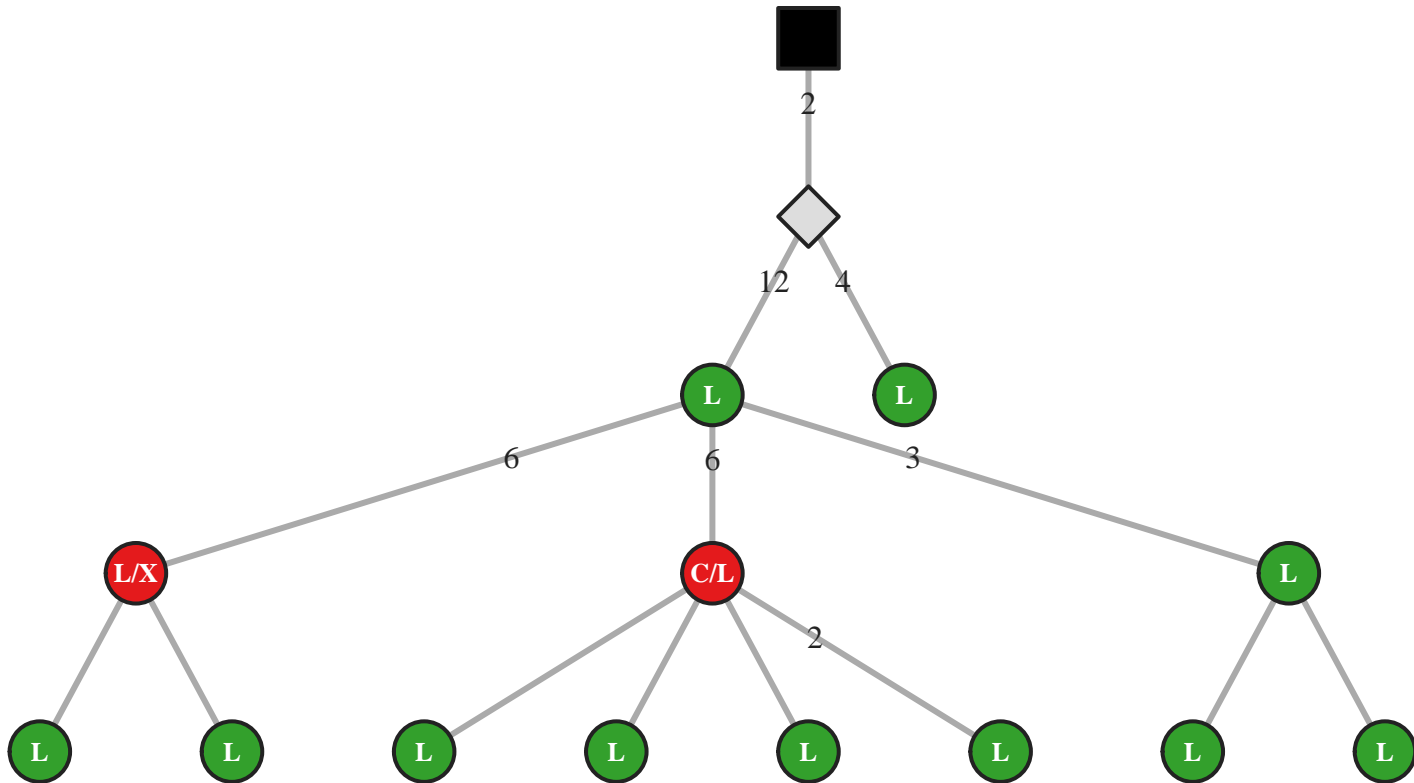

M5 IgG IGHV3-30/J4 51bp (44183)

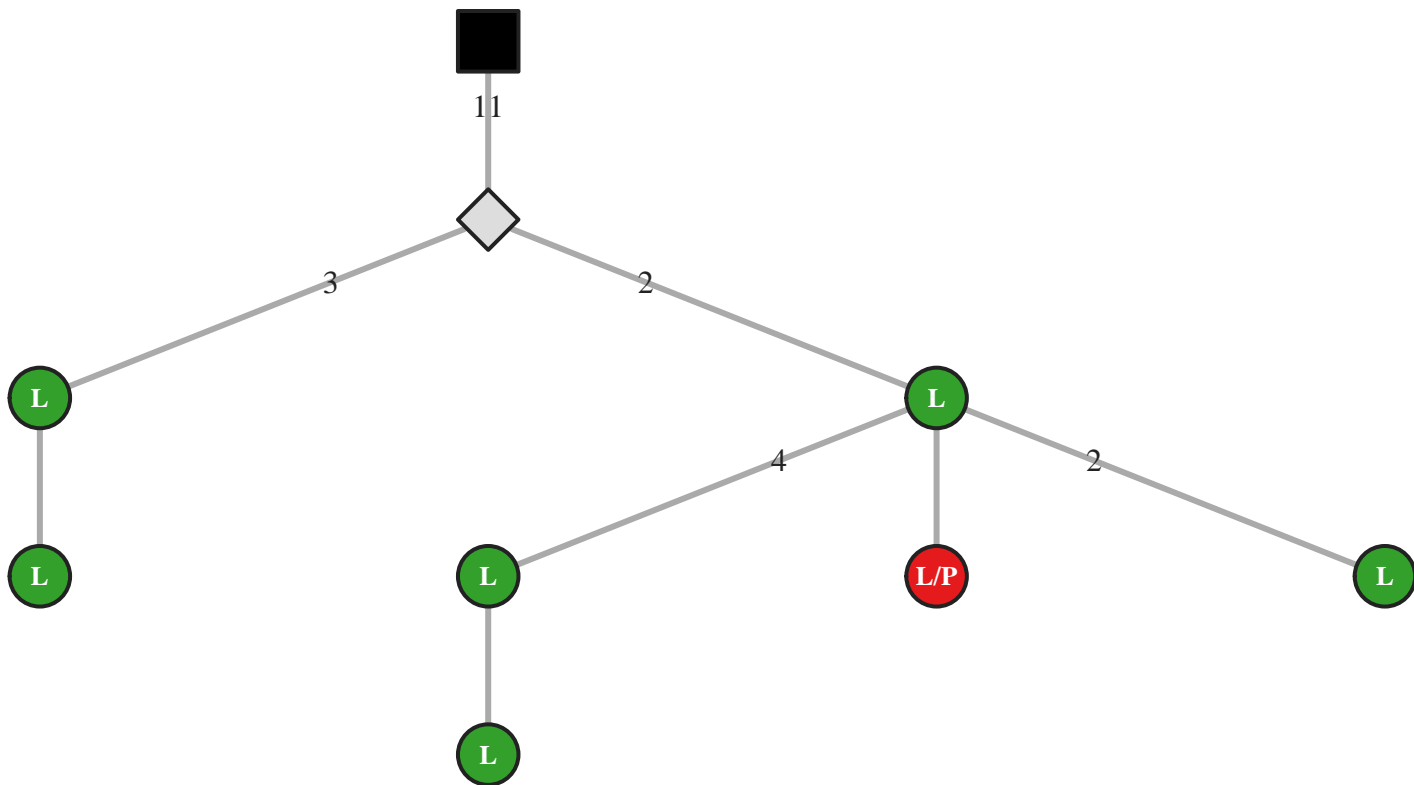

M5 IgG IGHV3-30/J4 51bp (44204)

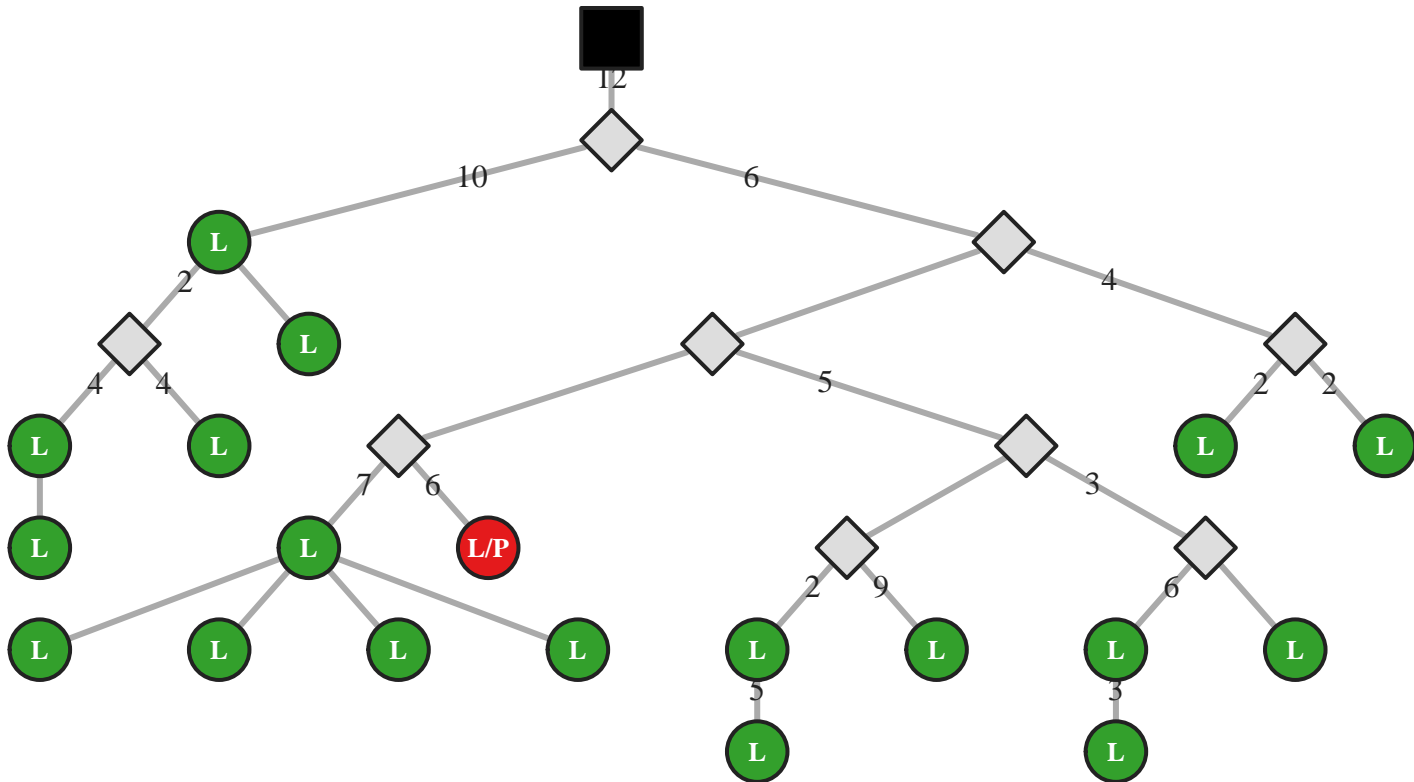

M5 IgG IGHV3-30/J4 51bp (44229)

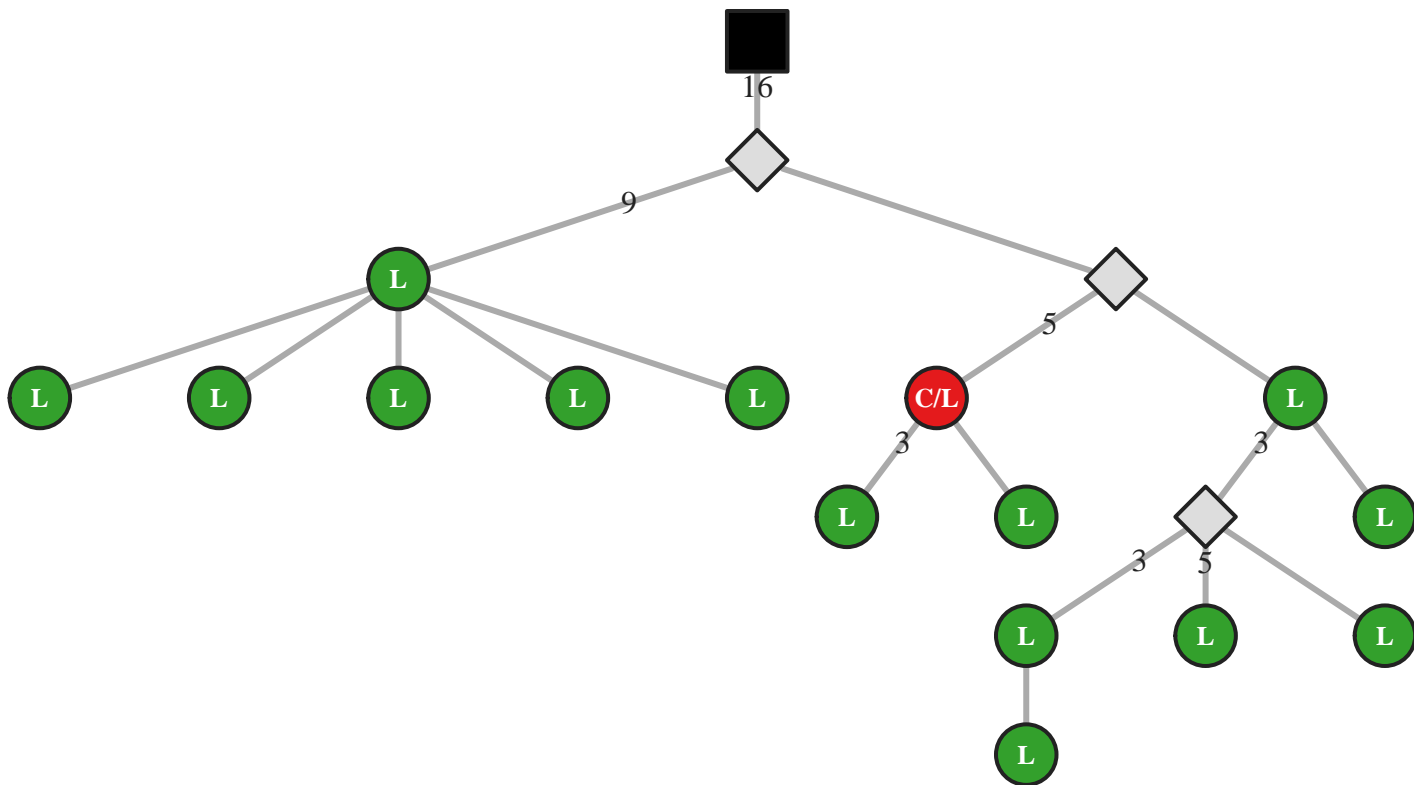

M5 IgG IGHV3-30/J4 51bp (44442)

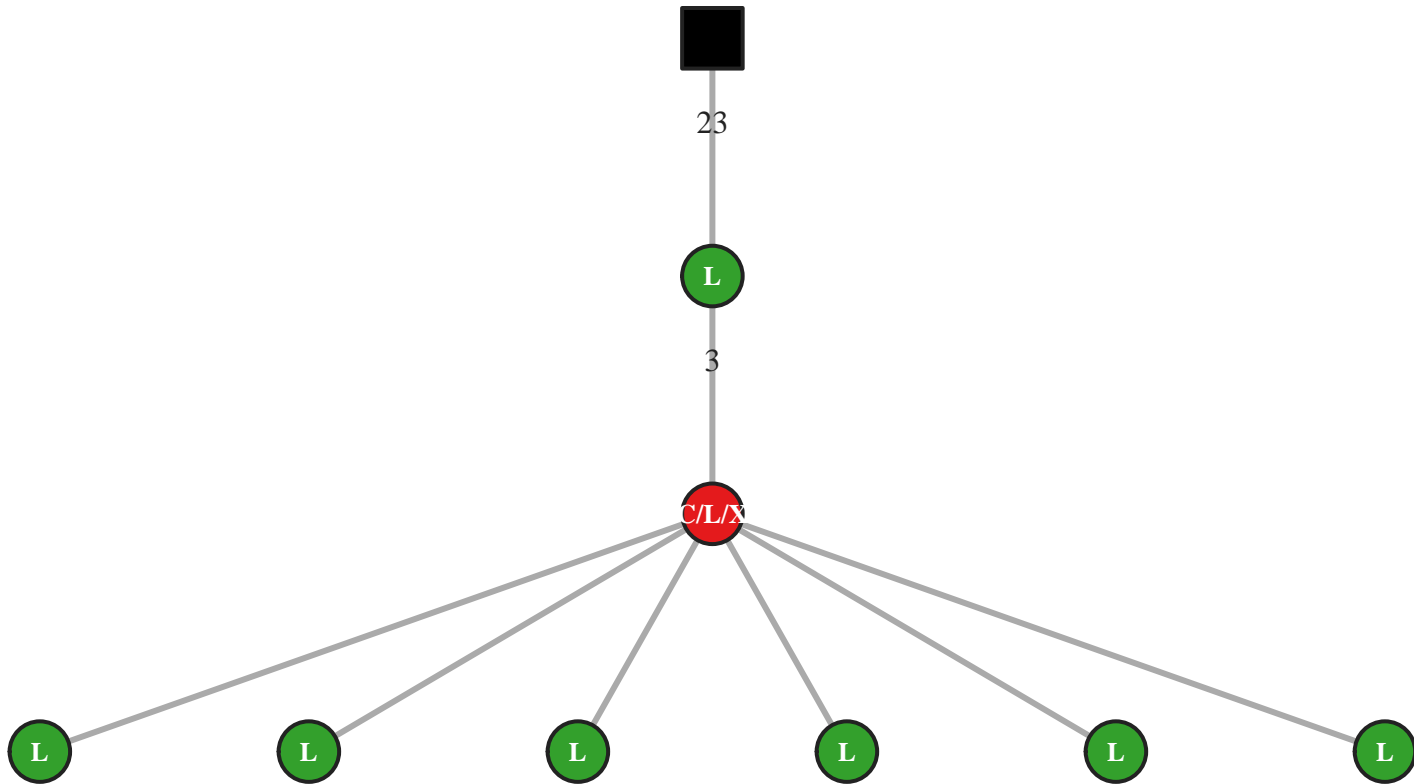

M5 IgG IGHV3-30/J4 51bp (44570)

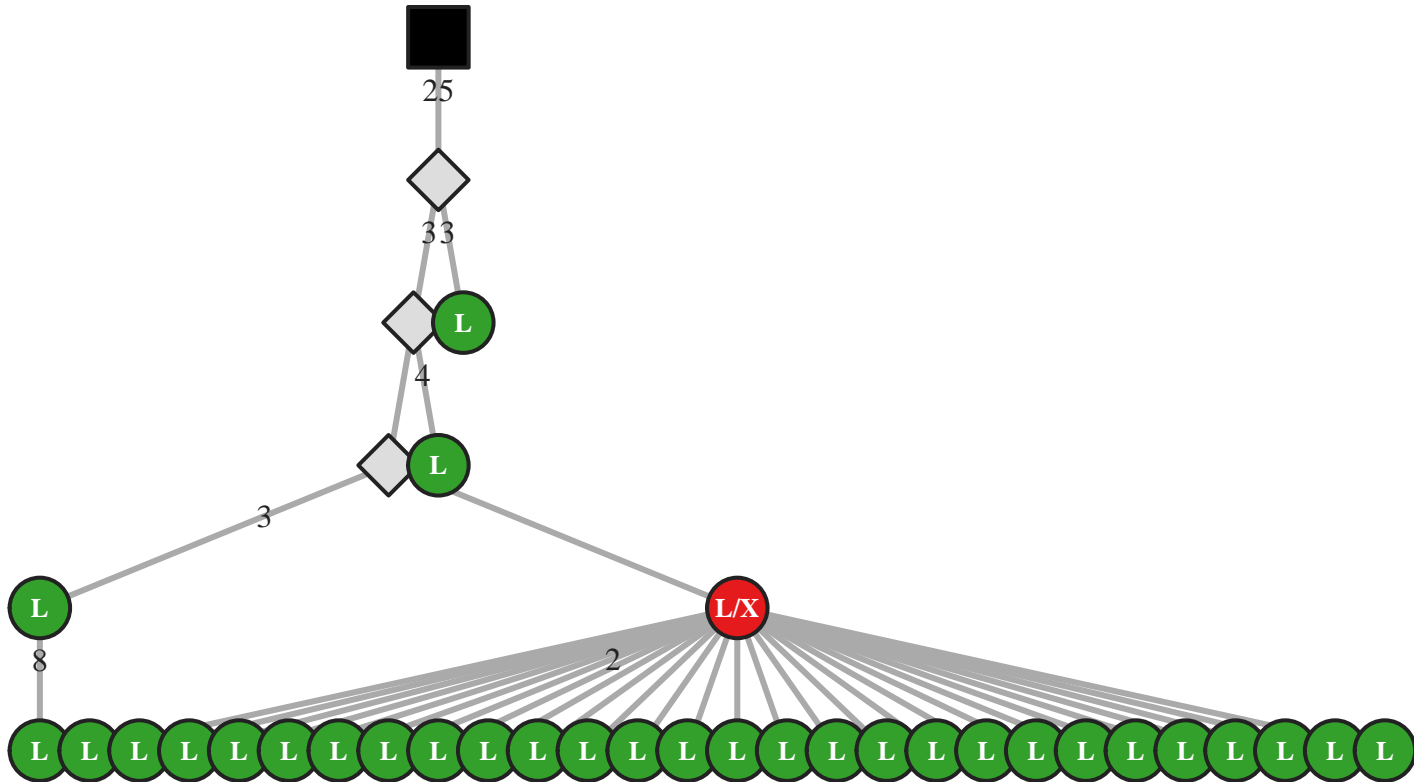

M5 IgG IGHV3-30/J4 54bp (34513)

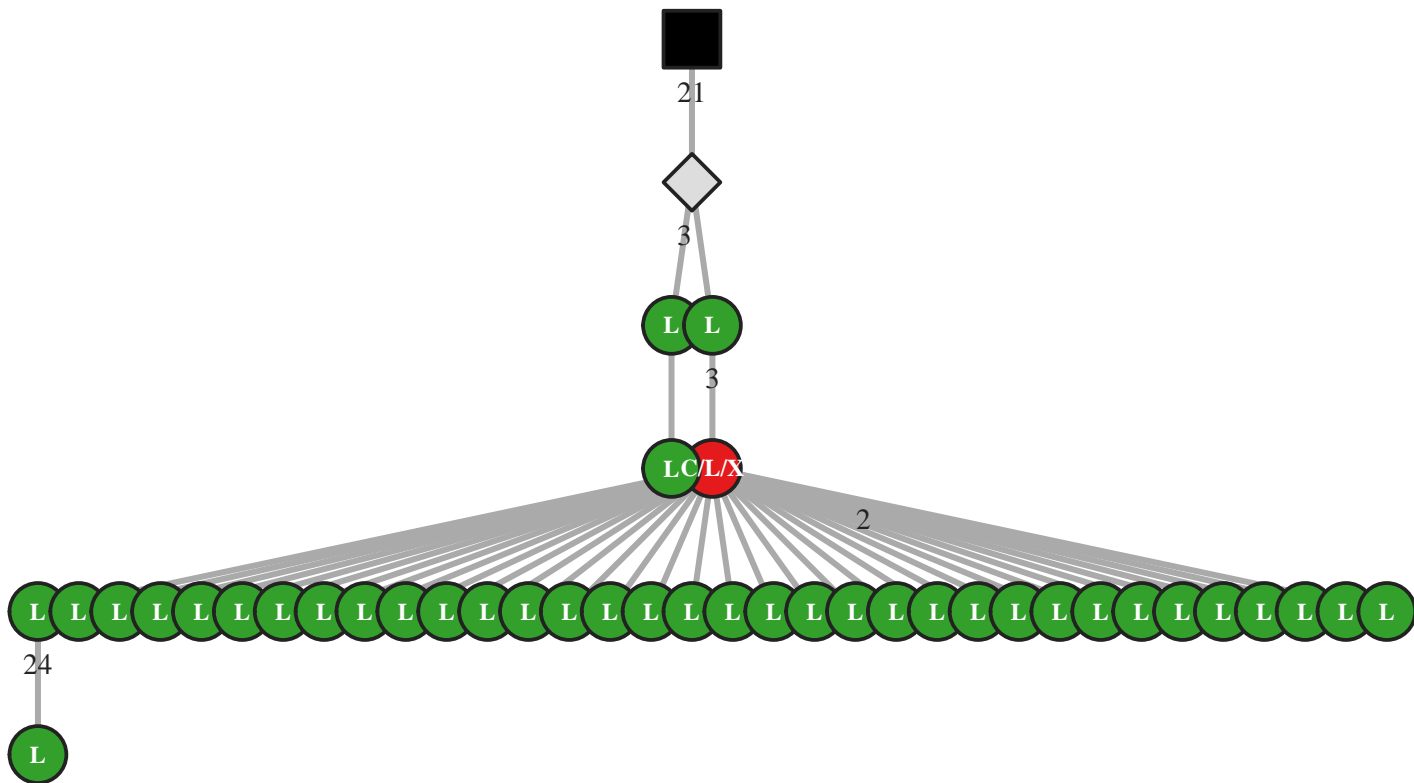

M5 IgG IGHV3-30/J4 54bp (34602)

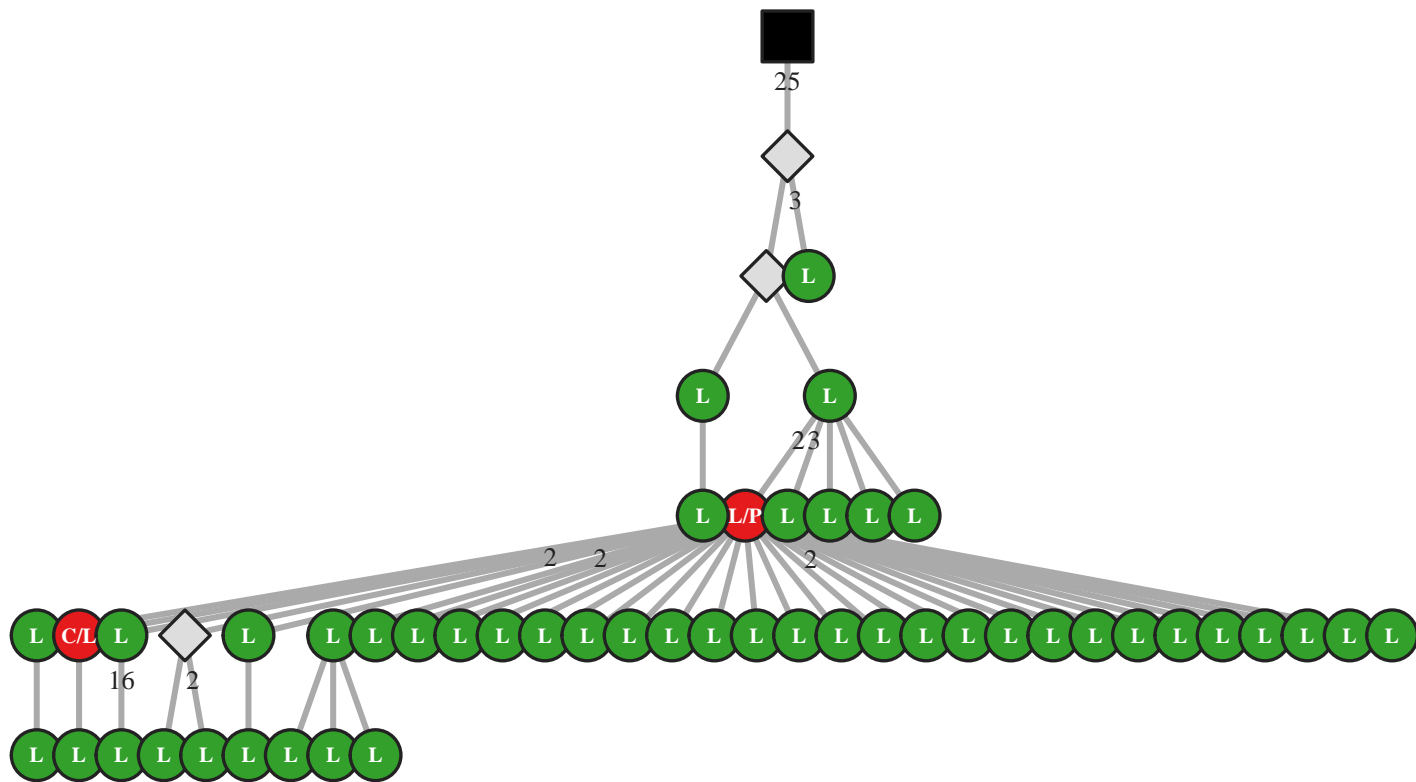

M5 IgG IGHV3-30/J4 54bp (34632)

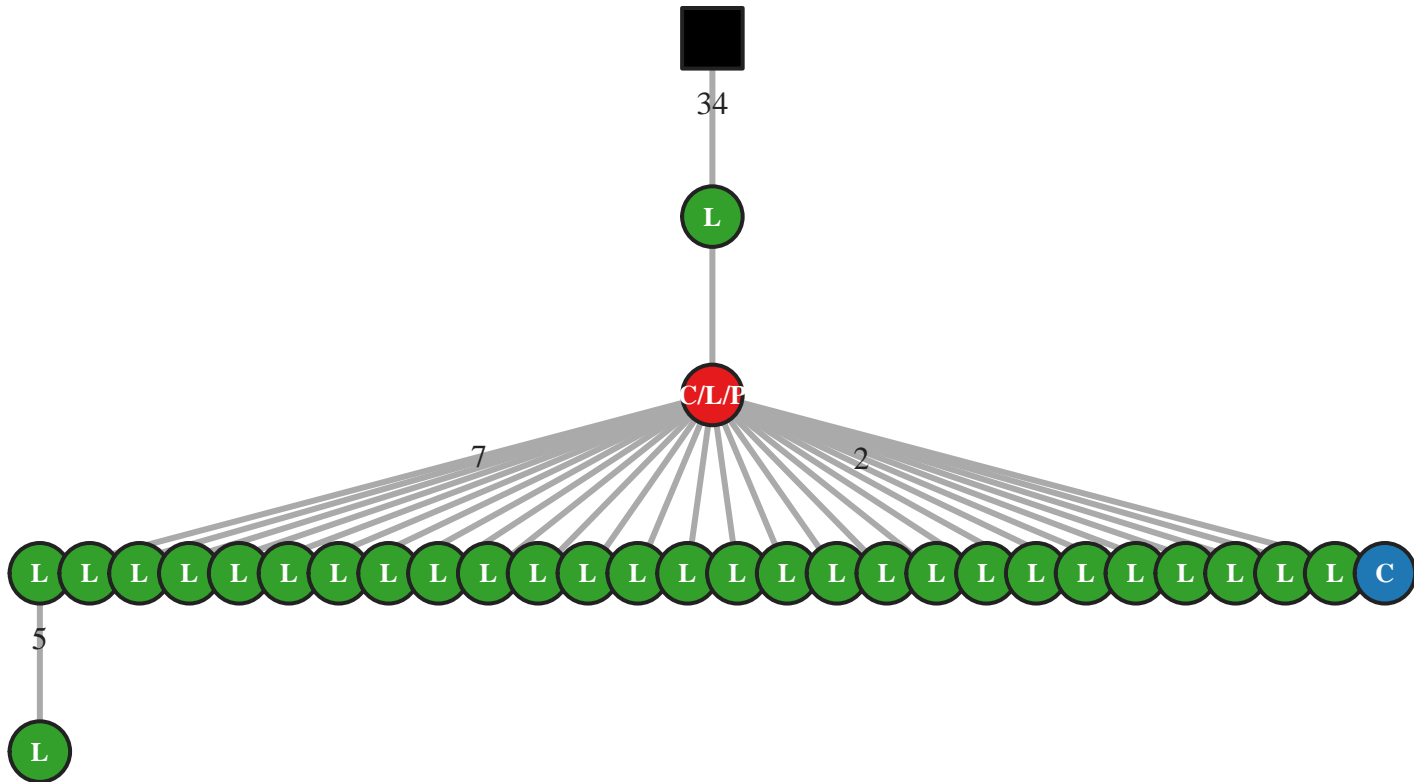

M5 IgG IGHV3-30/J4 54bp (34658)

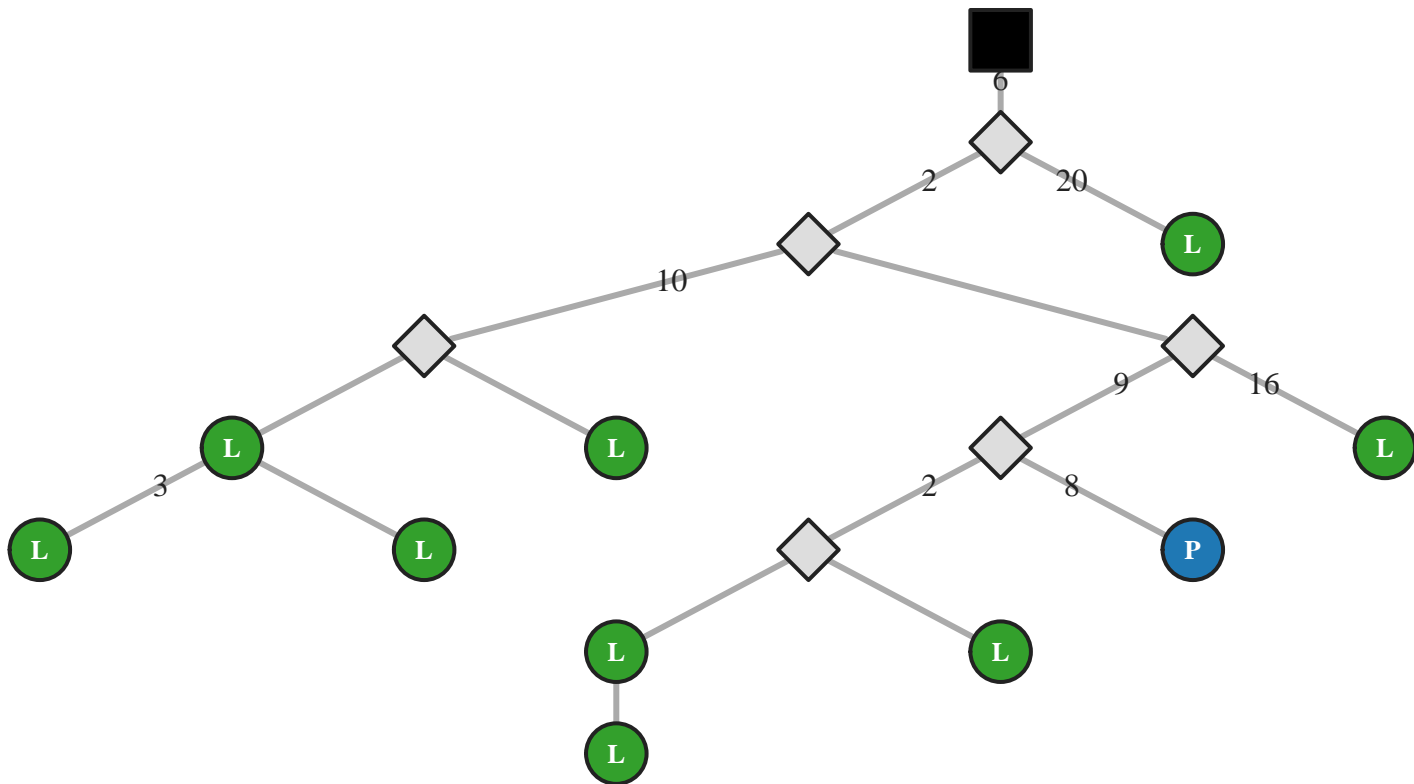

M5 IgG IGHV3-30/J4 54bp (34661)

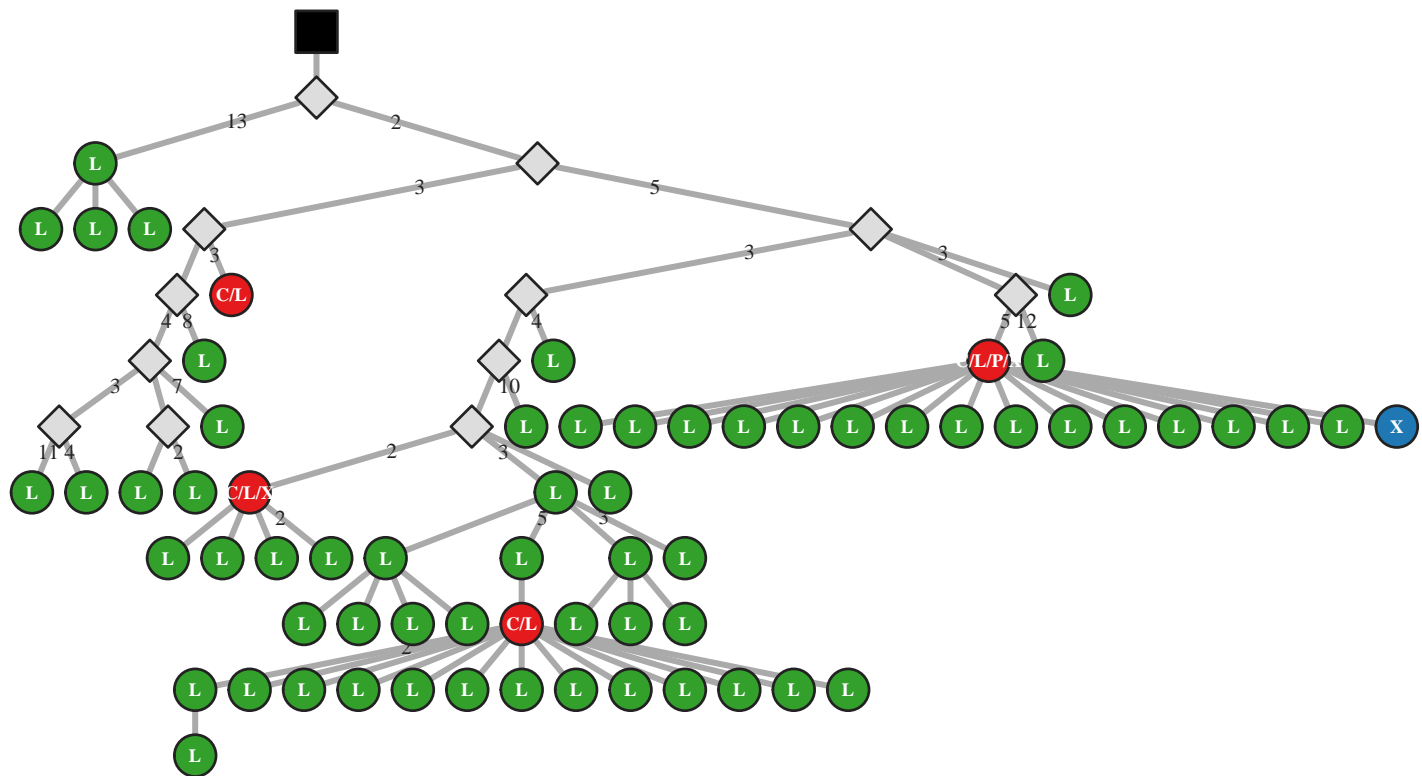

M5 IgG IGHV3-30/J4 54bp (34679)

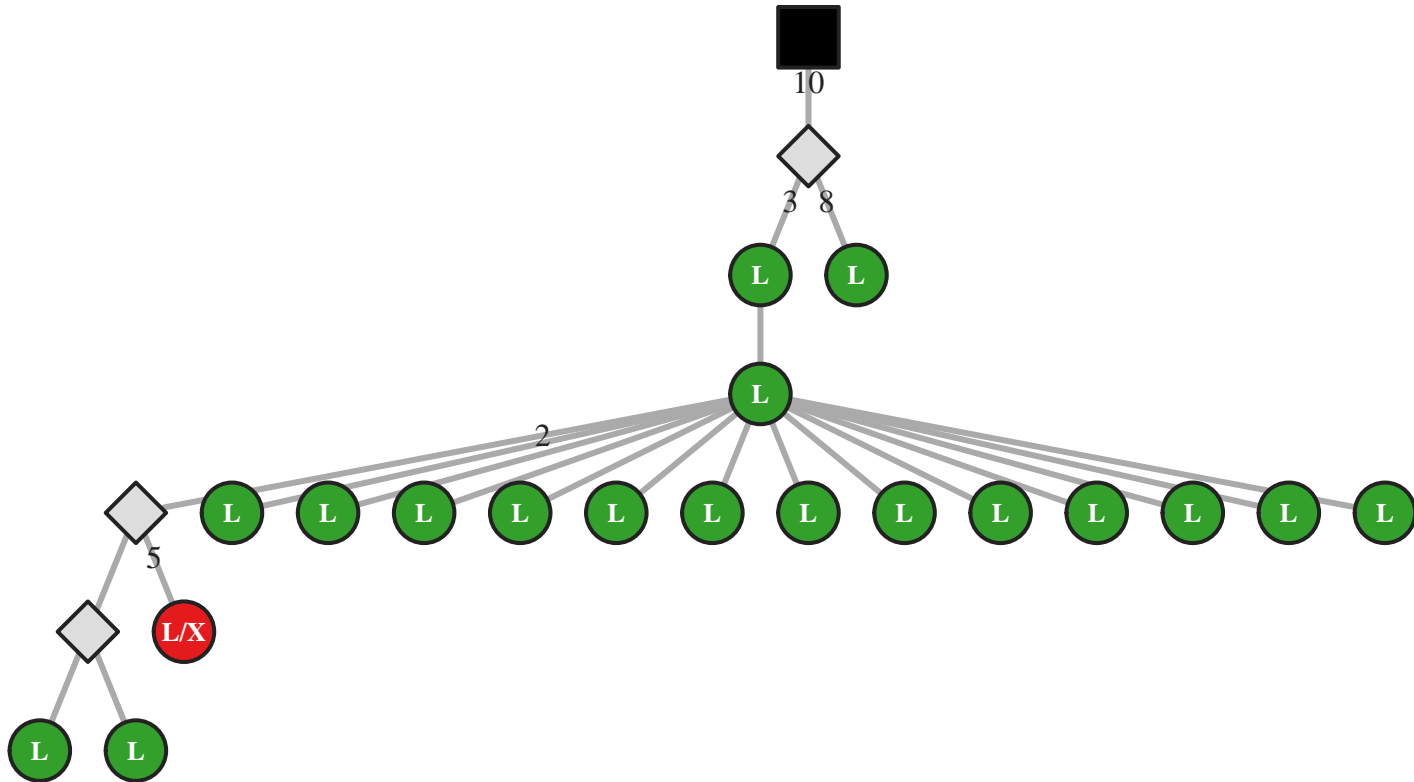

M5 IgG IGHV3-30/J4 54bp (34689)

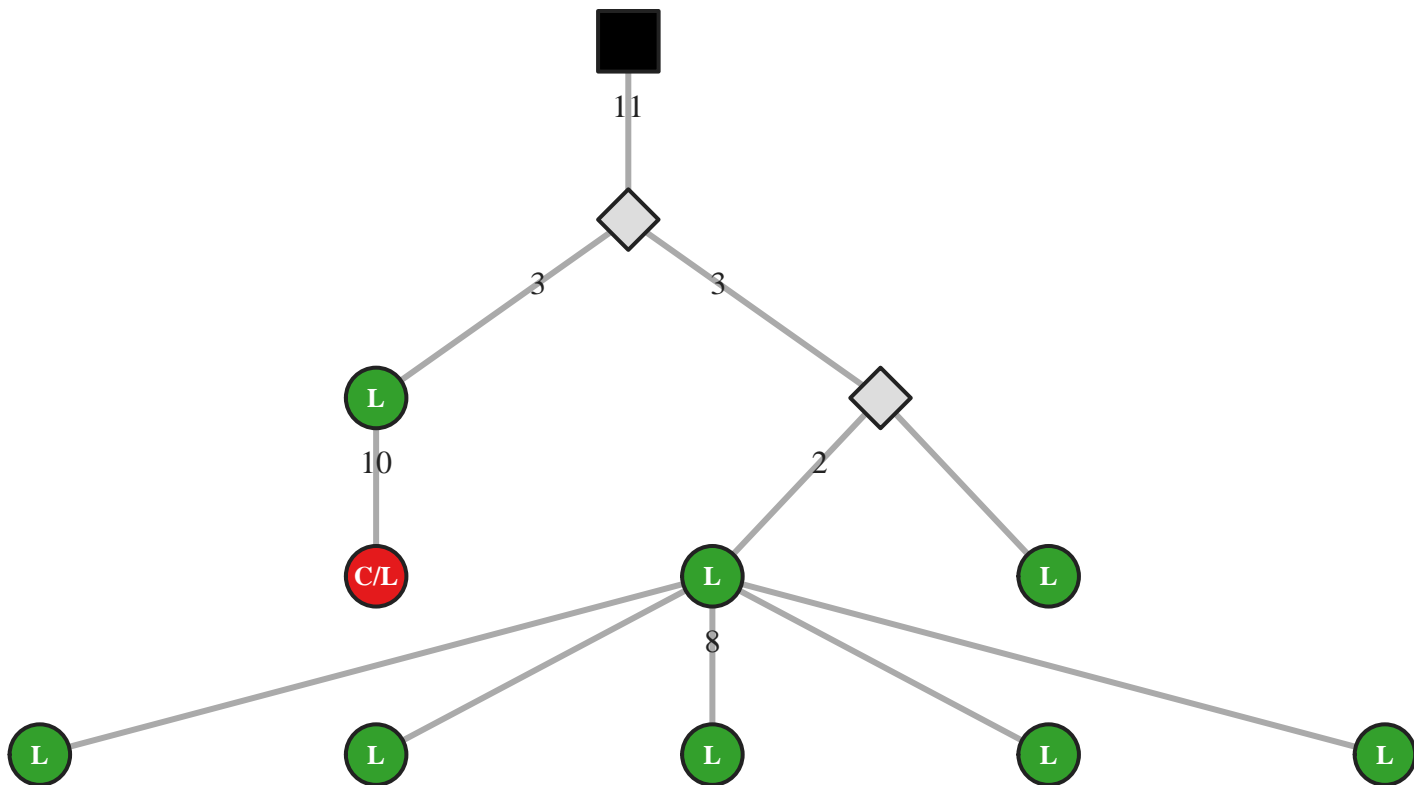

M5 IgG IGHV3-30/J4 54bp (34695)

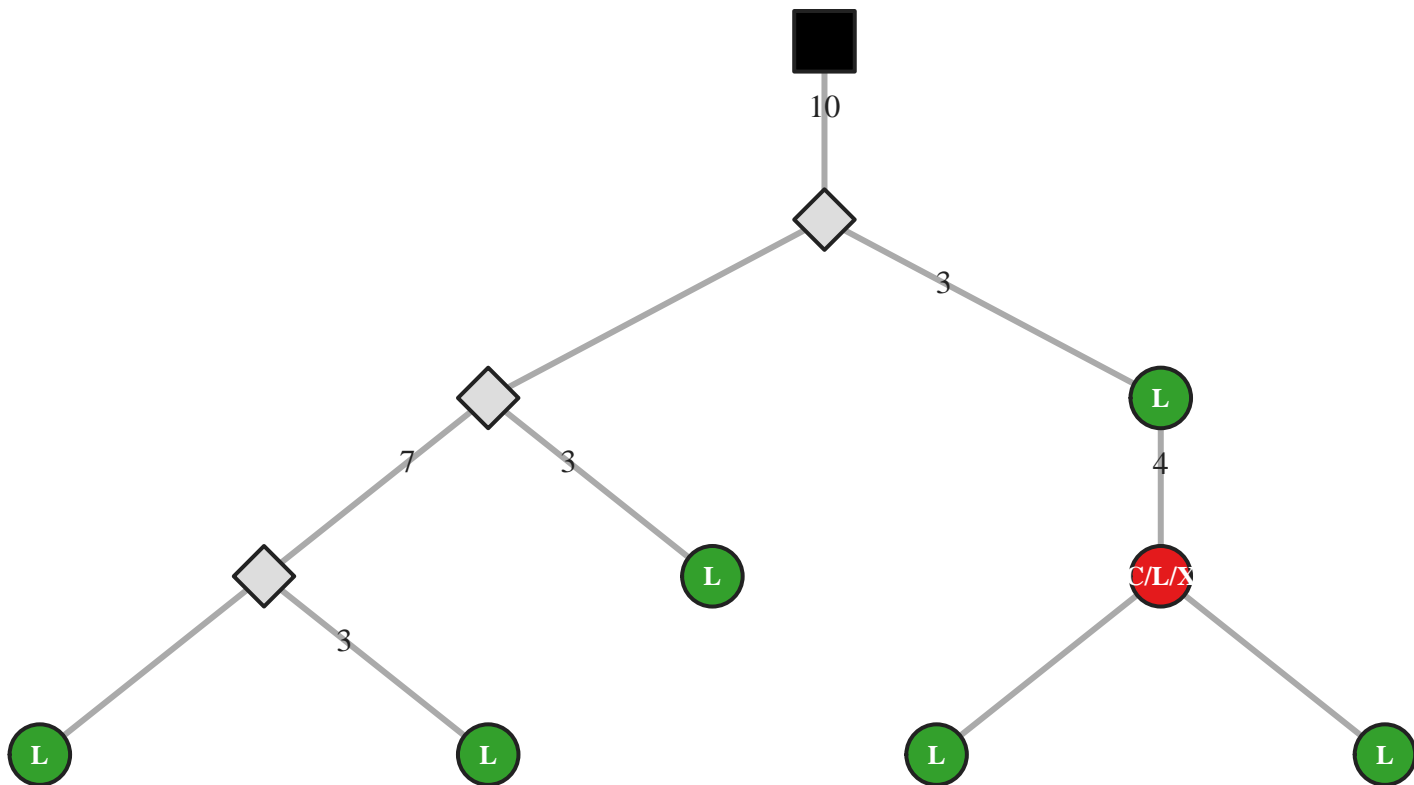

M5 IgA IGHV3-30/J4 57bp (2797)

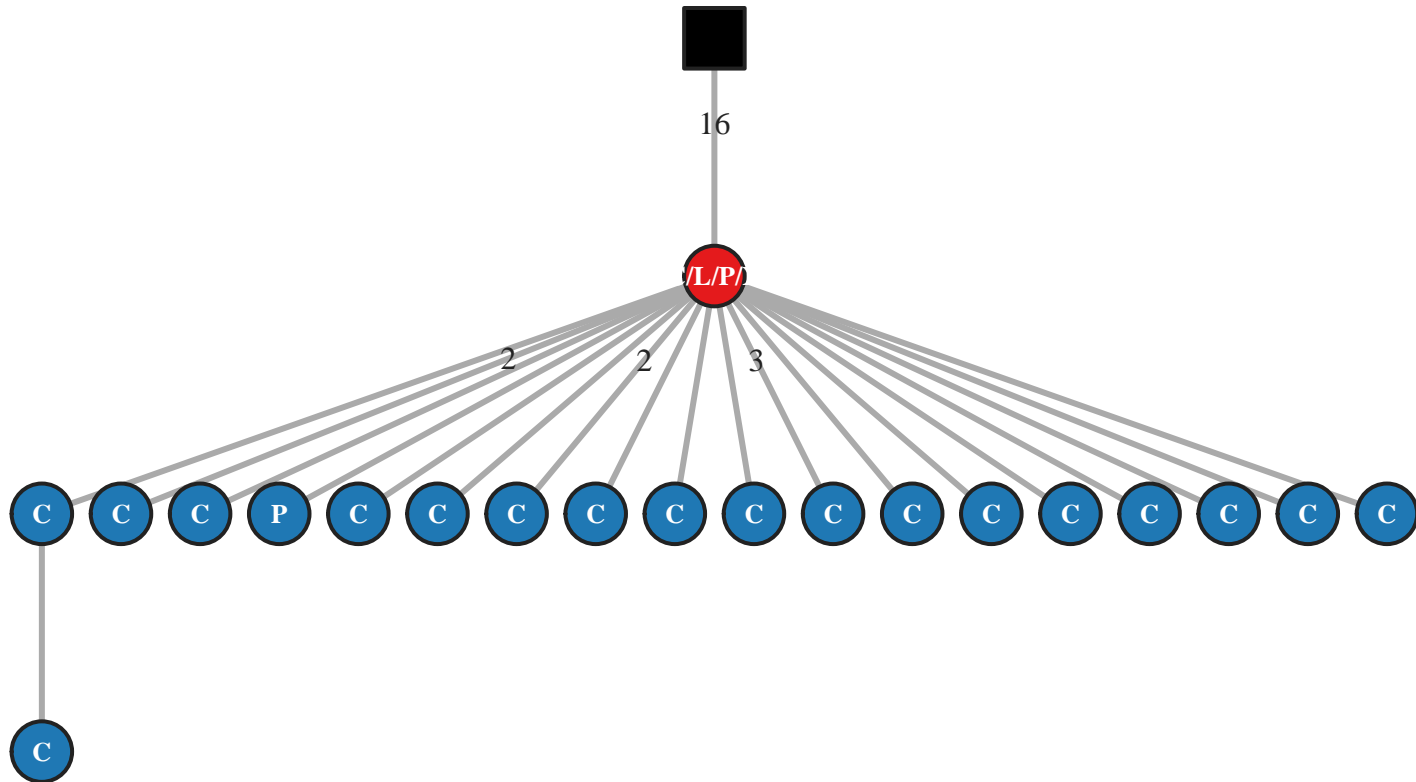

M5 IgG IGHV3-30/J4 57bp (17413)

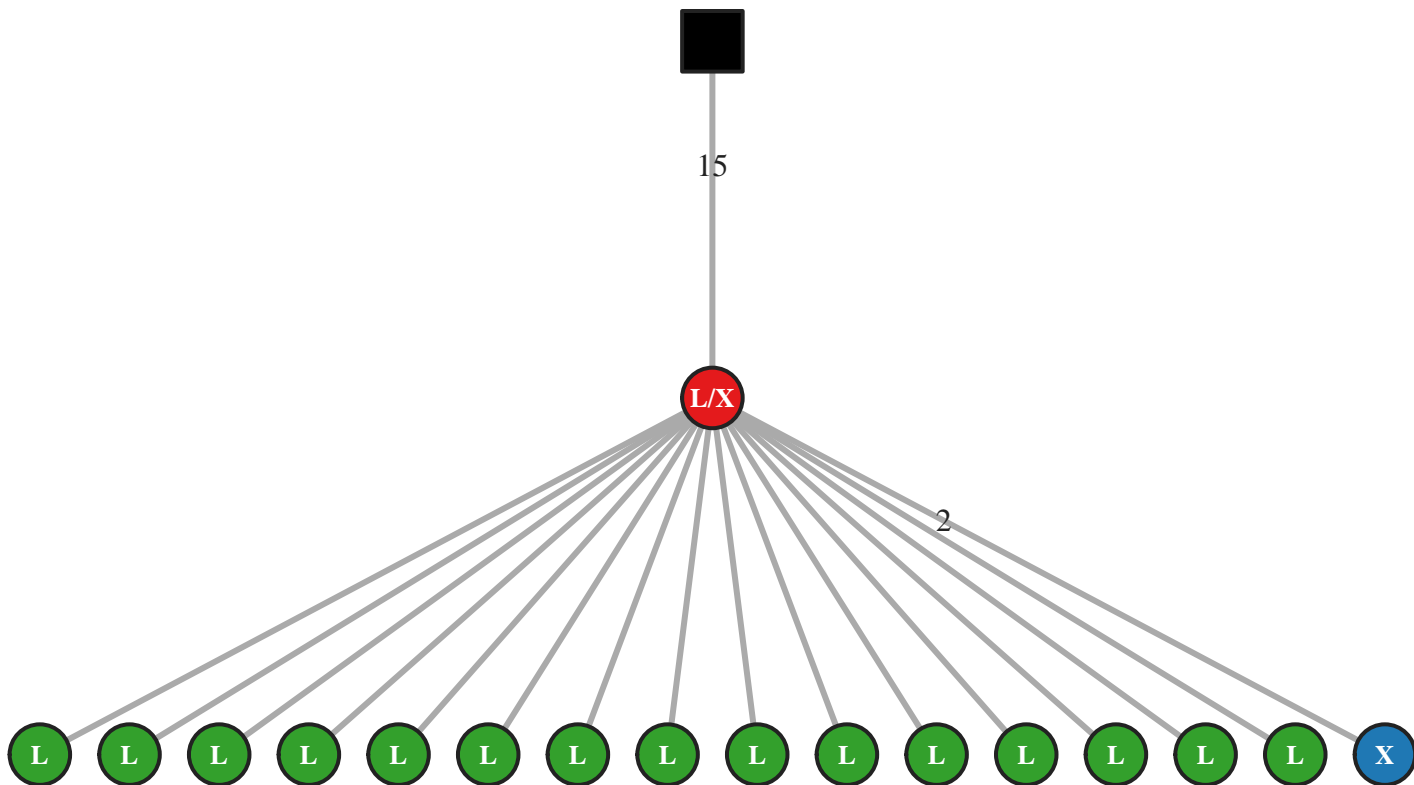

M5 IgG IGHV3-30/J4 57bp (17462)

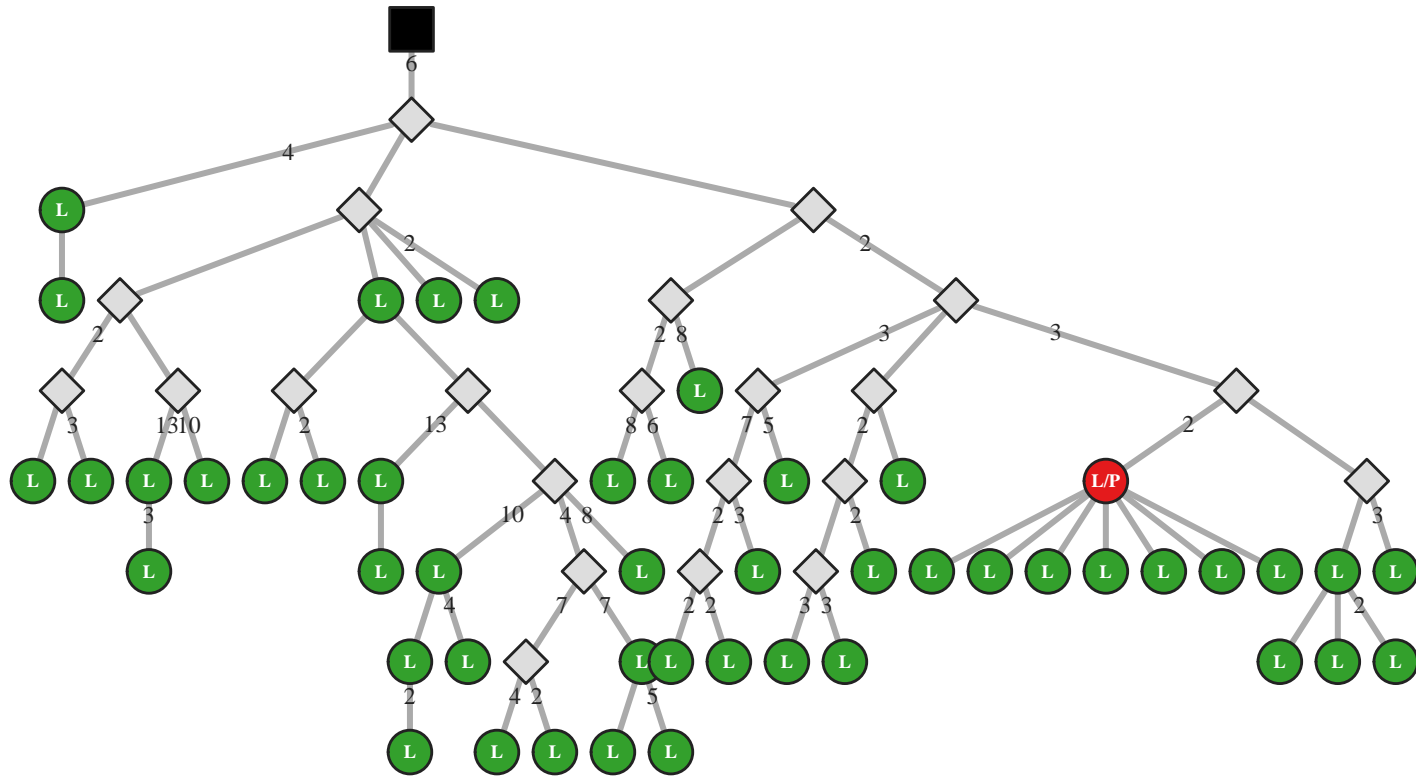

M5 IgA IGHV3-30/J4 60bp (12404)

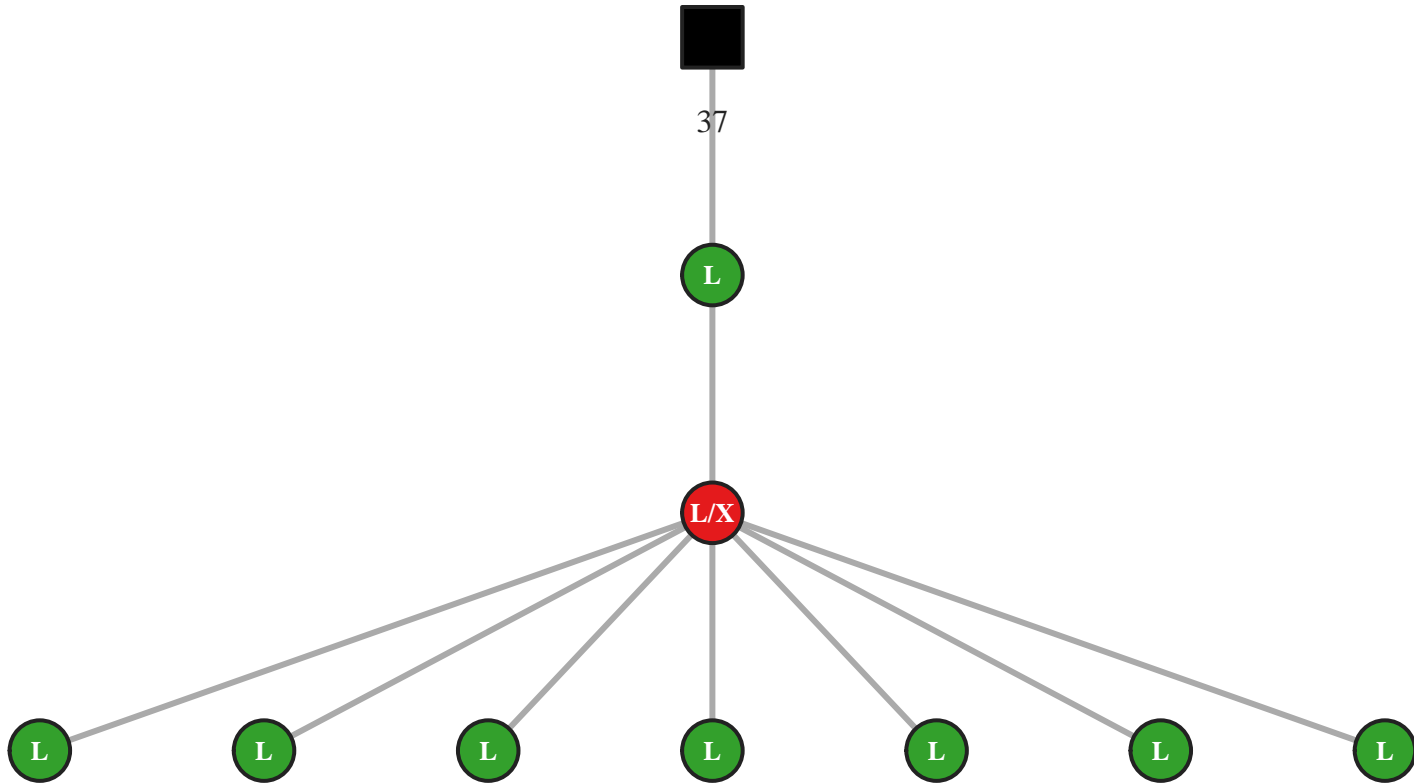

M5 IgG IGHV3-30/J4 60bp (25935)

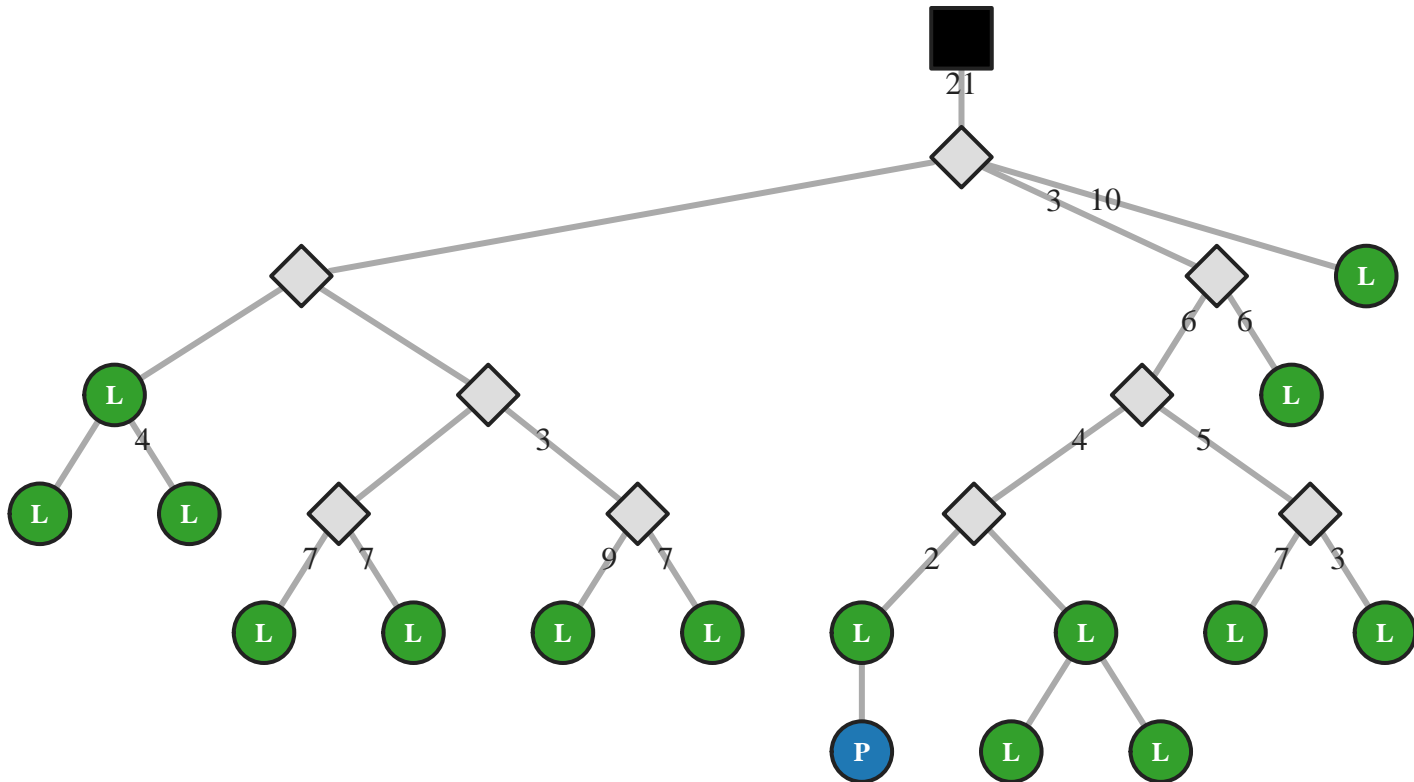

M5 IgG IGHV3-30/J4 60bp (25936)

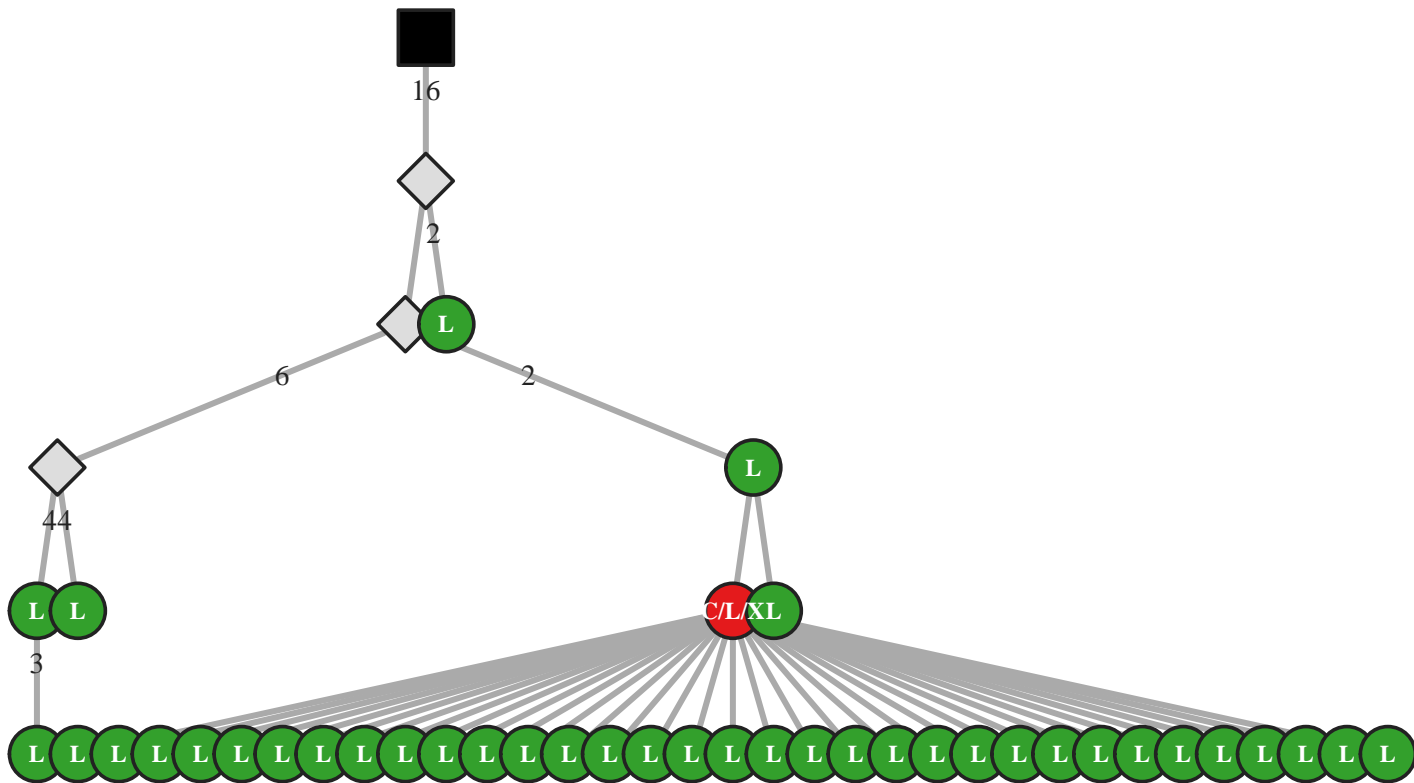

M5 IgG IGHV3-30/J4 60bp (25953)

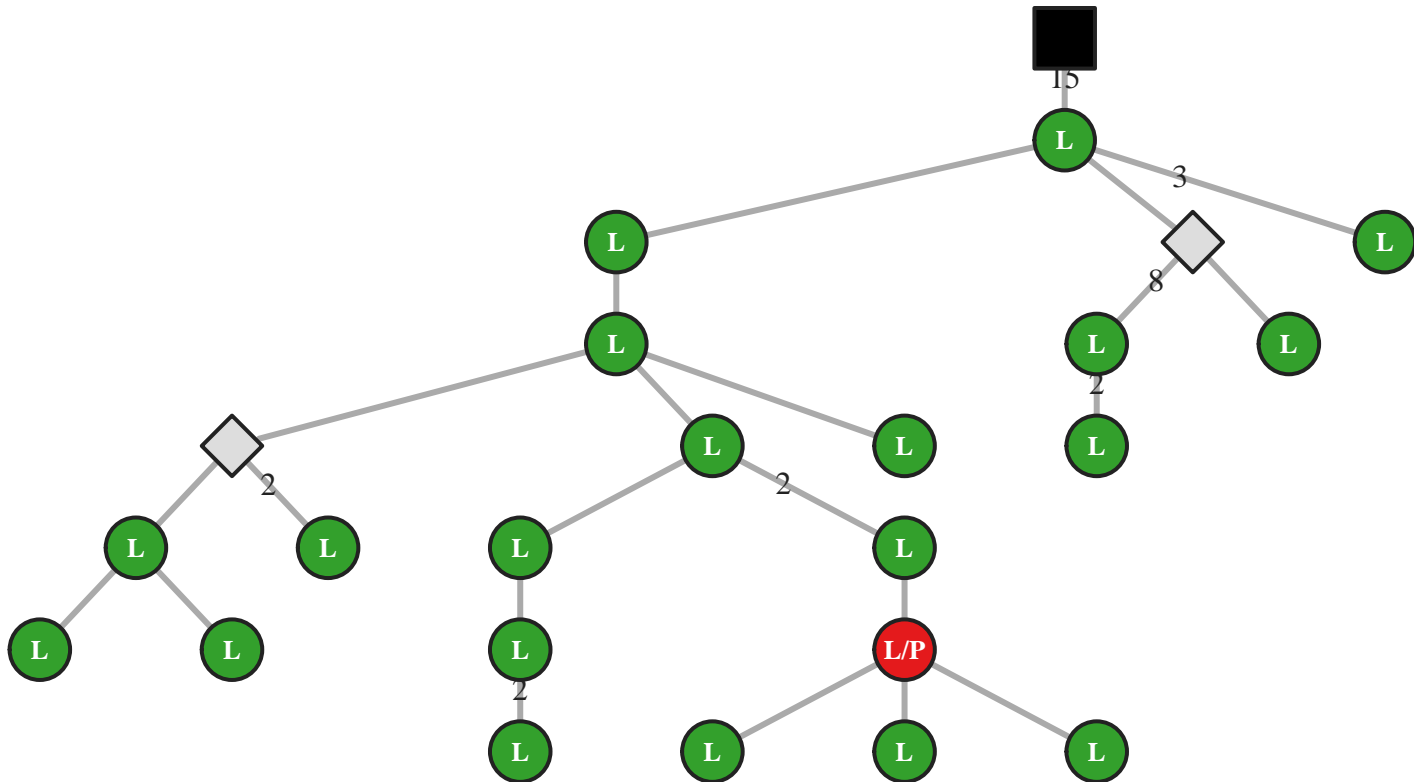

M5 IgG IGHV3-30/J4 60bp (25957)

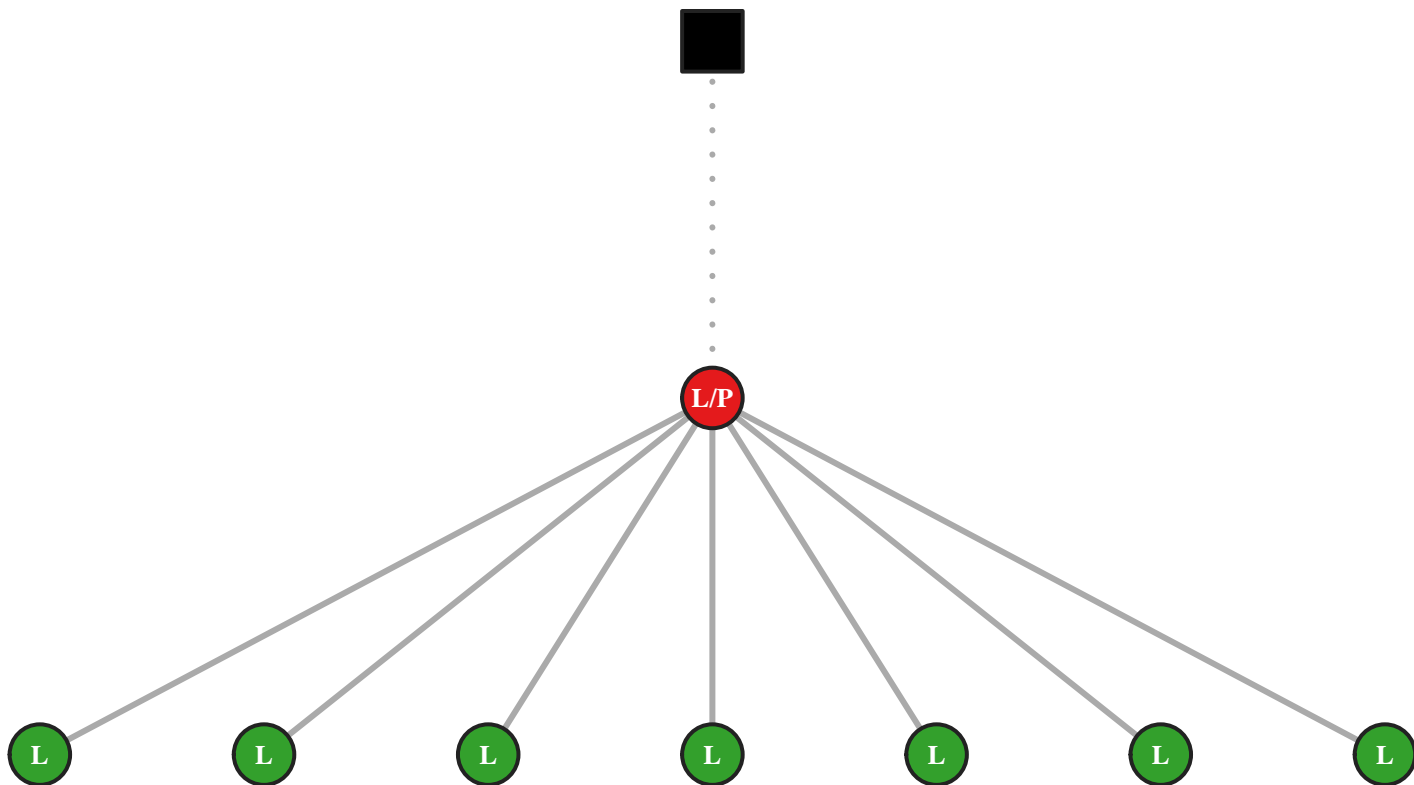

M5 IgG IGHV3-30/J4 60bp (25980)

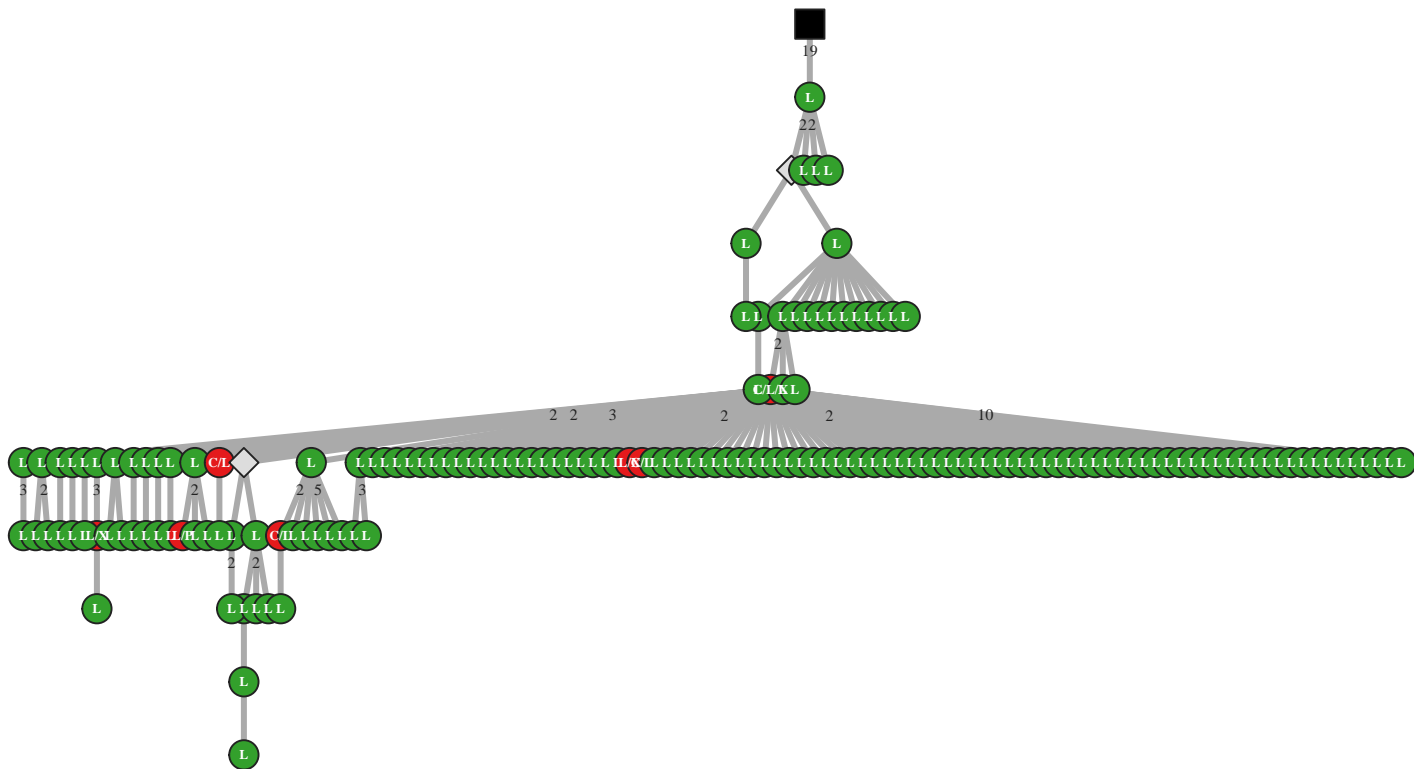

M5 IgG IGHV3-30/J4 60bp (26010)

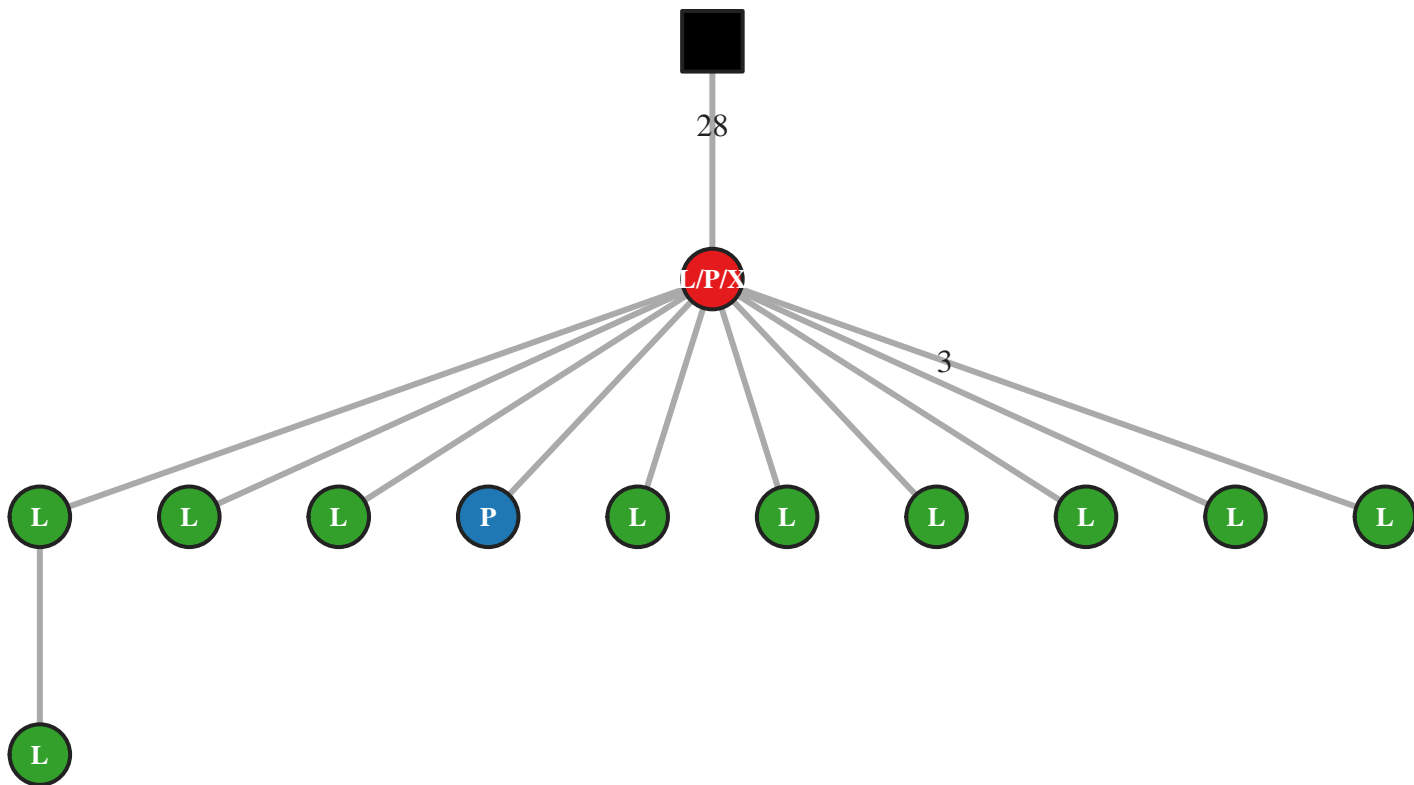

M5 IgG IGHV3-30/J4 60bp (26013)

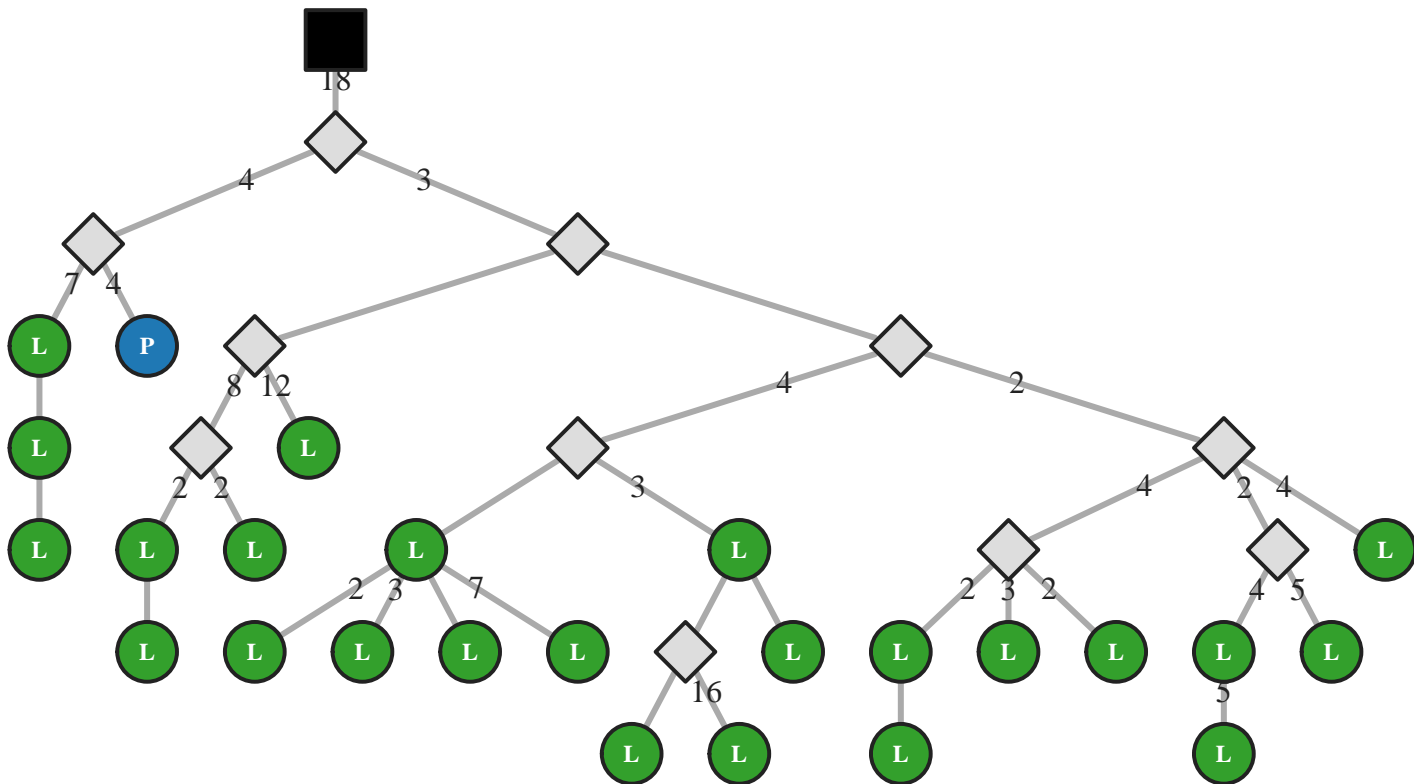

M5 IgG IGHV3-30/J4 63bp (7766)

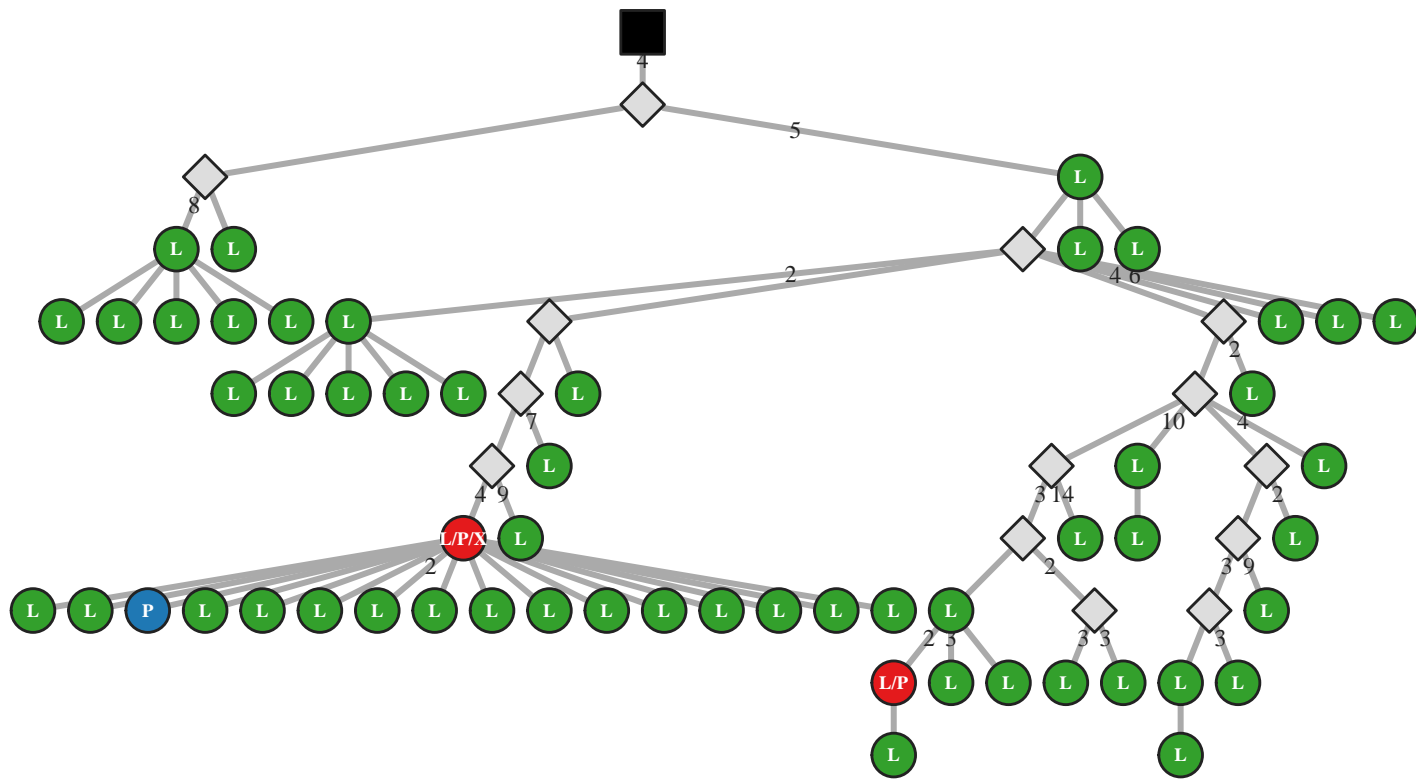

M5 IgG IGHV3-30/J4 63bp (7786)

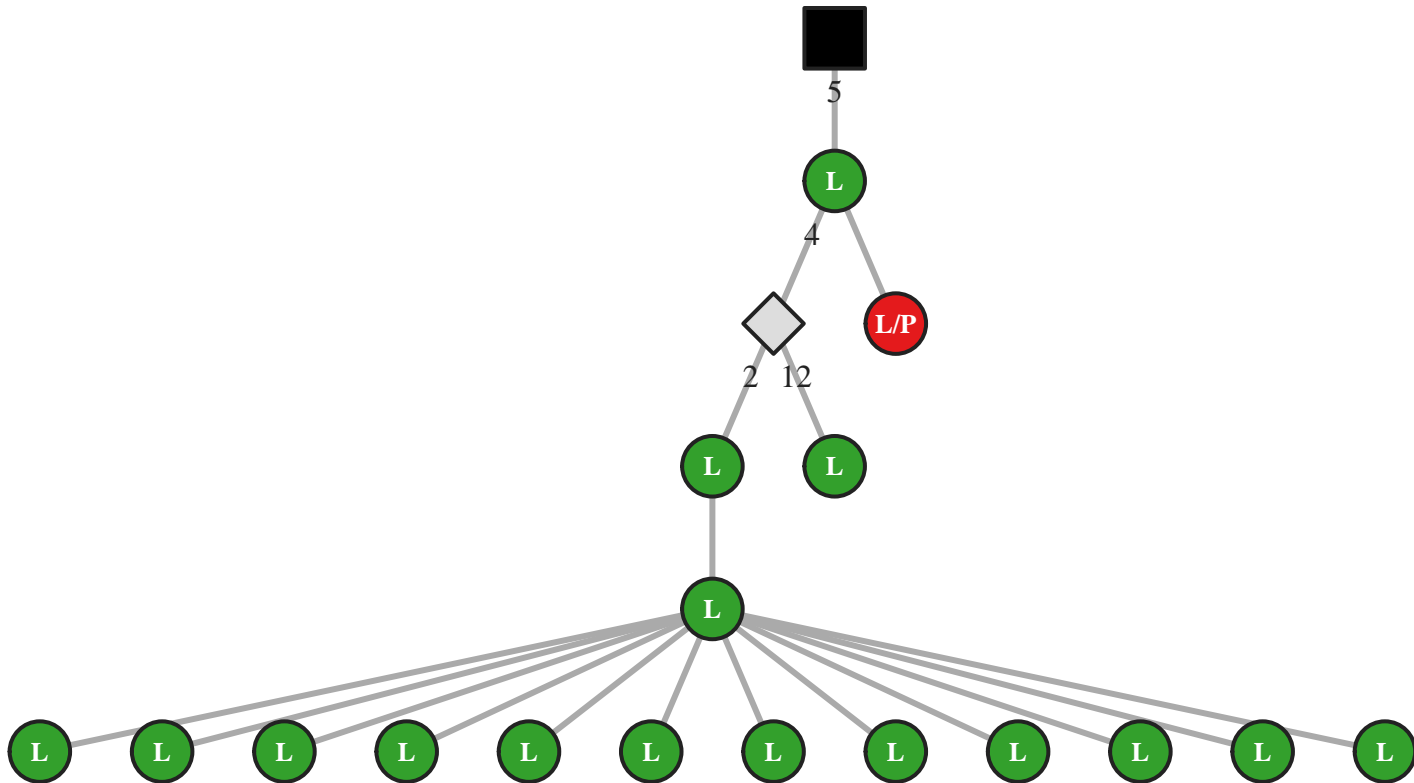

M5 IgG IGHV3-30/J4 63bp (7842)

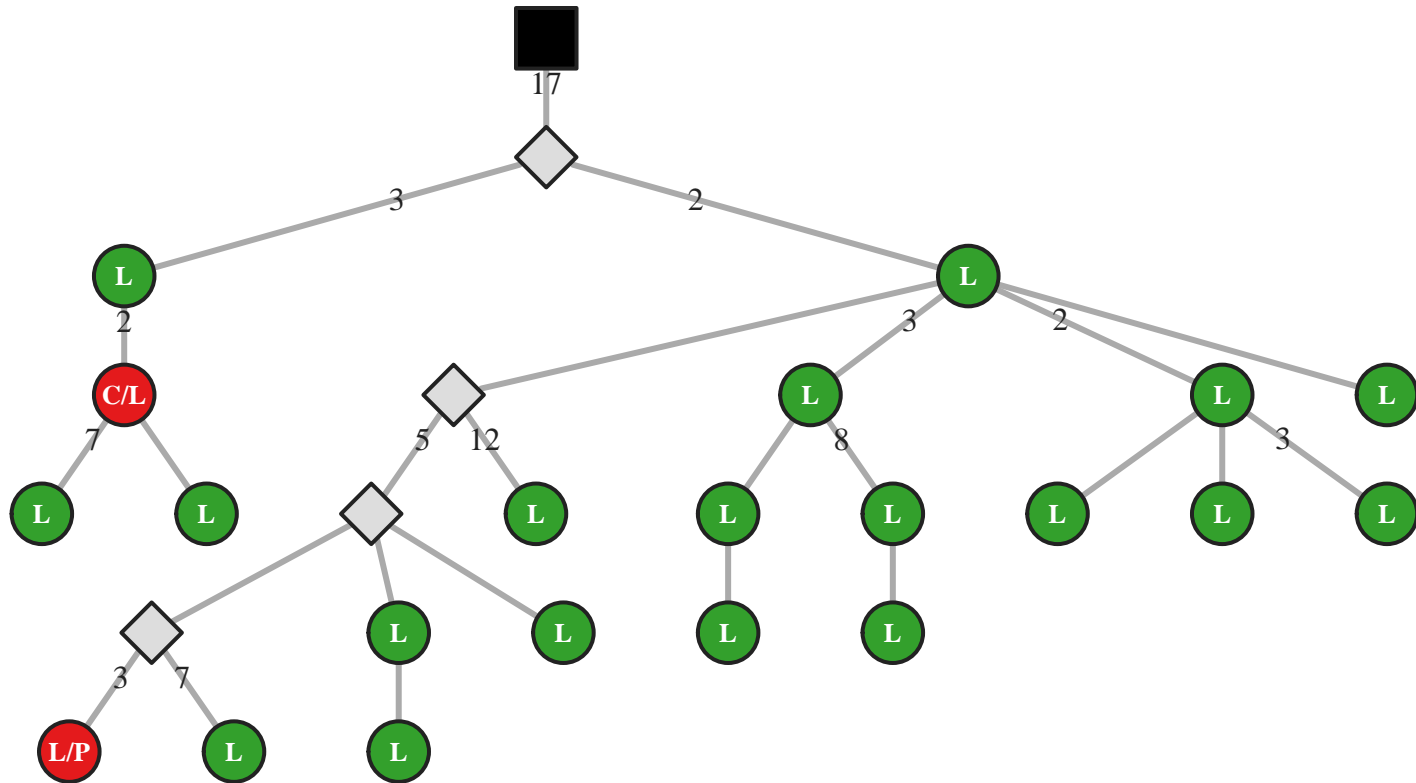

M5 IgG IGHV3-30/J4 66bp (26498)

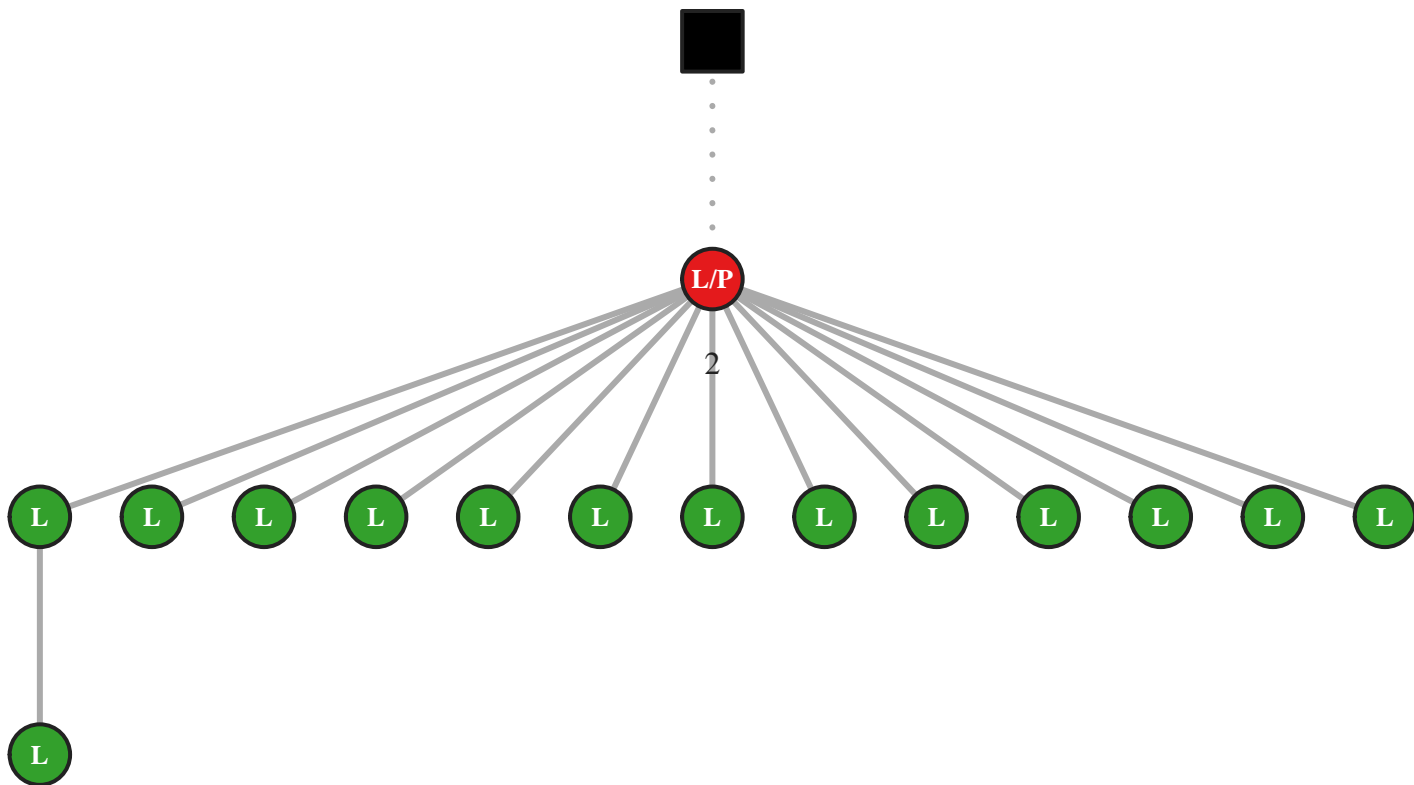

M5 IgG IGHV3-30/J4 66bp (26521)

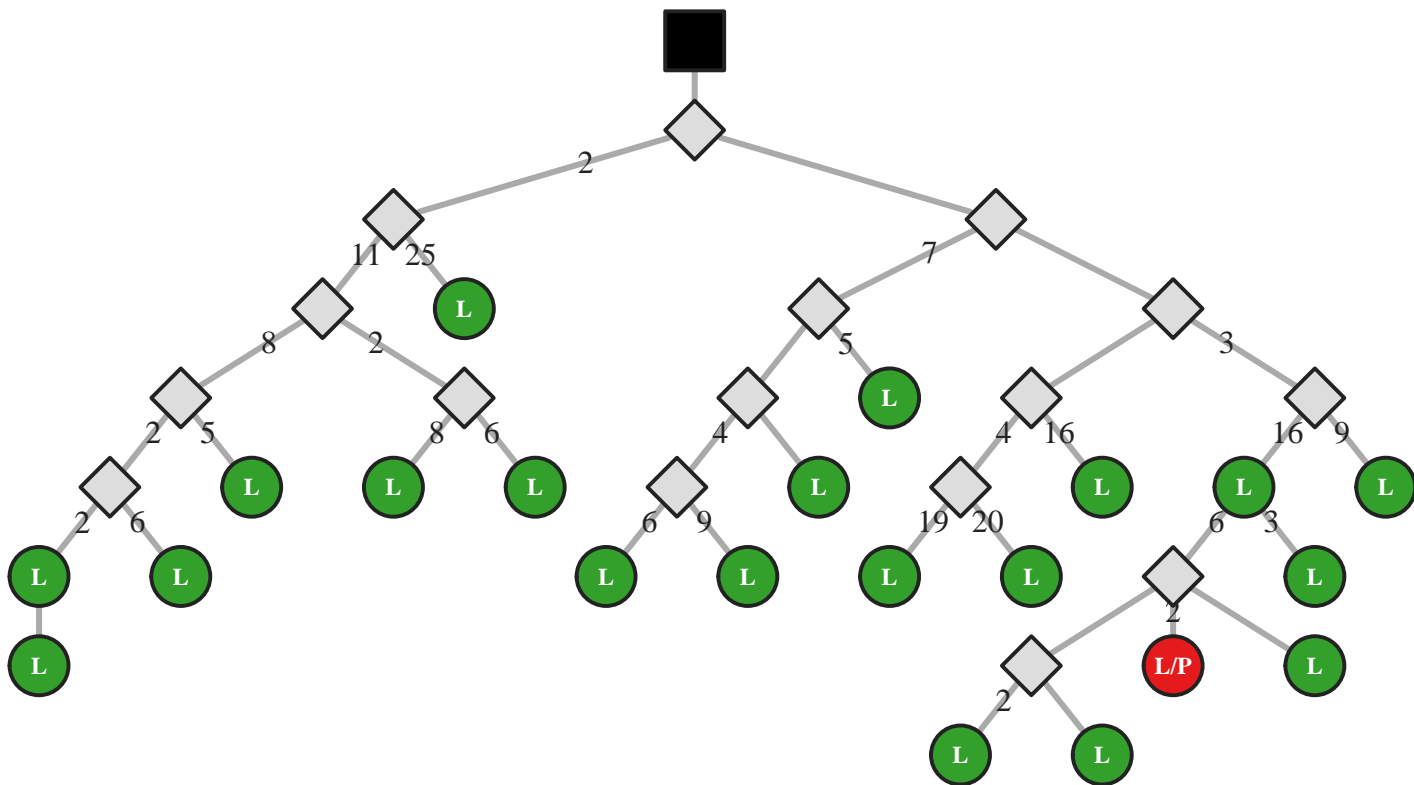

M5 IgG IGHV3-30/J4 69bp (17477)

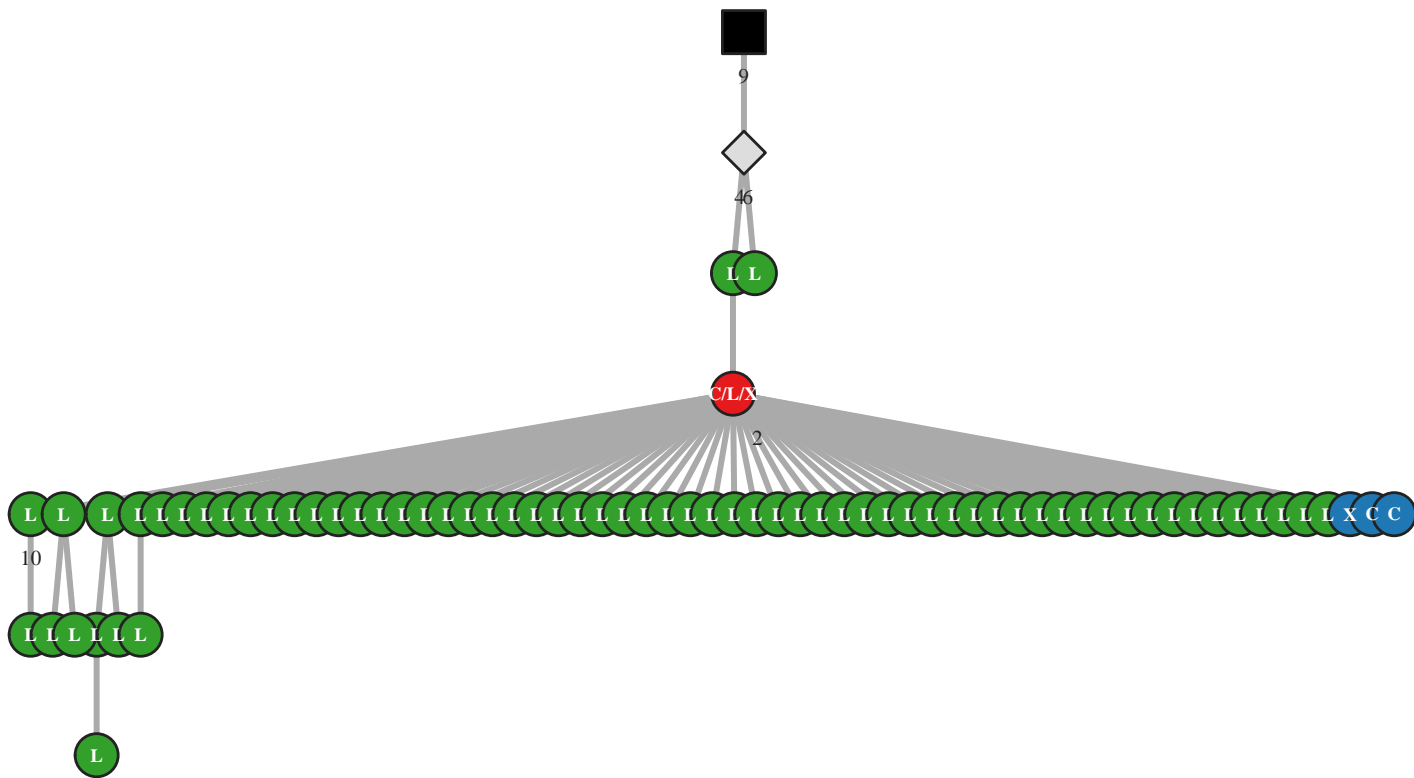

M5 IgG IGHV3-30/J5 21bp (35084)

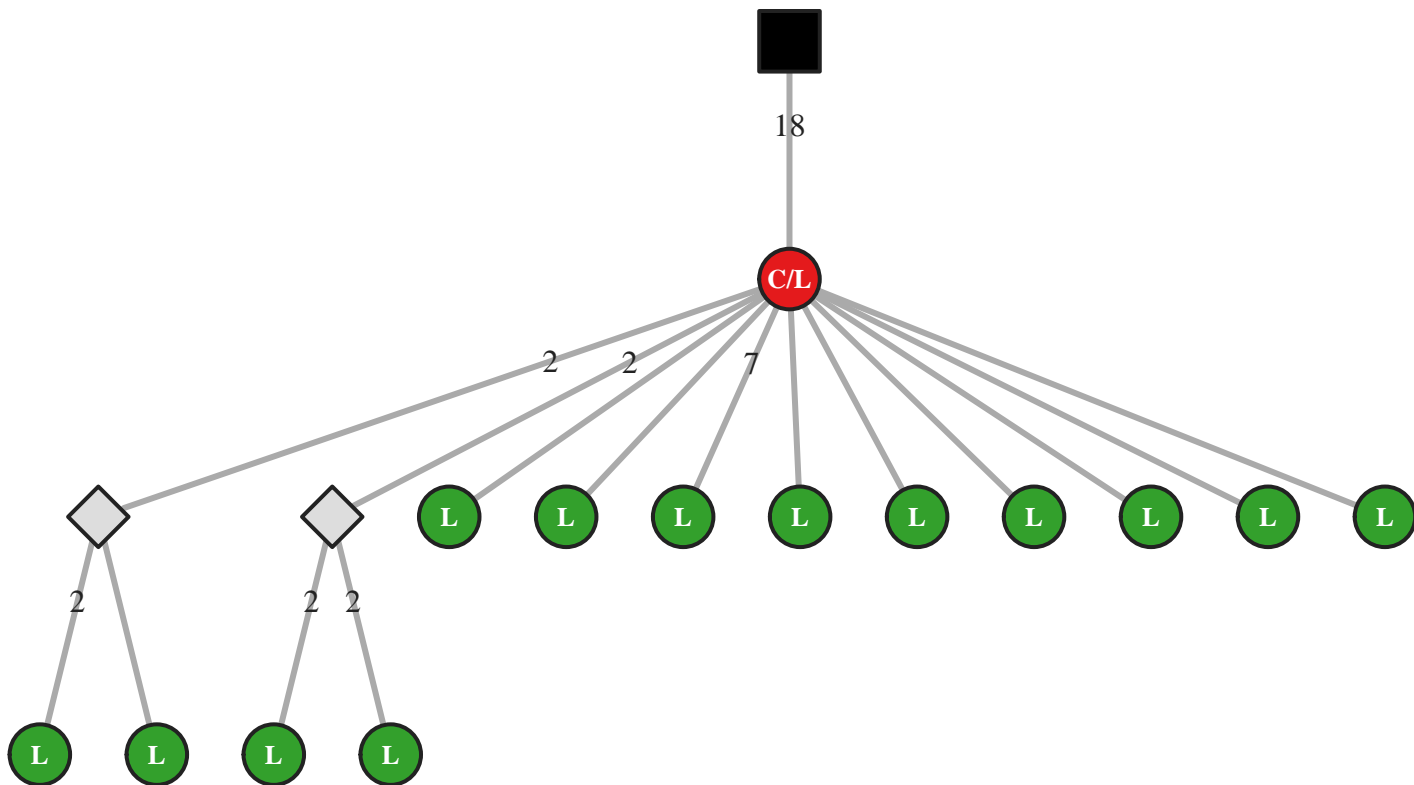

M5 IgG IGHV3-30/J5 24bp (51803)

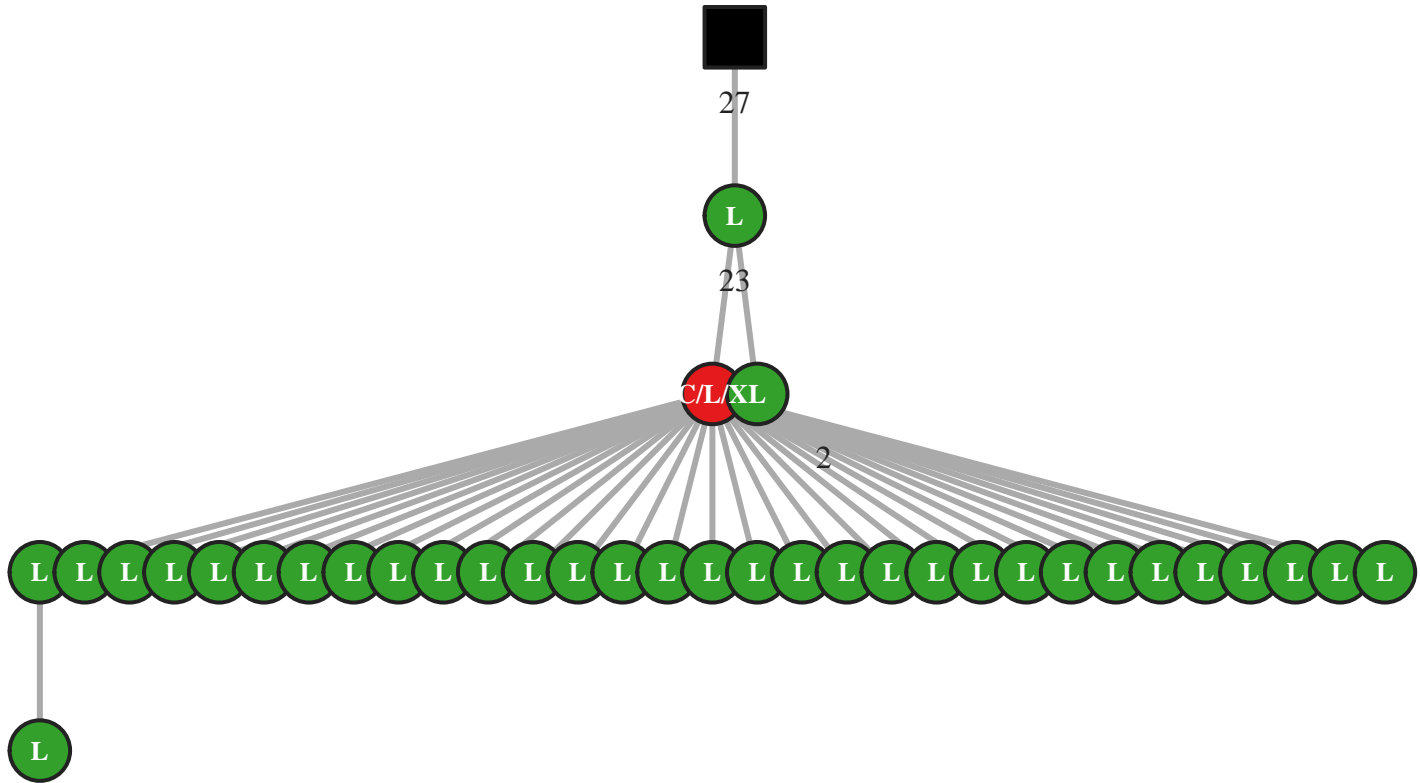

M5 IgG IGHV3-30/J5 39bp (17661)

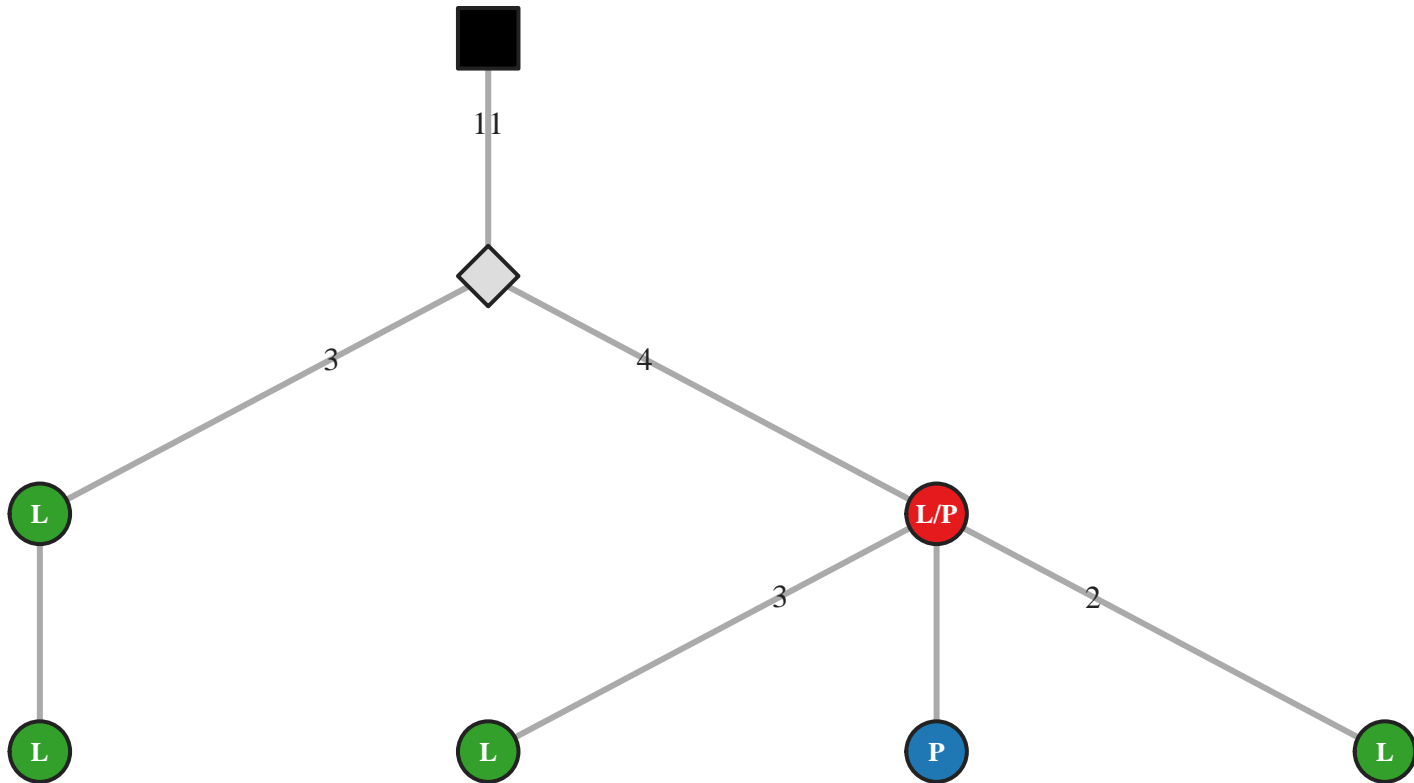

M5 IgG IGHV3-30/J5 39bp (17664)

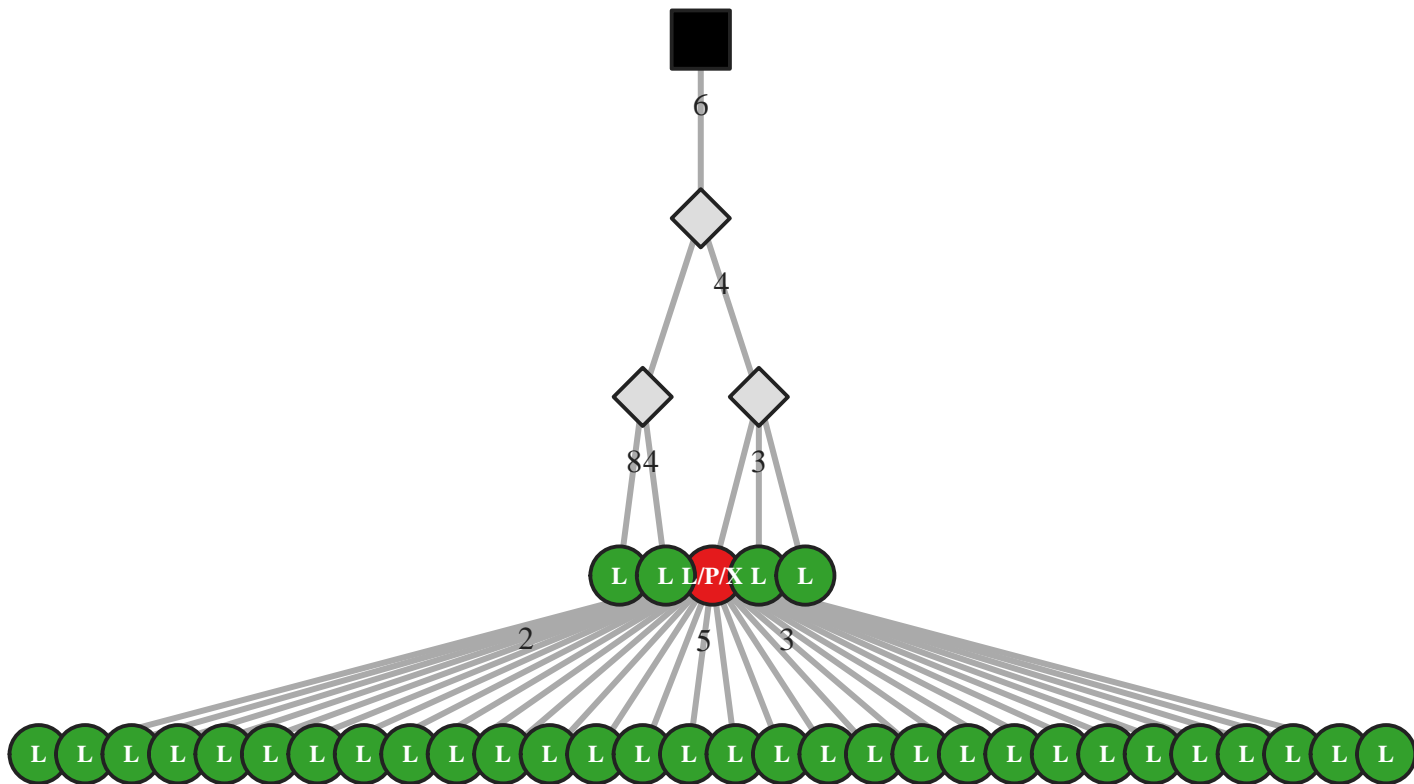

M5 IgG IGHV3-30/J5 42bp (35002)

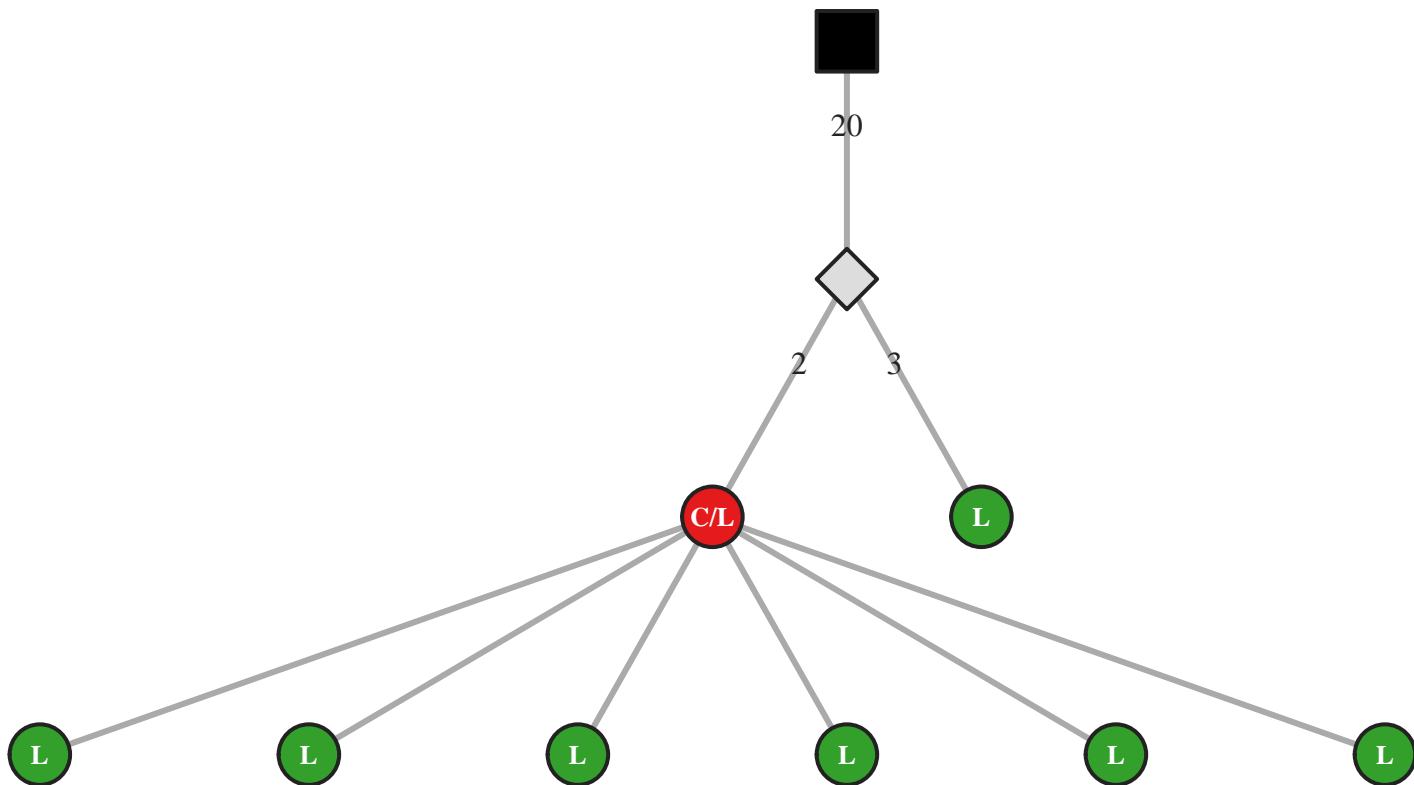

M5 IgG IGHV3-30/J5 48bp (44593)

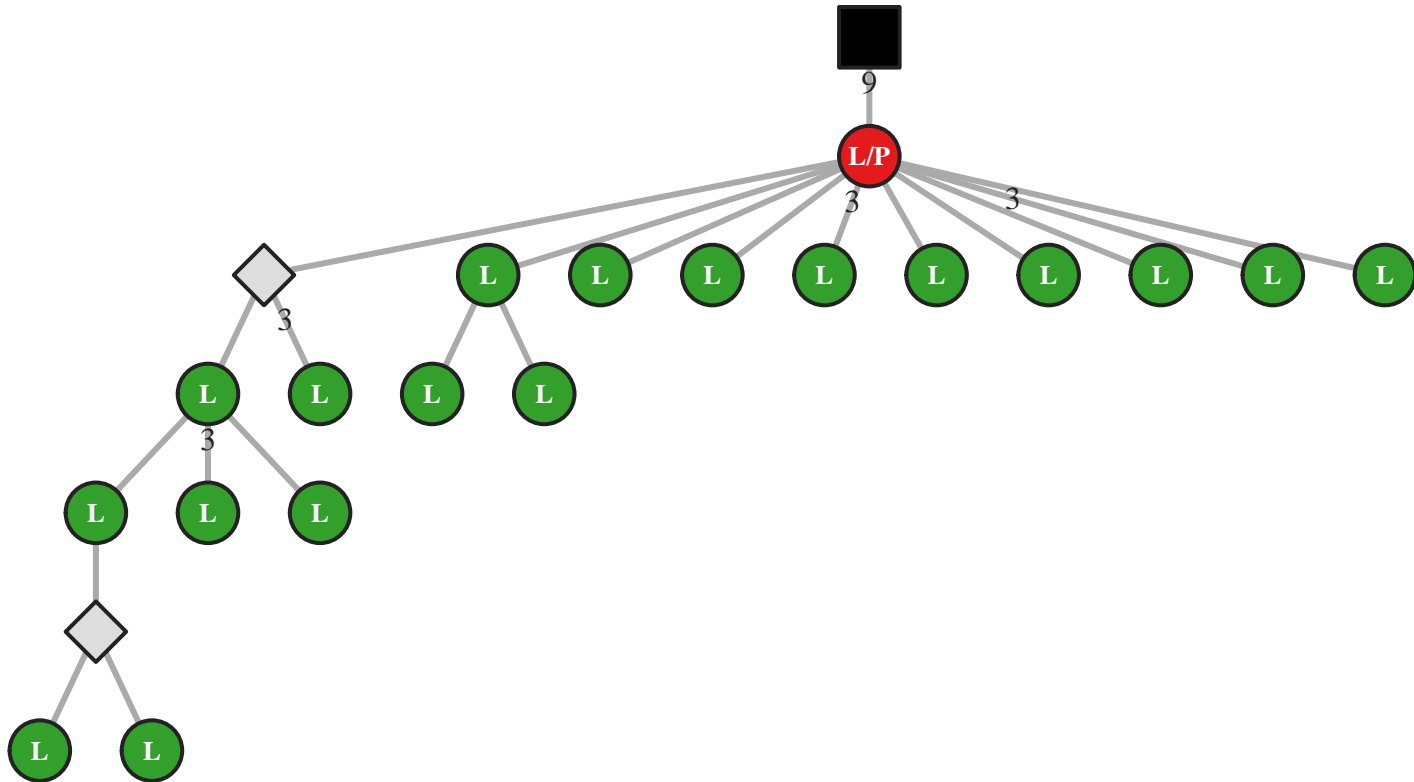

M5 IgG IGHV3-30/J5 48bp (44602)

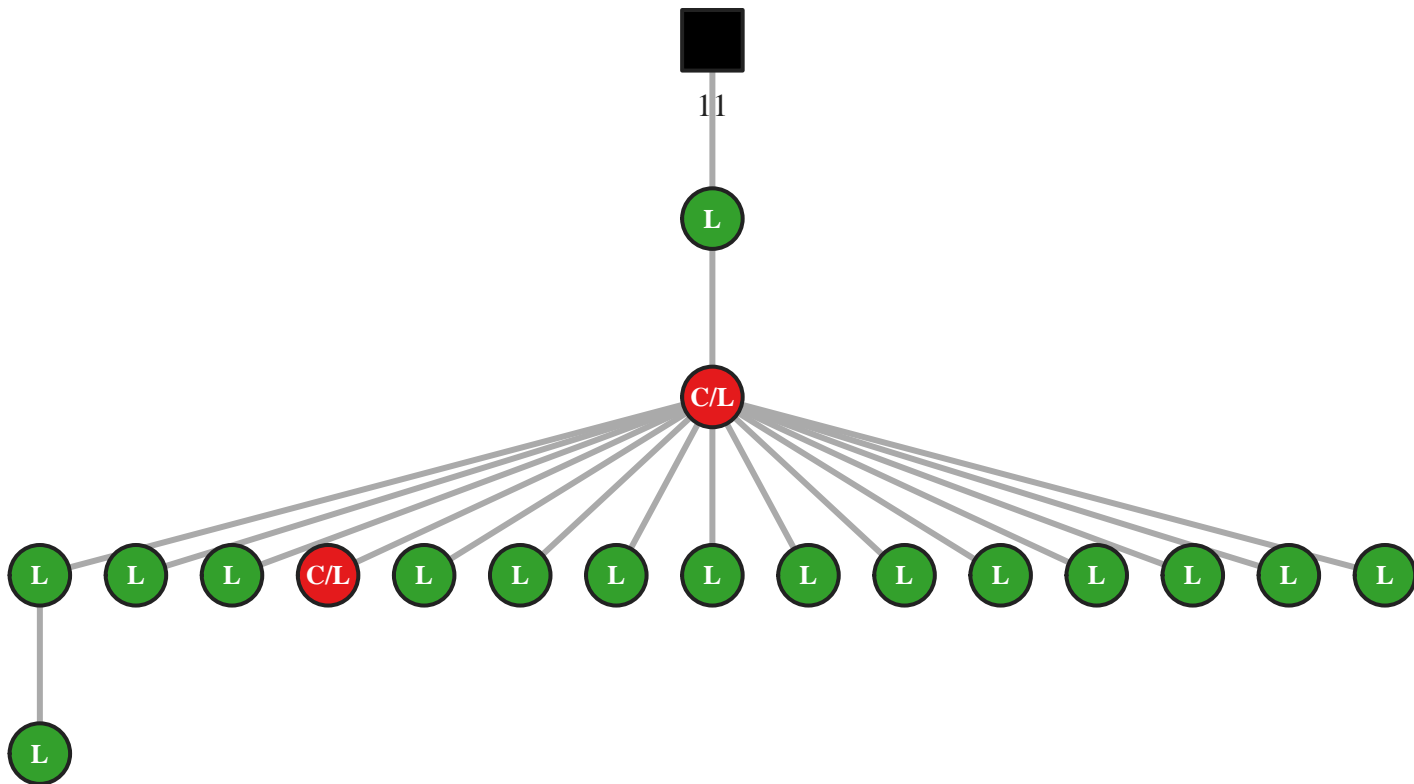

M5 IgG IGHV3-30/J5 54bp (26184)

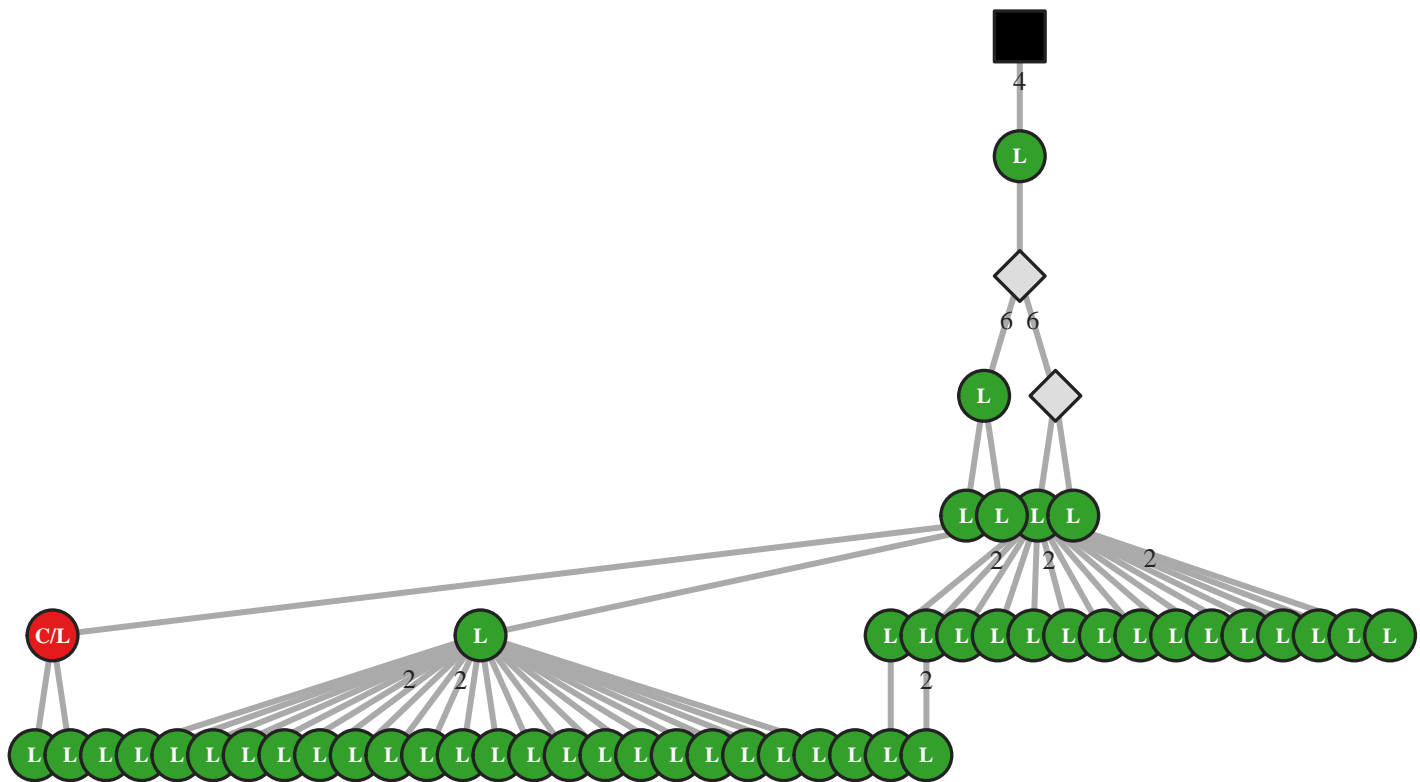

M5 IgG IGHV3-30/J6 33bp (8029)

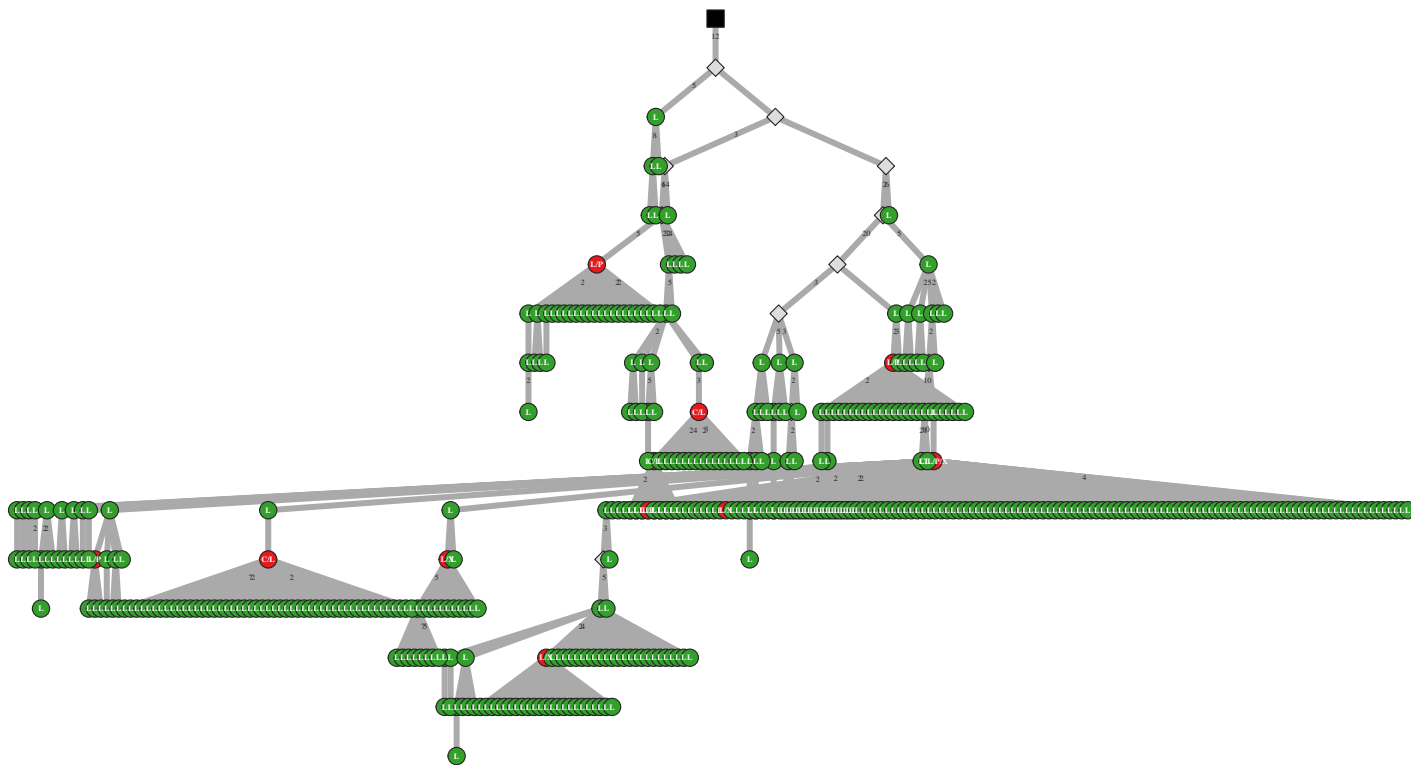

M5 IgA IGHV3-30/J6 39bp (30566)

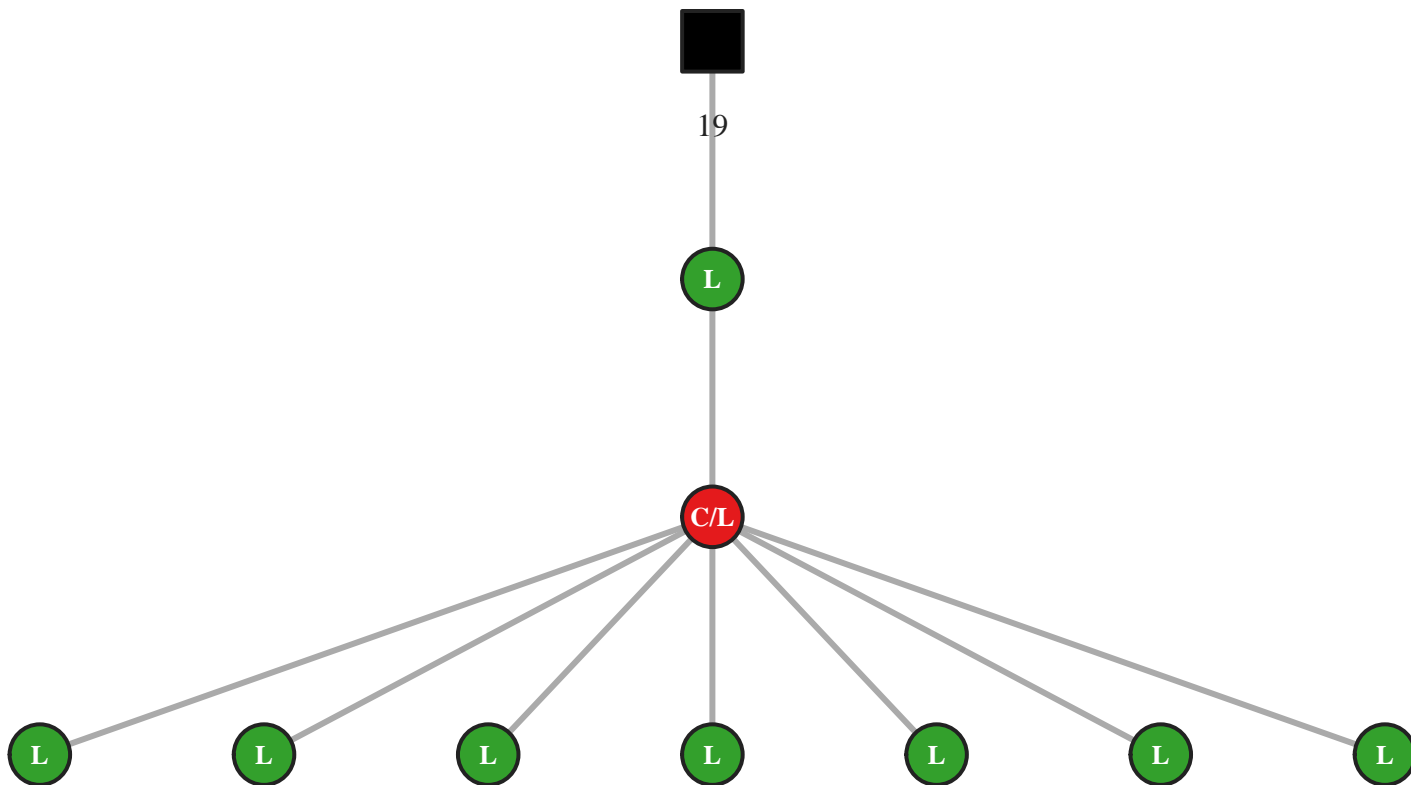

M5 IgG IGHV3-30/J6 48bp (26544)

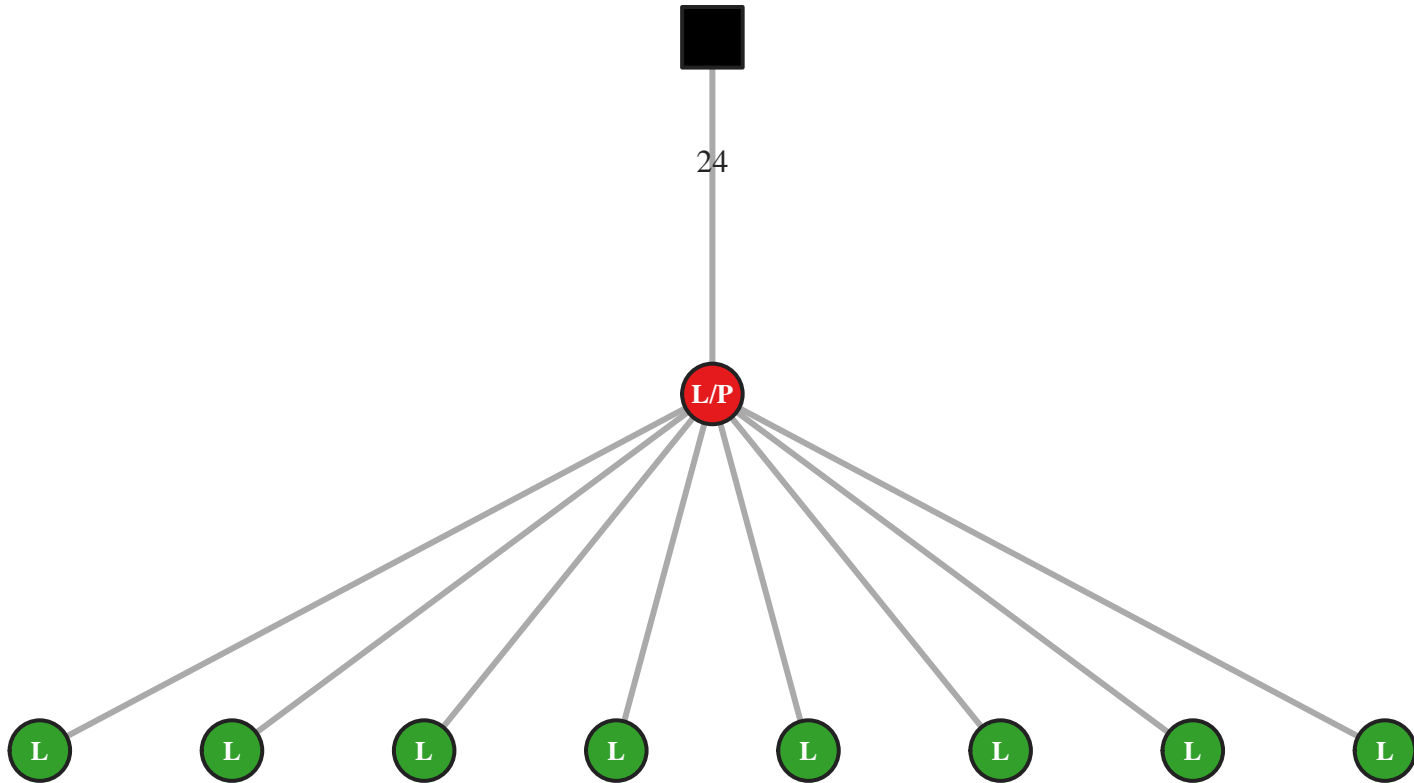

M5 IgA IGHV3-30/J6 51bp (2903)

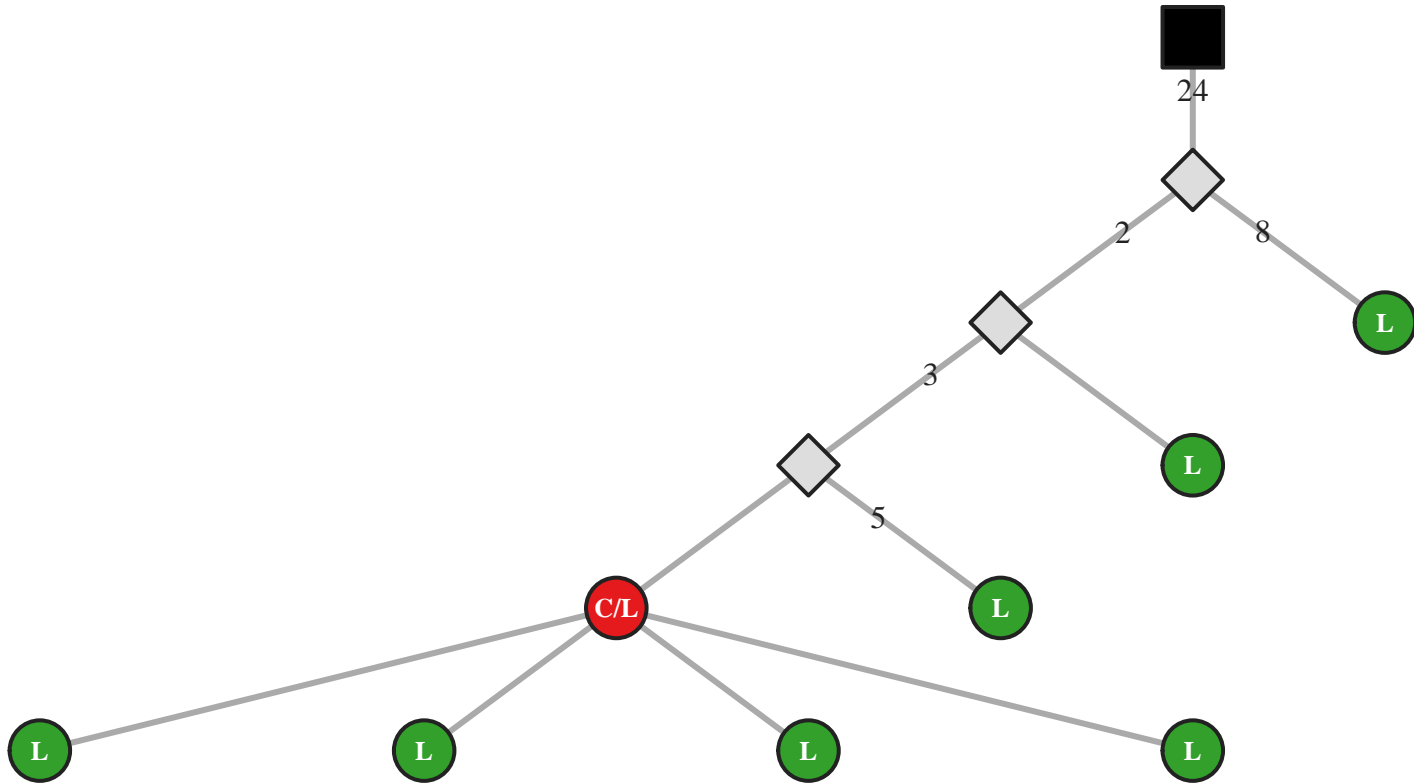

M5 IgA IGHV3-30/J6 51bp (2904)

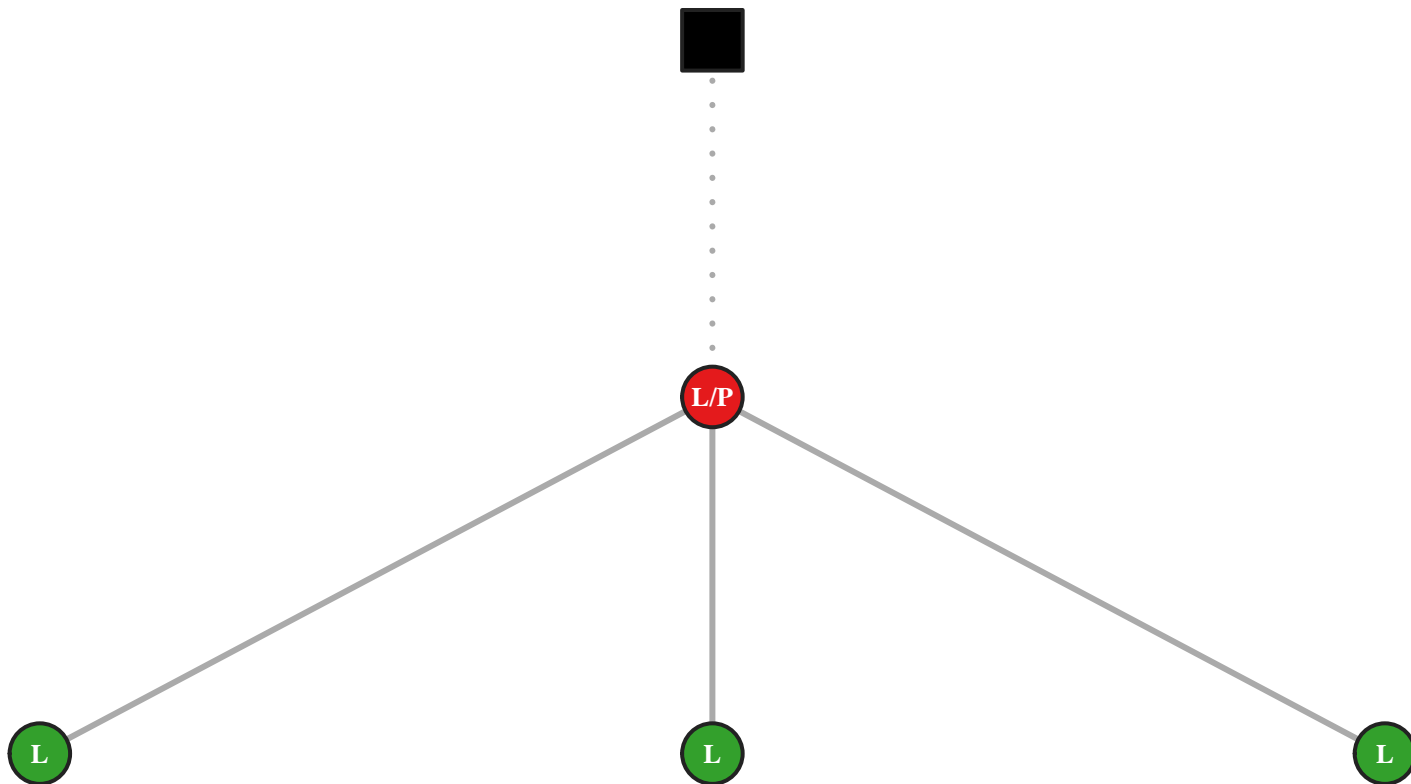

M5 IgG IGHV3-30/J6 51bp (44815)

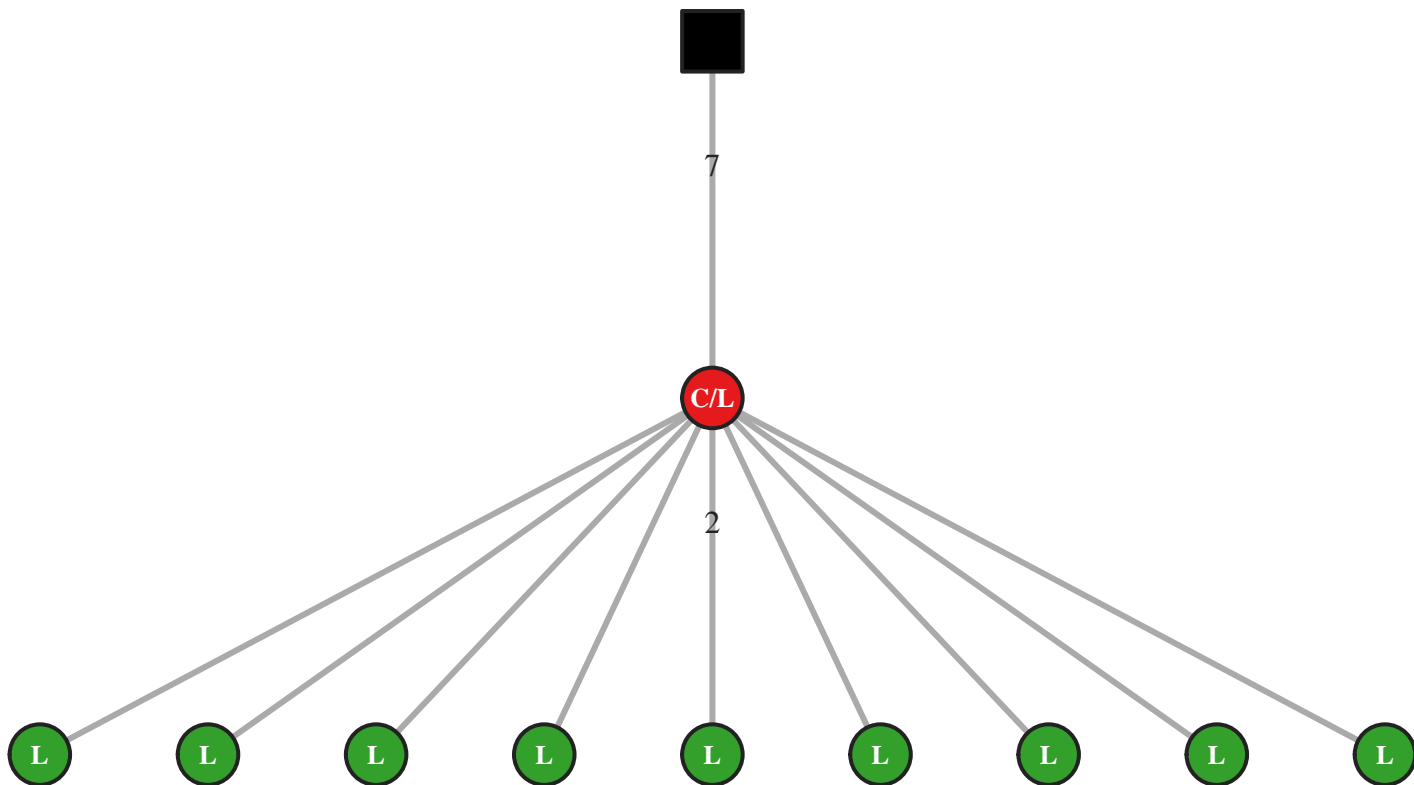

M5 IgG IGHV3-30/J6 51bp (44832)

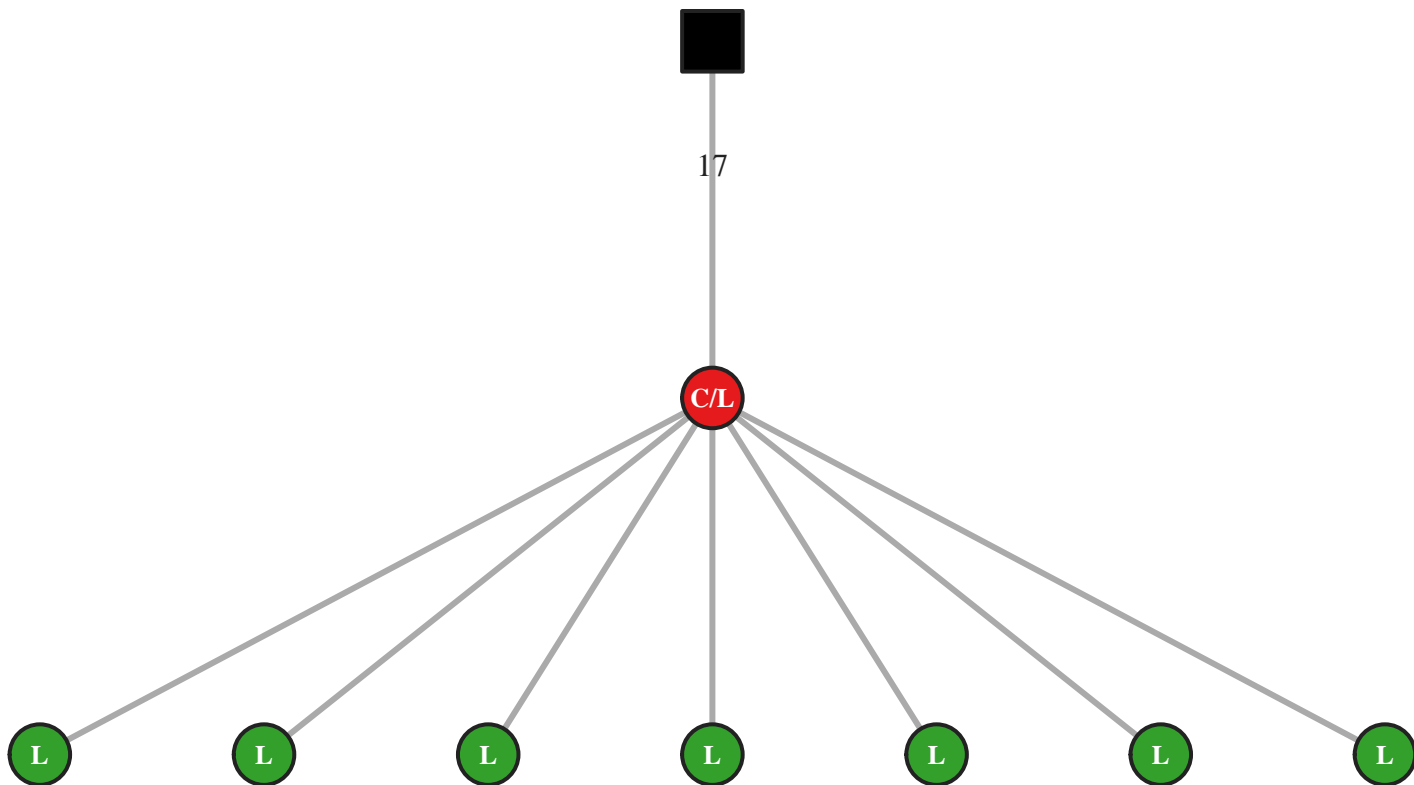

M5 IgG IGHV3-30/J6 54bp (51667)

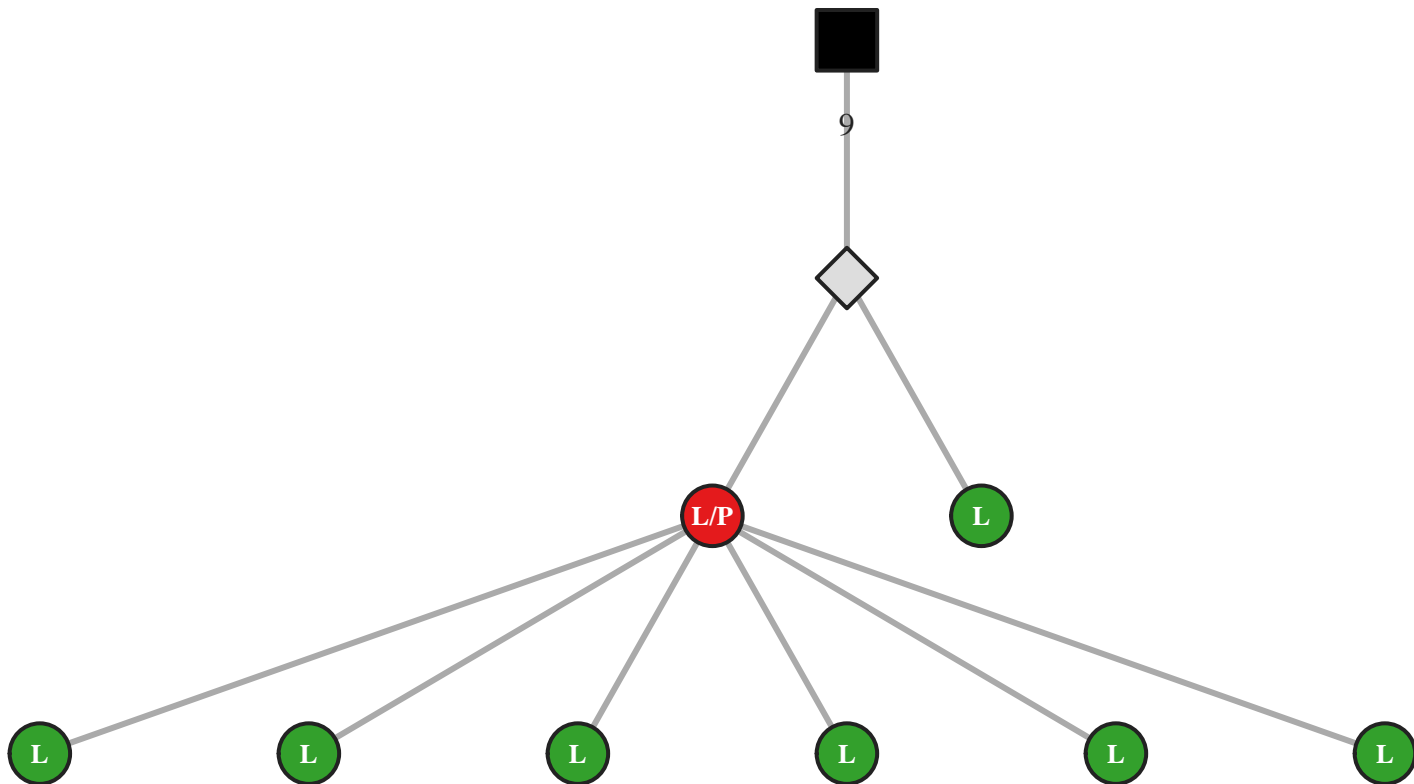

M5 IgG IGHV3-30/J6 54bp (51706)

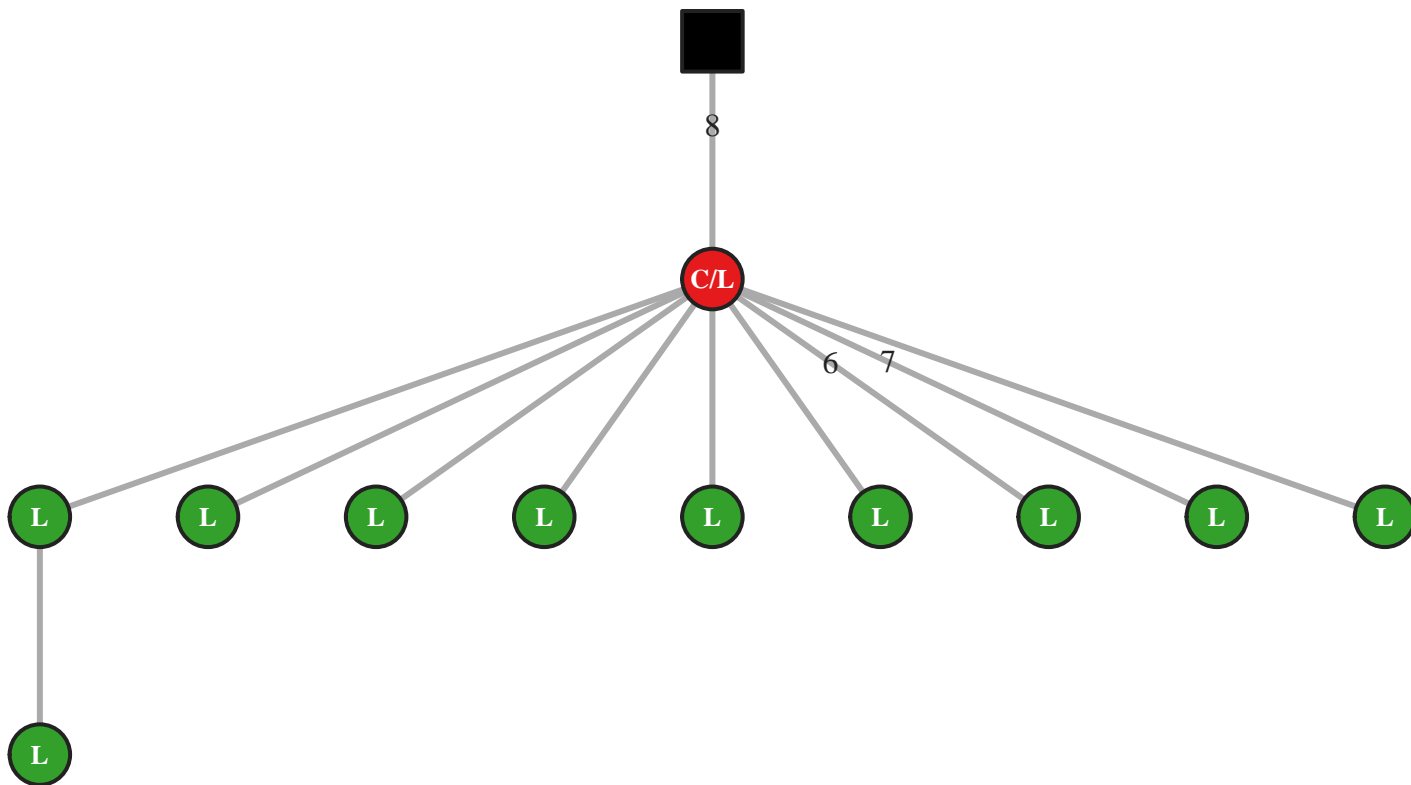

M5 IgG IGHV3-30/J6 54bp (51734)

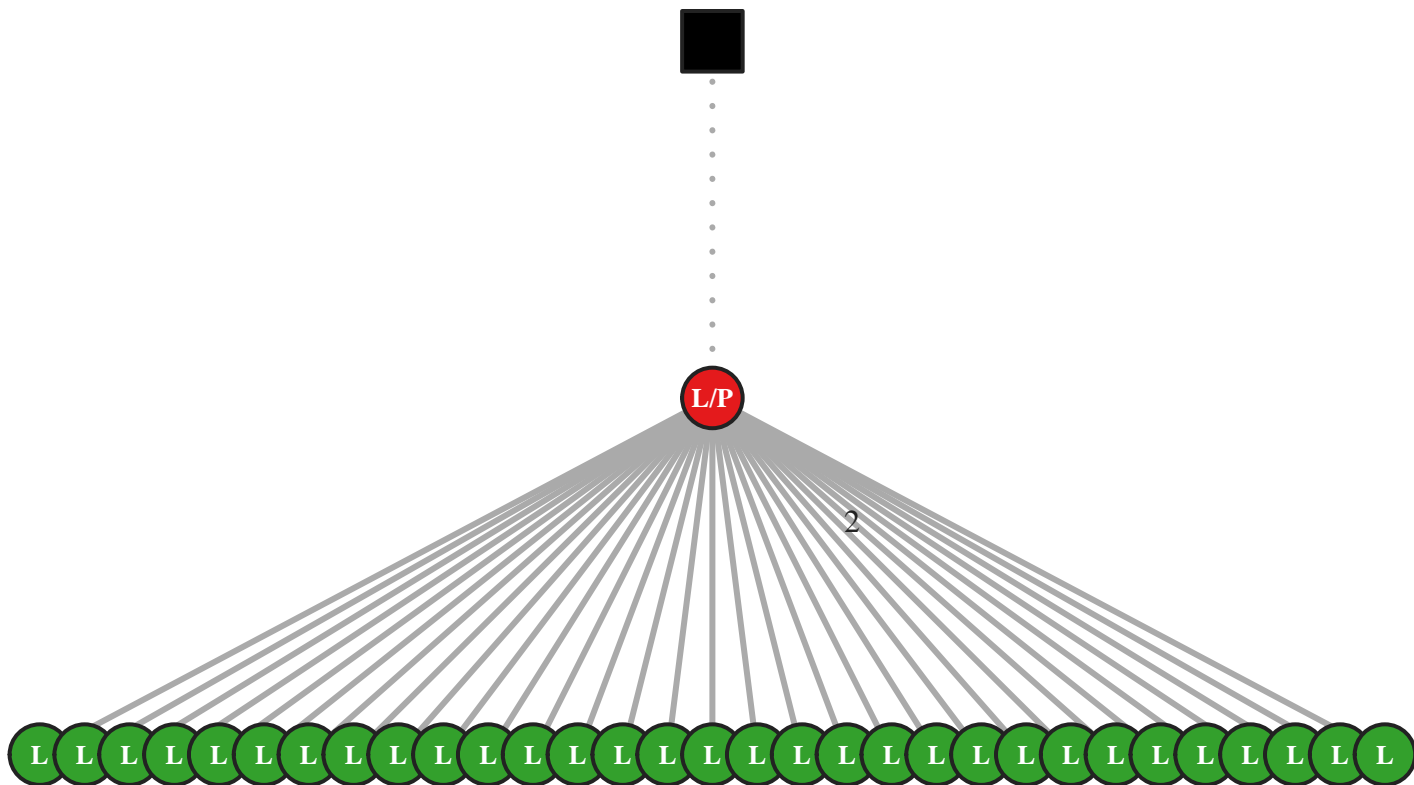

M5 IgG IGHV3-30/J6 54bp (51777)

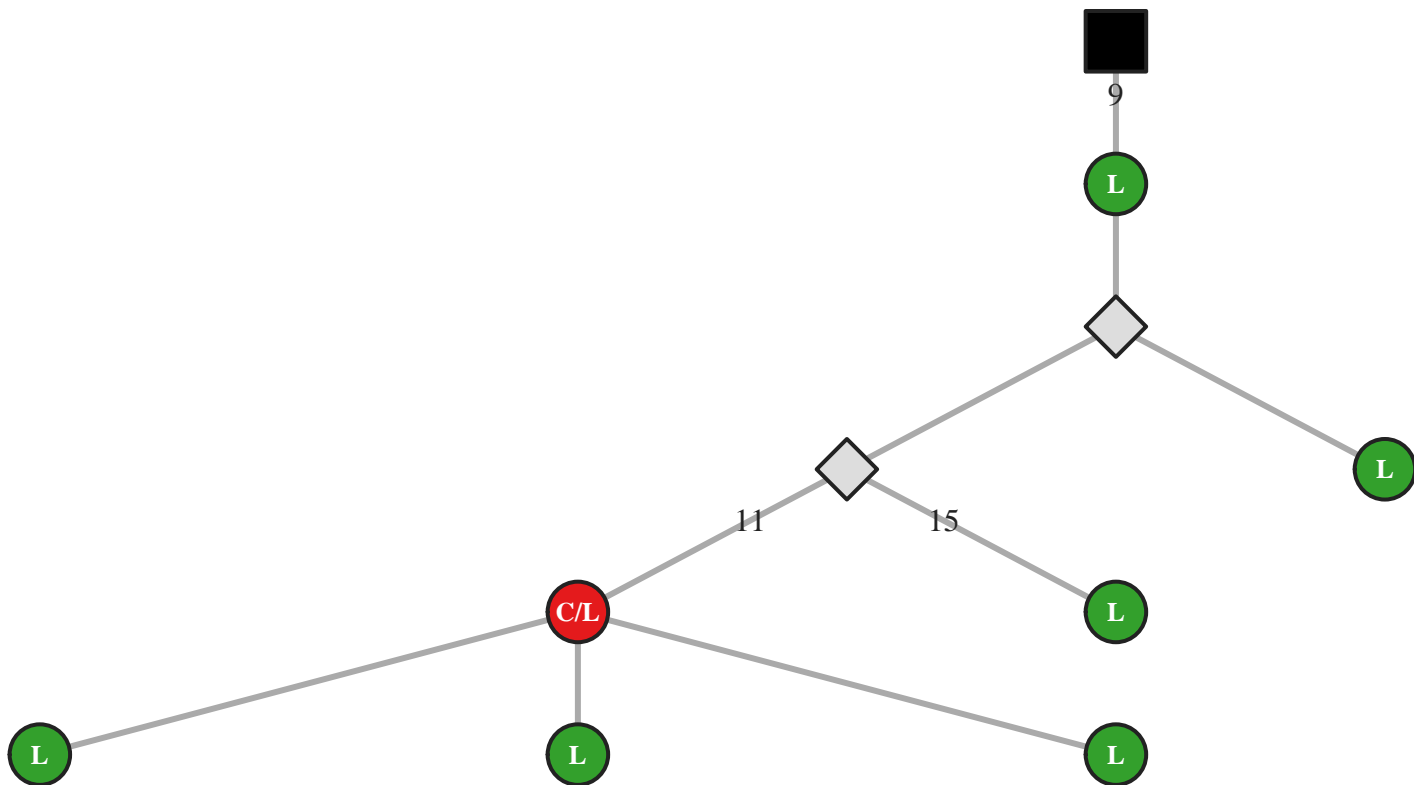

M5 IgG IGHV3-30/J6 57bp (26057)

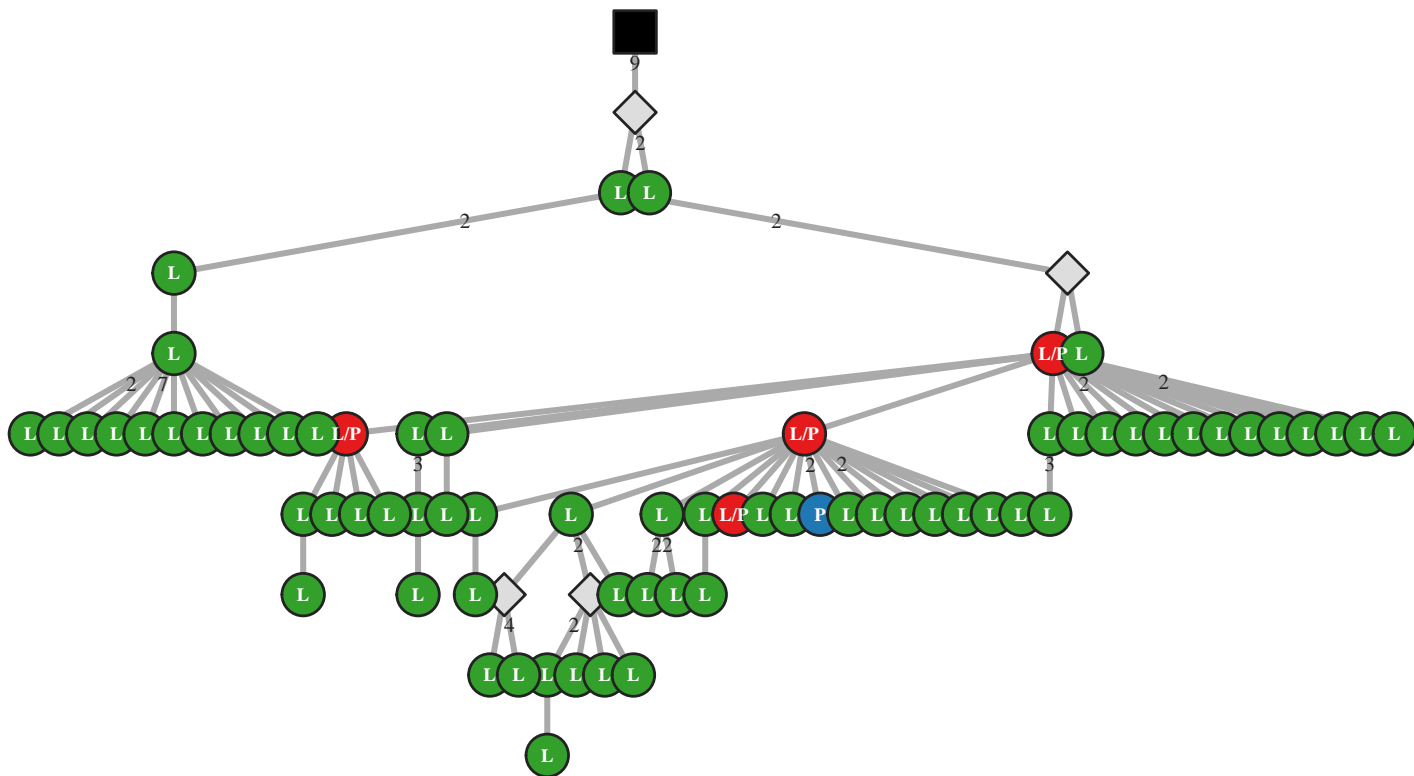

M5 IgG IGHV3-30/J6 57bp (26100)

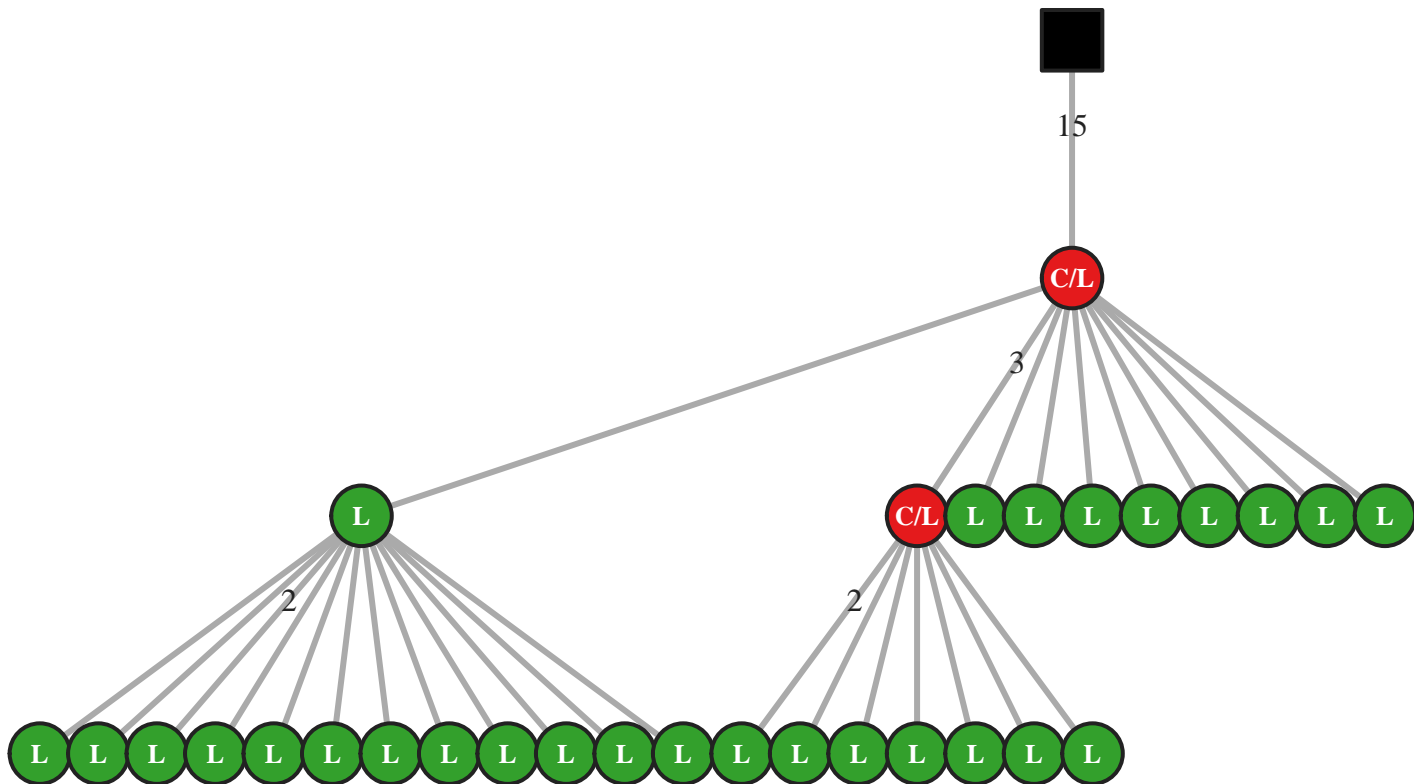

M5 IgG IGHV3-30/J6 57bp (26106)

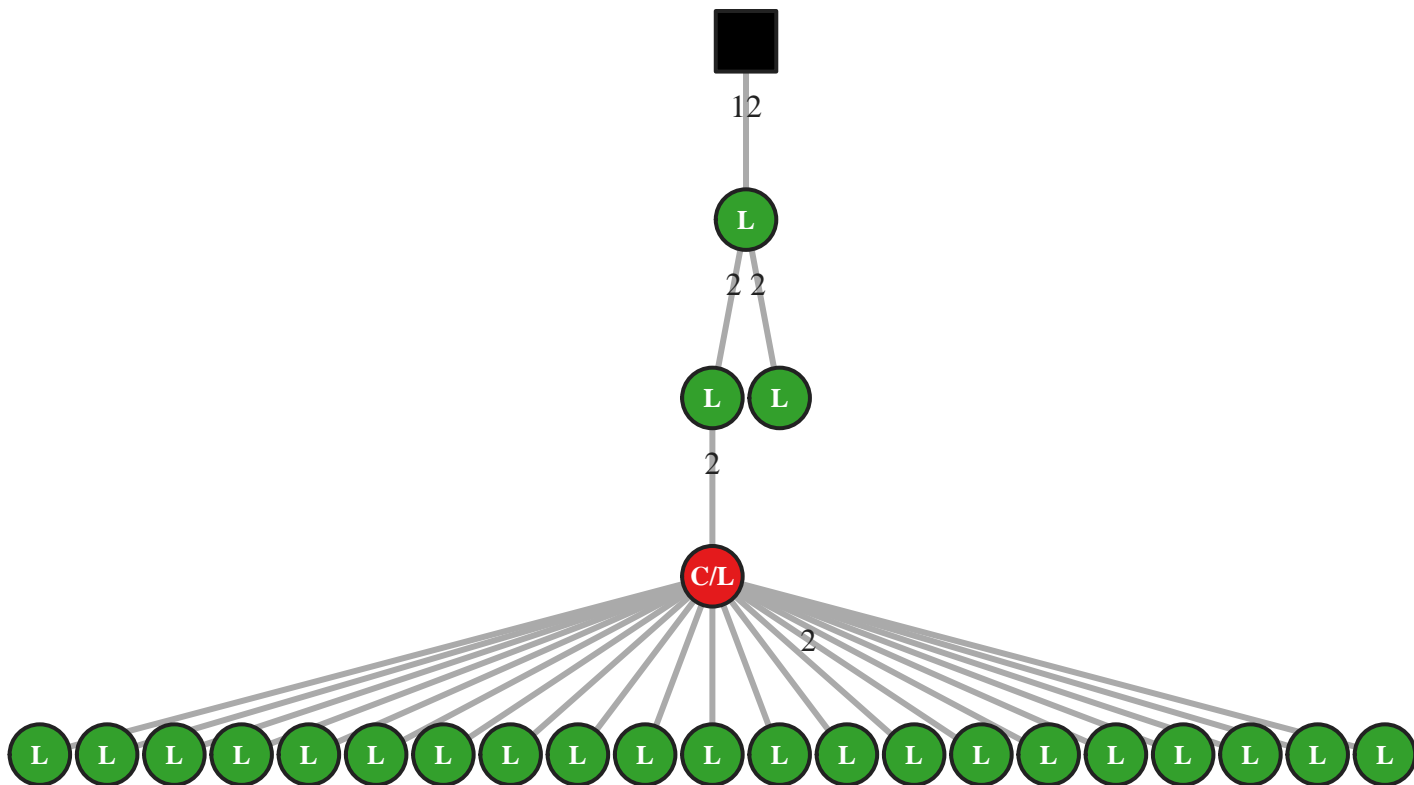

M5 IgA IGHV3-30/J6 60bp (12437)

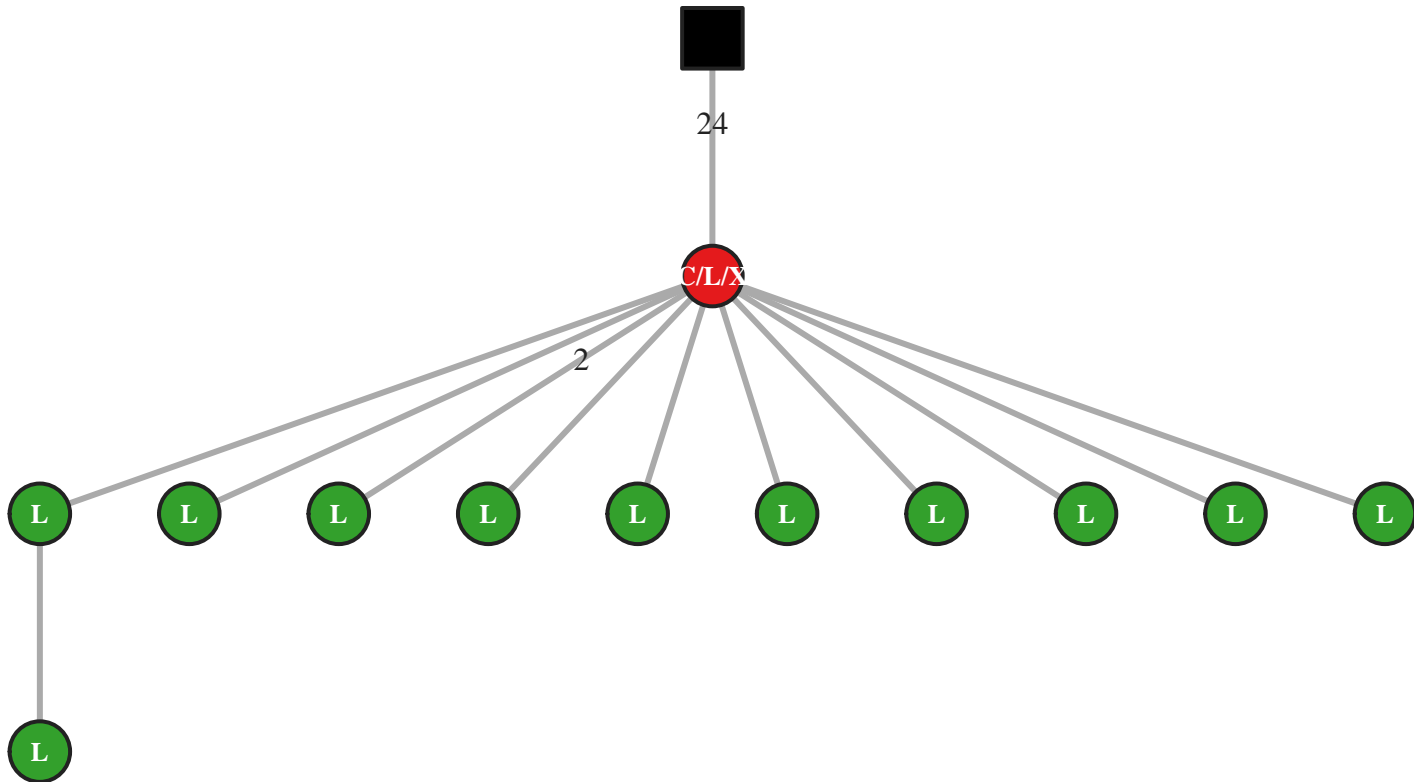

M5 IgG IGHV3-30/J6 60bp (26235)

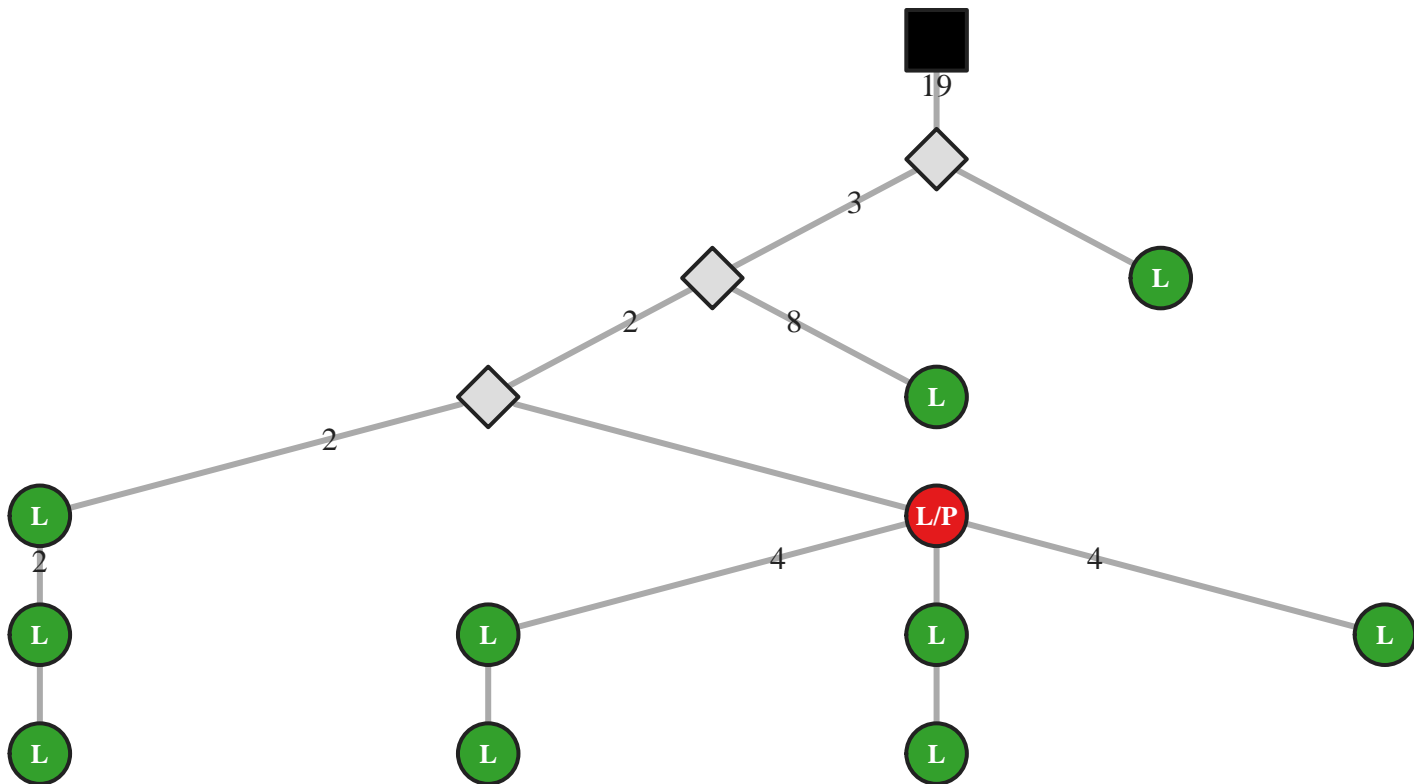

M5 IgG IGHV3-30/J6 63bp (44736)

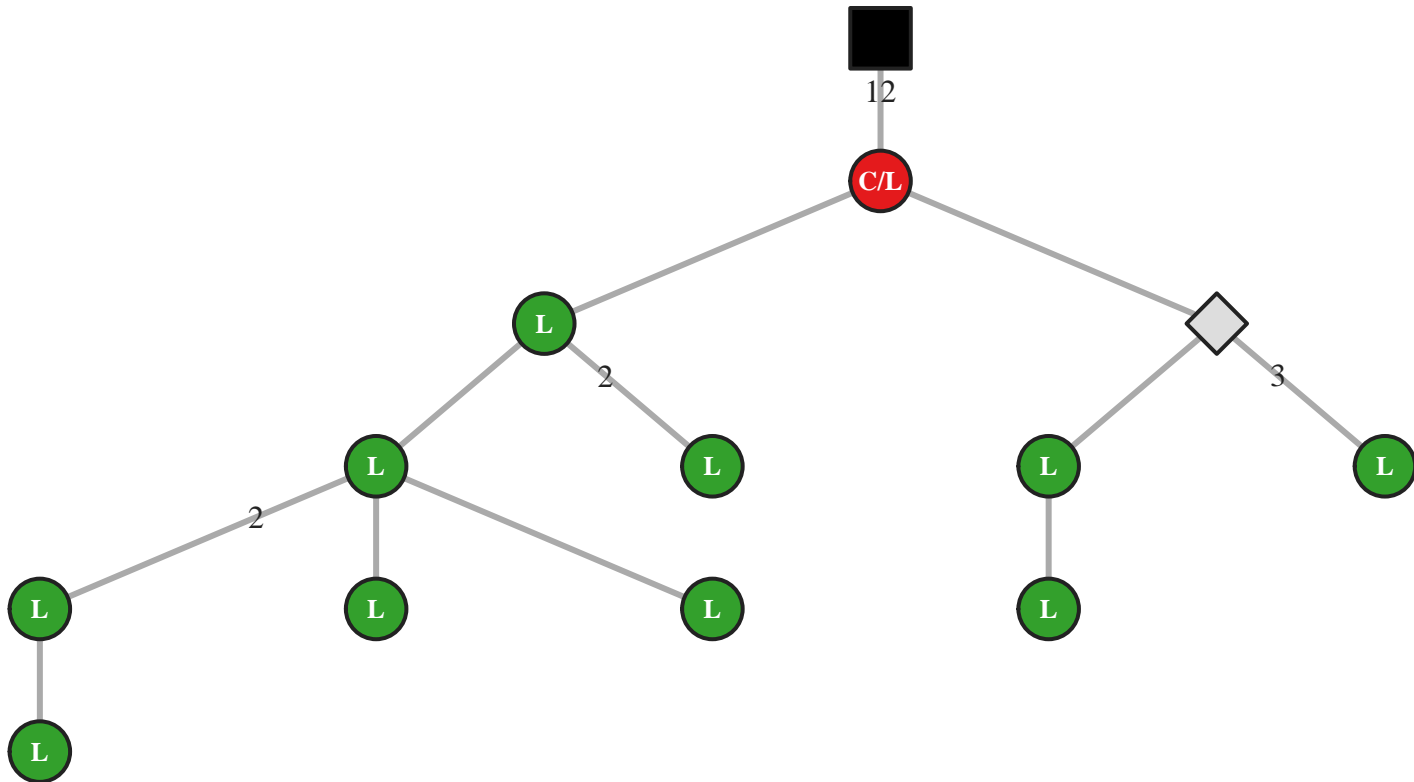

M5 IgA IGHV3-30/J6 66bp (2843)

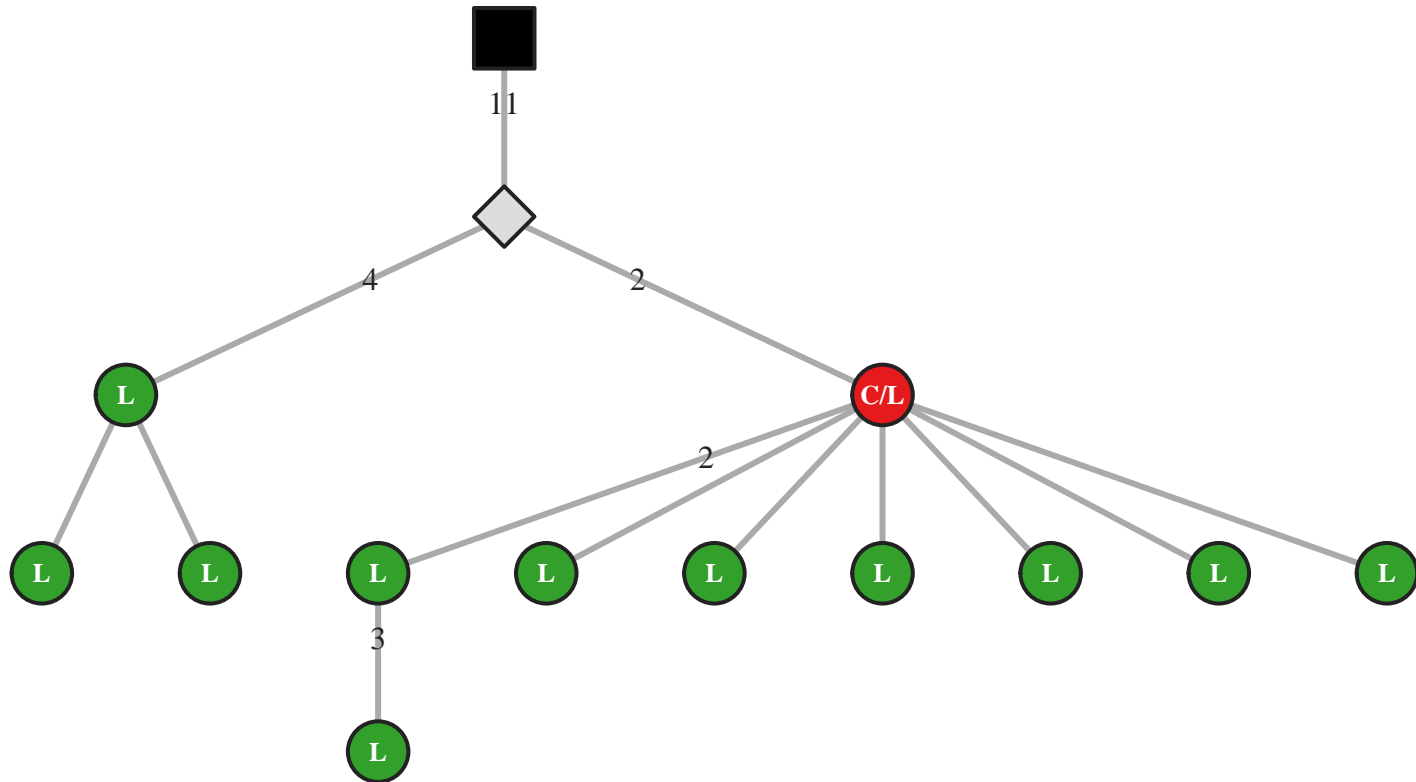

M5 IgG IGHV3-30/J6 69bp (44881)

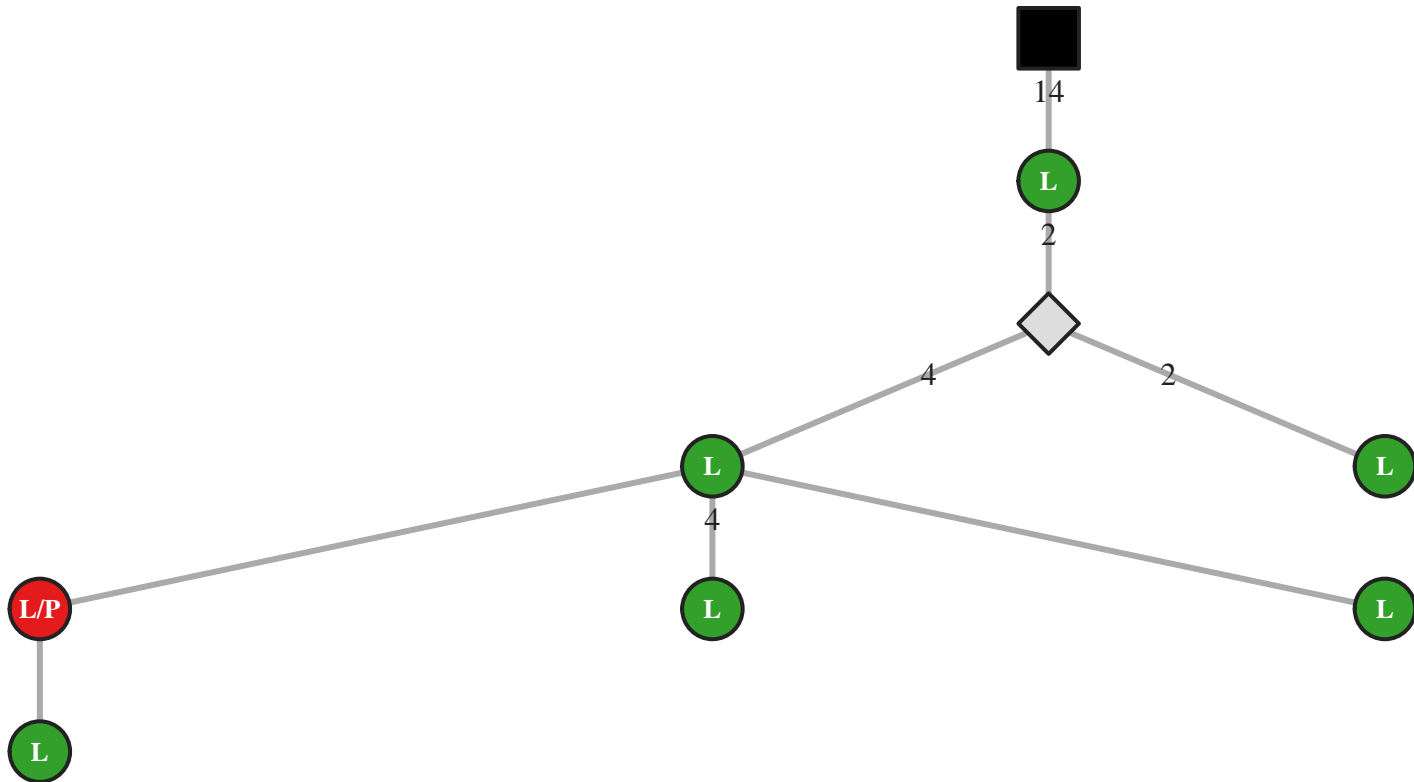

M5 IgG IGHV3-30/J6 69bp (44919)

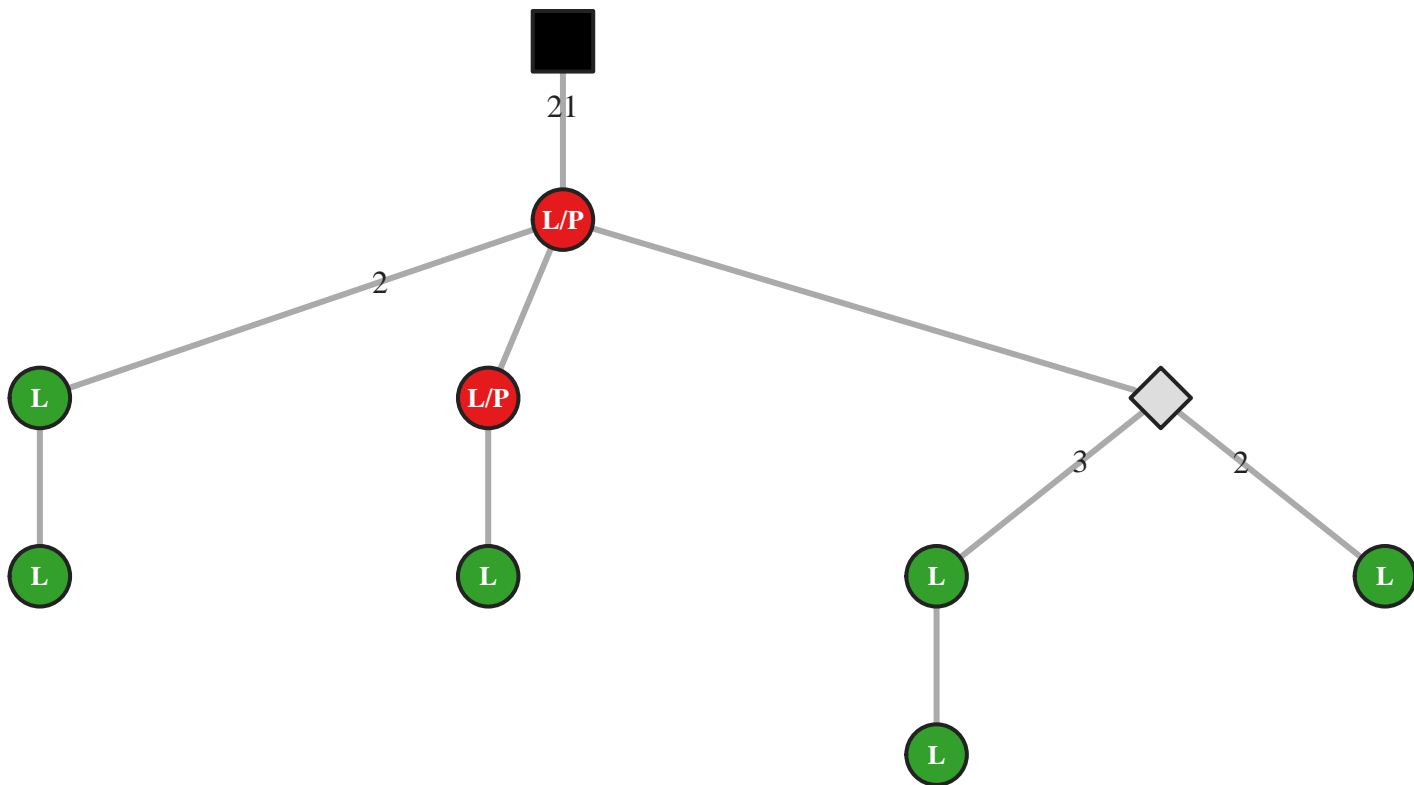

M5 IgG IGHV3-30/J6 69bp (44947)

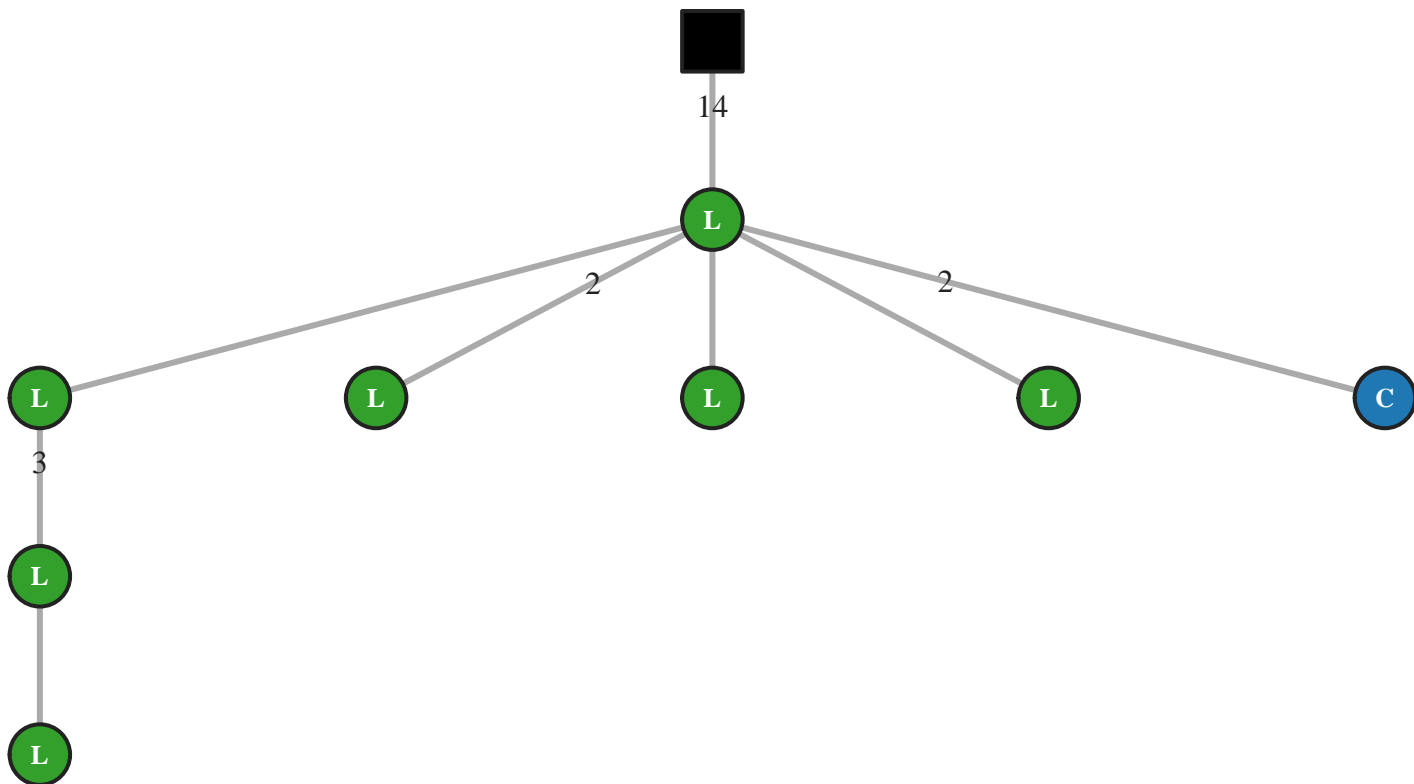

M5 IgG IGHV3-30/J6 72bp (7874)

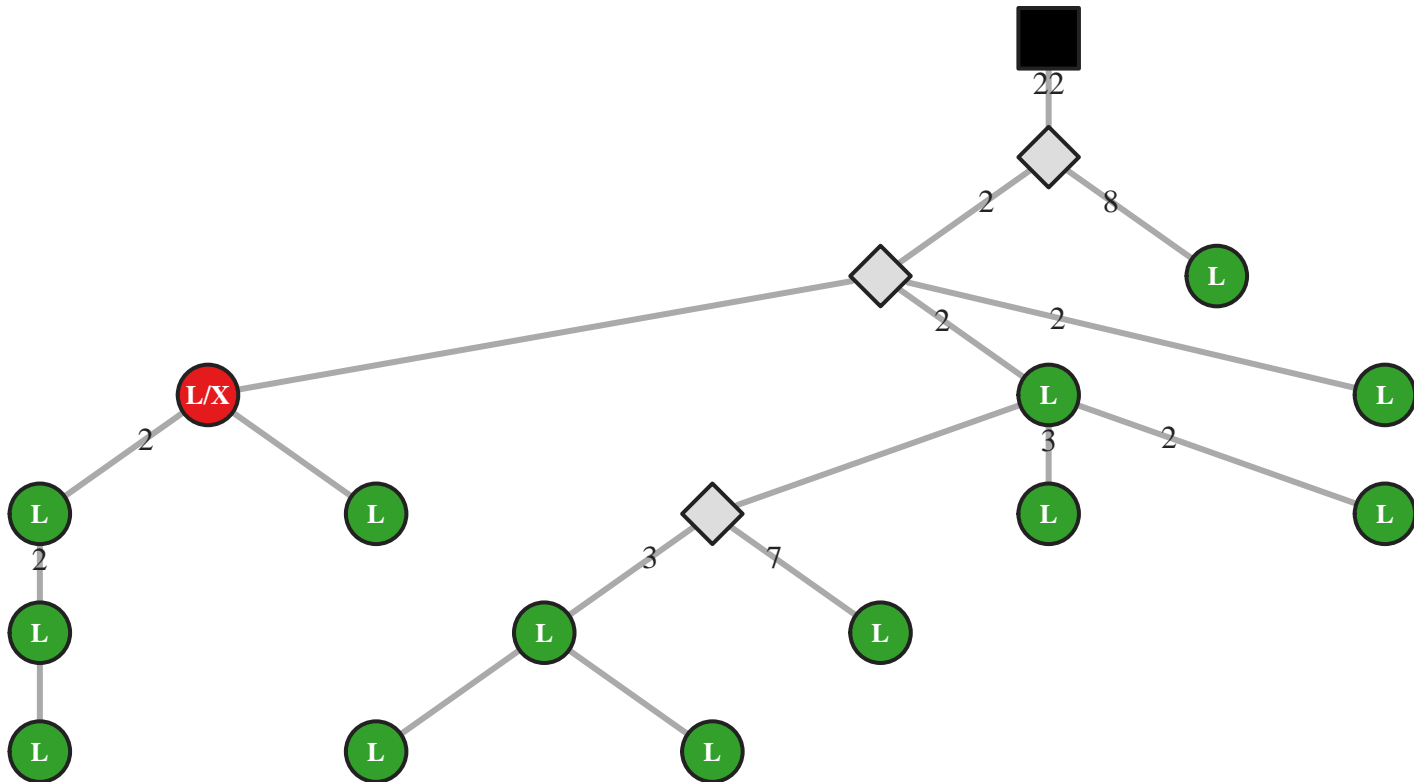

M5 IgG IGHV3-30/J6 72bp (7921)

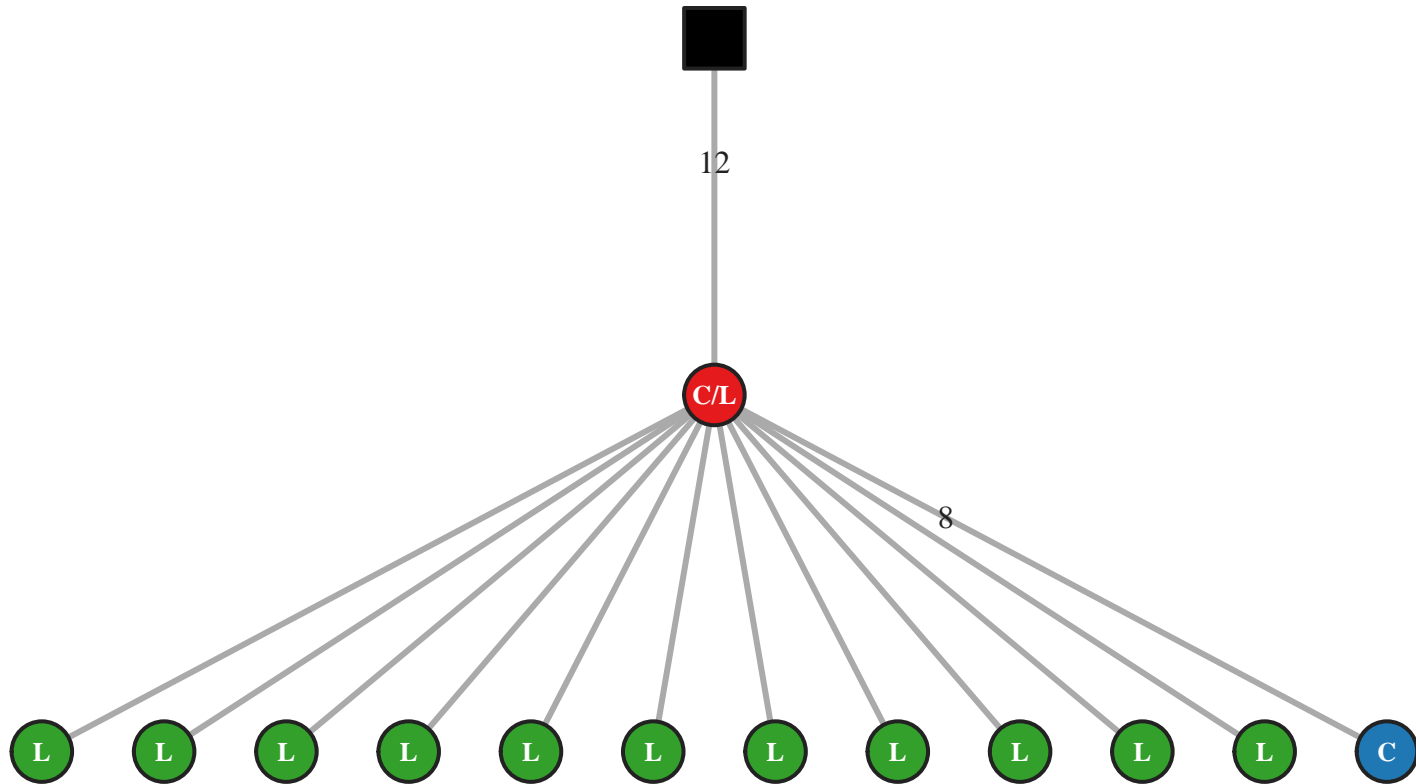

M5 IgG IGHV3-30/J6 72bp (7932)

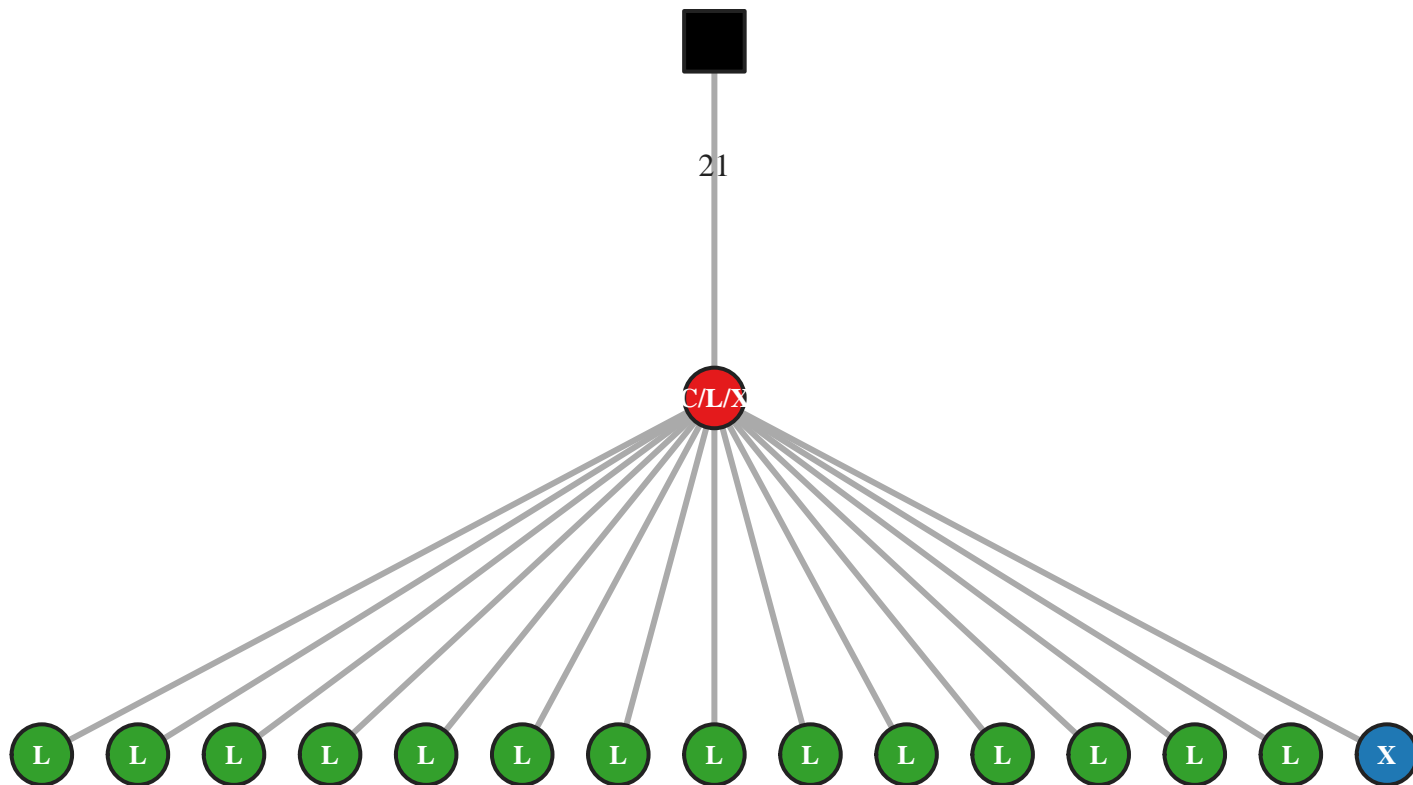

M5 IgG IGHV3-30-3/J1 36bp (44748)

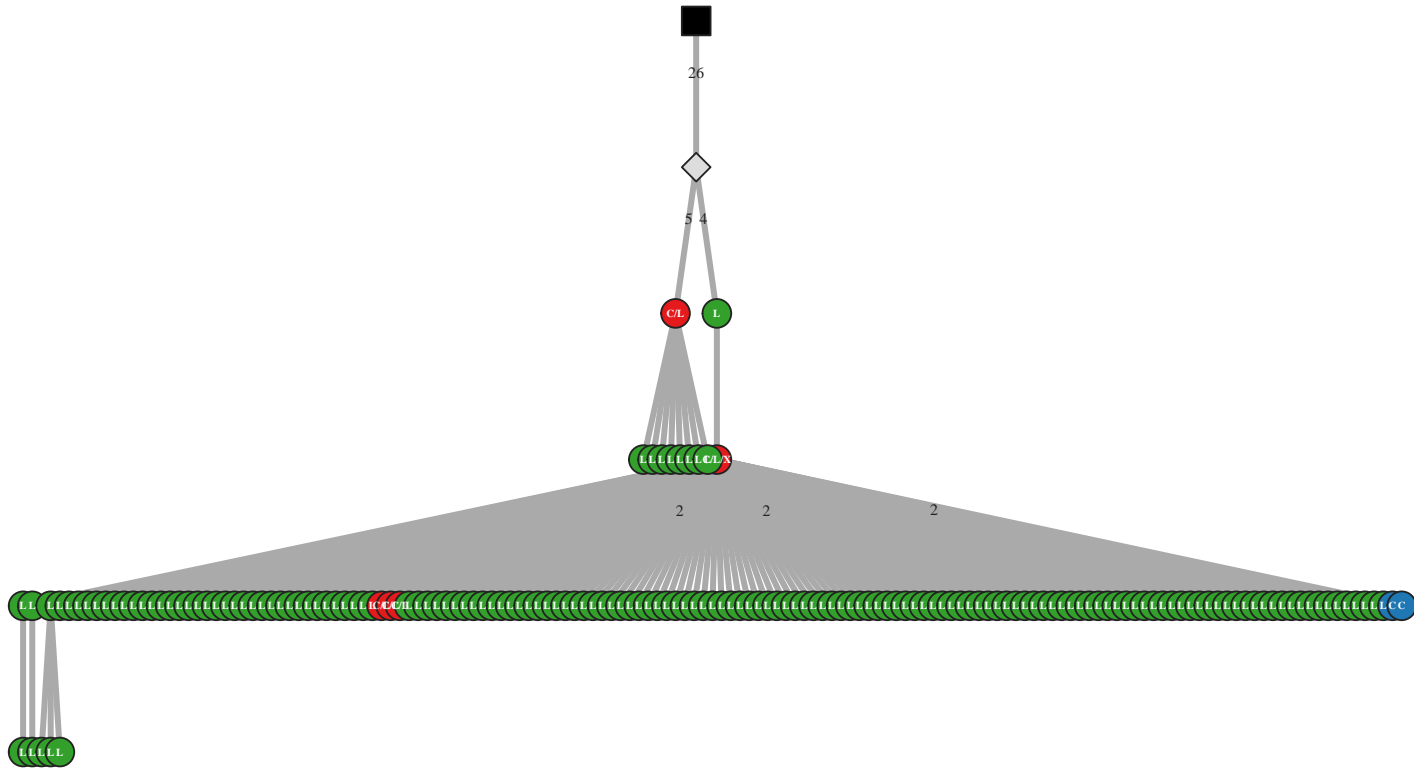

M5 IgG IGHV3-30-3/J1 51bp (51809)

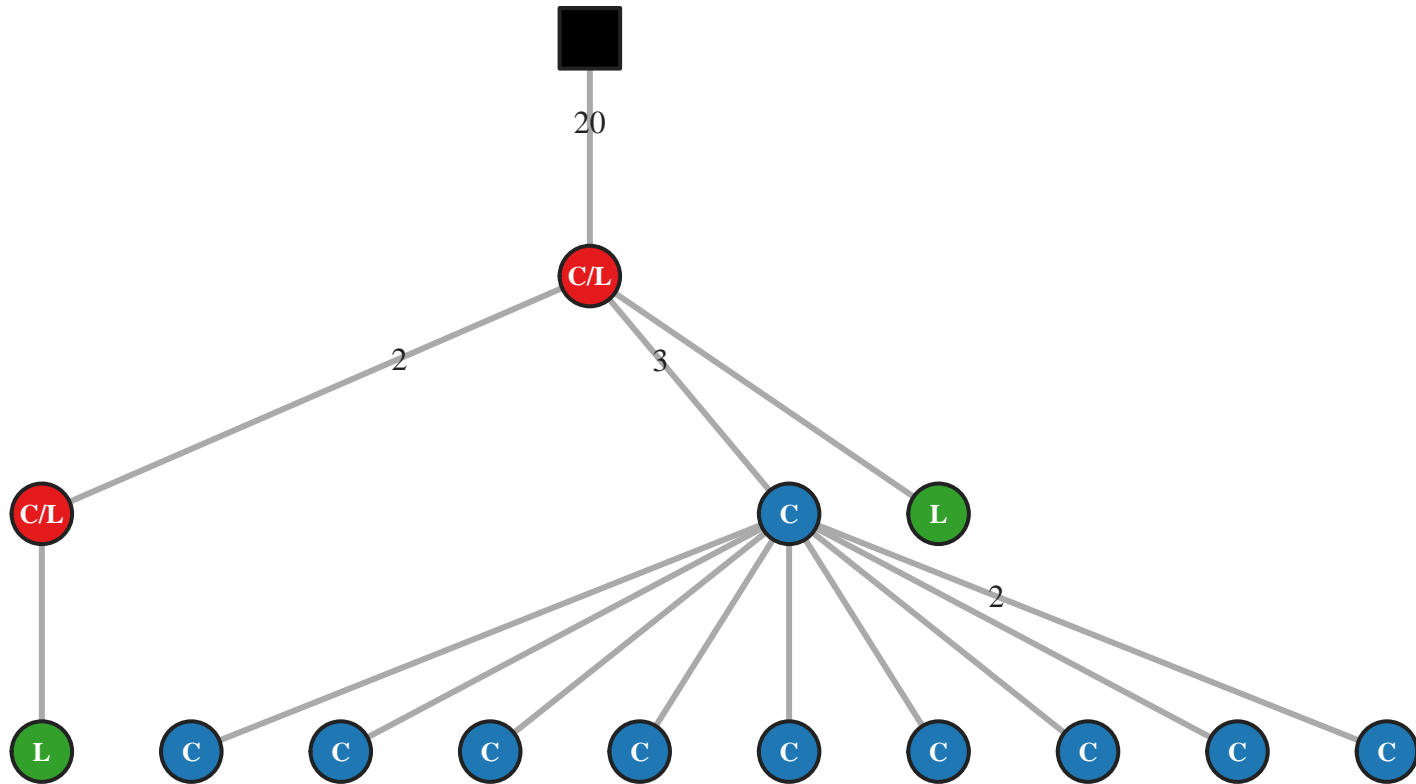

M5 IgG IGHV3-30-3/J2 39bp (26338)

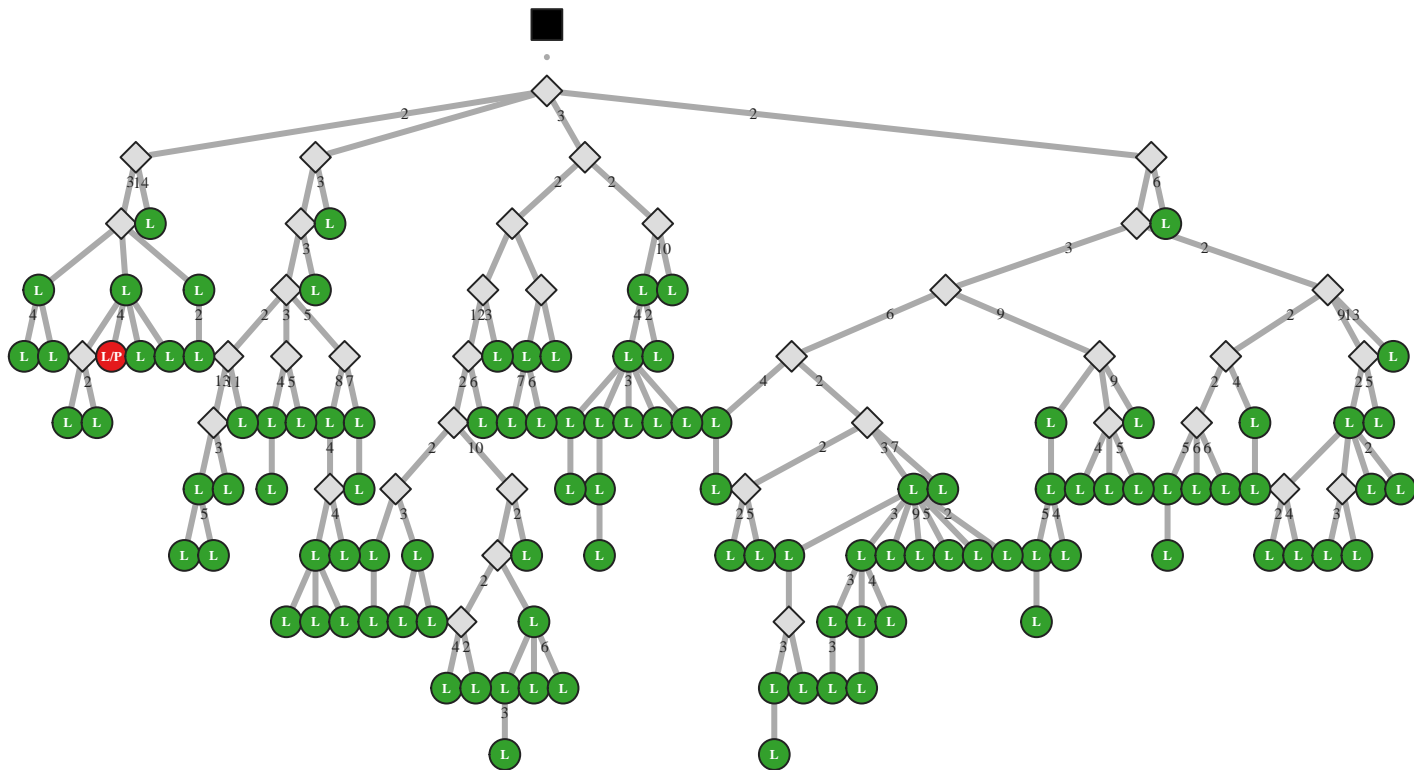

M5 IgG IGHV3-30-3/J2 45bp (17567)

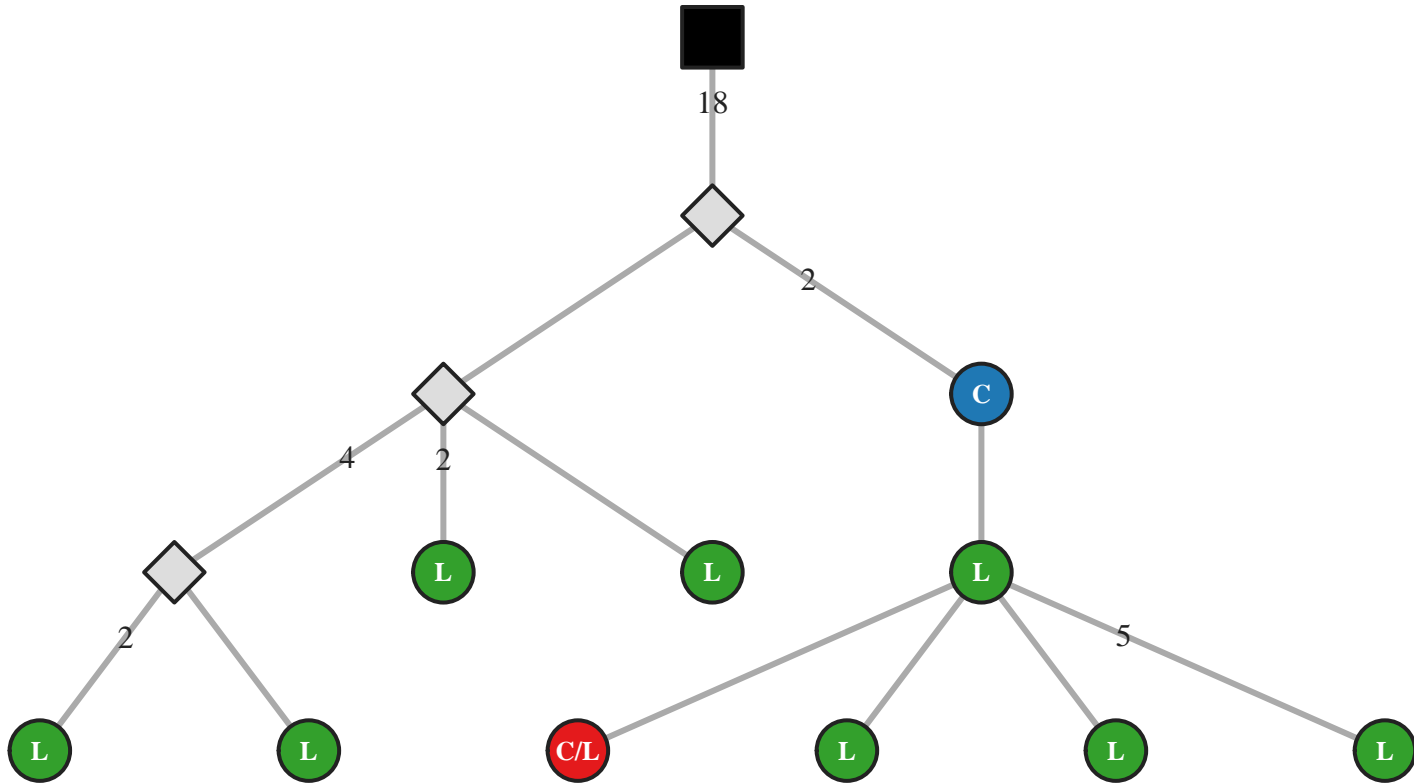

M5 IgG IGHV3-30-3/J2 51bp (51820)

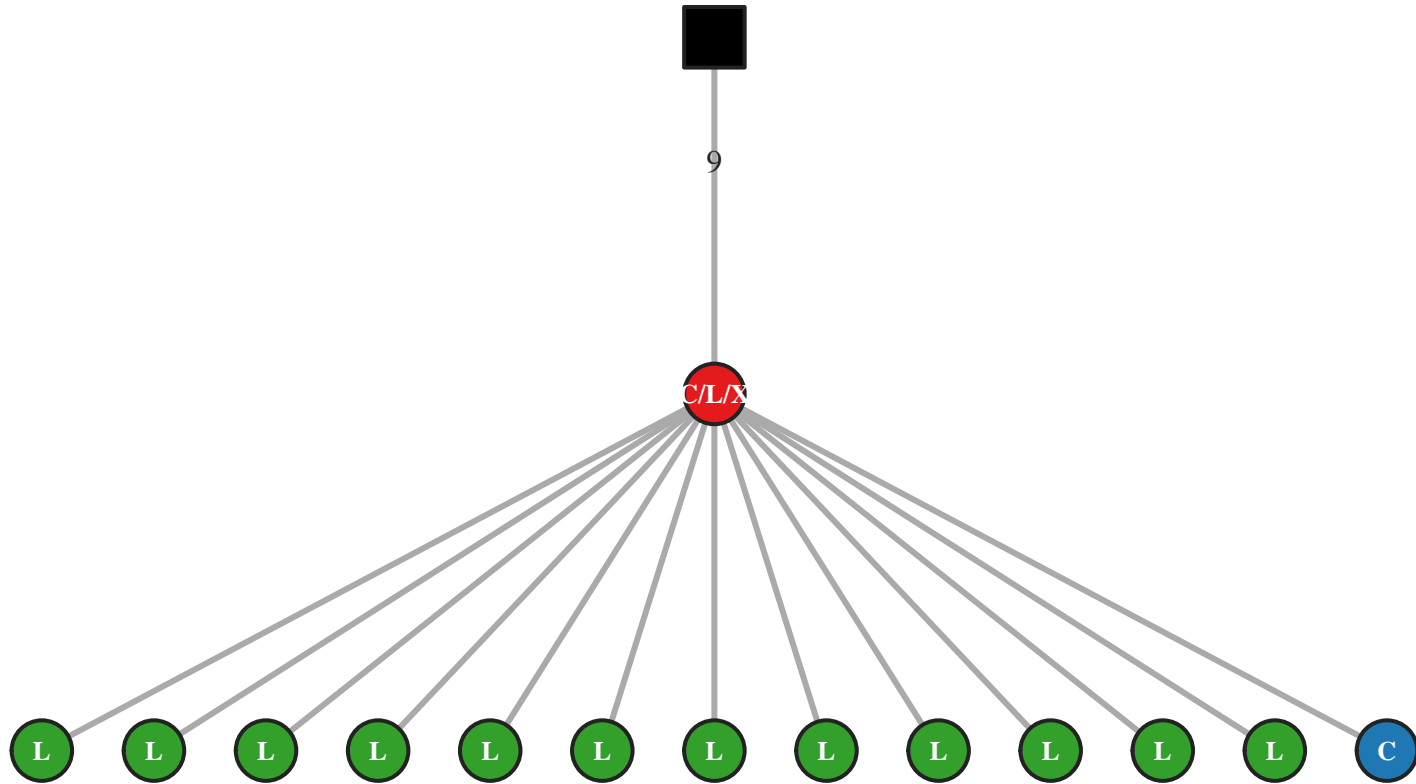

M5 IgG IGHV3-30-3/J3 48bp (7041)

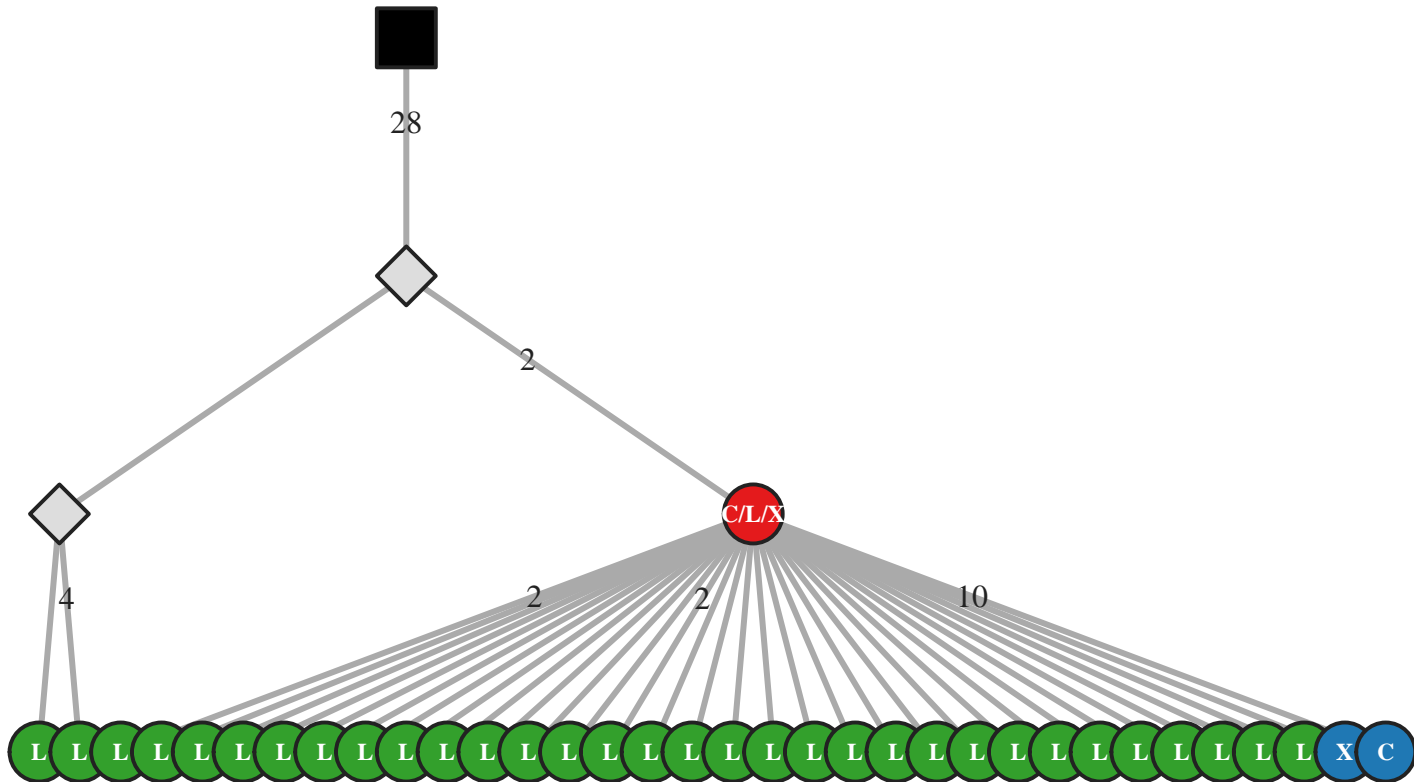

M5 IgG IGHV3-30-3/J3 48bp (7079)

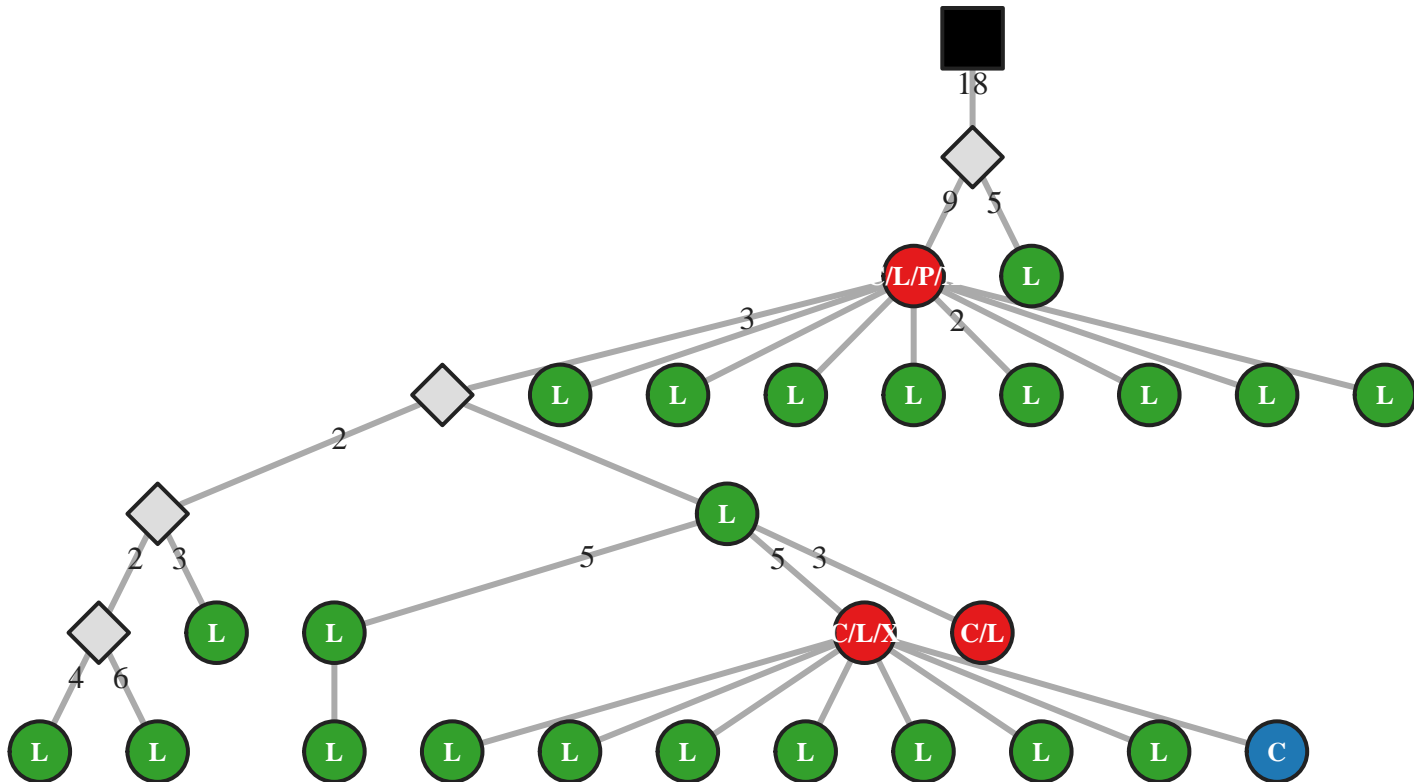

M5 IgG IGHV3-30-3/J3 54bp (51833)

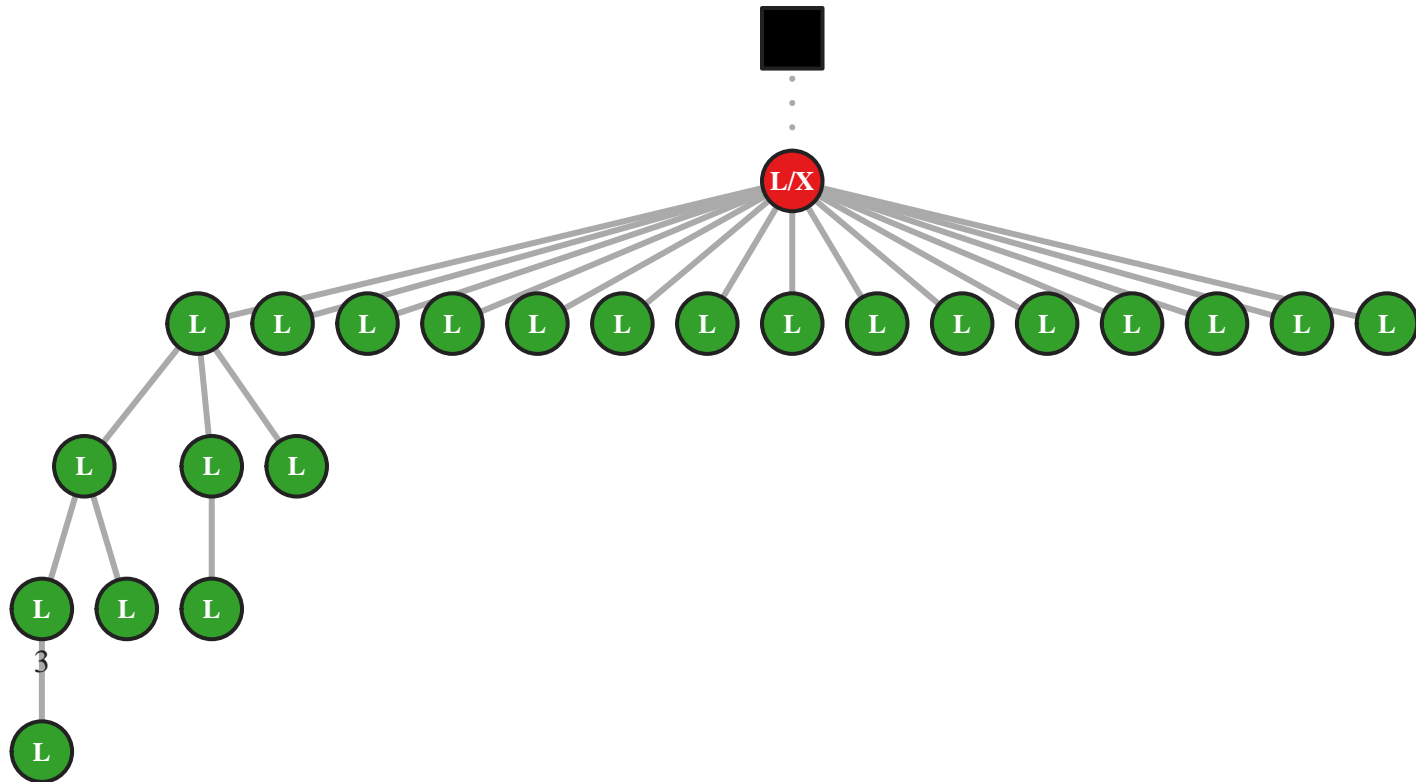

M5 IgG IGHV3-30-3/J3 60bp (34849)

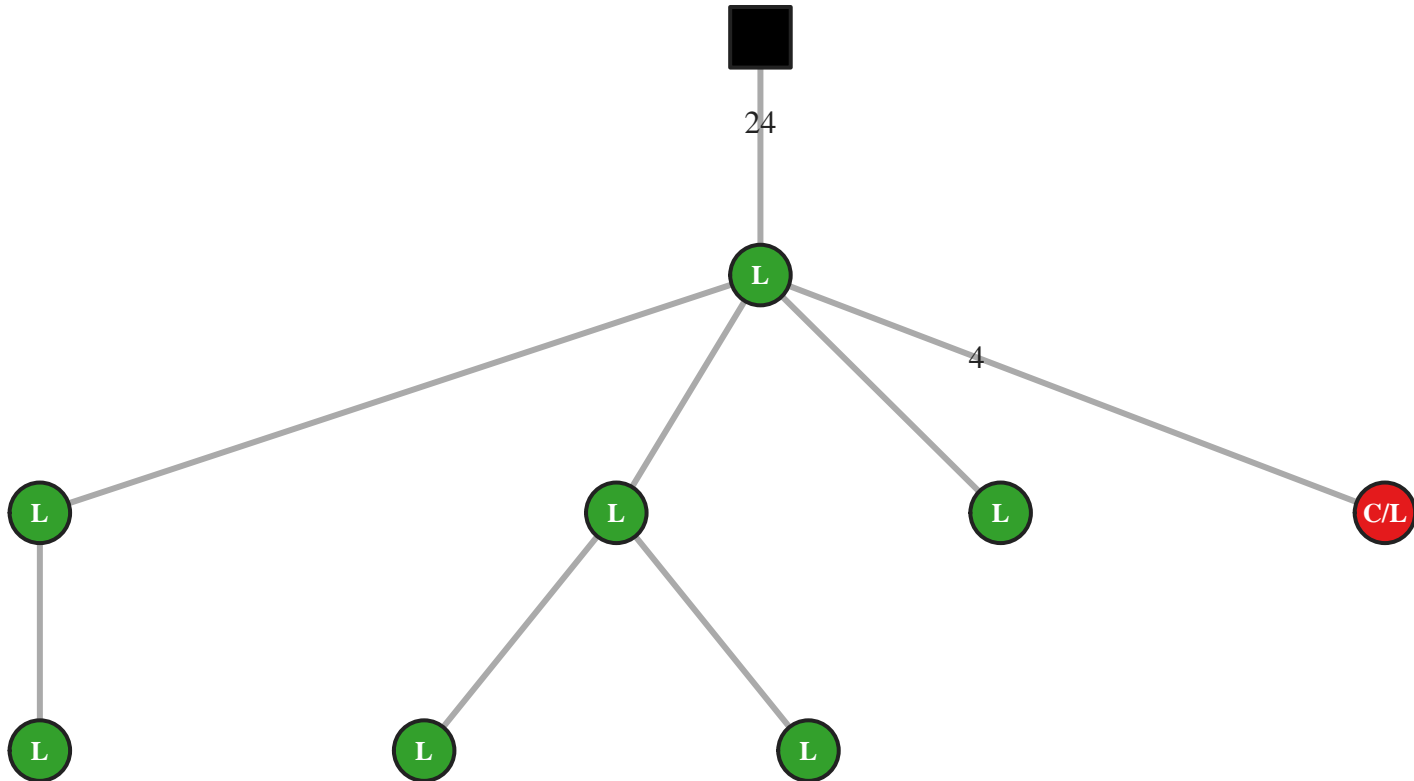

M5 IgG IGHV3-30-3/J4 24bp (51804)

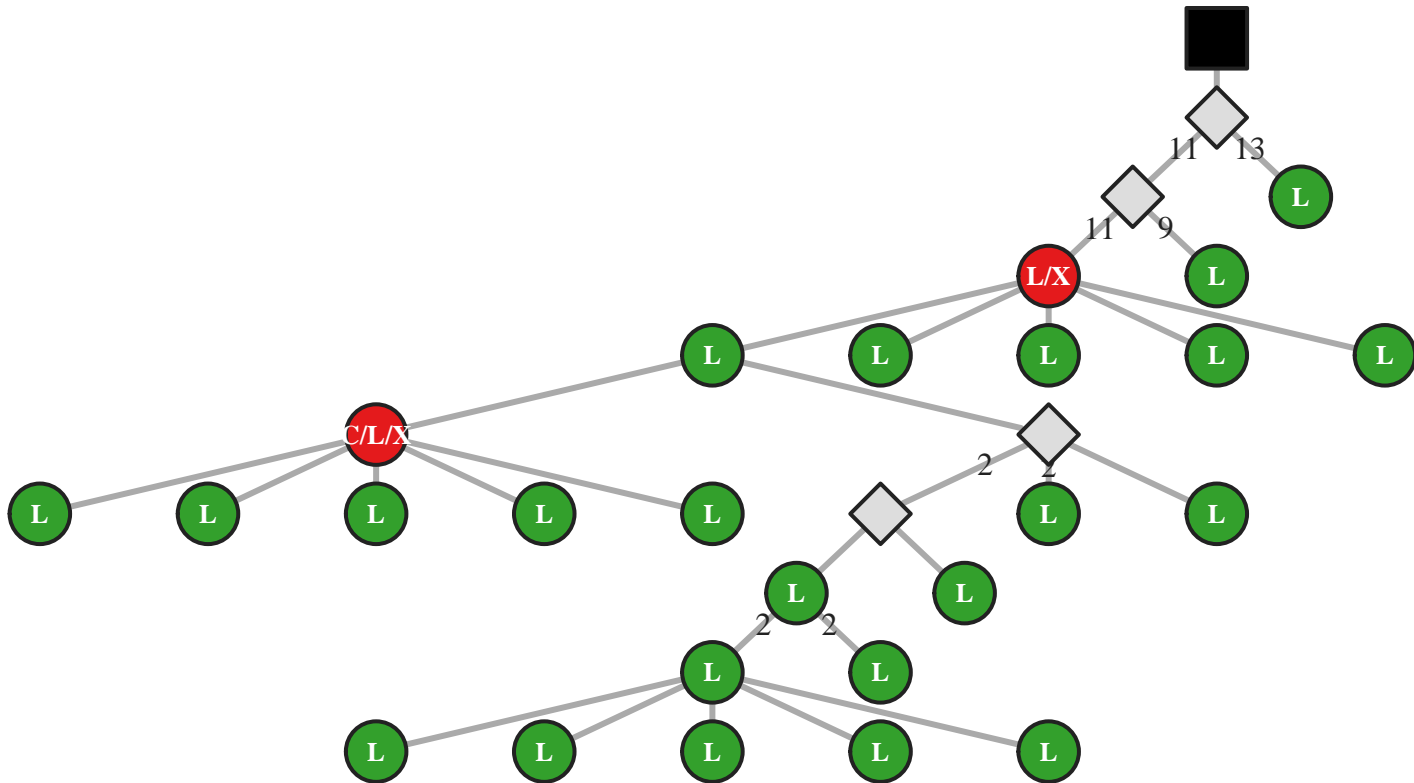

M5 IgG IGHV3-30-3/J4 24bp (51807)

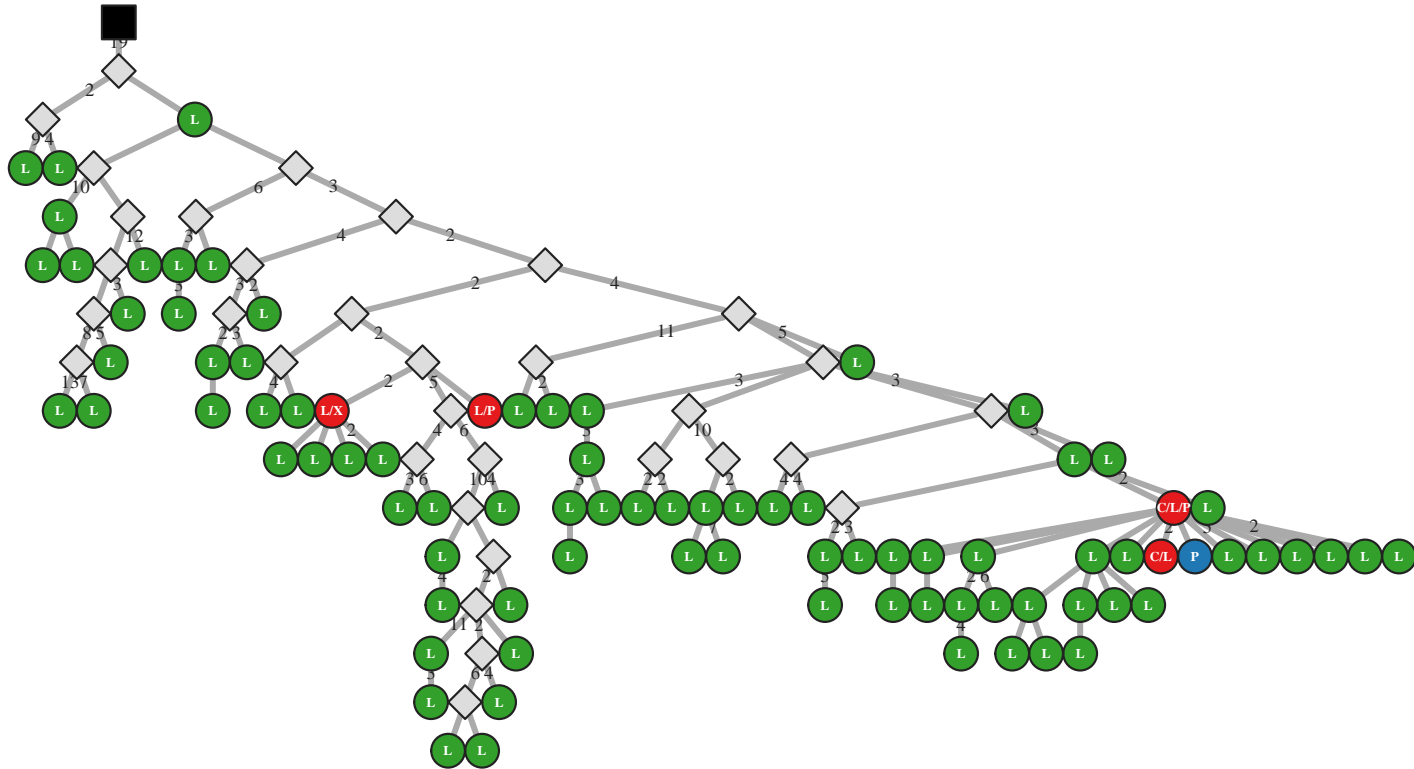

M5 IgG IGHV3-30-3/J4 27bp (17584)

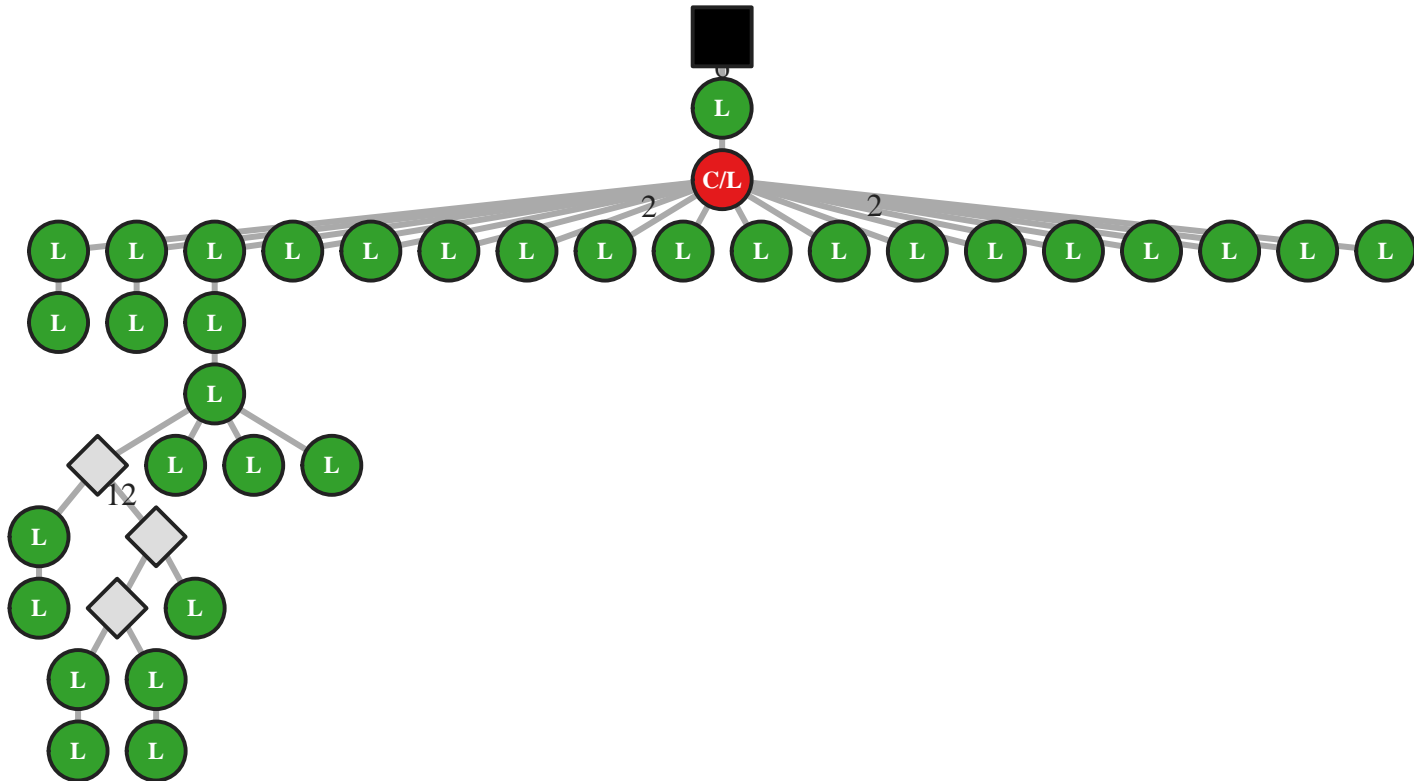

M5 IgA IGHV3-30-3/J4 33bp (2712)

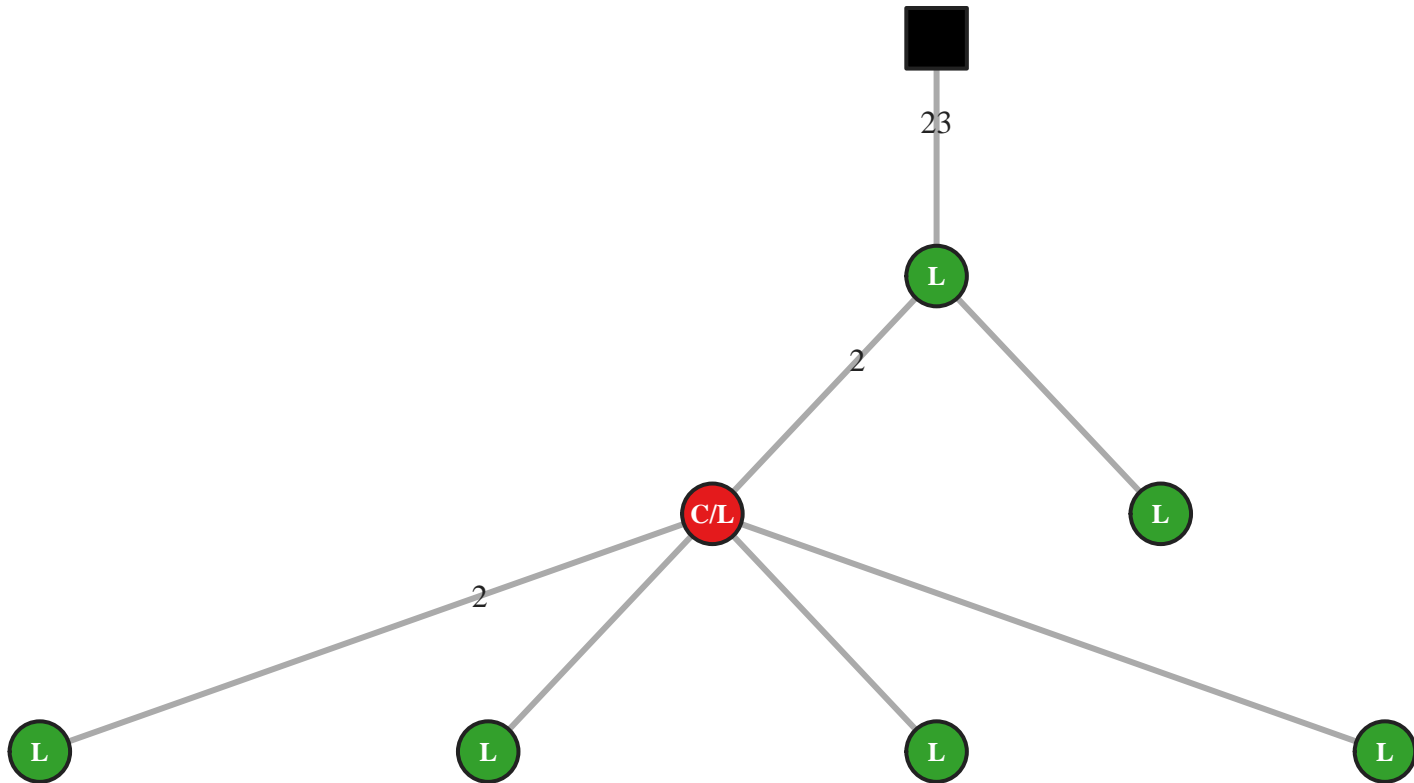

M5 IgG IGHV3-30-3/J4 33bp (7725)

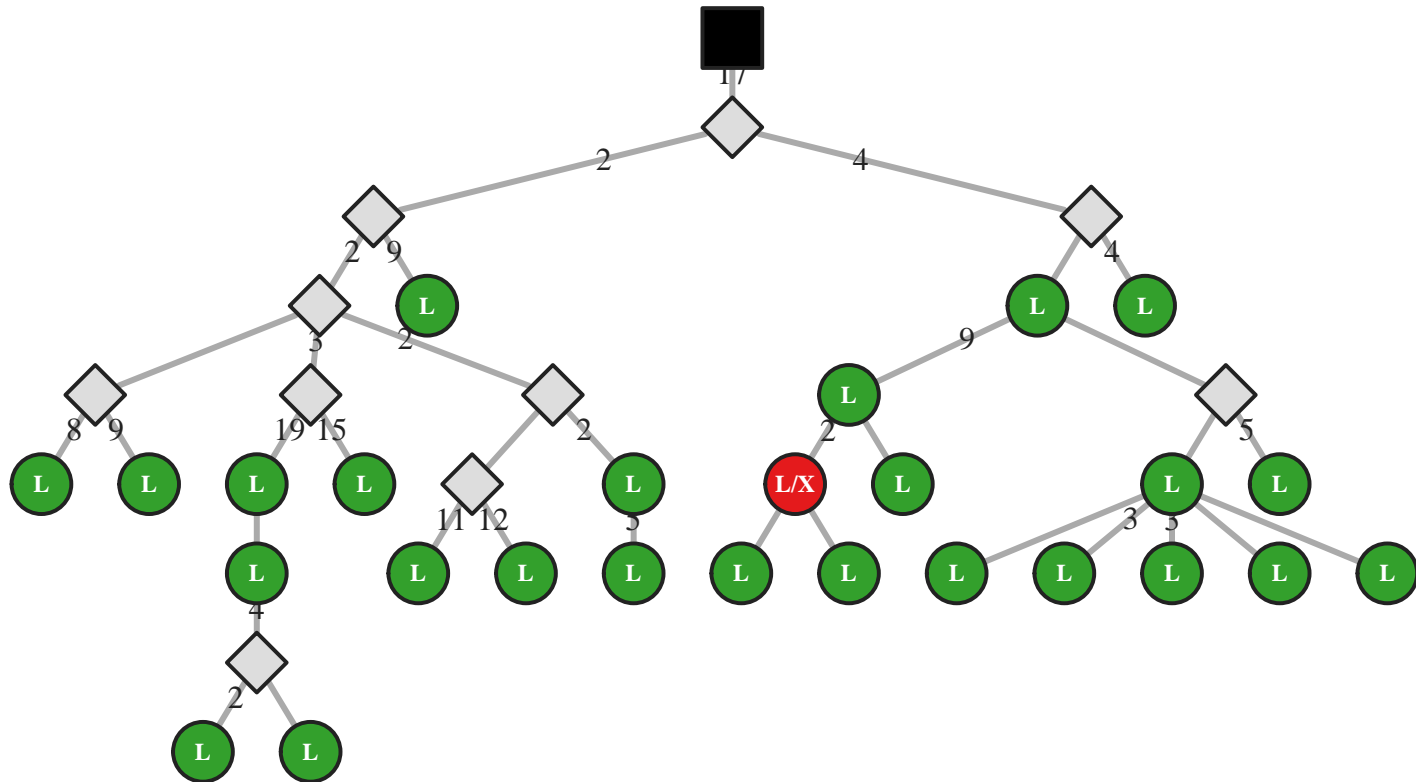

M5 IgG IGHV3-30-3/J4 33bp (7729)

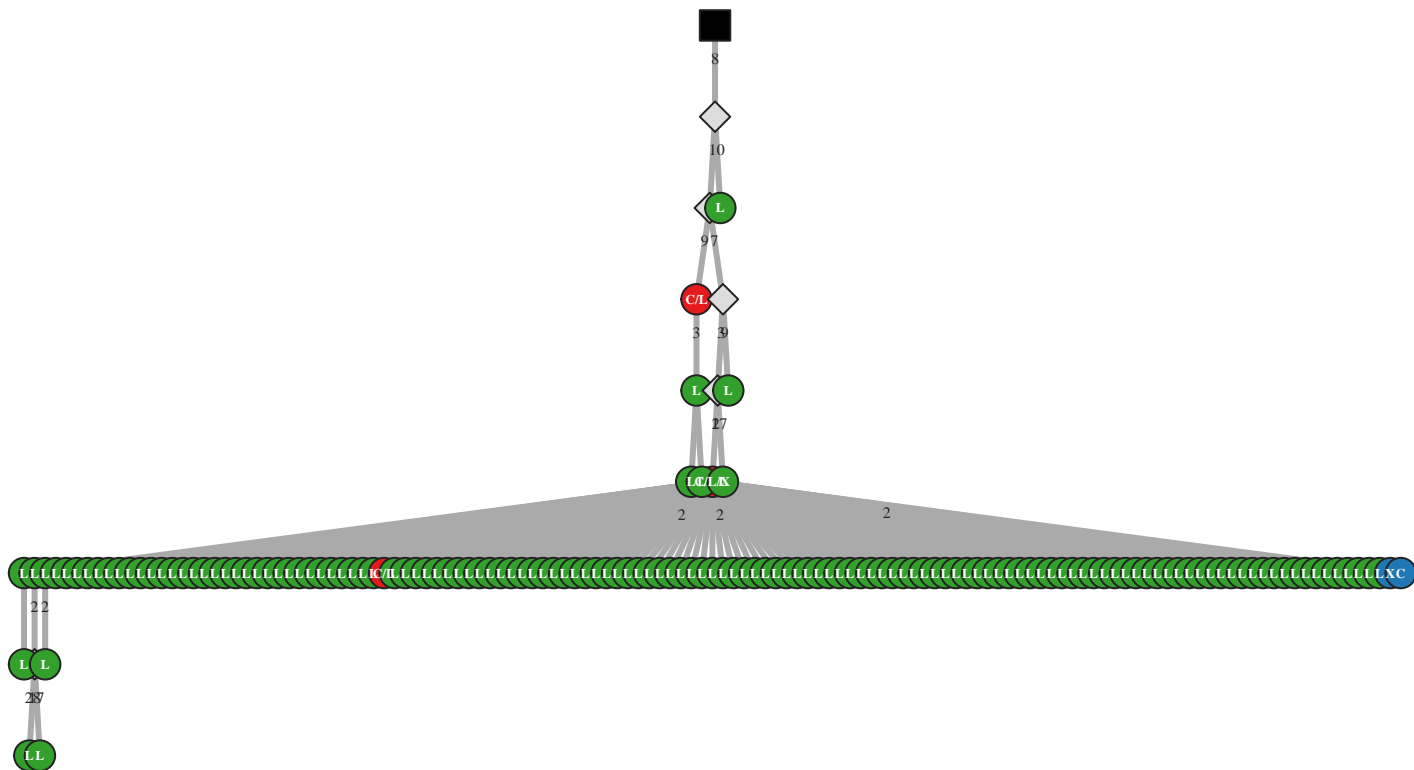

M5 IgG IGHV3-30-3/J4 39bp (7115)

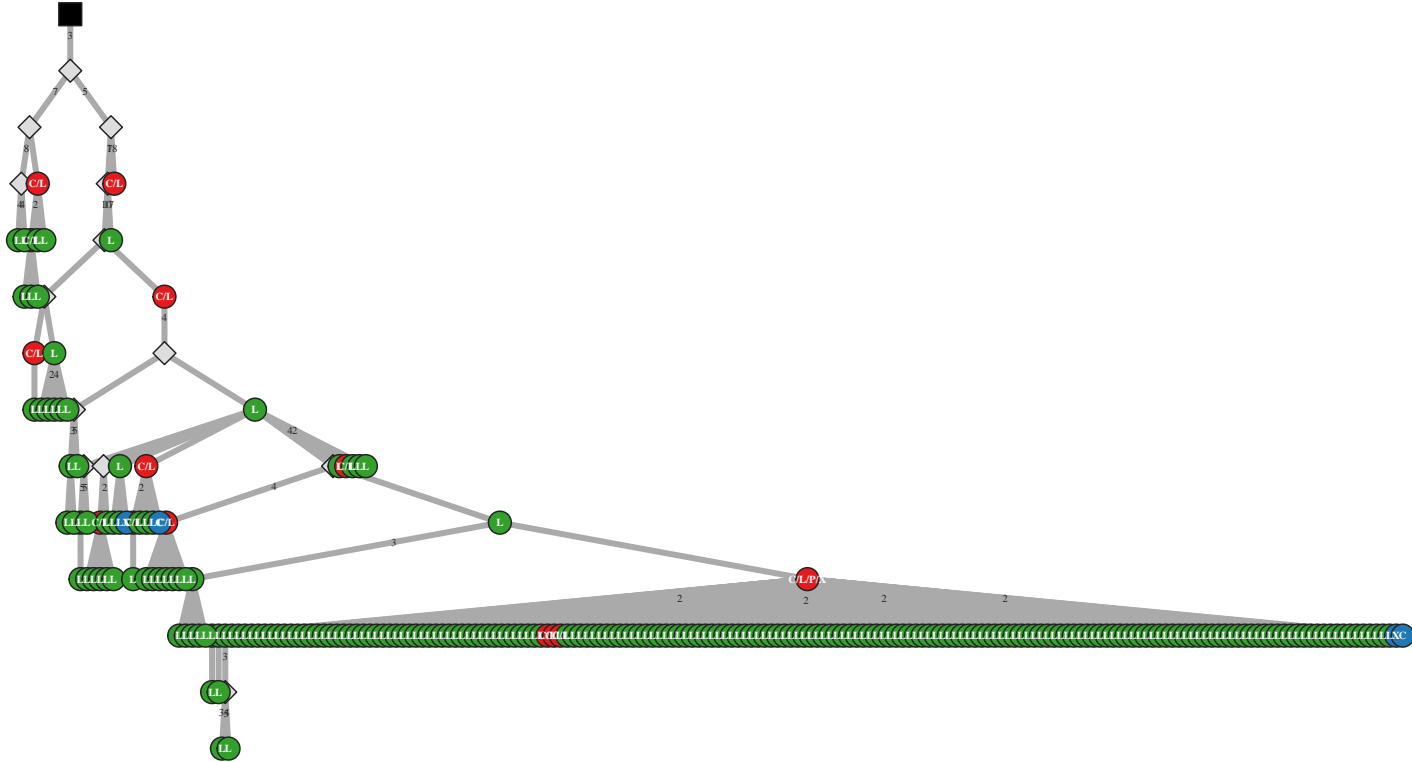

M5 IgG IGHV3-30-3/J4 39bp (7170)

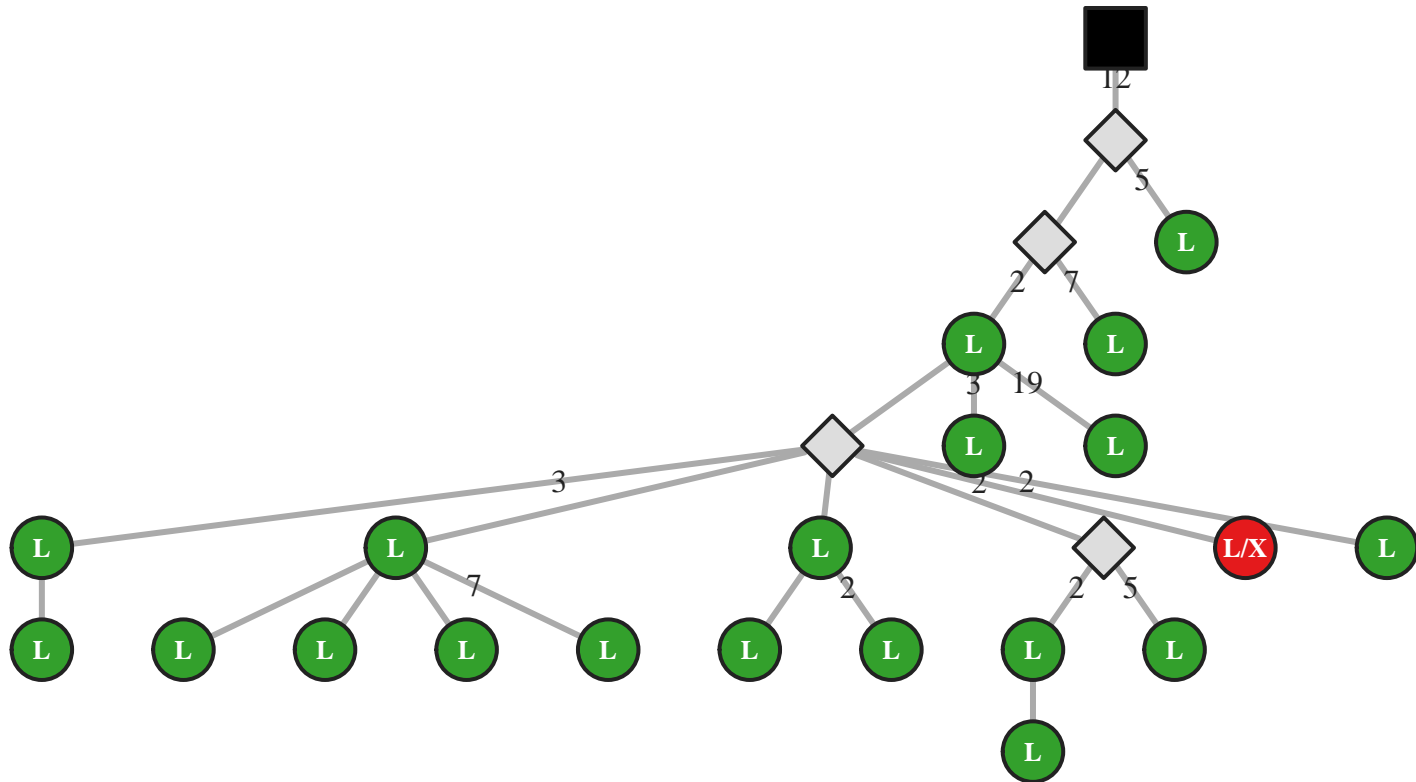

M5 IgG IGHV3-30-3/J4 39bp (7199)

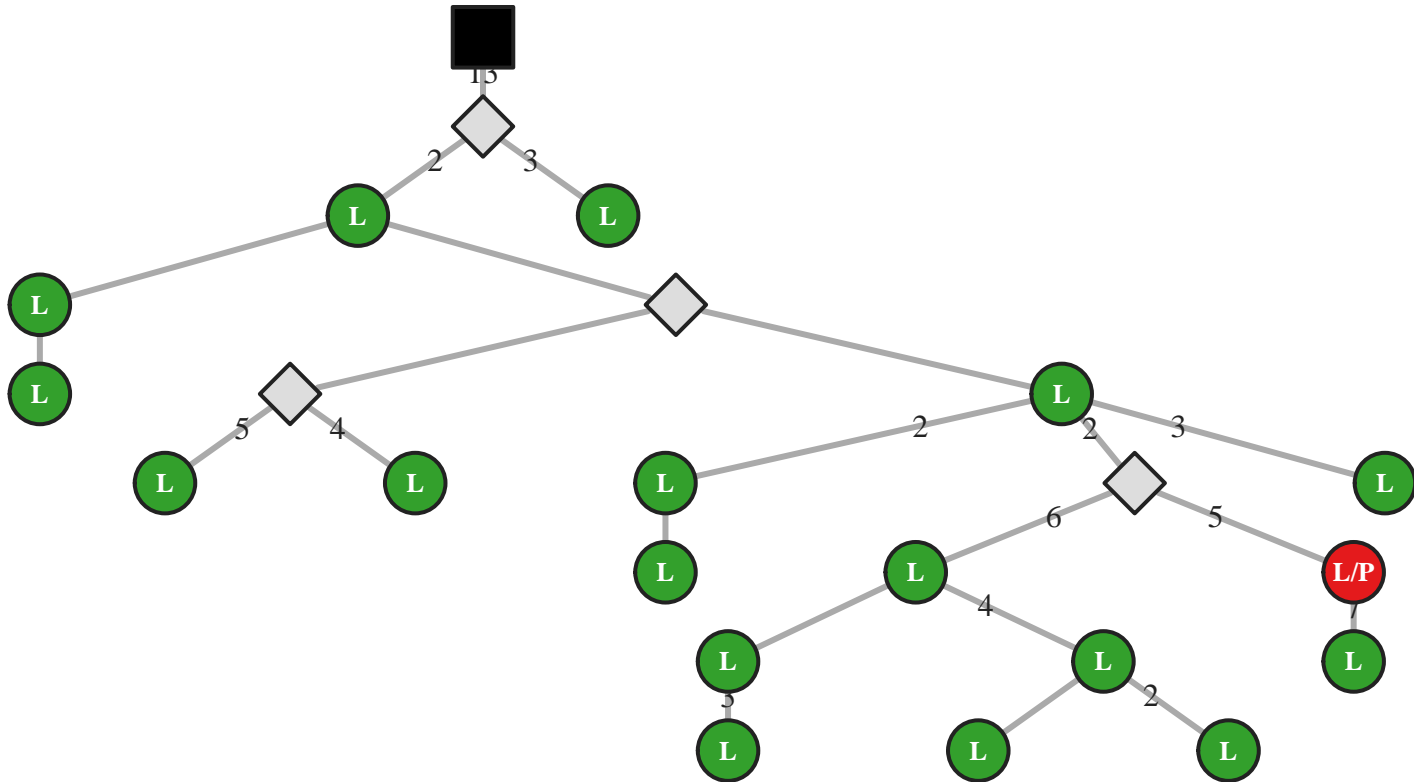

M5 IgG IGHV3-30-3/J4 39bp (7267)

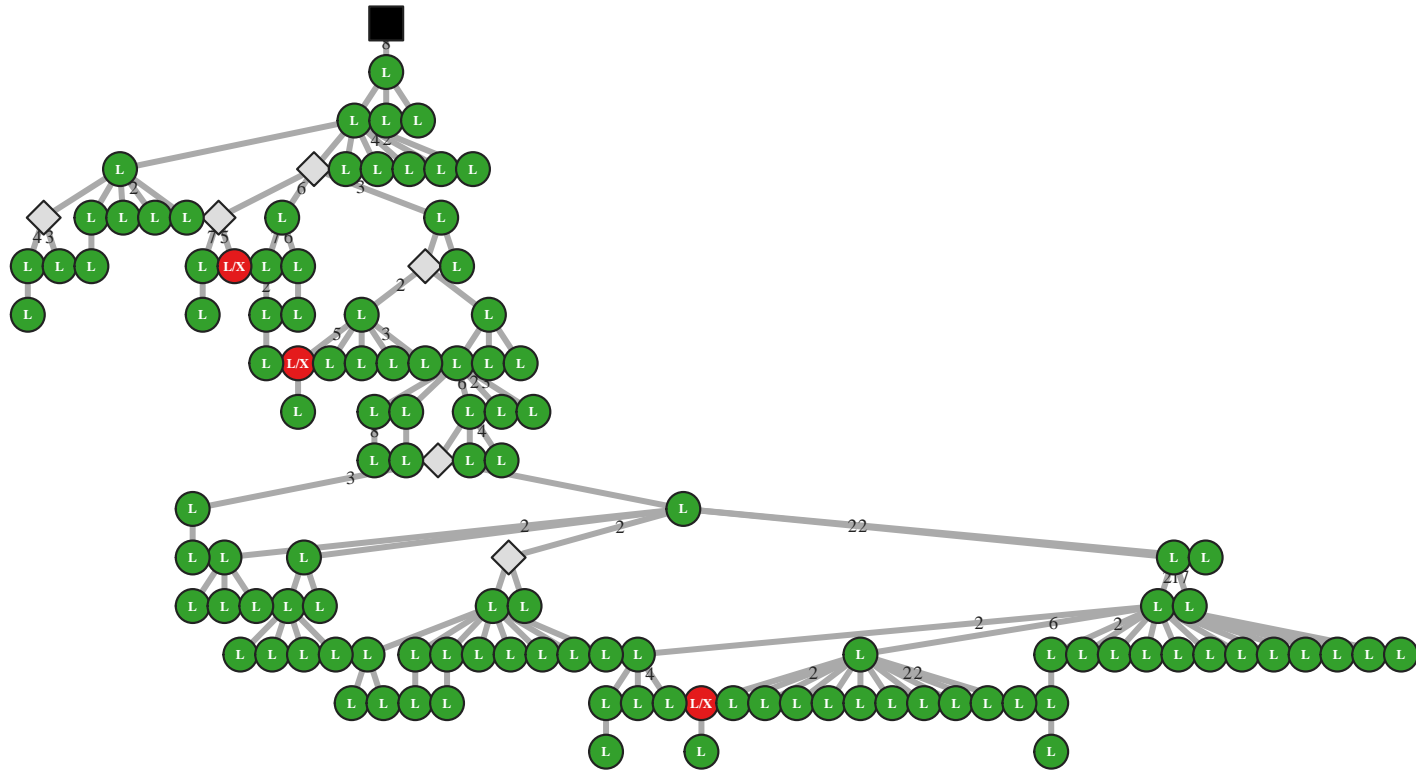

M5 IgG IGHV3-30-3/J4 39bp (7274)

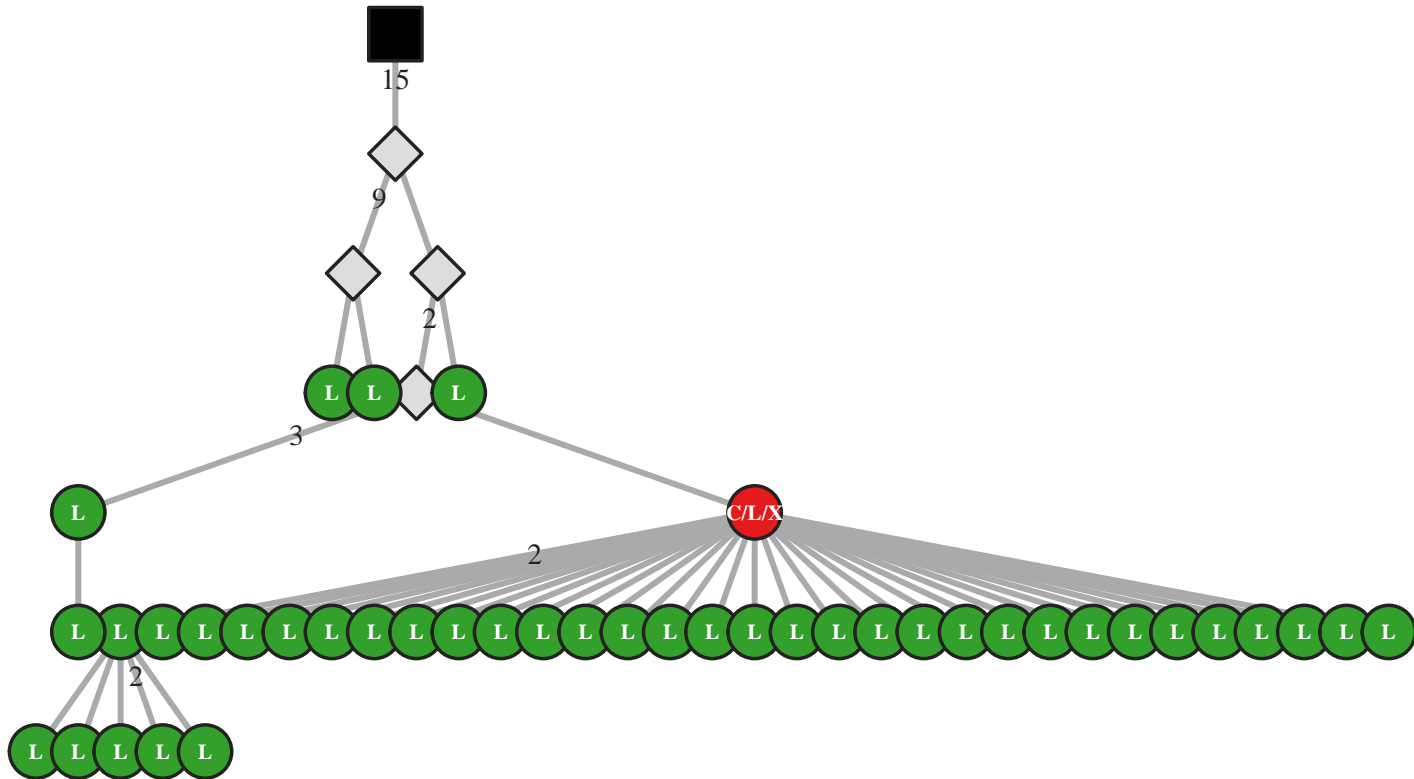

M5 IgG IGHV3-30-3/J4 39bp (7276)

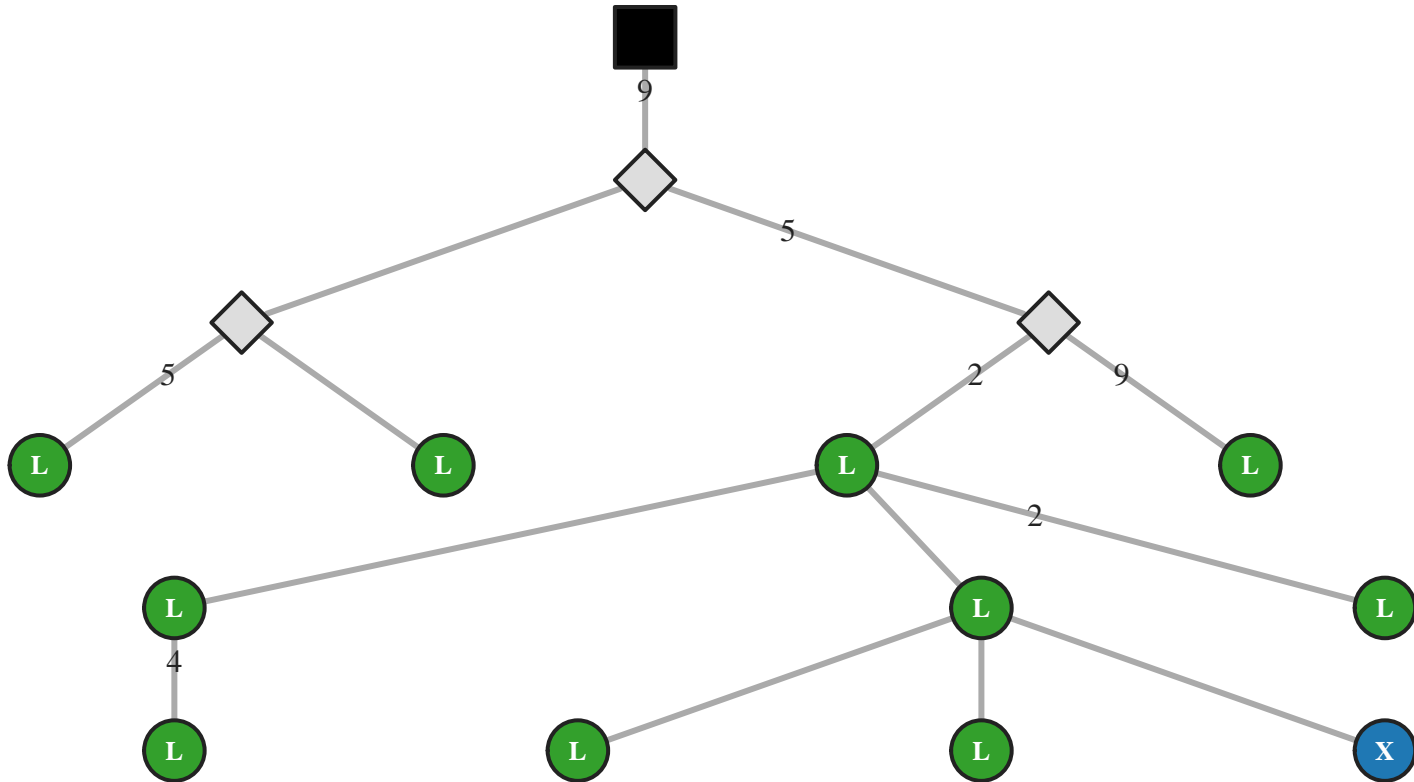

M5 IgG IGHV3-30-3/J4 42bp (44012)

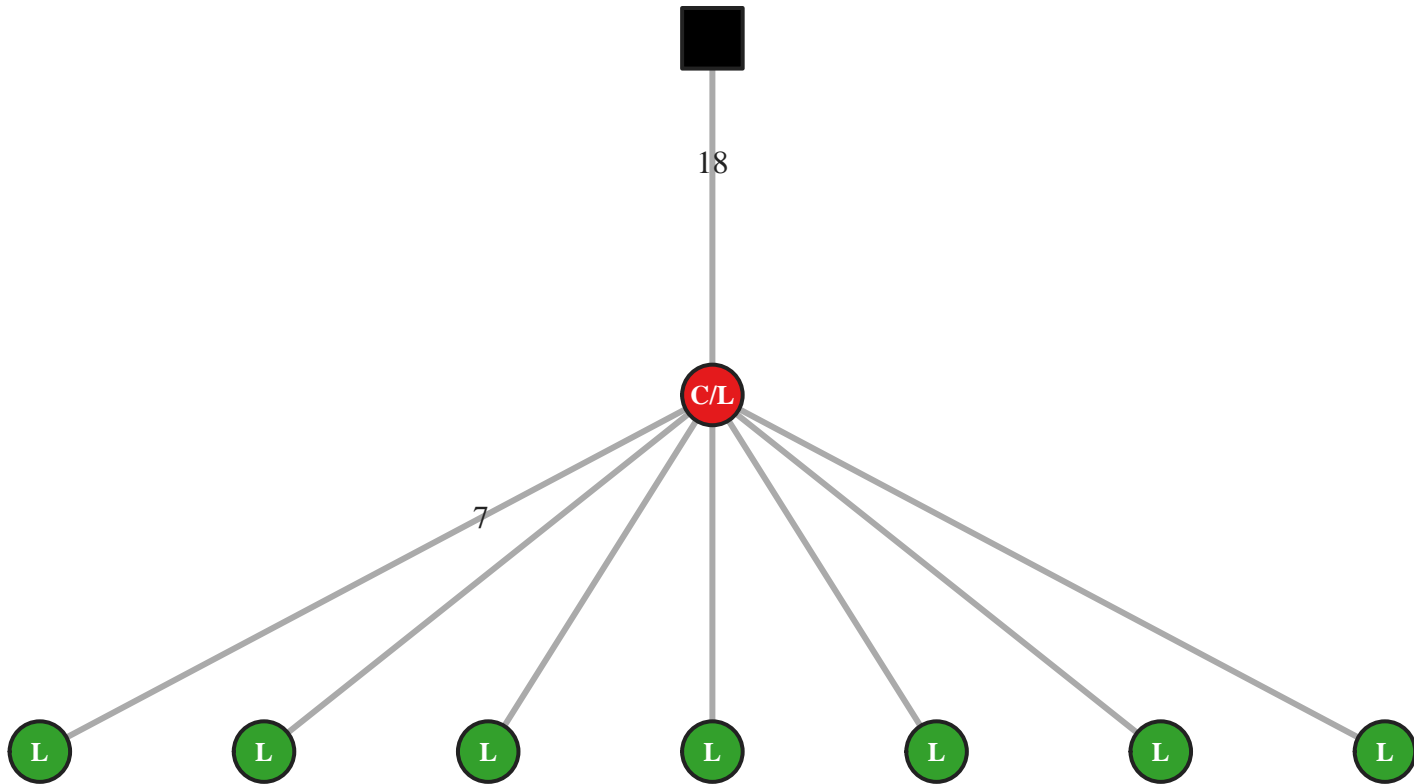

M5 IgA IGHV3-30-3/J4 45bp (2747)

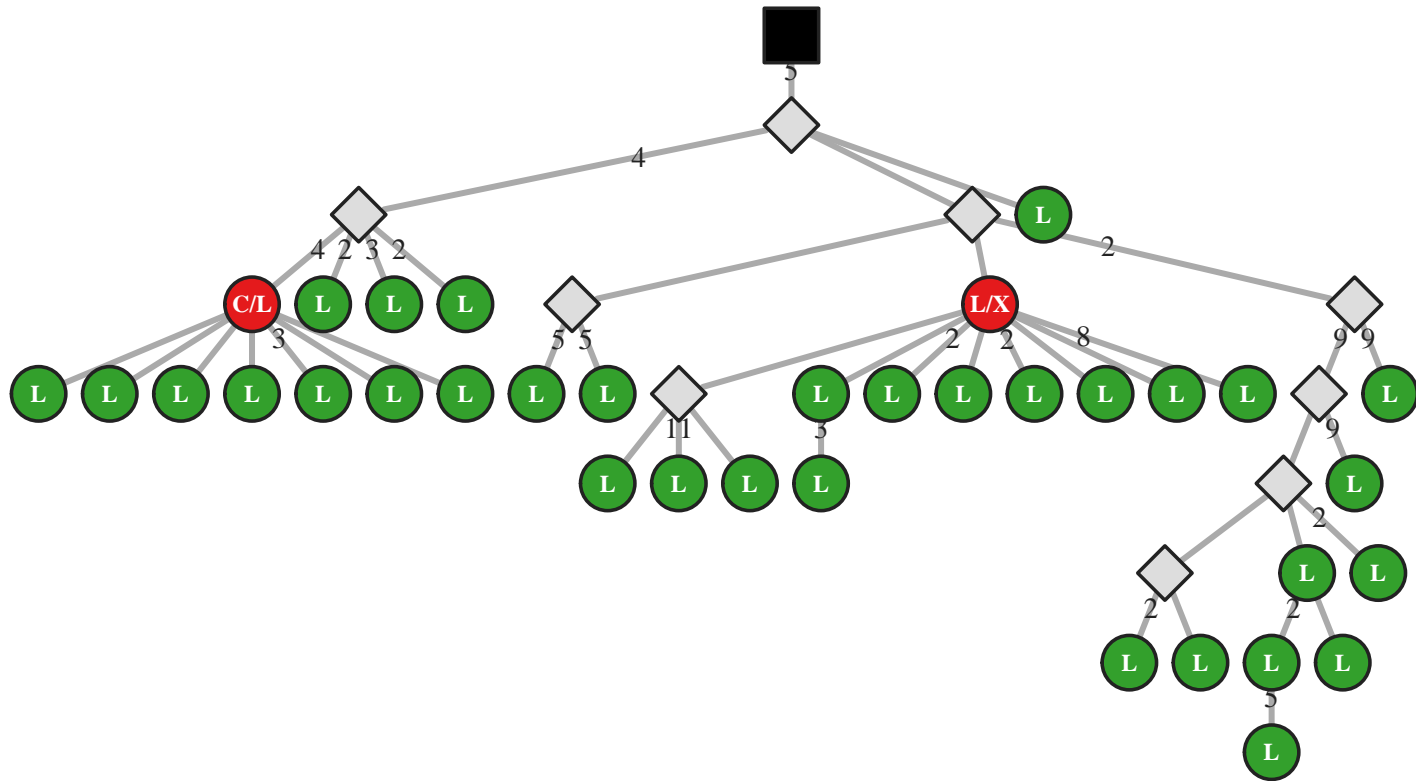

M5 IgG IGHV3-30-3/J4 48bp (7399)

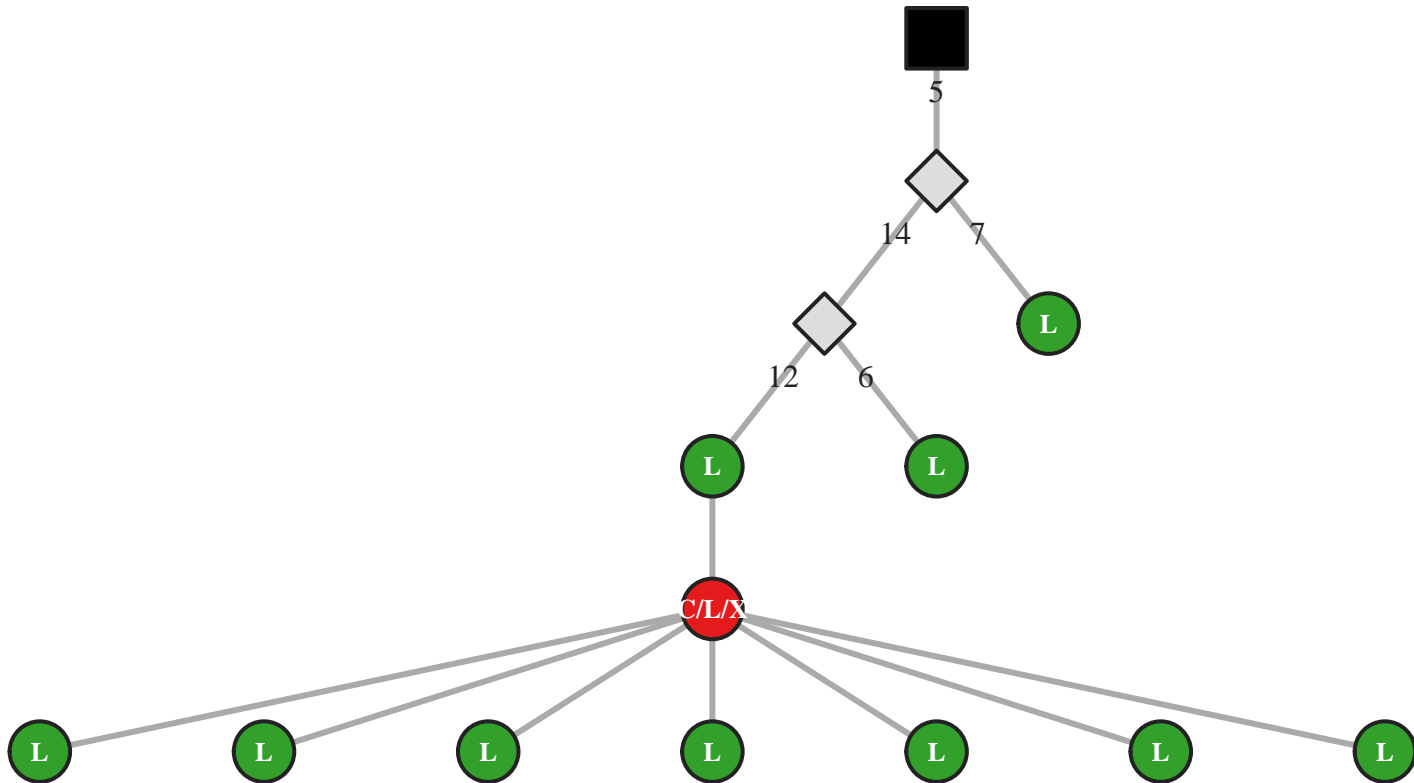

M5 IgG IGHV3-30-3/J4 48bp (7434)

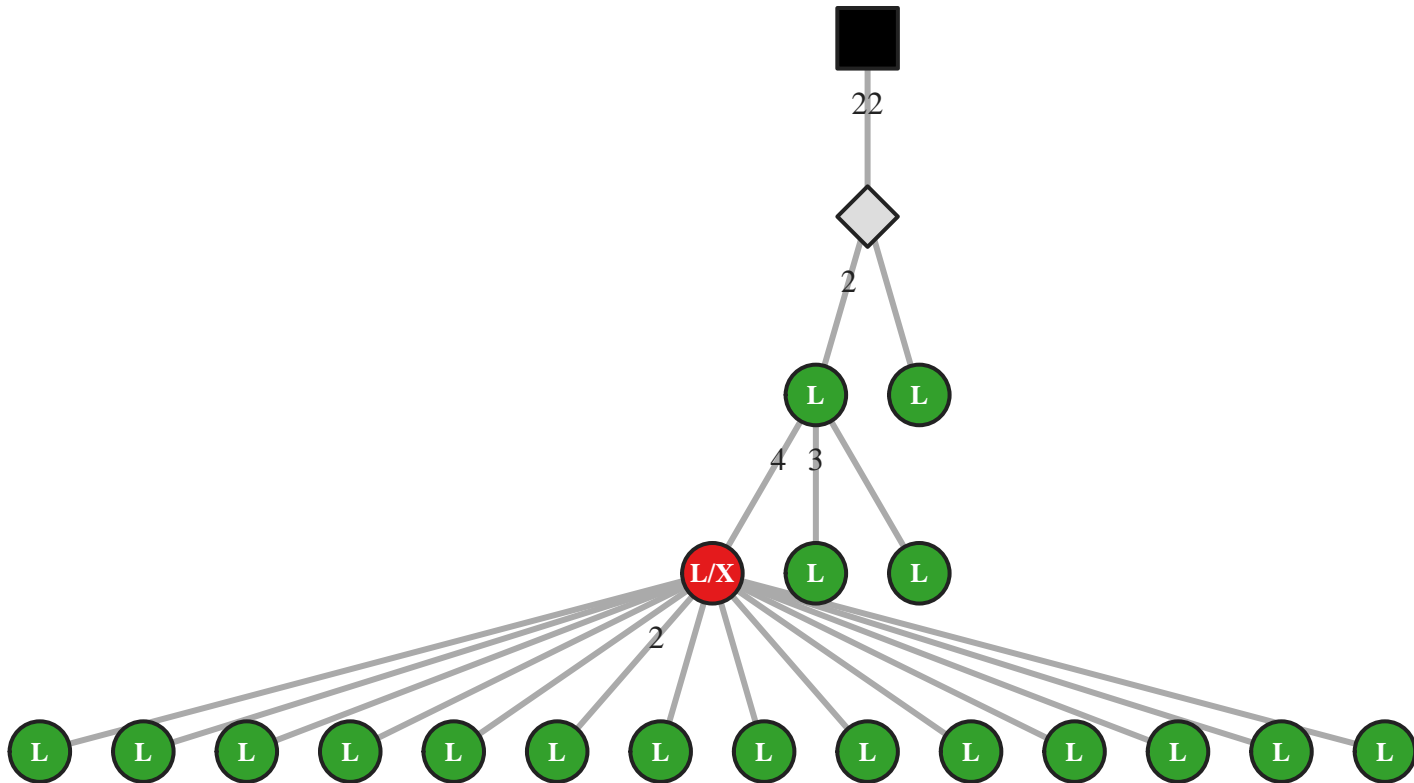

M5 IgG IGHV3-30-3/J4 48bp (7643)

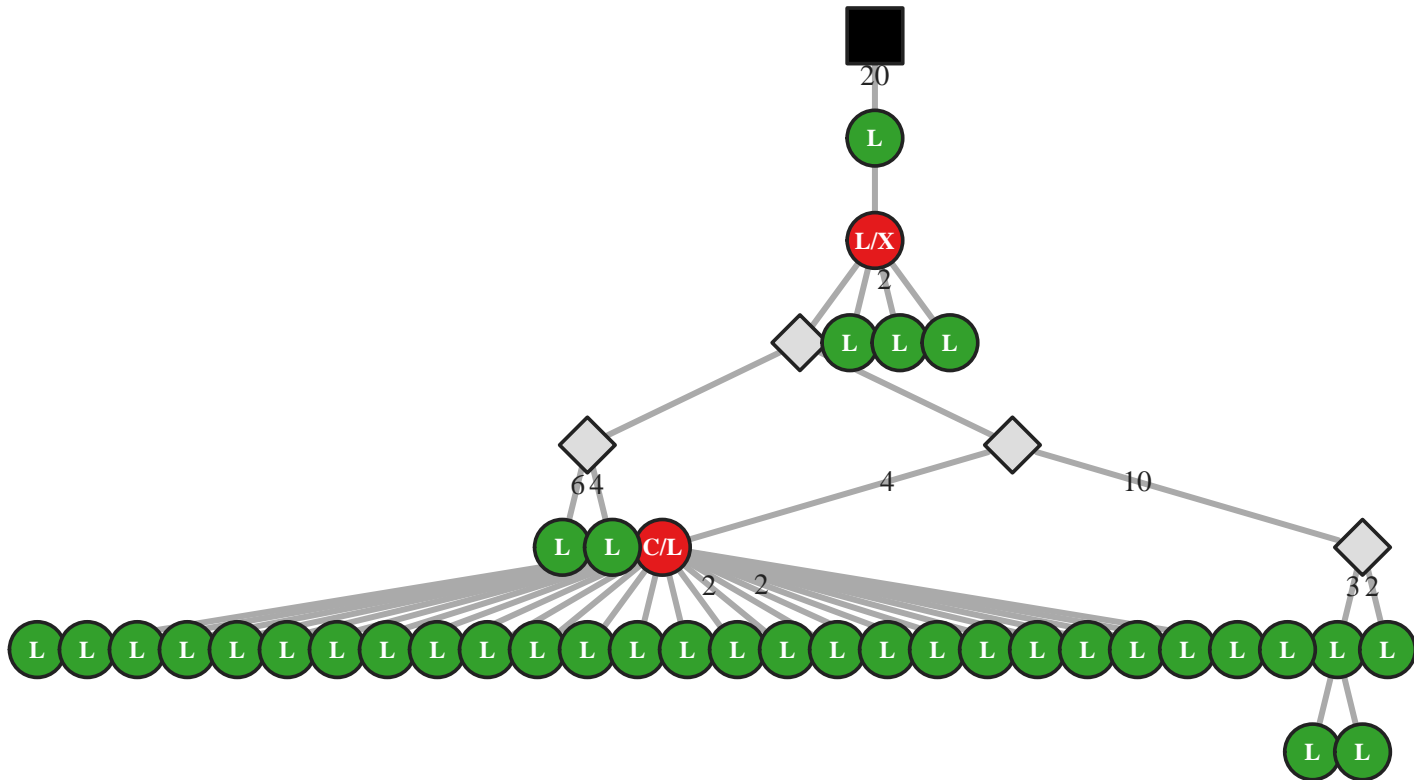

M5 IgG IGHV3-30-3/J4 48bp (7659)

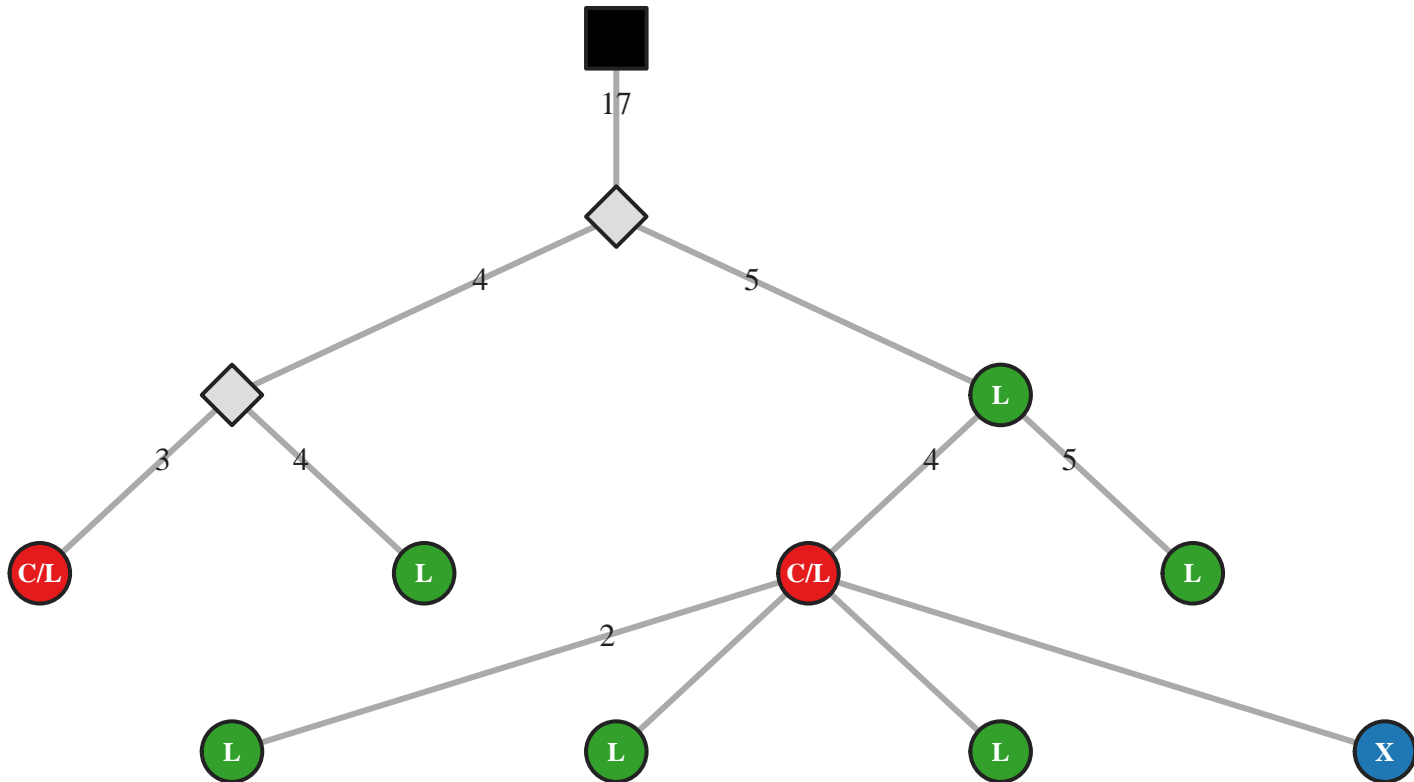

M5 IgG IGHV3-30-3/J4 51bp (44169)

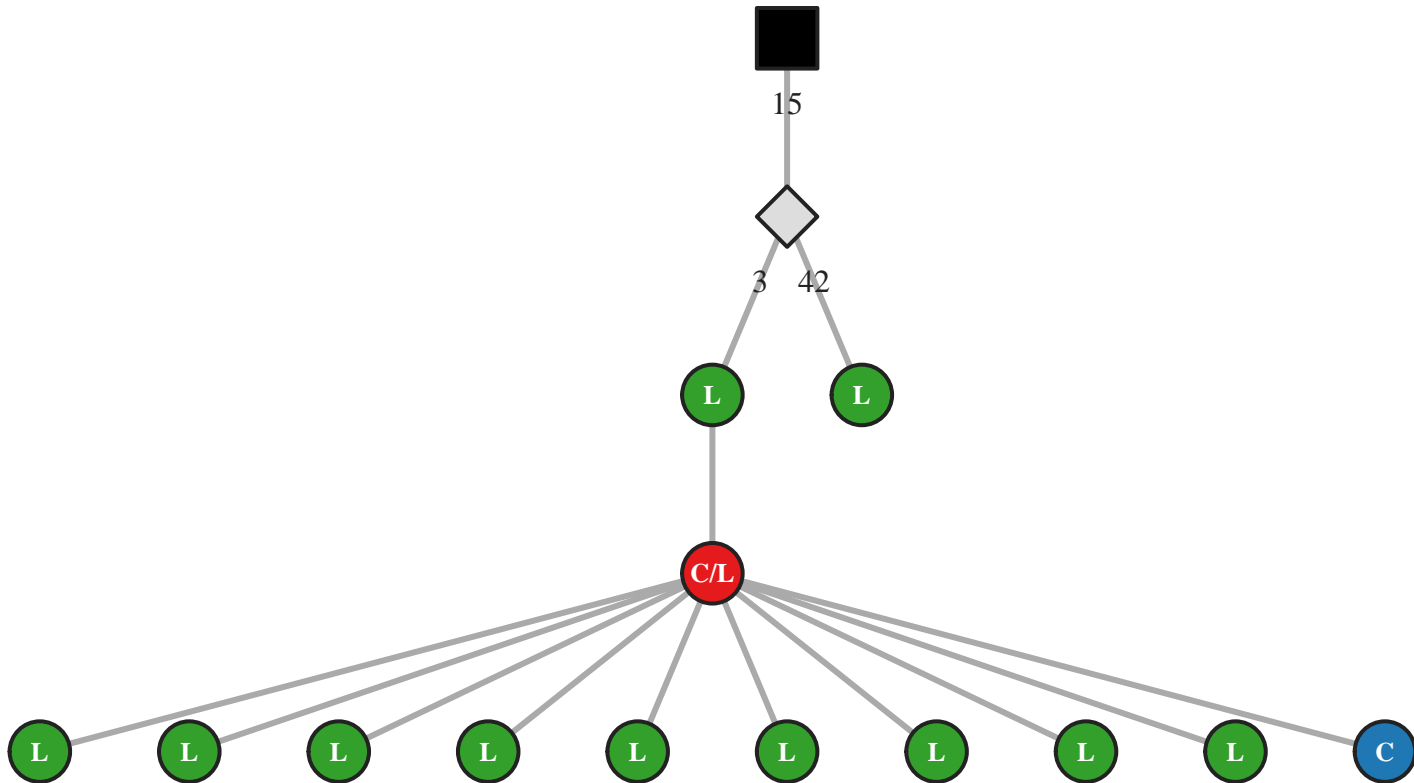

M5 IgG IGHV3-30-3/J4 51bp (44255)

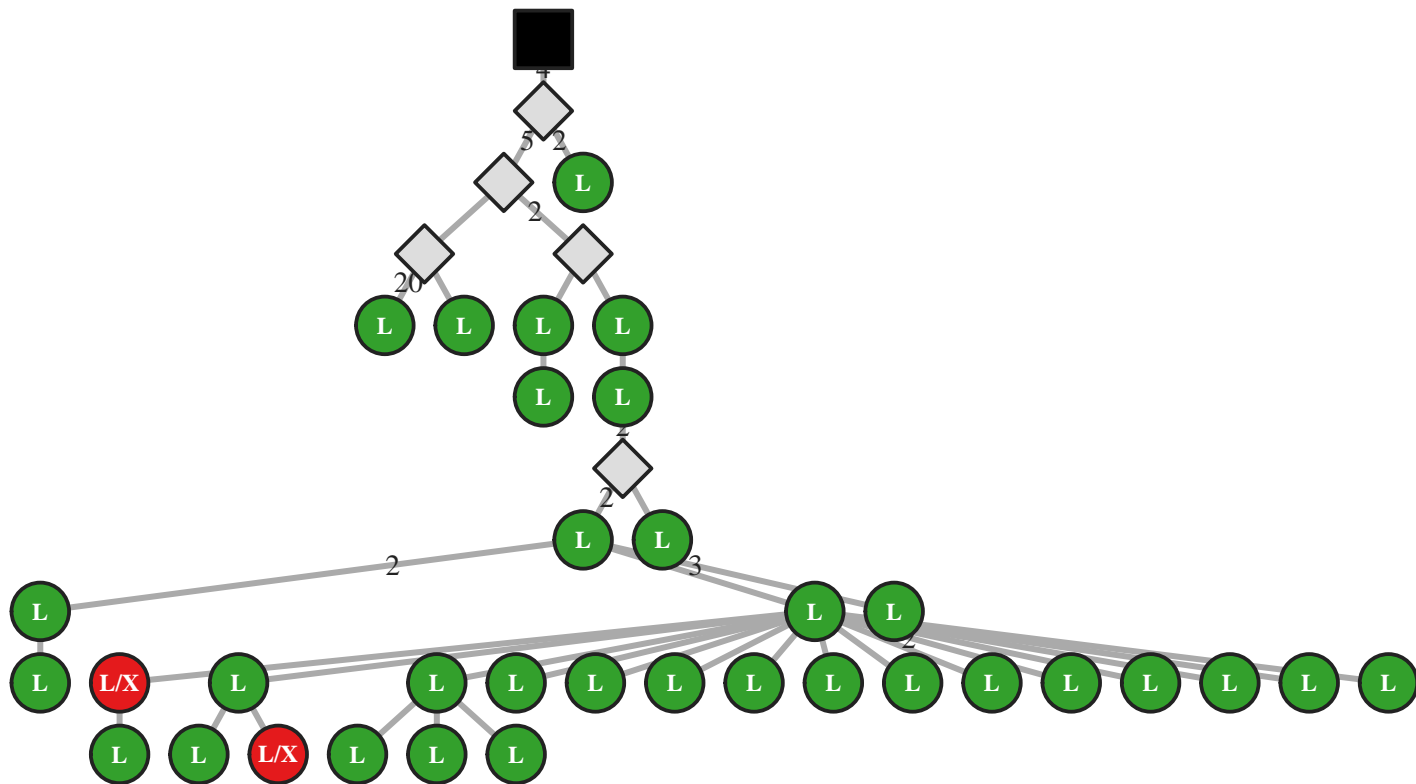

M5 IgG IGHV3-30-3/J4 54bp (34469)

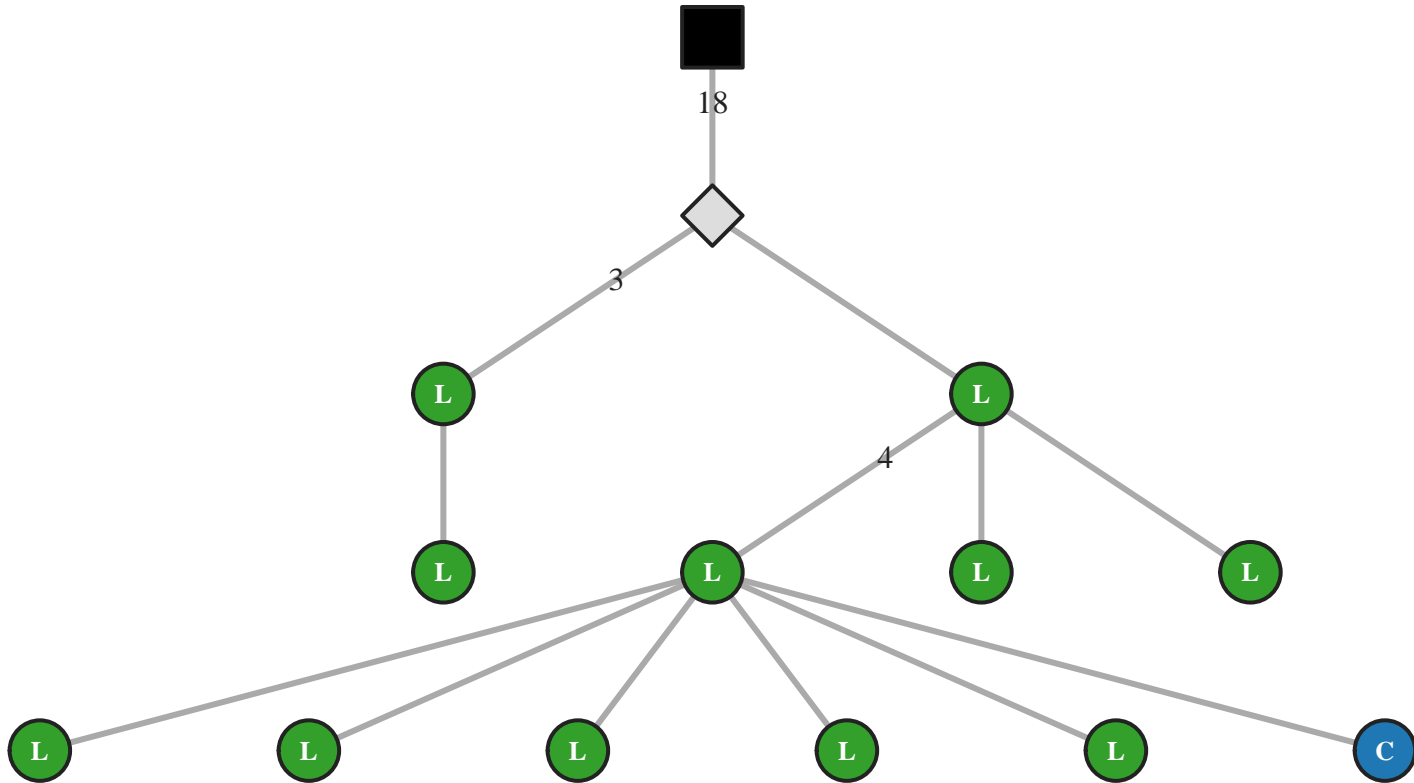

M5 IgG IGHV3-30-3/J4 54bp (34485)

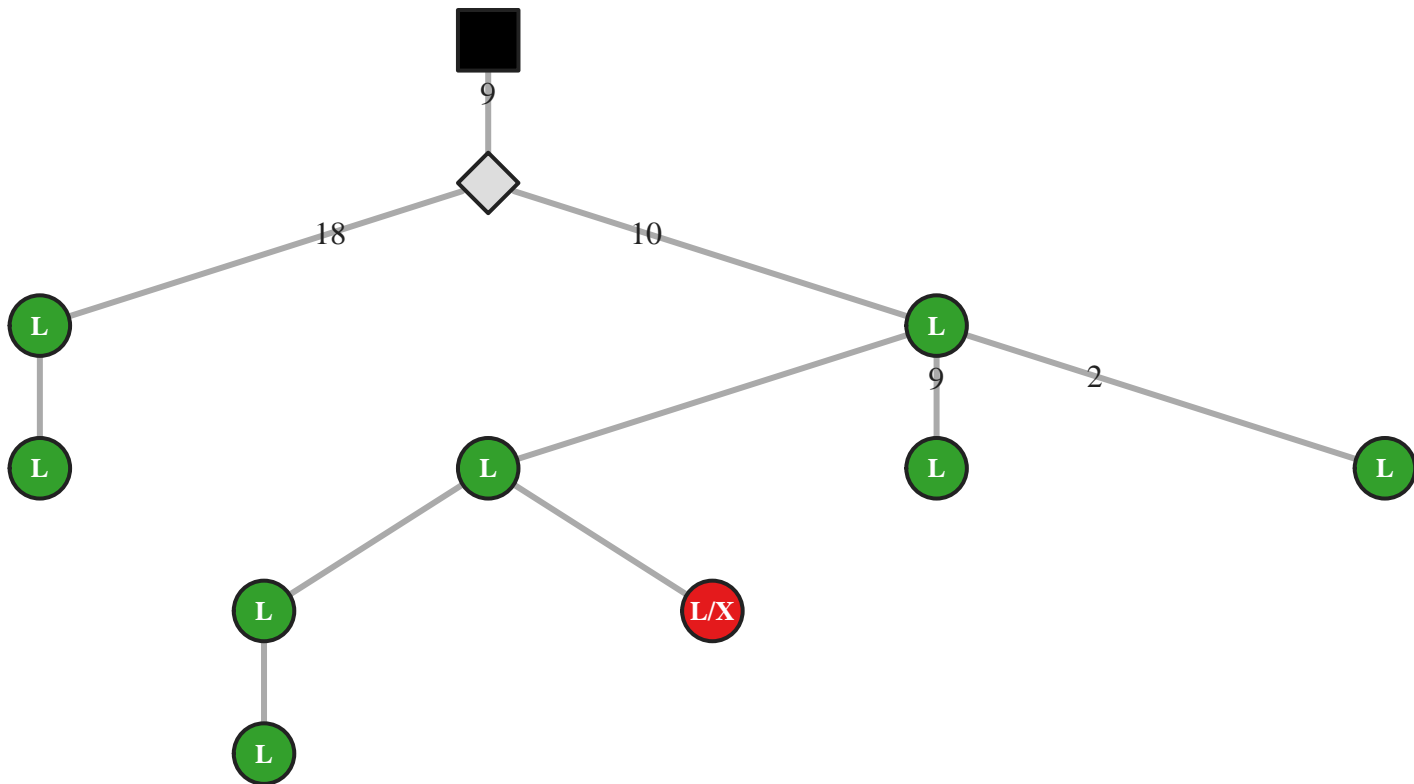

M5 IgG IGHV3-30-3/J4 54bp (34502)

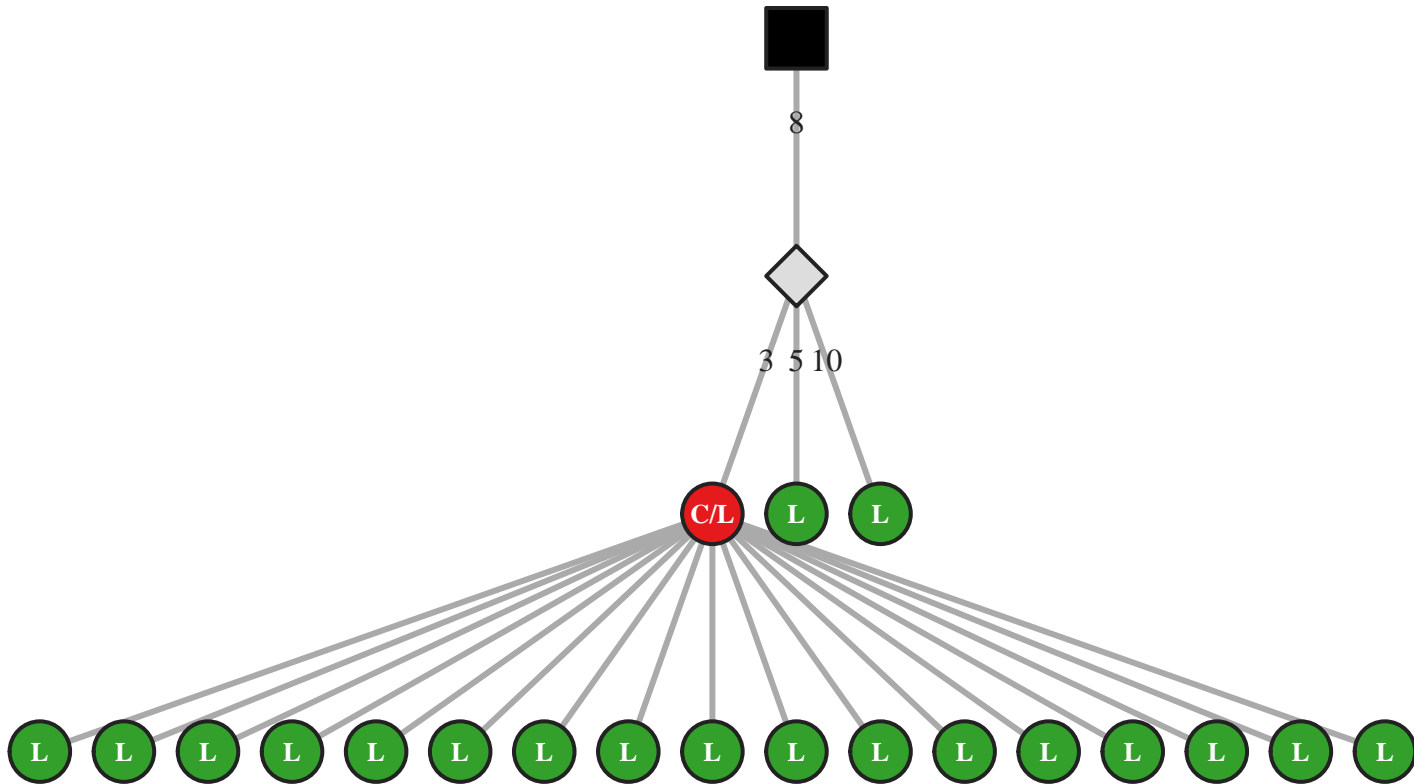

M5 IgG IGHV3-30-3/J5 75bp (44973)

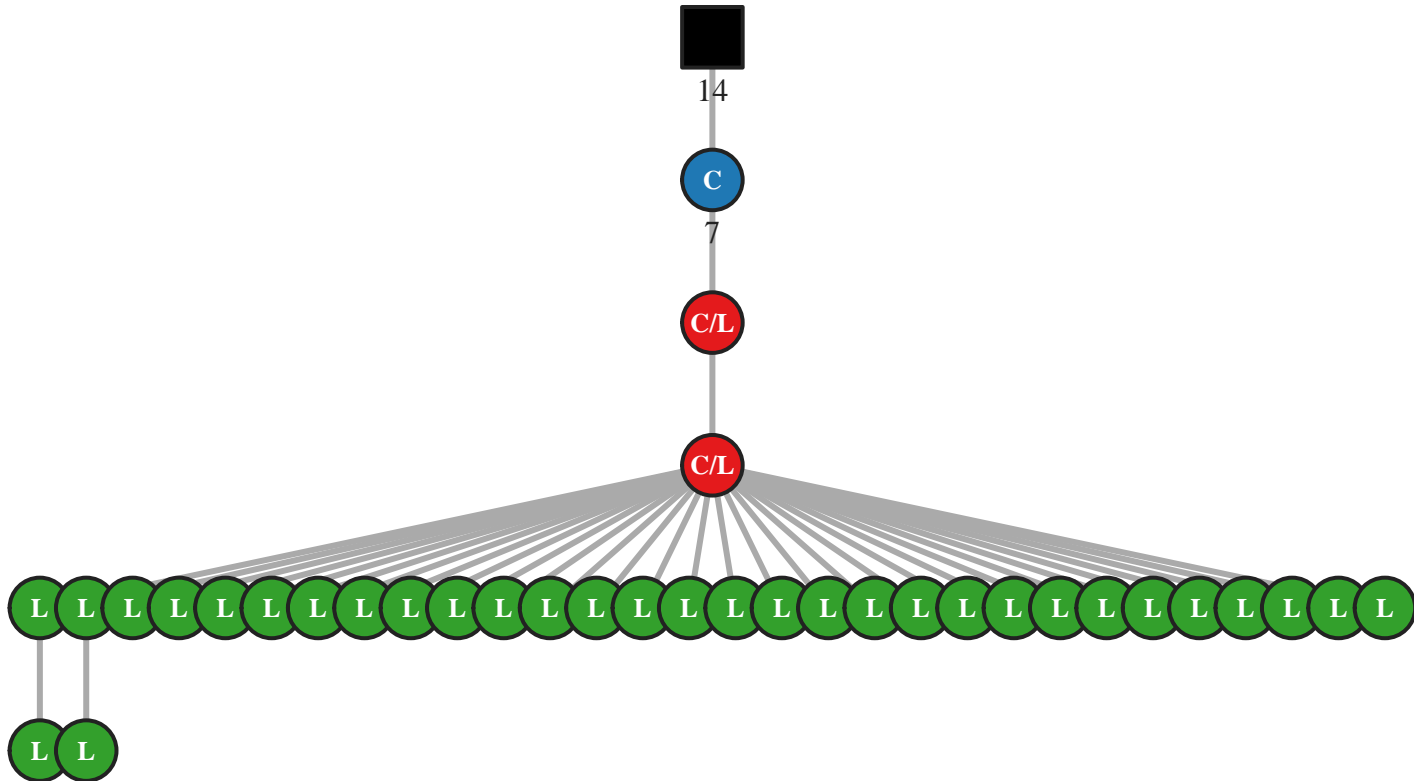

M5 IgG IGHV3-30-3/J6 33bp (26371)

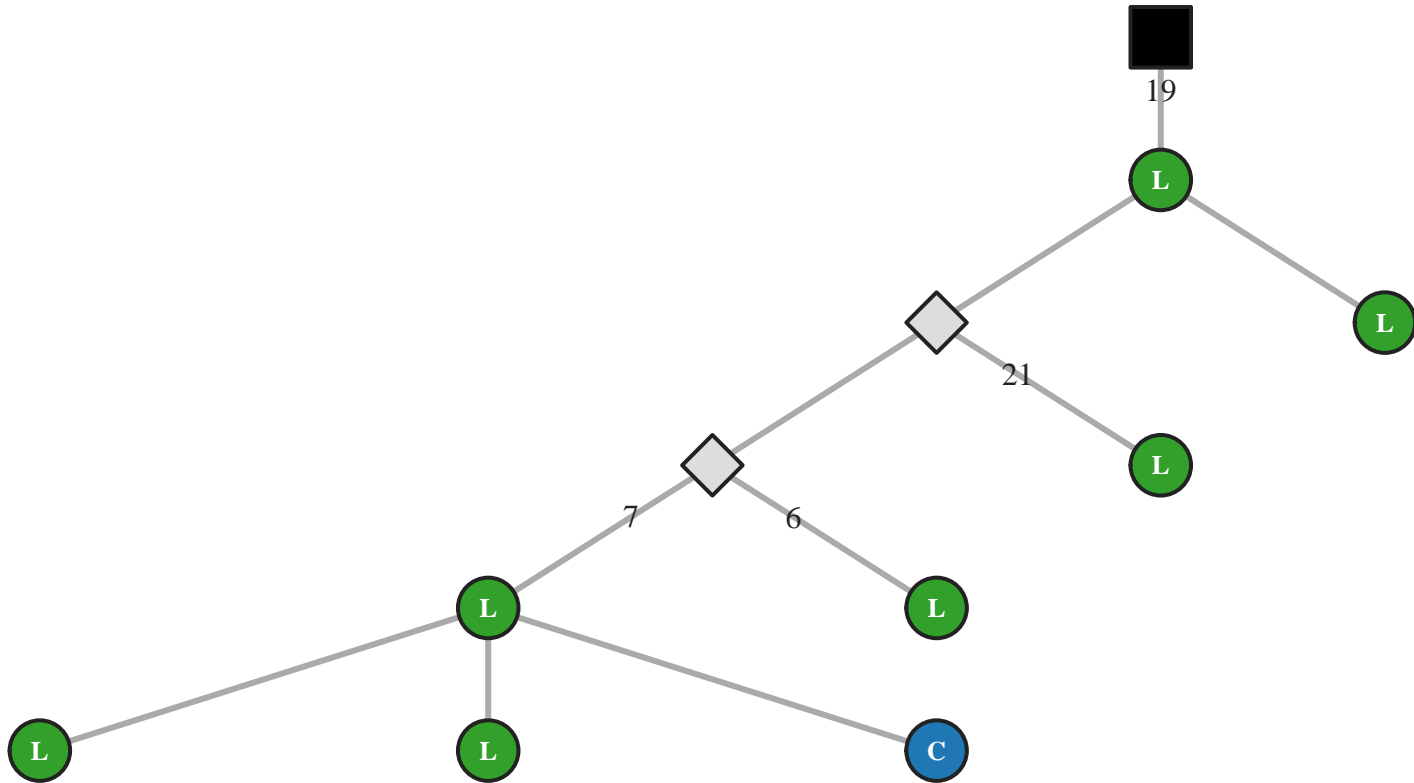

M5 IgG IGHV3-30-3/J6 57bp (26103)

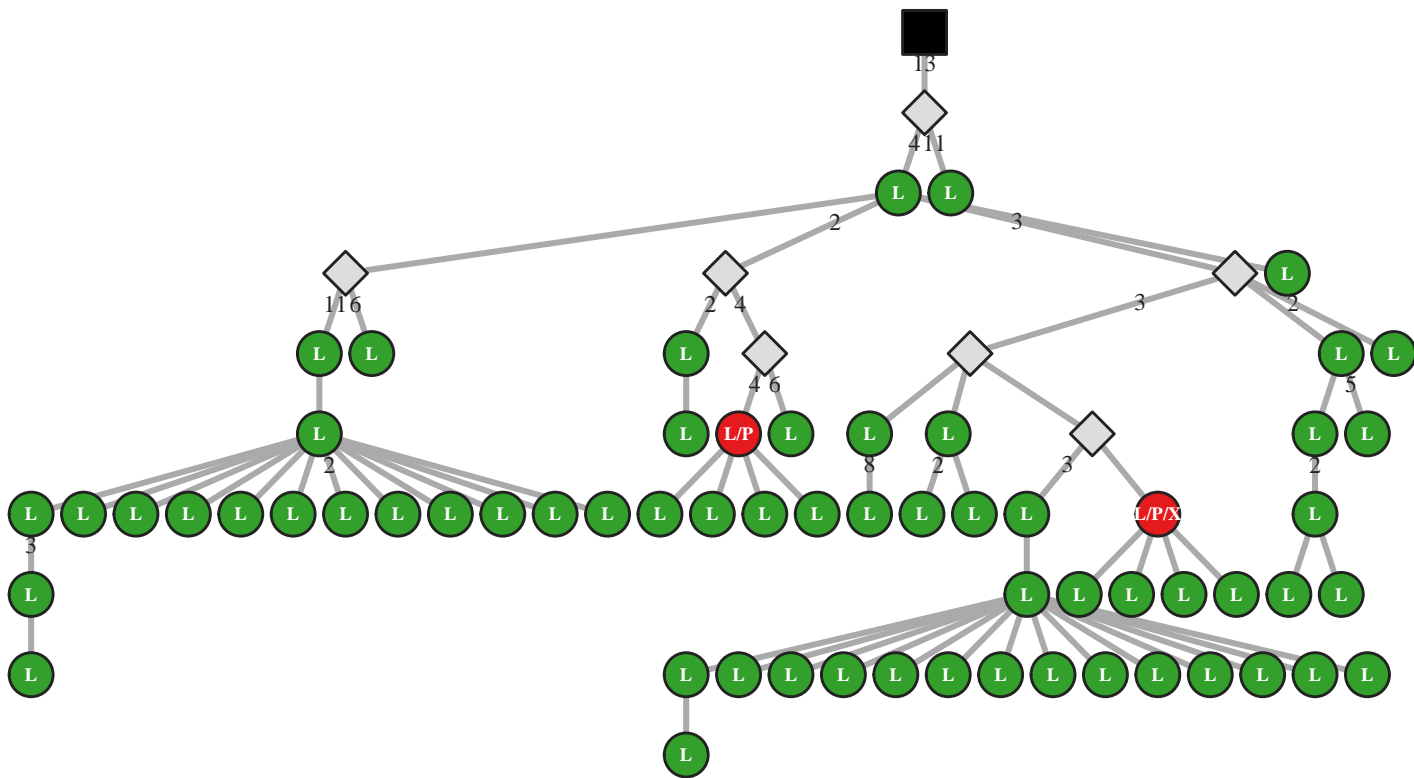

M5 IgG IGHV3-30-3/J6 57bp (26163)

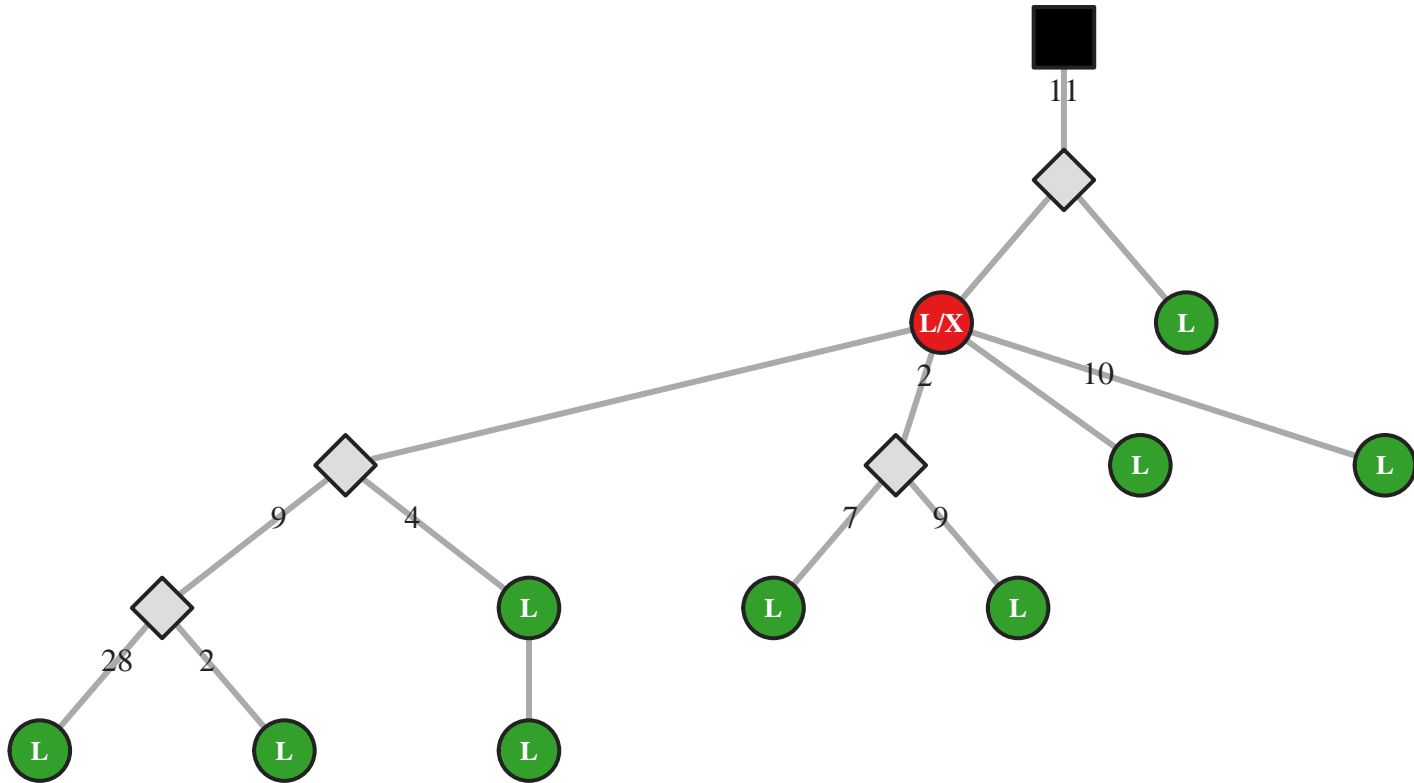

M5 IgG IGHV3-30-3/J6 60bp (26243)

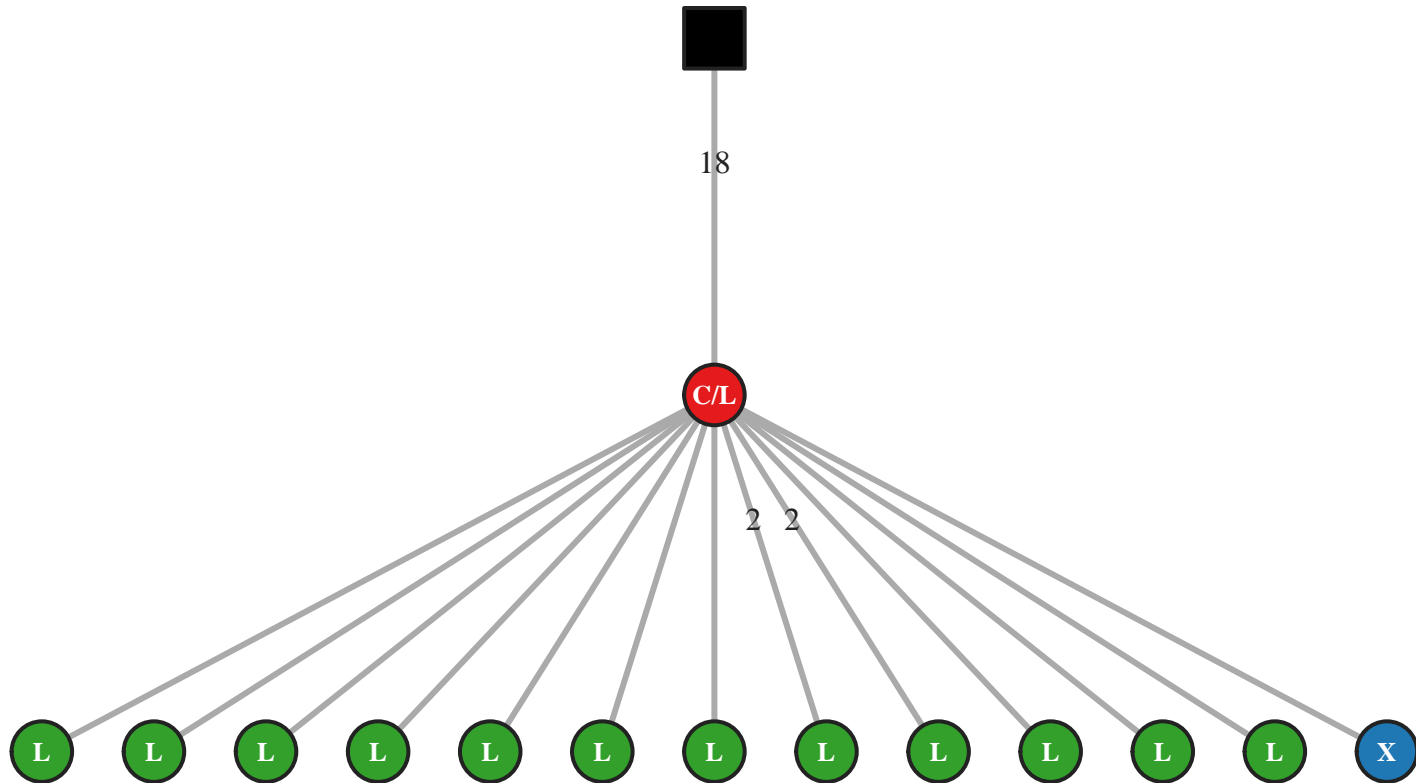

M5 IgG IGHV3-30-3/J6 60bp (26292)

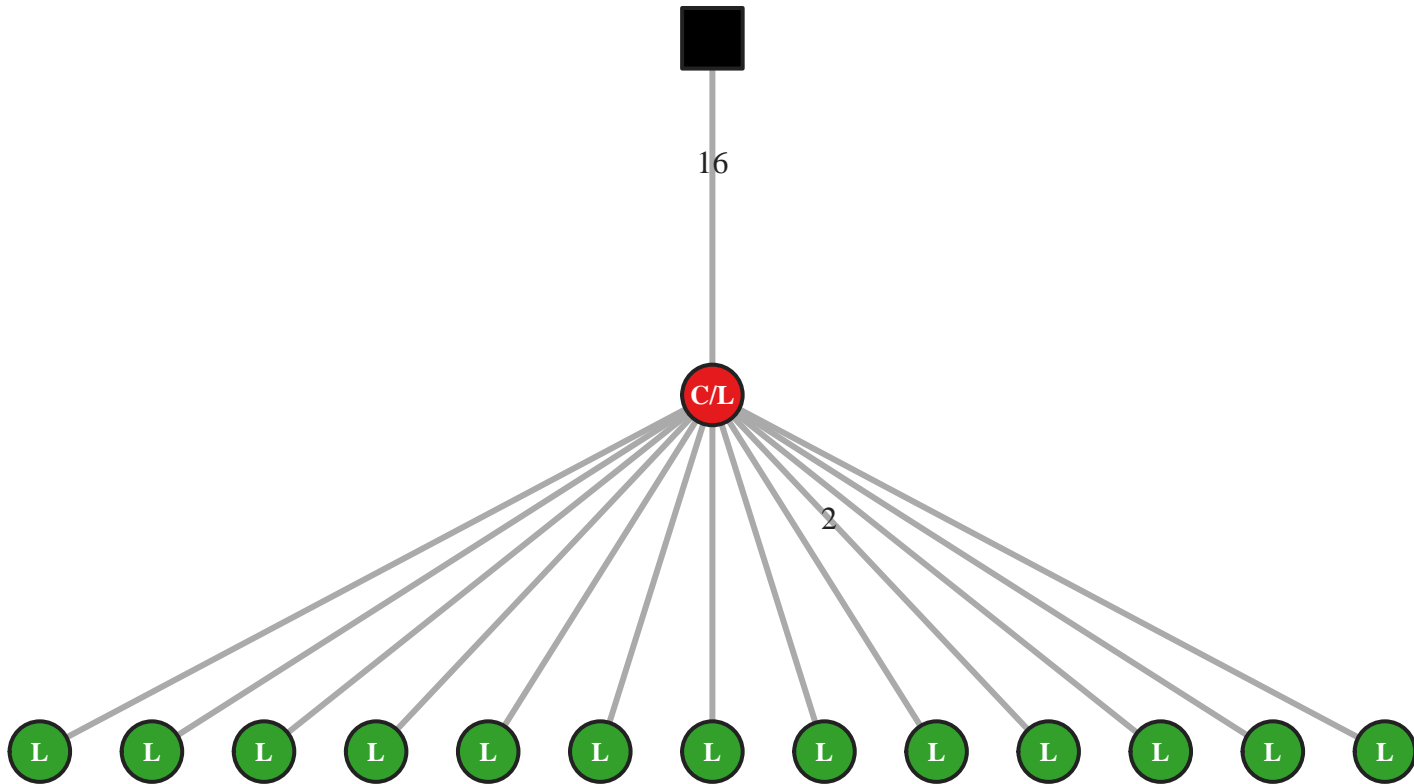

M5 IgG IGHV3-30-3/J6 69bp (44852)

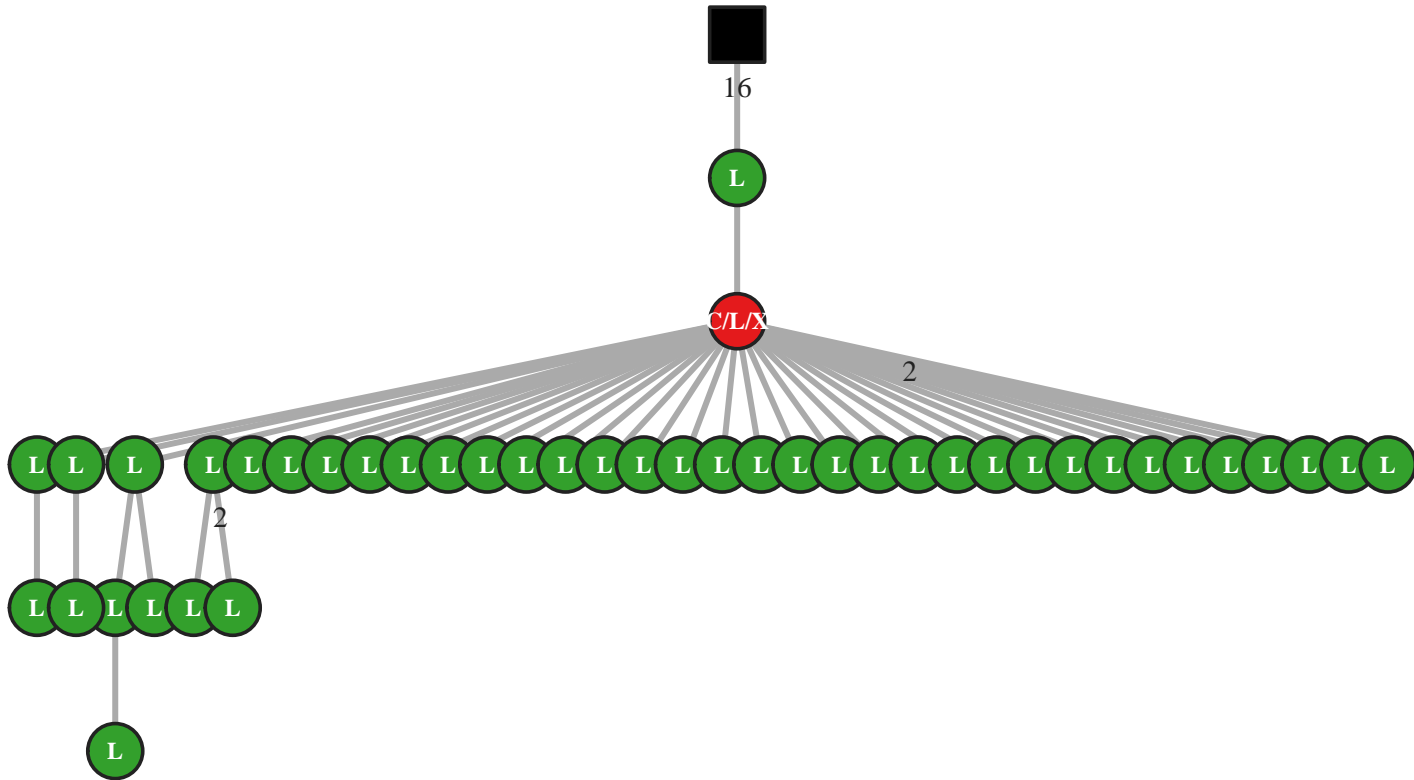

M5 IgG IGHV3-30-3/J6 69bp (44876)

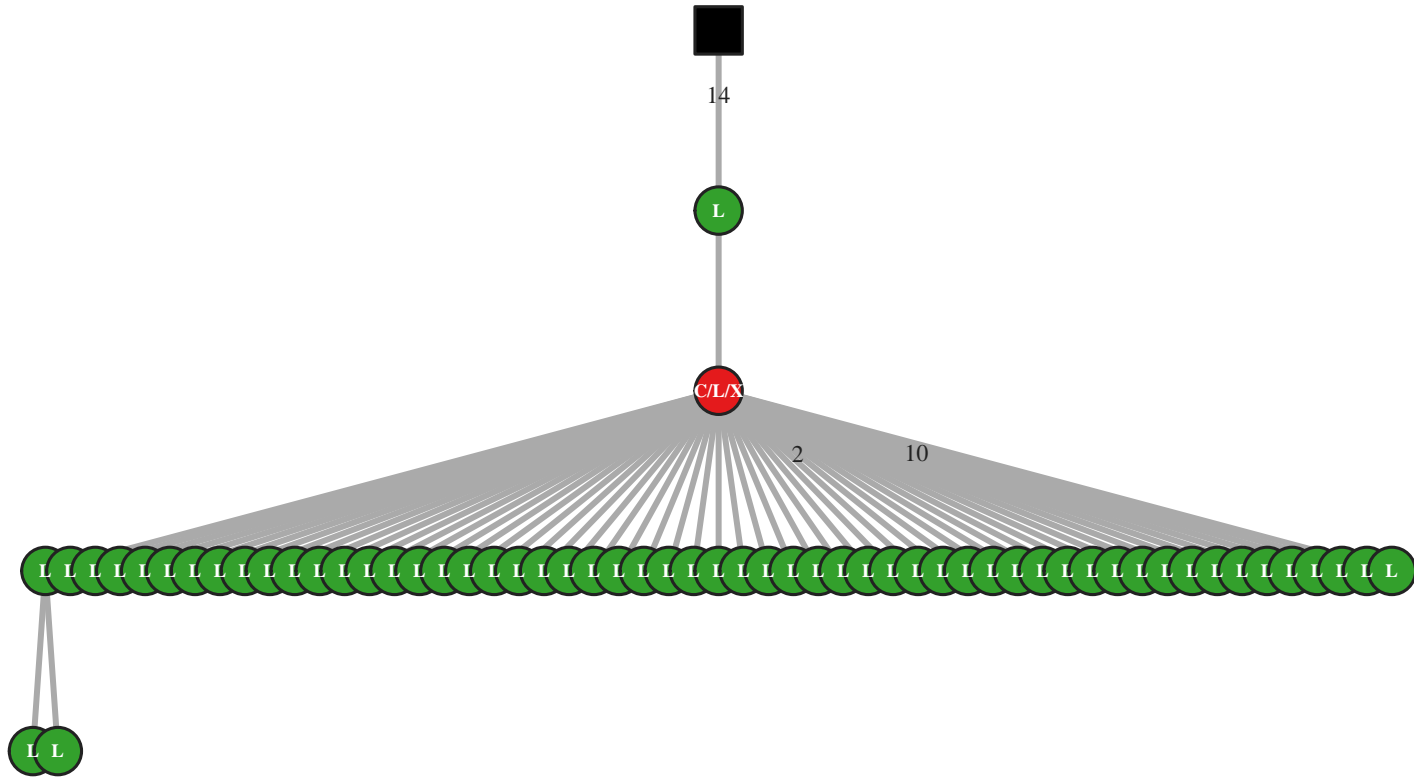

M5 IgG IGHV3-33/J1 36bp (51890)

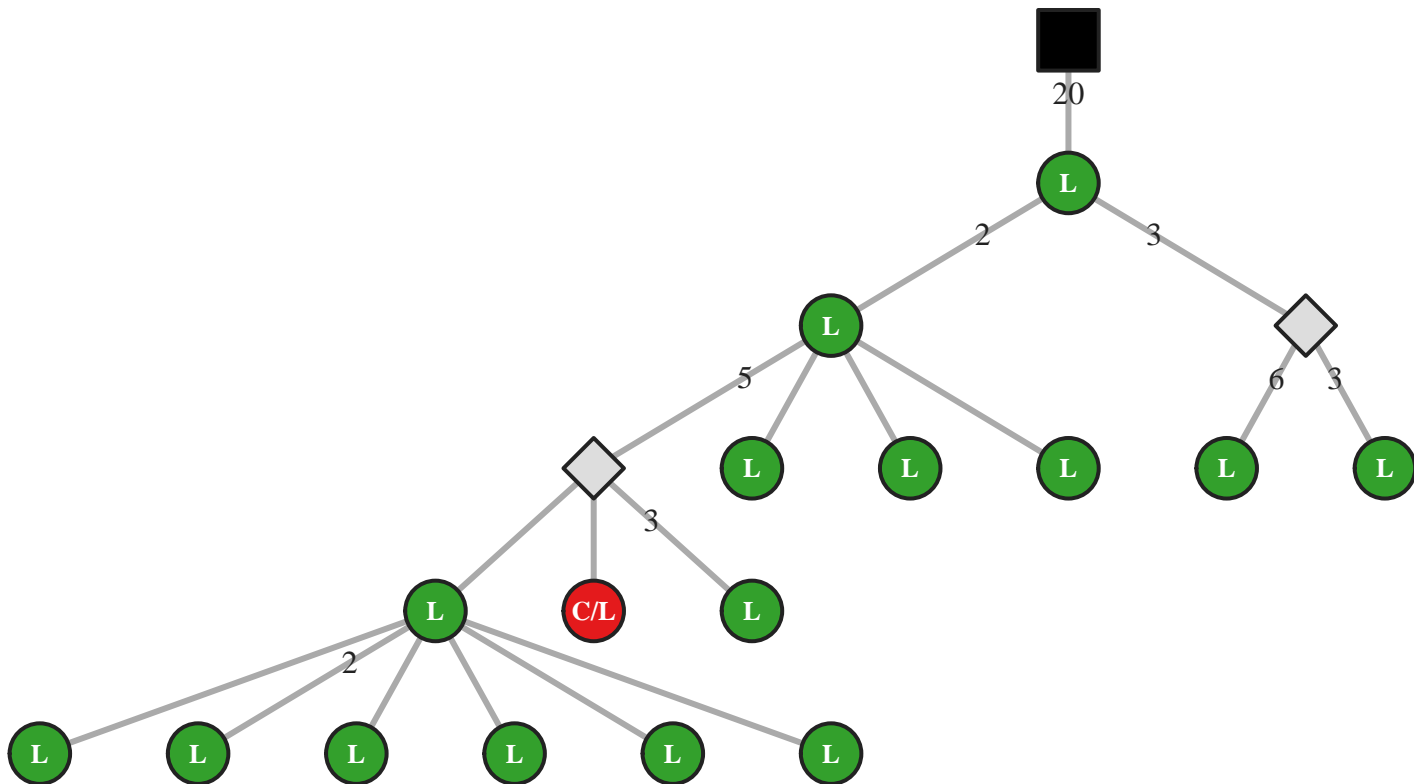

M5 IgG IGHV3-33/J1 42bp (45020)

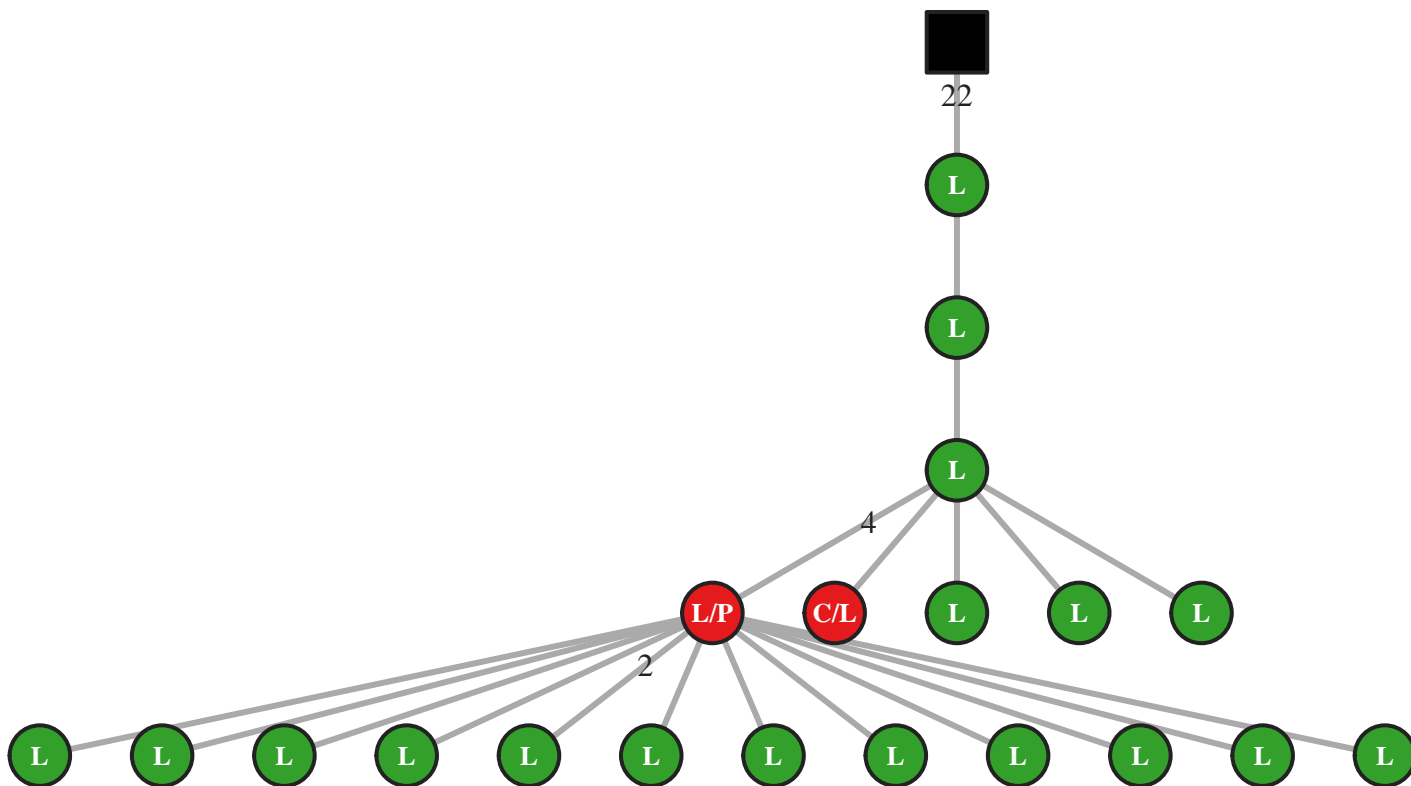

M5 IgG IGHV3-33/J1 66bp (45027)

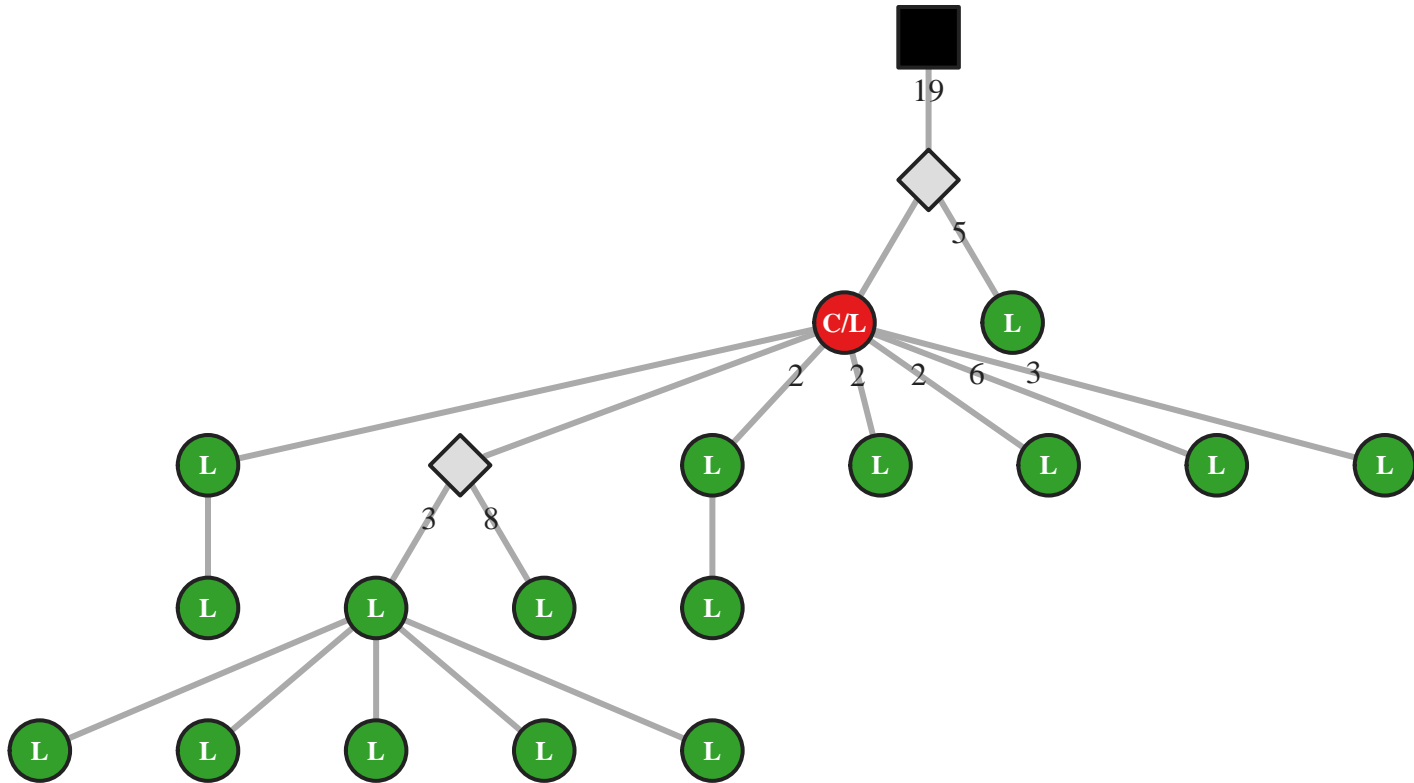

M5 IgG IGHV3-33/J2 54bp (45035)

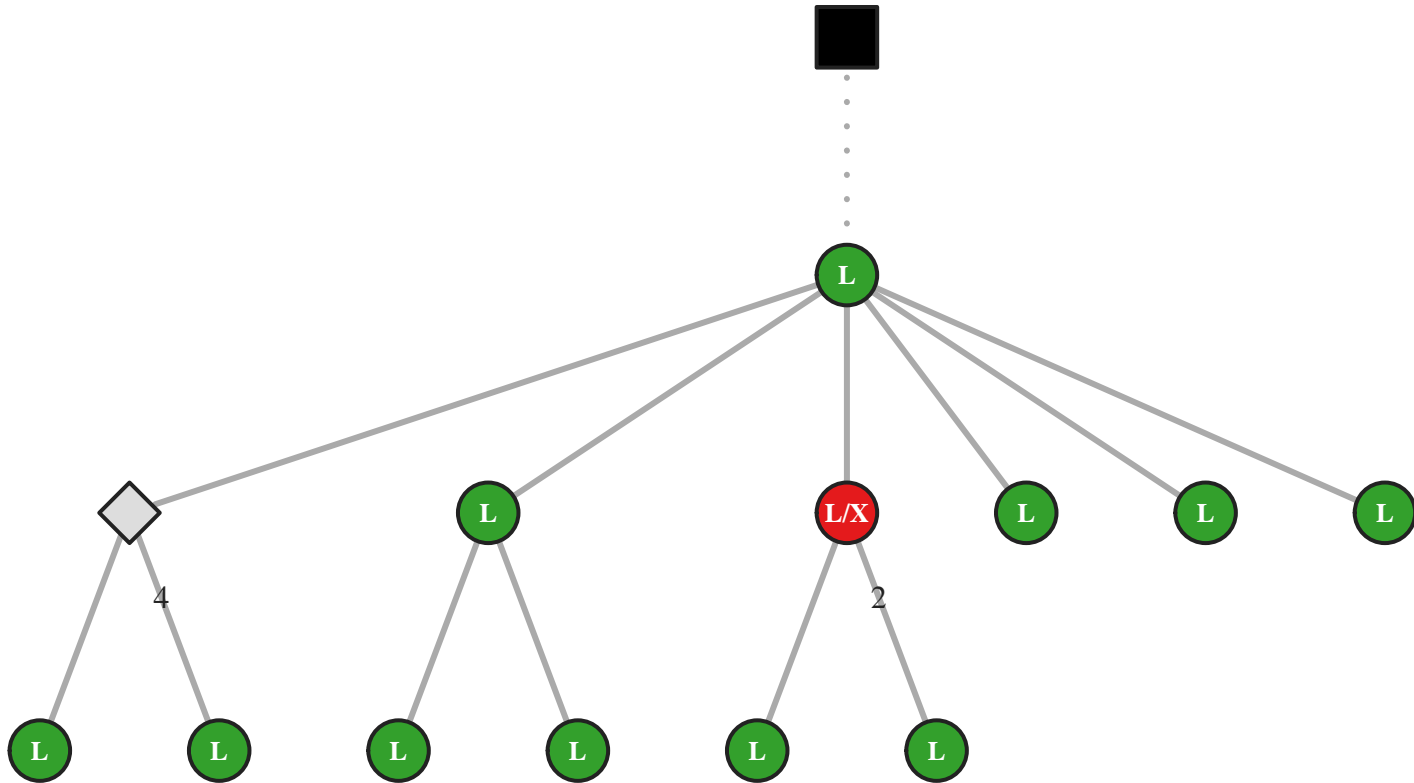

M5 IgG IGHV3-33/J2 57bp (35127)

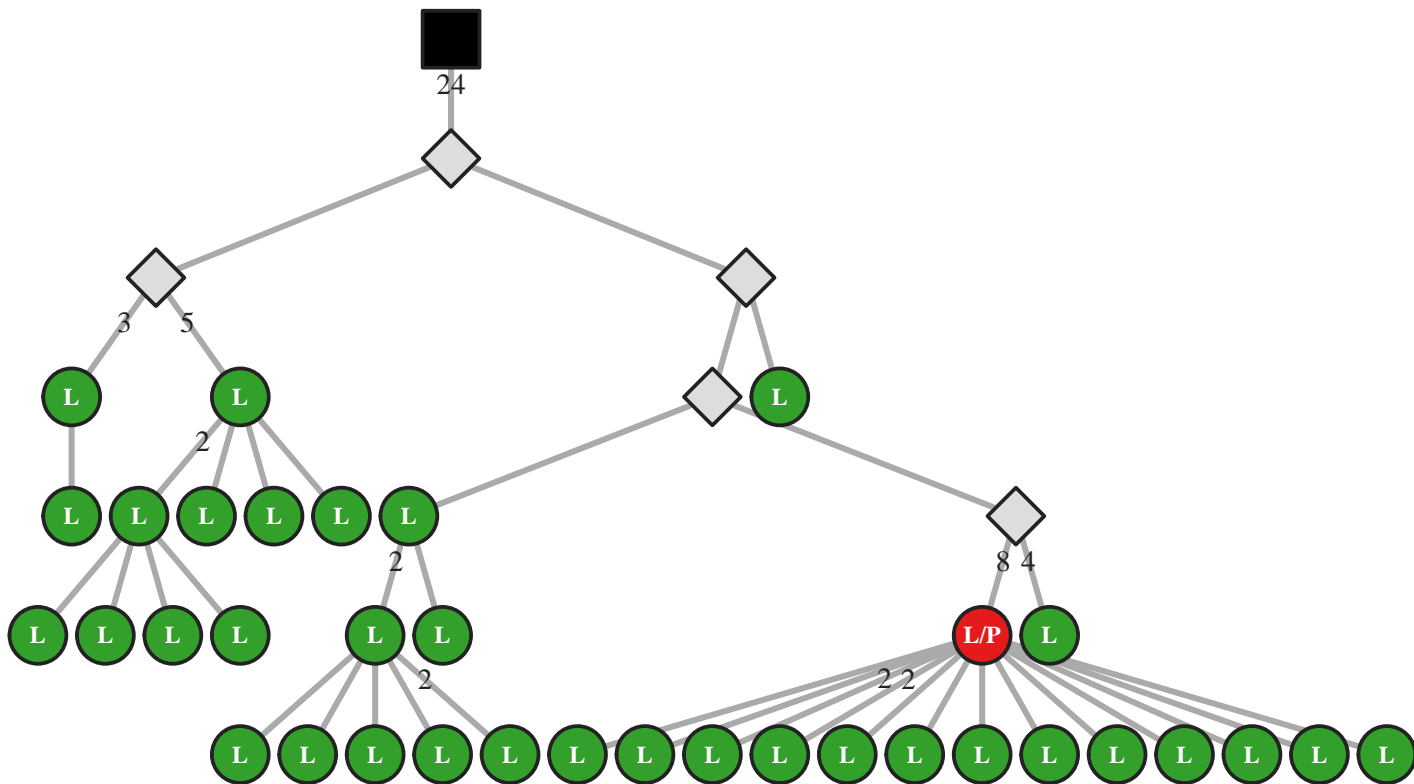

M5 IgG IGHV3-33/J3 39bp (35133)

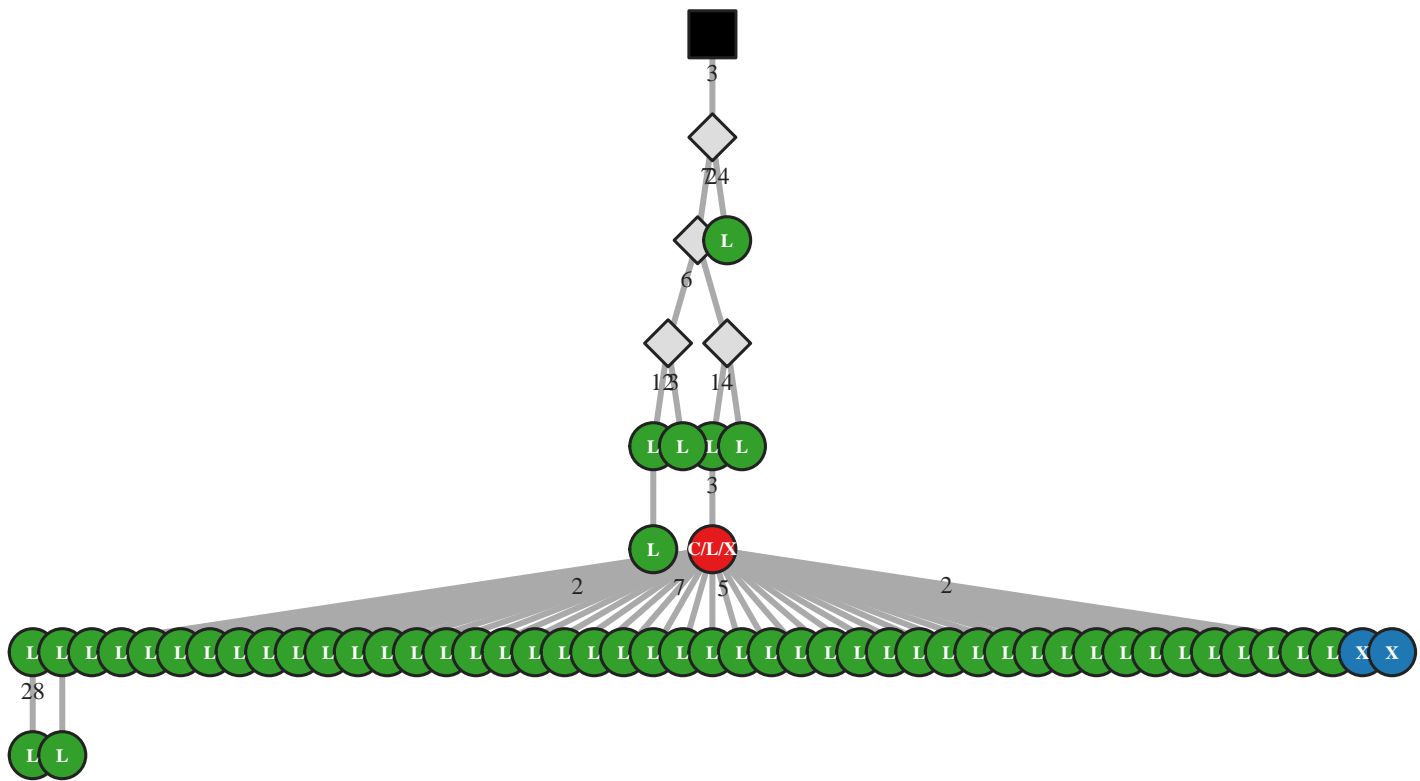

M5 IgG IGHV3-33/J3 42bp (7939)

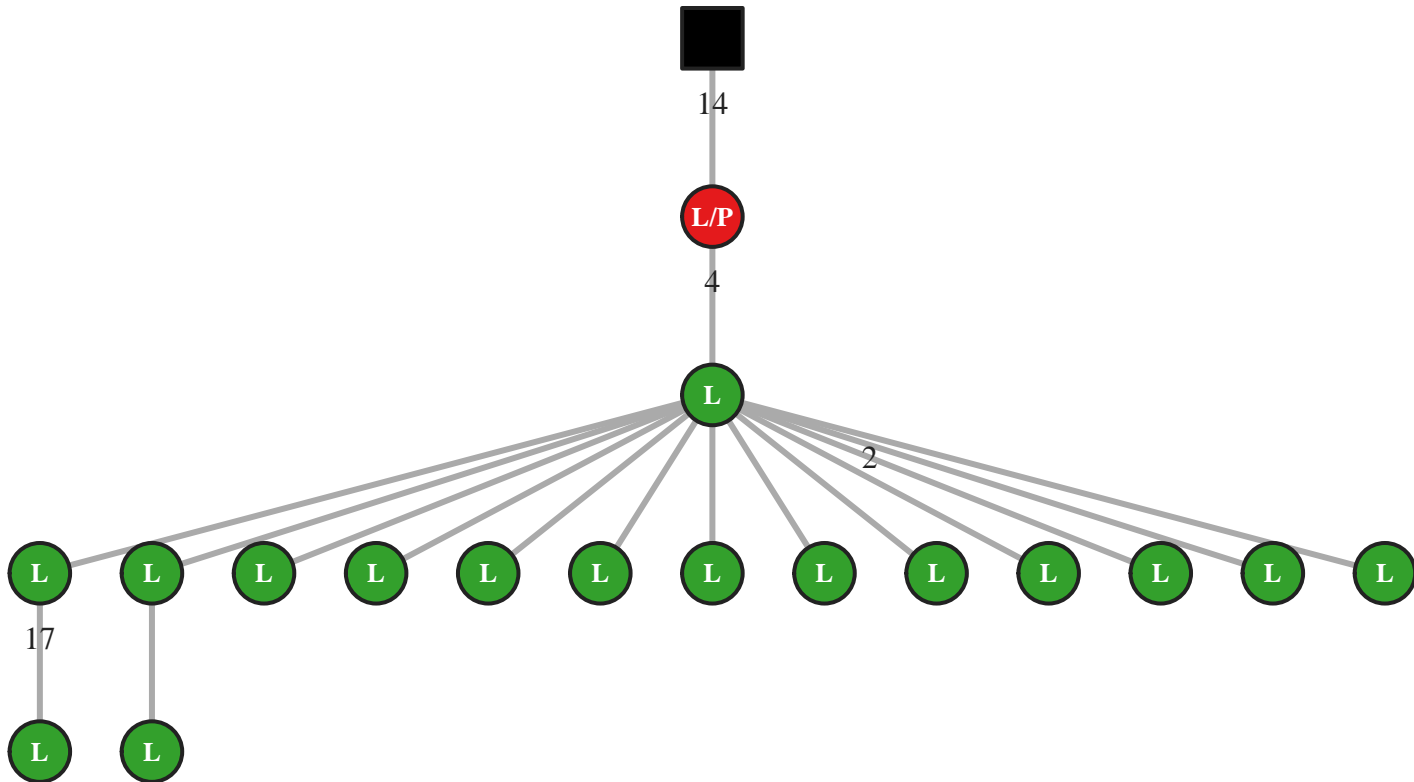

M5 IgG IGHV3-33/J3 54bp (45042)

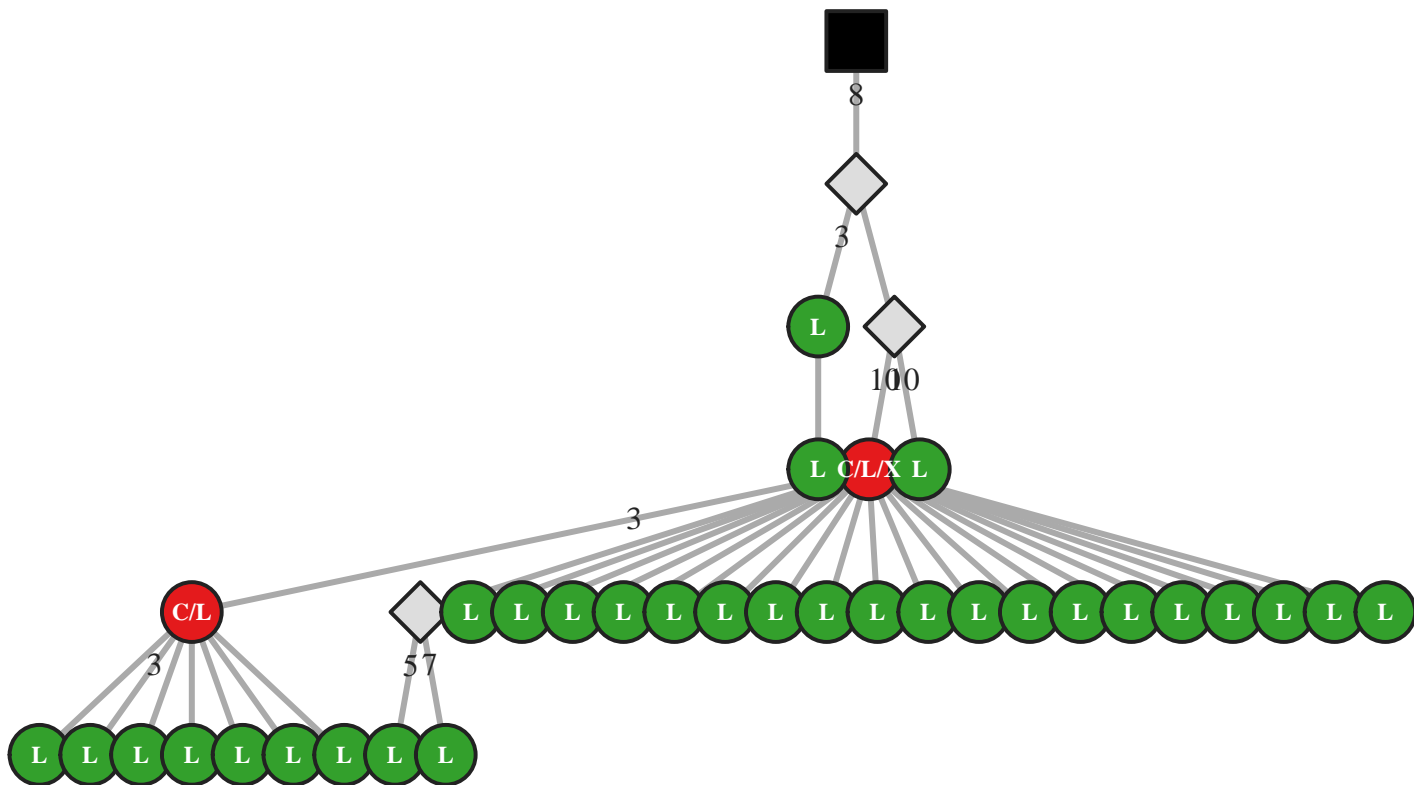

M5 IgG IGHV3-33/J3 54bp (45049)

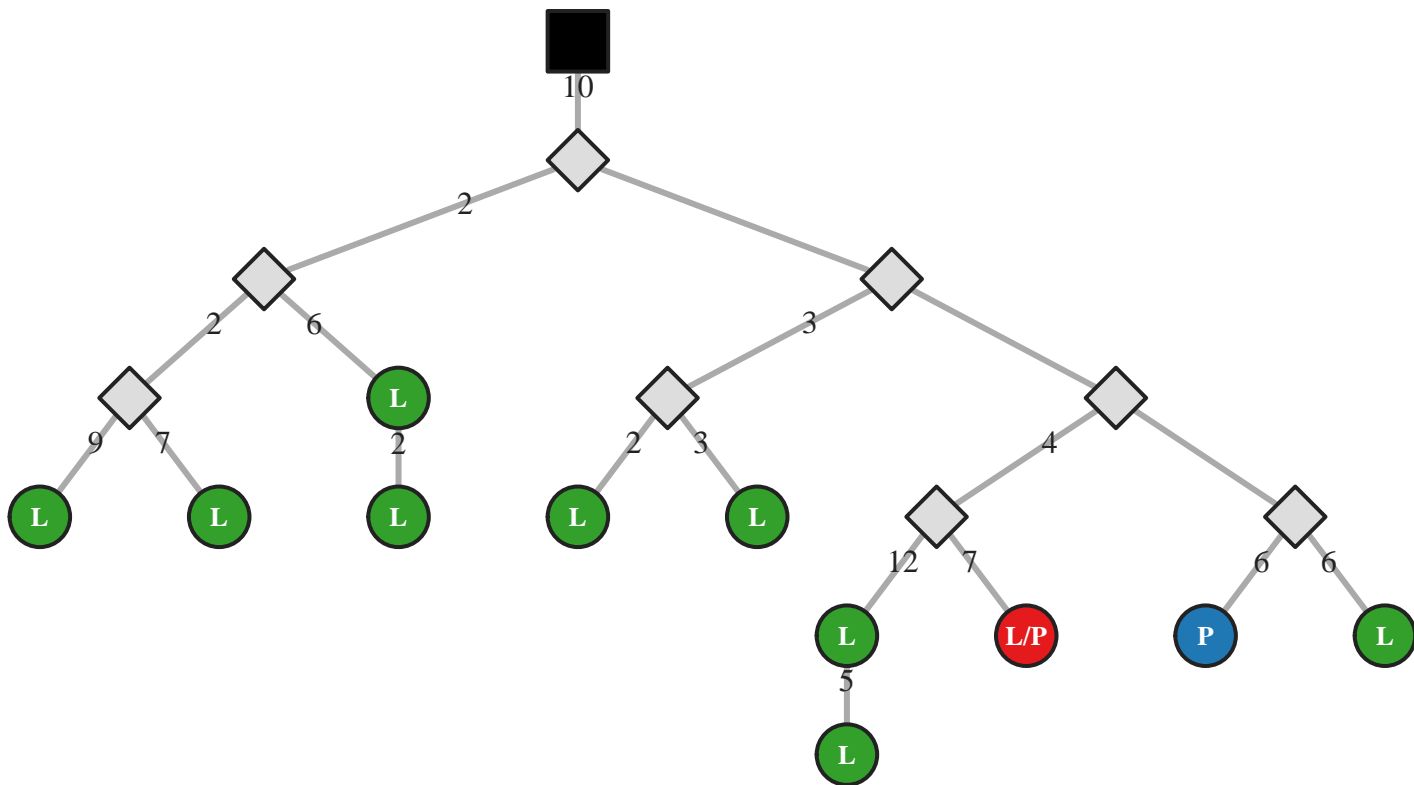

M5 IgG IGHV3-33/J3 54bp (45056)

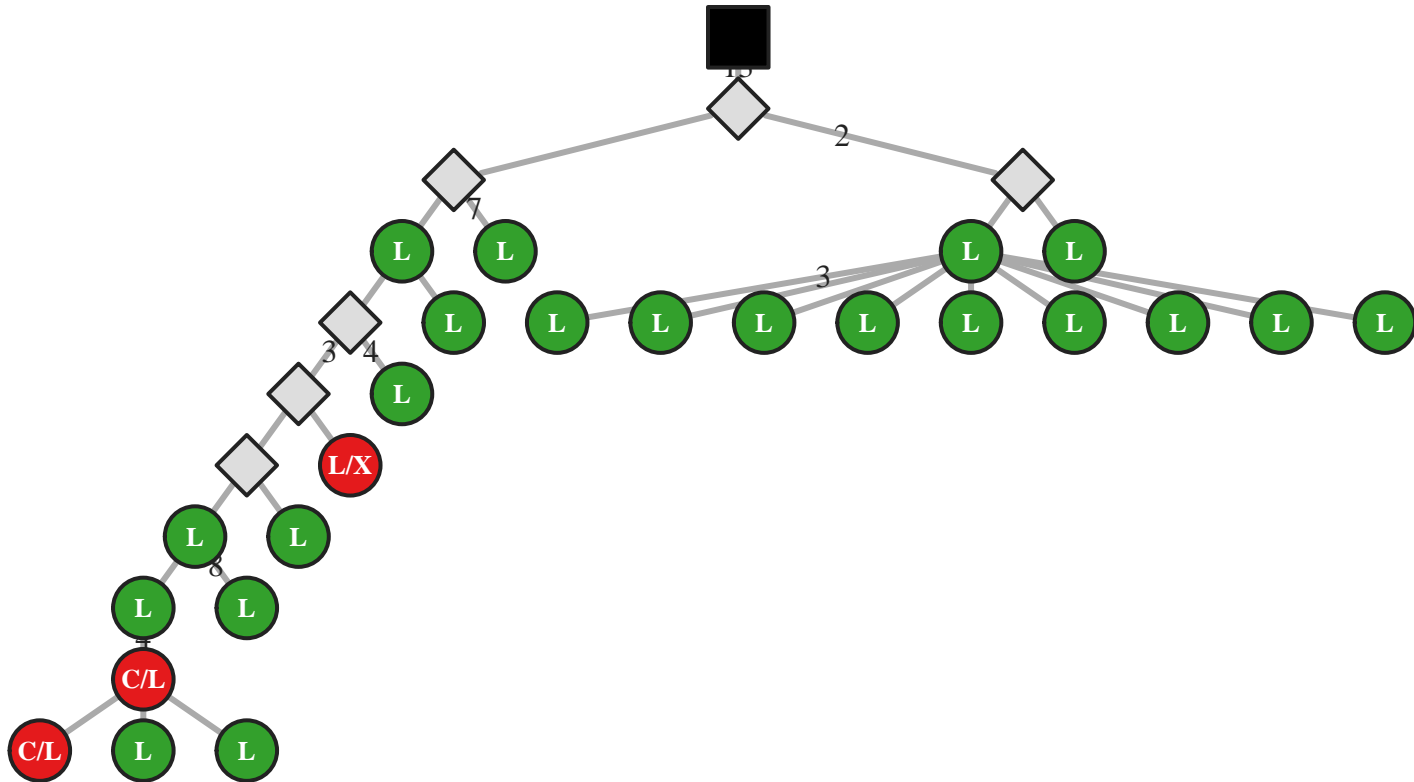

M5 IgG IGHV3-33/J3 54bp (45057)

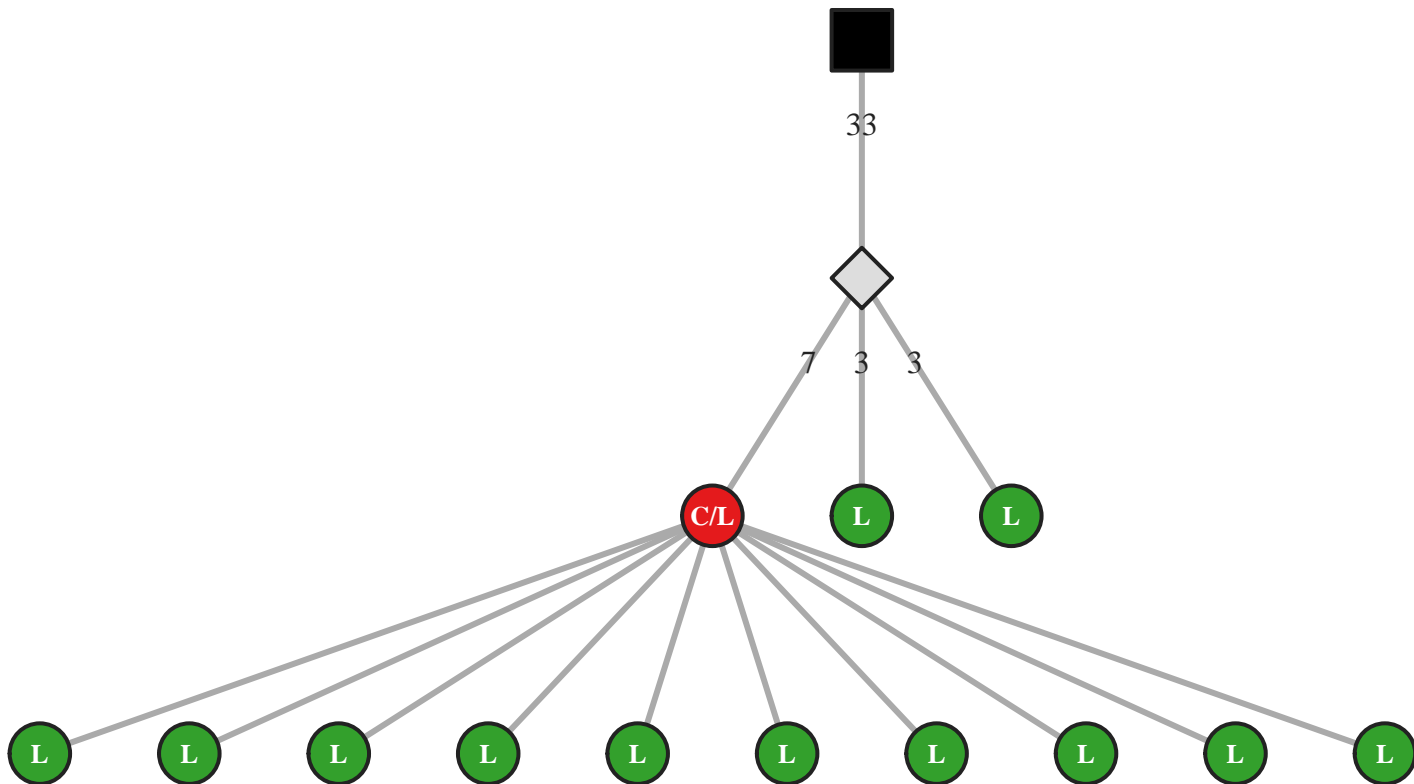

M5 IgG IGHV3-33/J3 60bp (45072)

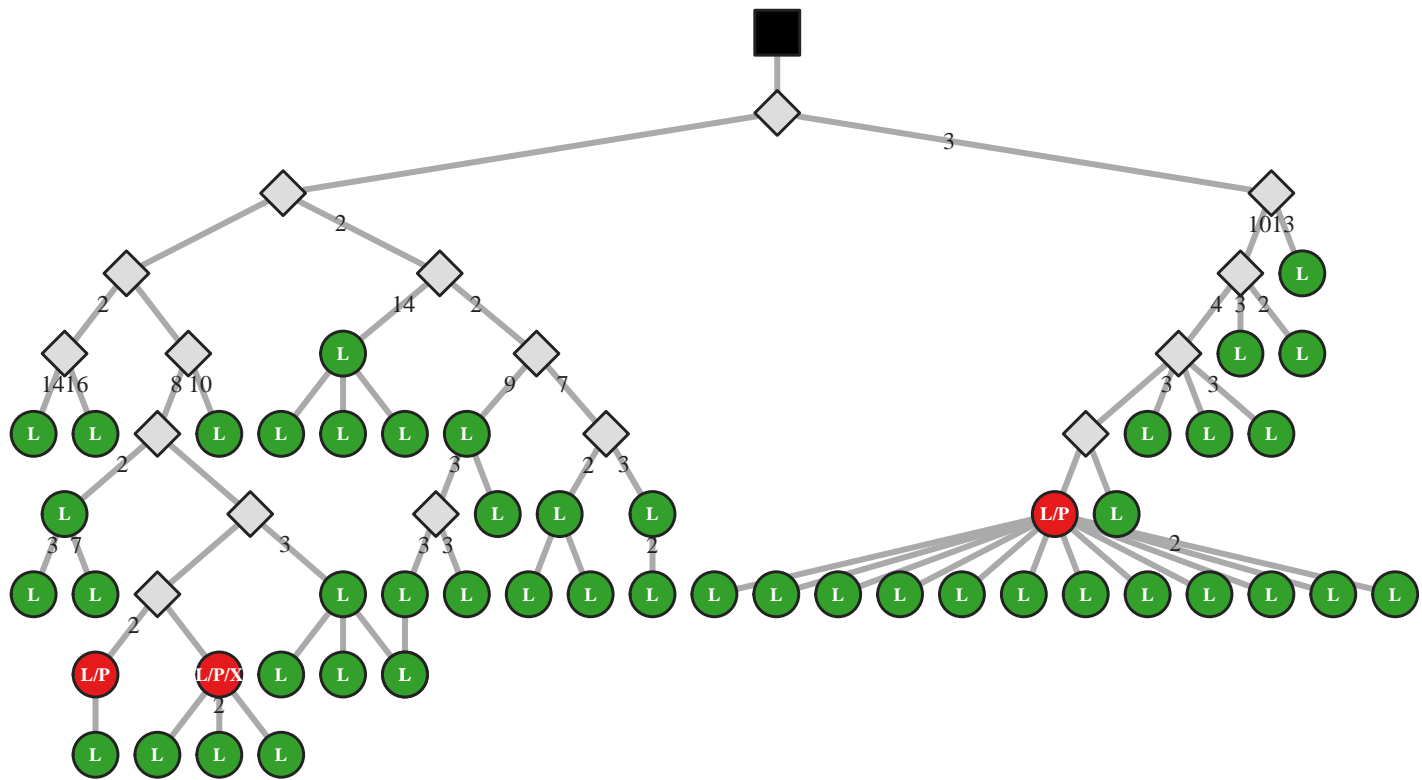

M5 IgG IGHV3-33/J3 69bp (8073)

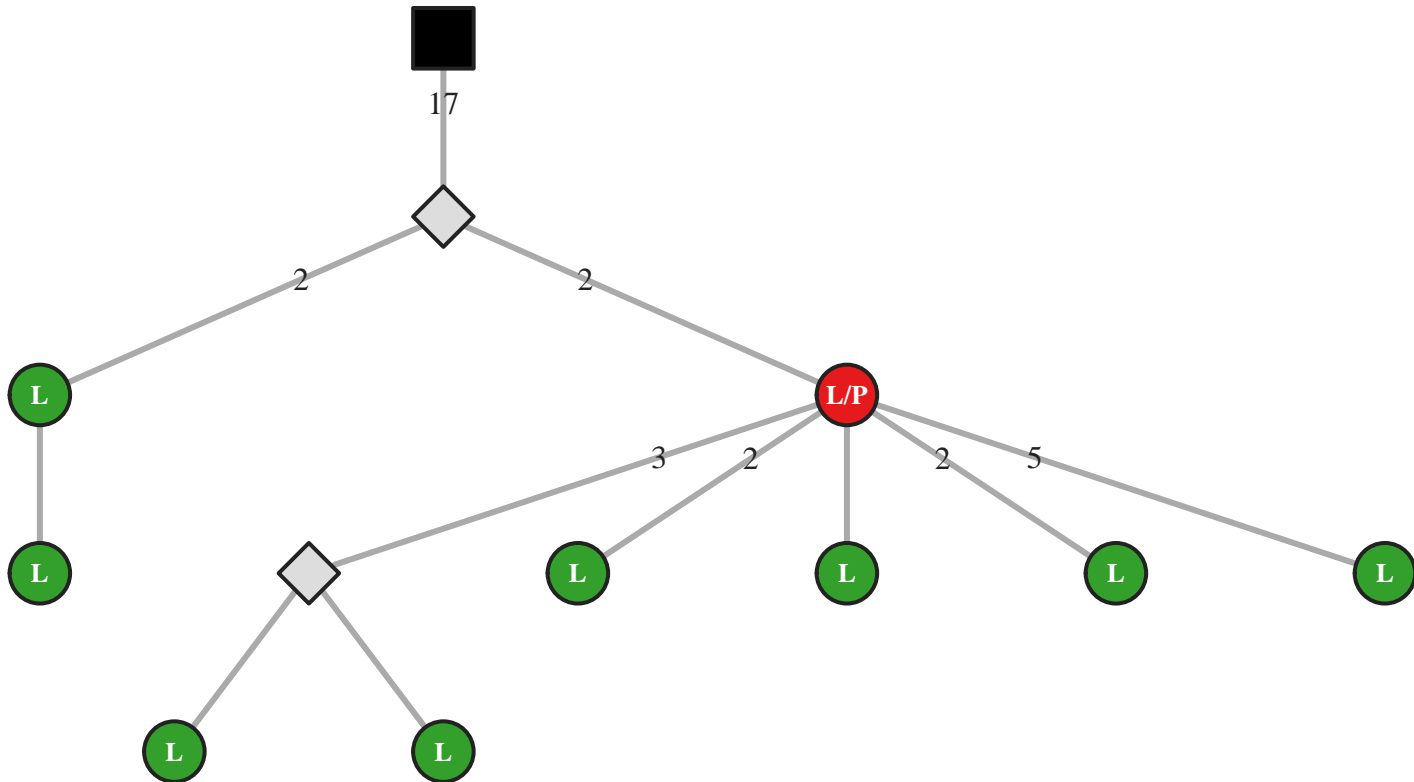

M5 IgG IGHV3-33/J4 33bp (17737)

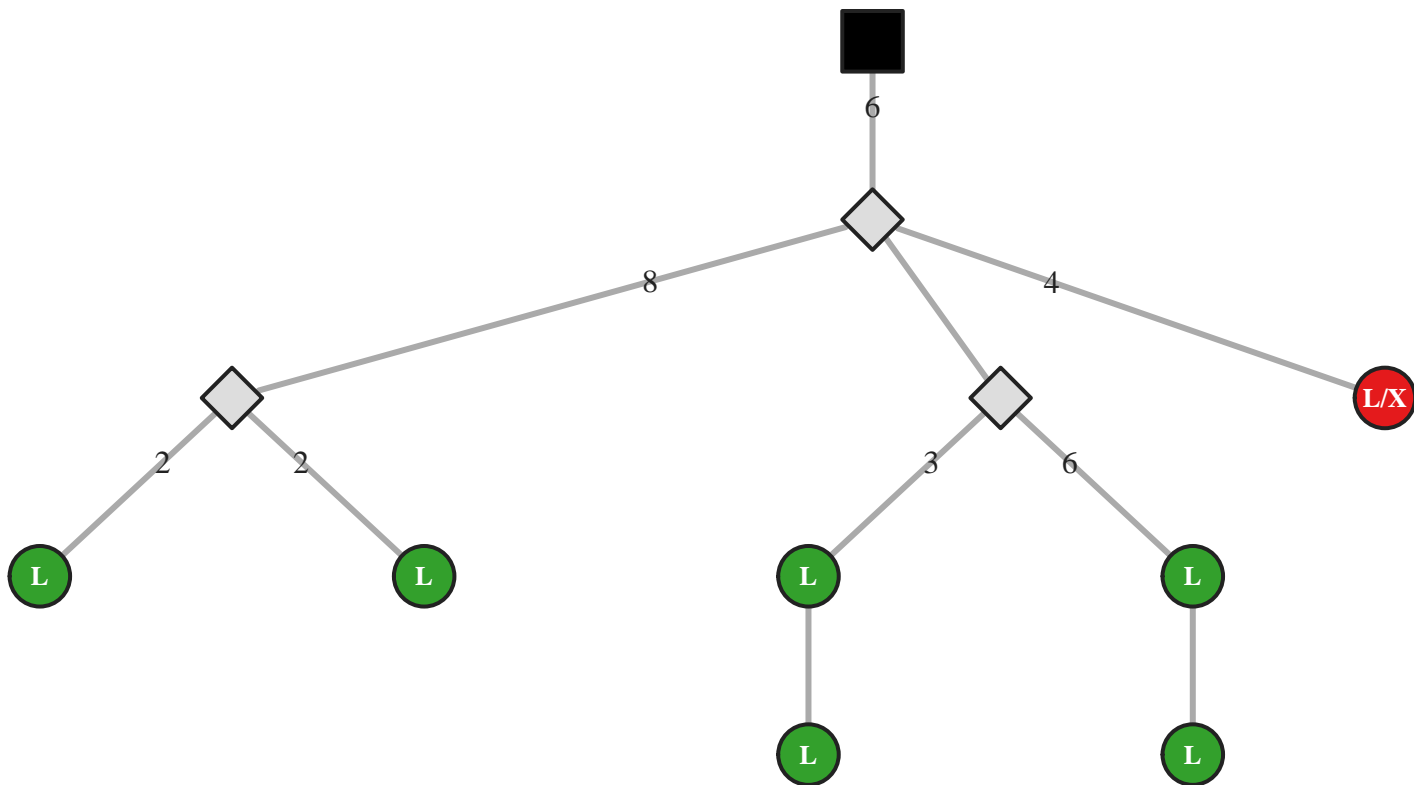

M5 IgM IGHV3-33/J4 33bp (11417)

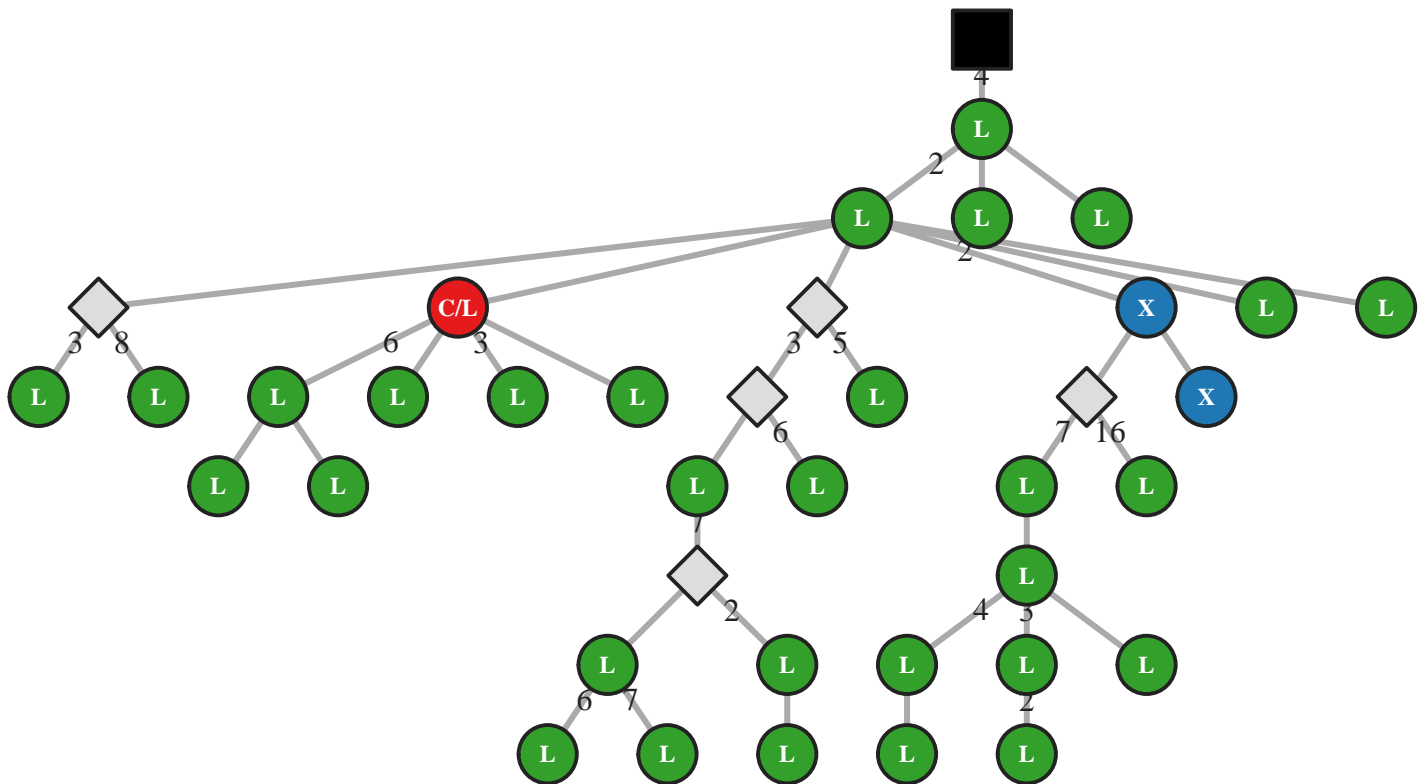

M5 IgM IGHV3-33/J4 36bp (29534)

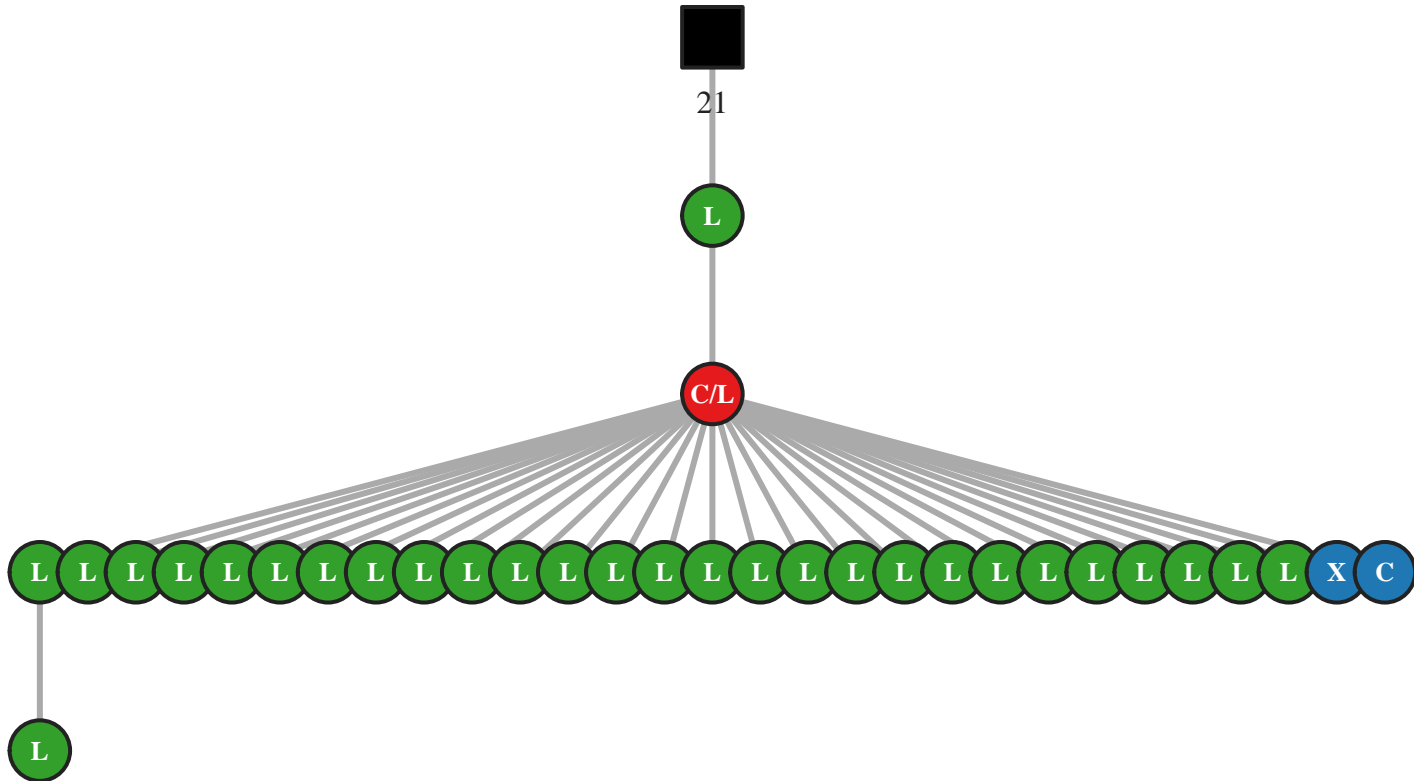

M5 IgA IGHV3-33/J4 39bp (21870)

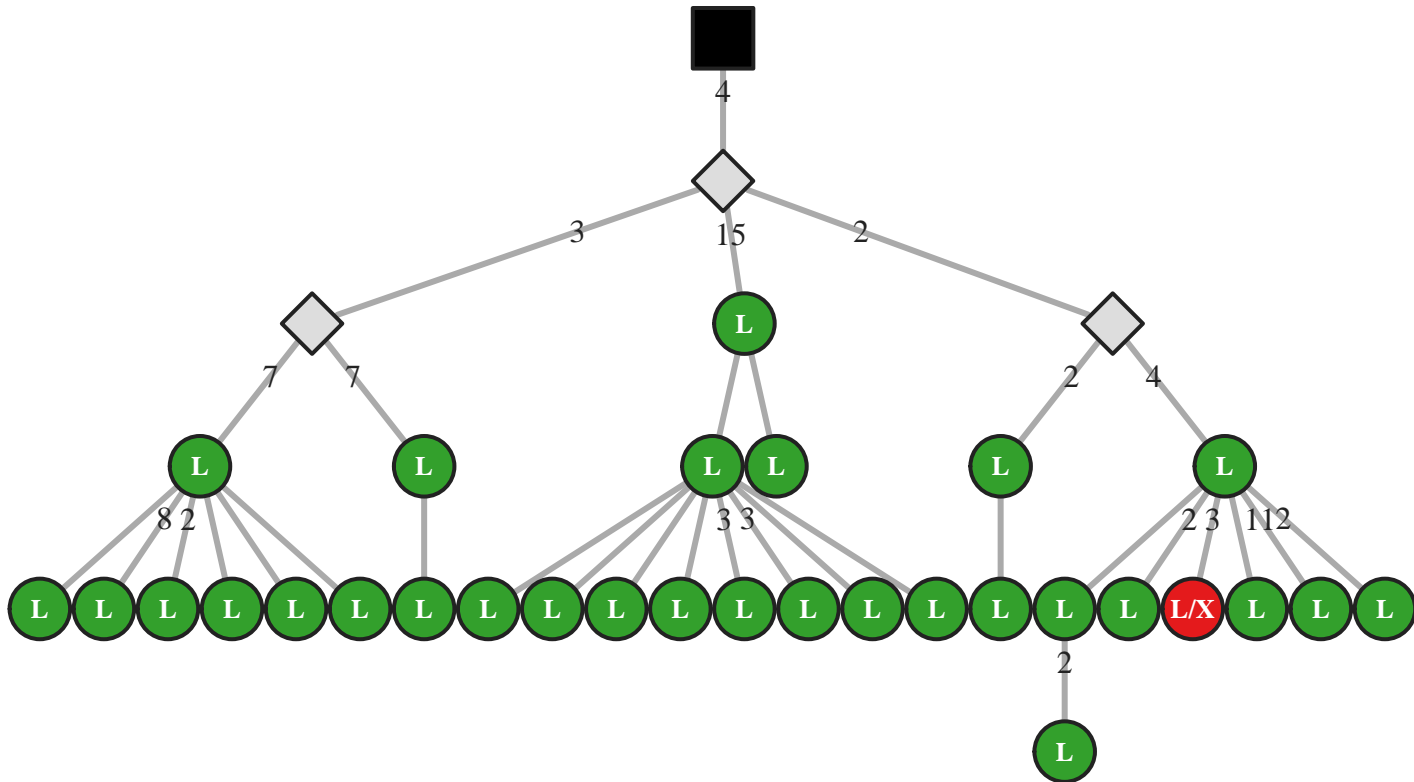

M5 IgA IGHV3-33/J4 39bp (21874)

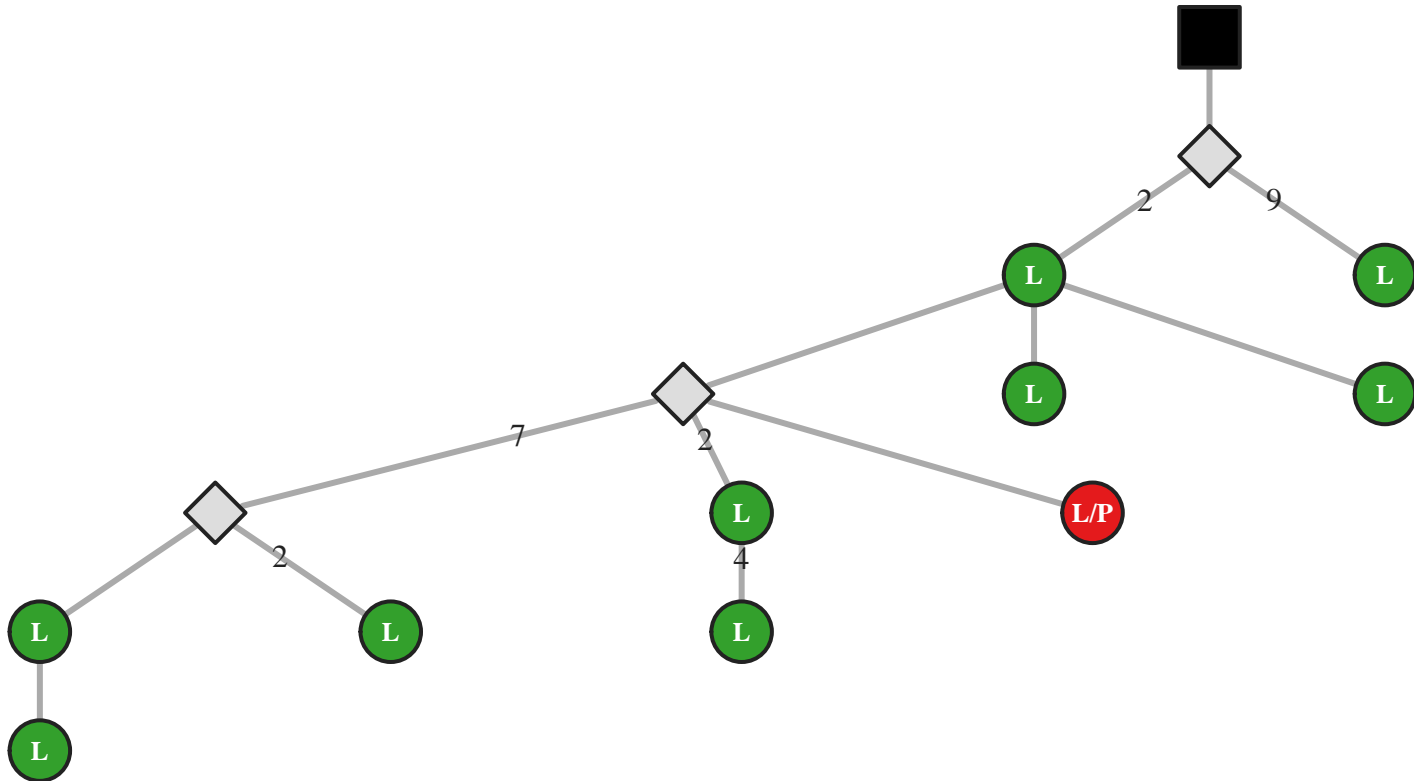

M5 IgG IGHV3-33/J4 39bp (7215)

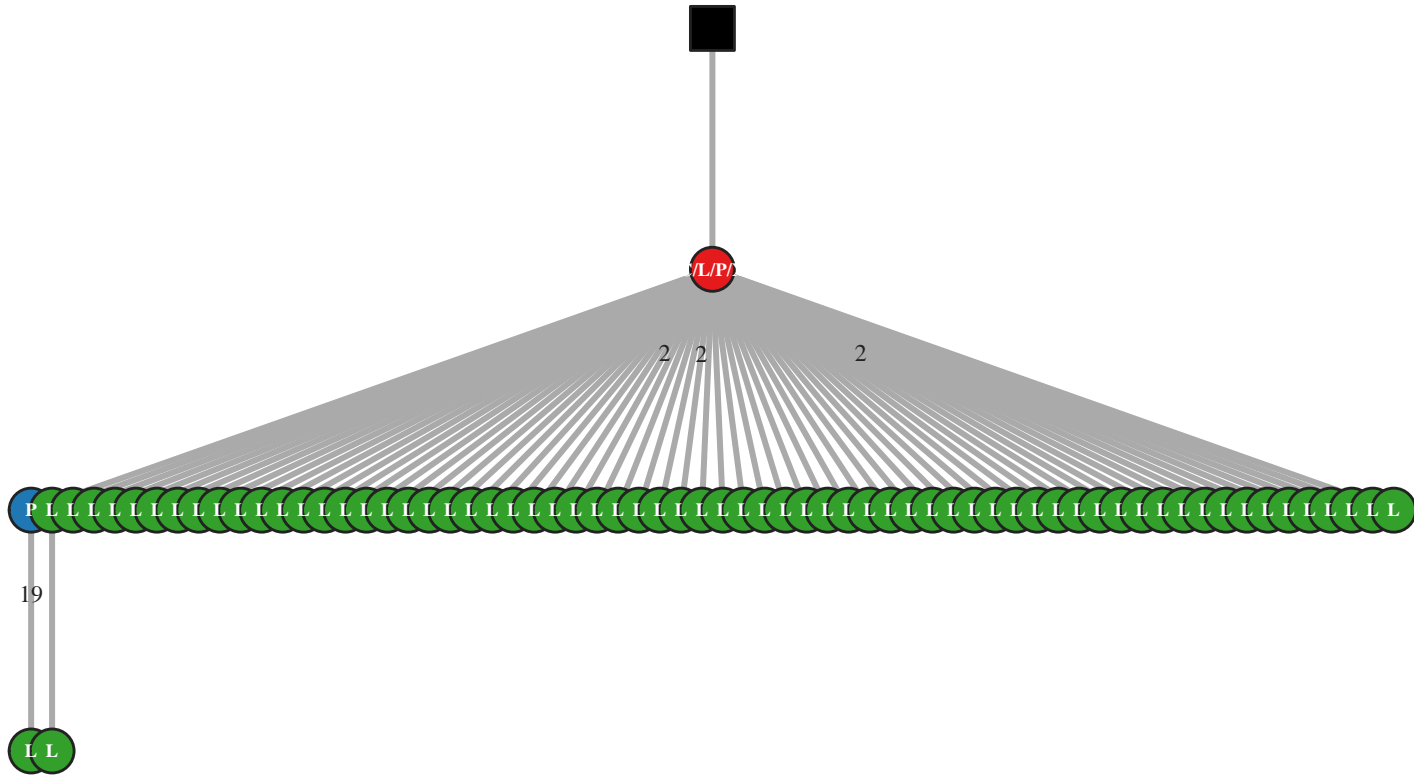

M5 IgG IGHV3-33/J4 39bp (7234)

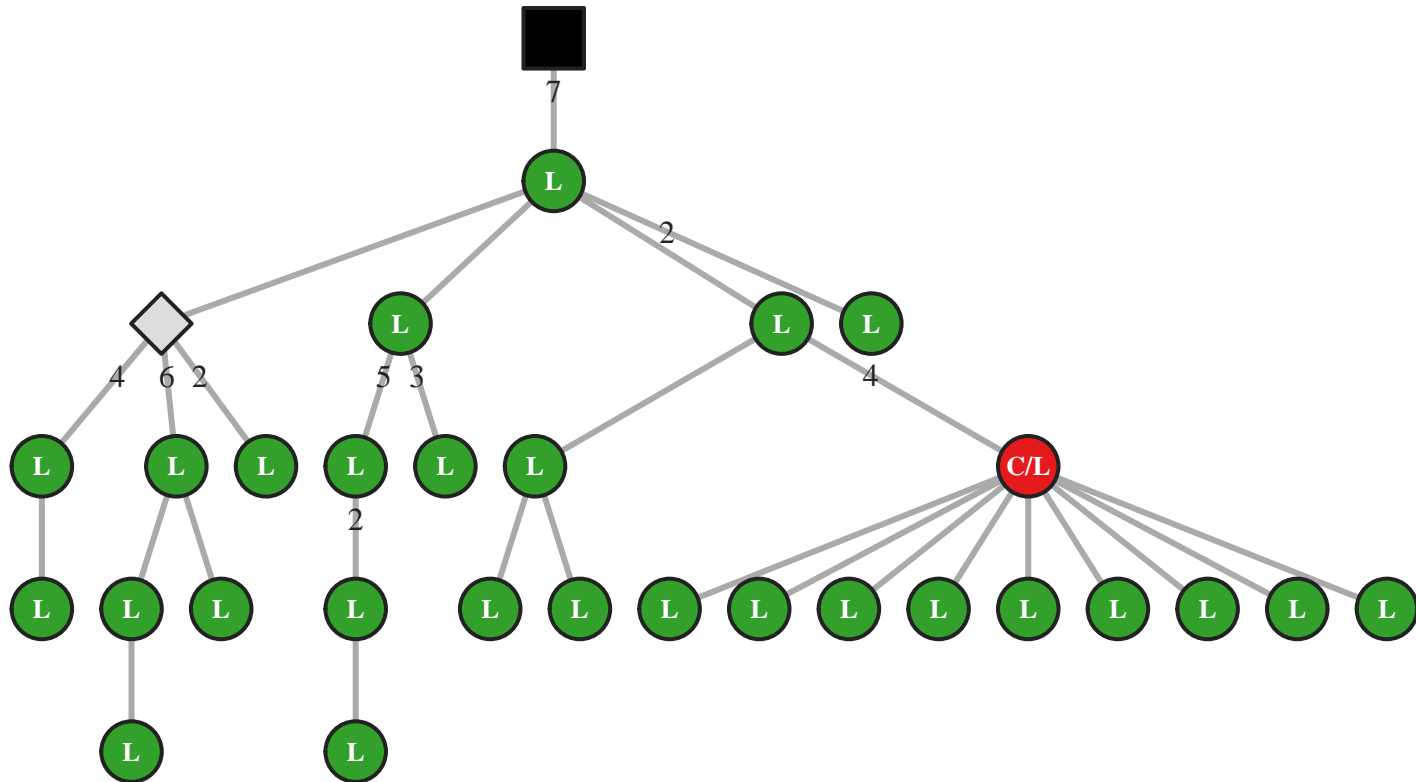

M5 IgM IGHV3-33/J4 39bp (37866)

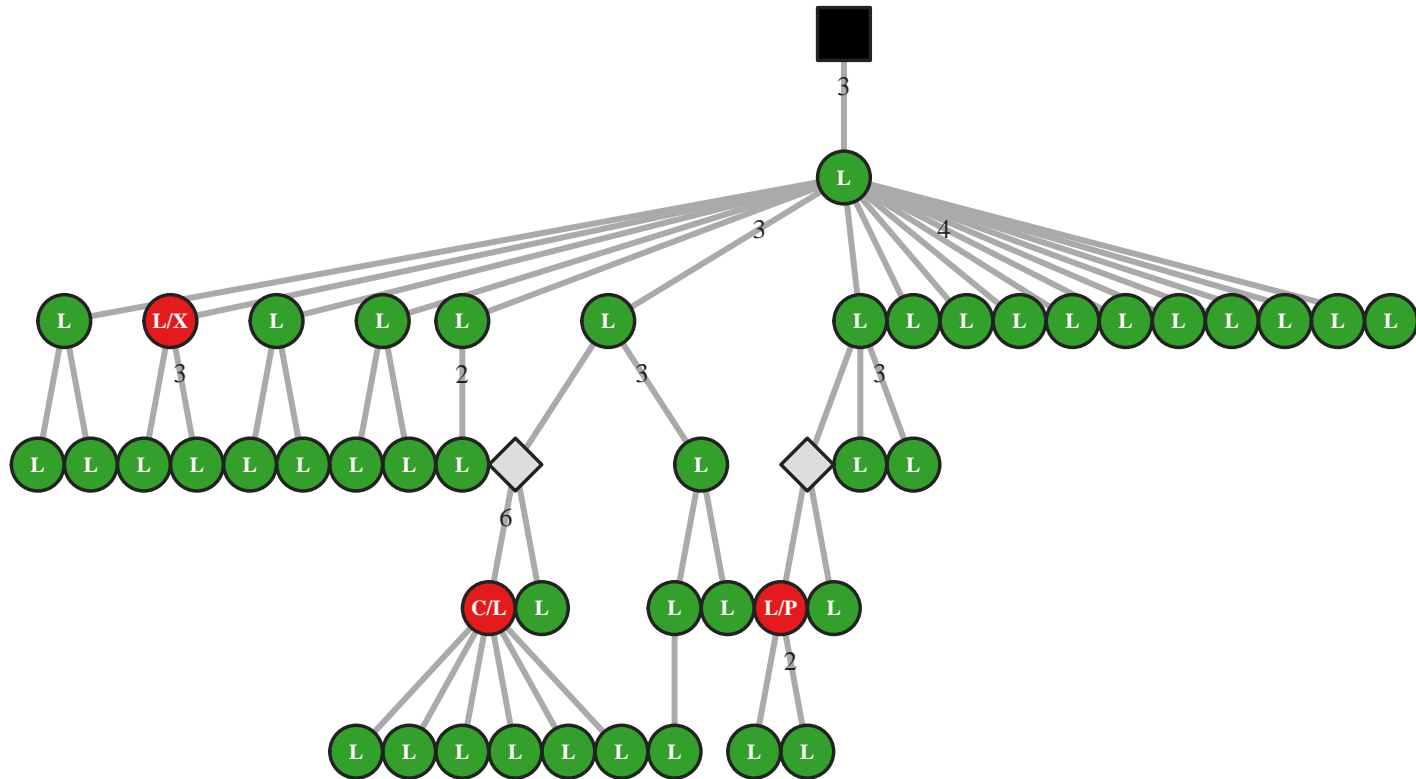

M5 IgG IGHV3-33/J4 42bp (43947)

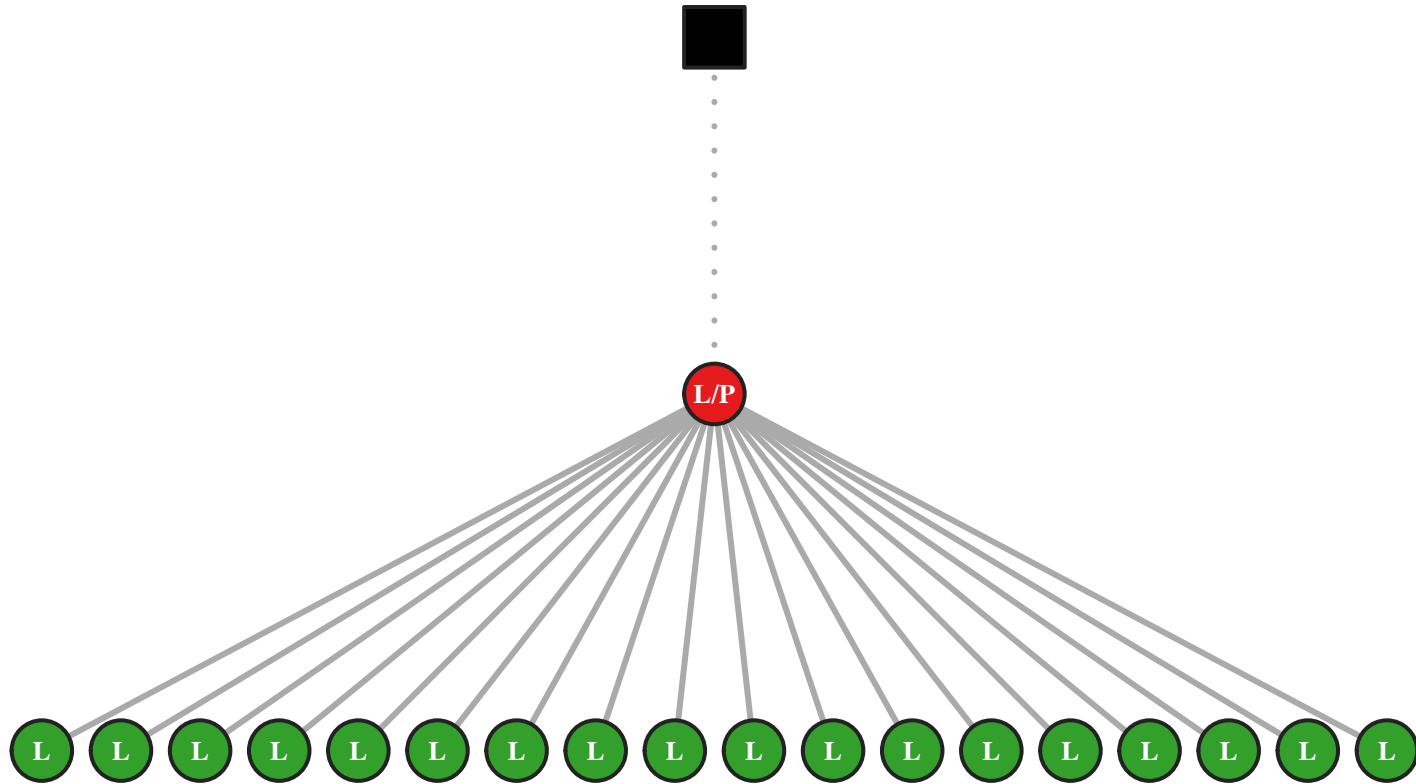

M5 IgG IGHV3-33/J4 45bp (16950)

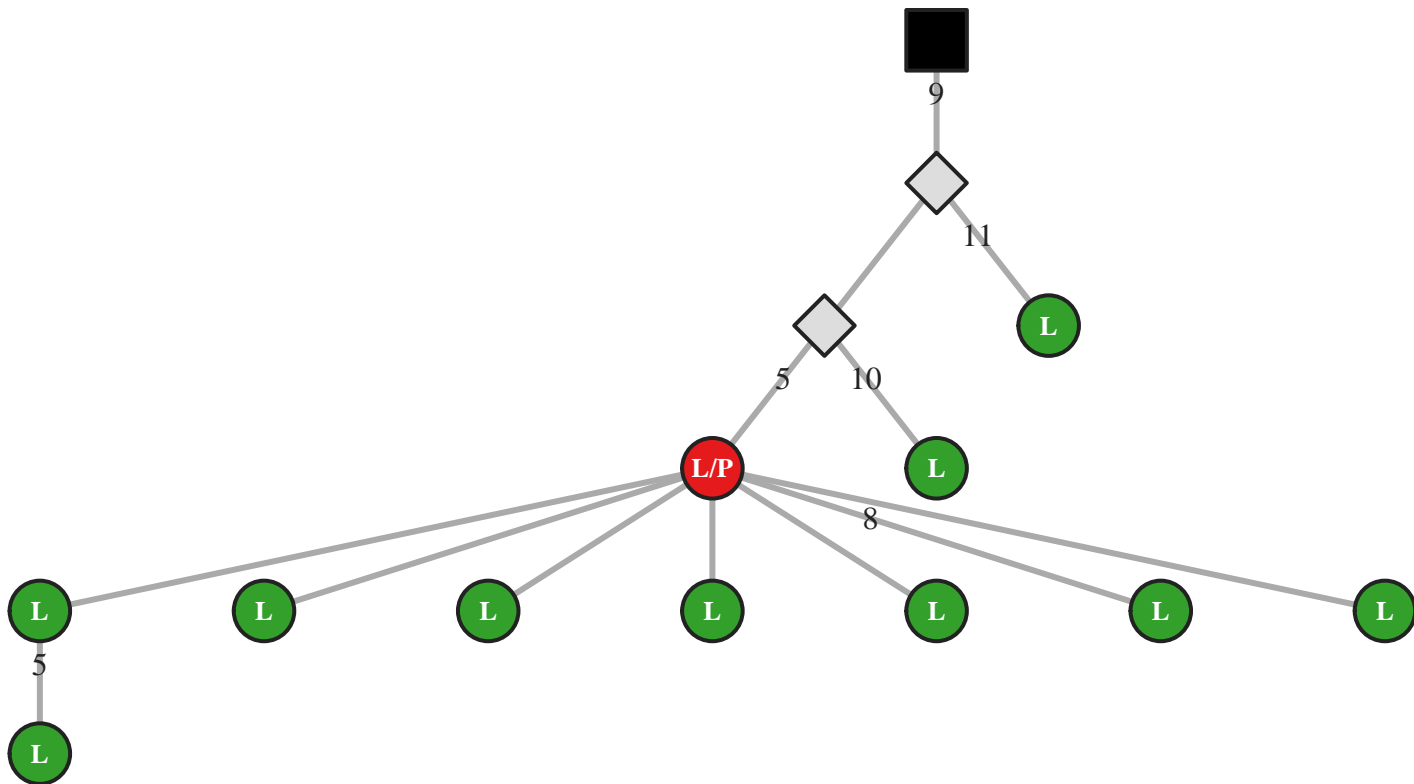

M5 IgG IGHV3-33/J4 45bp (17058)

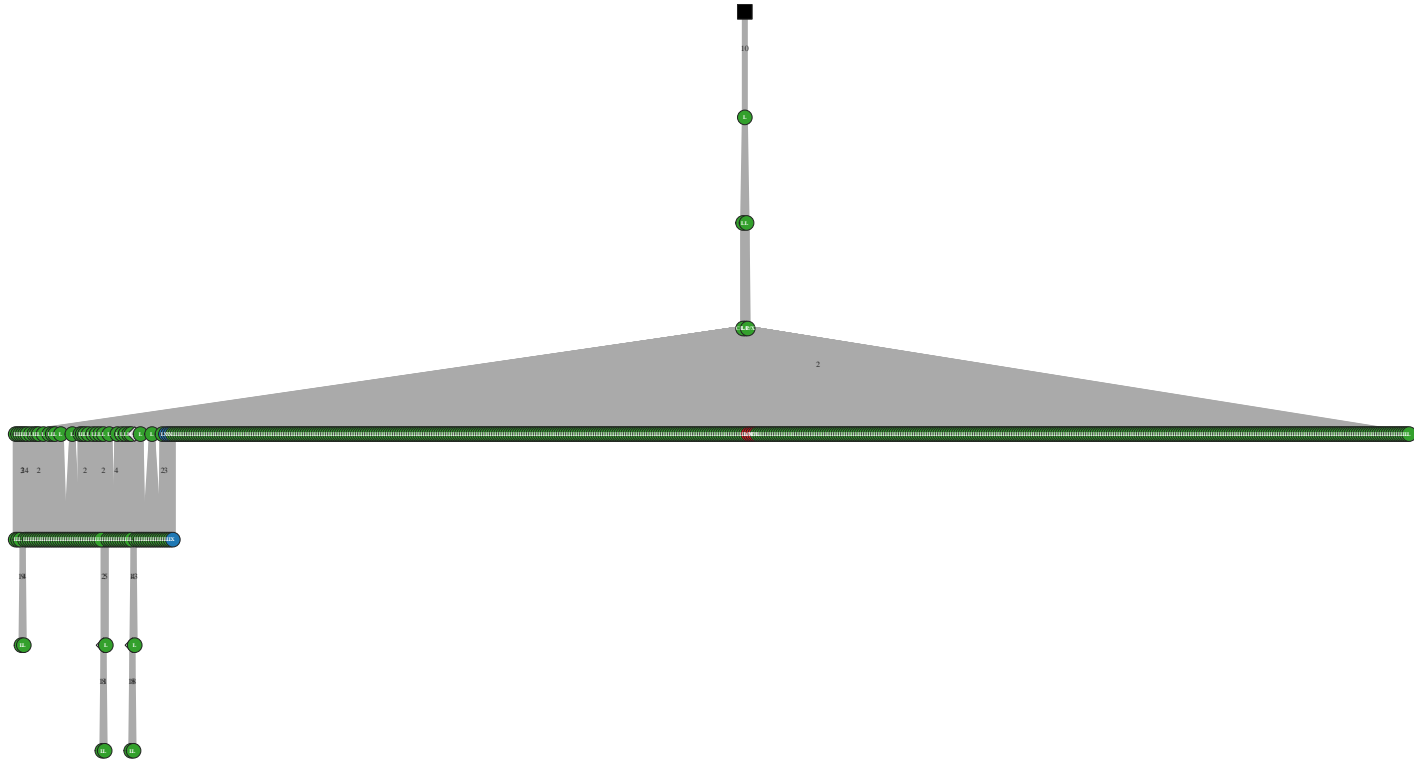

M5 IgG IGHV3-33/J4 45bp (17136)

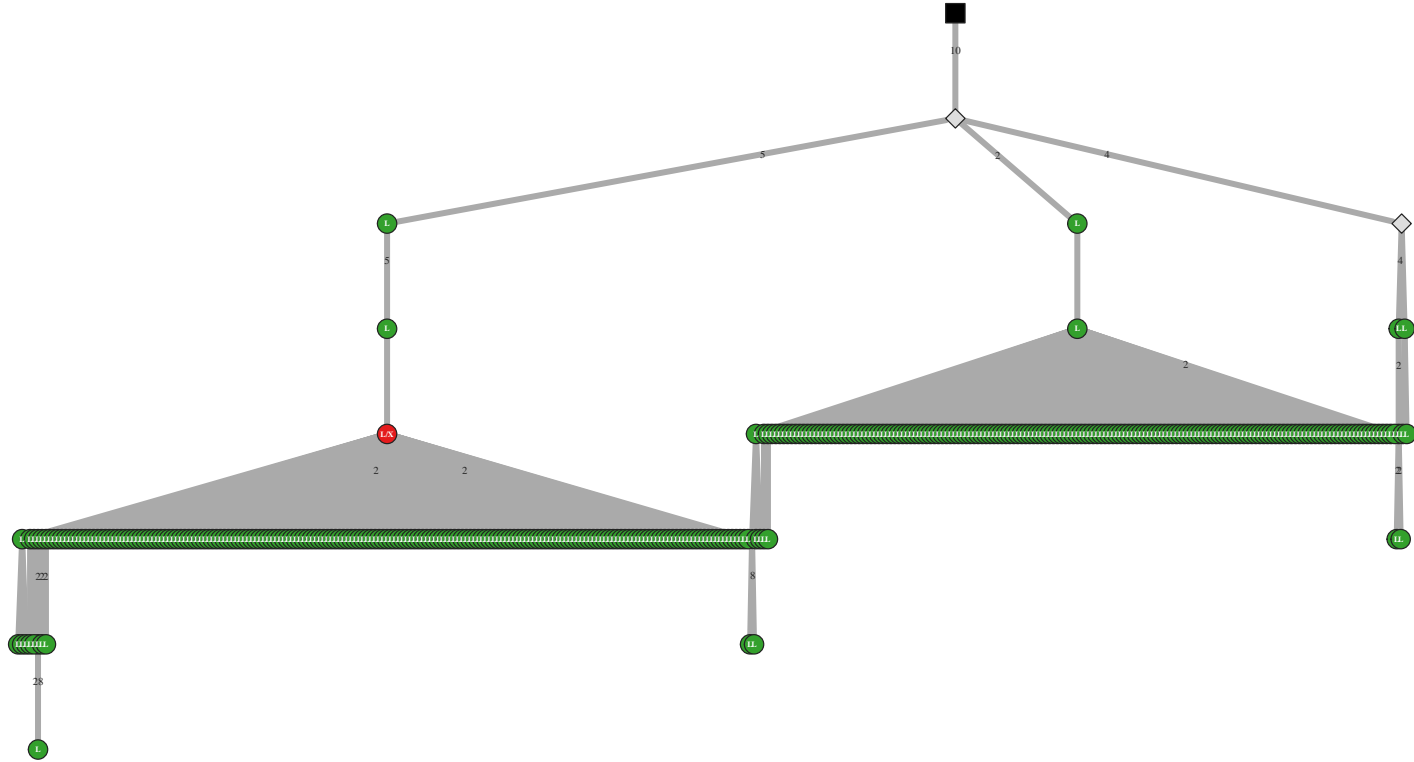

M5 IgG IGHV3-33/J4 45bp (17202)

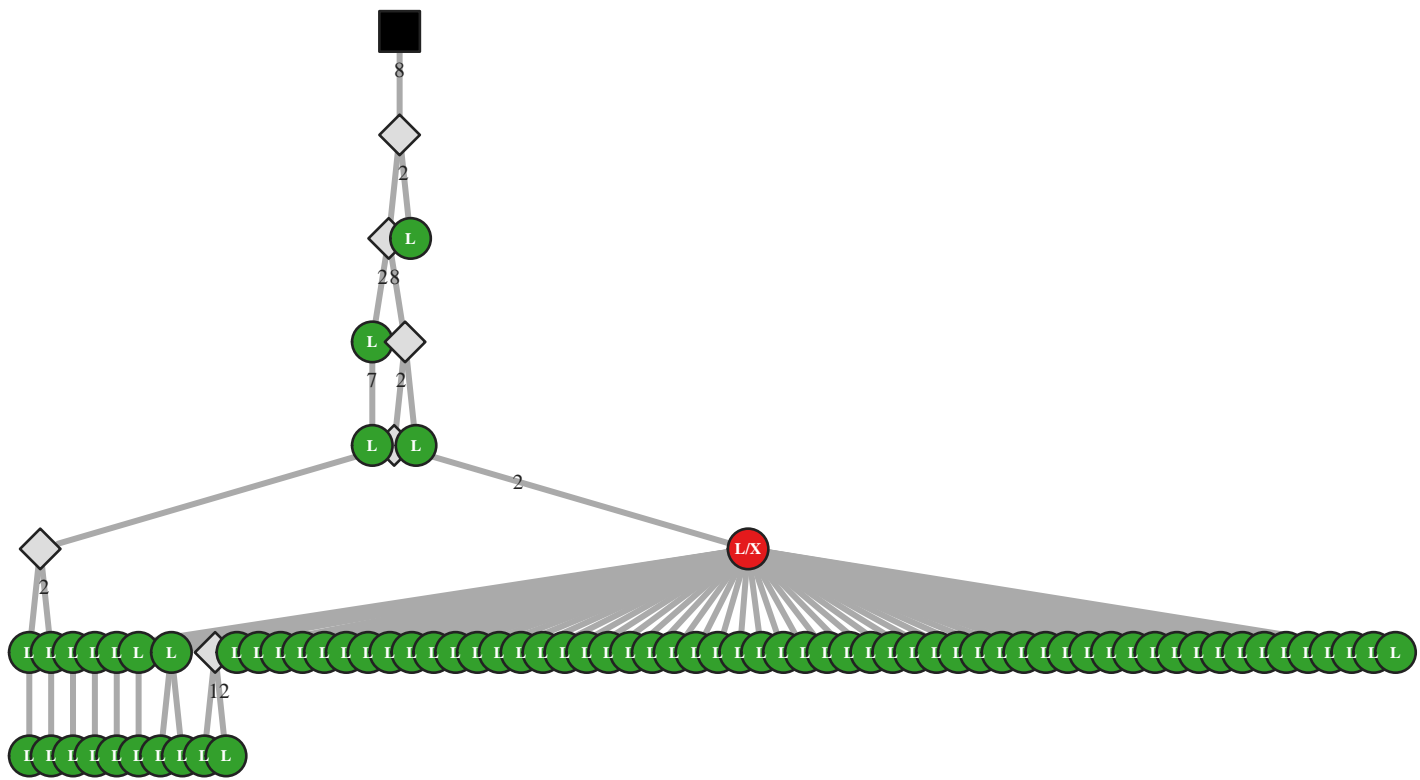

M5 IgG IGHV3-33/J4 48bp (7353)

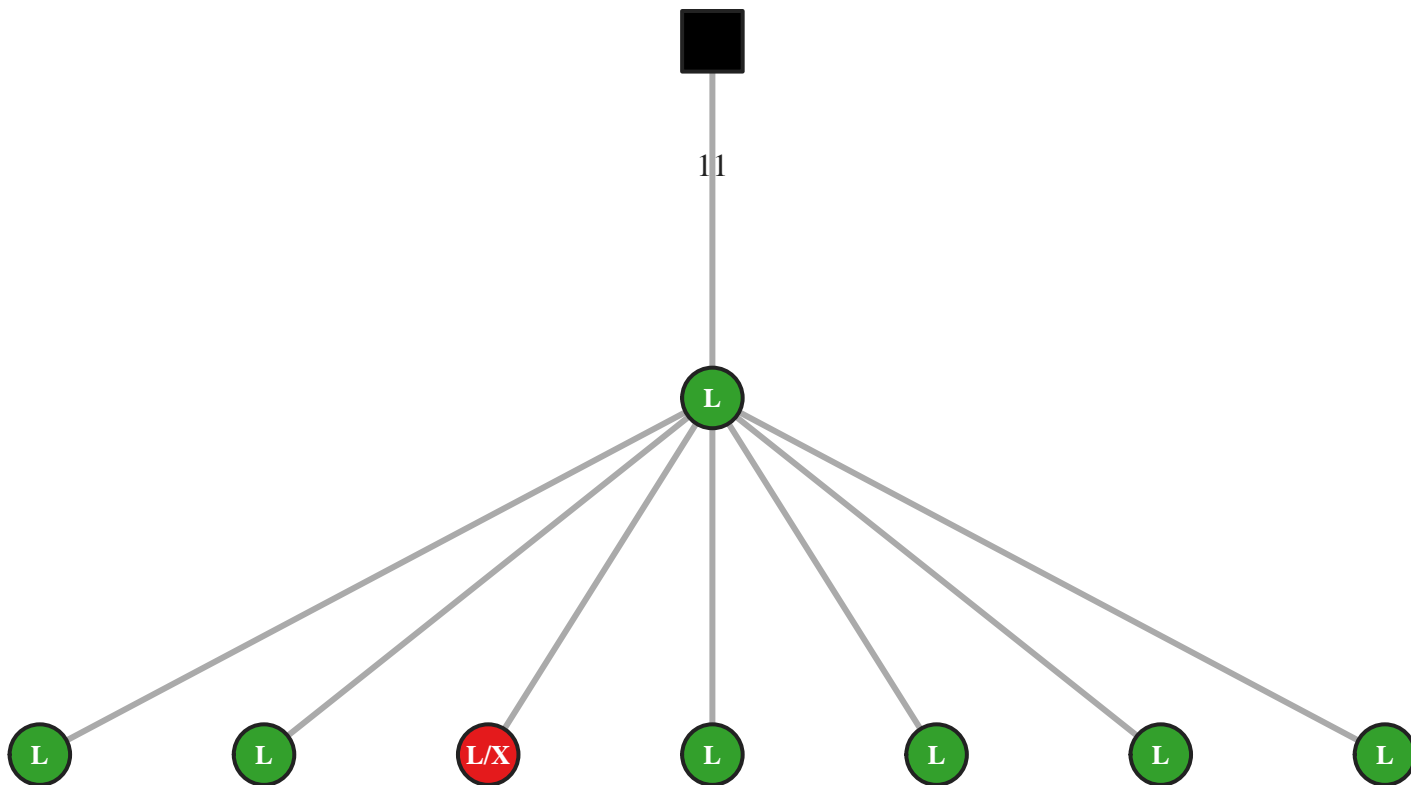

M5 IgG IGHV3-33/J4 48bp (7678)

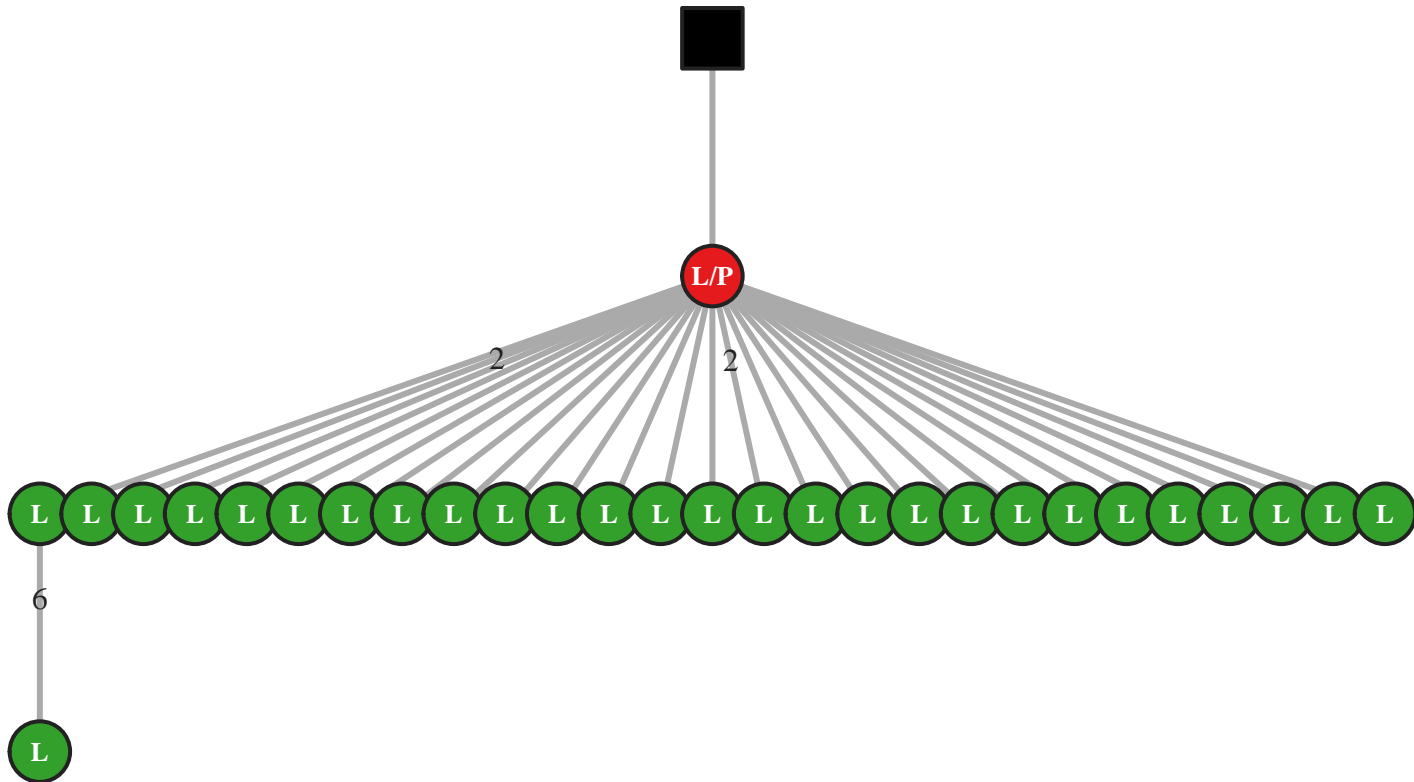

M5 IgG IGHV3-33/J4 51bp (44333)

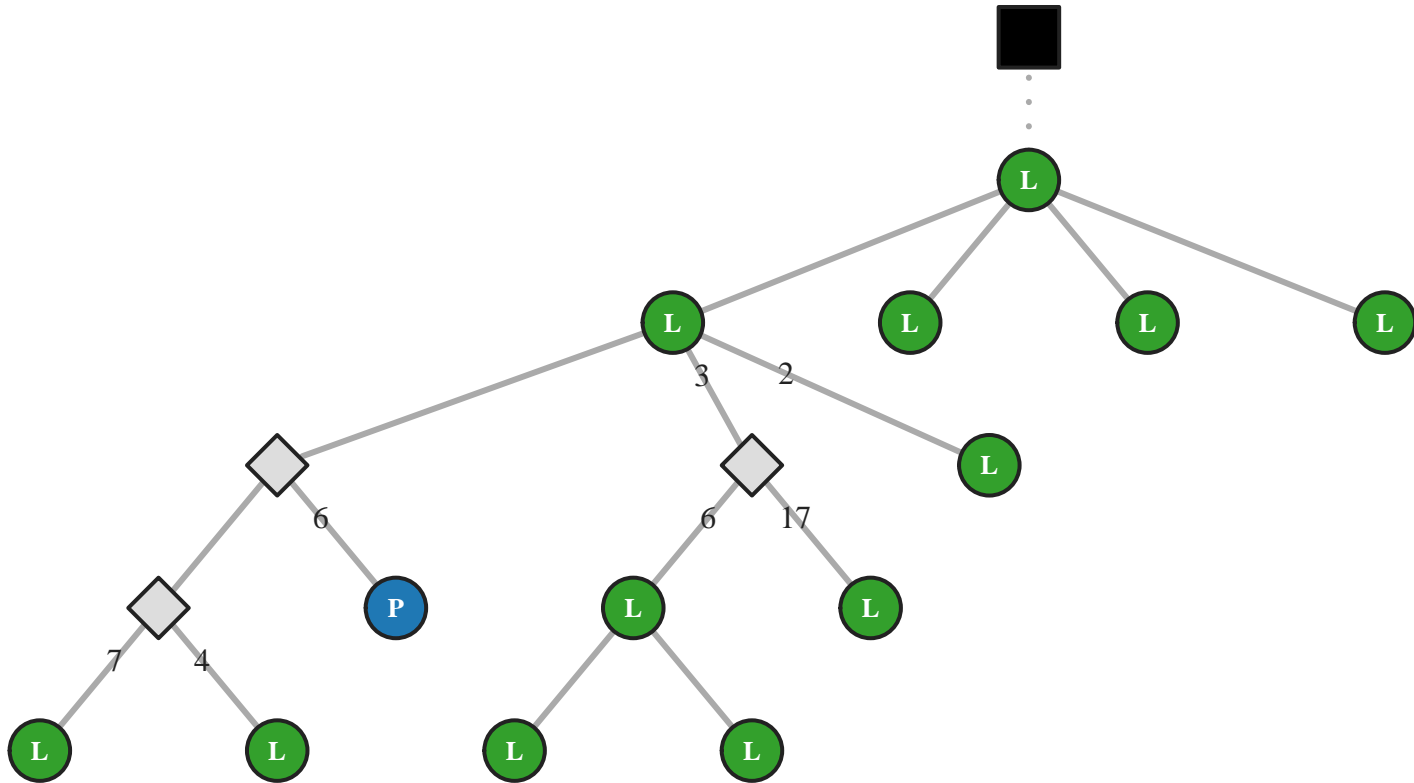

M5 IgG IGHV3-33/J4 51bp (44526)

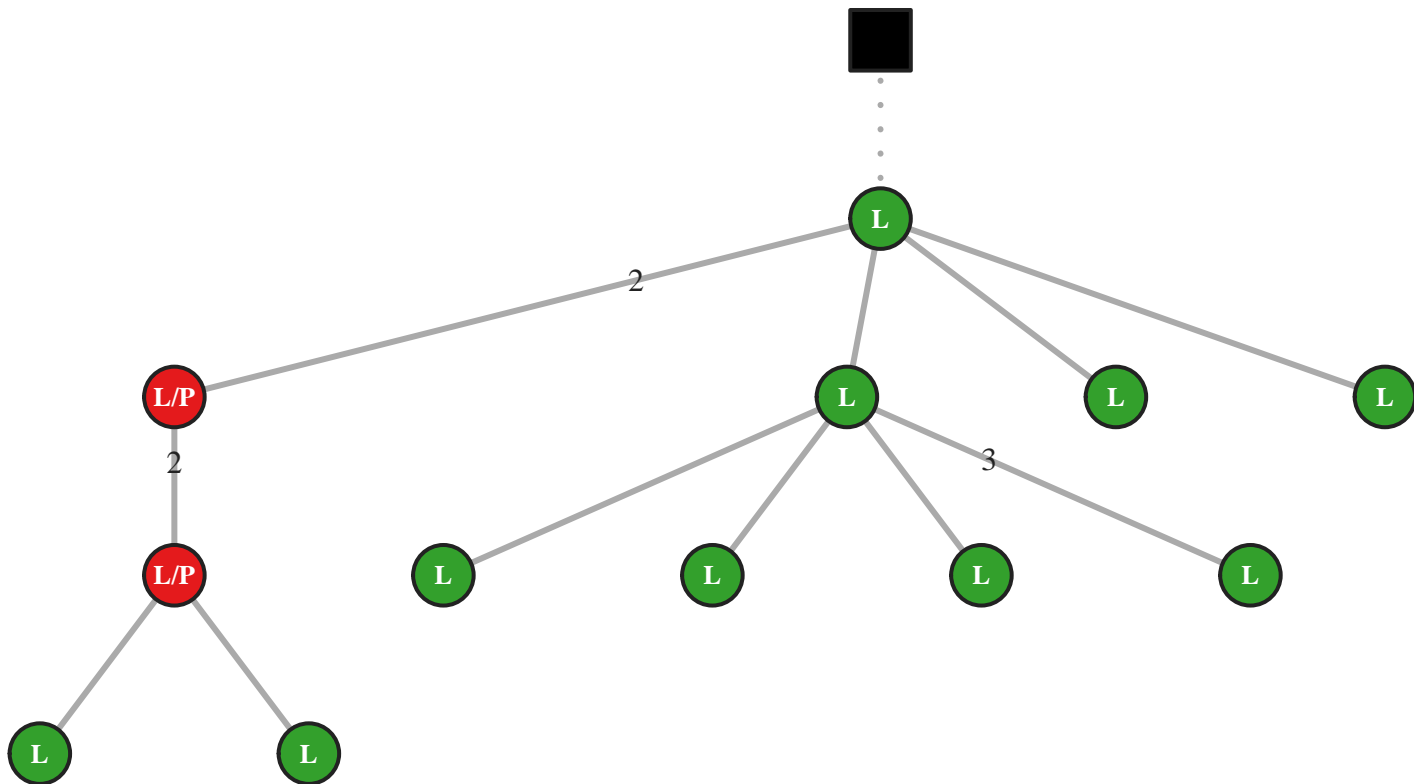

M5 IgG IGHV3-33/J4 54bp (34657)

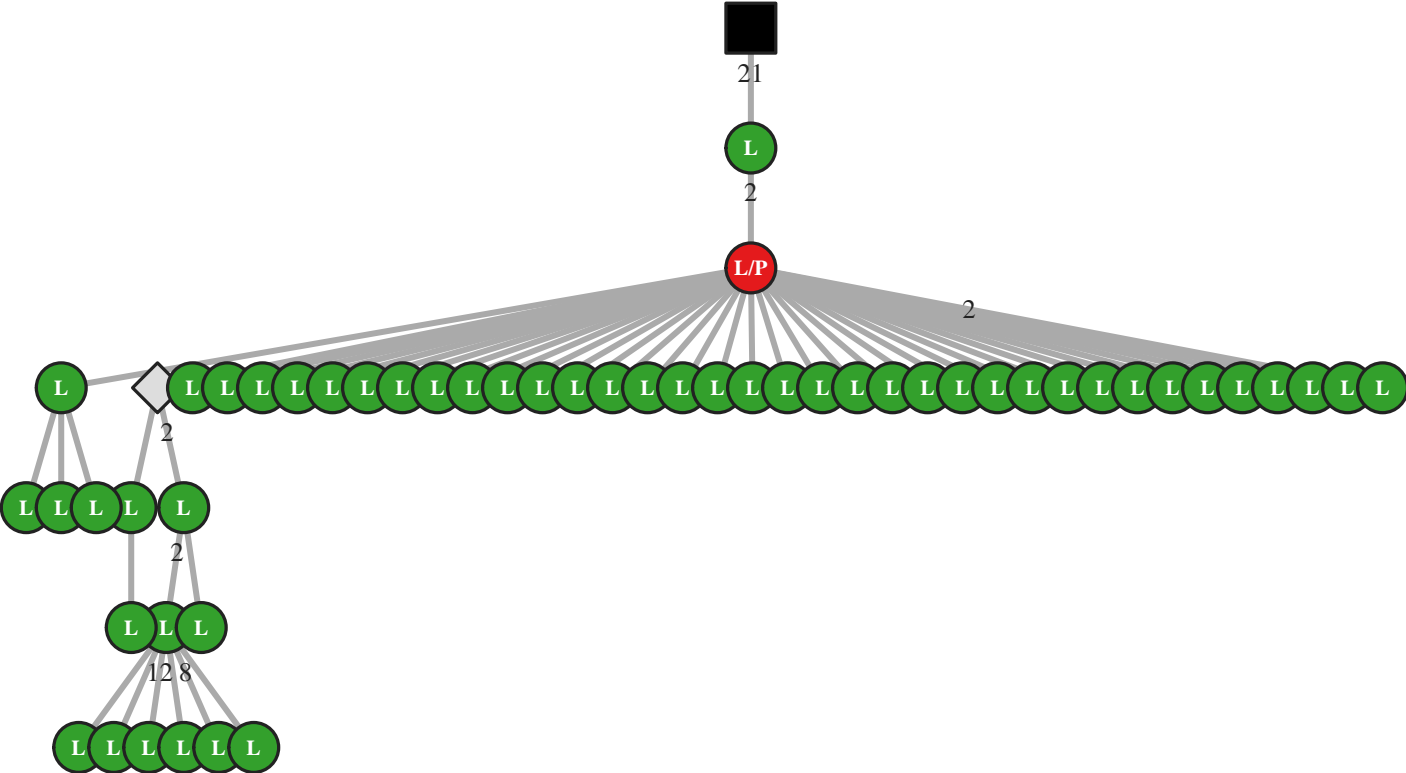

M5 IgG IGHV3-33/J4 54bp (34684)

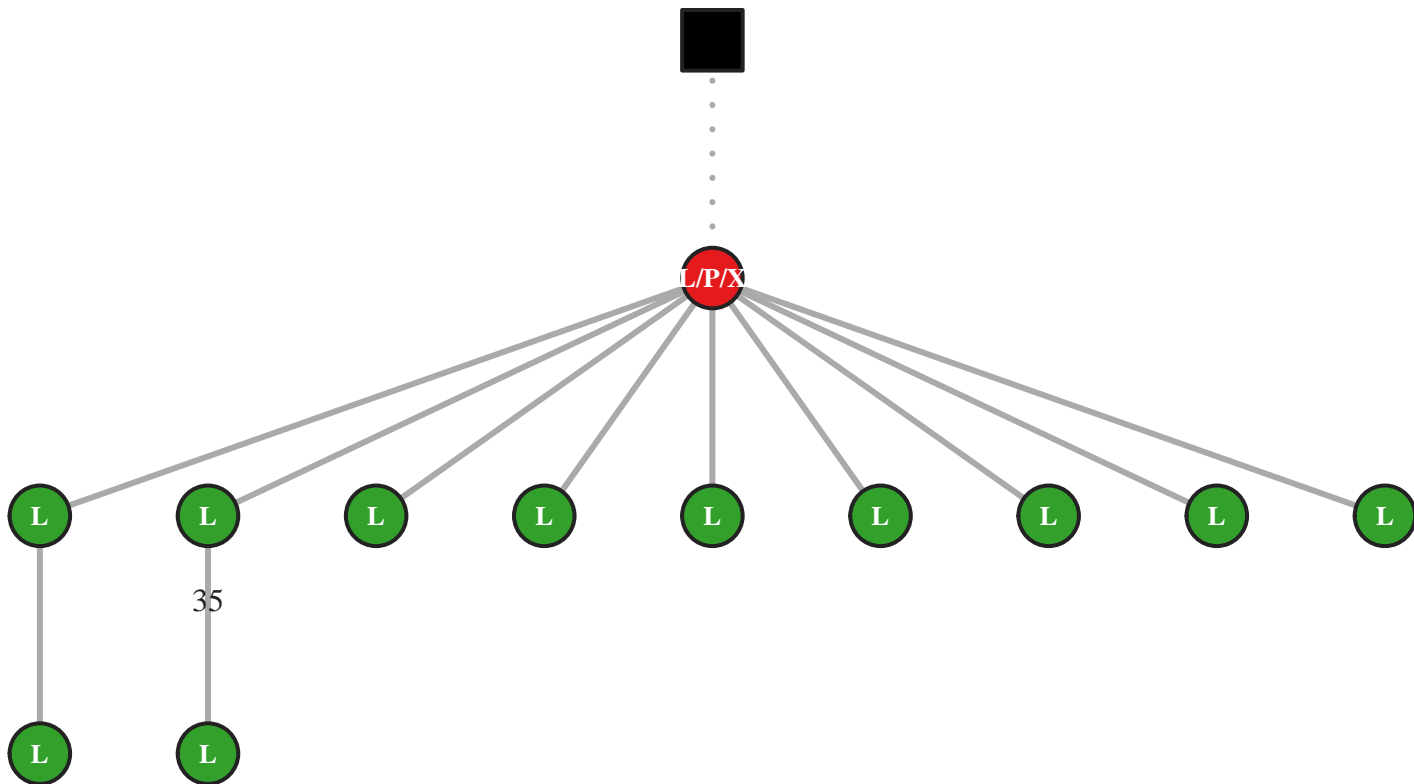

M5 IgG IGHV3-33/J4 54bp (34702)

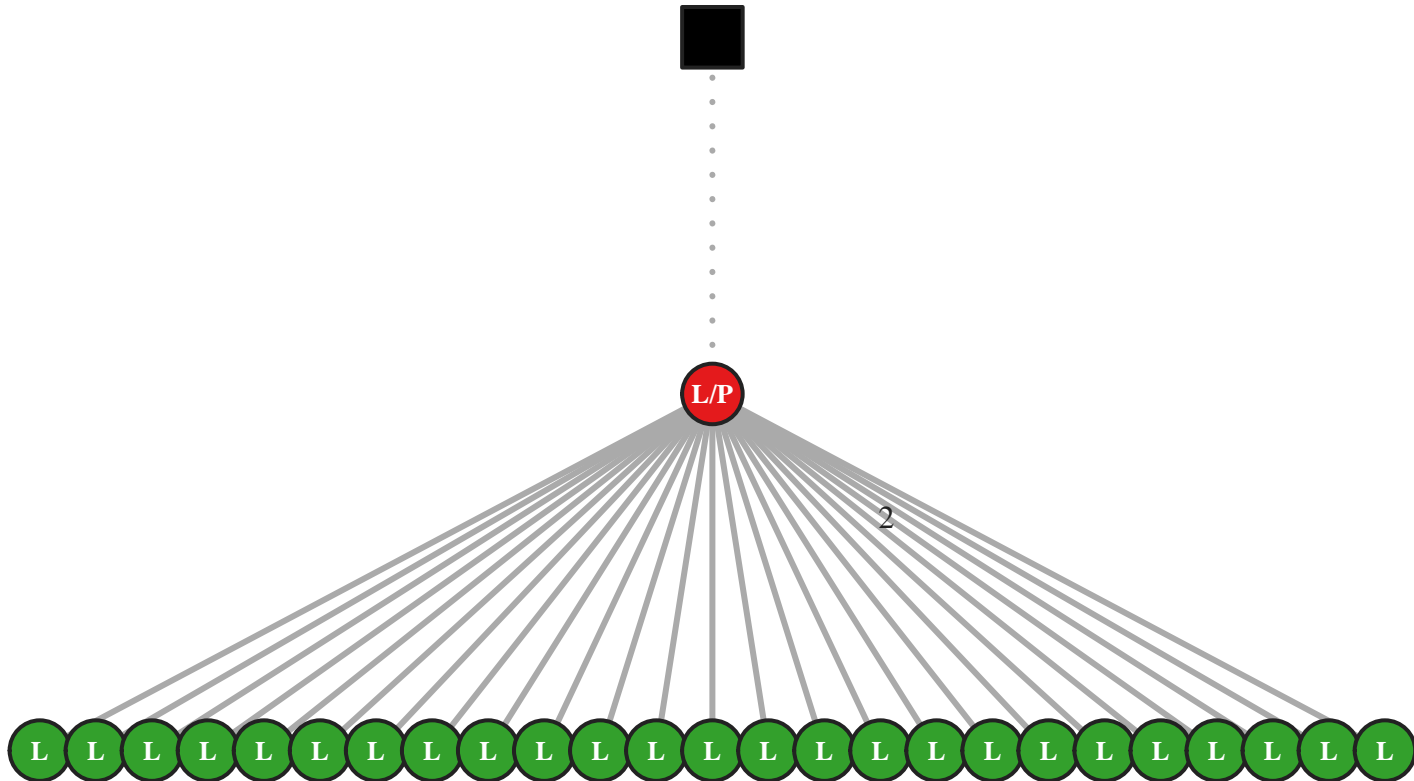

M5 IgG IGHV3-33/J4 57bp (51898)

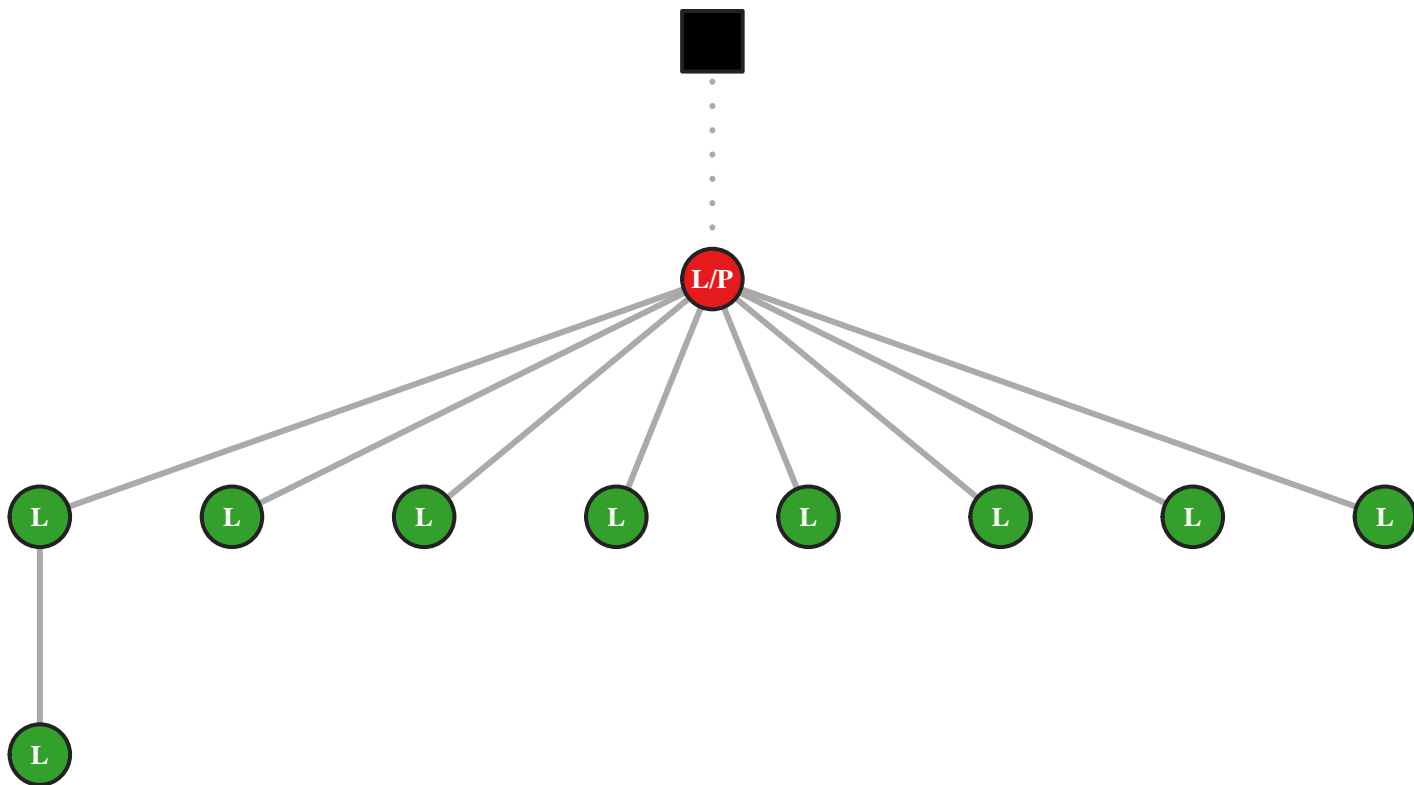

M5 IgG IGHV3-33/J4 57bp (51913)

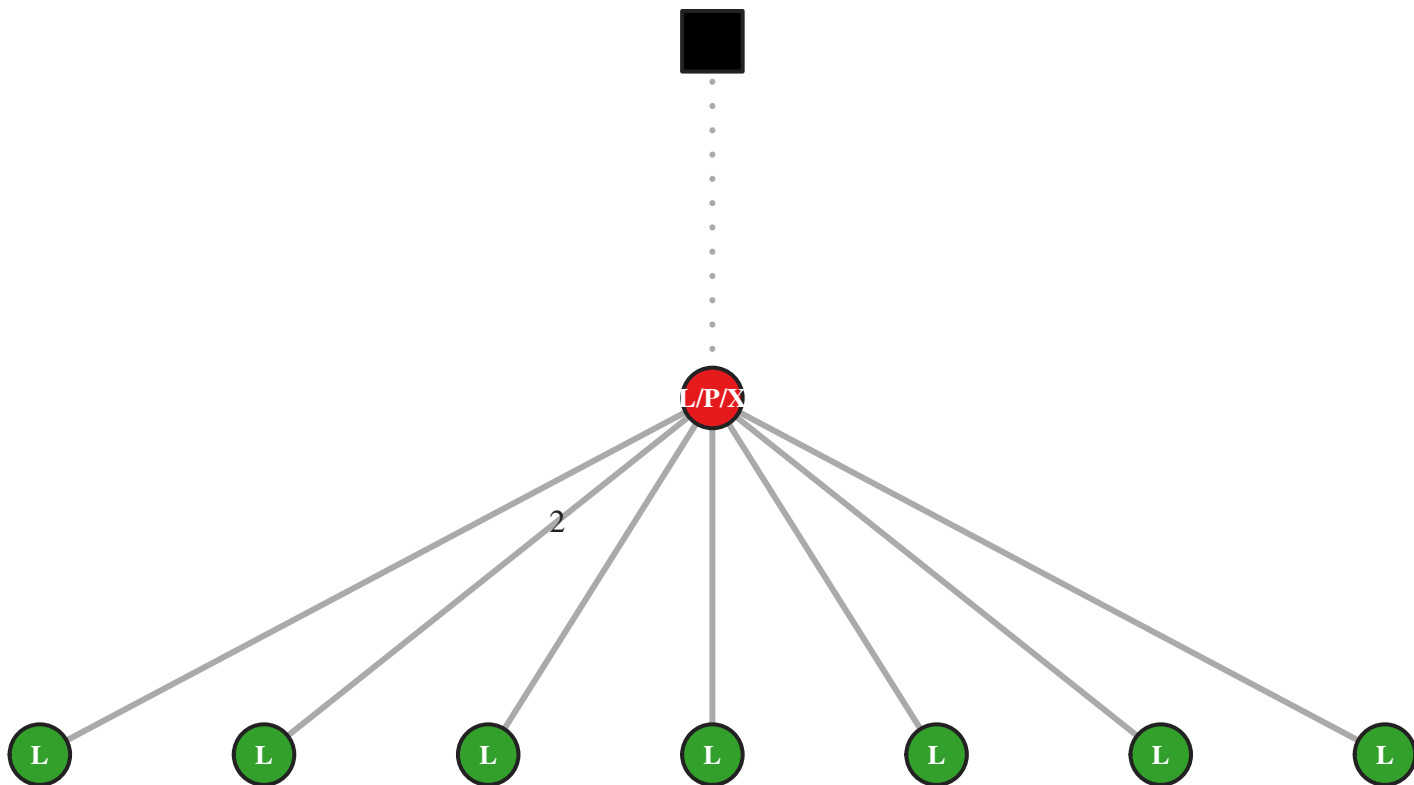

M5 IgG IGHV3-33/J4 60bp (25942)

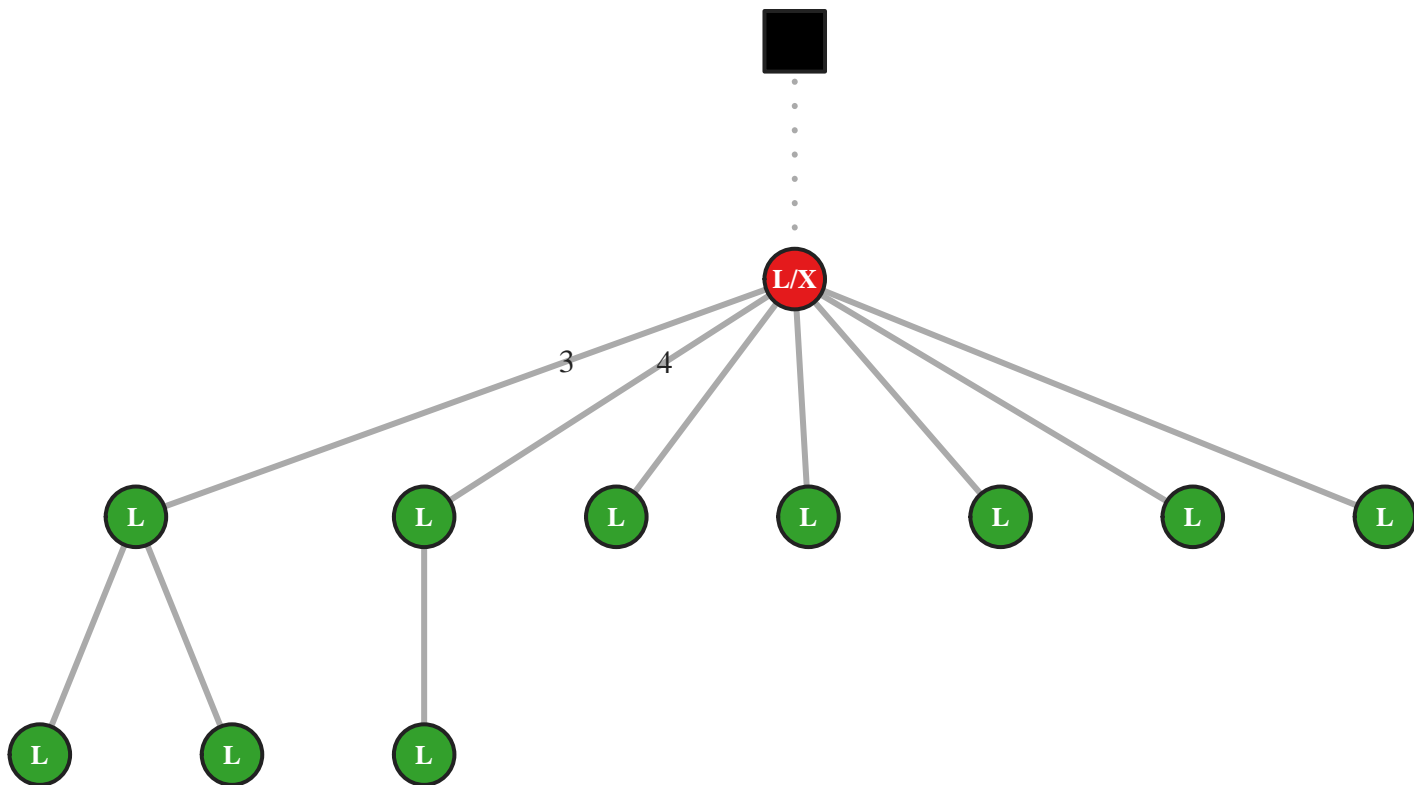

M5 IgG IGHV3-33/J4 66bp (45083)

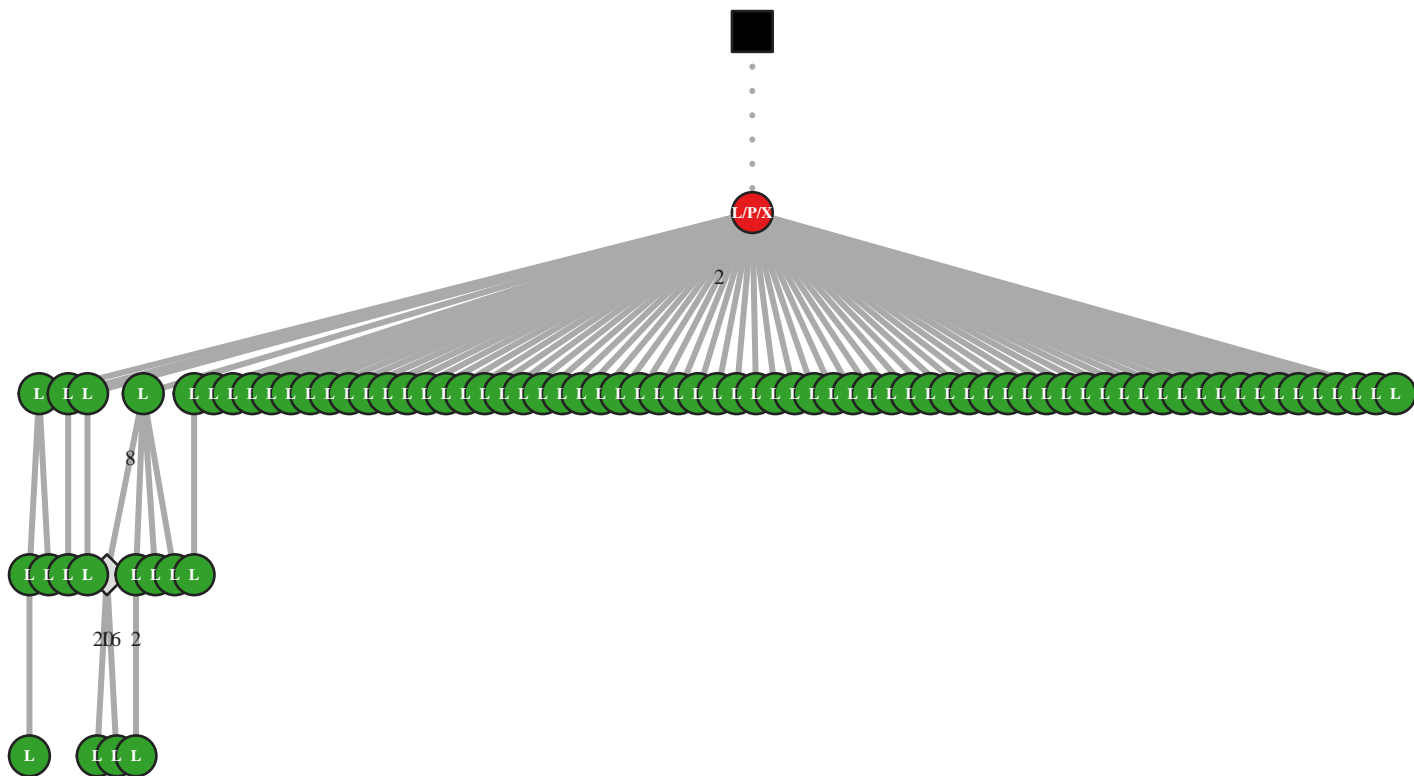

M5 IgG IGHV3-33/J4 66bp (45088)

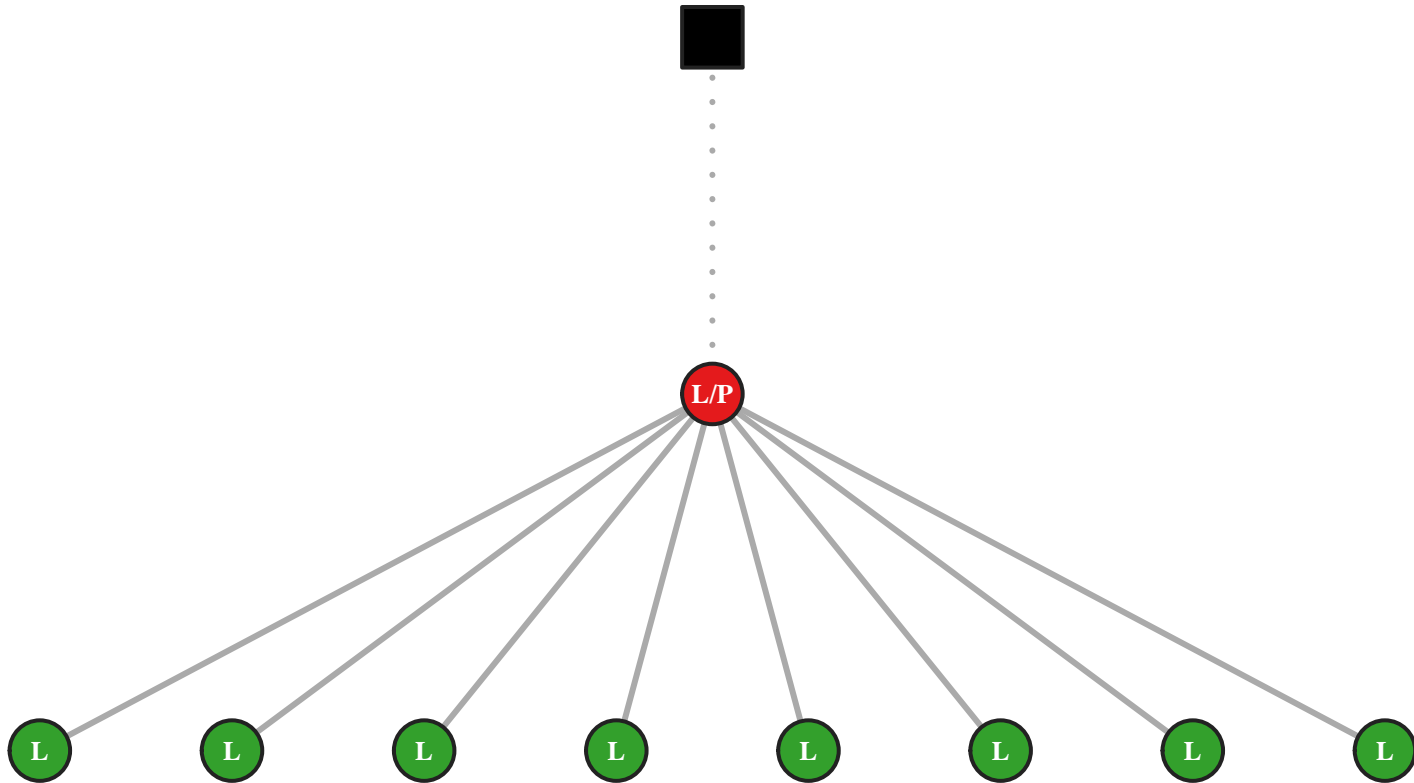

M5 IgG IGHV3-33/J5 48bp (44625)

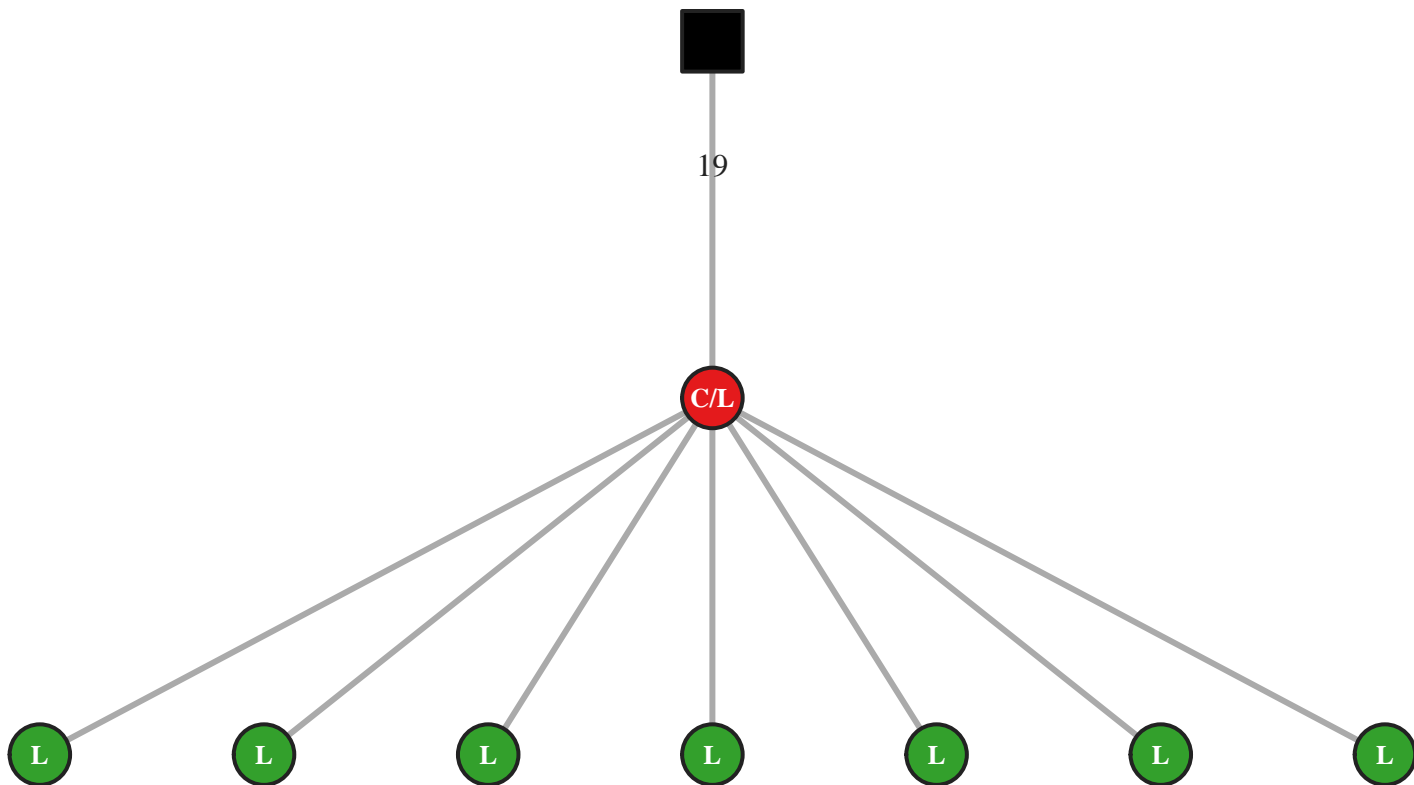

M5 IgG IGHV3-33/J5 48bp (44631)

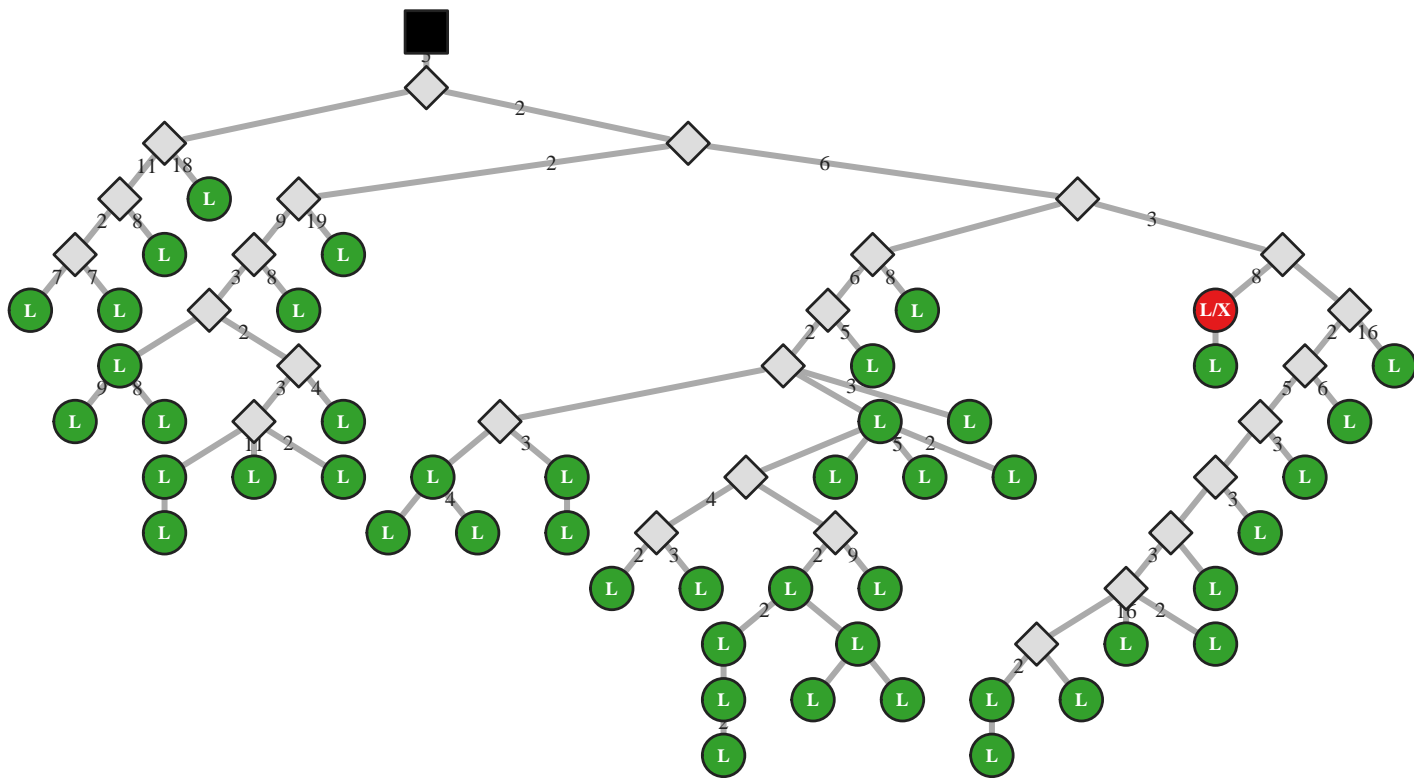

M5 IgG IGHV3-33/J5 51bp (17564)

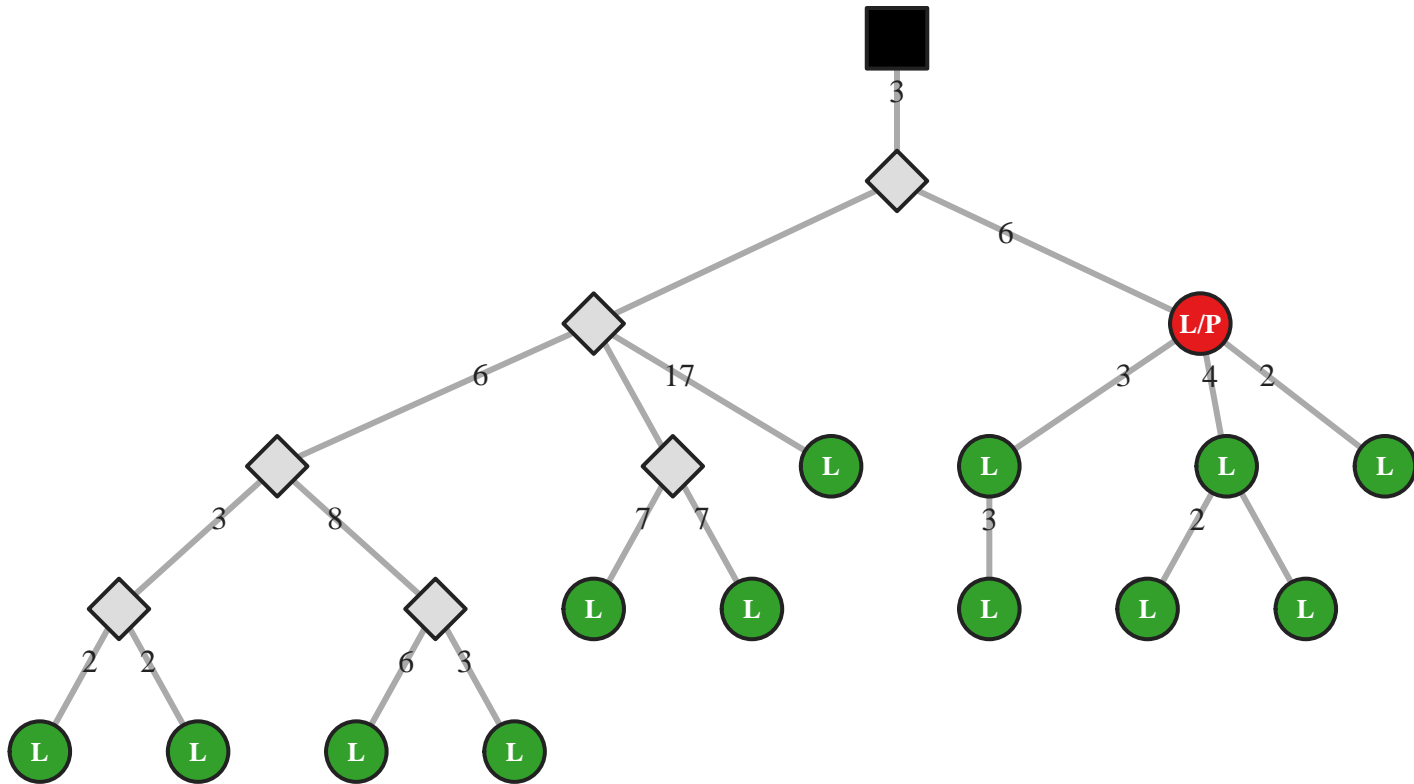

M5 IgG IGHV3-33/J5 54bp (8108)

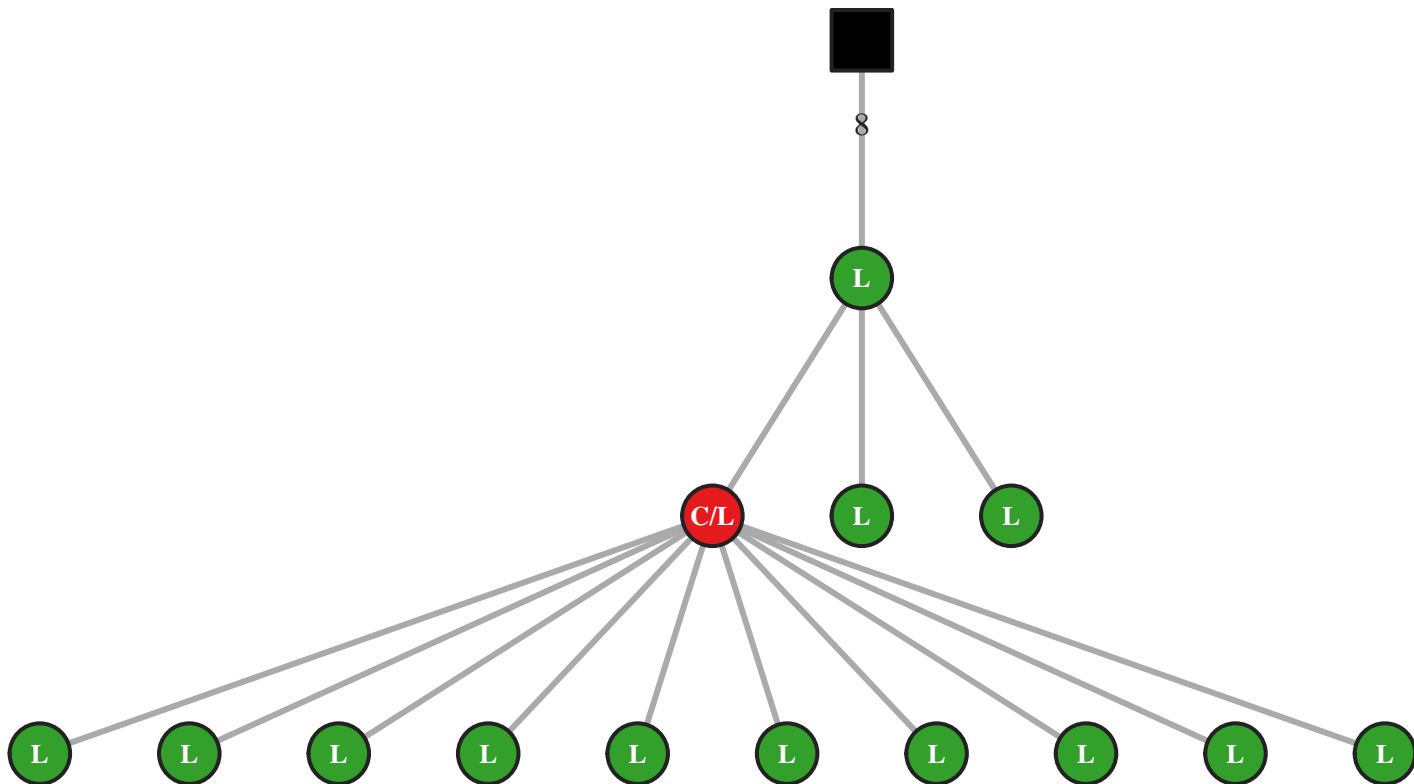

M5 IgG IGHV3-33/J6 51bp (51972)

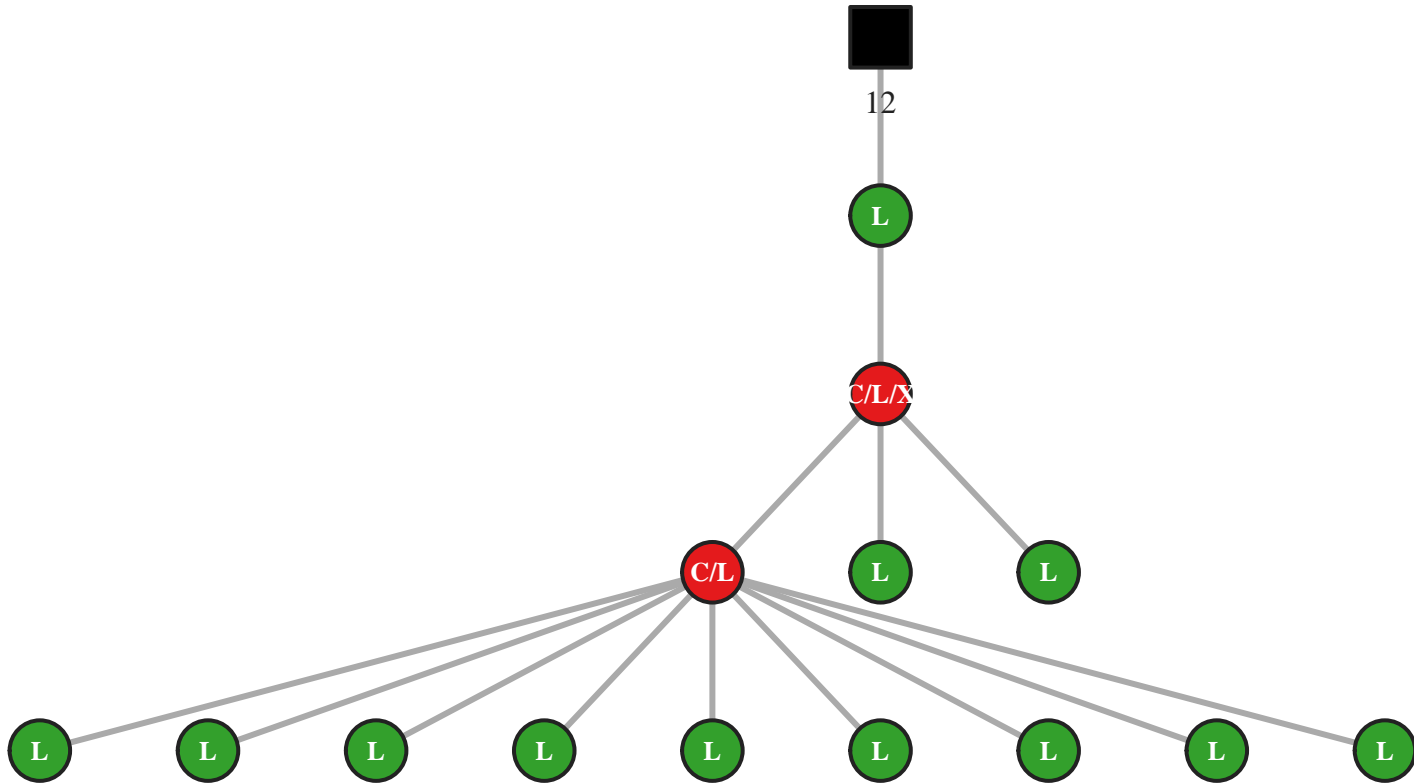

M5 IgG IGHV3-33/J6 54bp (51689)

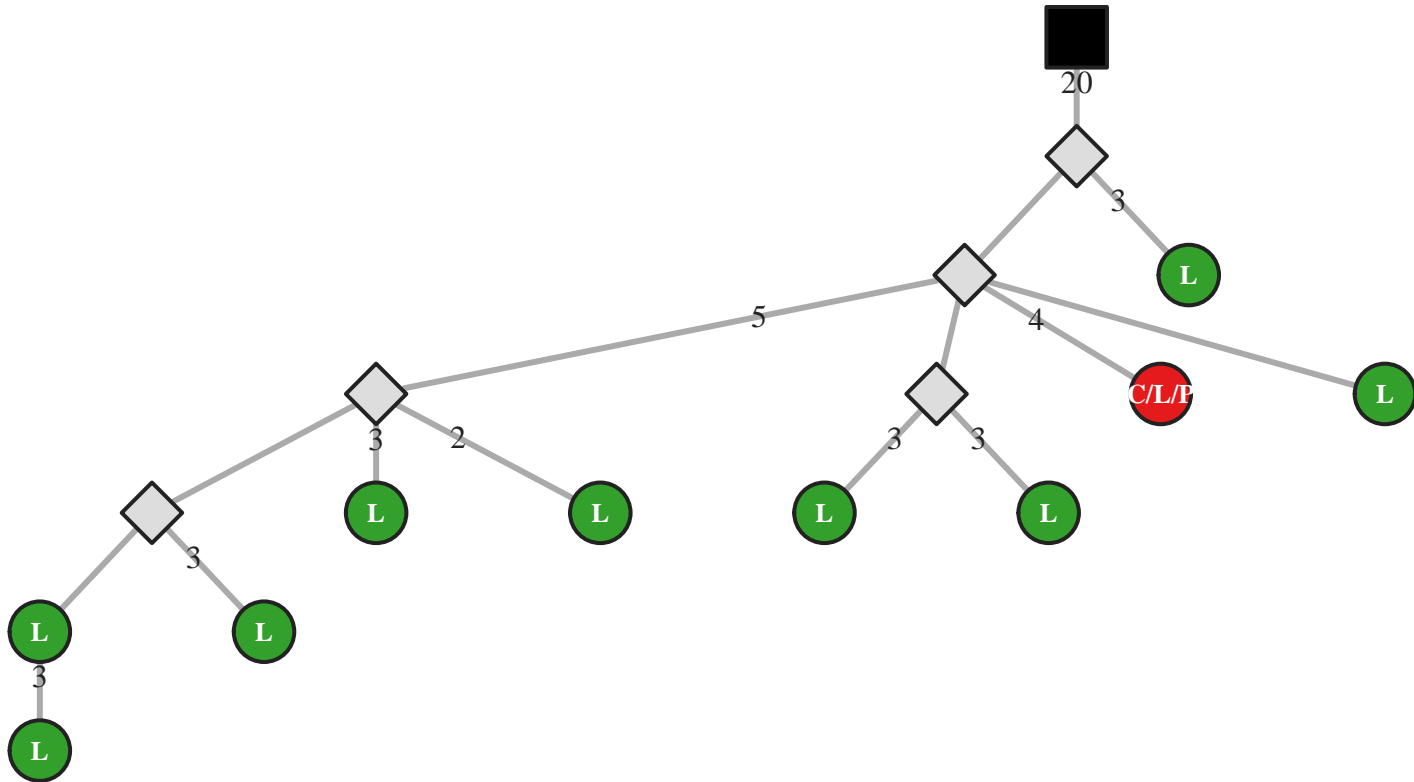

M5 IgG IGHV3-33/J6 54bp (51709)

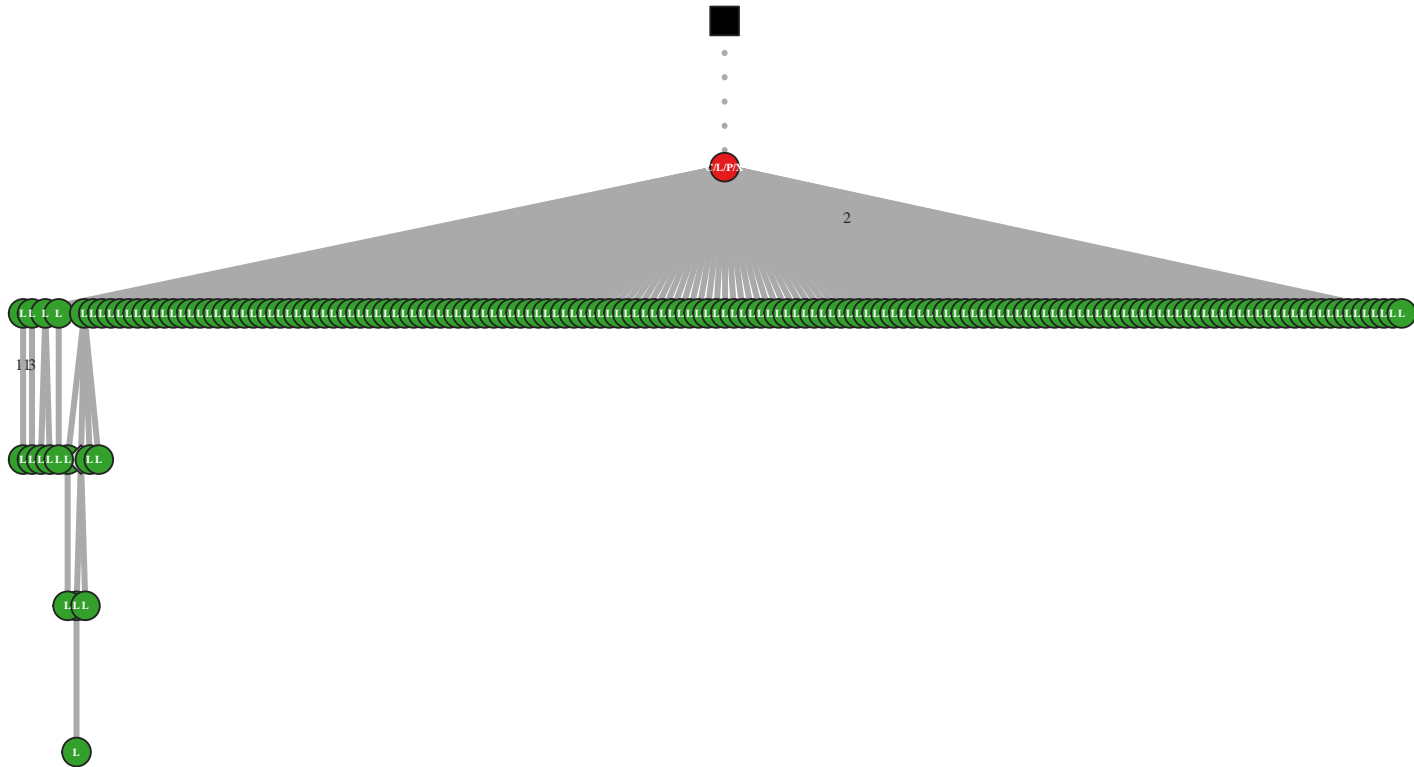

M5 IgG IGHV3-33/J6 66bp (17787)

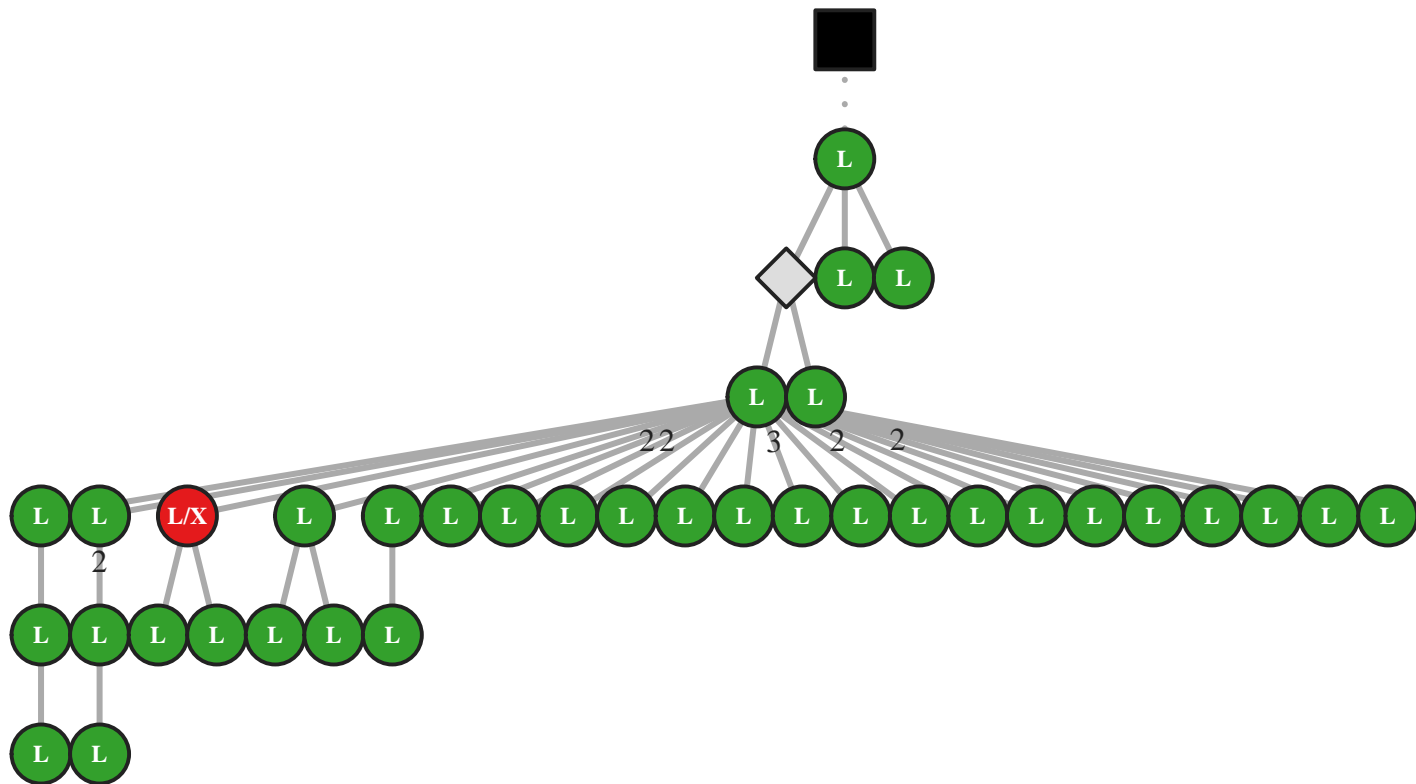

M5 IgG IGHV3-33/J6 69bp (17807)

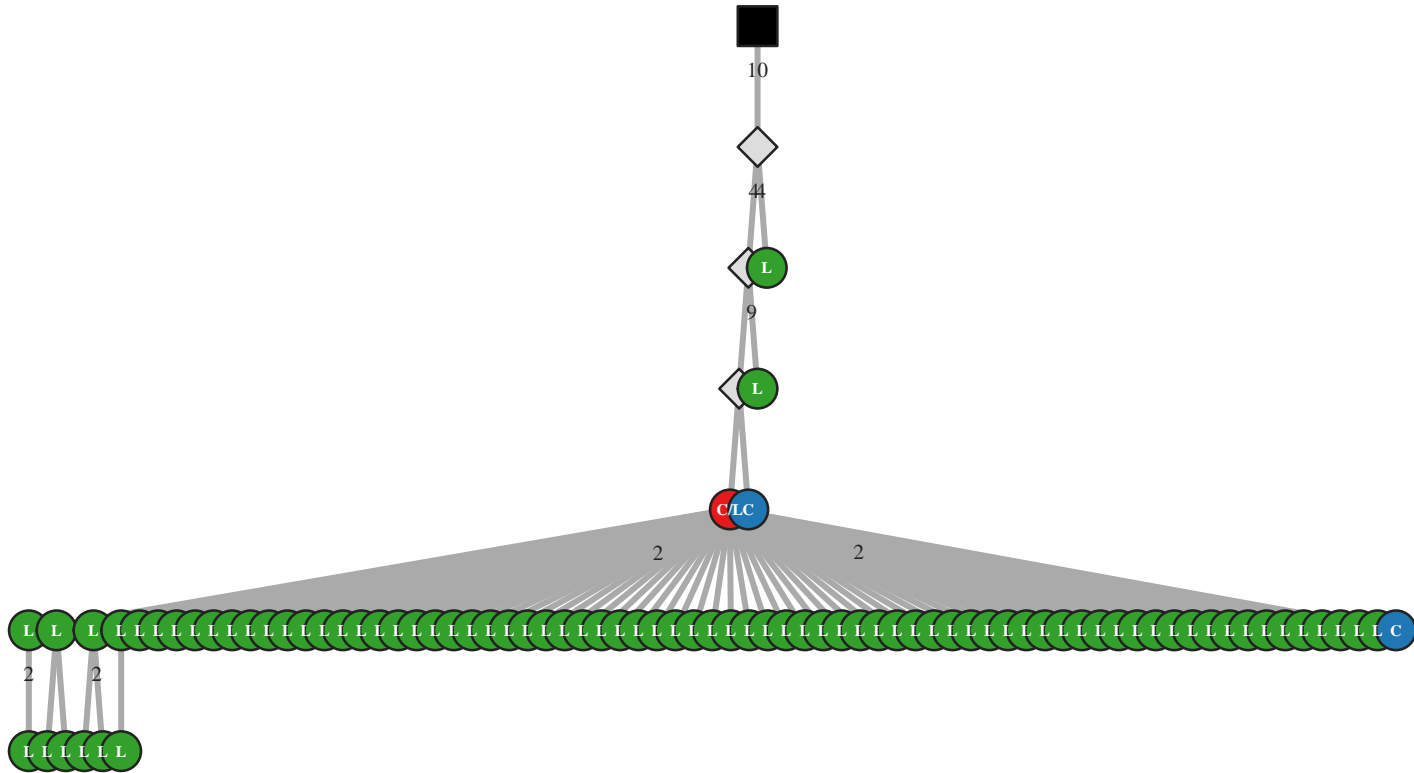

M5 IgG IGHV3-43/J4 54bp (45158)

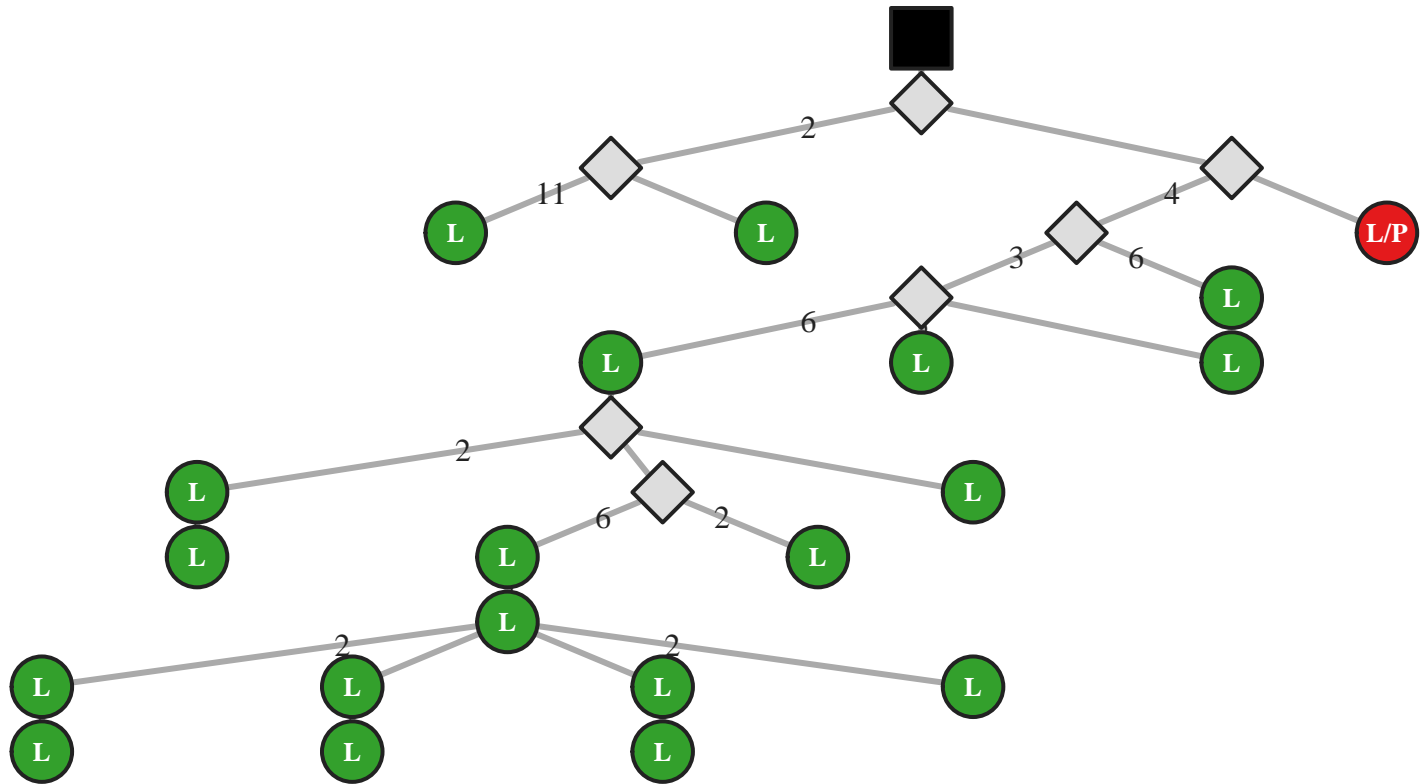

M5 IgG IGHV3-43/J4 57bp (8143)

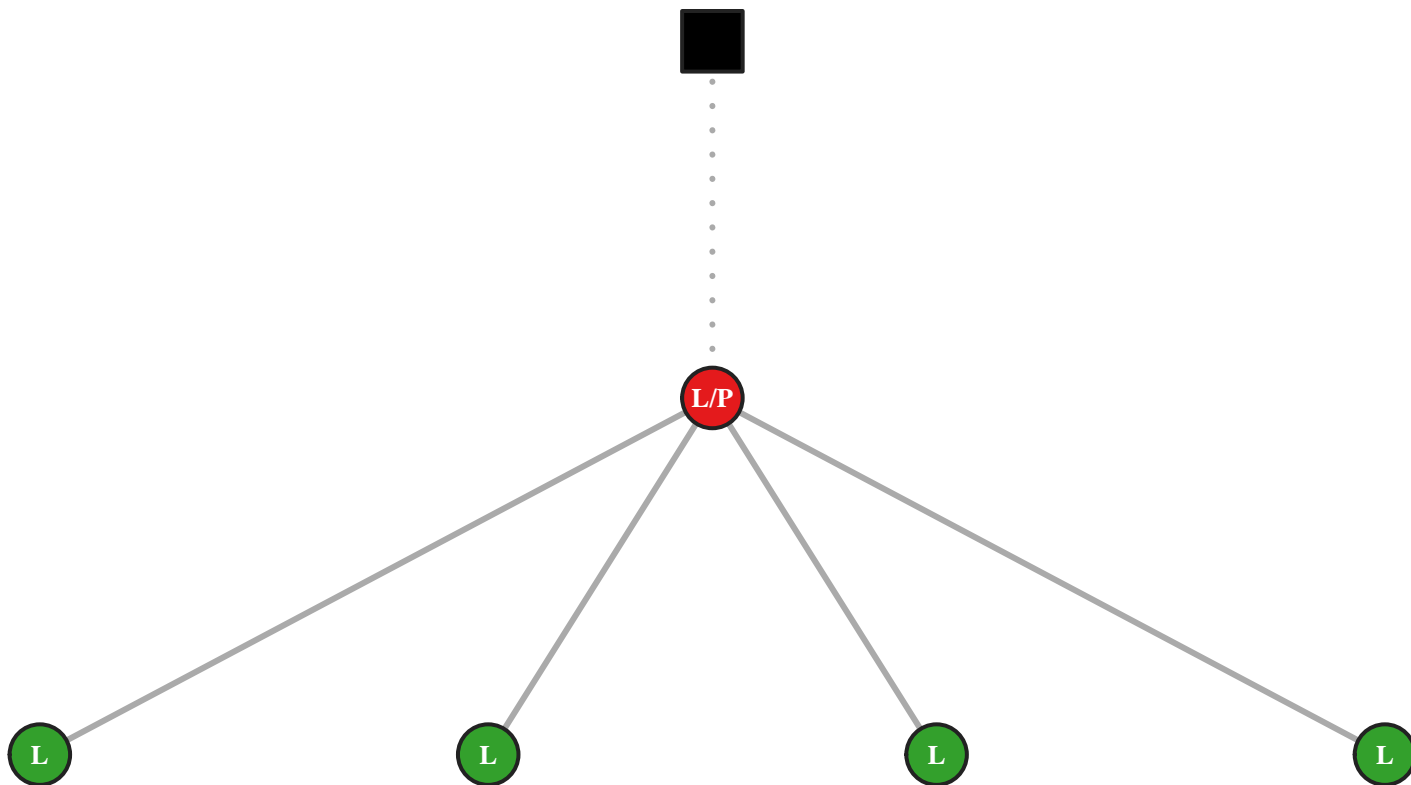

M5 IgG IGHV3-43/J5 51bp (35206)

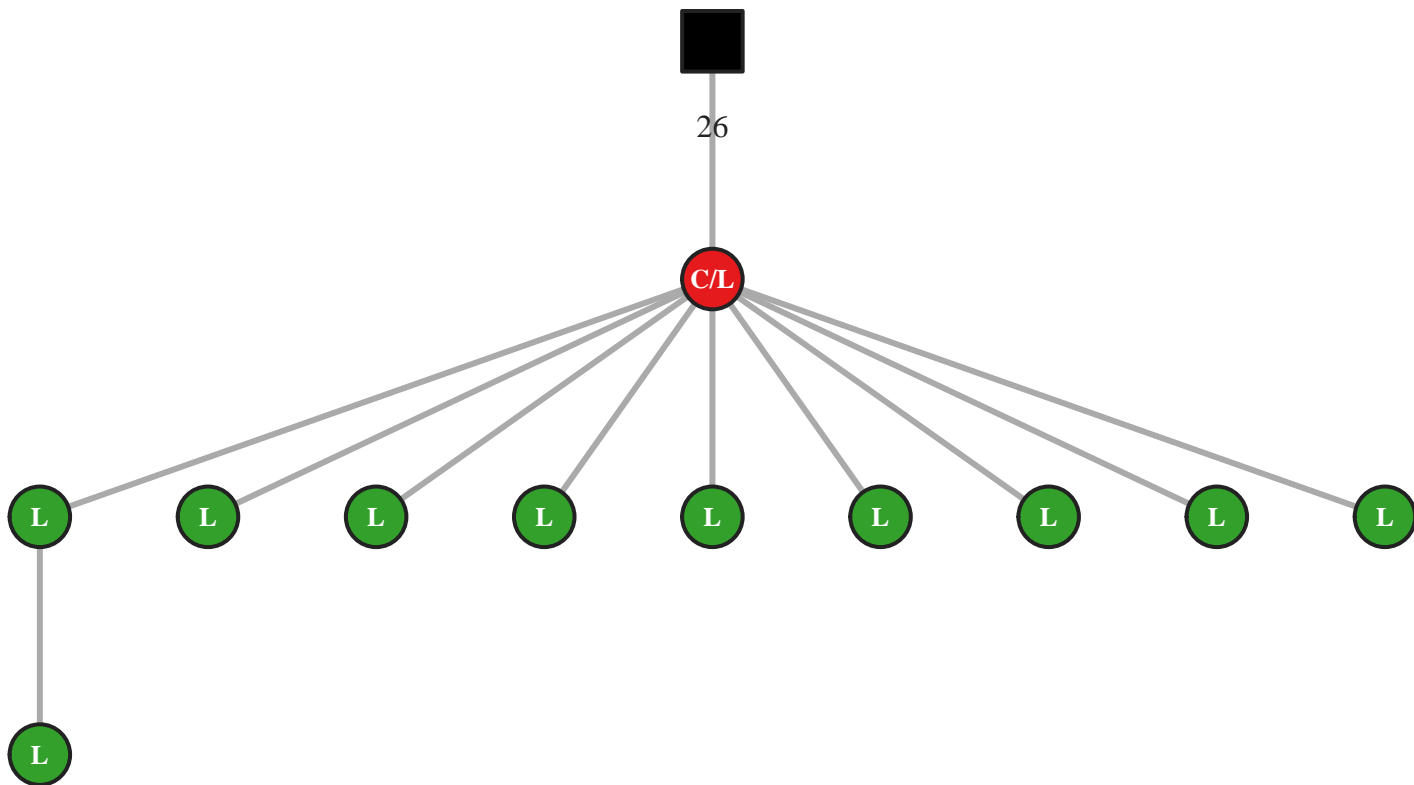

M5 IgG IGHV3-43/J6 36bp (35209)

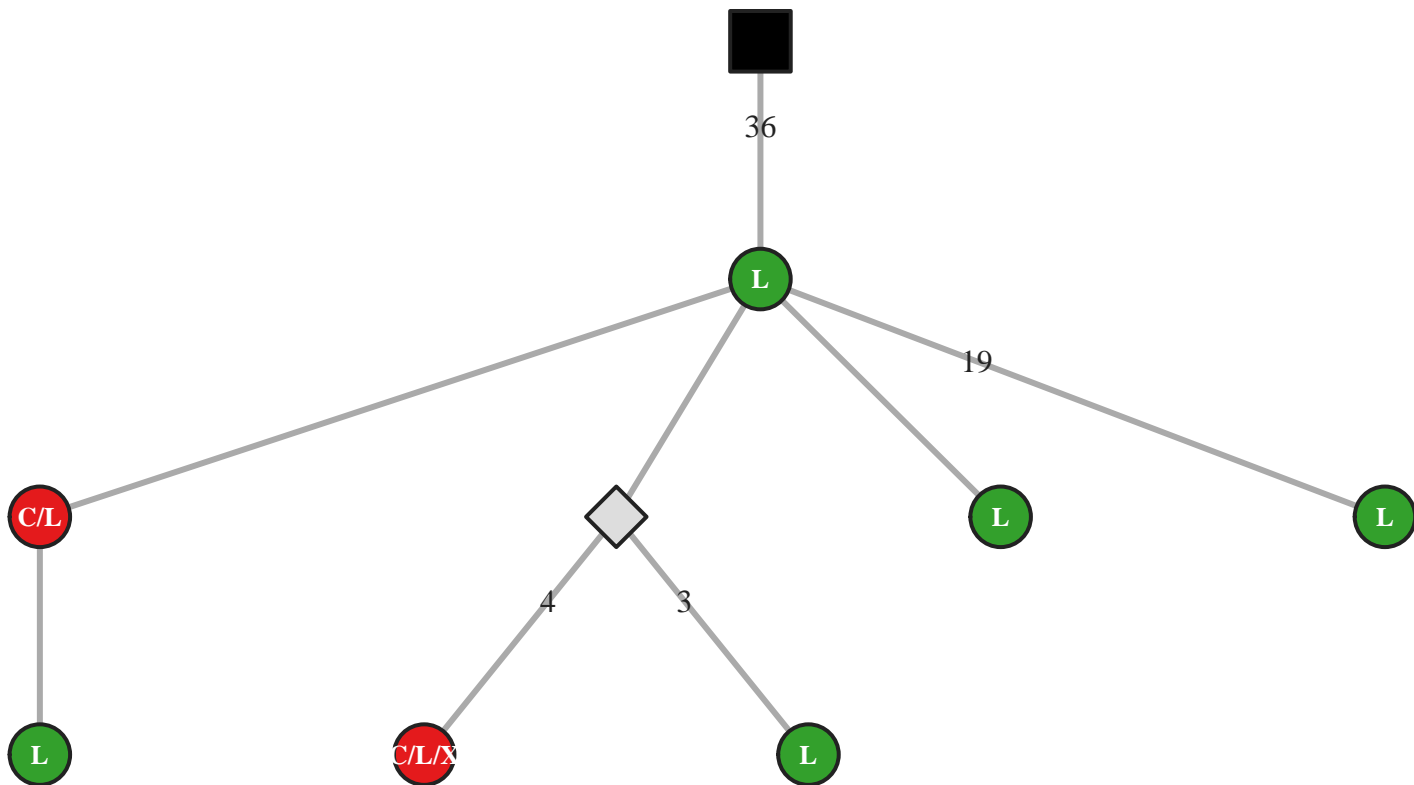

M5 IgG IGHV3-43/J6 42bp (35210)

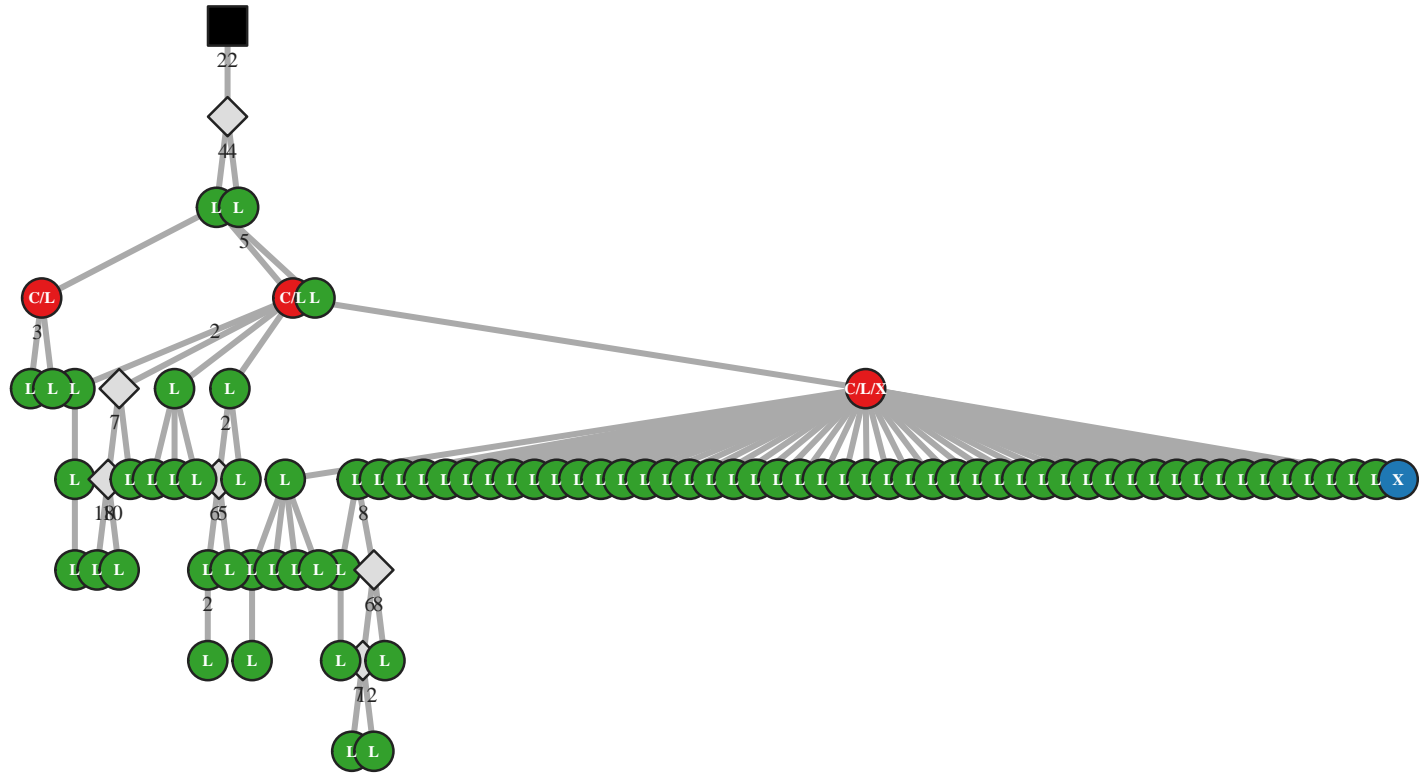

M5 IgG IGHV3-48/J3 45bp (35223)

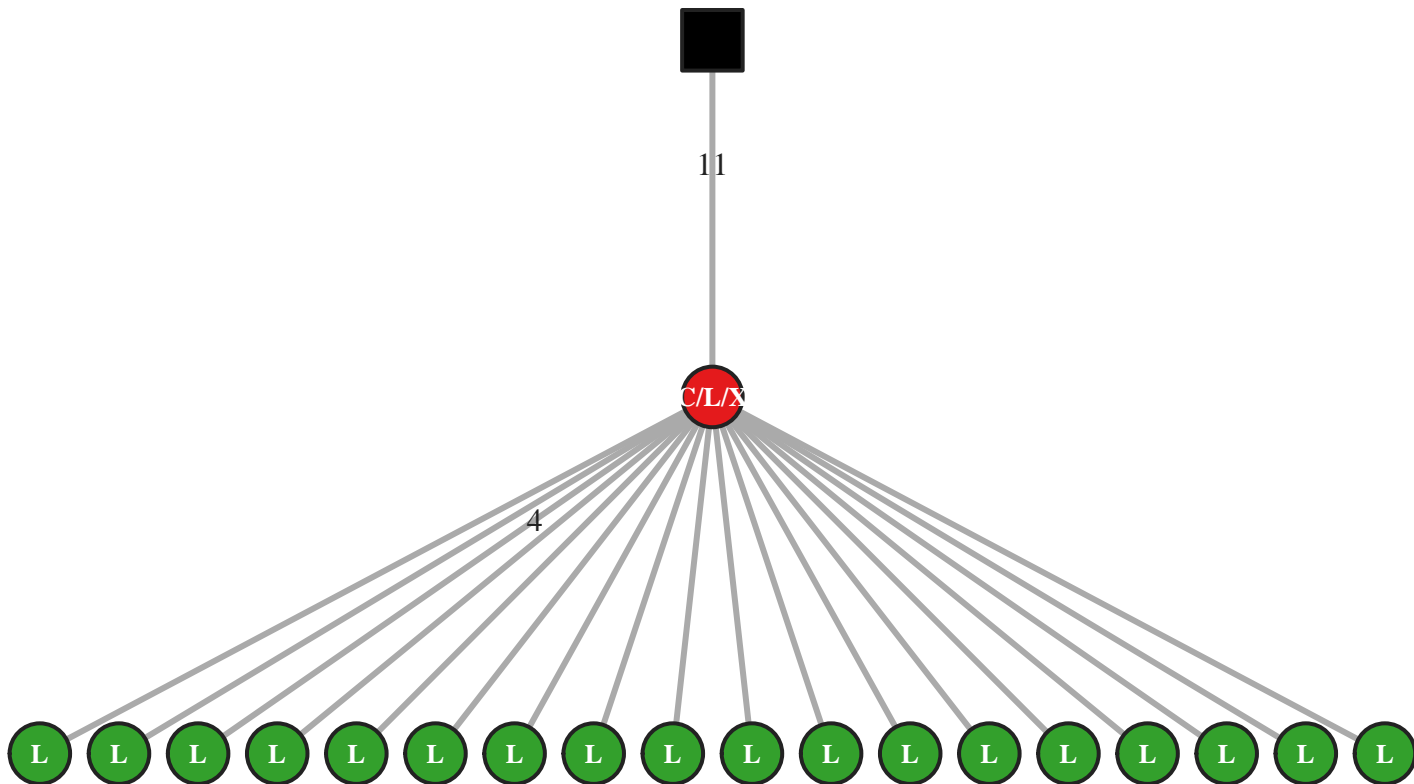

M5 IgG IGHV3-48/J3 54bp (17836)

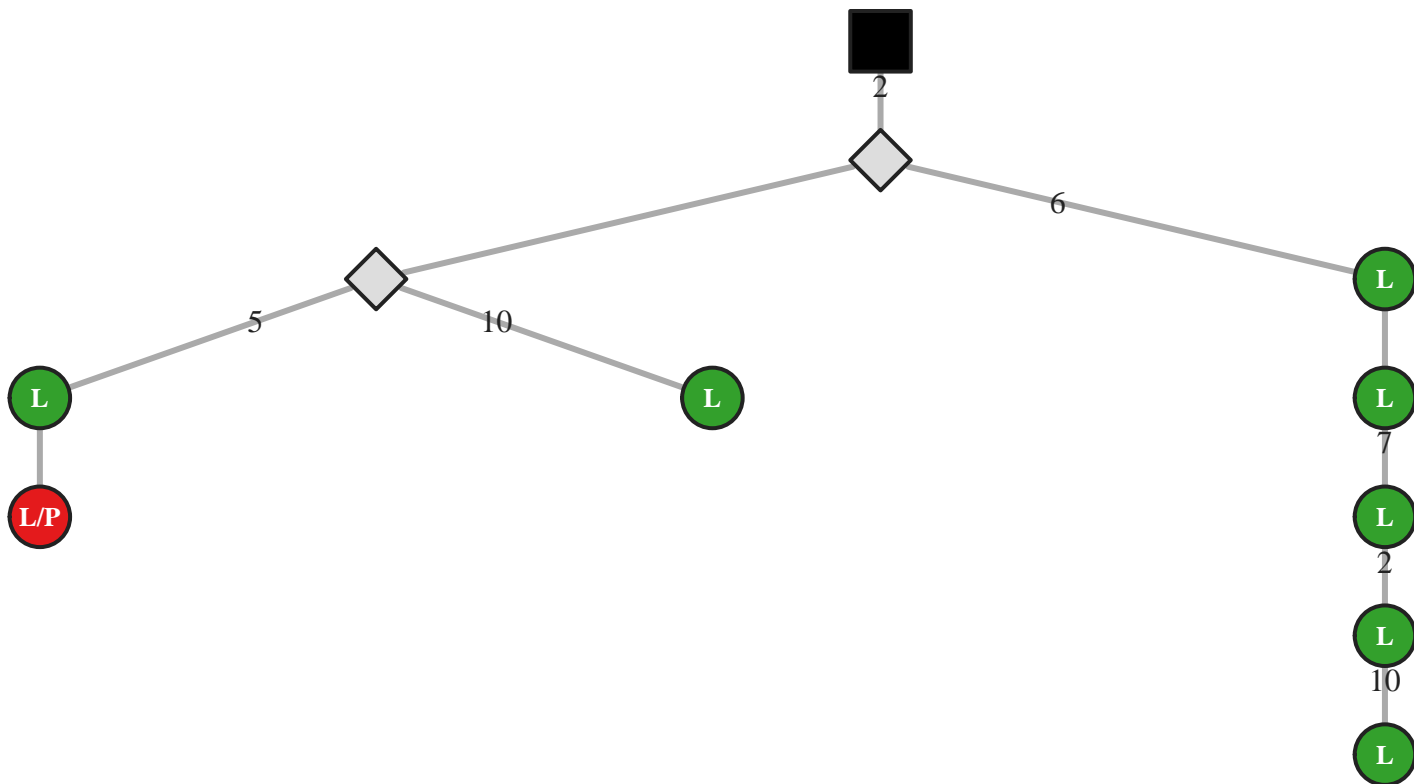

M5 IgG IGHV3-48/J4 33bp (35259)

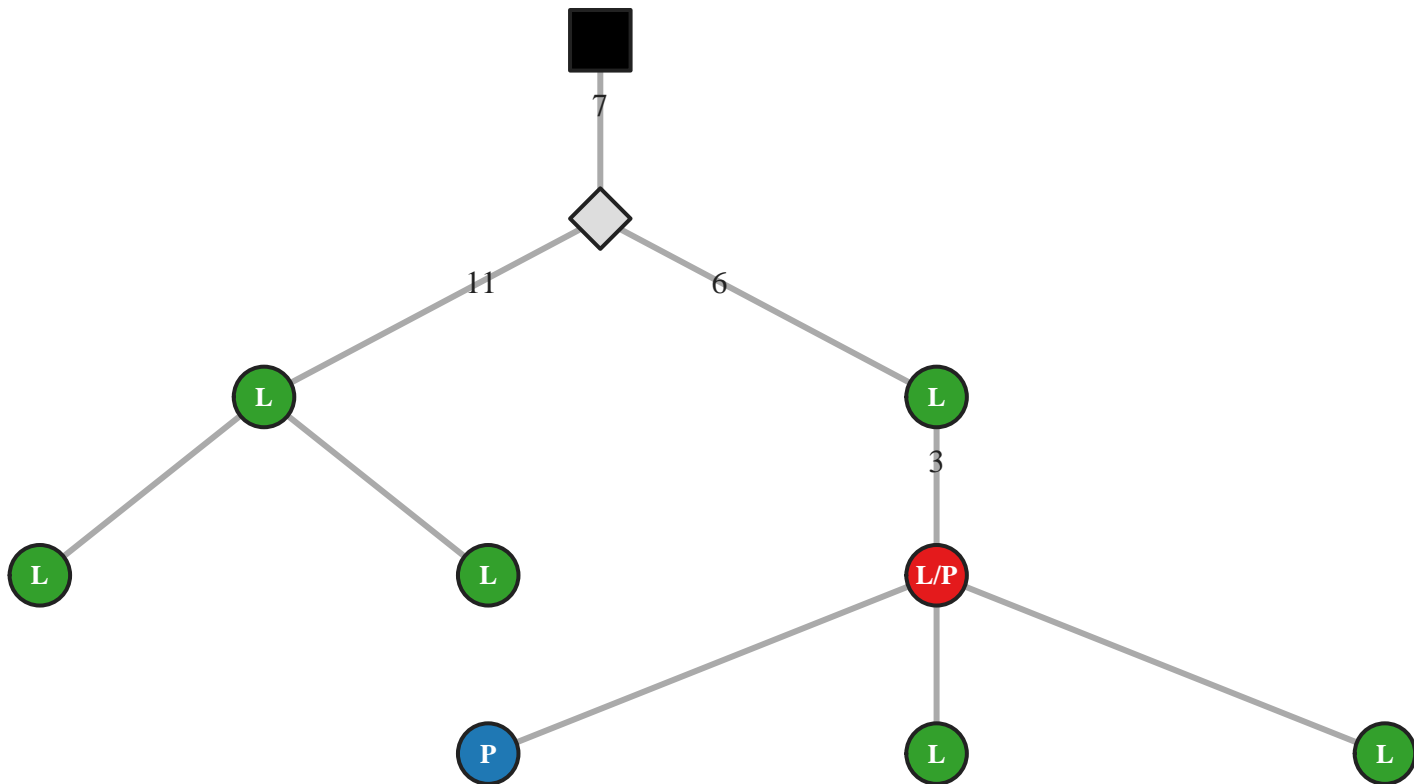

M5 IgG IGHV3-48/J4 33bp (35262)

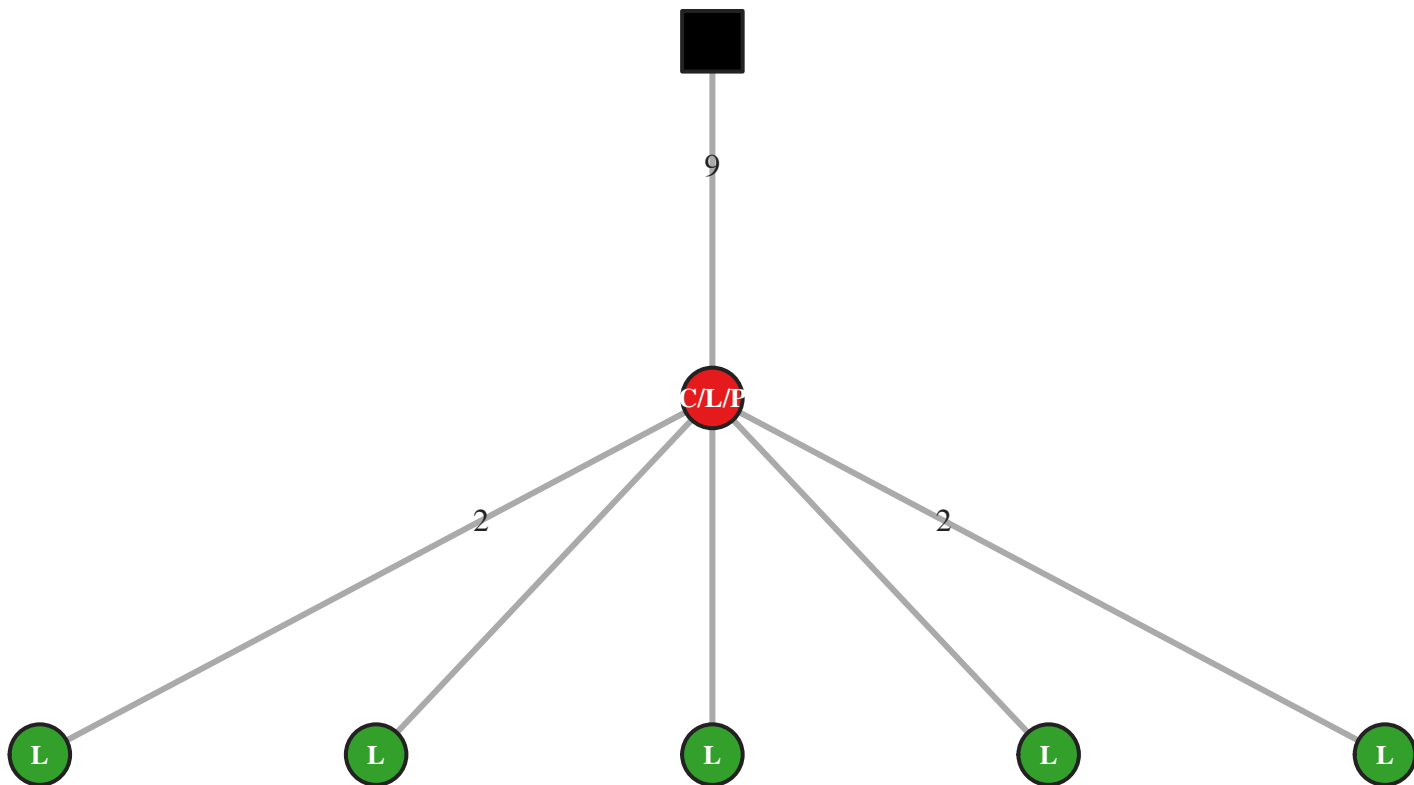

M5 IgG IGHV3-48/J4 39bp (8169)

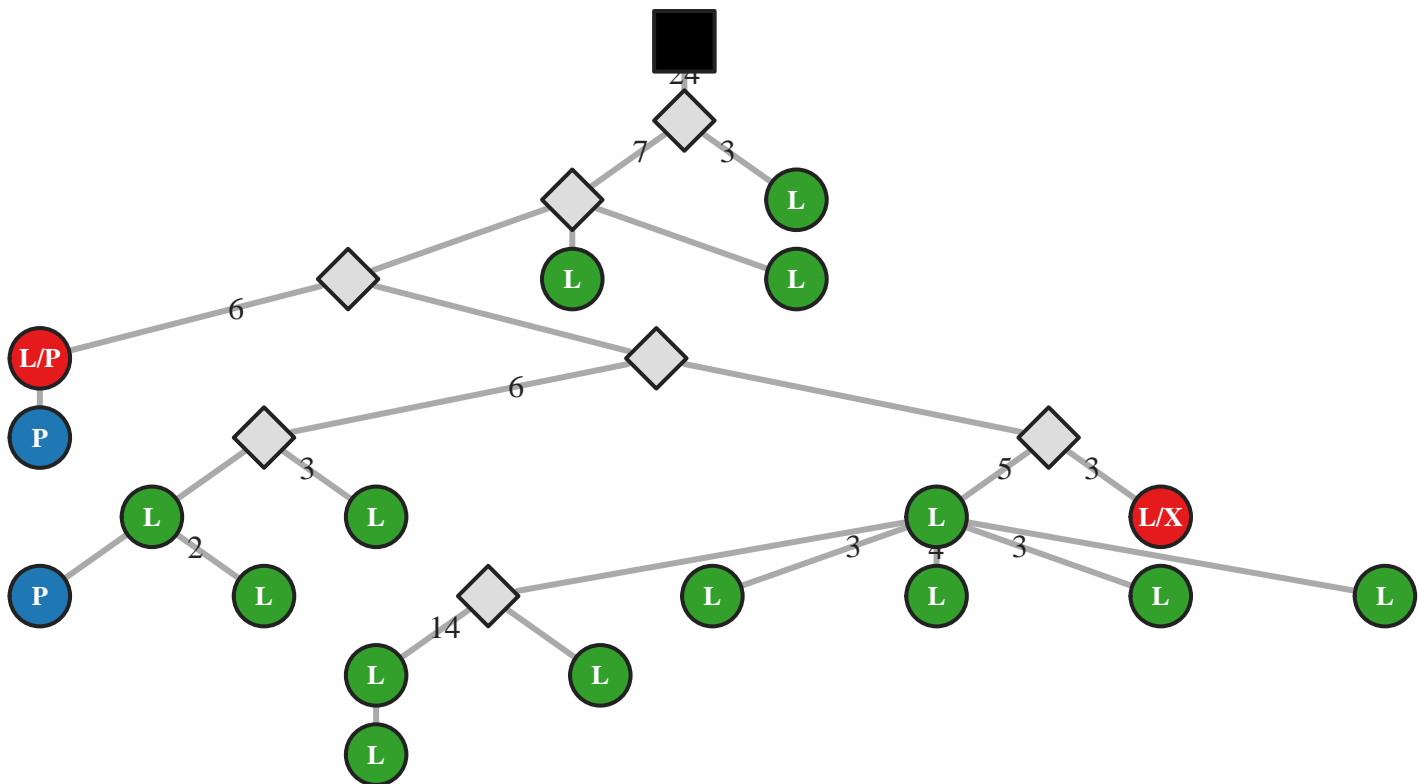

M5 IgG IGHV3-48/J4 39bp (8210)

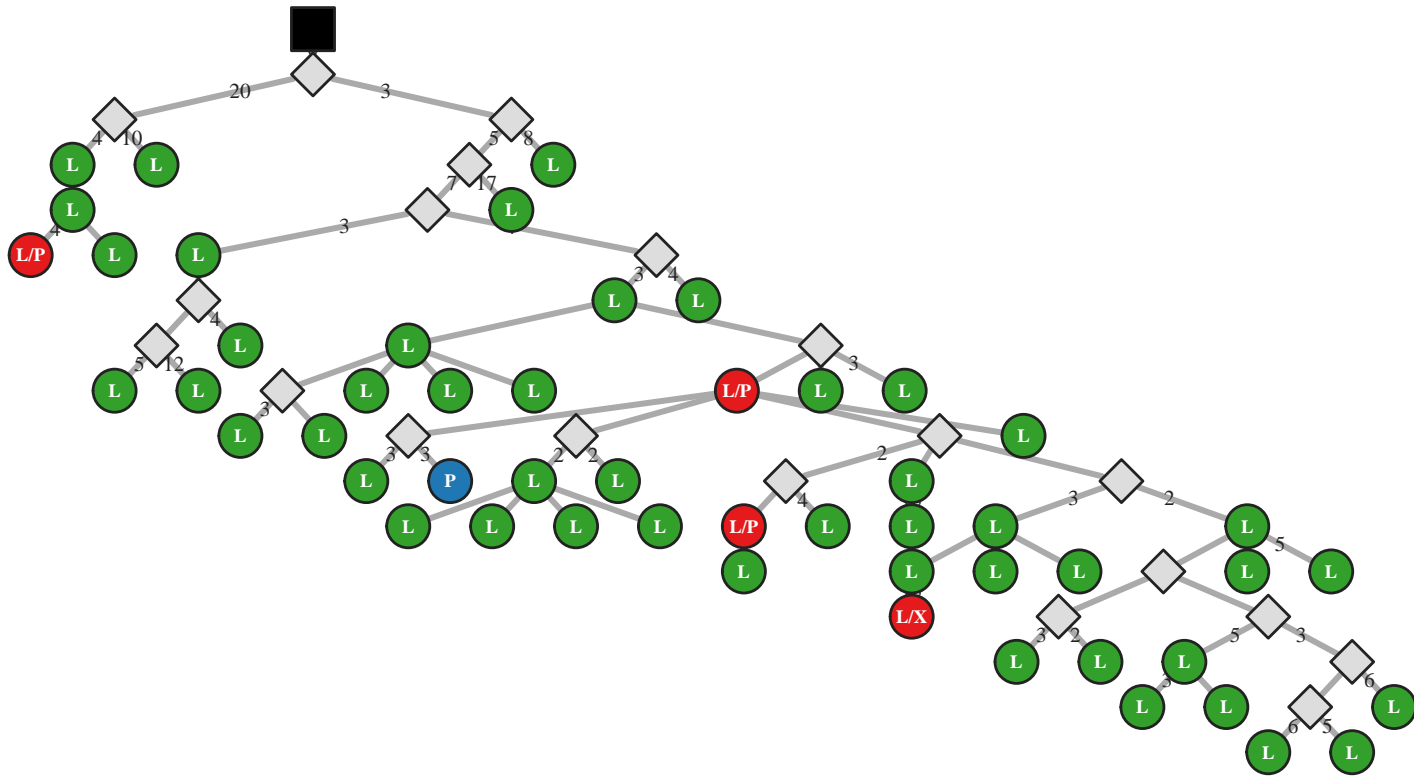

M5 IgG IGHV3-48/J4 42bp (8247)

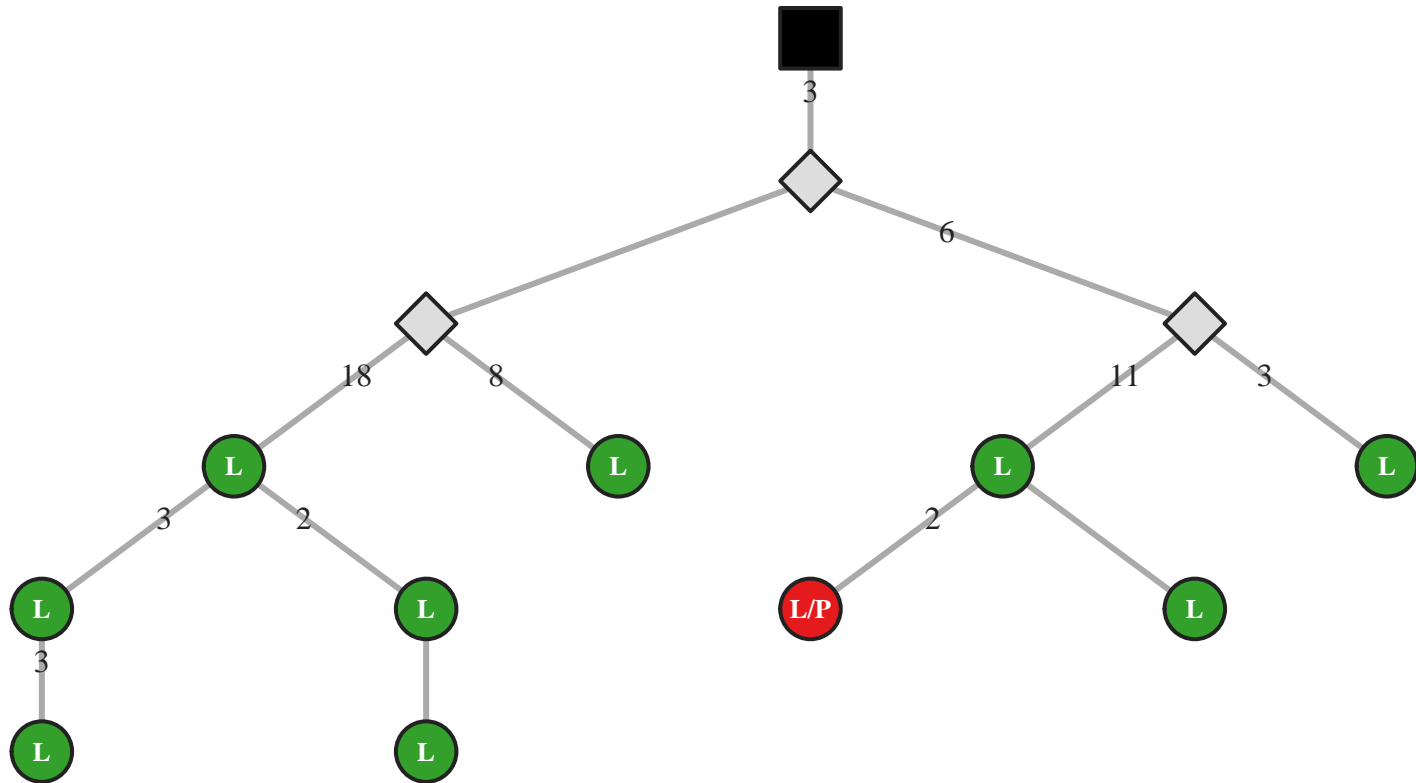

M5 IgG IGHV3-48/J4 51bp (26795)

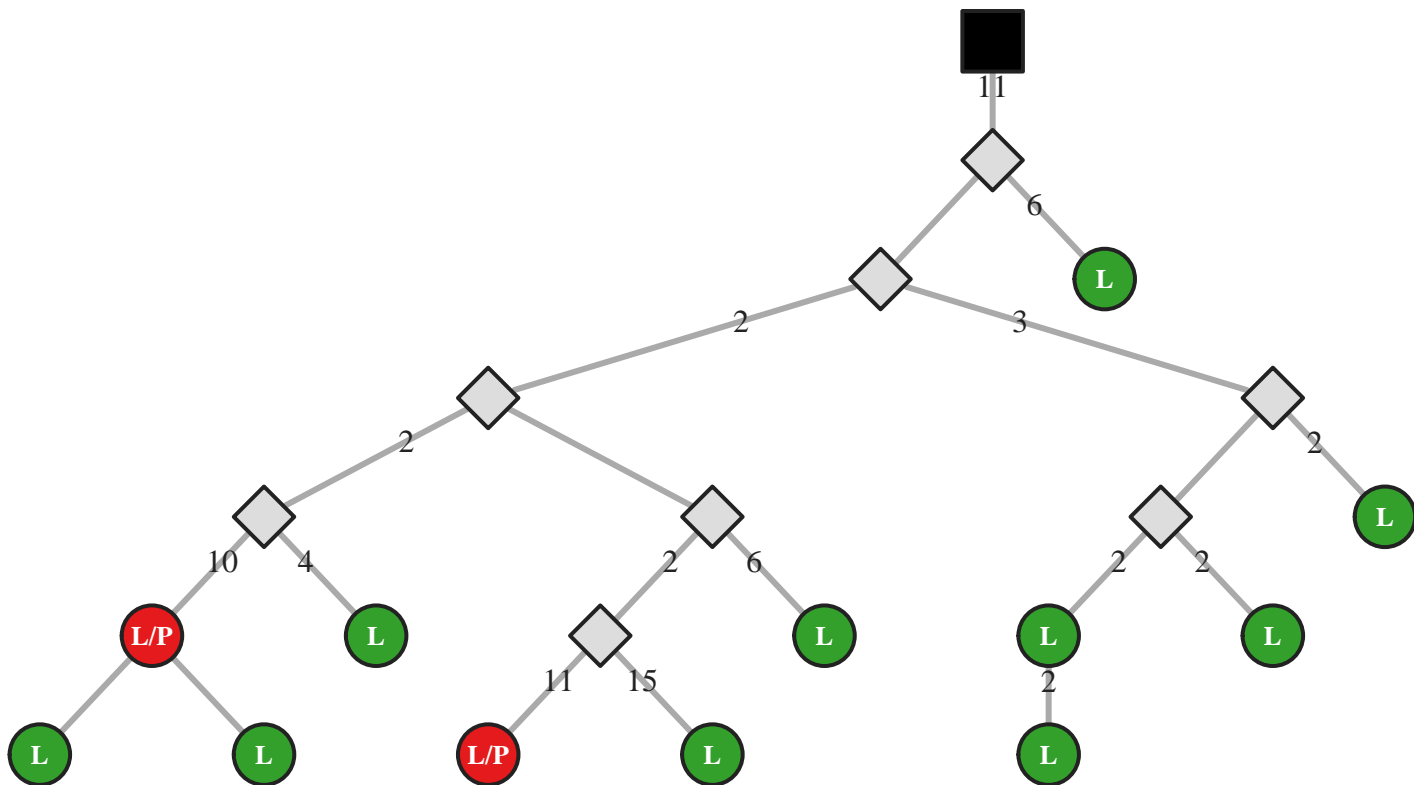

M5 IgG IGHV3-48/J4 54bp (45213)

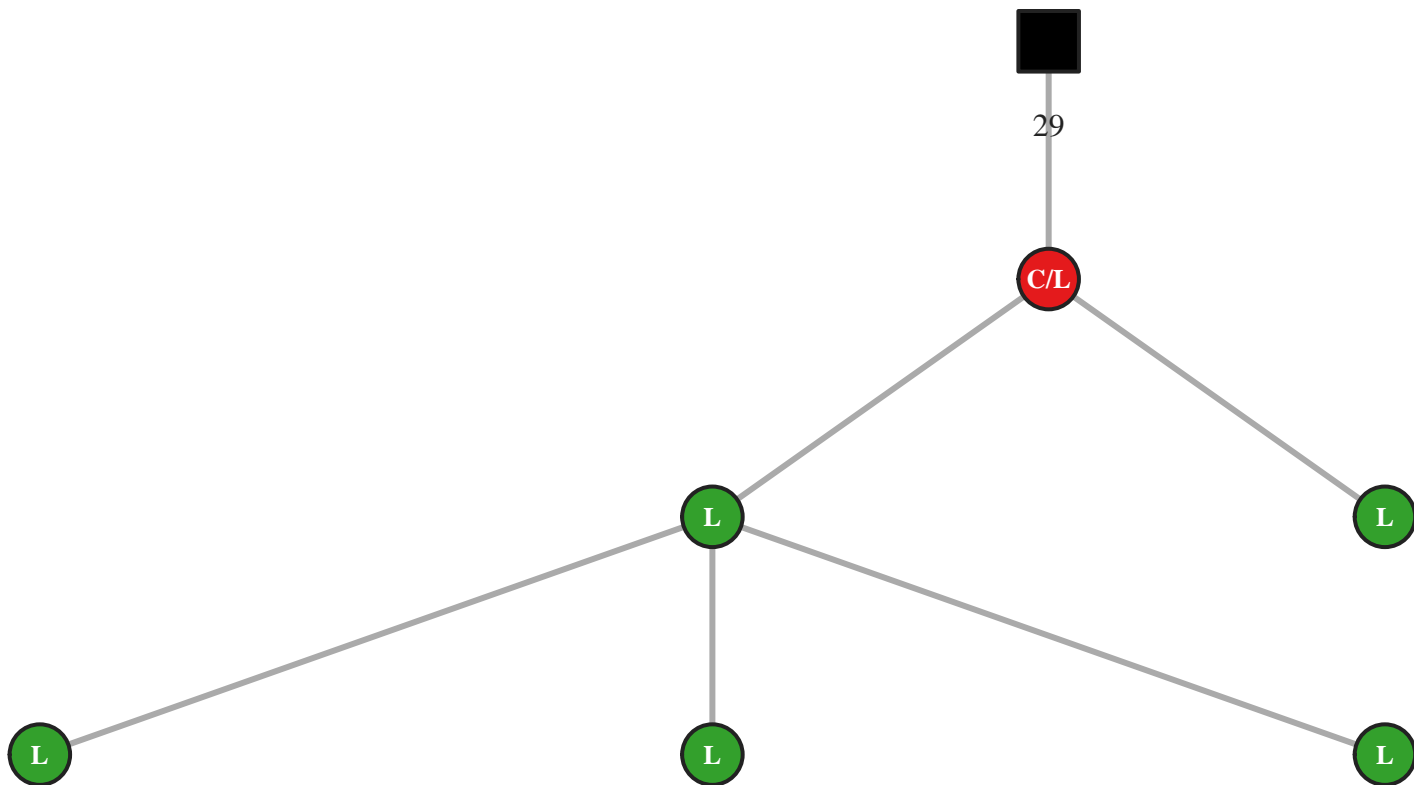

M5 IgG IGHV3-48/J4 63bp (52056)

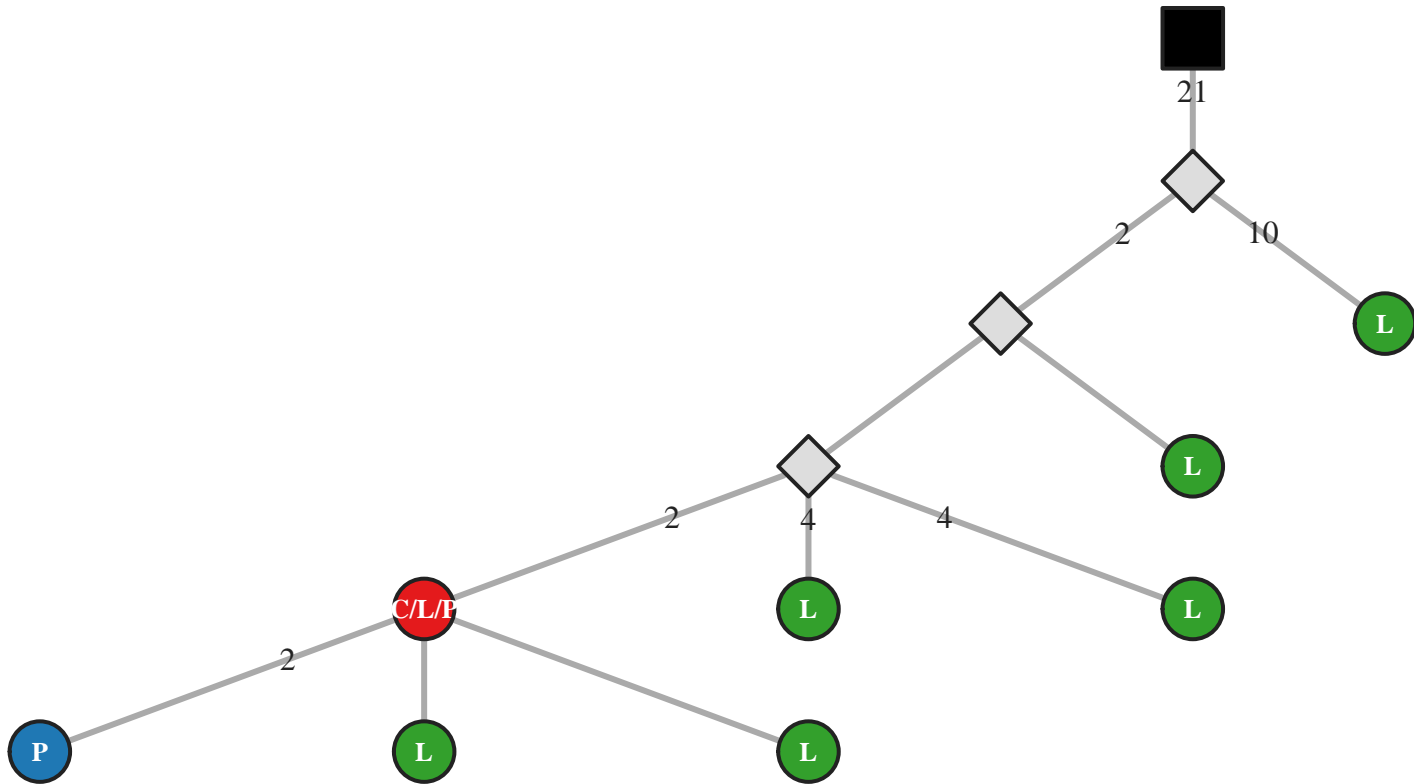

M5 IgG IGHV3-48/J5 36bp (35295)

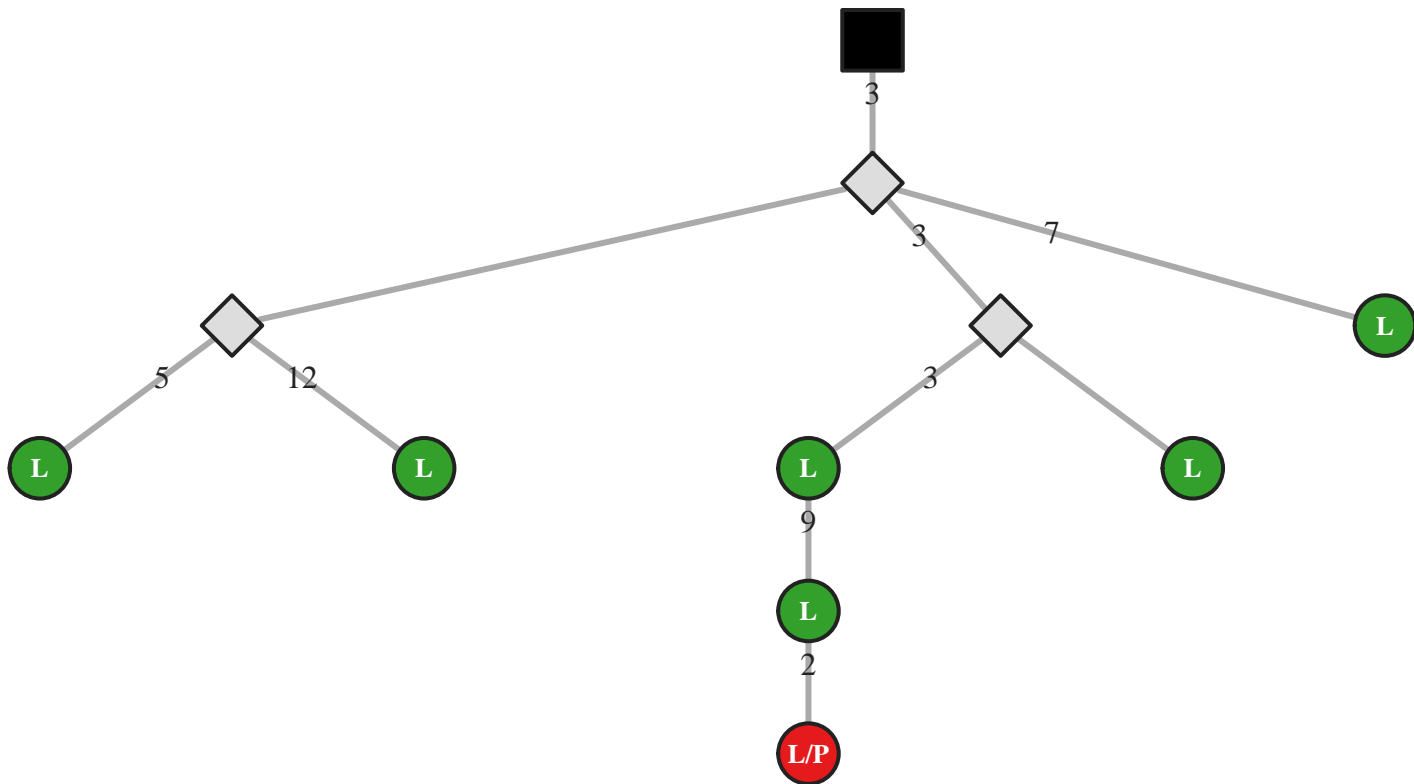

M5 IgG IGHV3-48/J5 39bp (52062)

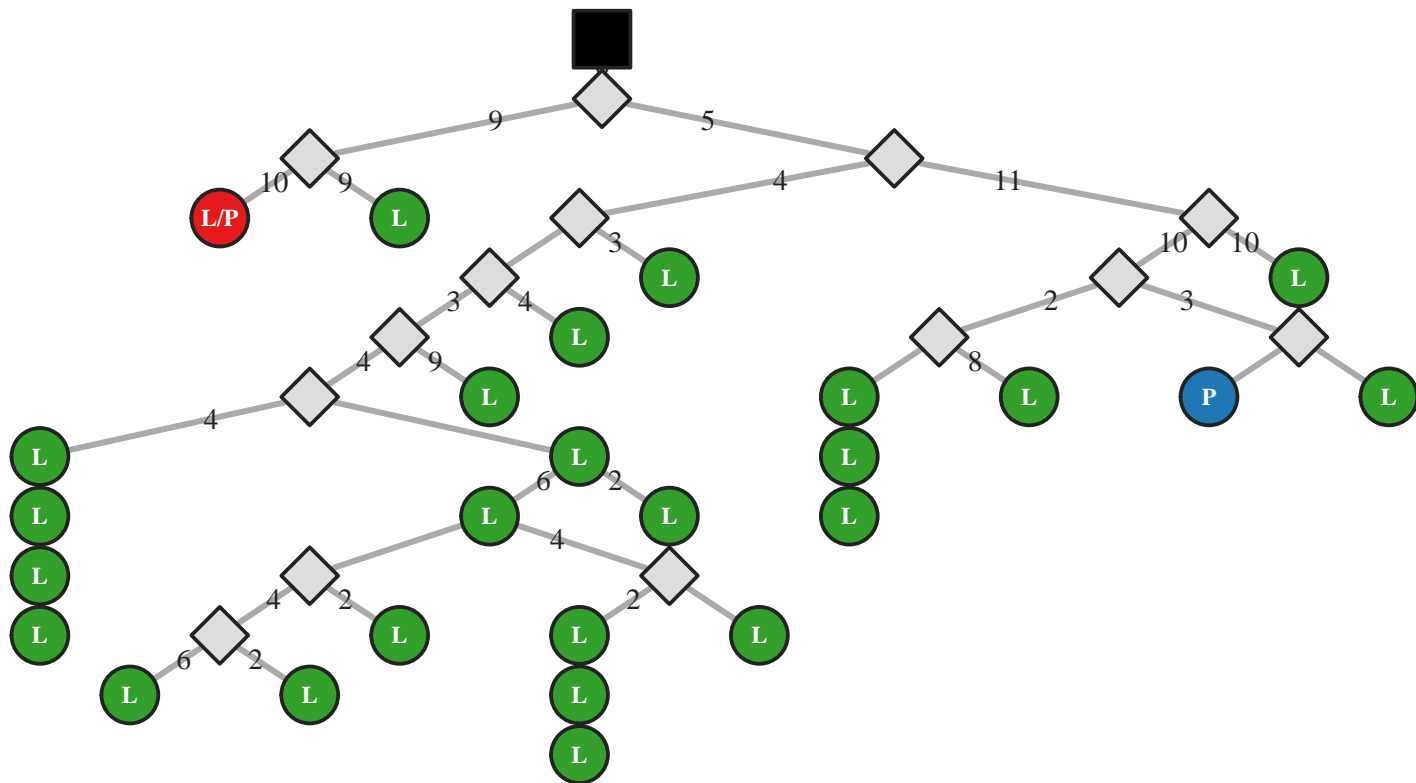

M5 IgG IGHV3-48/J5 39bp (52065)

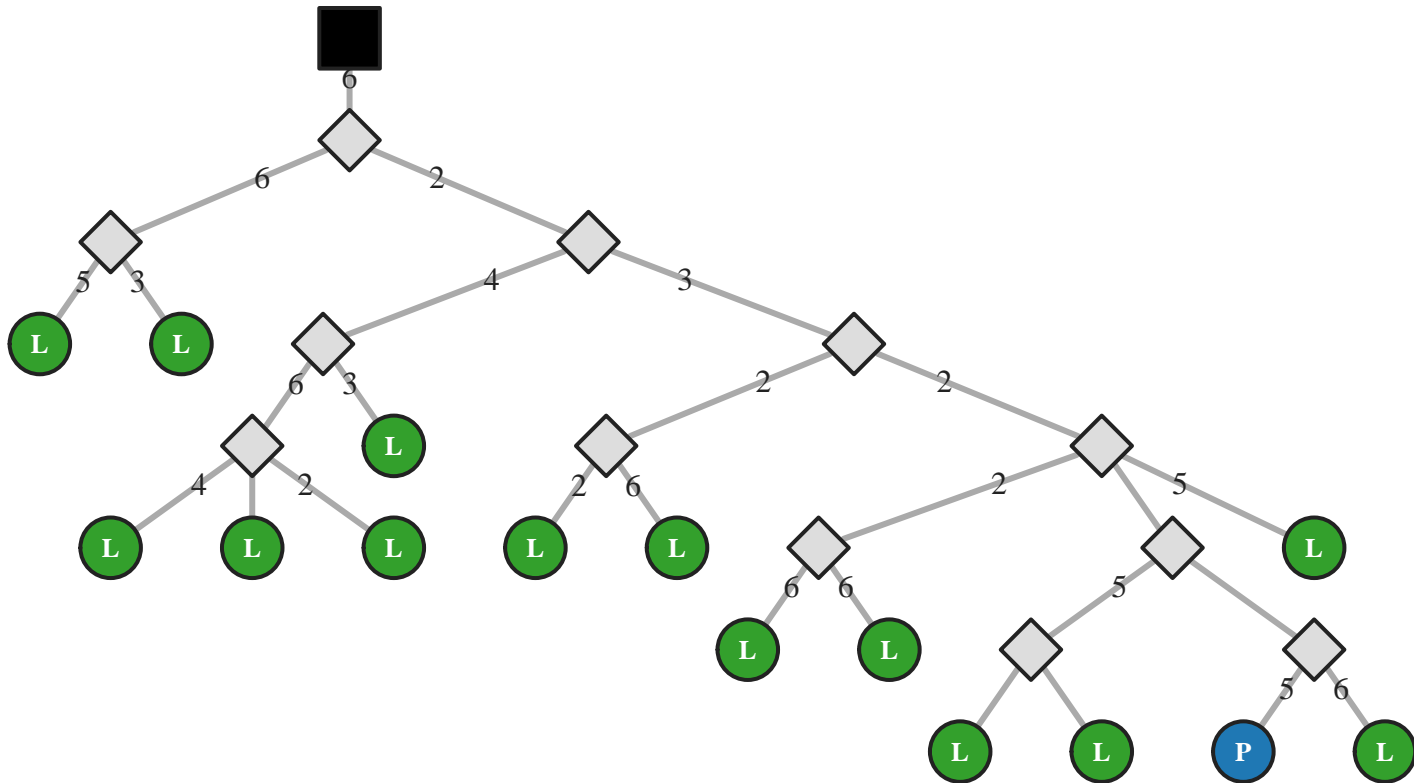

M5 IgG IGHV3-48/J6 45bp (17938)

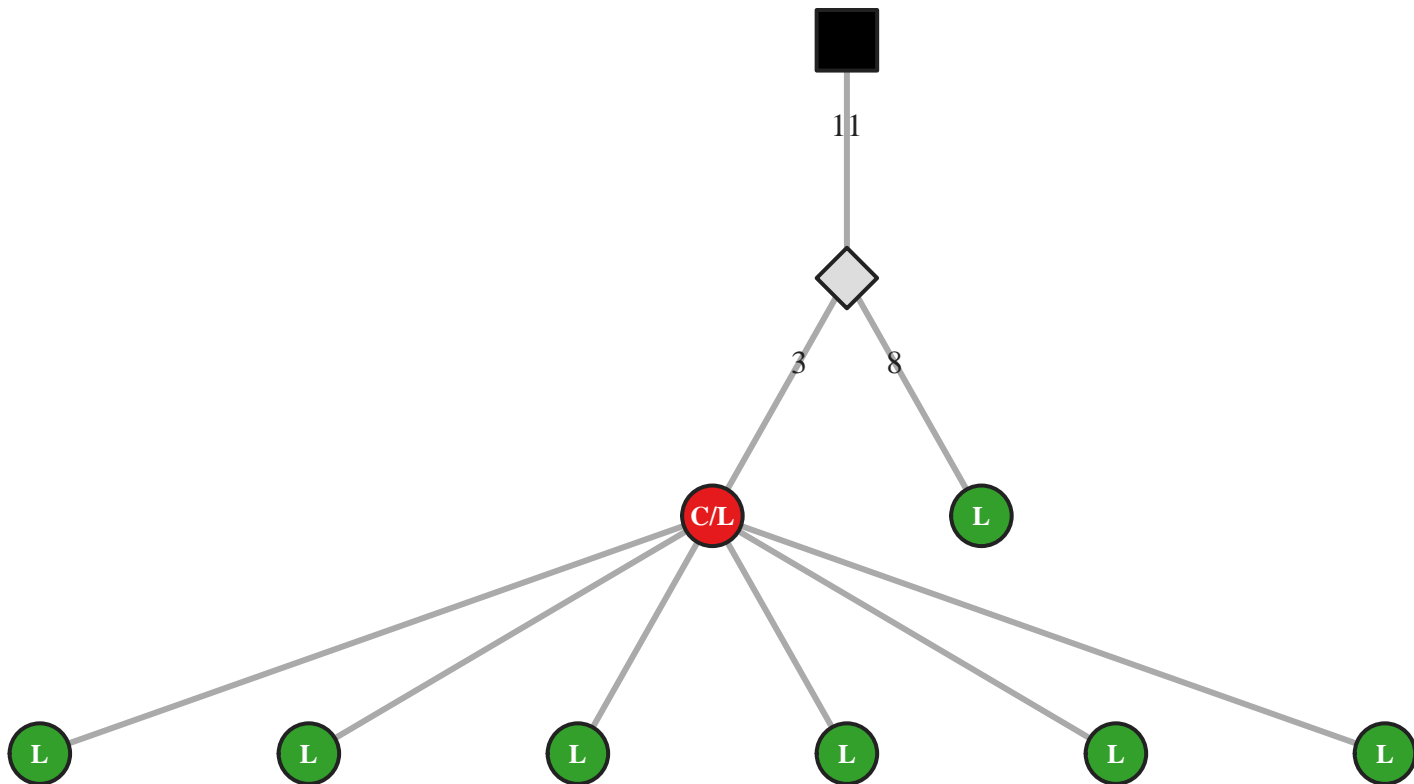

M5 IgG IGHV3-48/J6 51bp (17944)

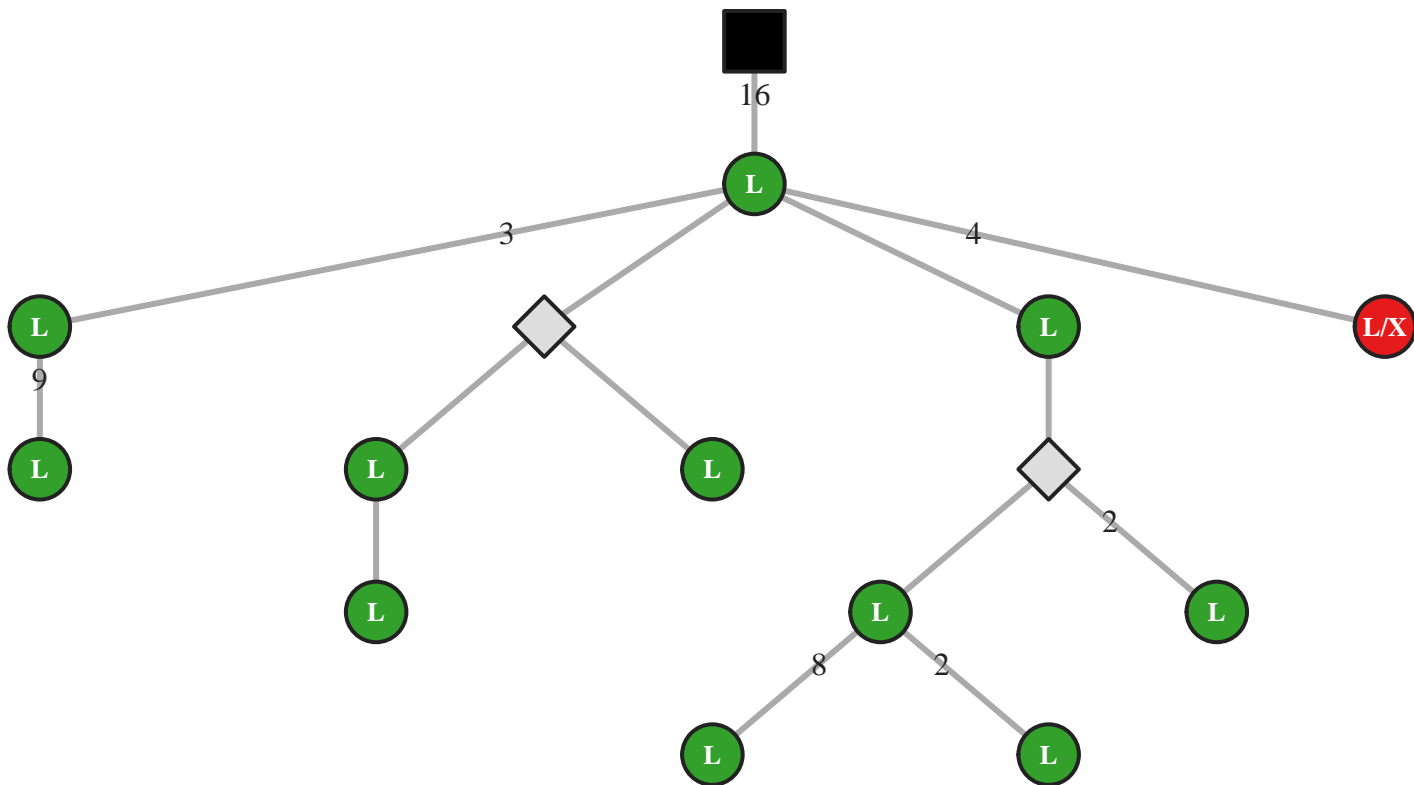

M5 IgG IGHV3-48/J6 51bp (17946)

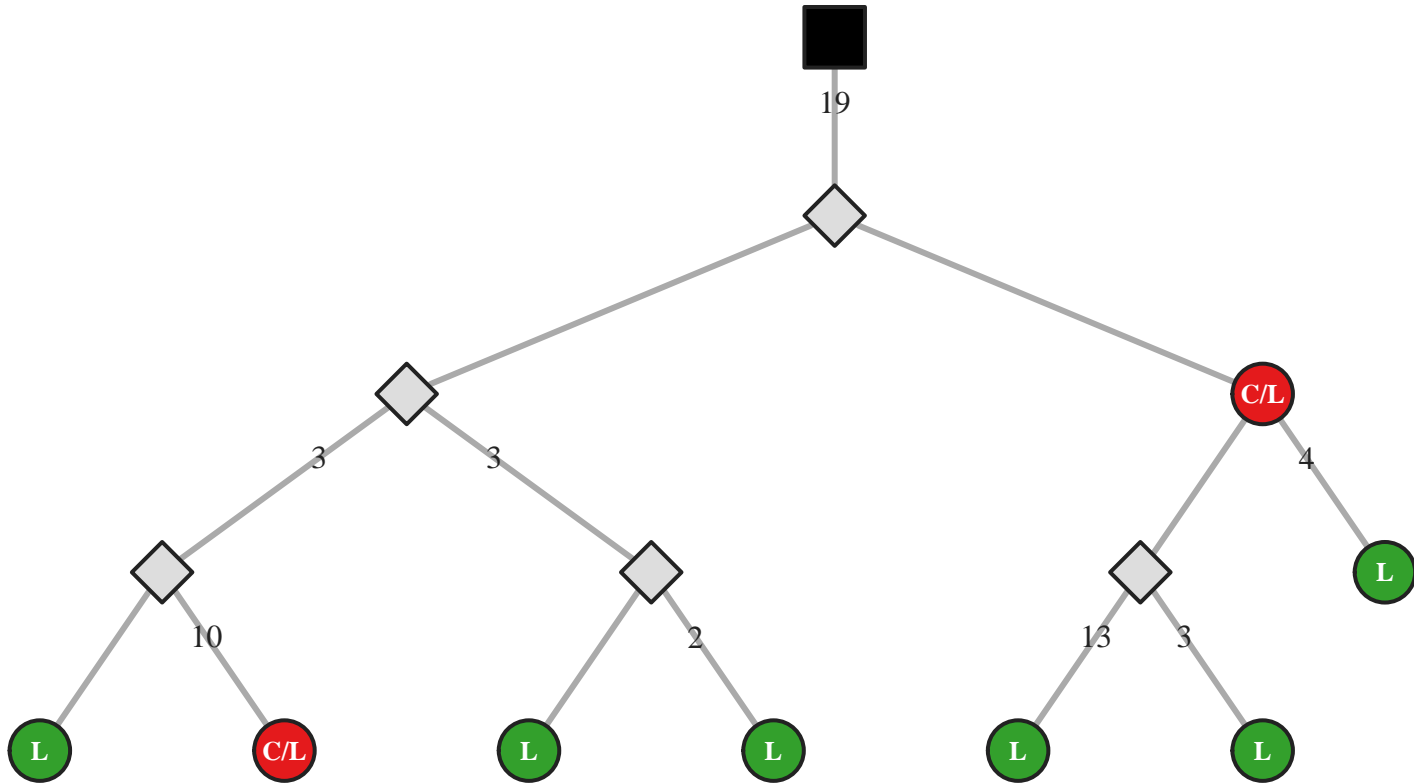

M5 IgG IGHV3-48/J6 54bp (45232)

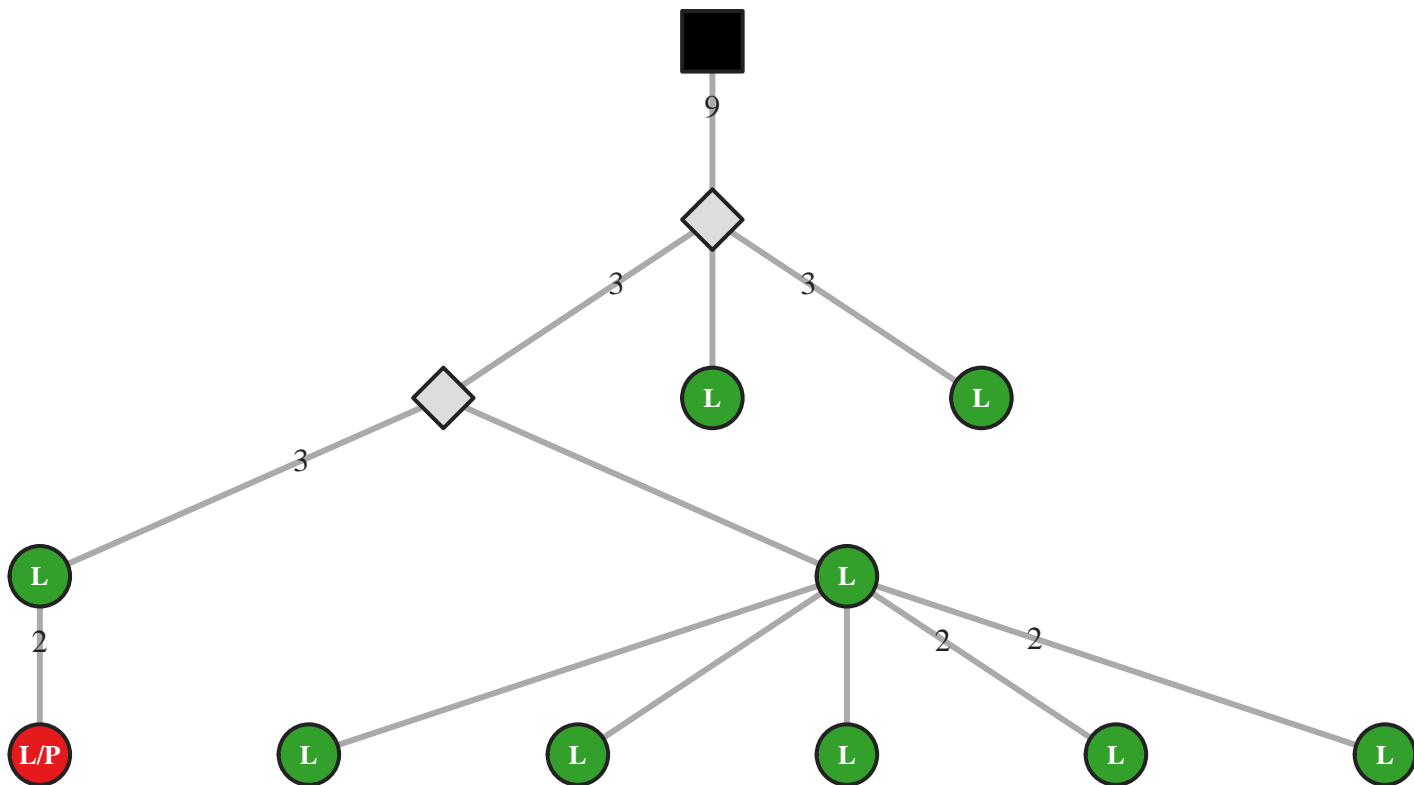

M5 IgG IGHV3-49/J1 27bp (17964)

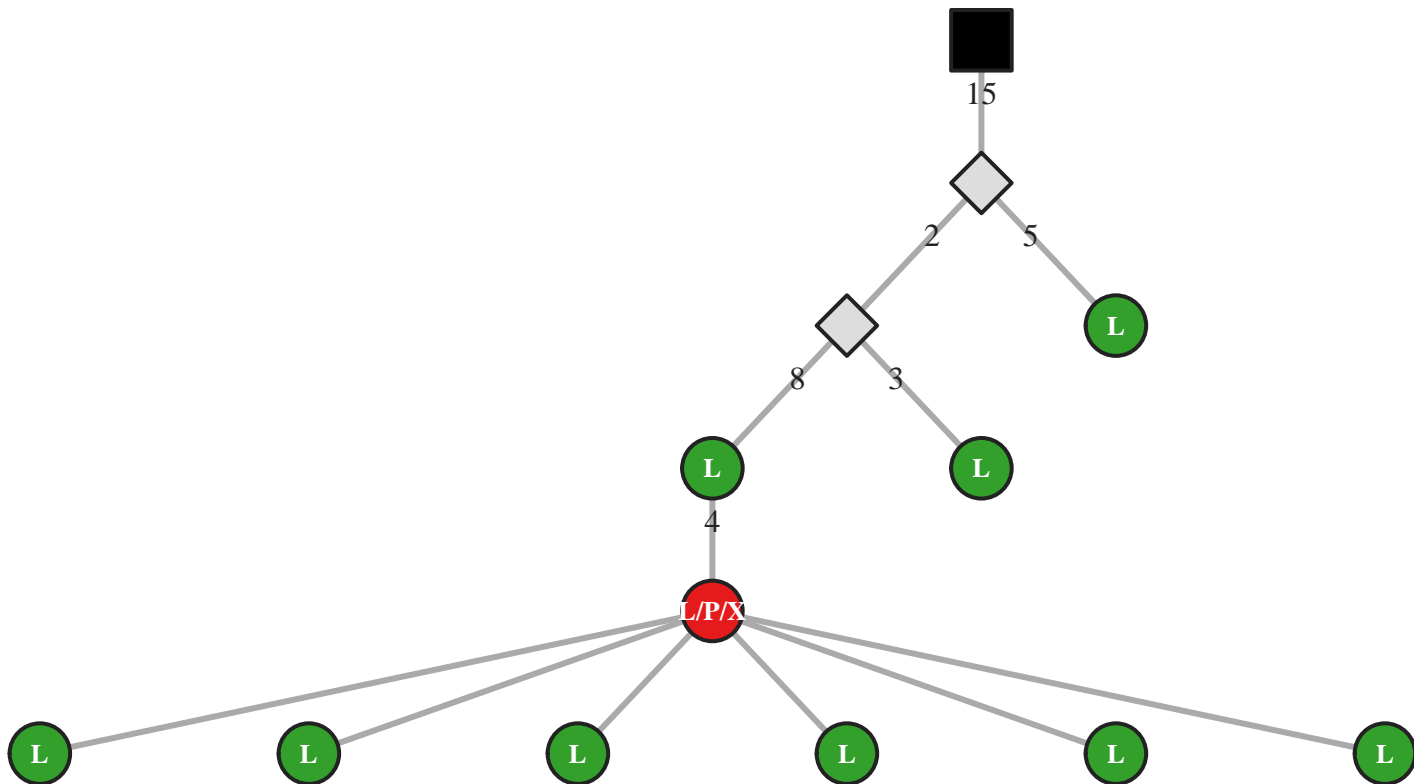

M5 IgG IGHV3-49/J3 63bp (8343)

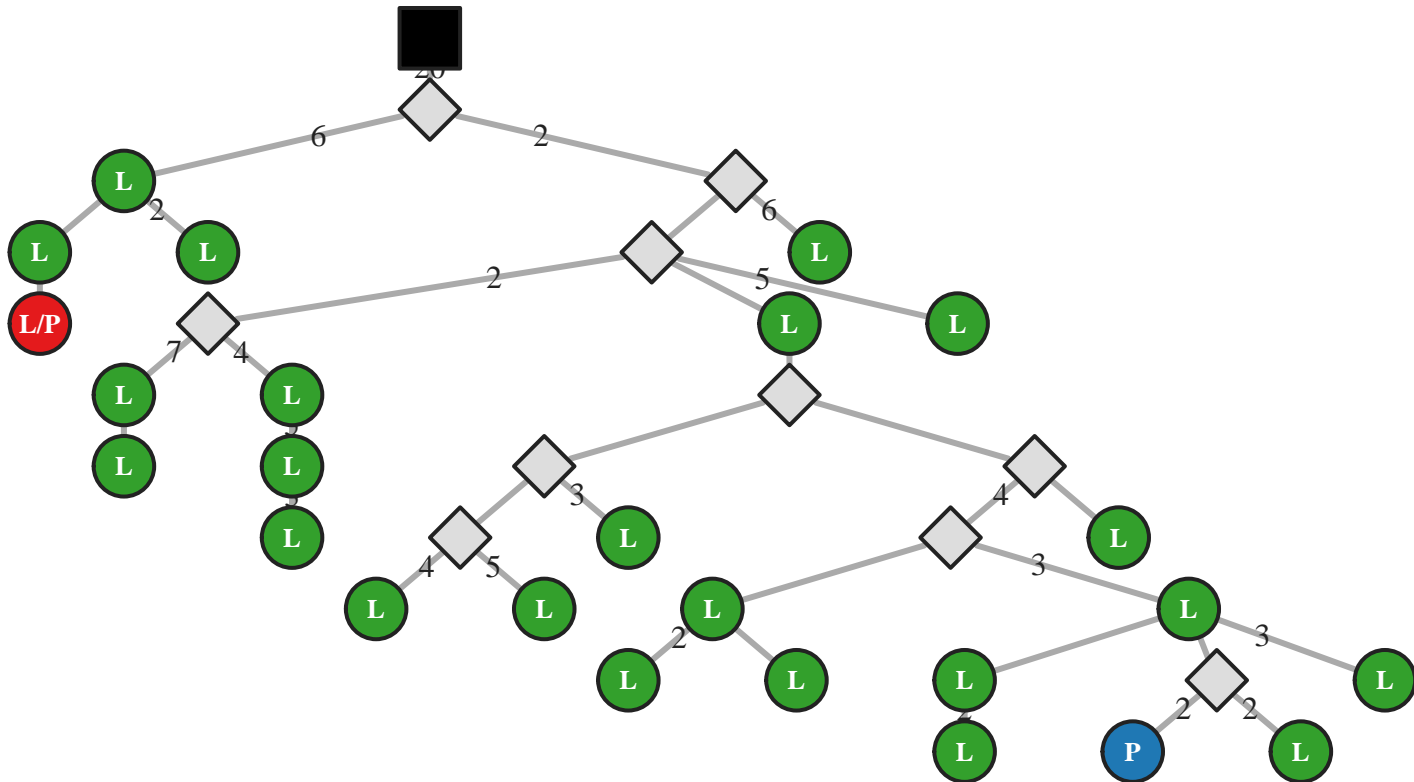

M5 IgG IGHV3-49/J3 63bp (8344)

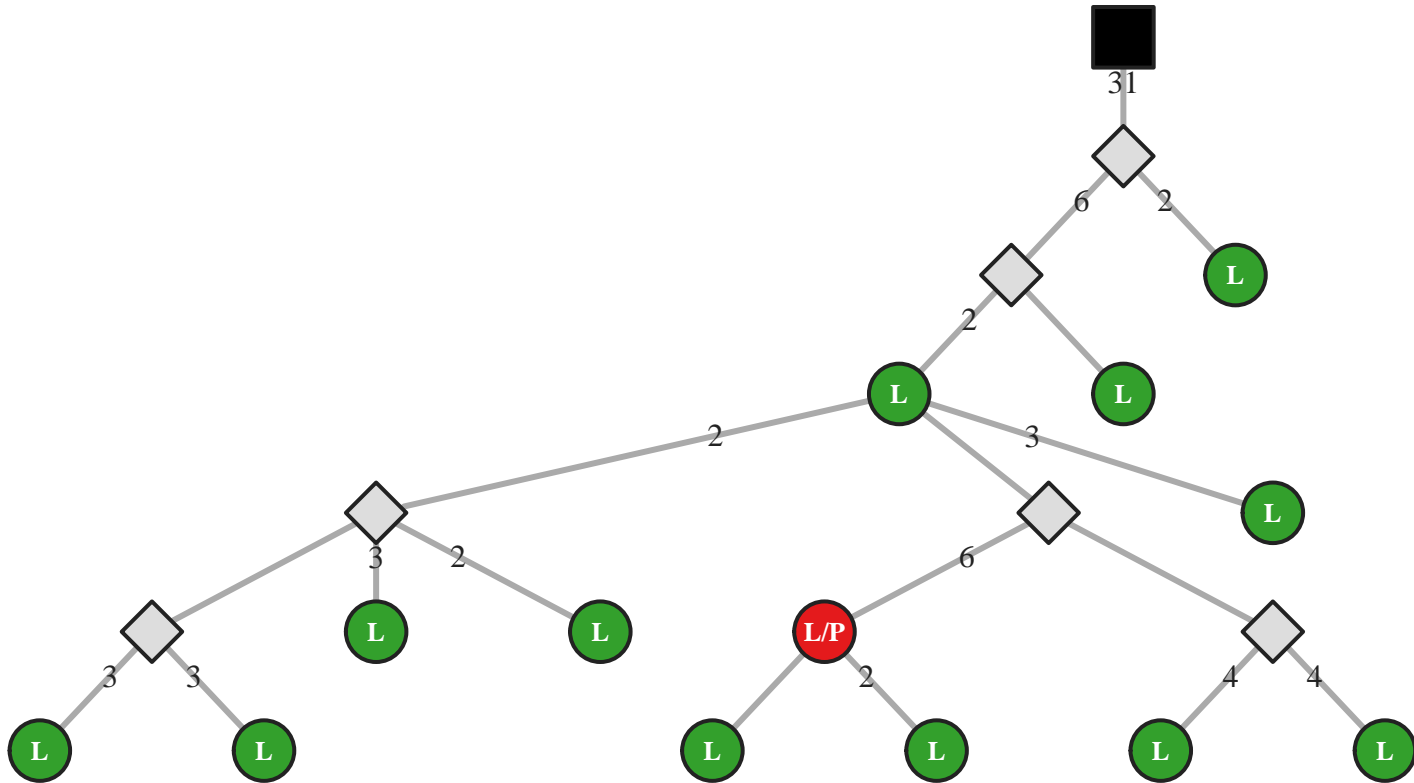

M5 IgG IGHV3-49/J3 81bp (8352)

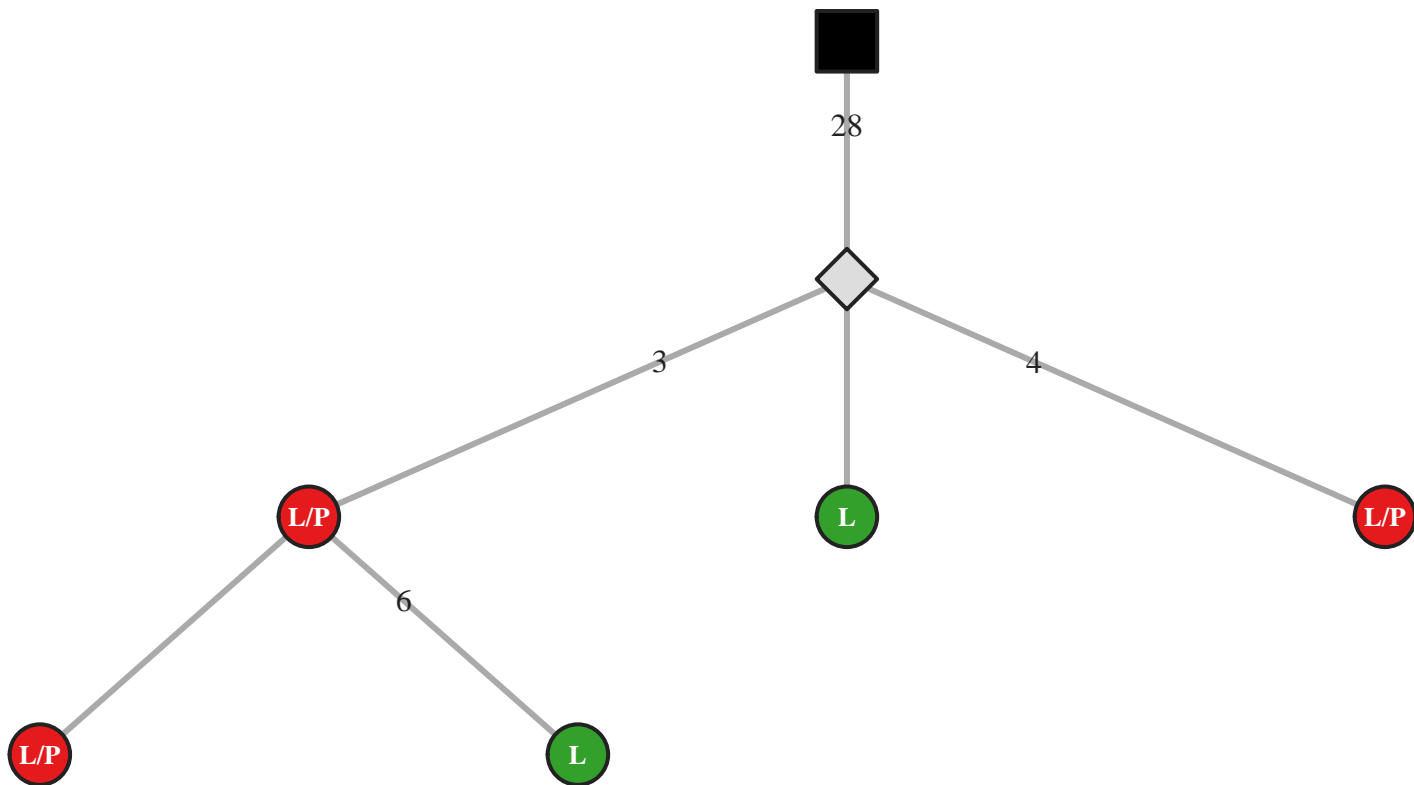

M5 IgG IGHV3-49/J4 24bp (45255)

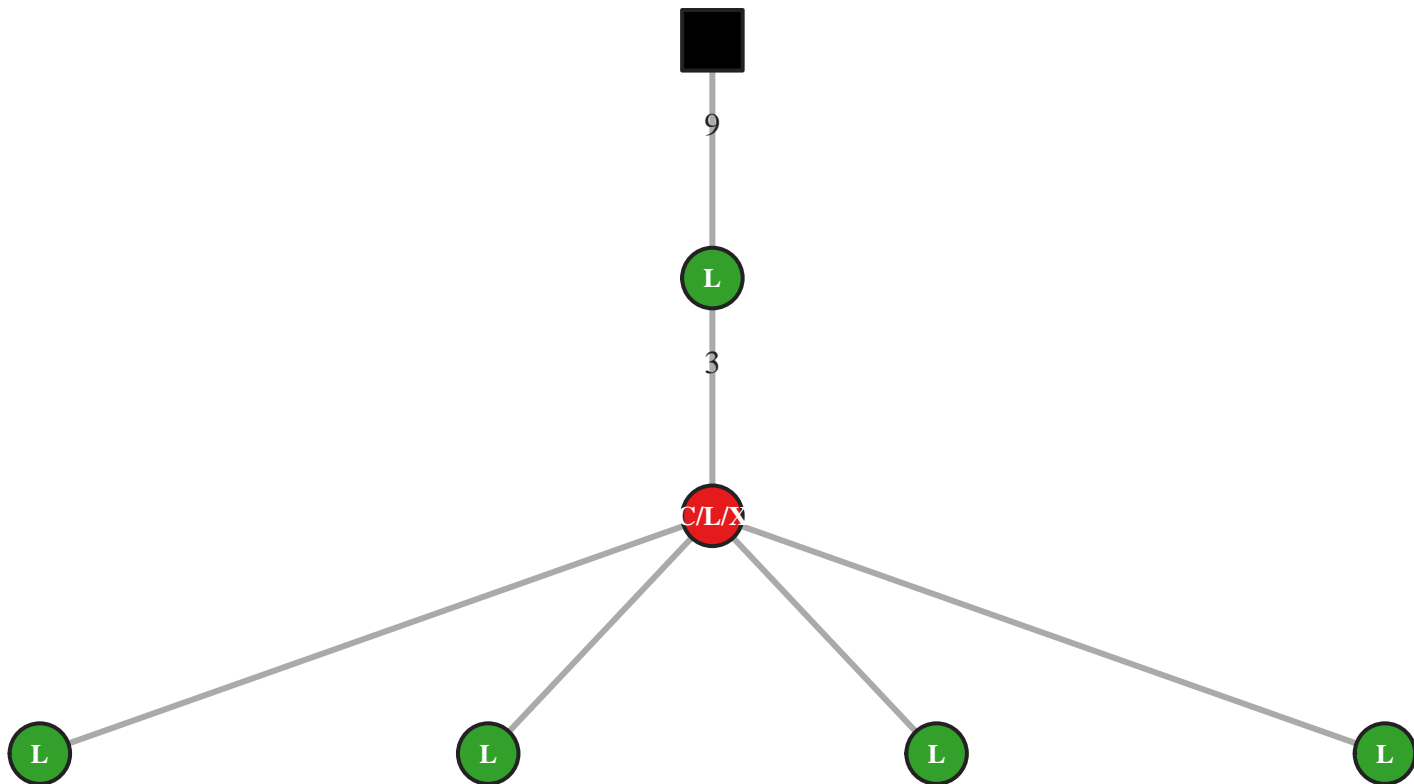

M5 IgG IGHV3-49/J4 30bp (17972)

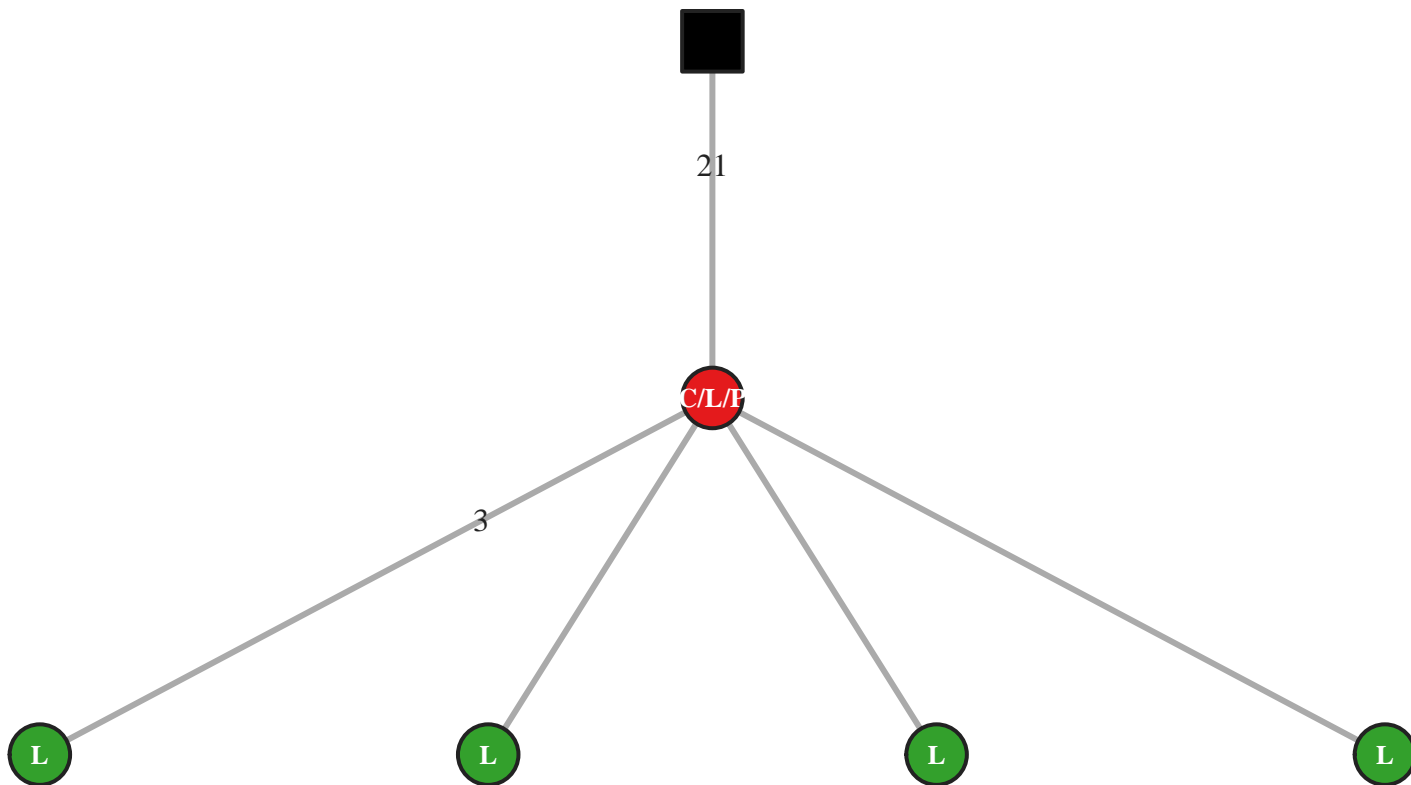

M5 IgG IGHV3-49/J4 33bp (8356)

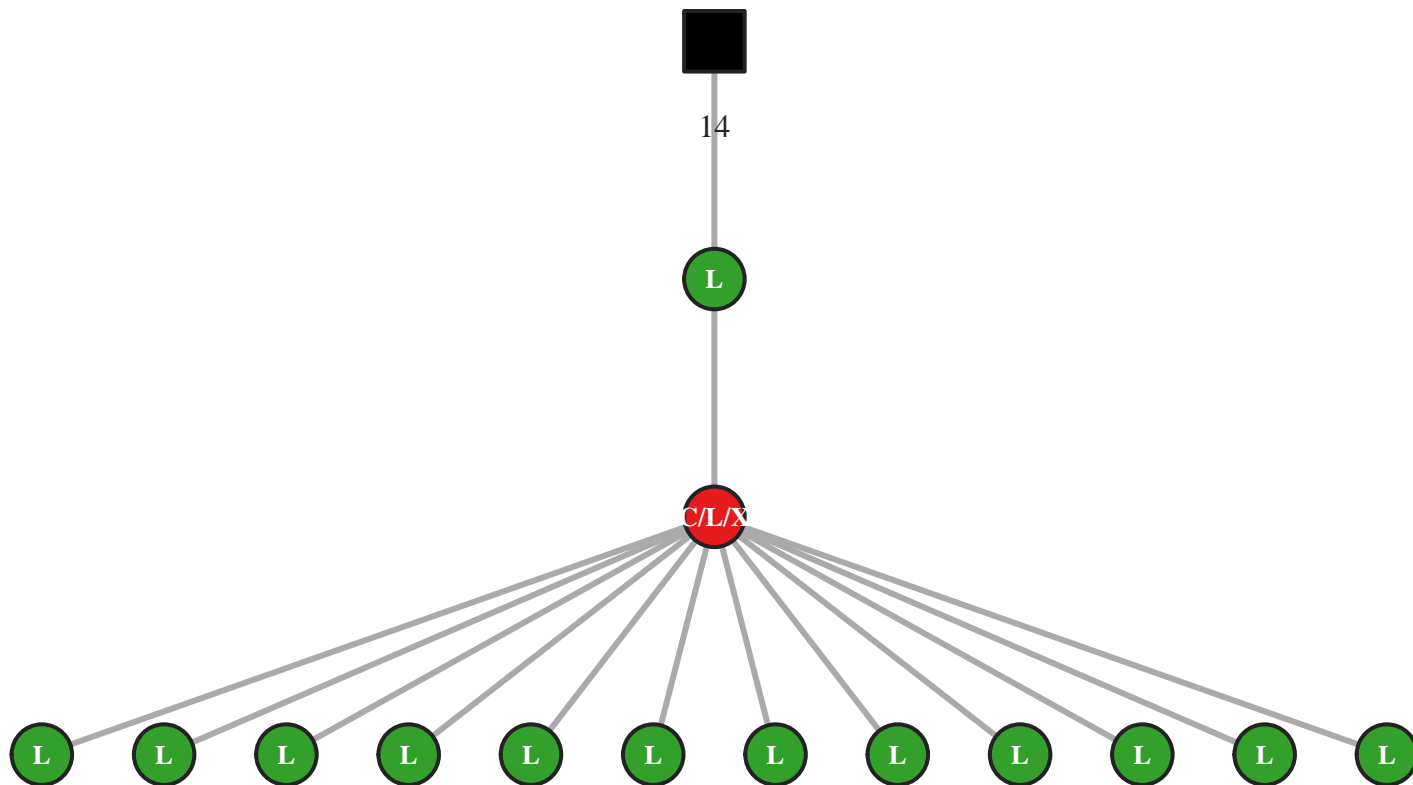

M5 IgG IGHV3-49/J4 45bp (26875)

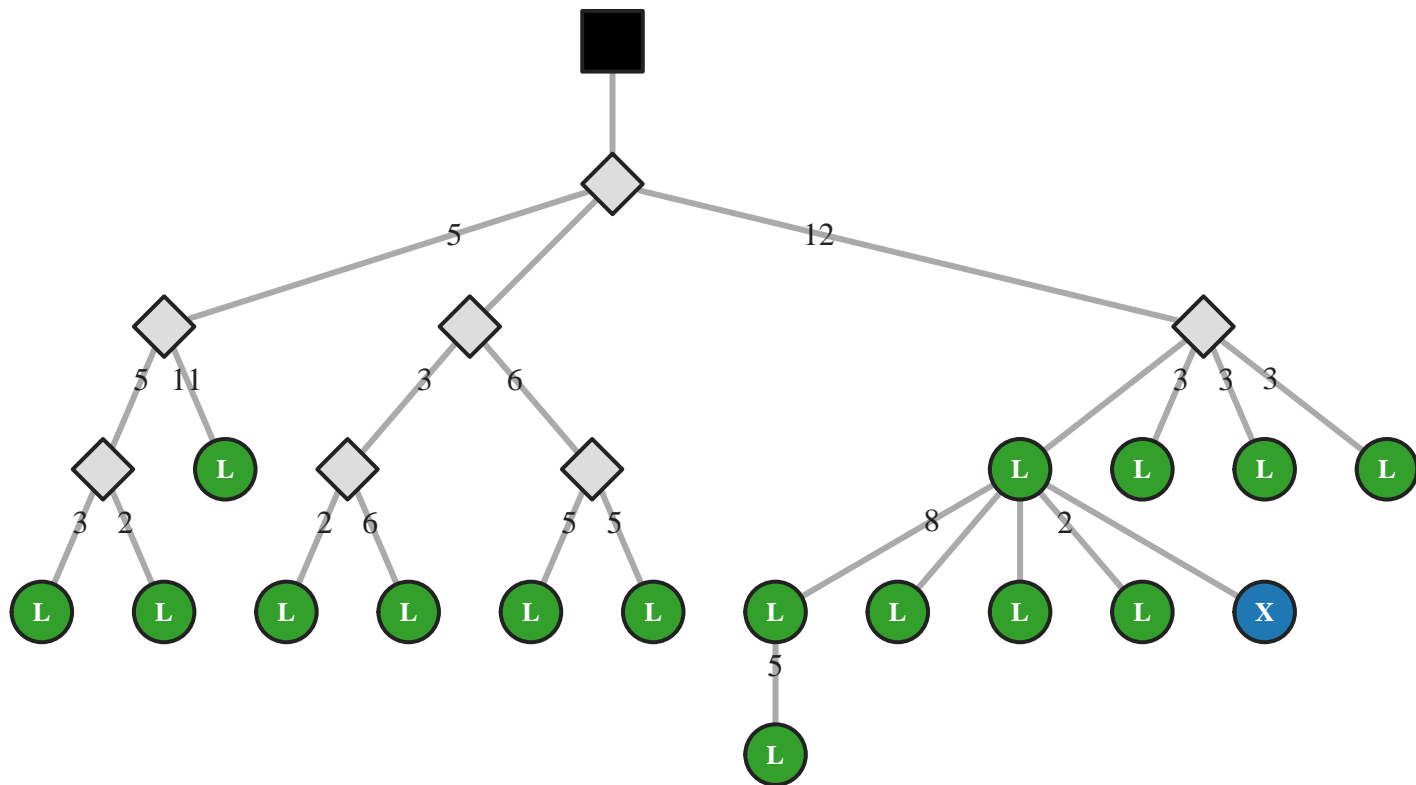

M5 IgG IGHV3-49/J4 54bp (45270)

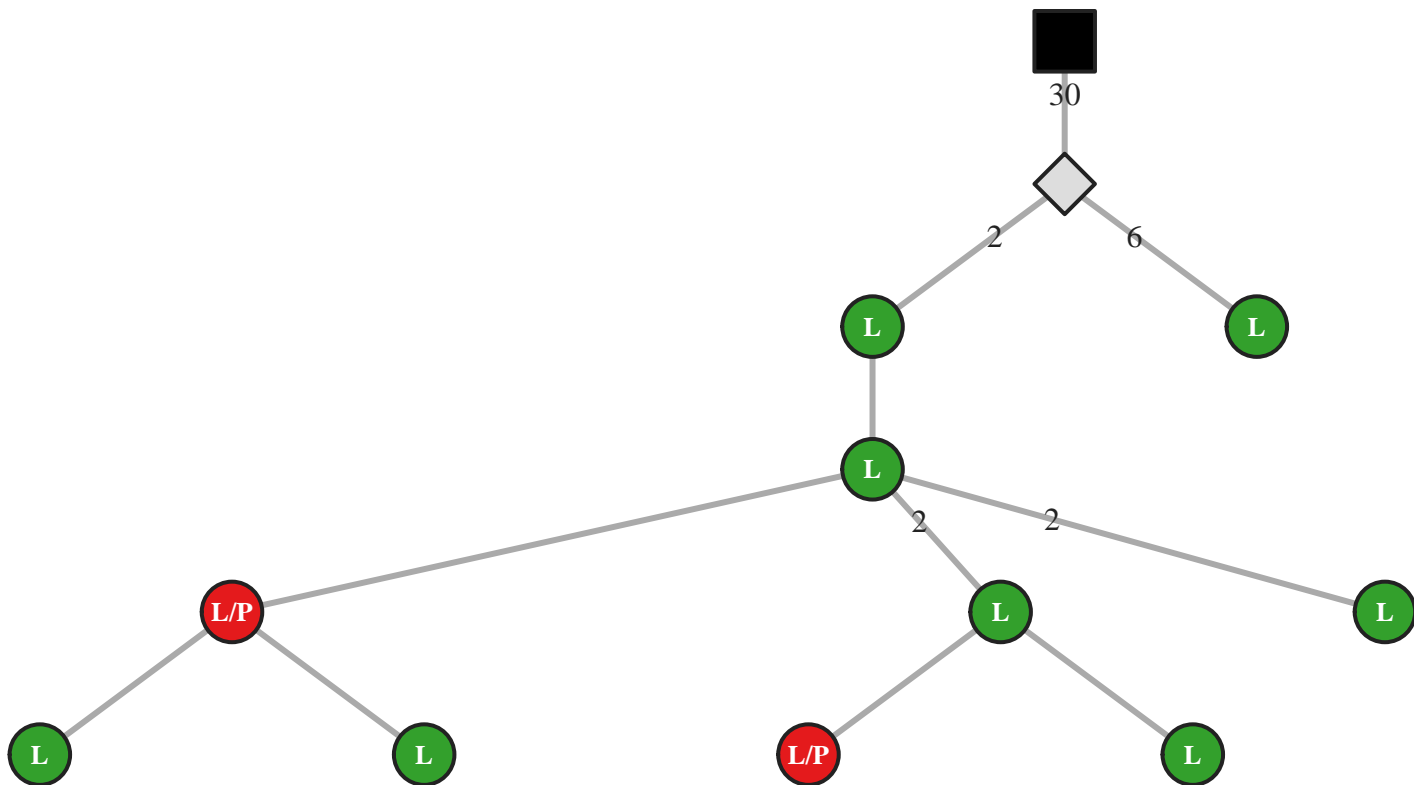

M5 IgG IGHV3-49/J5 39bp (52091)

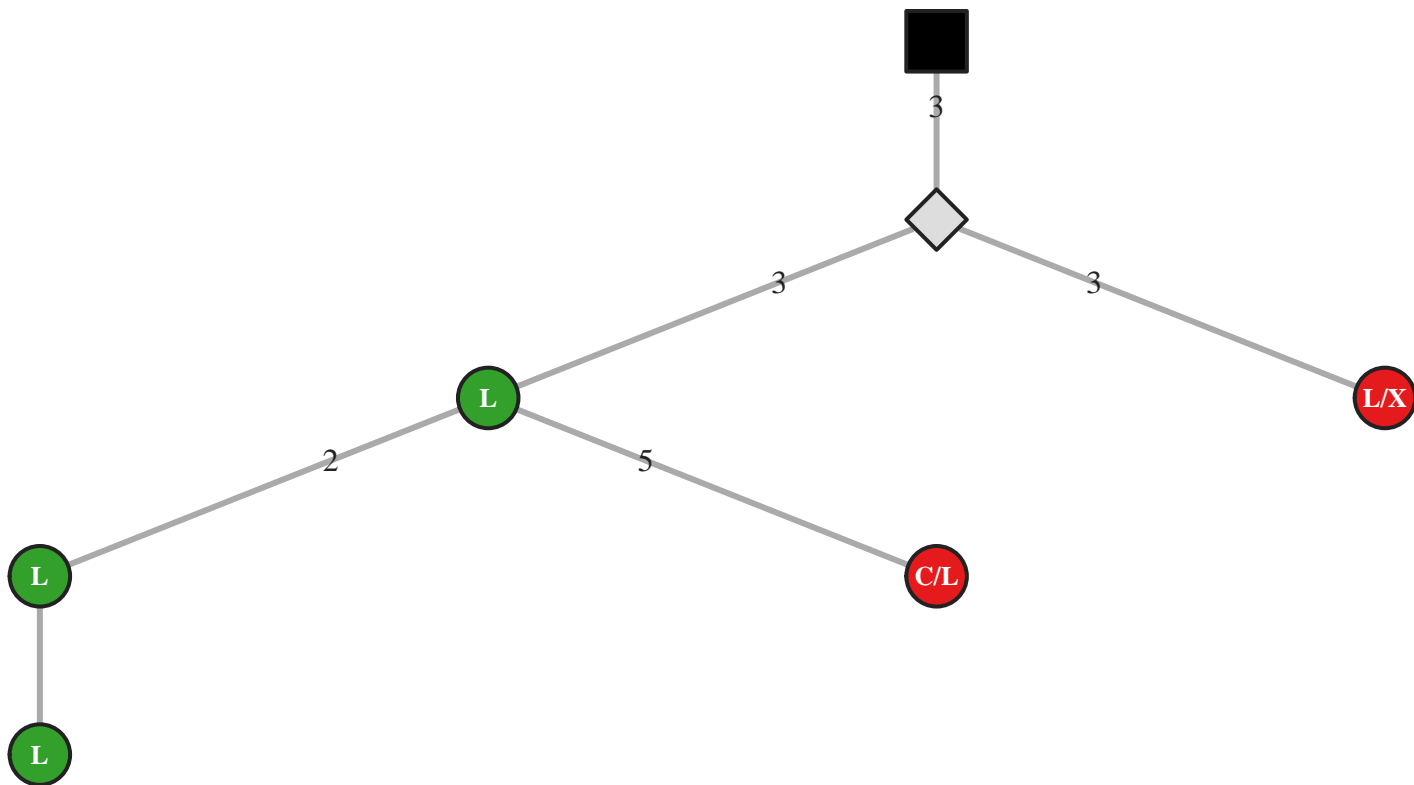

M5 IgG IGHV3-49/J5 63bp (17989)

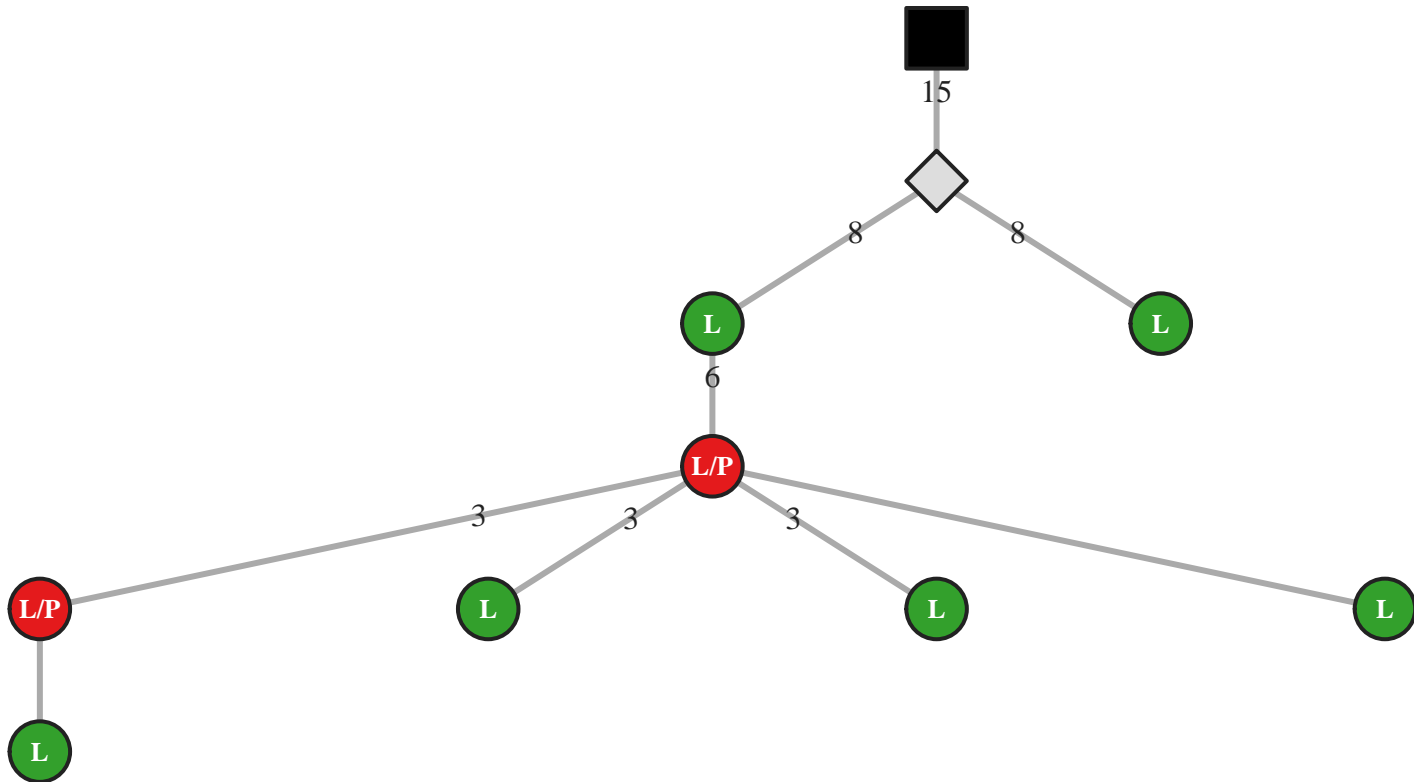

M5 IgG IGHV3-49/J6 48bp (8374)

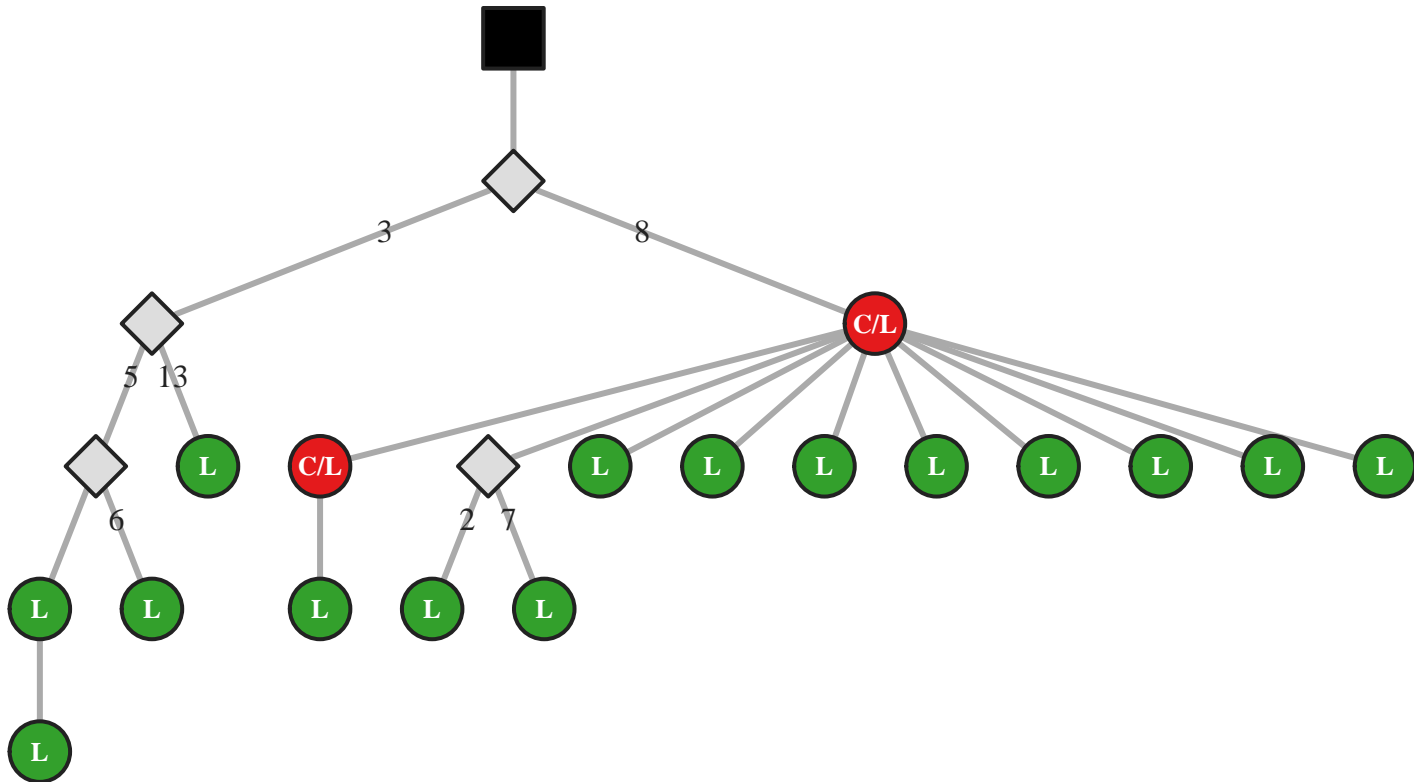

M5 IgG IGHV3-53/J3 63bp (8398)

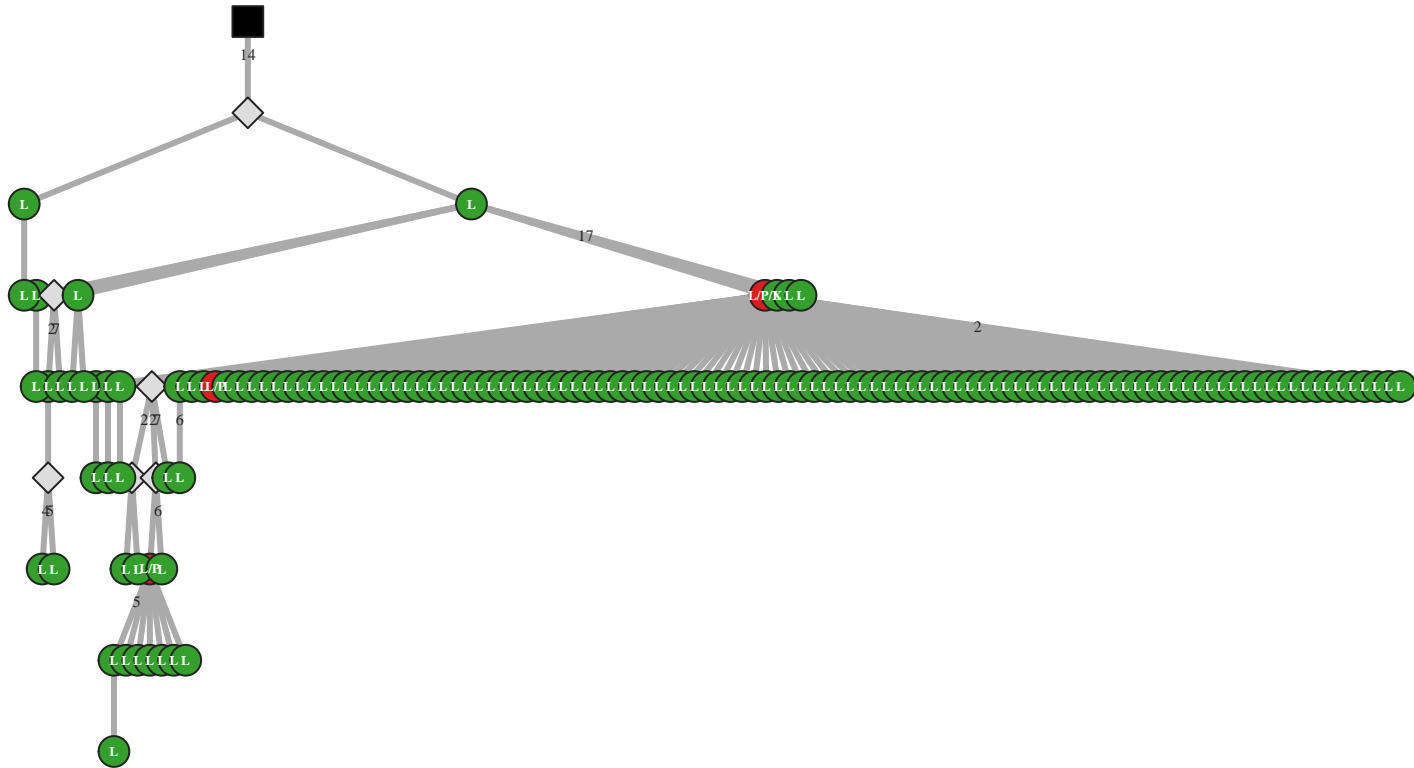

M5 IgG IGHV3-53/J3 63bp (8399)

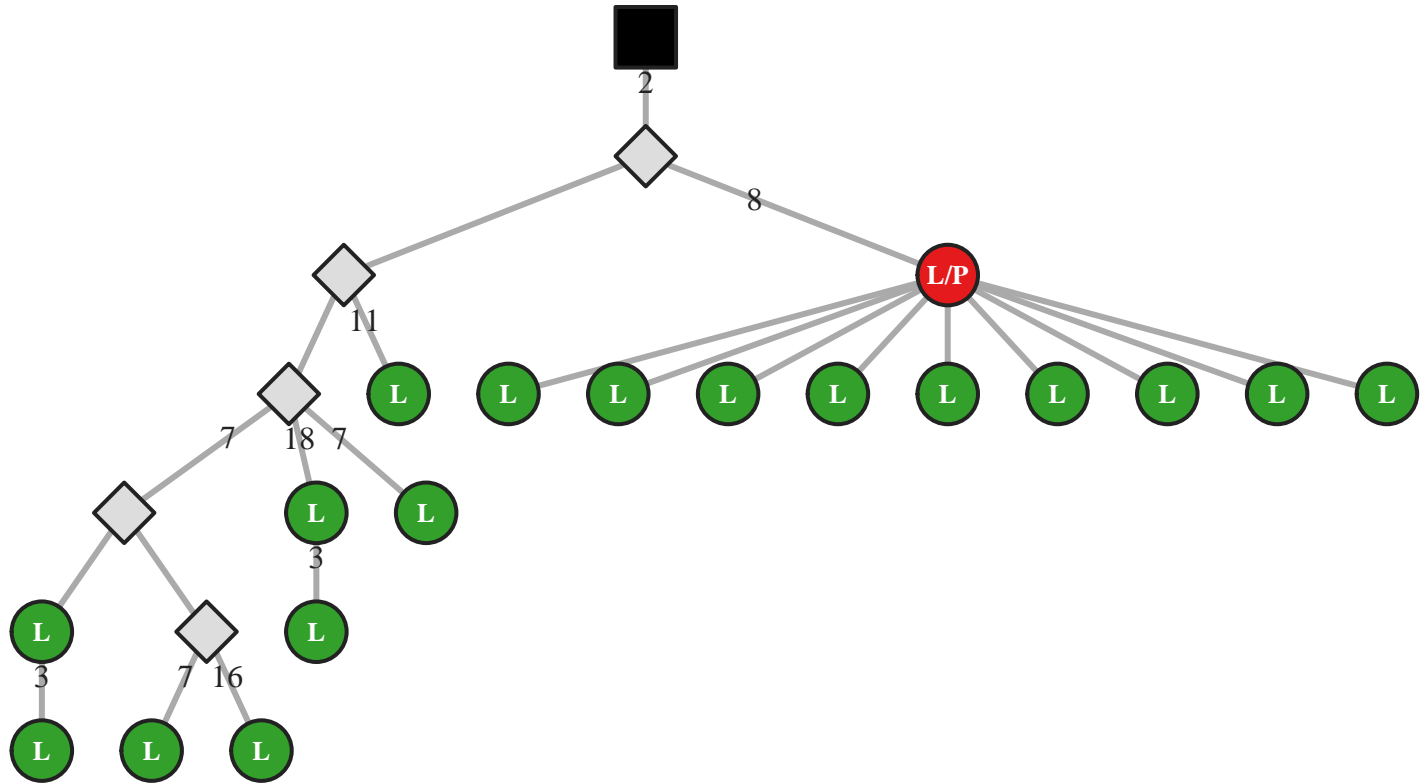

M5 IgG IGHV3-53/J3 63bp (8400)

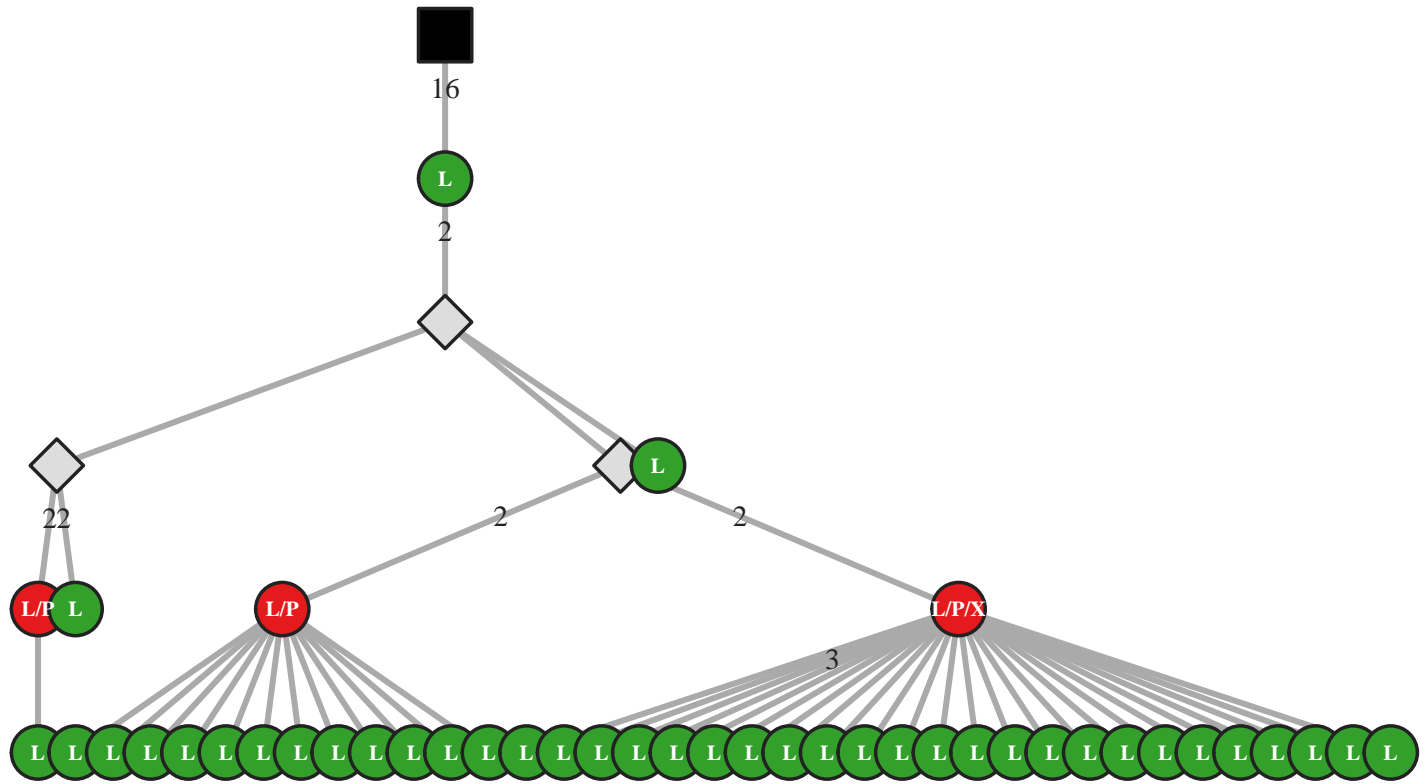

M5 IgG IGHV3-53/J4 27bp (35393)

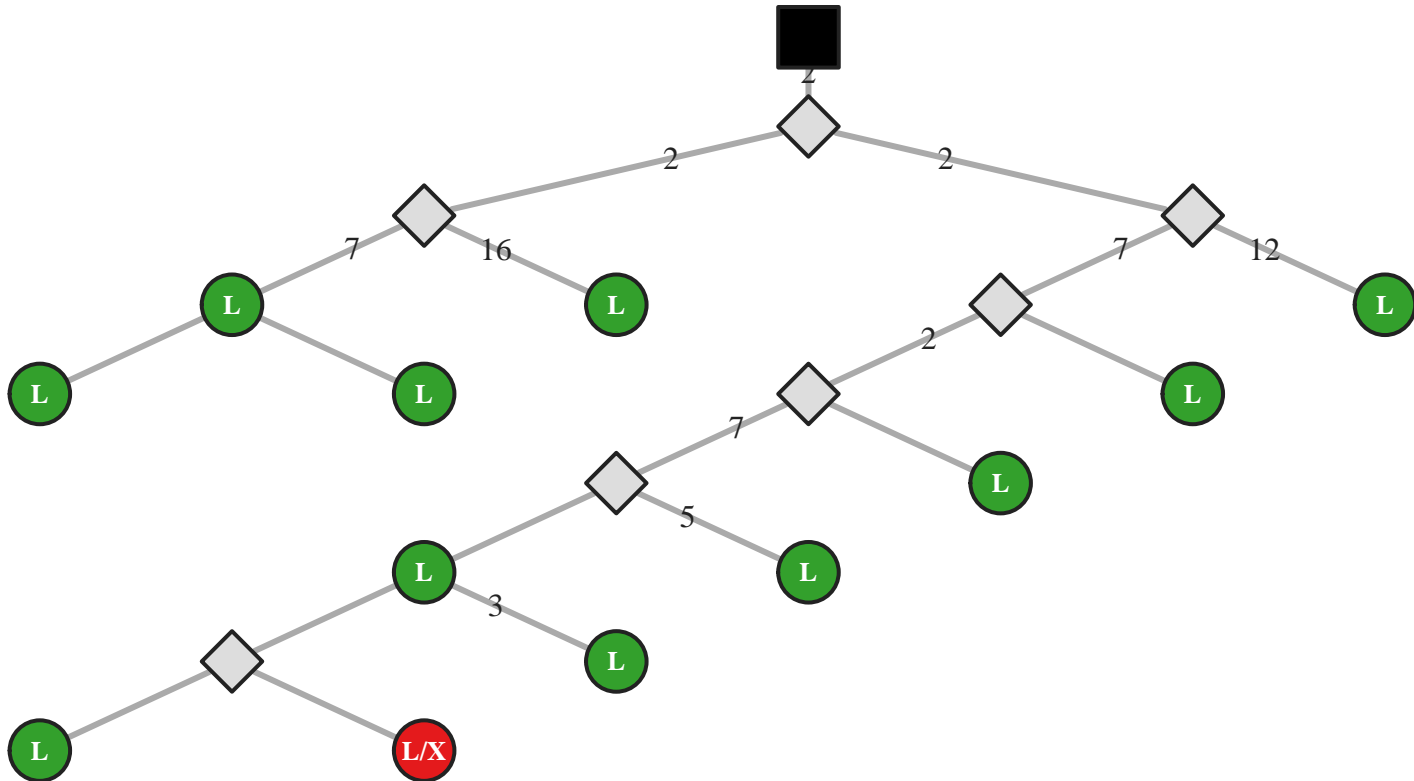

M5 IgG IGHV3-53/J4 42bp (26929)

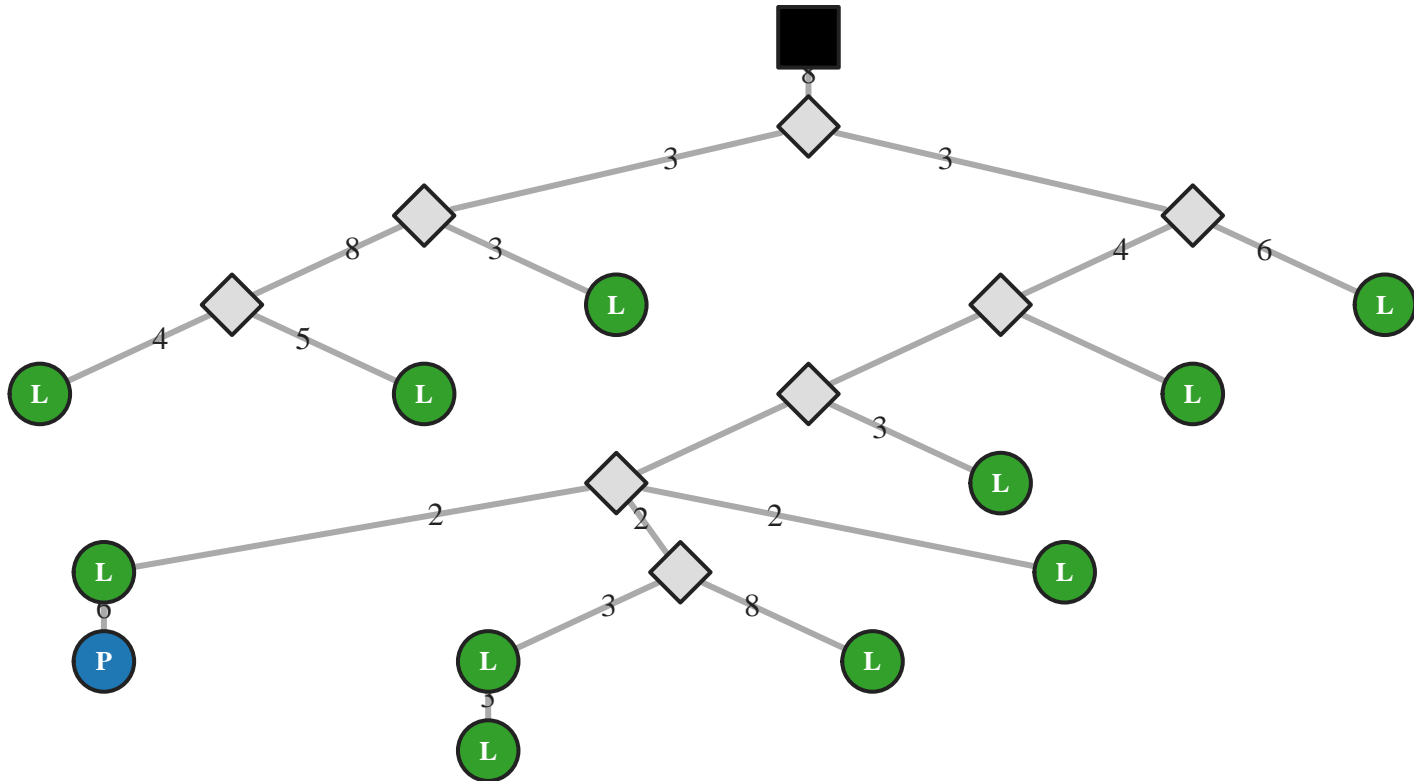

M5 IgG IGHV3-53/J4 42bp (26963)

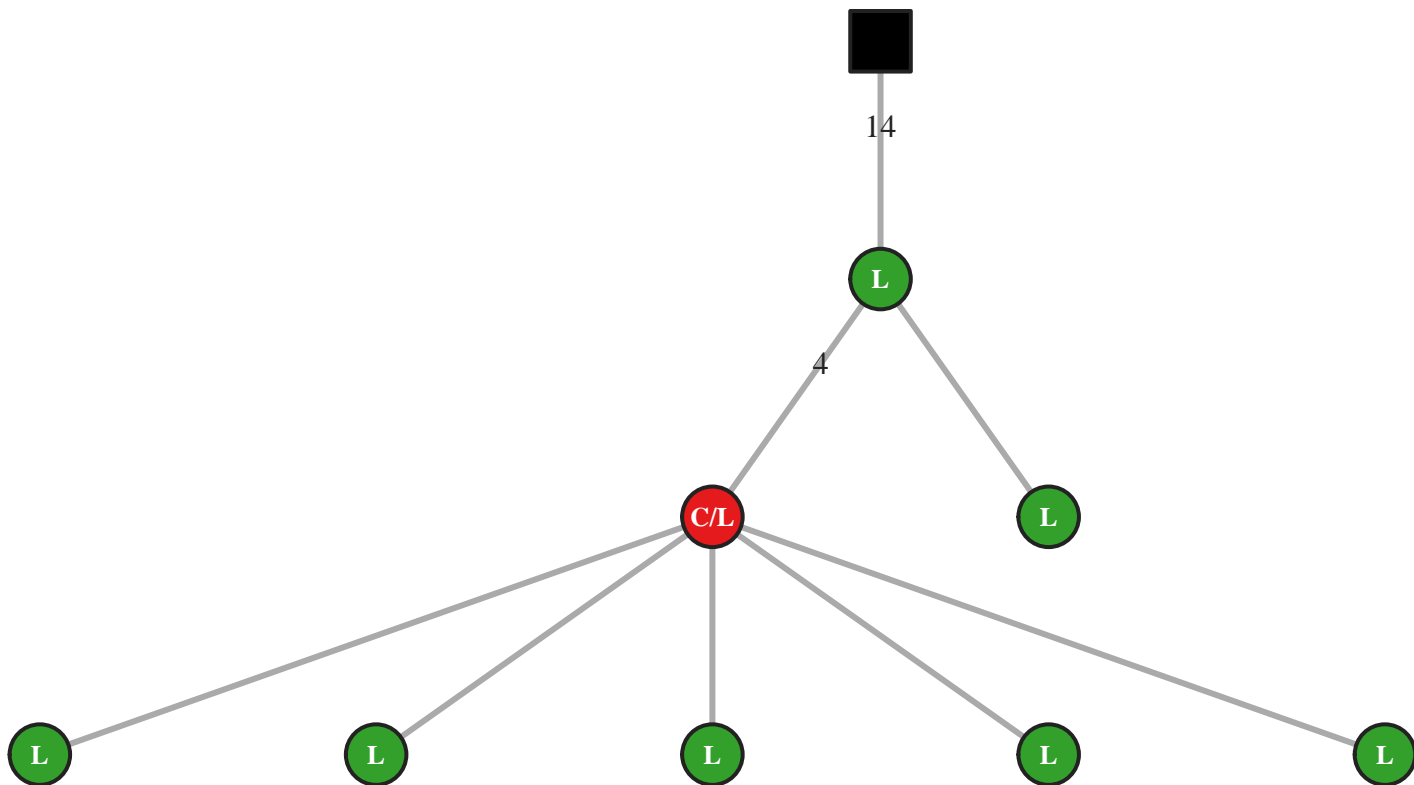

M5 IgG IGHV3-53/J4 42bp (26964)

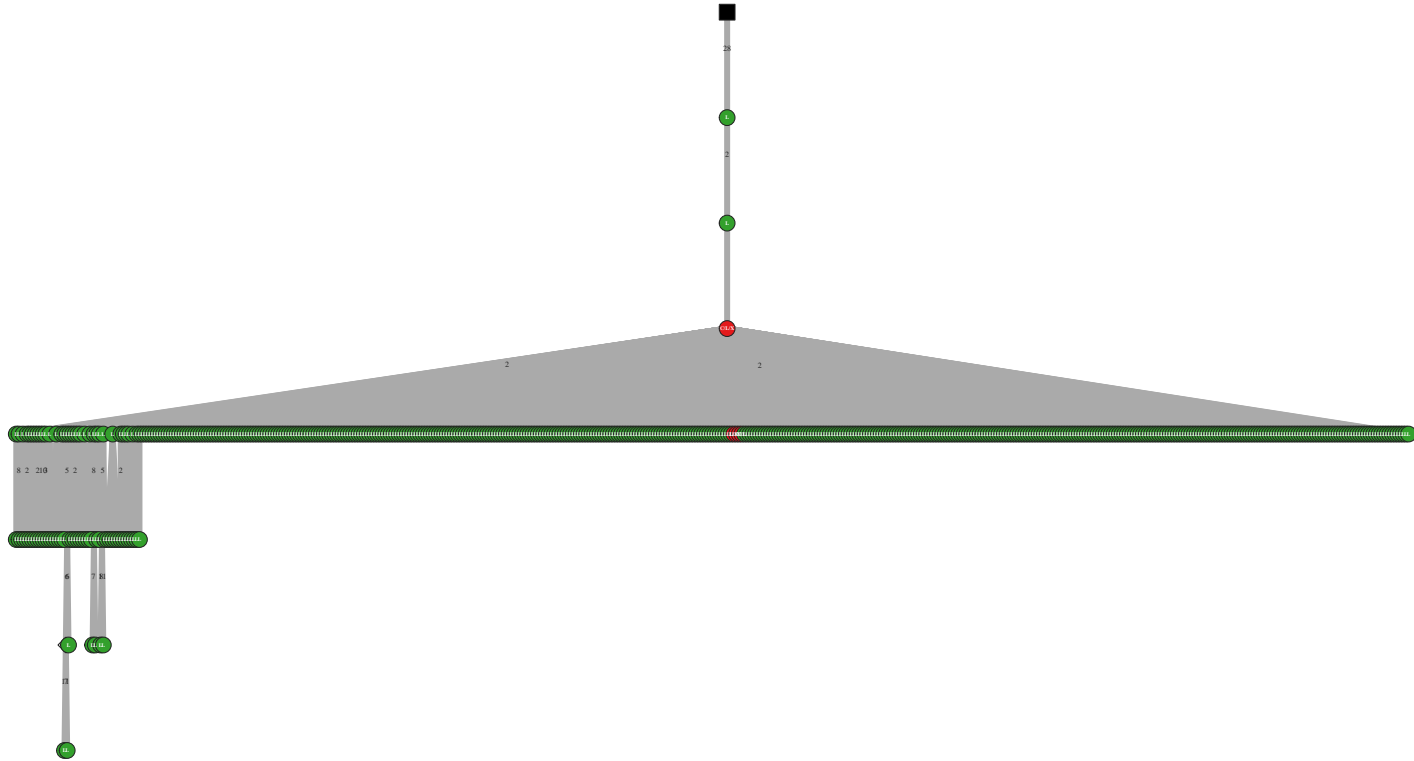

M5 IgG IGHV3-53/J4 48bp (52133)

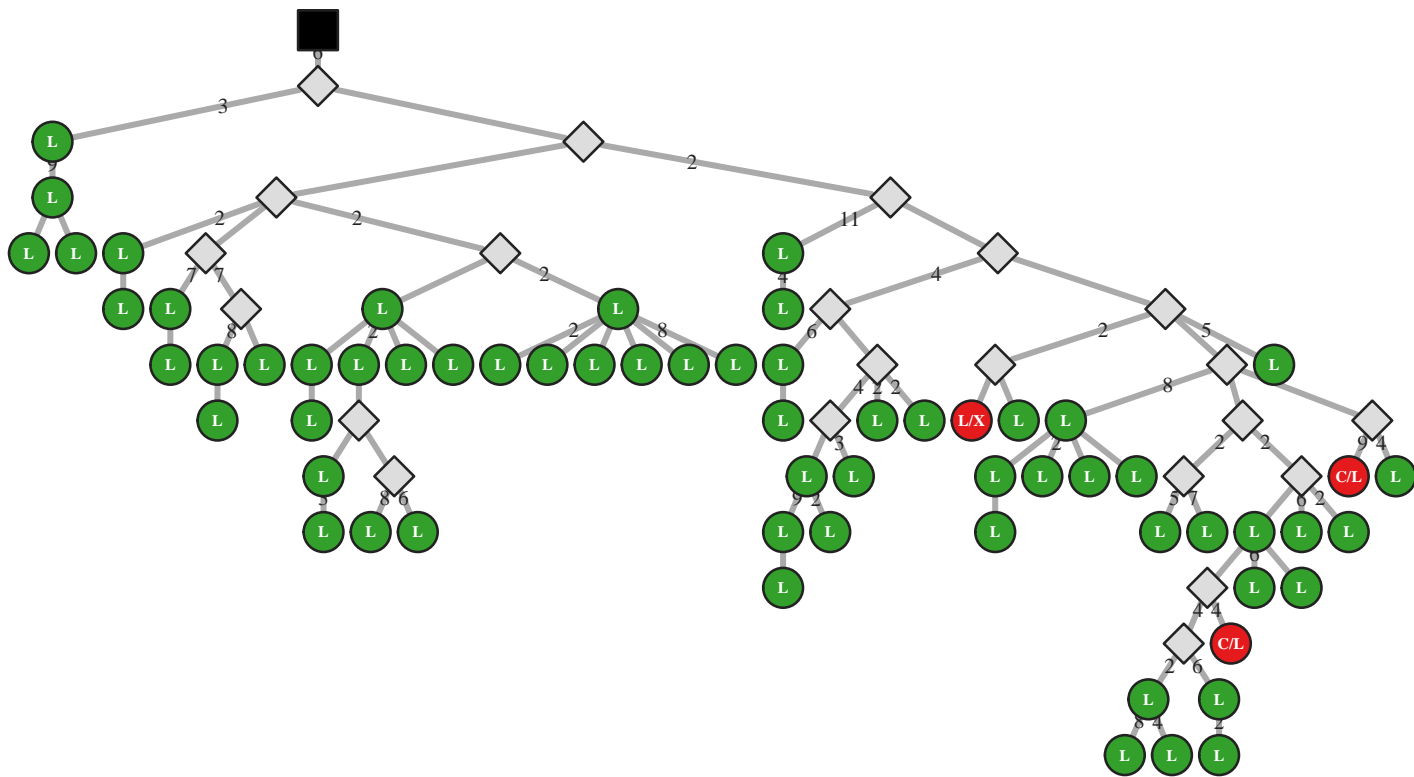

M5 IgG IGHV3-53/J4 51bp (18022)

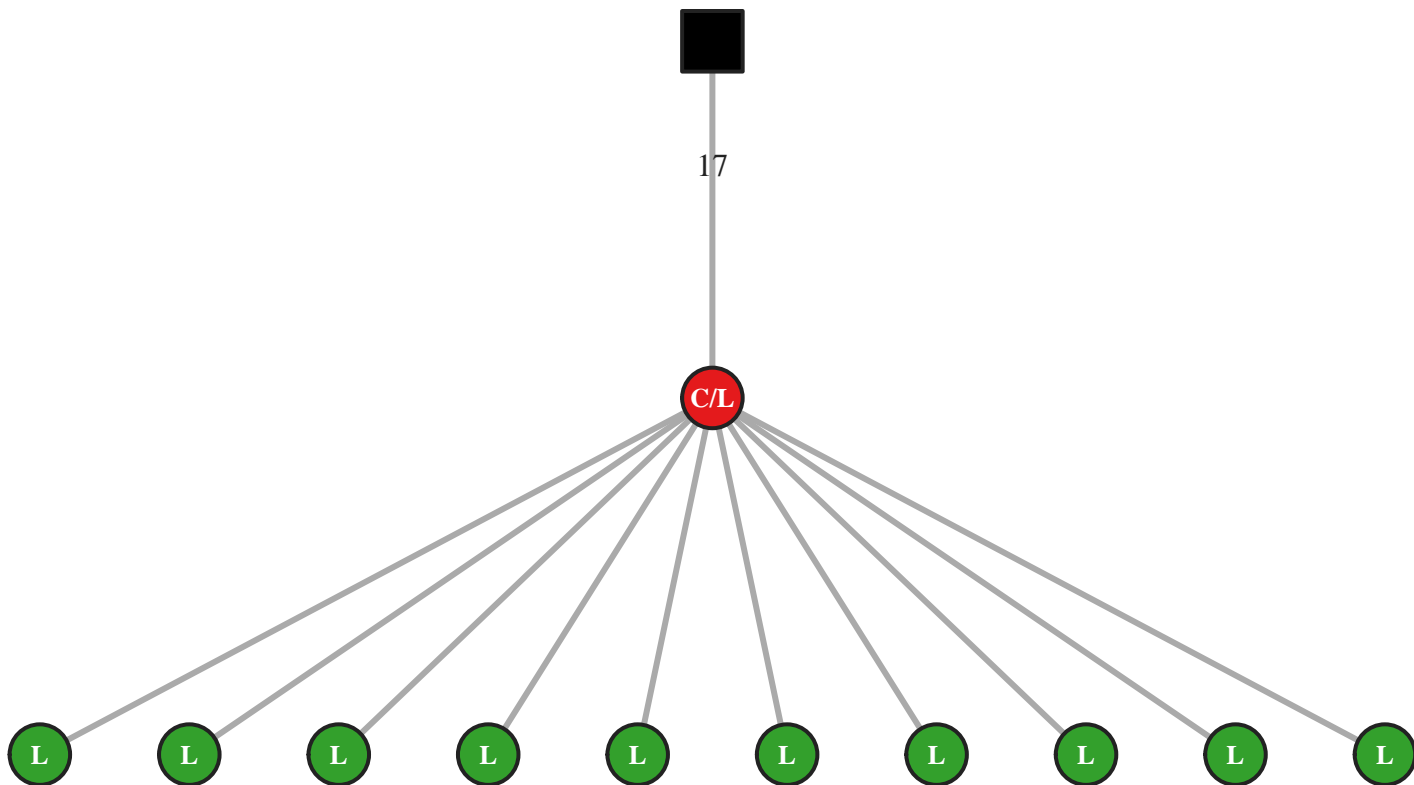

M5 IgG IGHV3-53/J4 66bp (18043)

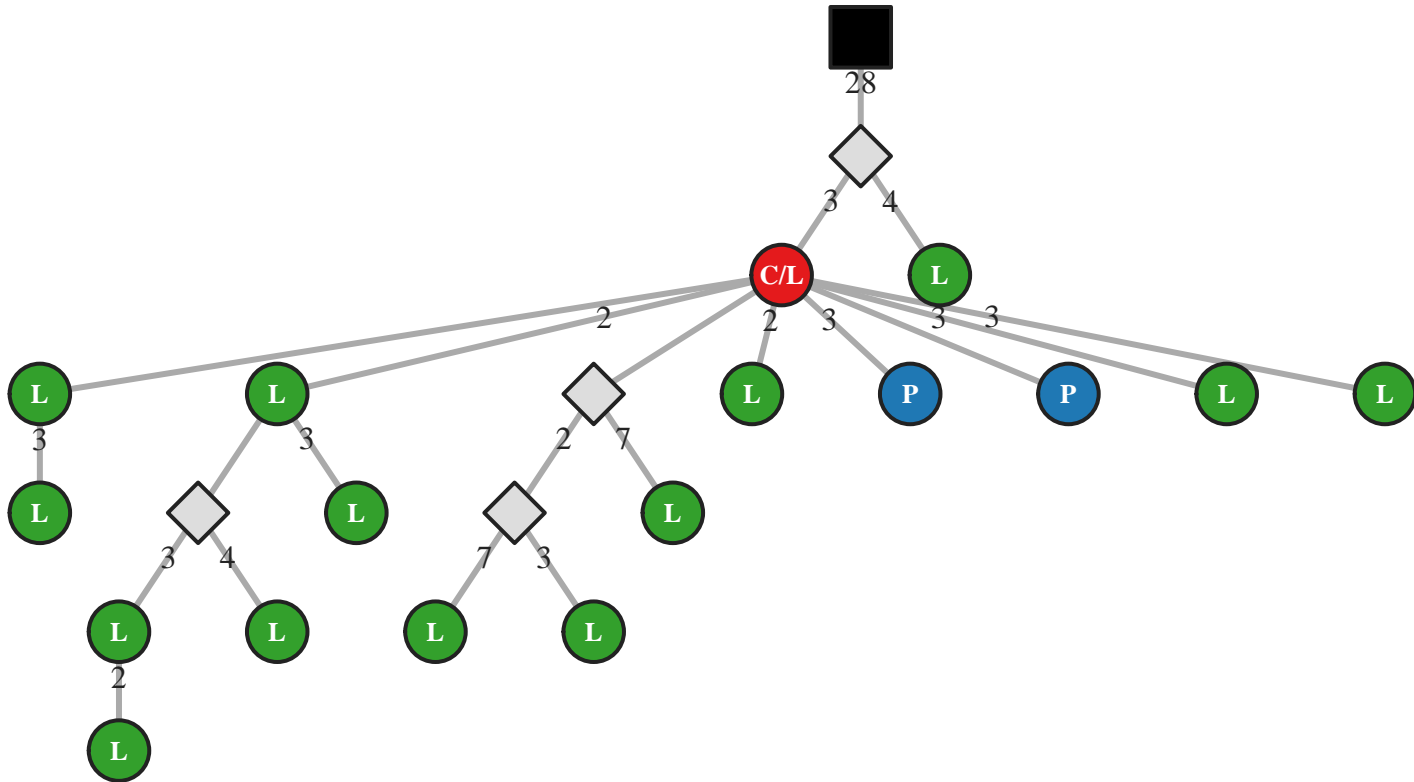

M5 IgG IGHV3-53/J6 45bp (45348)

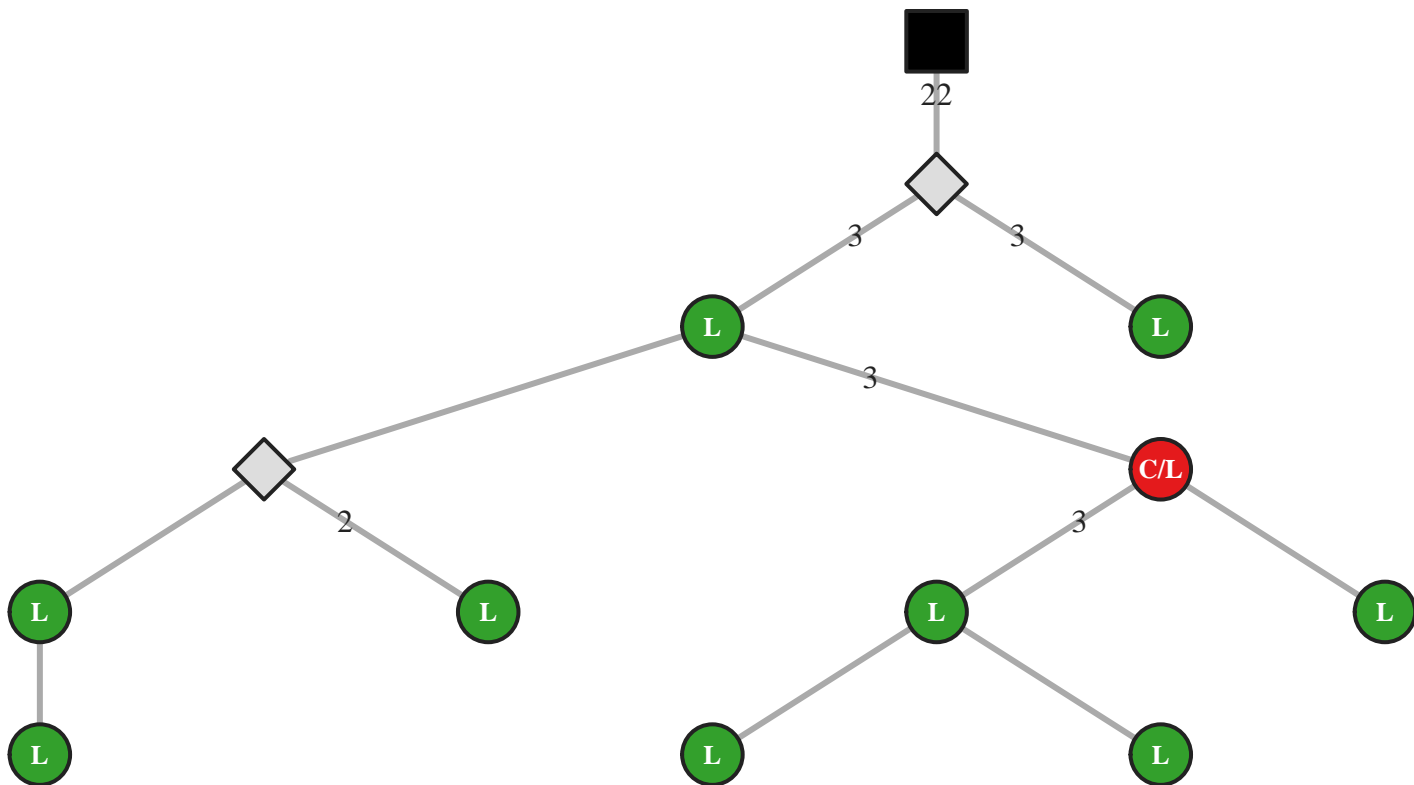

M5 IgG IGHV3-53/J6 60bp (26981)

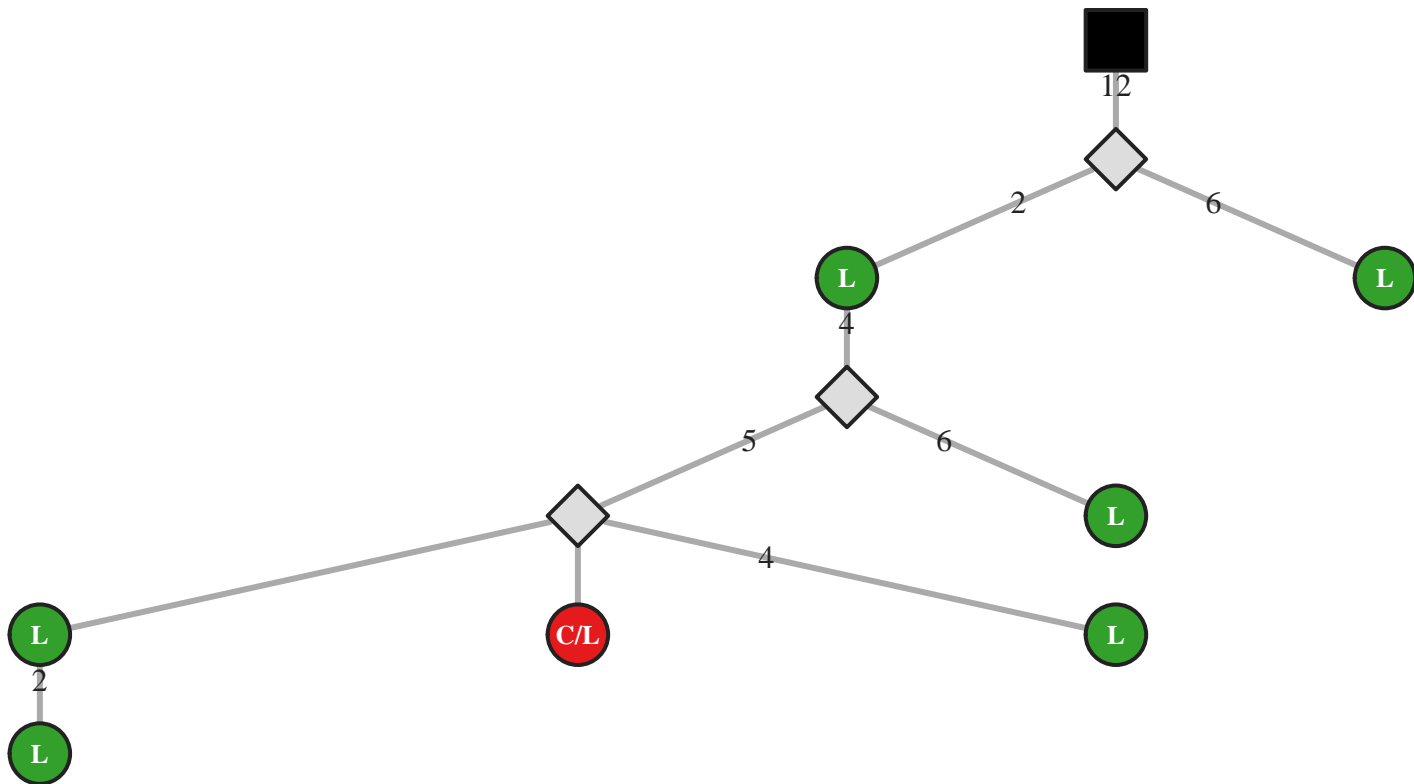

M5 IgG IGHV3-66/J4 36bp (45367)

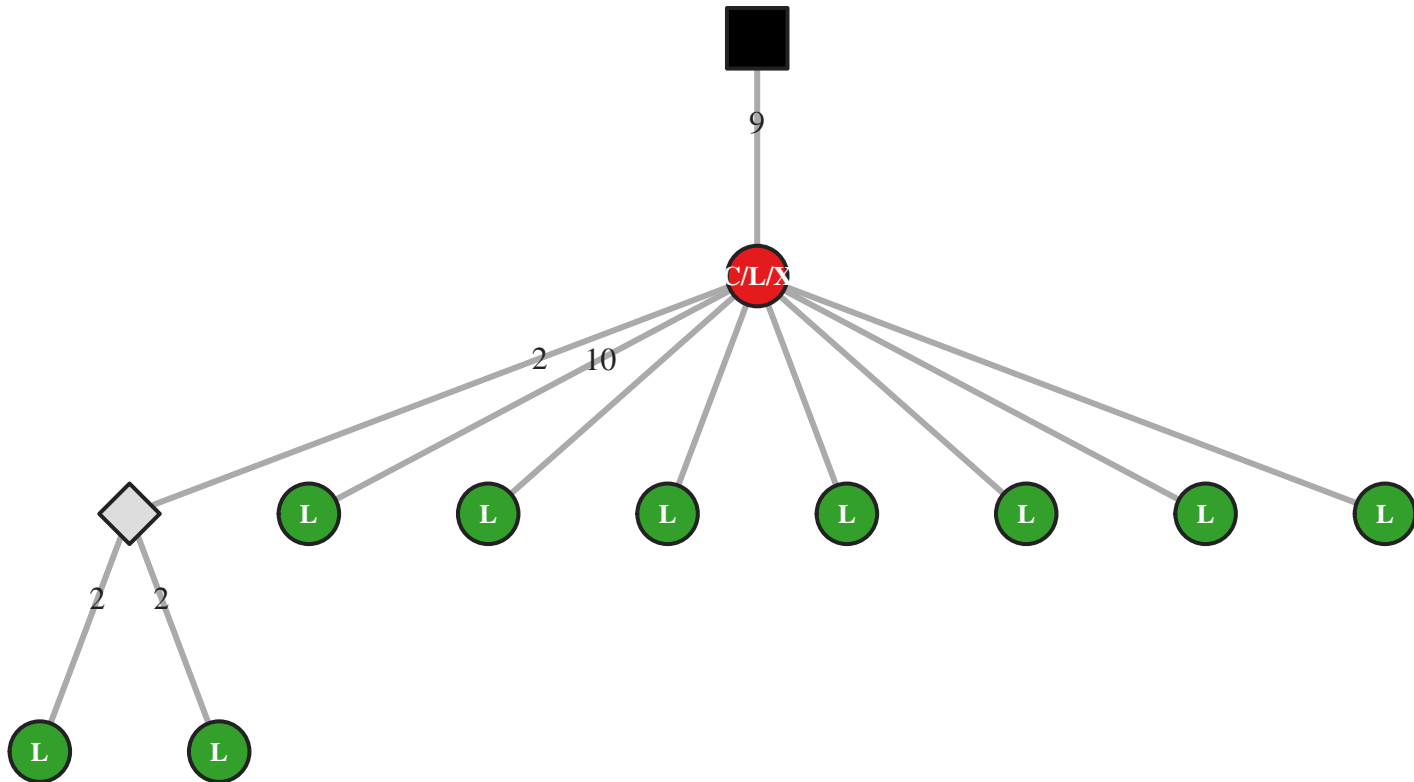

M5 IgG IGHV3-66/J4 36bp (45386)

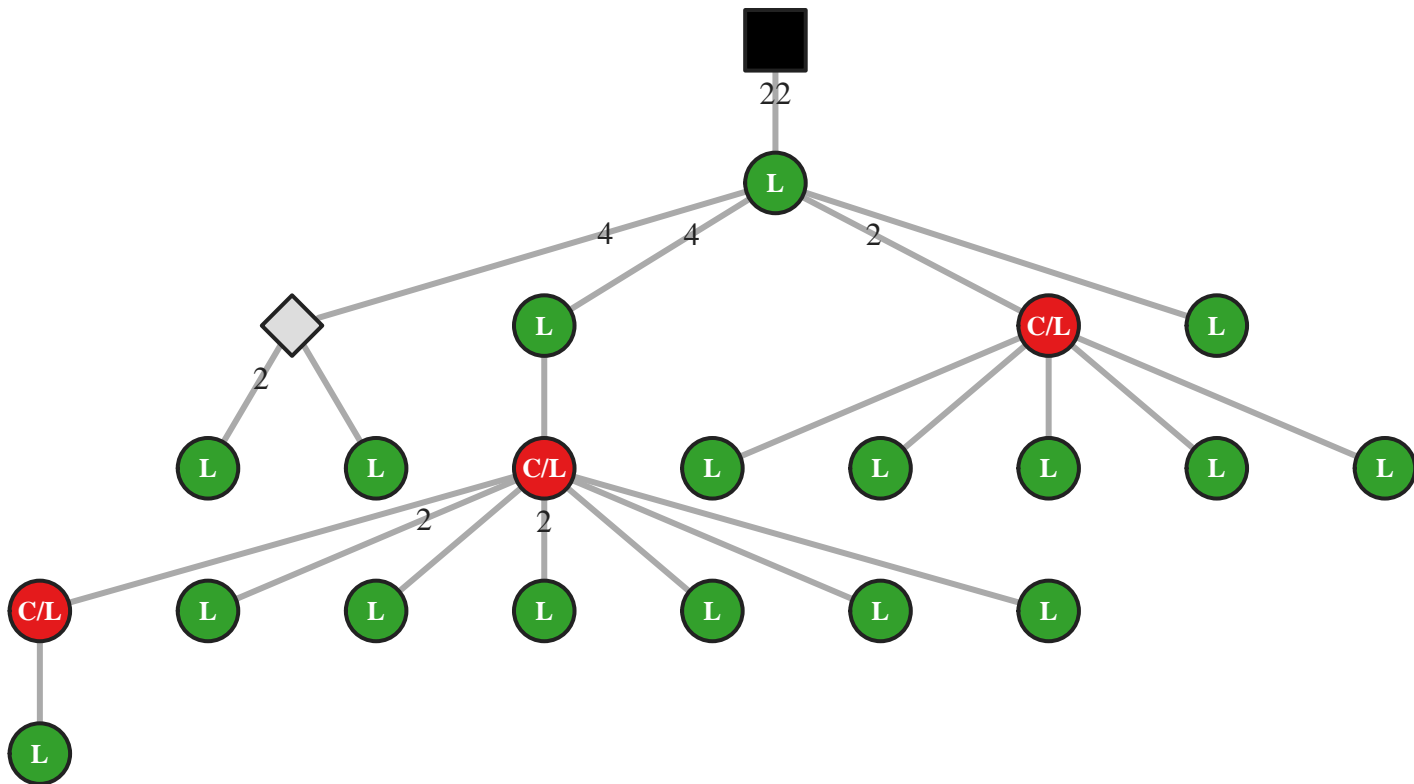

M5 IgA IGHV3-66/J5 27bp (30620)

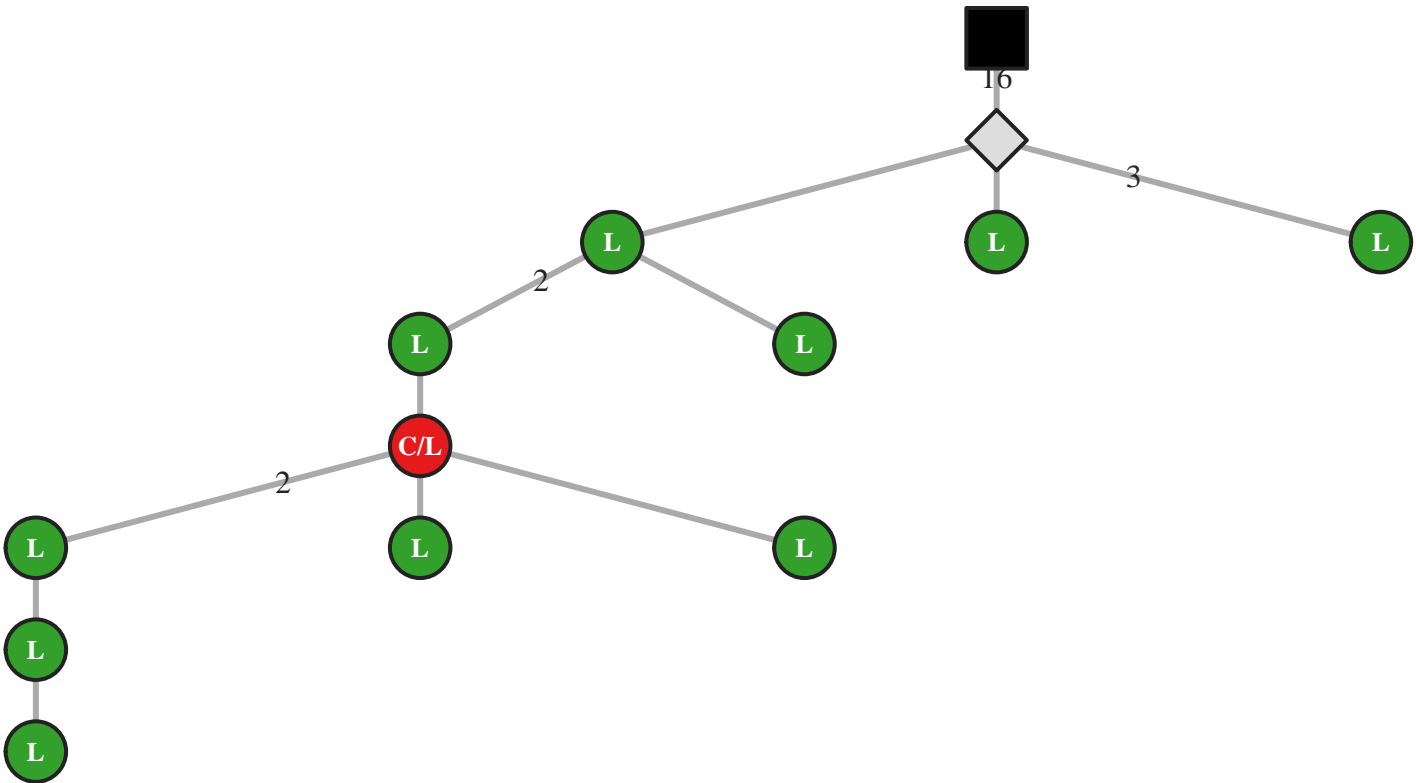

M5 IgG IGHV3-7/J1 36bp (35657)

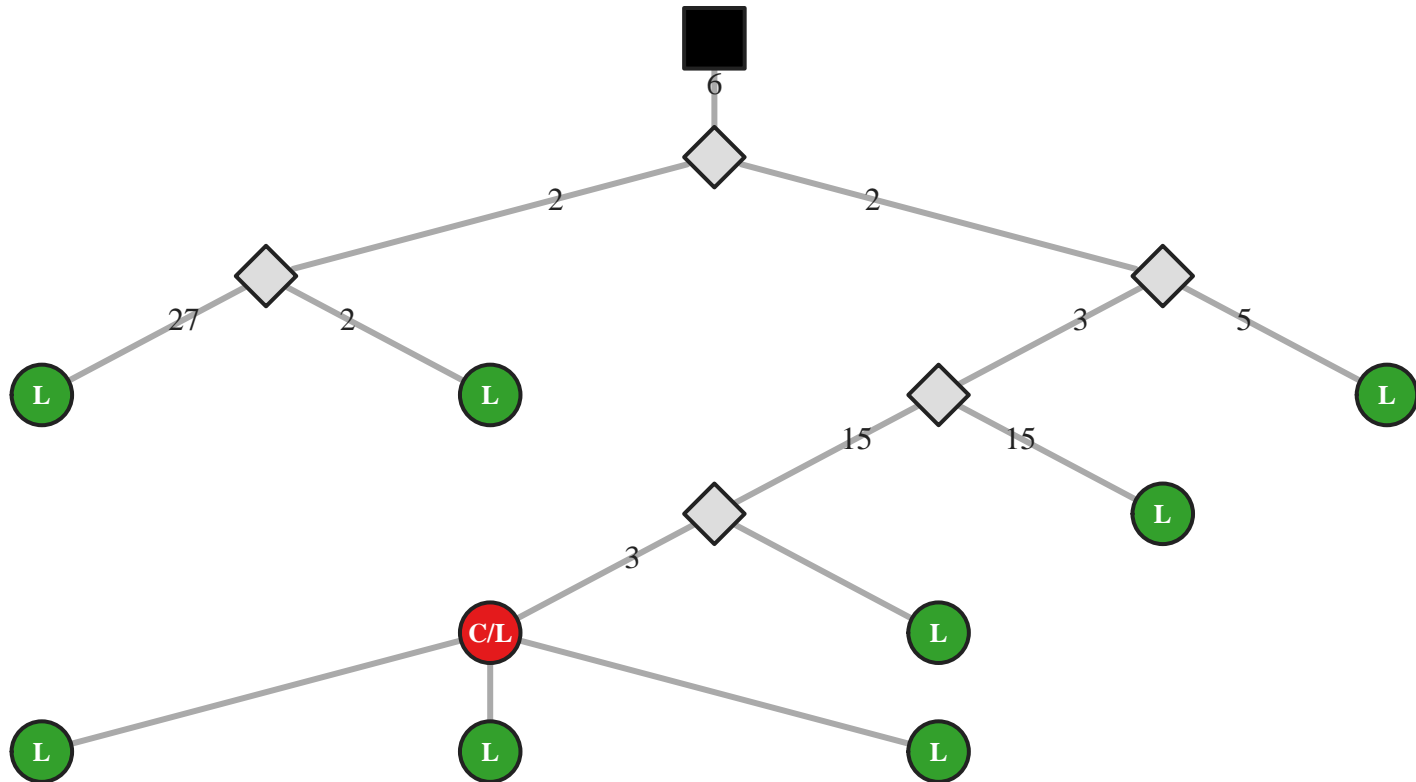

M5 IgG IGHV3-7/J3 51bp (27282)

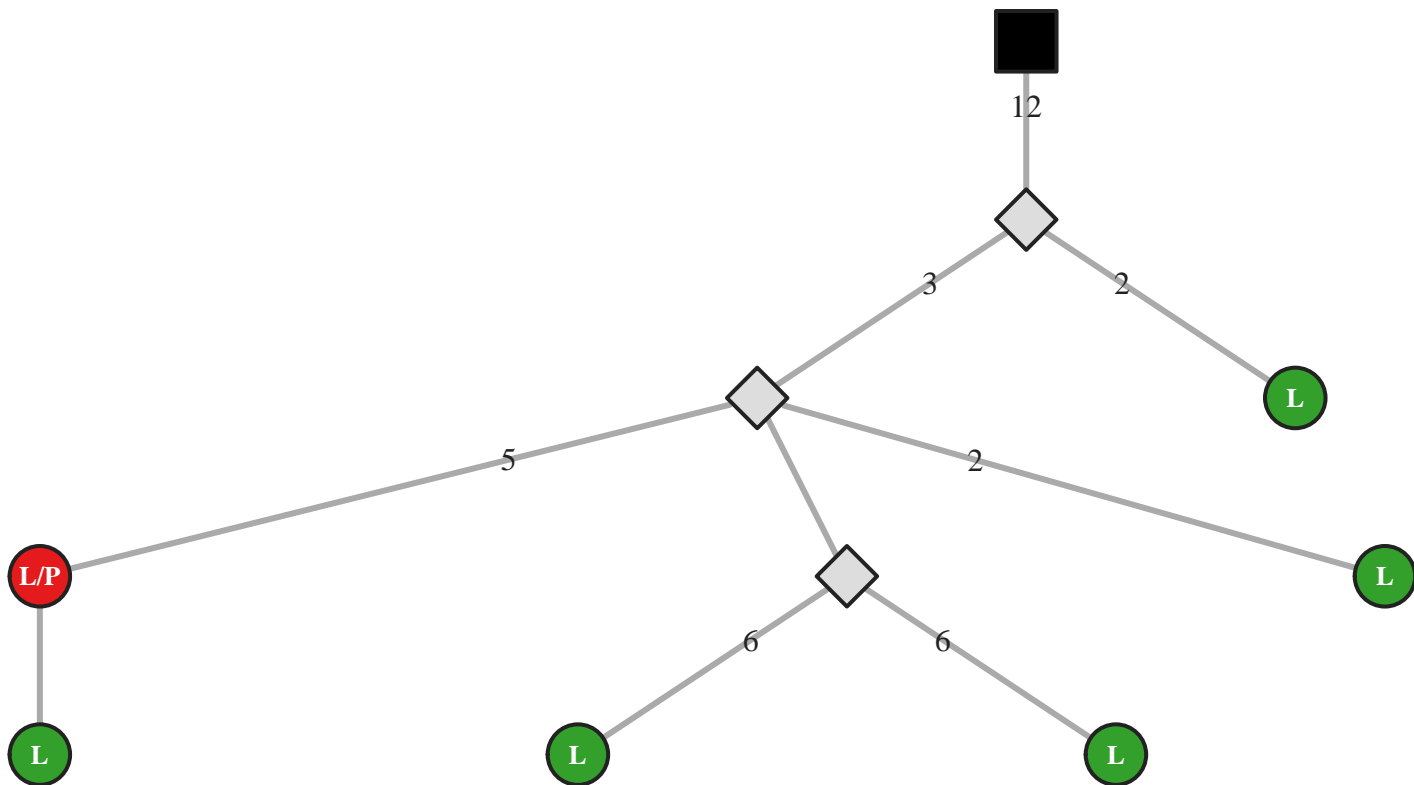

M5 IgG IGHV3-7/J4 27bp (52323)

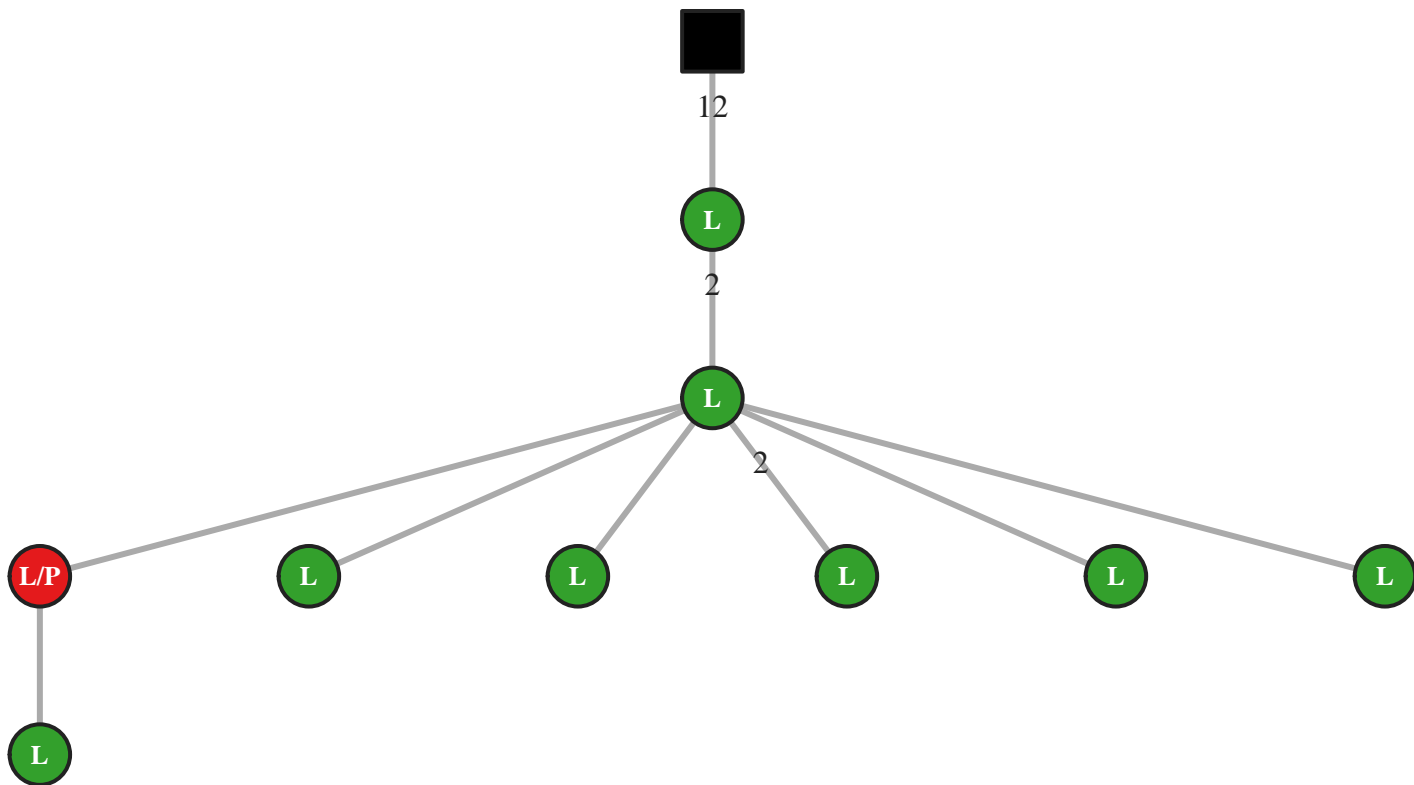

M5 IgG IGHV3-7/J4 30bp (45544)

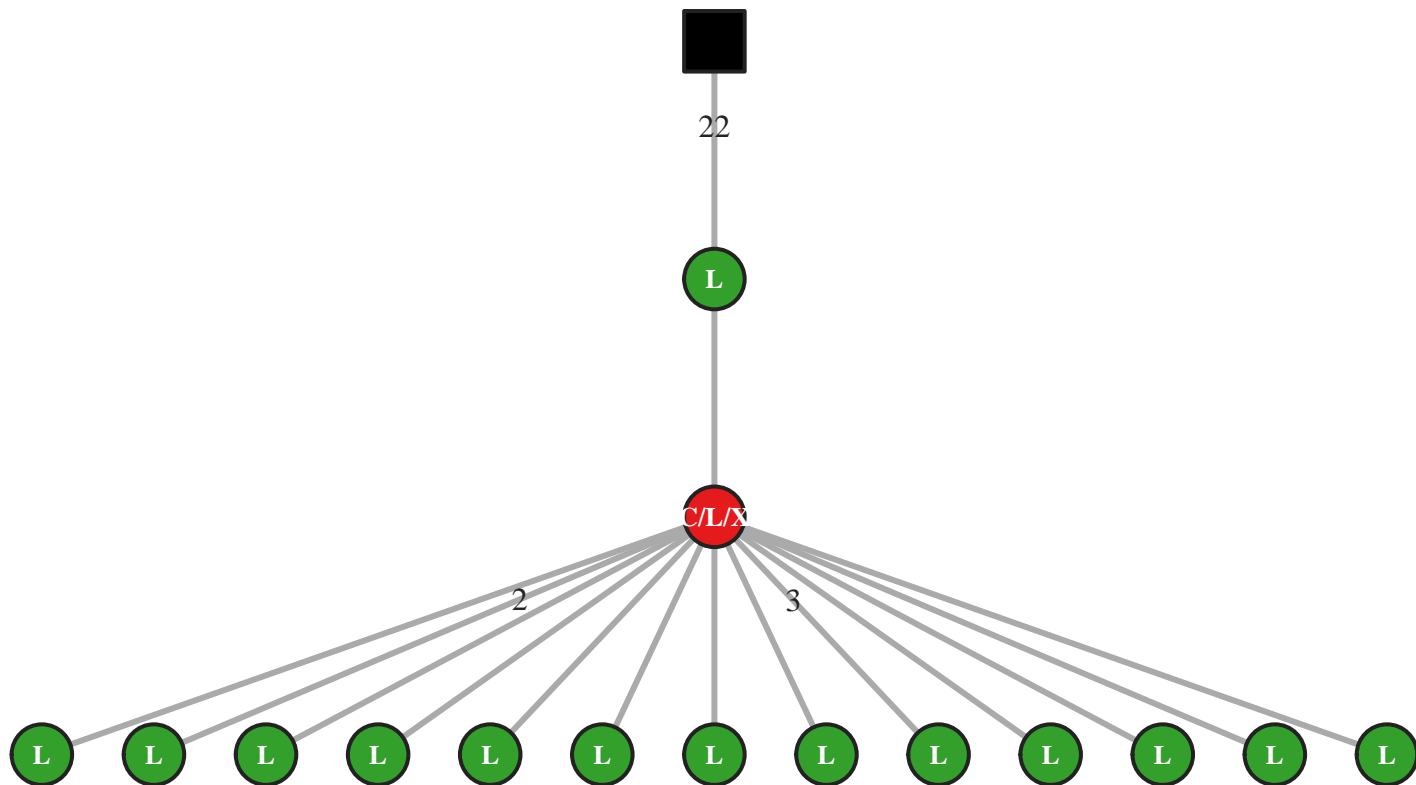

M5 IgG IGHV3-7/J4 36bp (52358)

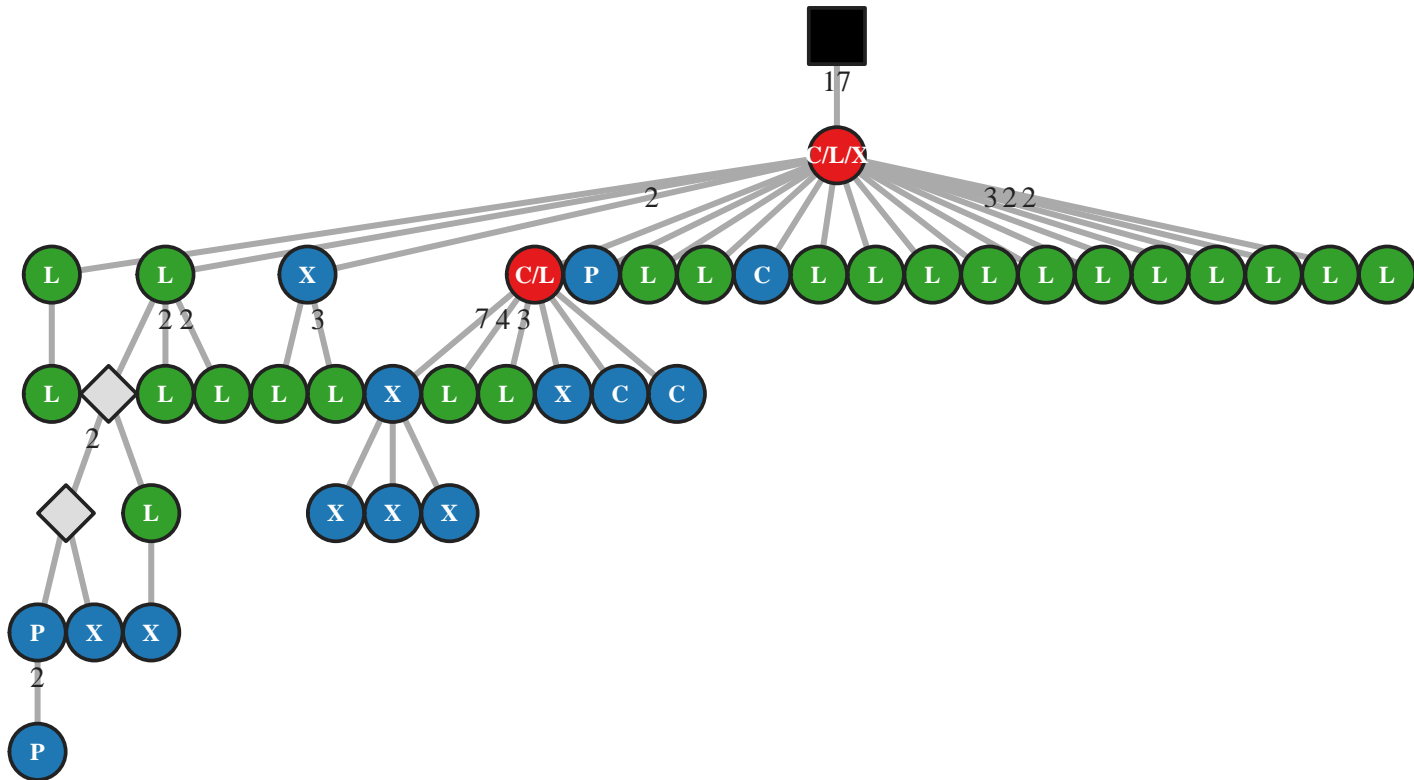

M5 IgM IGHV3-7/J4 36bp (54273)

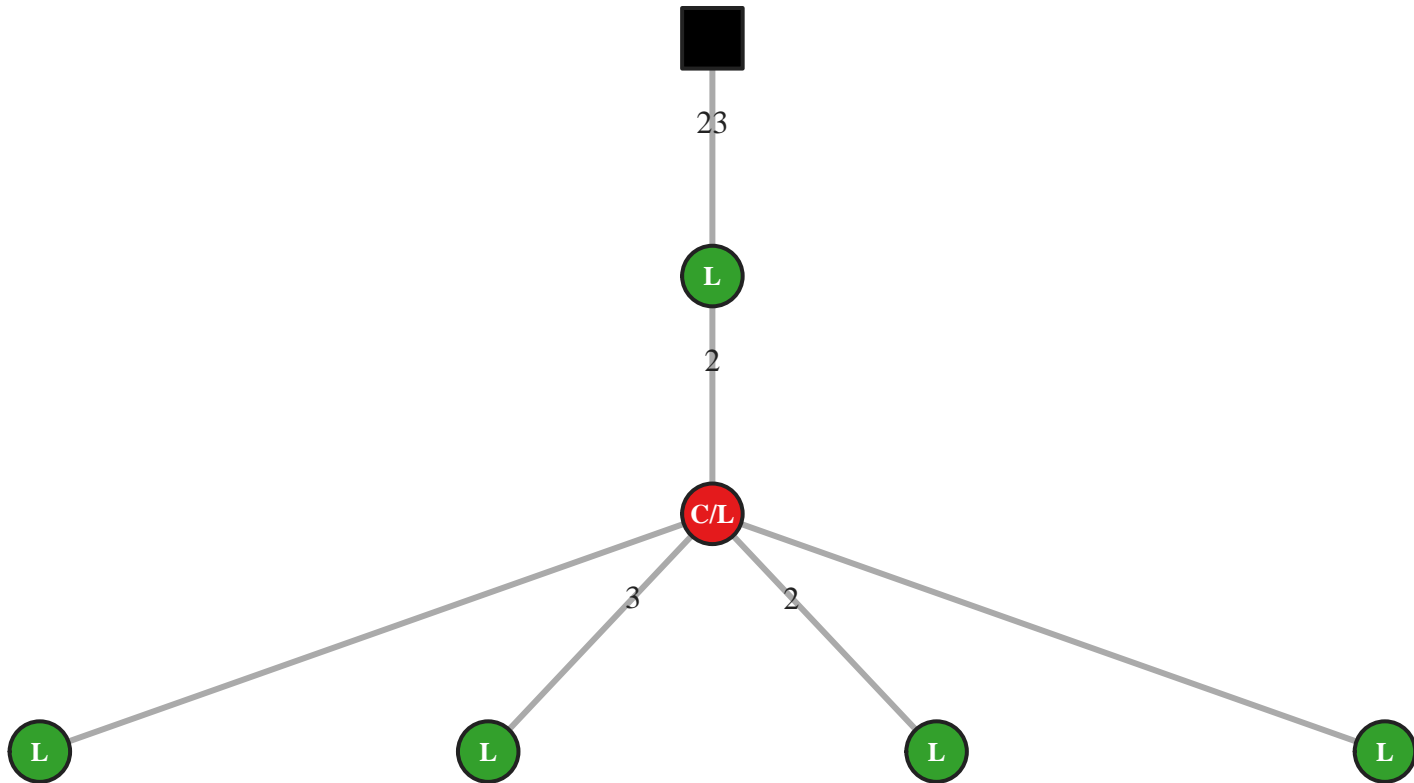

M5 IgG IGHV3-7/J4 39bp (8696)

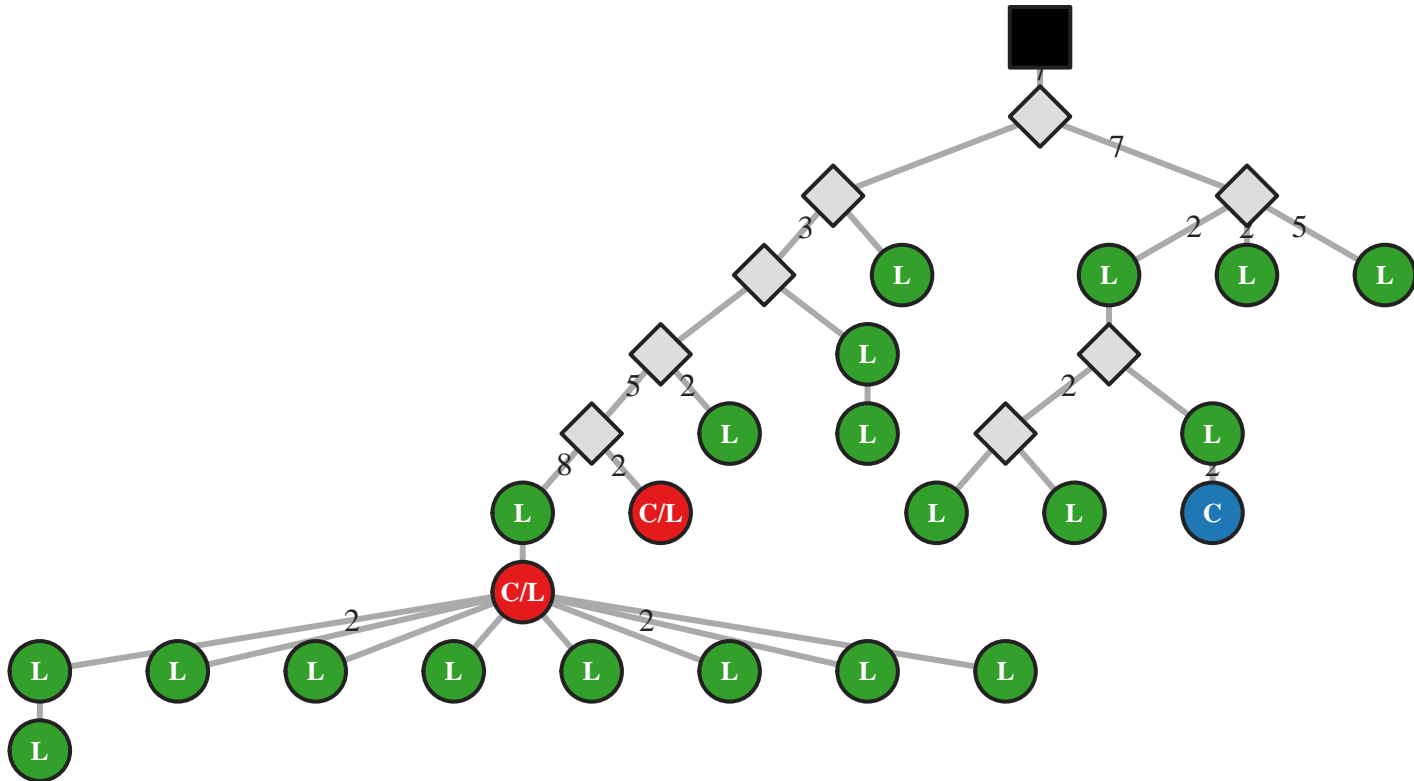

M5 IgG IGHV3-7/J4 39bp (8729)

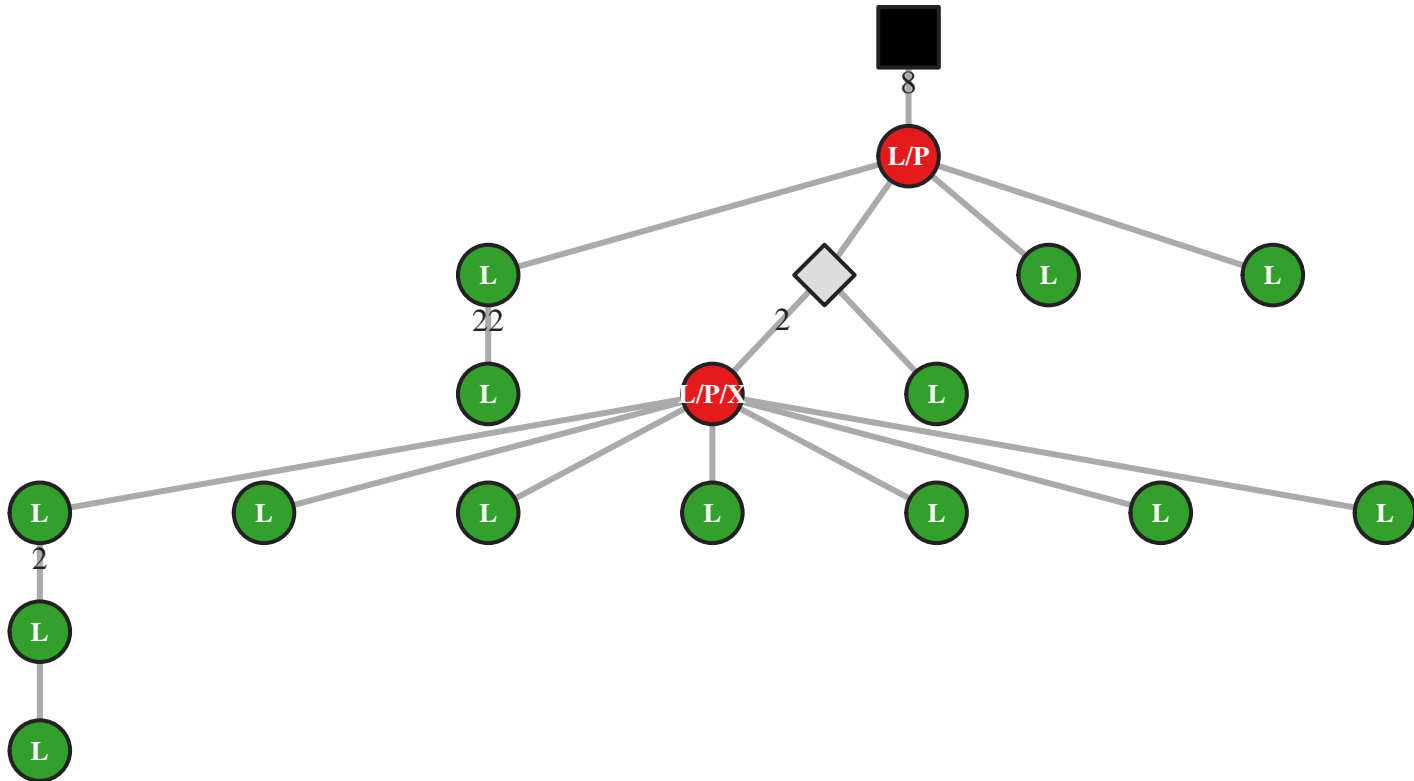

M5 IgG IGHV3-7/J4 42bp (8785)

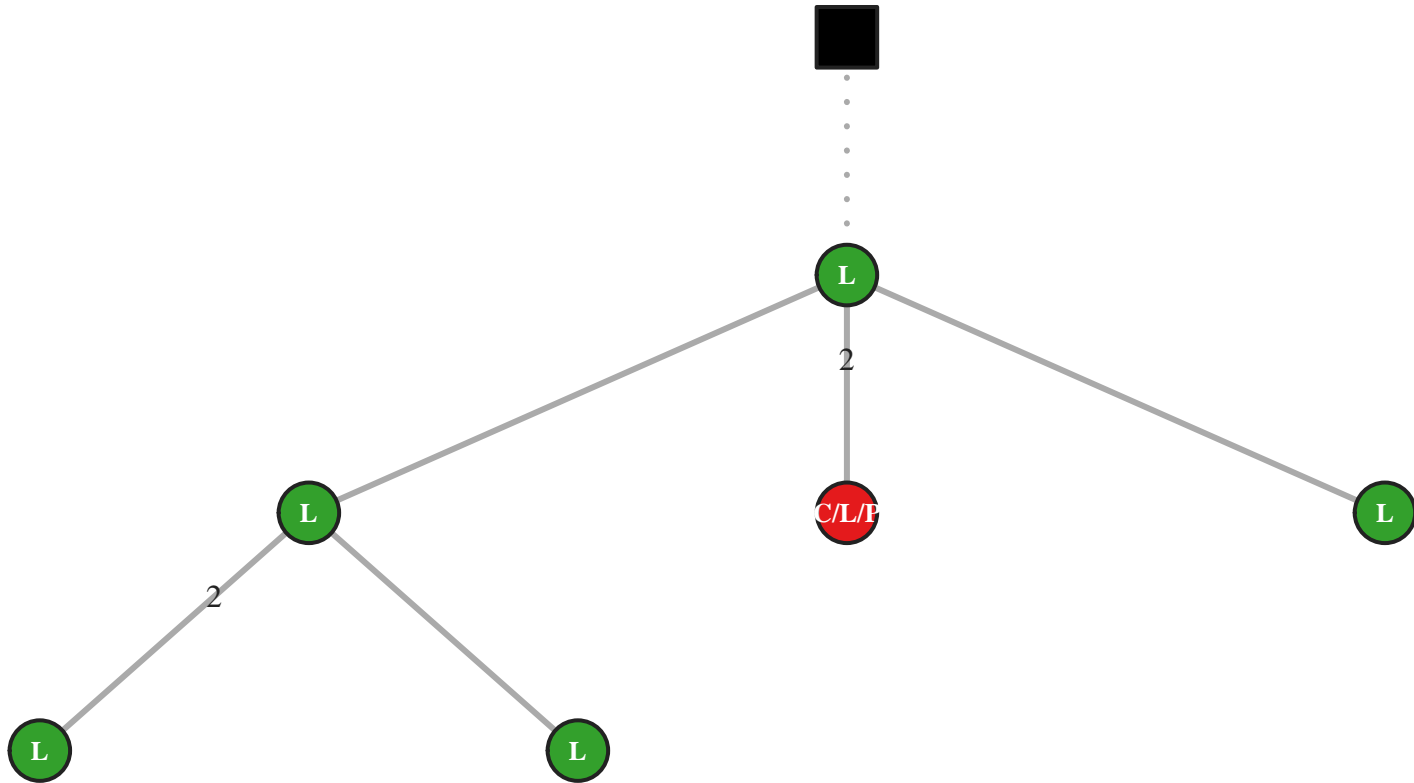

M5 IgG IGHV3-7/J4 42bp (8794)

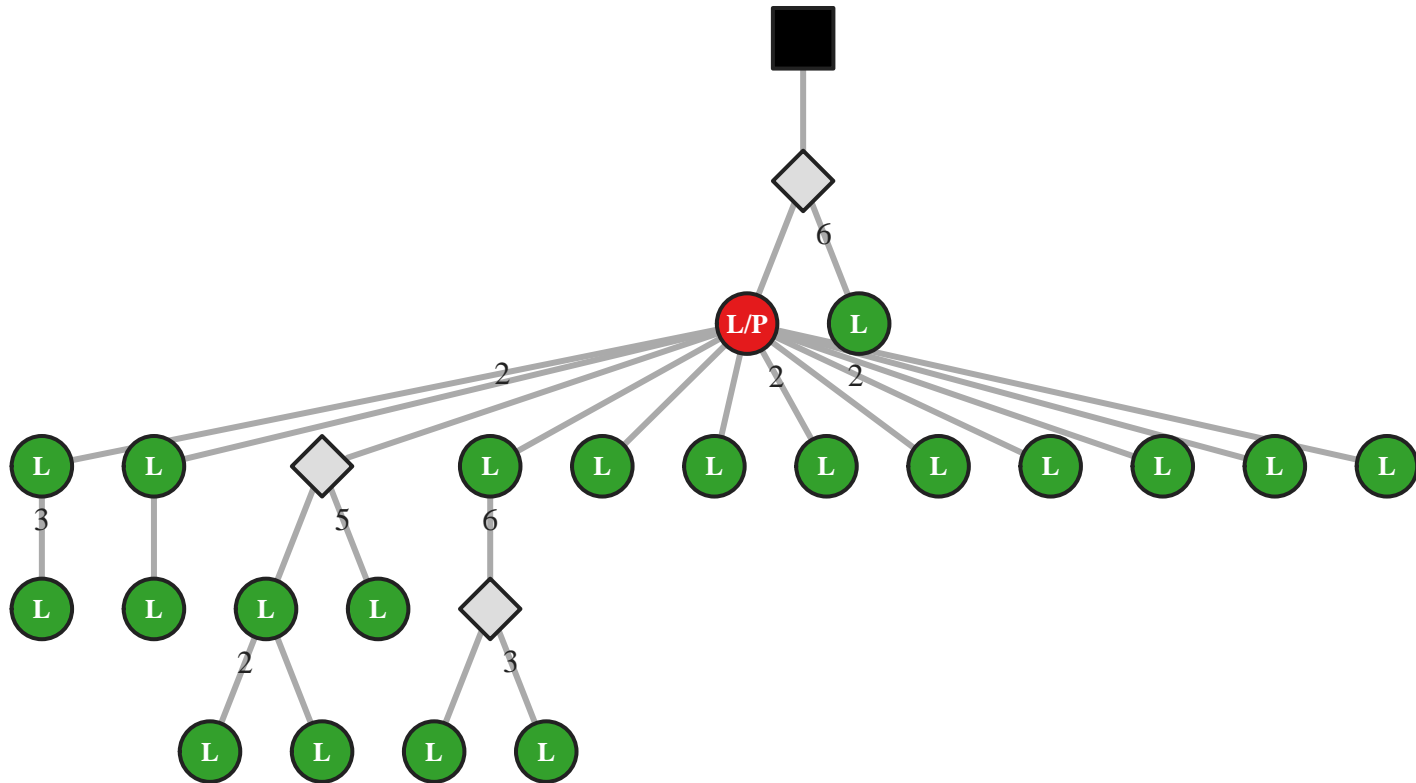

M5 IgG IGHV3-7/J4 48bp (45626)

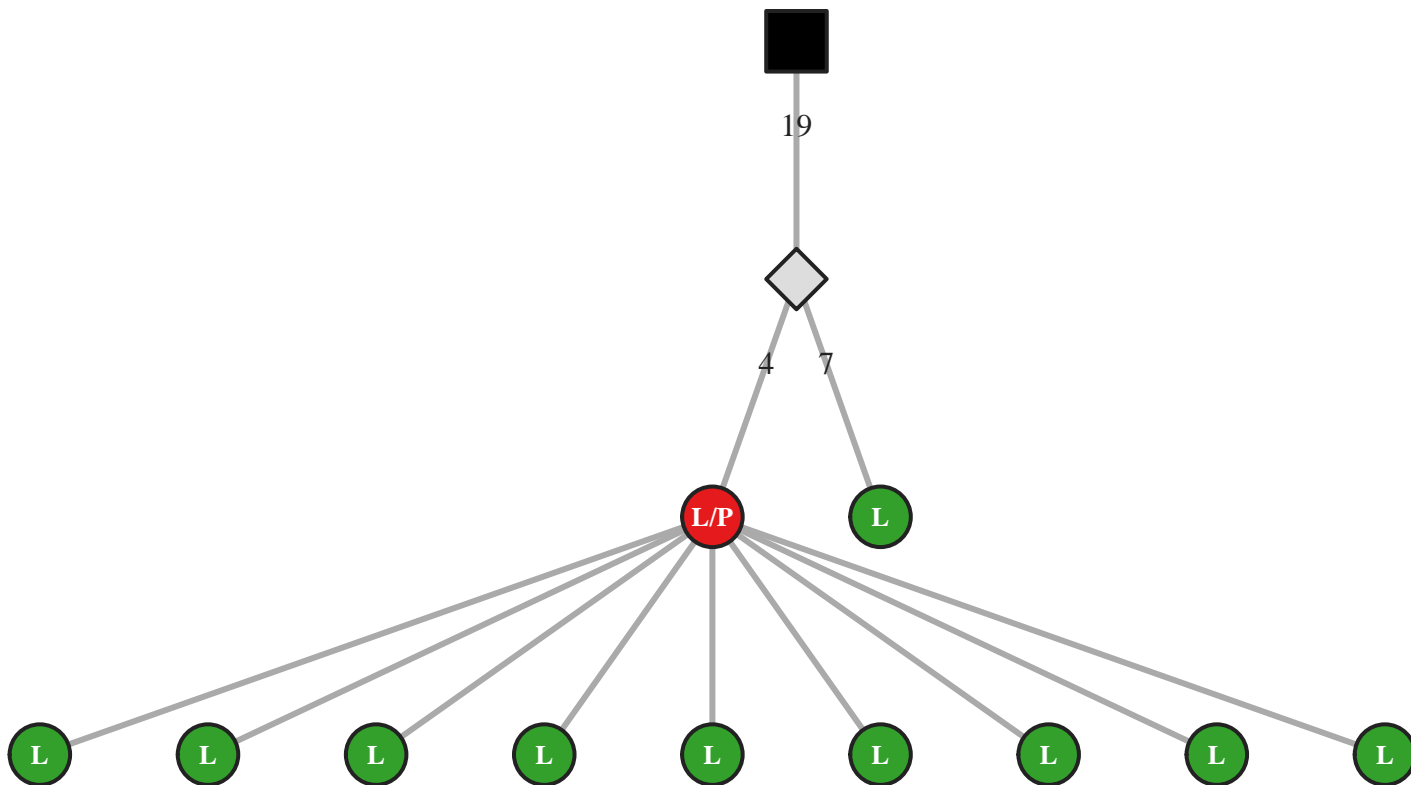

M5 IgG IGHV3-7/J4 51bp (52413)

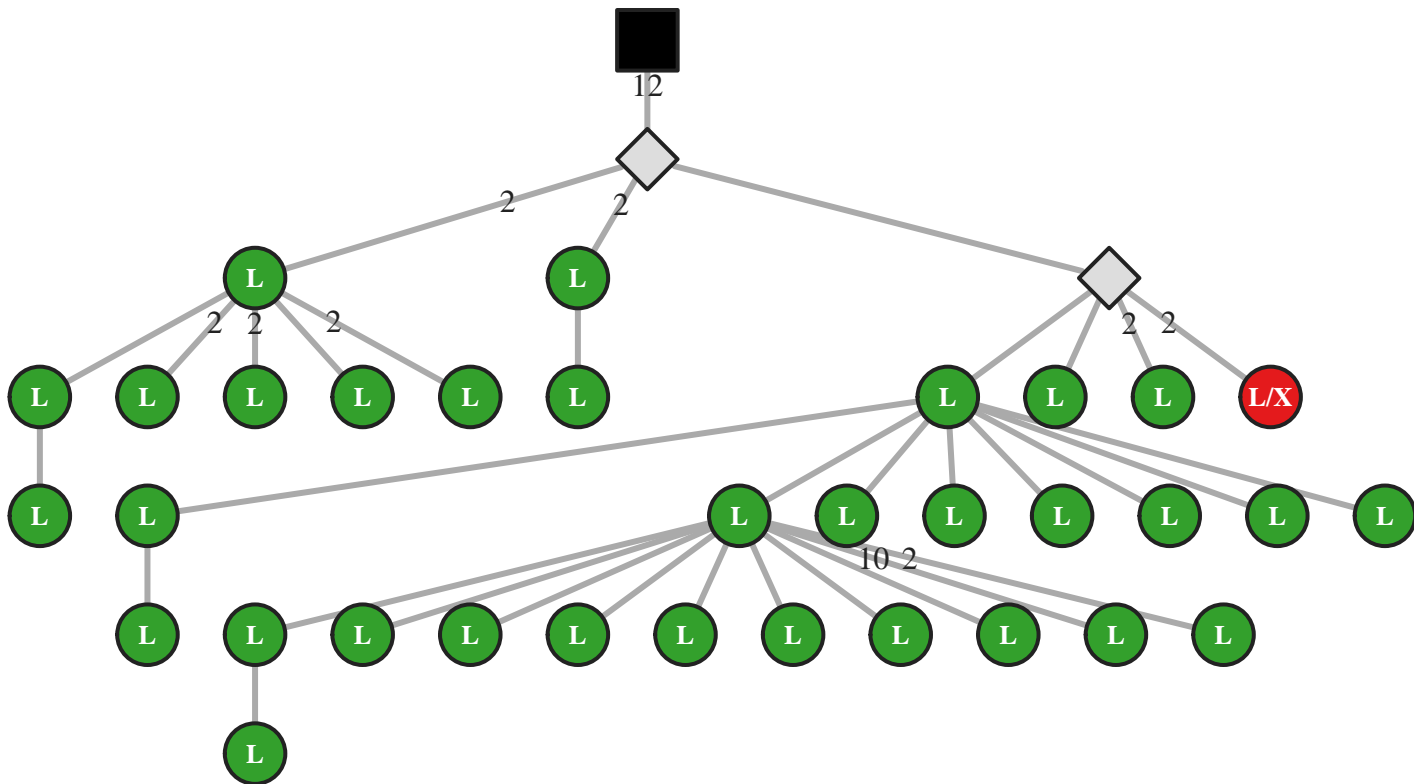

M5 IgG IGHV3-7/J4 51bp (52430)

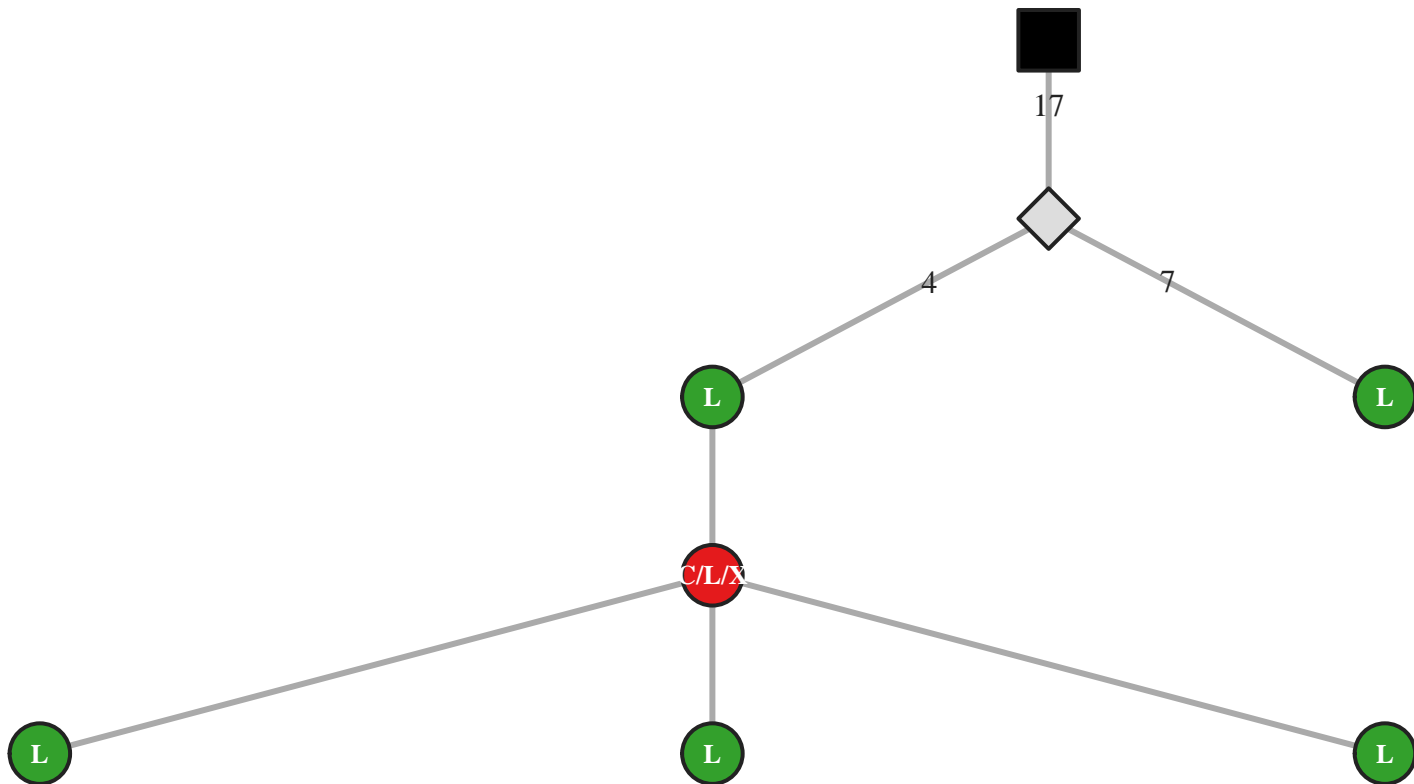

M5 IgG IGHV3-7/J4 51bp (52443)

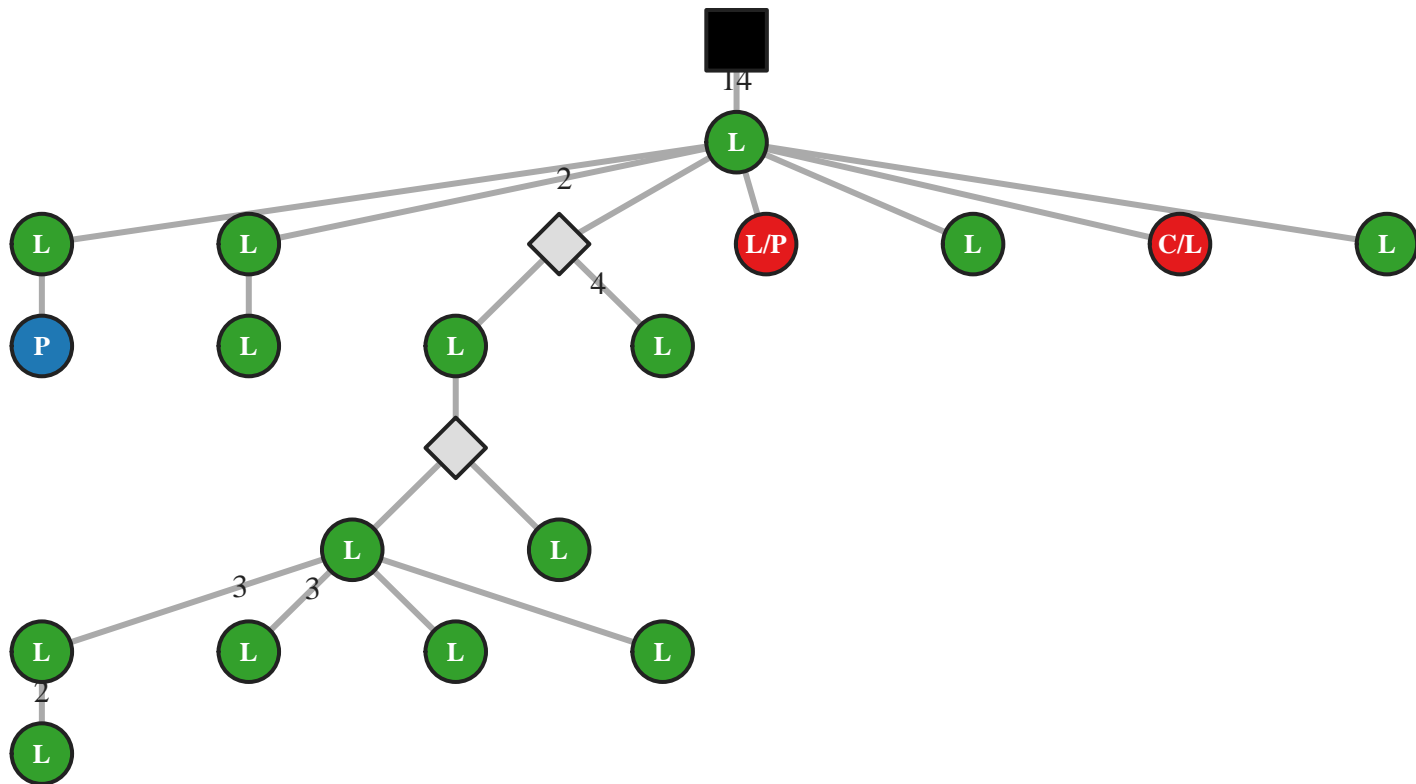

M5 IgG IGHV3-7/J4 54bp (45668)

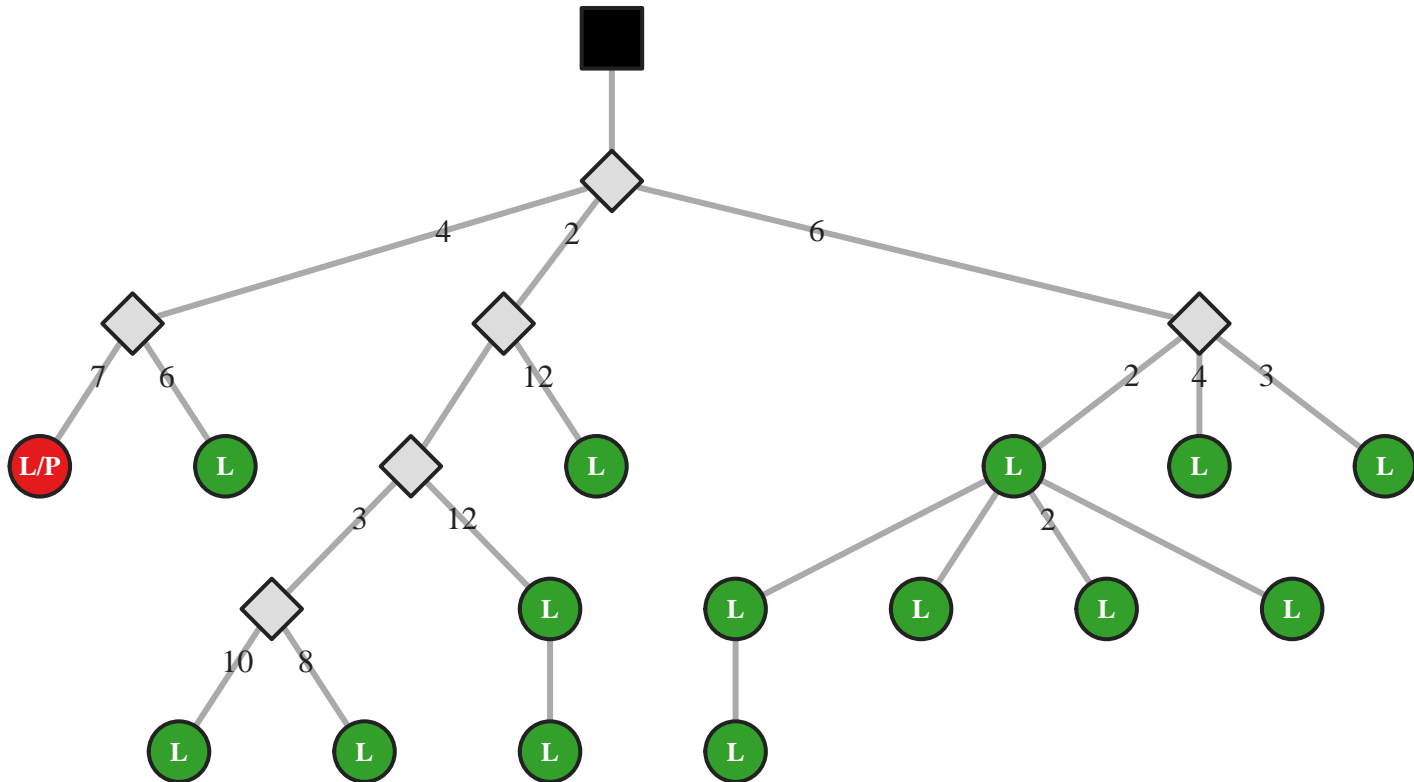

M5 IgG IGHV3-7/J4 63bp (35723)

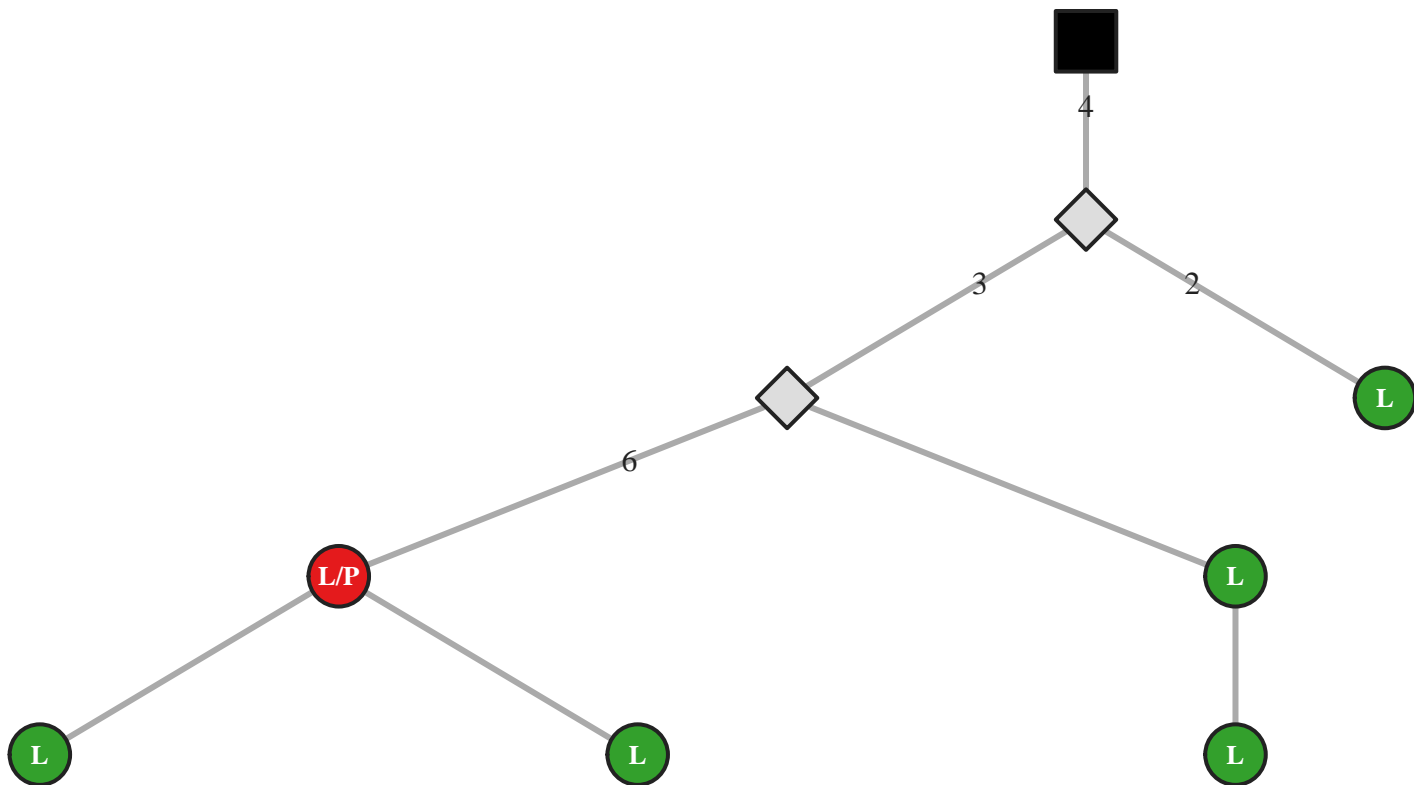

M5 IgG IGHV3-7/J4 63bp (35726)

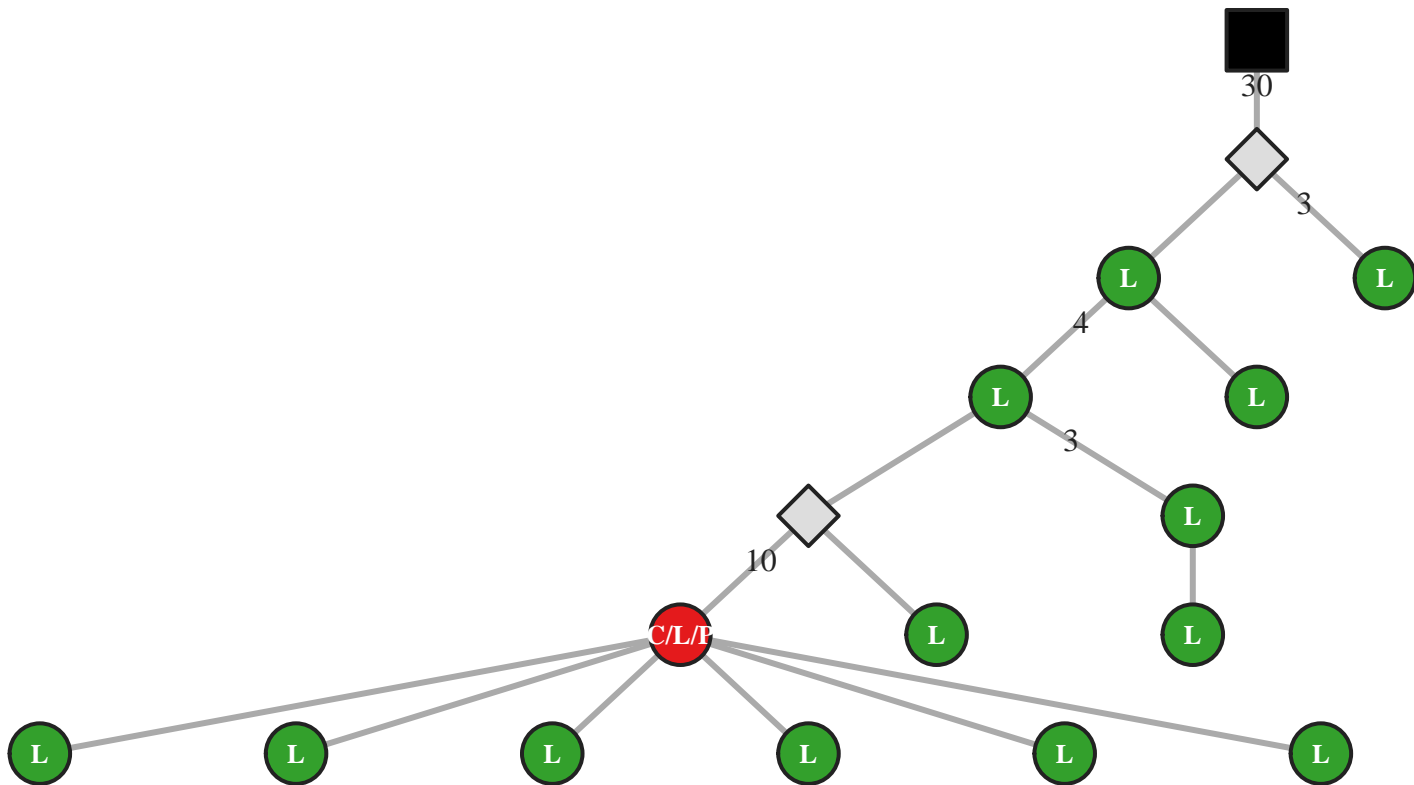

M5 IgG IGHV3-7/J5 27bp (52329)

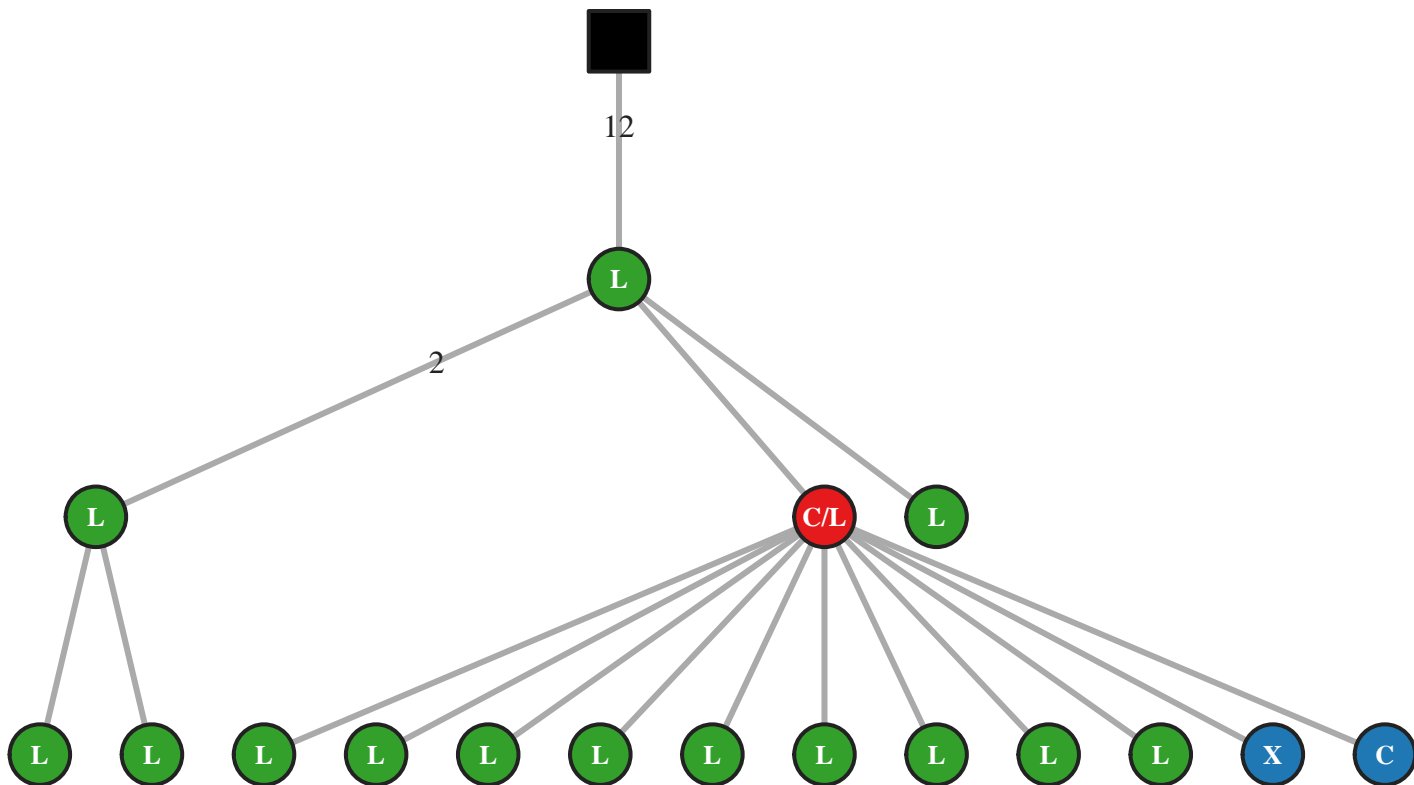

M5 IgA IGHV3-7/J5 42bp (3046)

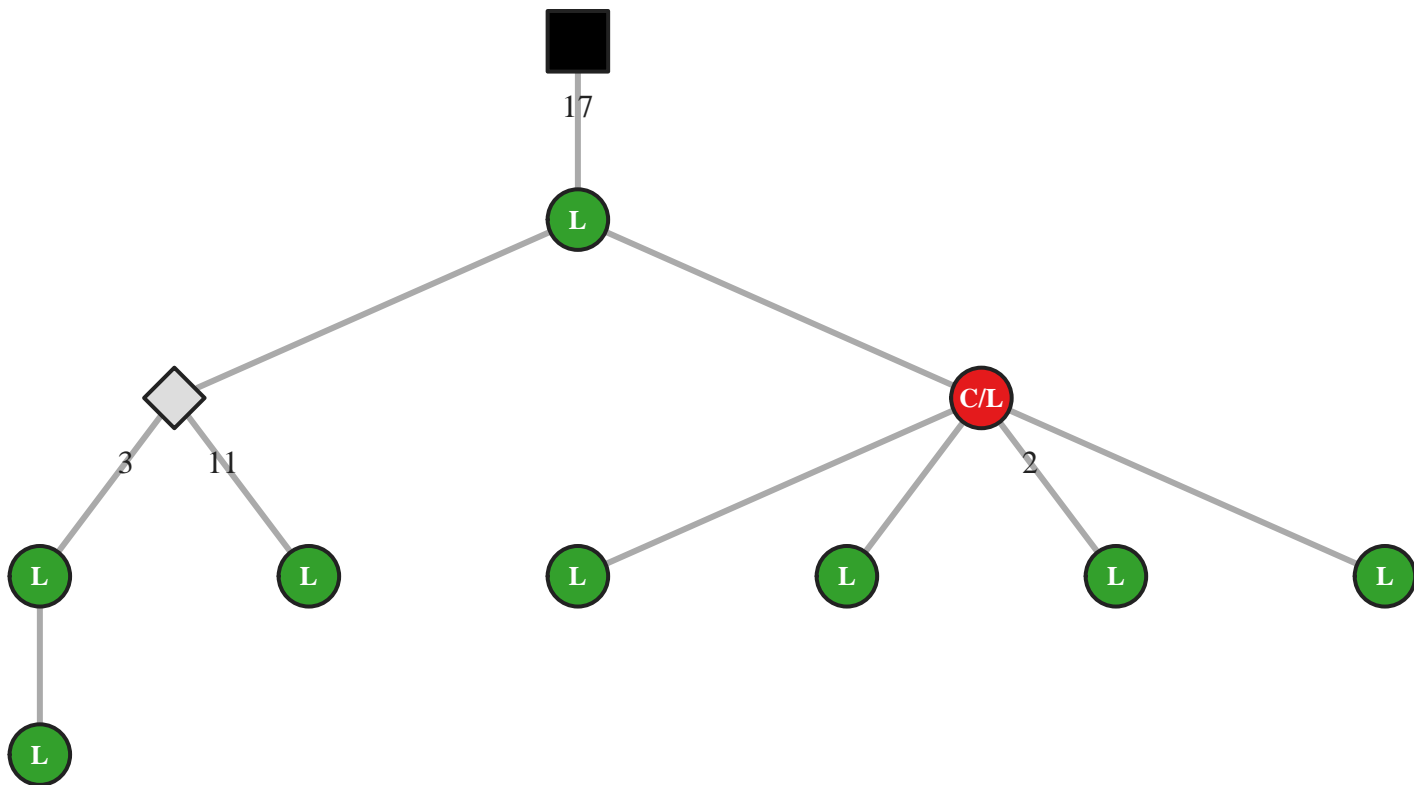

M5 IgG IGHV3-7/J6 24bp (18294)

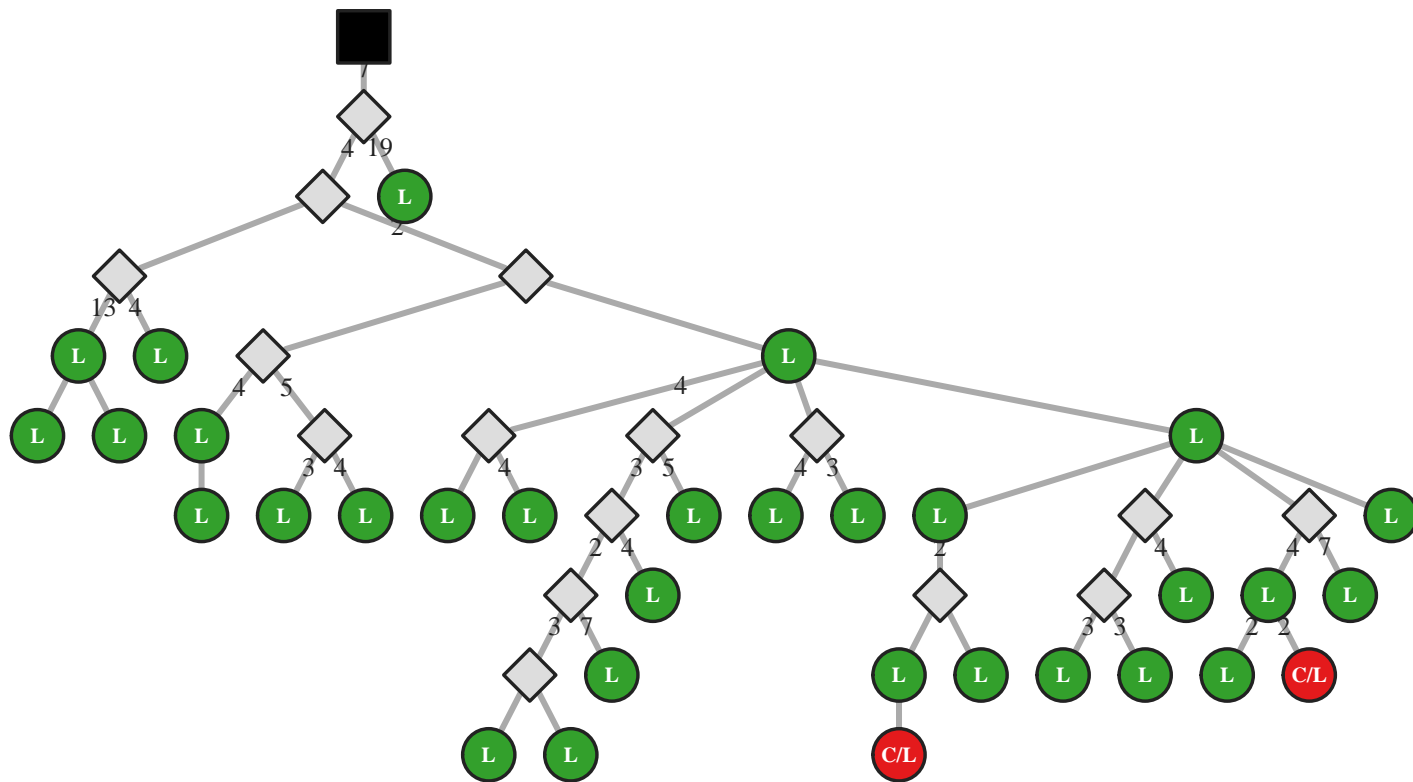

M5 IgG IGHV3-7/J6 27bp (18295)

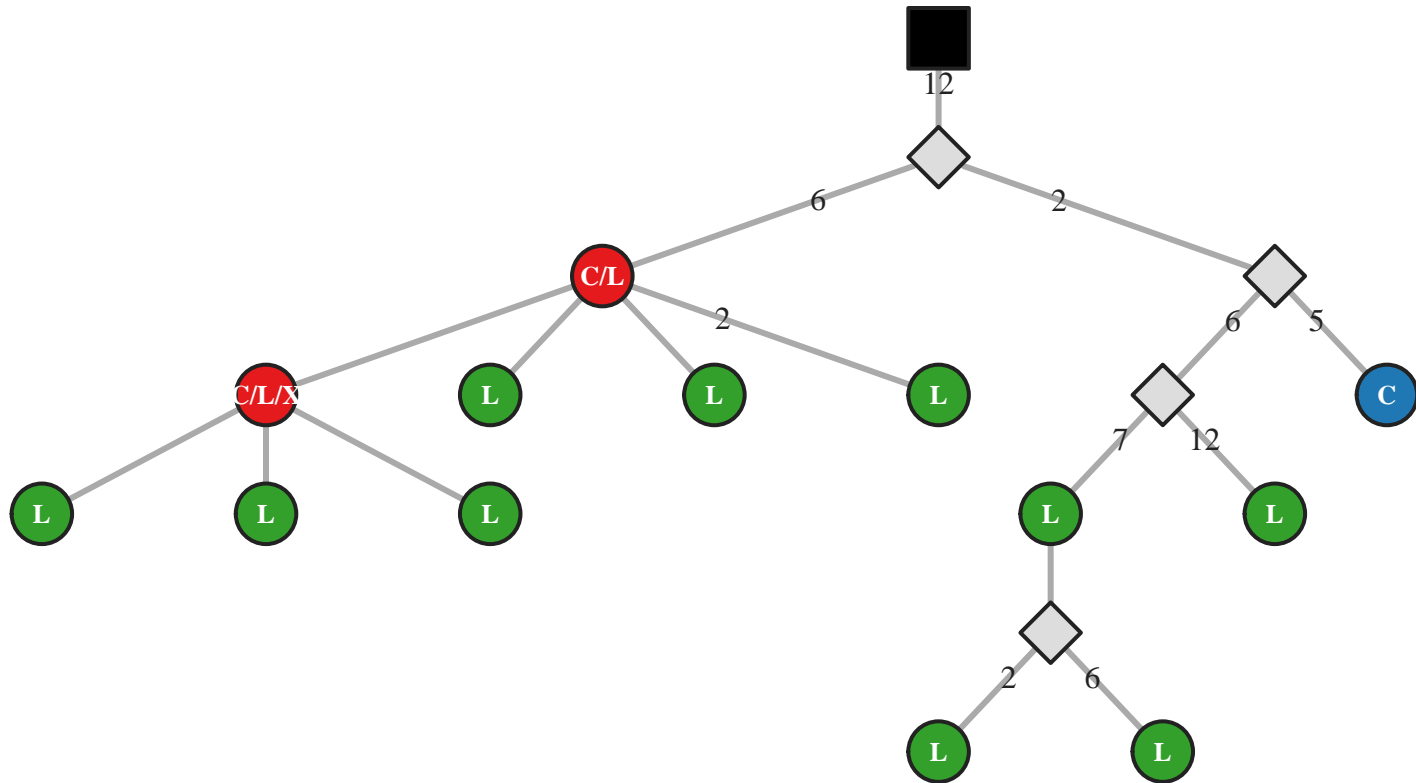

M5 IgG IGHV3-7/J6 66bp (8905)

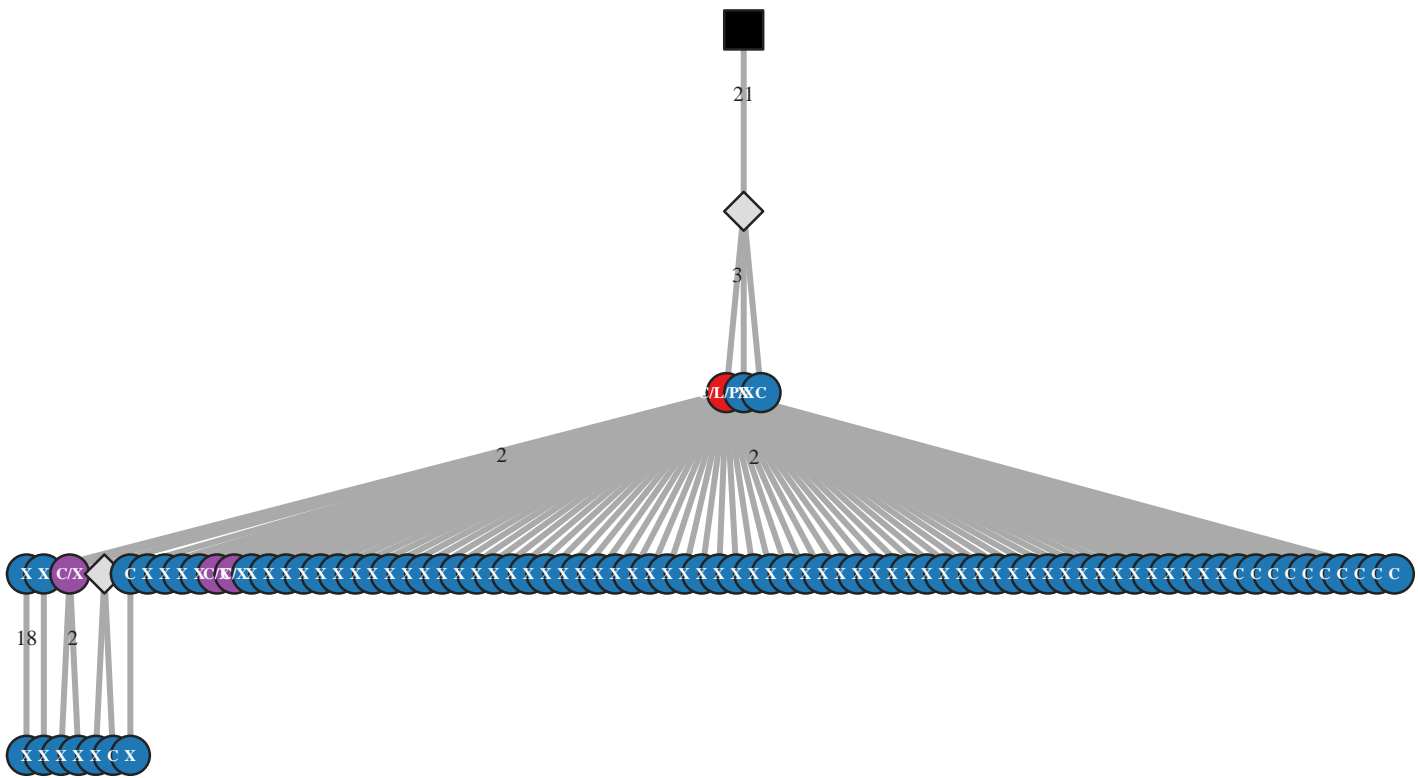

M5 IgG IGHV3-72/J3 24bp (27053)

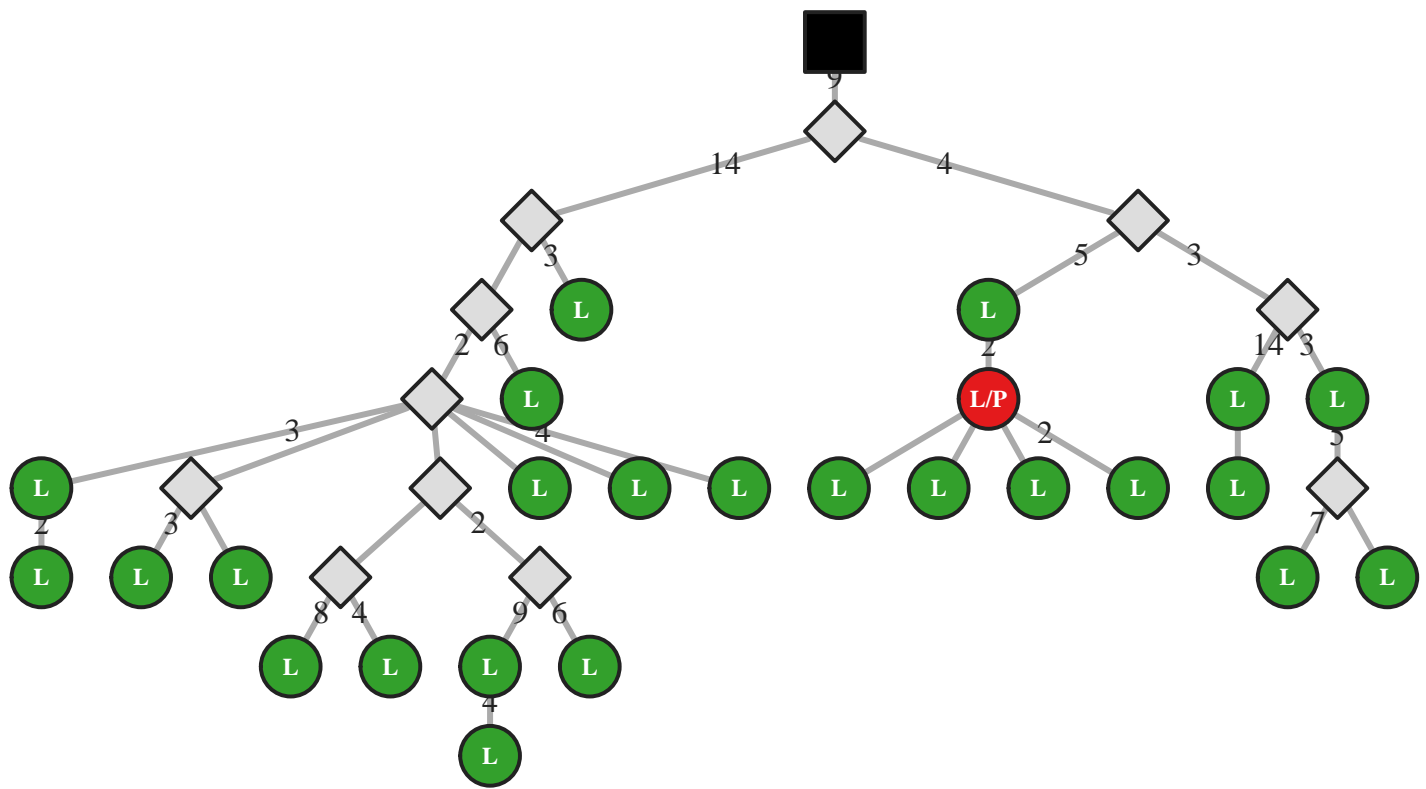

M5 IgG IGHV3-72/J4 24bp (35471)

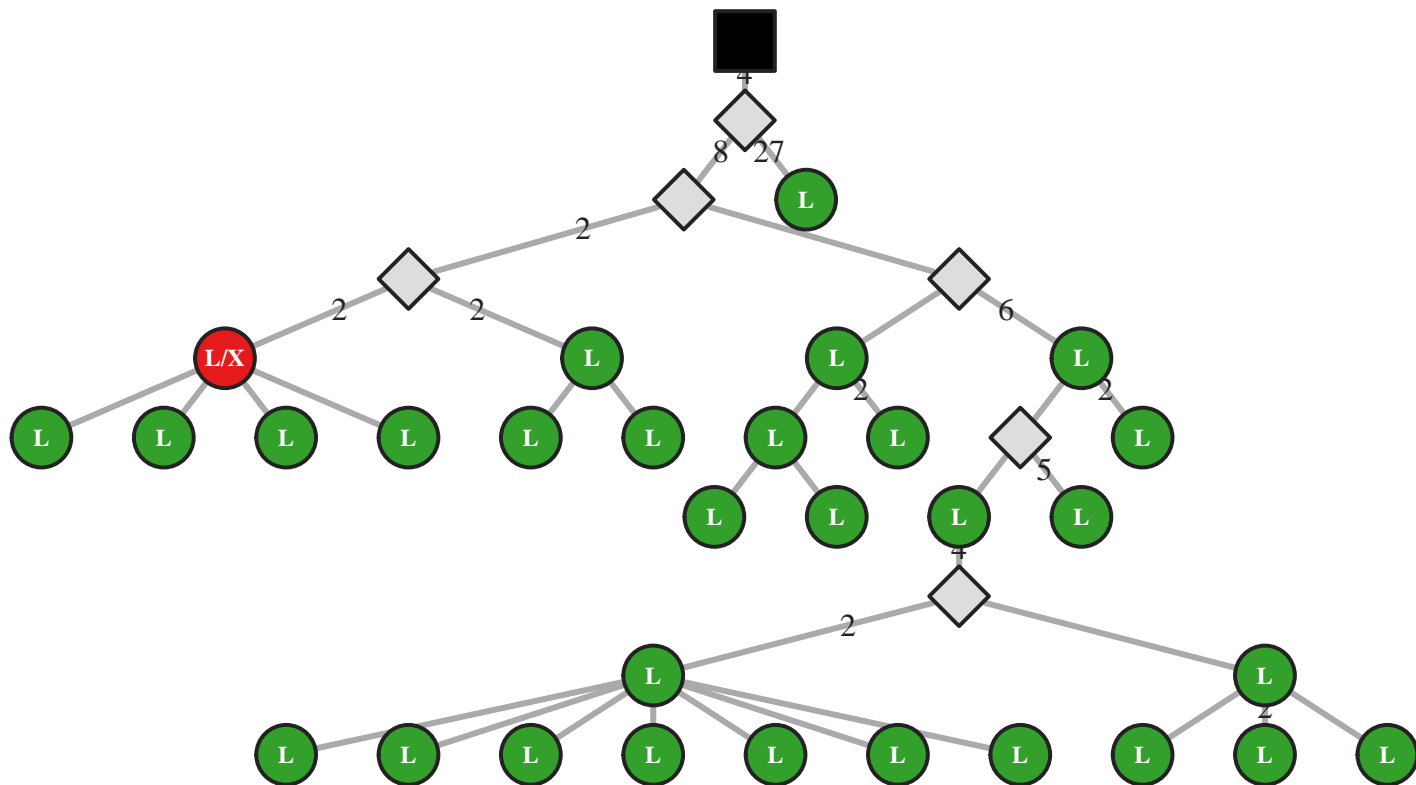

M5 IgG IGHV3-72/J4 30bp (45419)

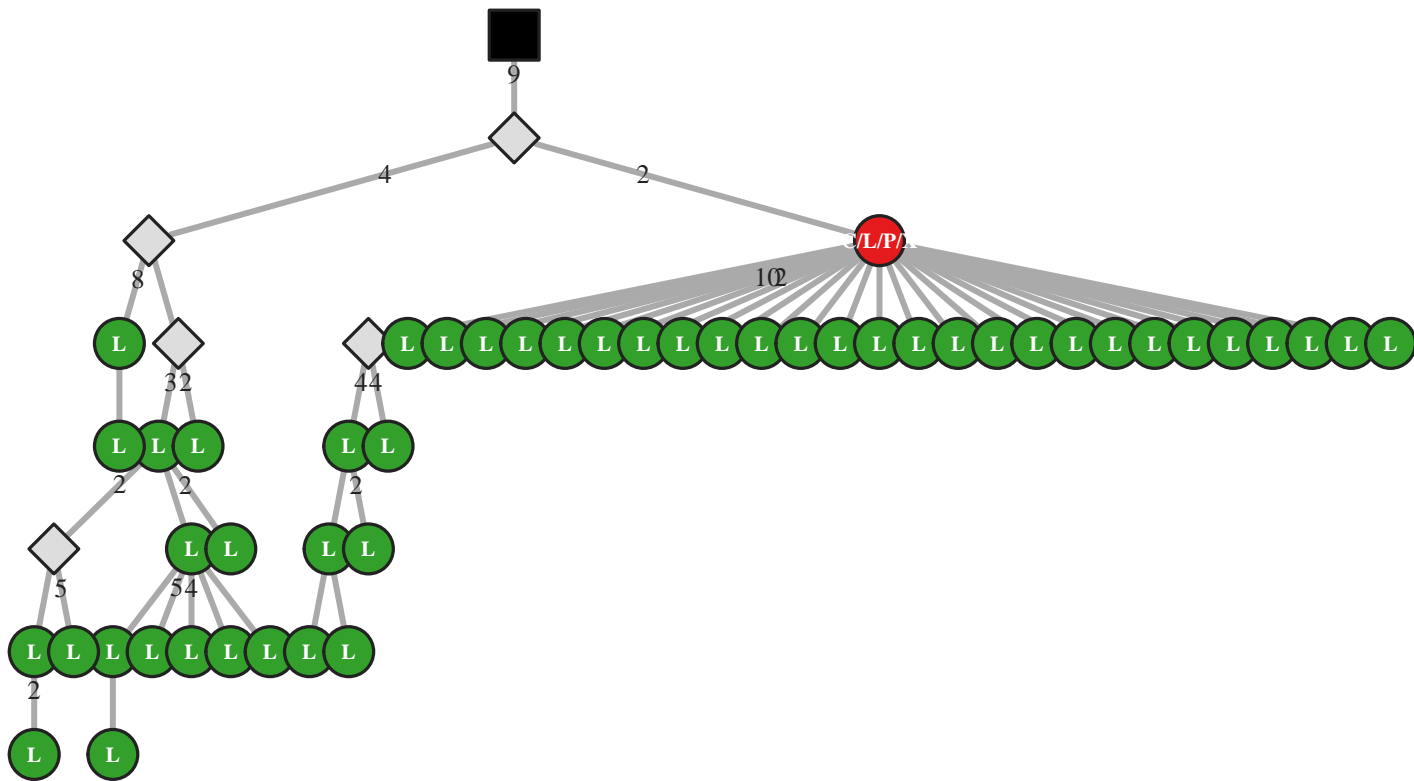

M5 IgG IGHV3-72/J4 36bp (52175)

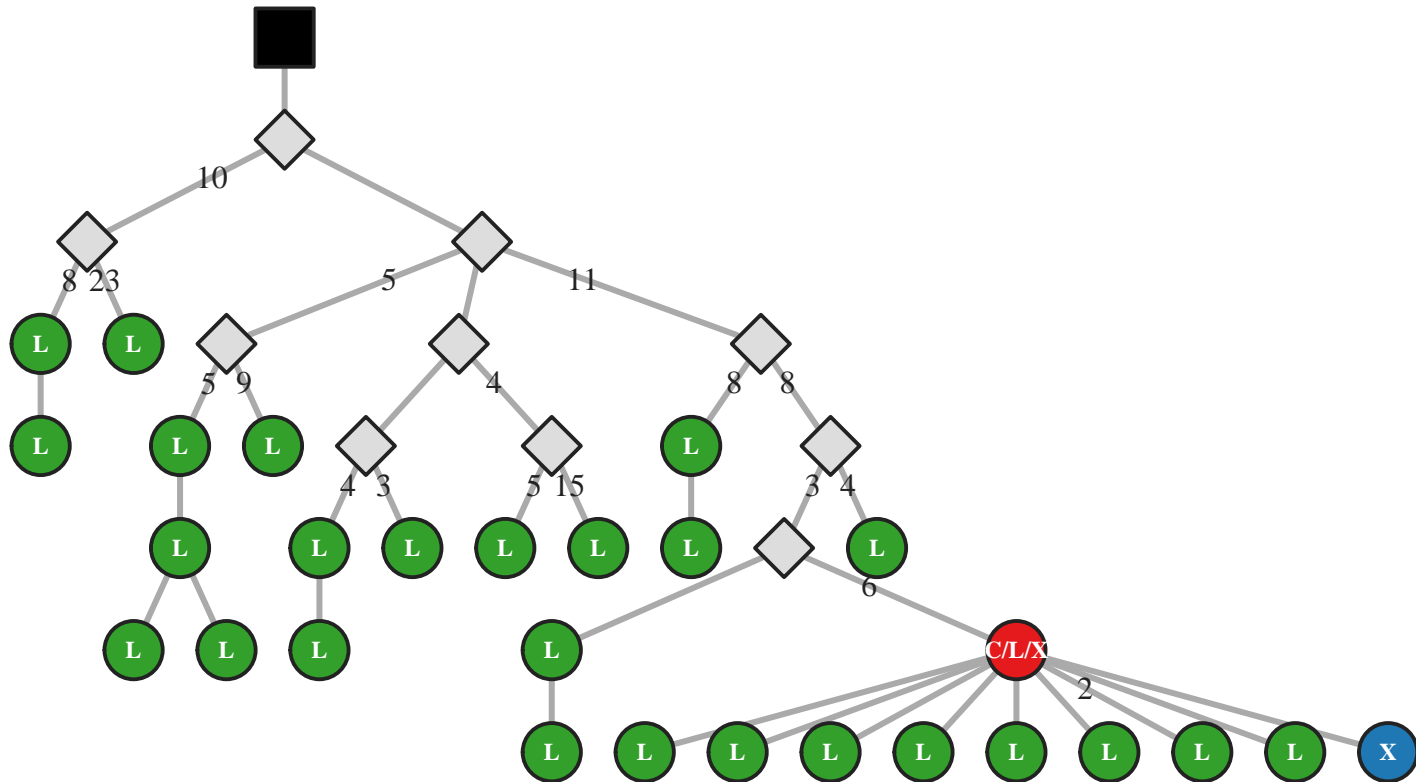

M5 IgM IGHV3-72/J4 51bp (54213)

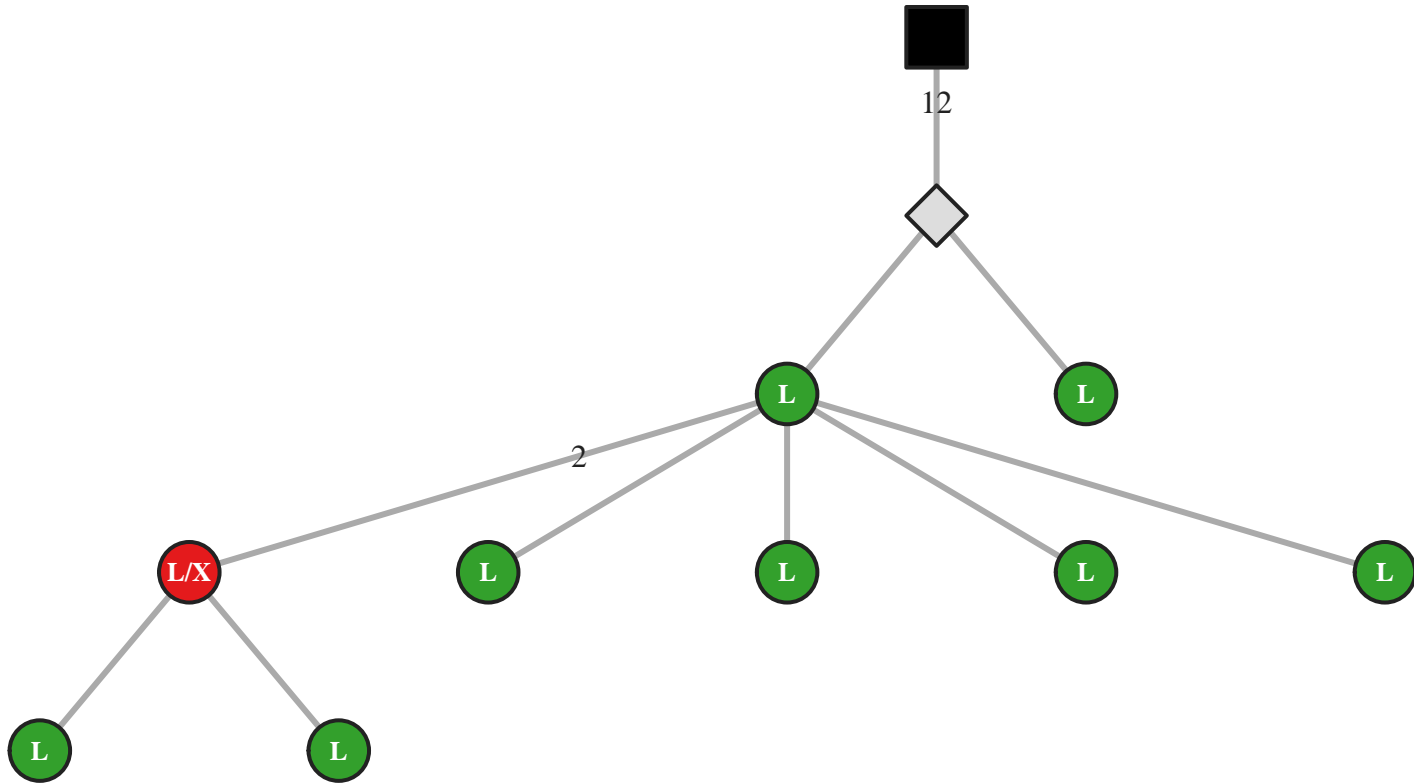

M5 IgG IGHV3-72/J6 33bp (35505)

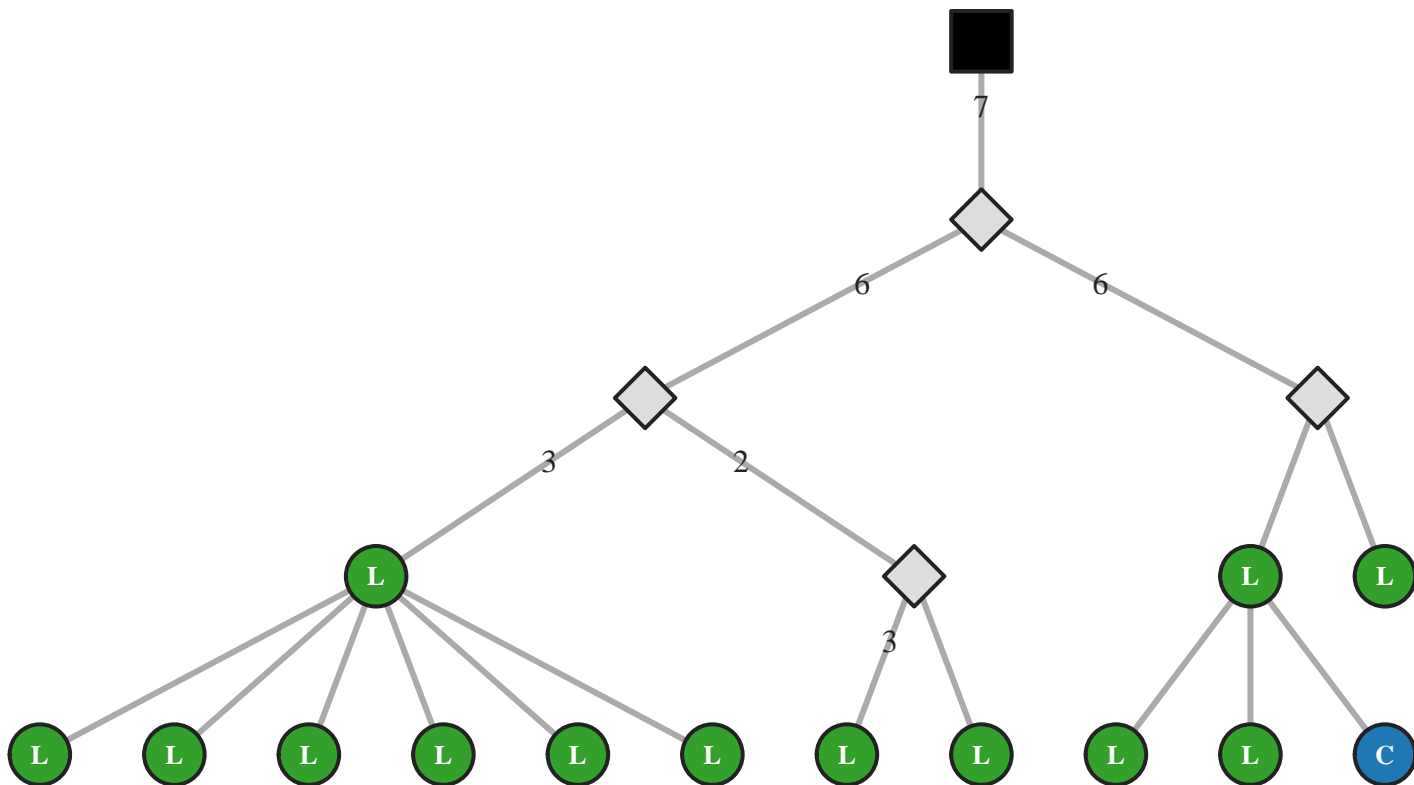

M5 IgG IGHV3-72/J6 54bp (8536)

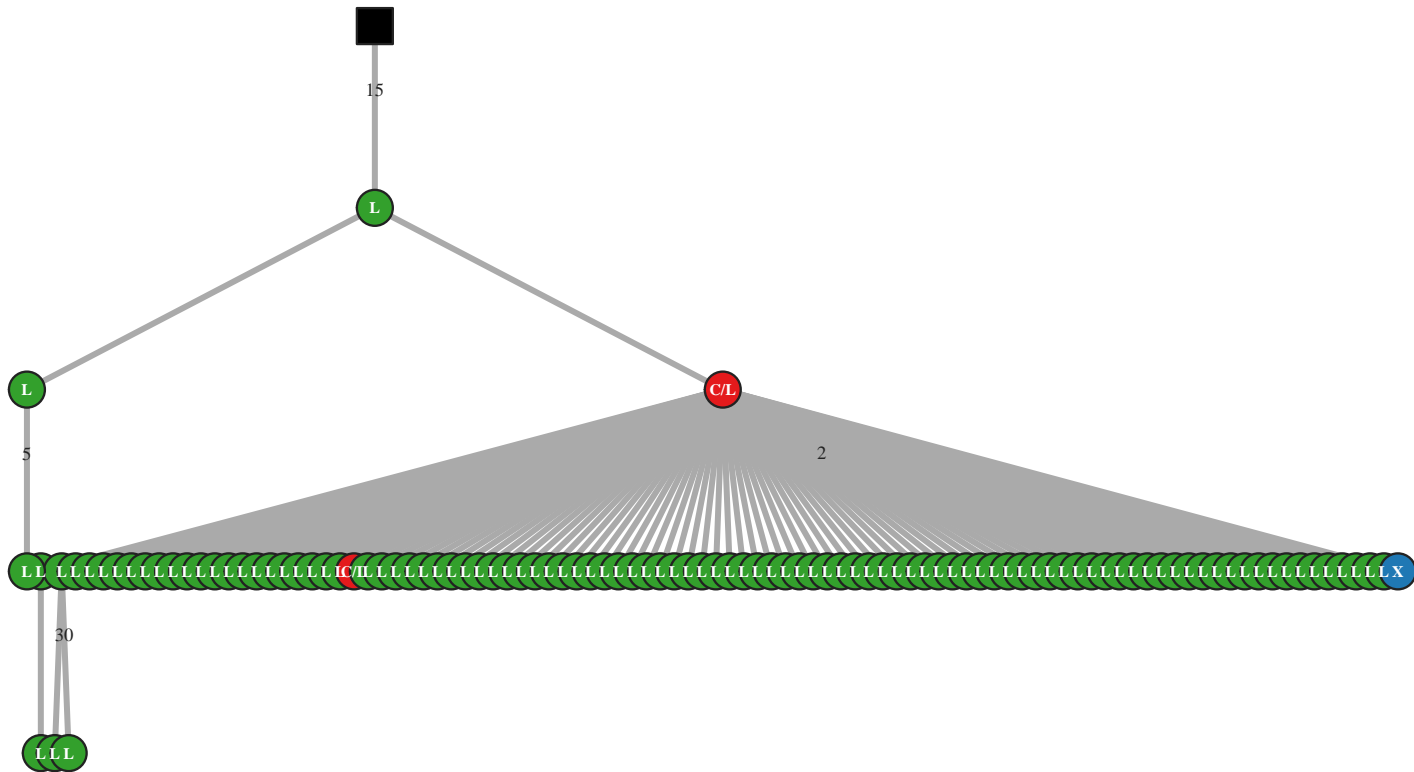

M5 IgG IGHV3-73/J3 24bp (35510)

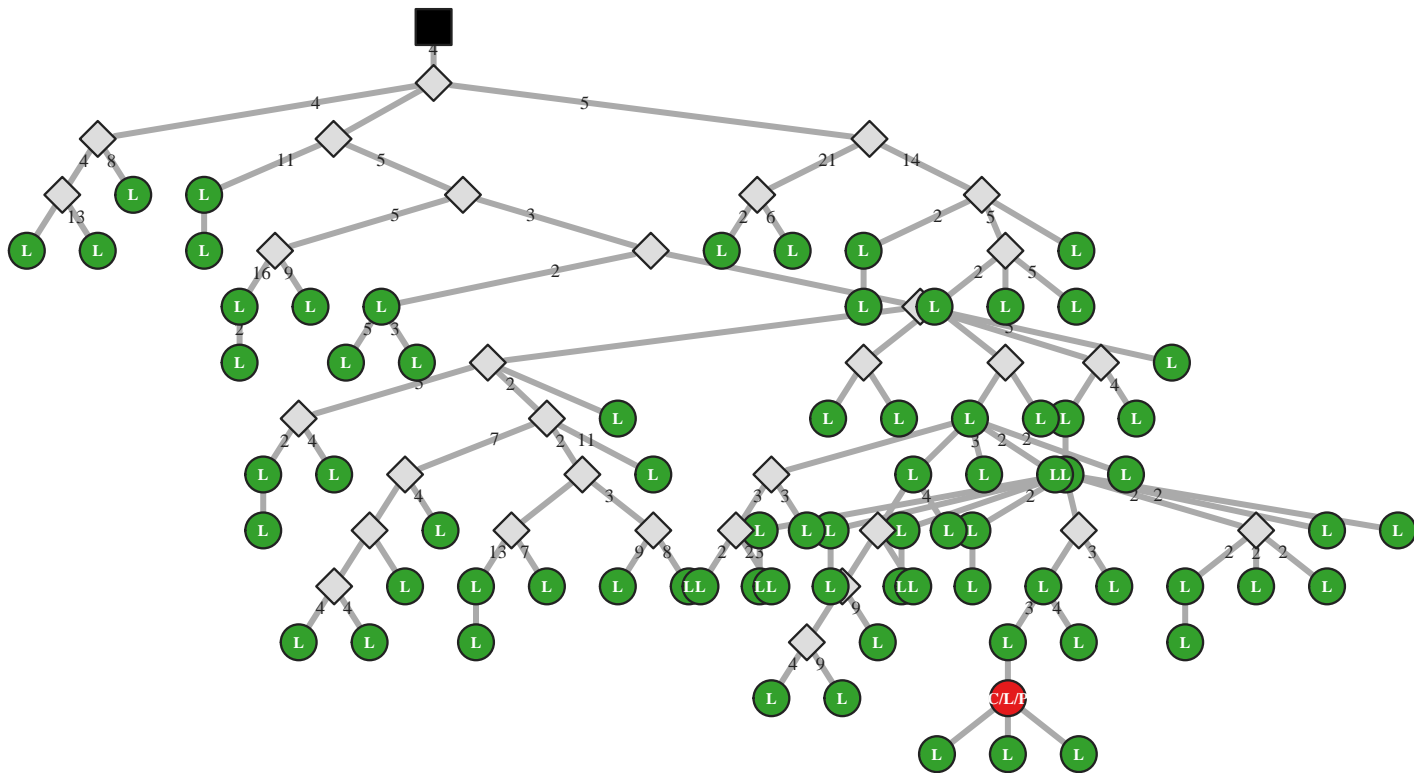

M5 IgG IGHV3-73/J3 39bp (45433)

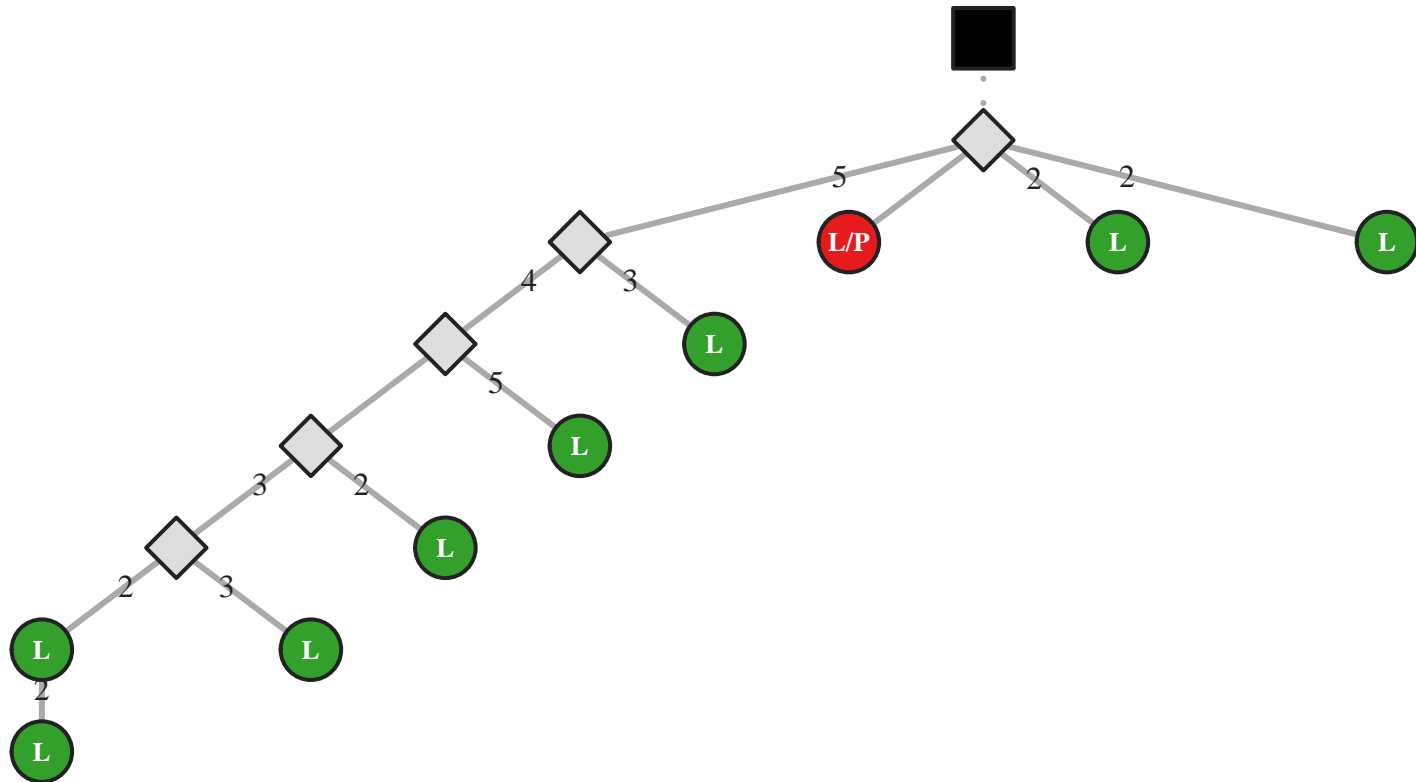

M5 IgG IGHV3-73/J4 24bp (45440)

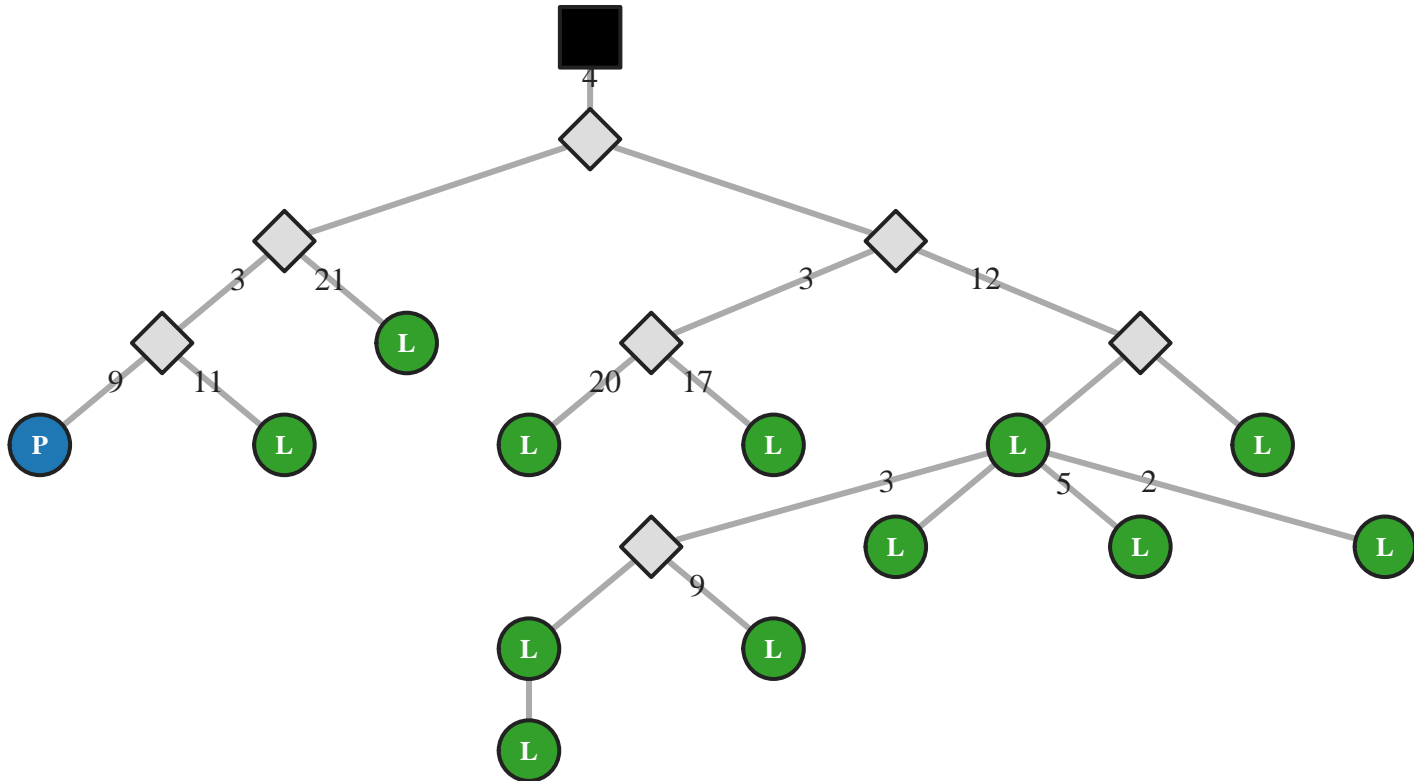

M5 IgA IGHV3-73/J5 45bp (12534)

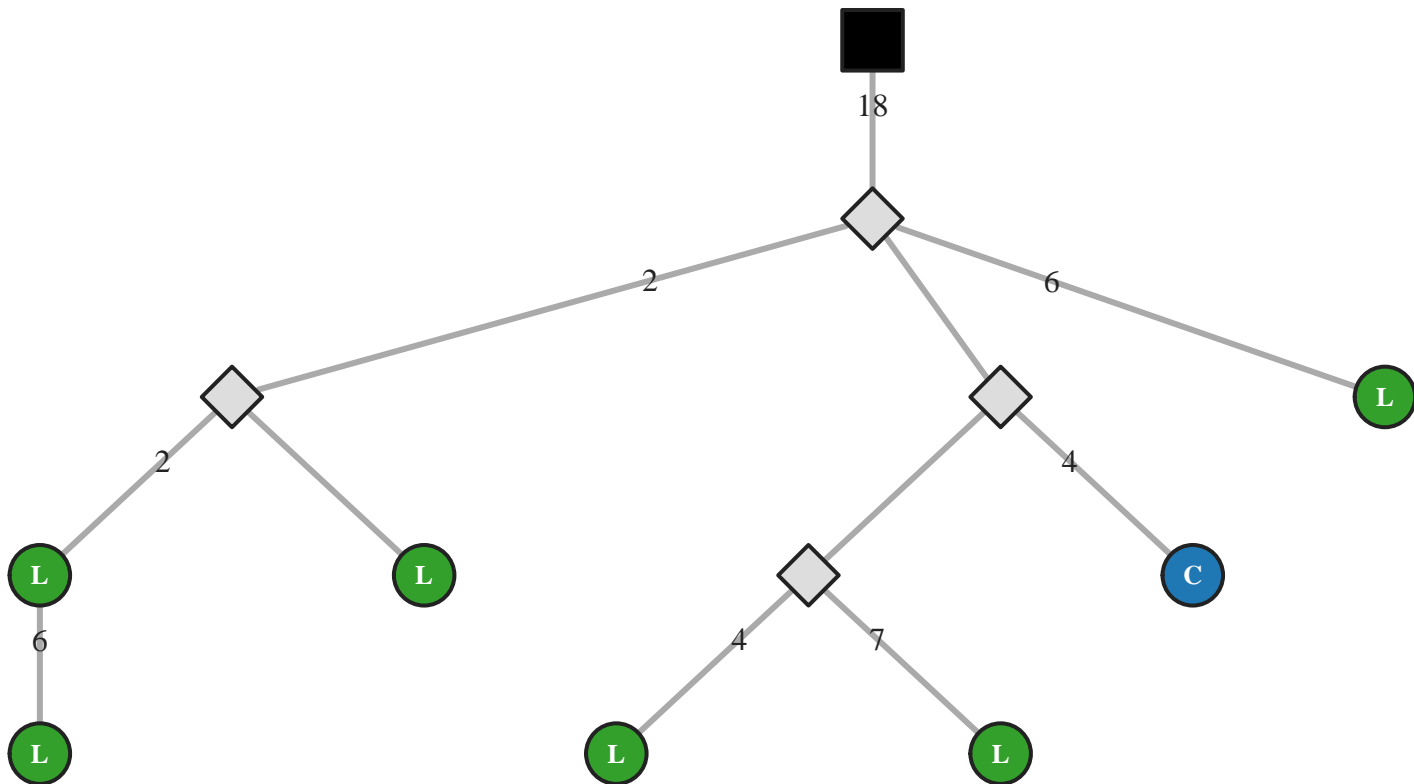

M5 IgG IGHV3-73/J5 48bp (18100)

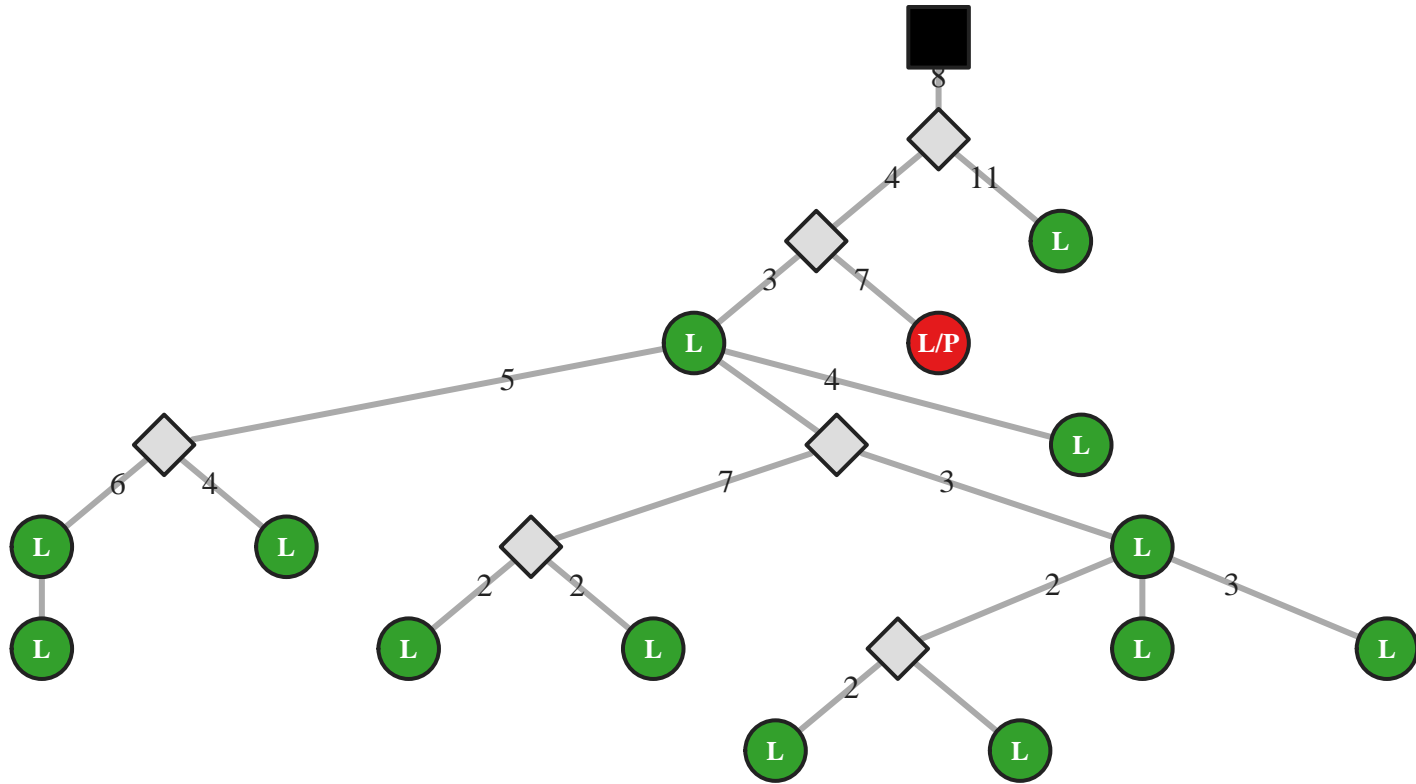

M5 IgG IGHV3-73/J5 51bp (8555)

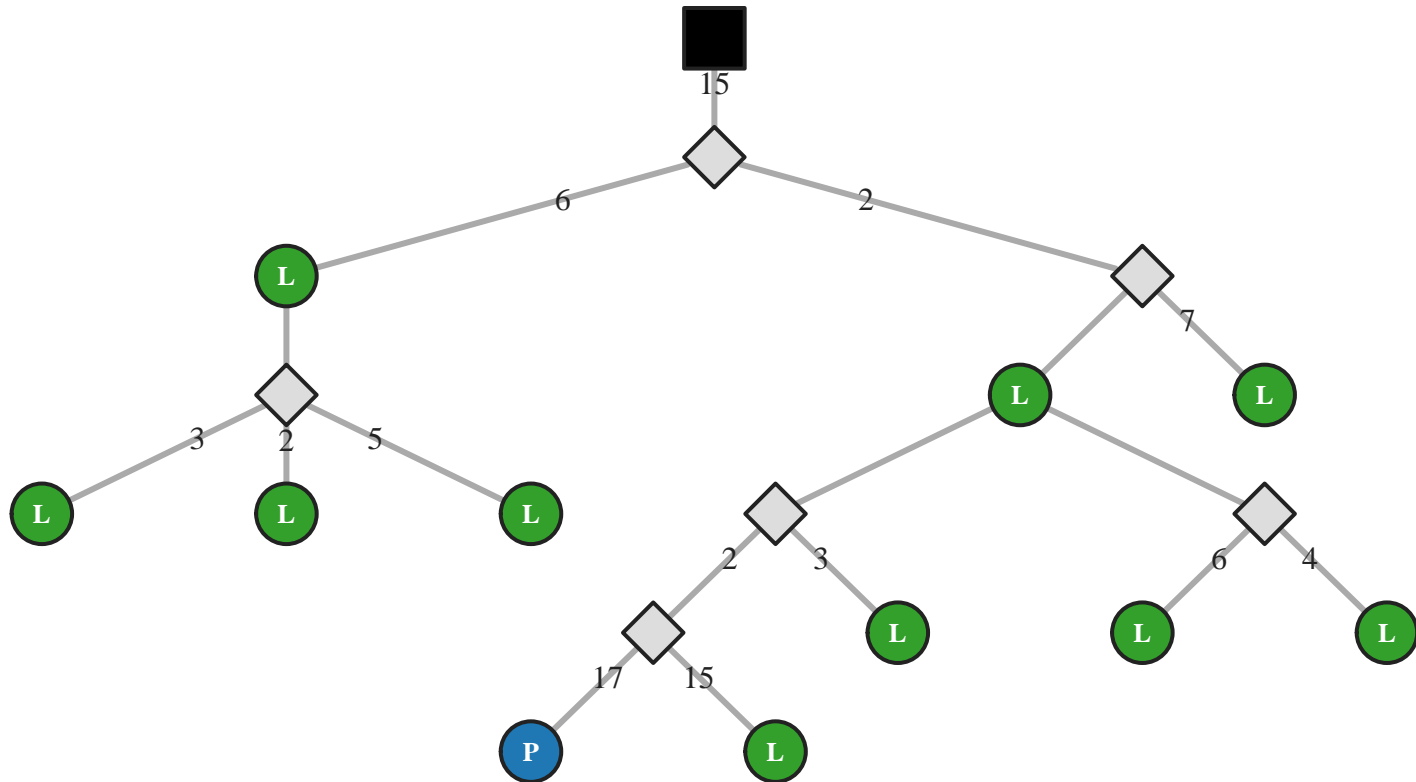

M5 IgG IGHV3-74/J1 27bp (18216)

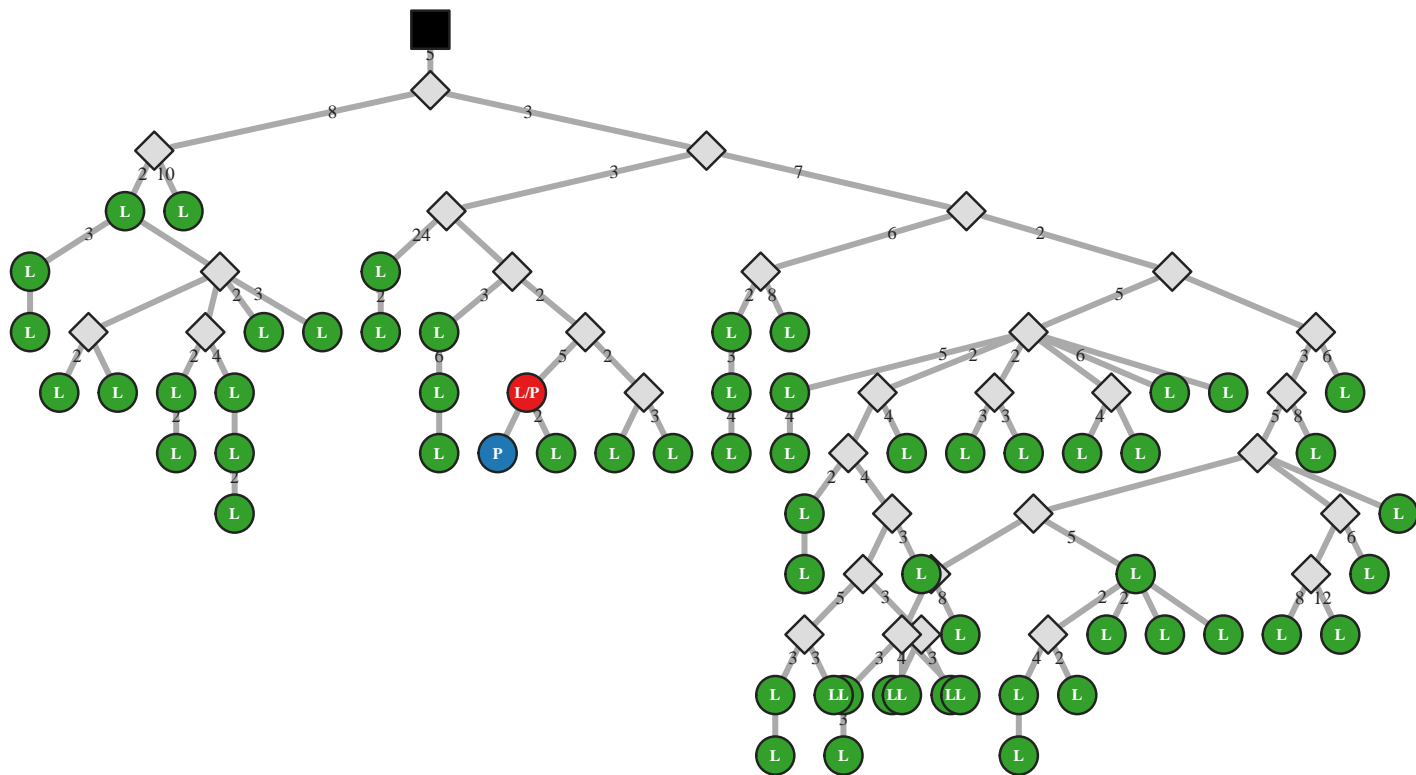

M5 IgM IGHV3-74/J2 36bp (37920)

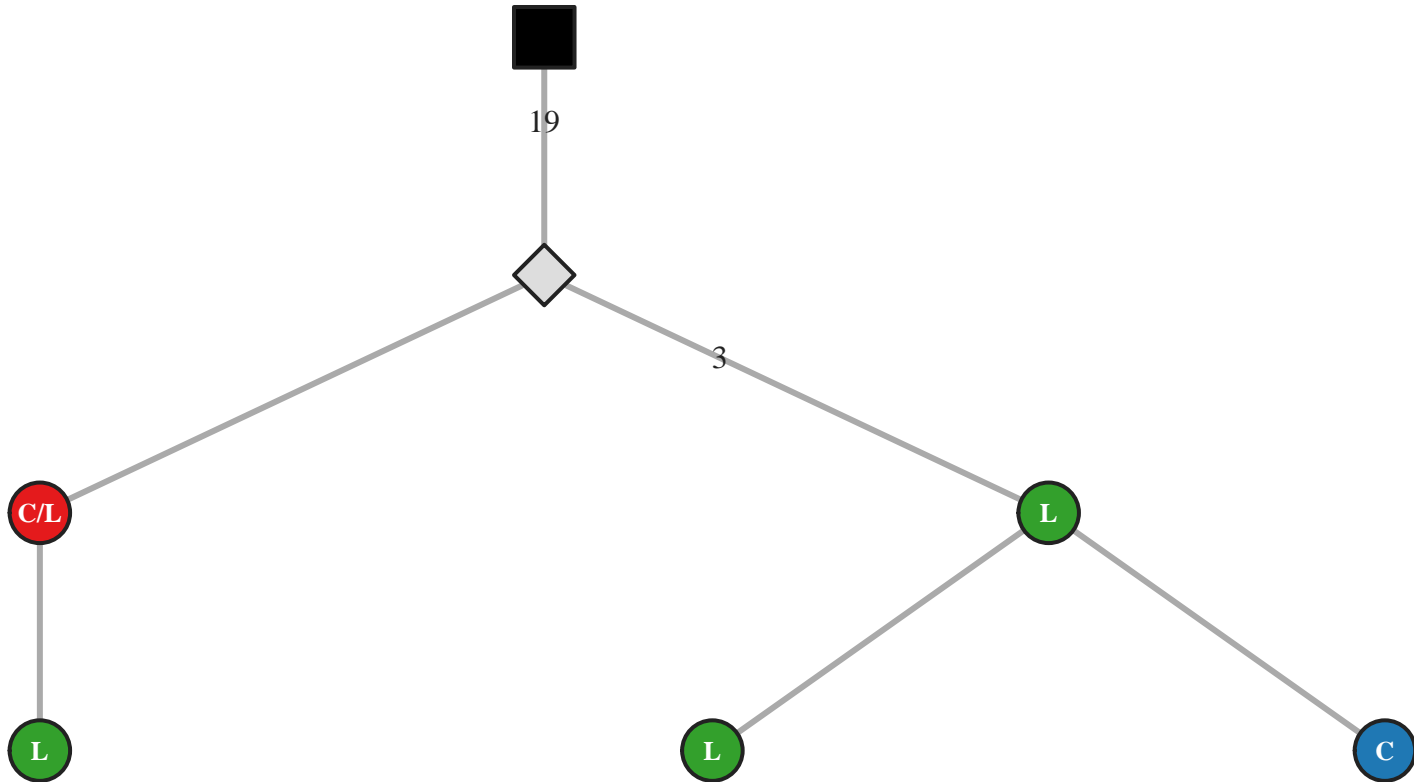

M5 IgM IGHV3-74/J3 45bp (20863)

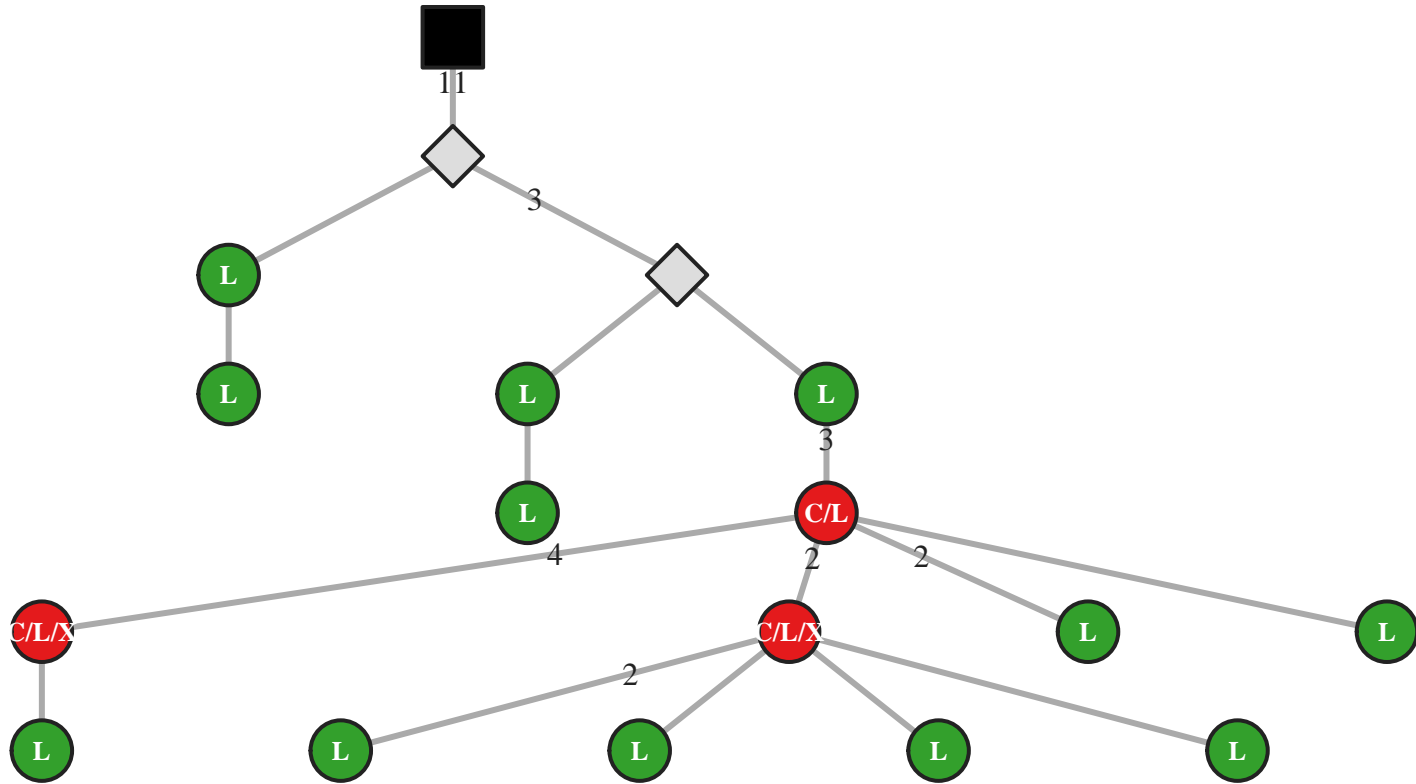

M5 IgA IGHV3-74/J3 48bp (12540)

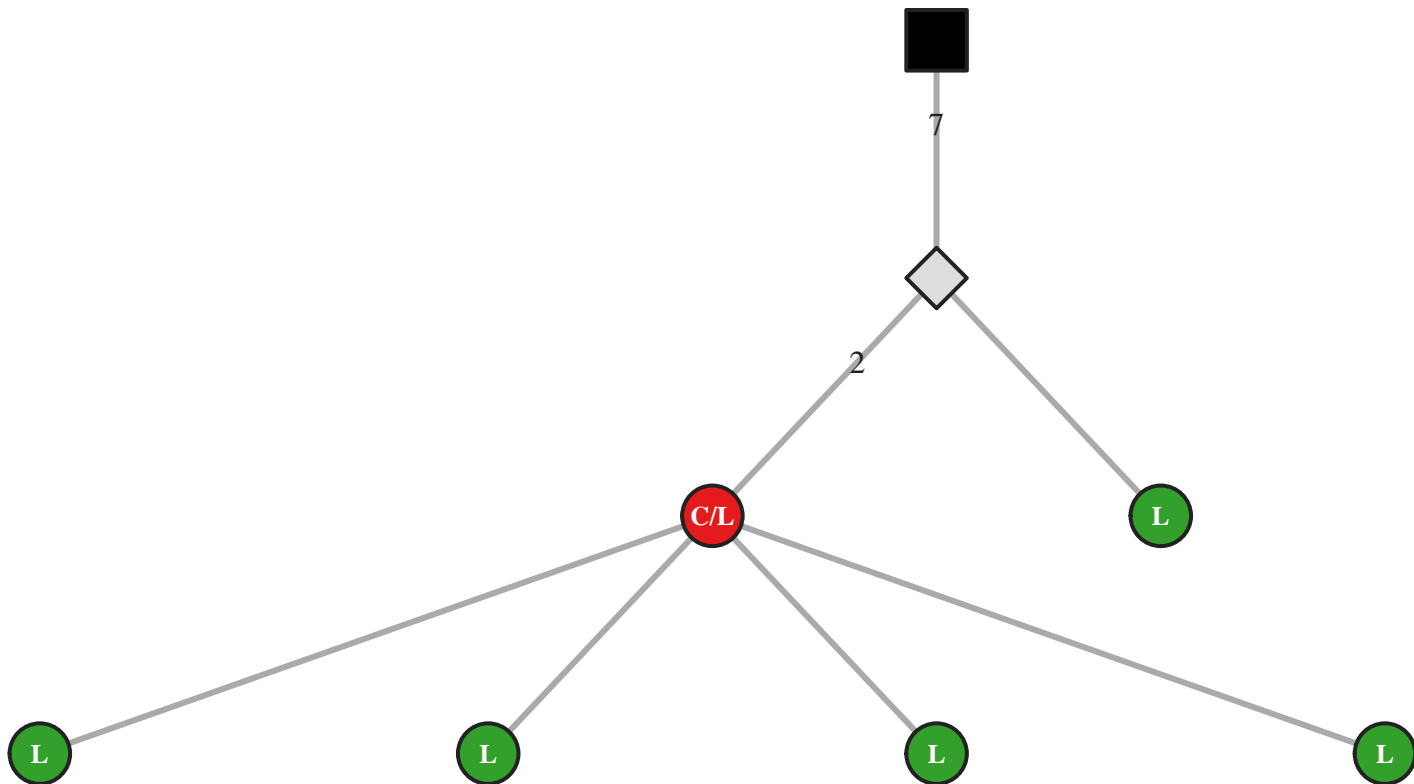

M5 IgG IGHV3-74/J3 48bp (35542)

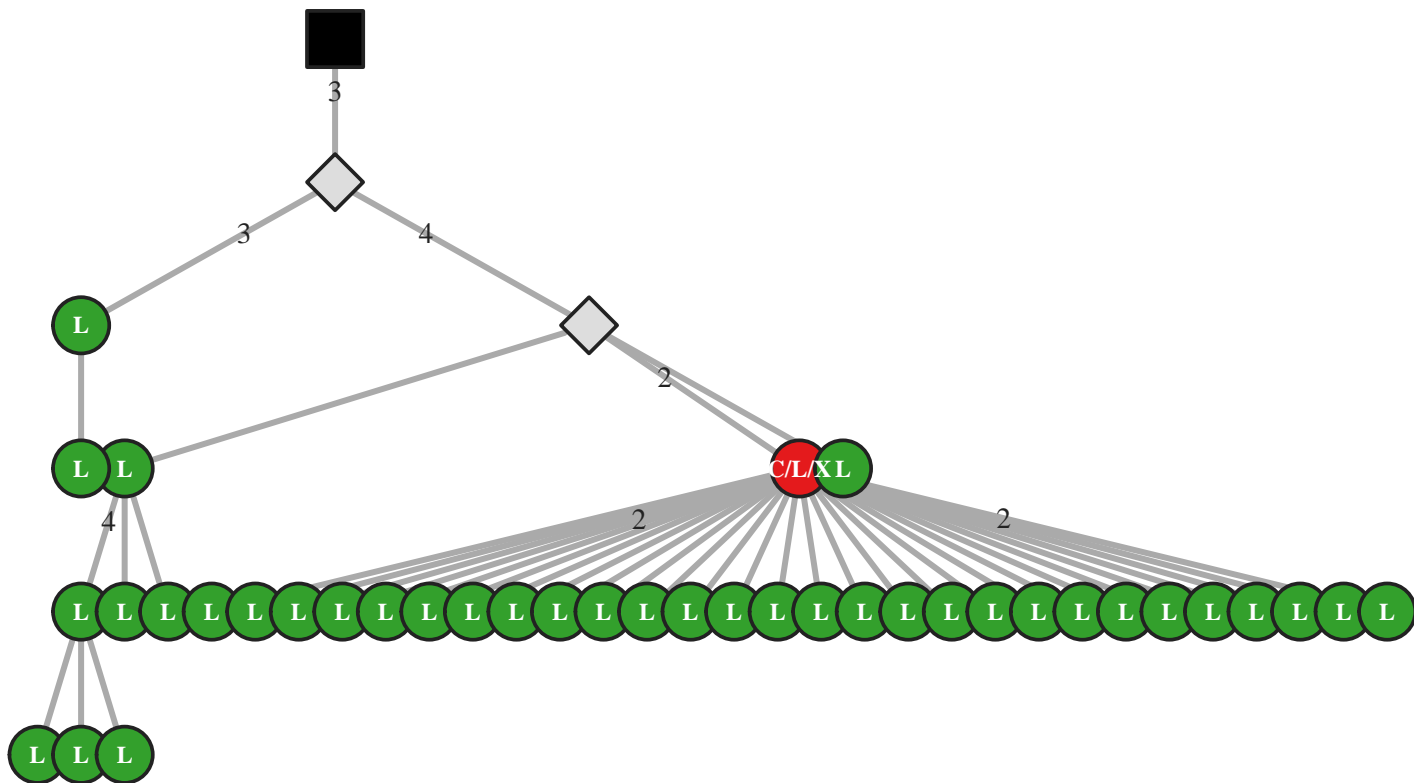

M5 IgG IGHV3-74/J3 60bp (52217)

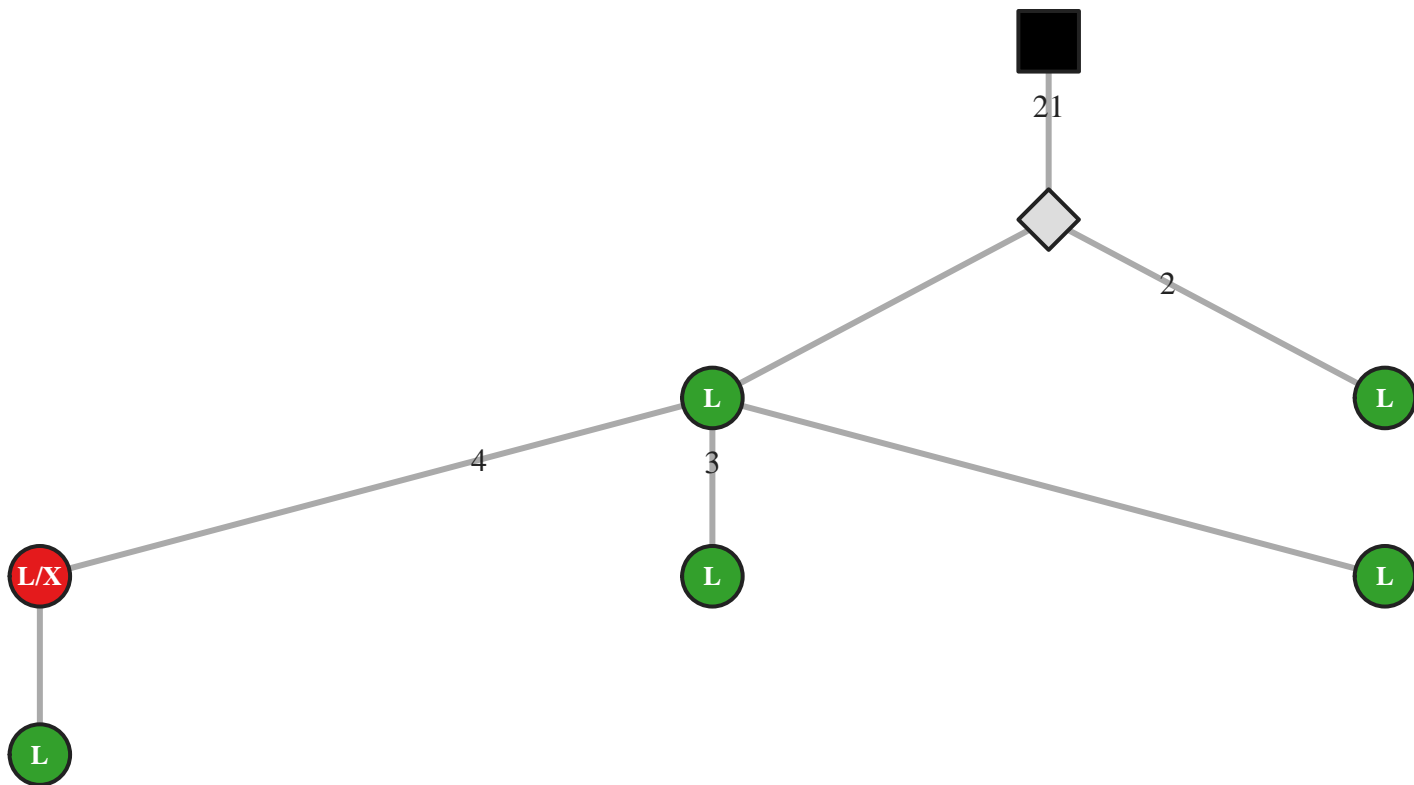

M5 IgG IGHV3-74/J4 30bp (27108)

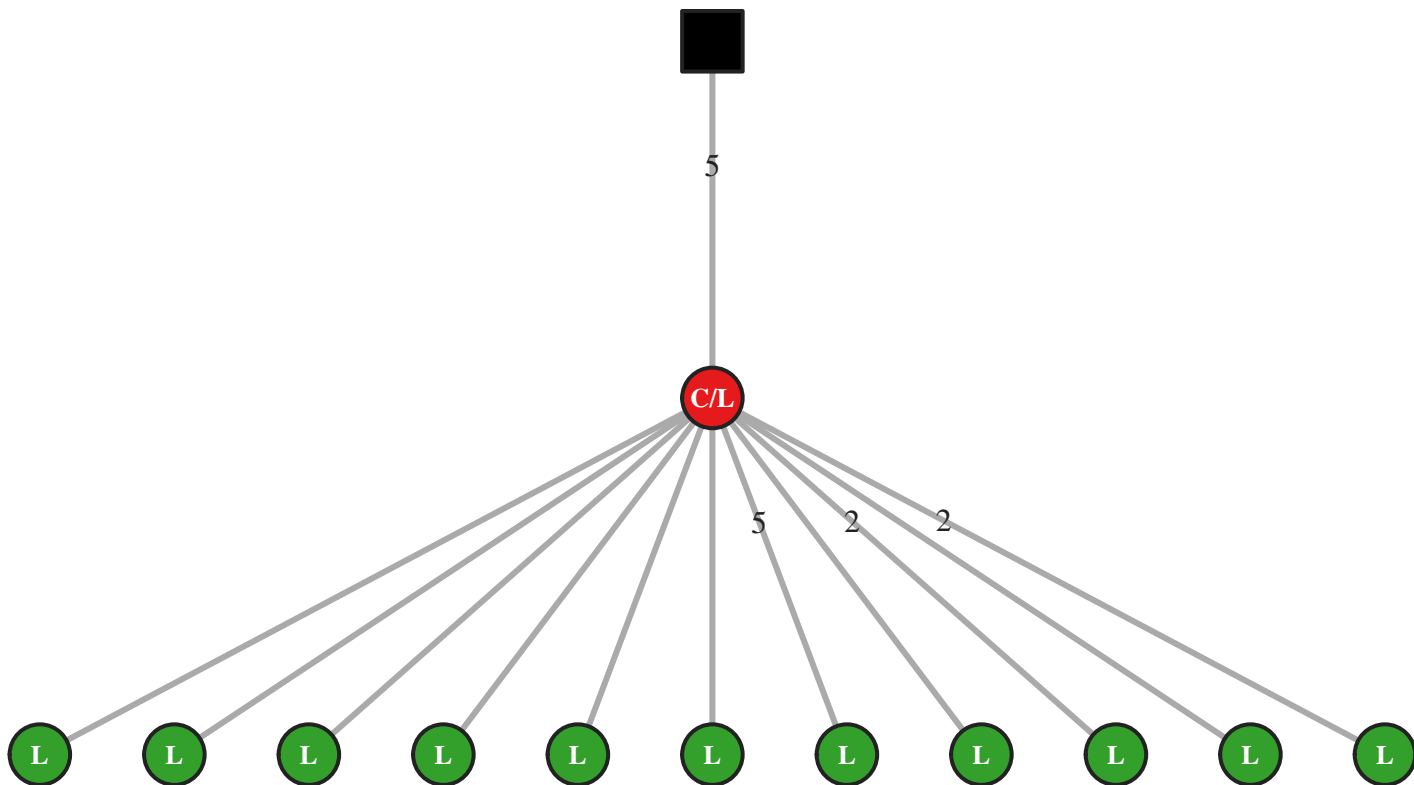

M5 IgG IGHV3-74/J4 33bp (35568)

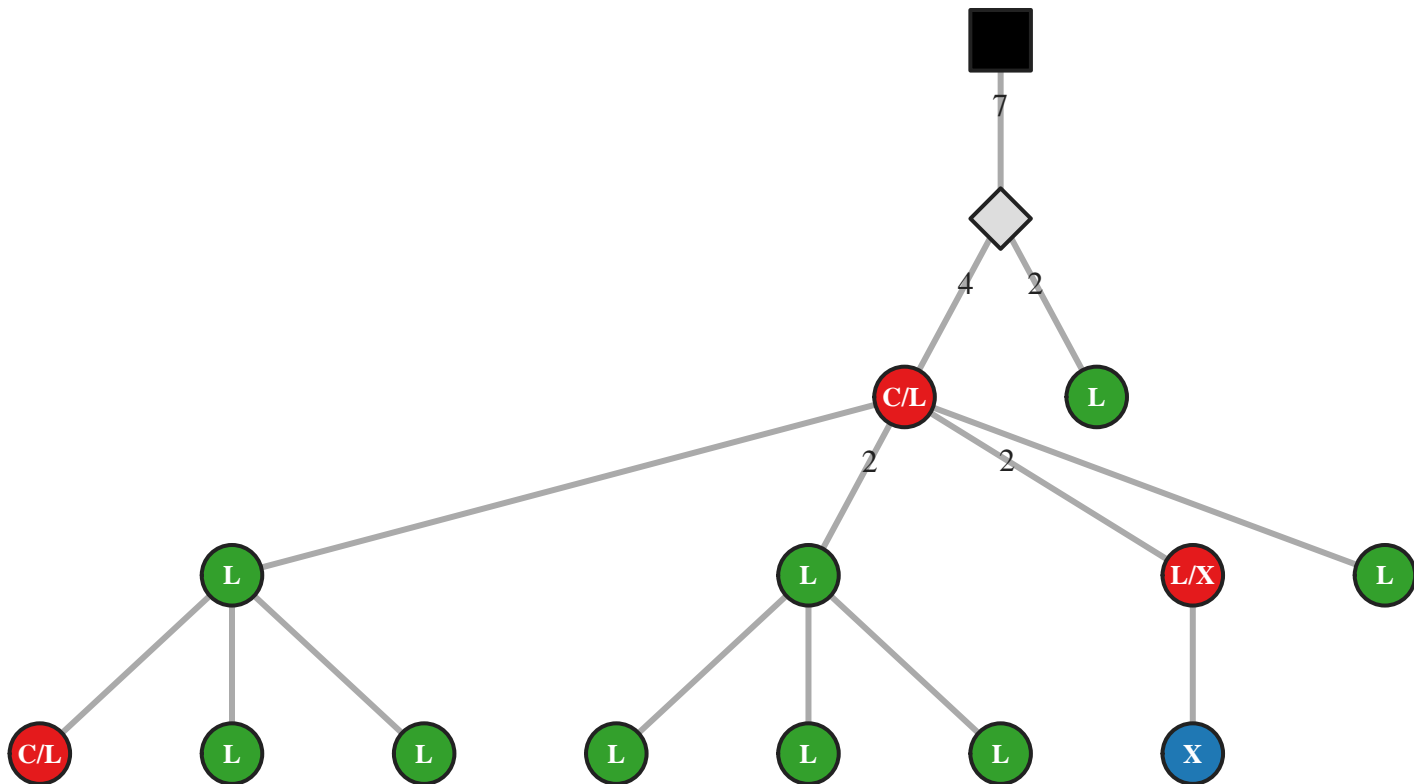

M5 IgA IGHV3-74/J4 36bp (30664)

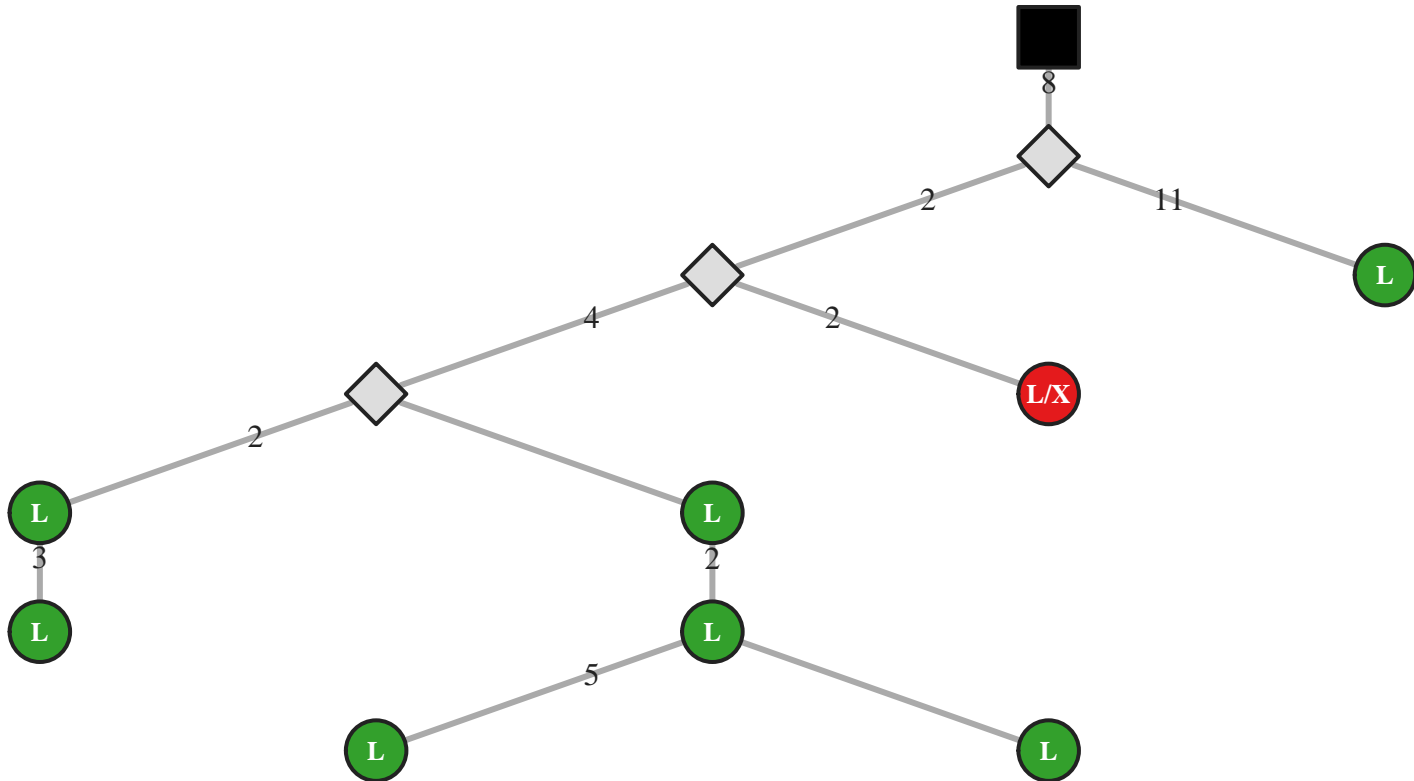

M5 IgG IGHV3-74/J4 36bp (18134)

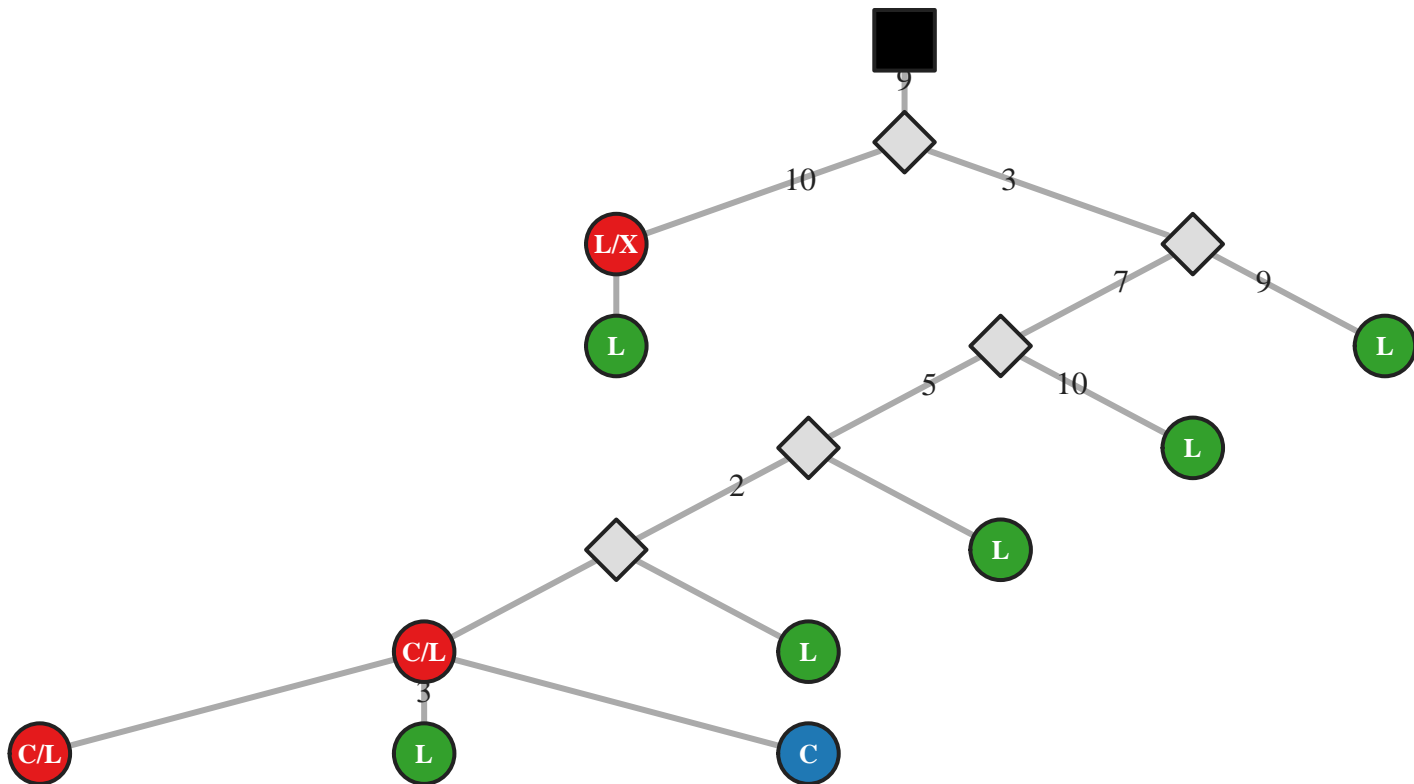

M5 IgG IGHV3-74/J4 36bp (18138)

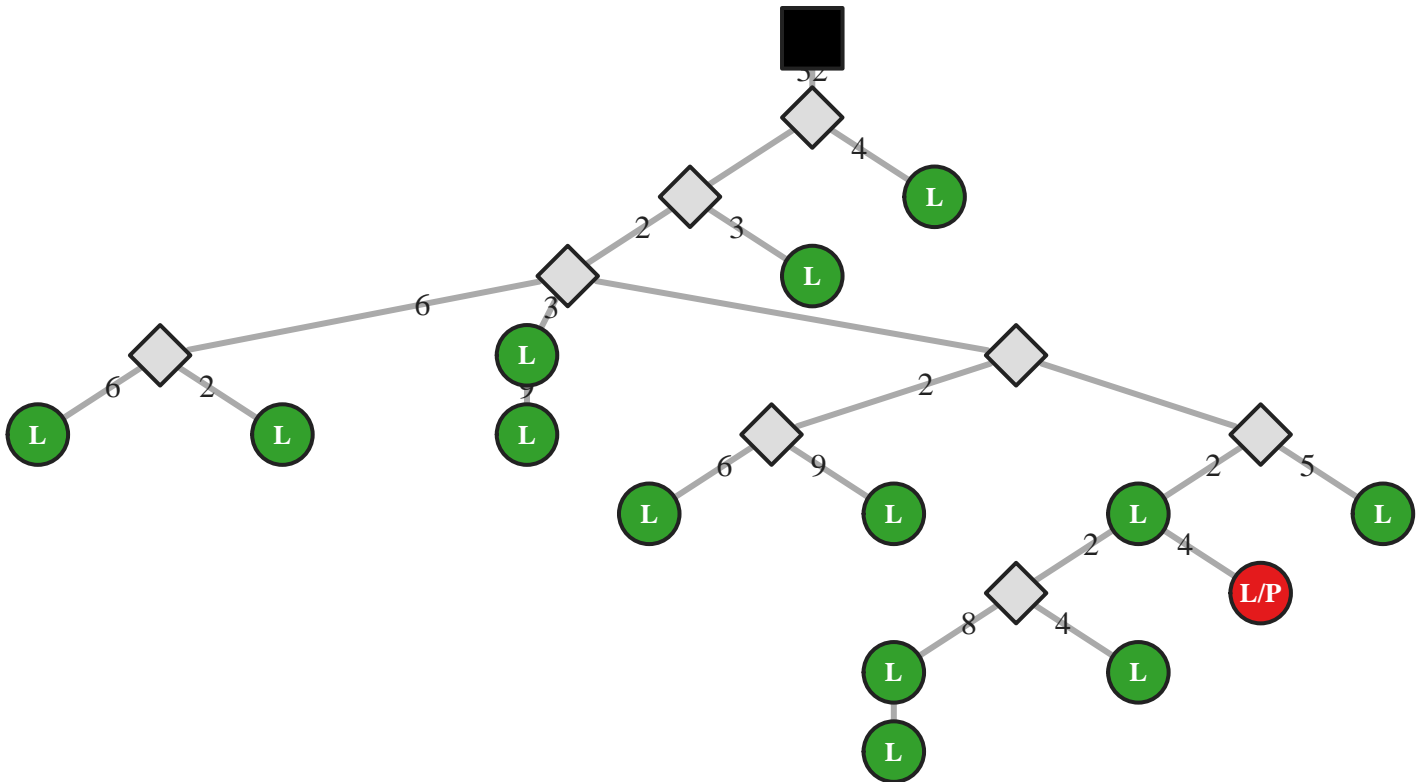

M5 IgG IGHV3-74/J4 36bp (18164)

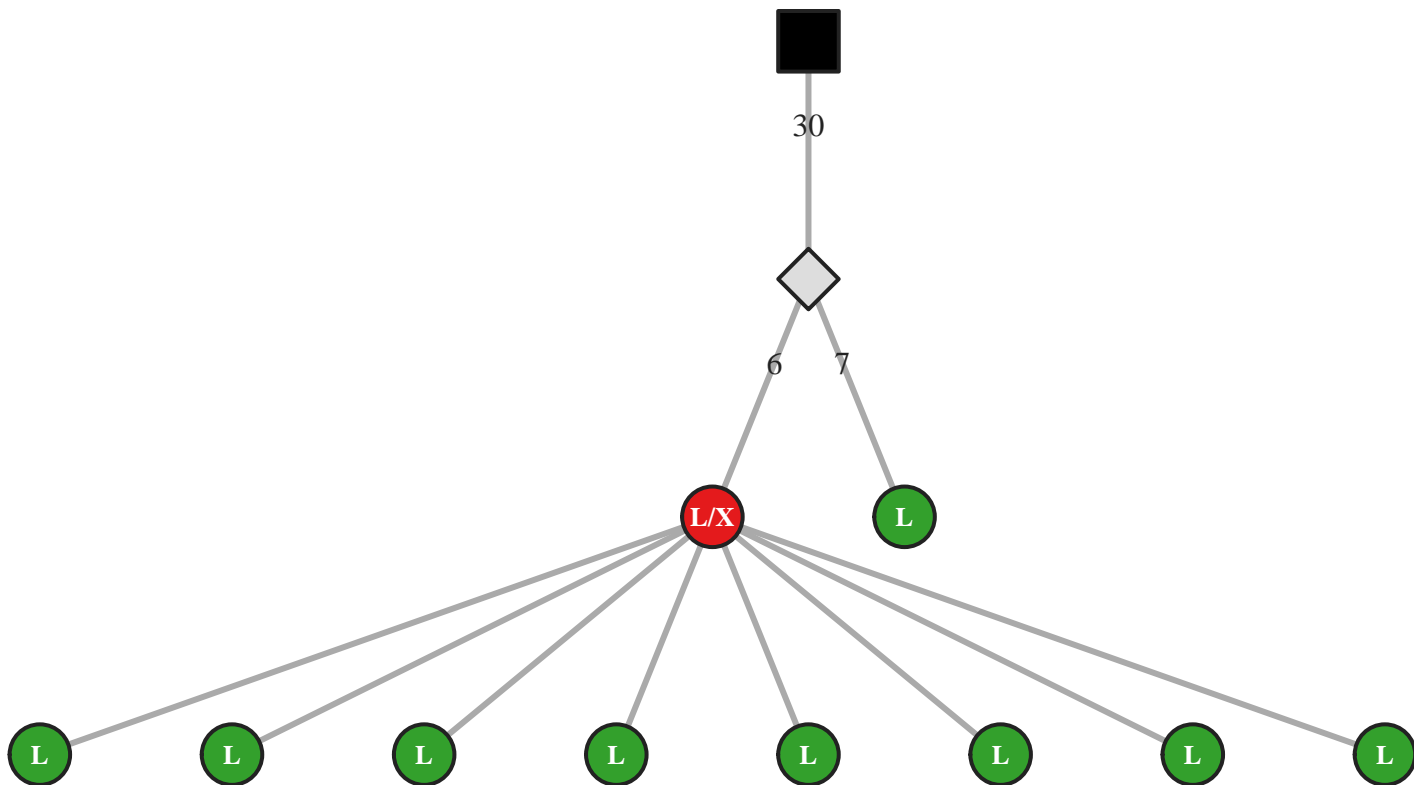

M5 IgG IGHV3-74/J4 36bp (18170)

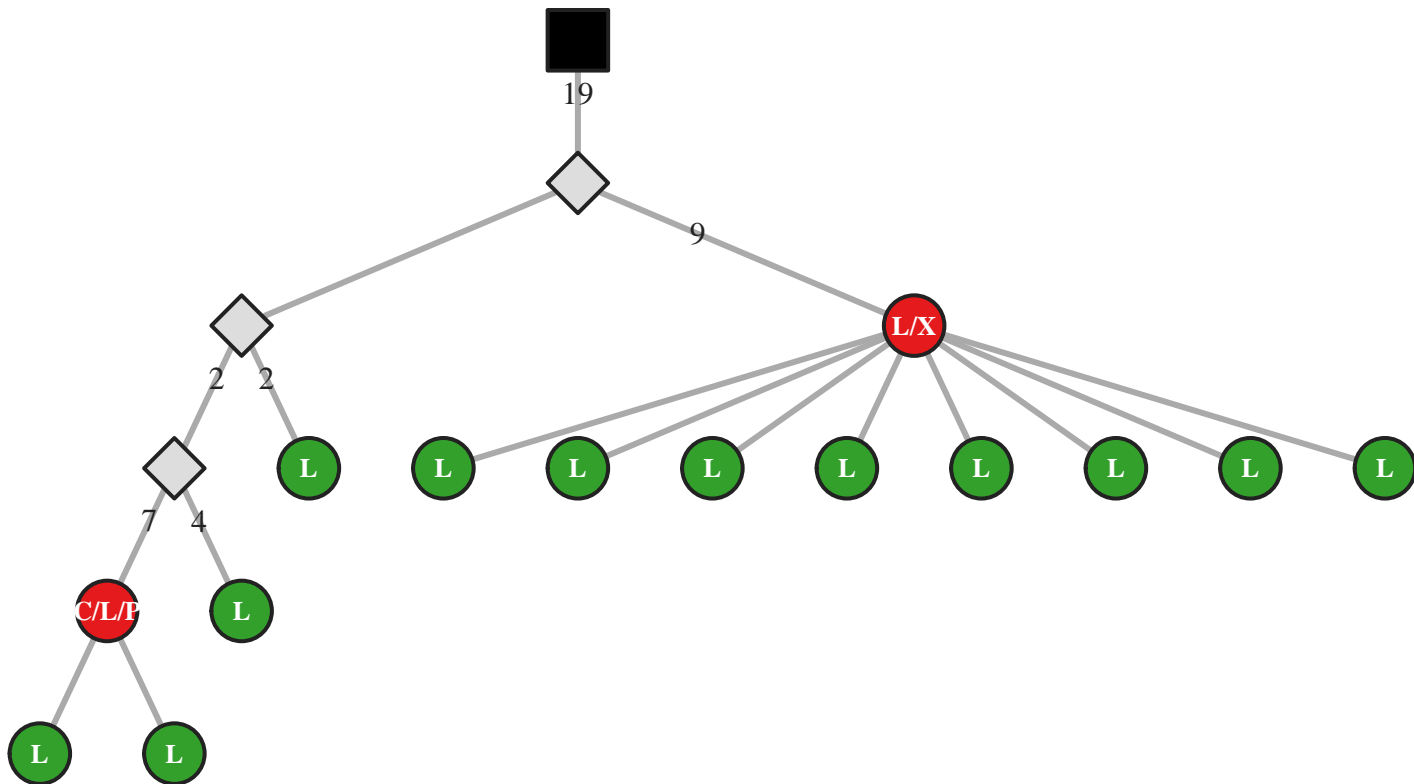

M5 IgG IGHV3-74/J4 36bp (18173)

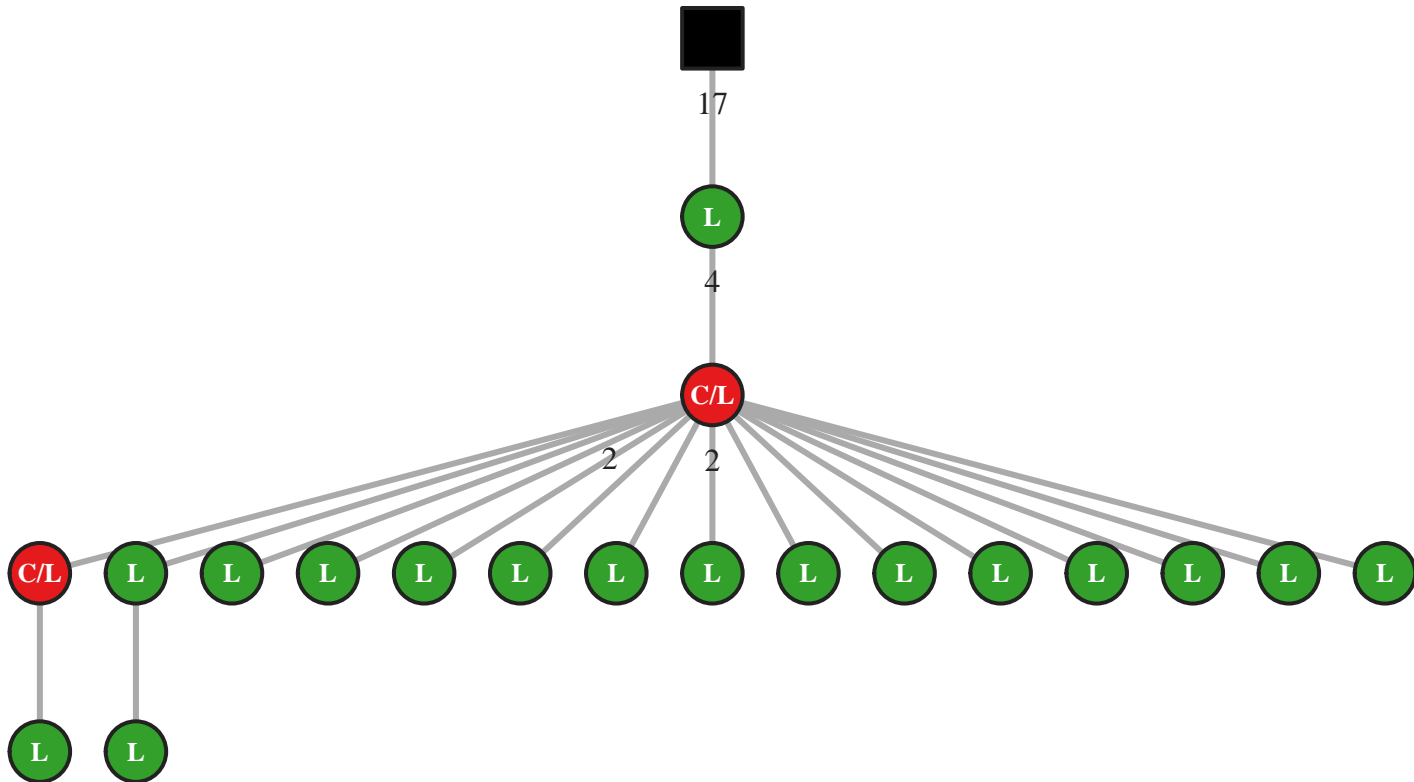

M5 IgG IGHV3-74/J4 36bp (18182)

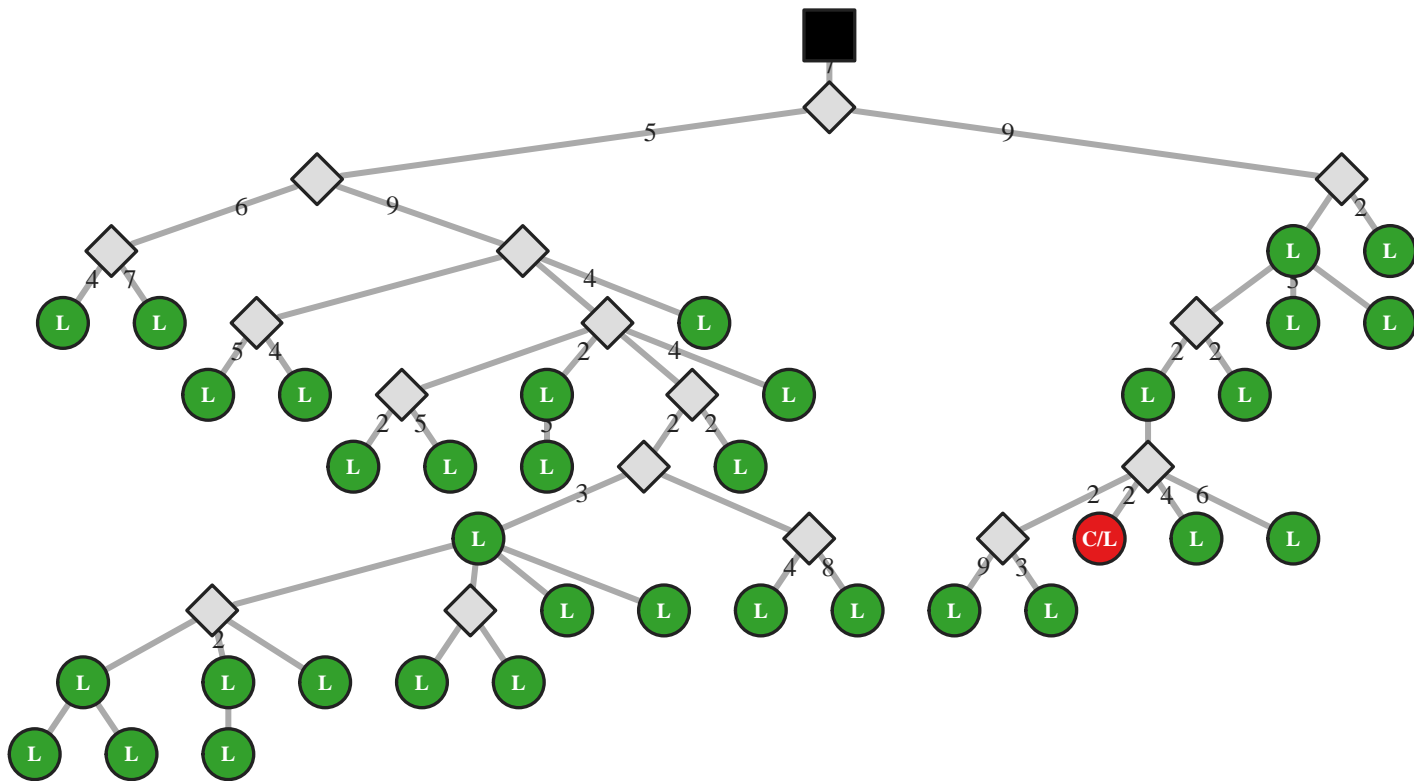

M5 IgG IGHV3-74/J4 36bp (18185)

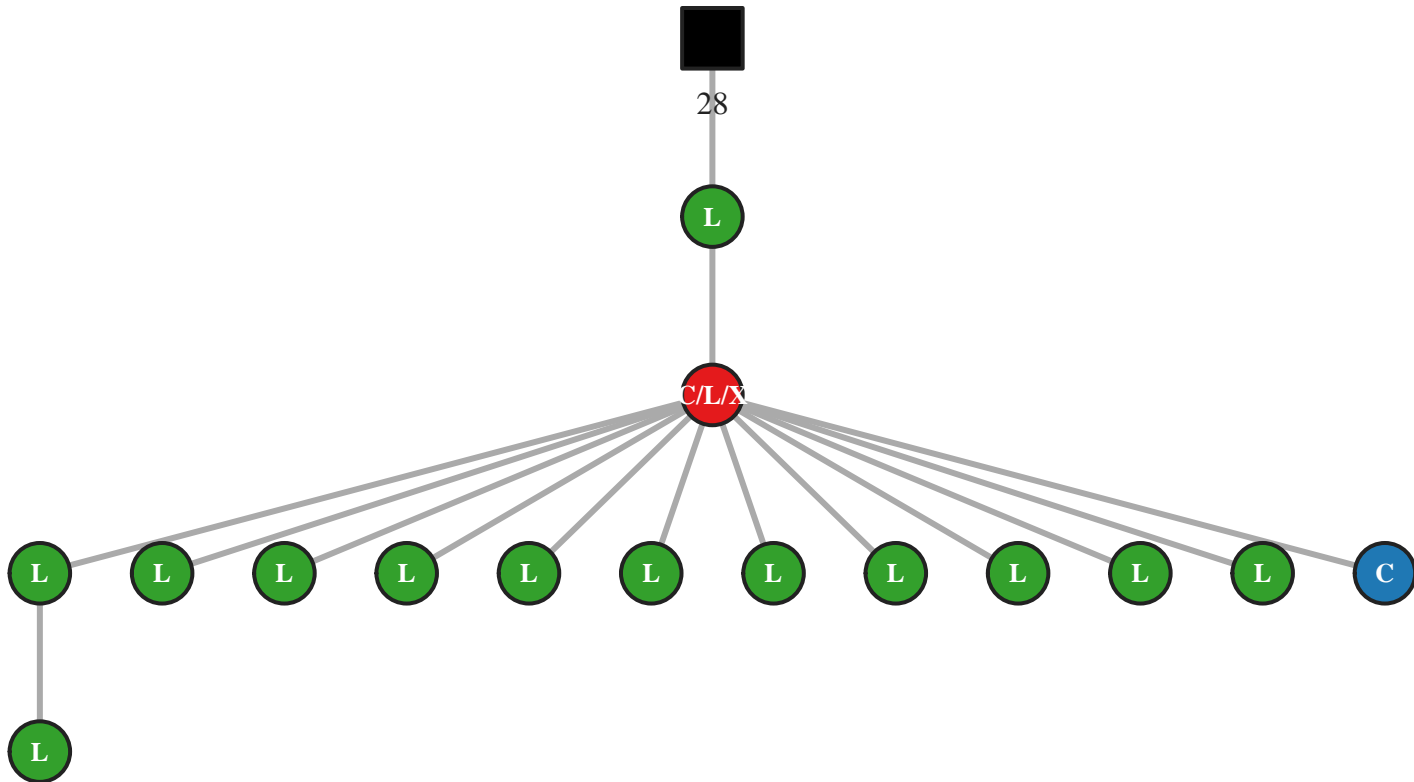

M5 IgG IGHV3-74/J4 36bp (18193)

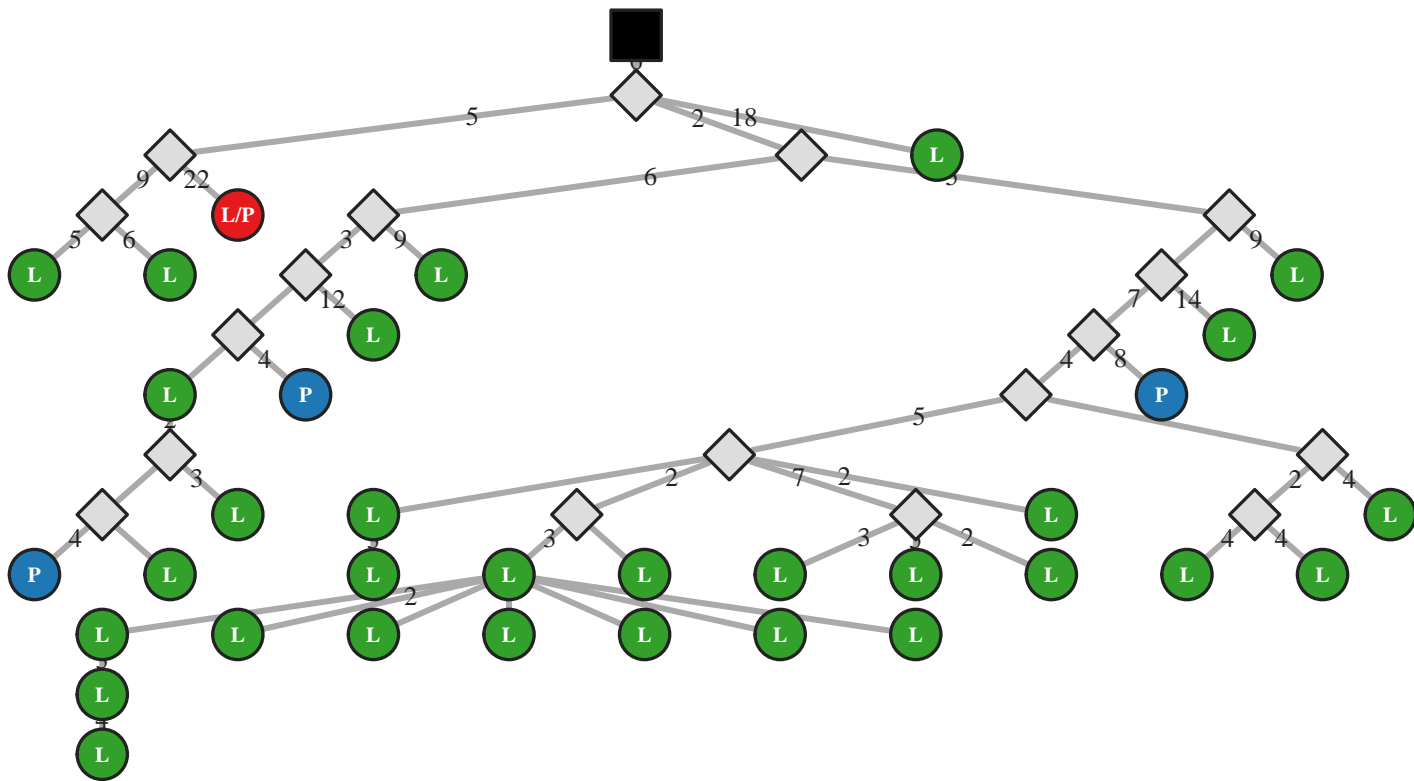

M5 IgM IGHV3-74/J4 39bp (48032)

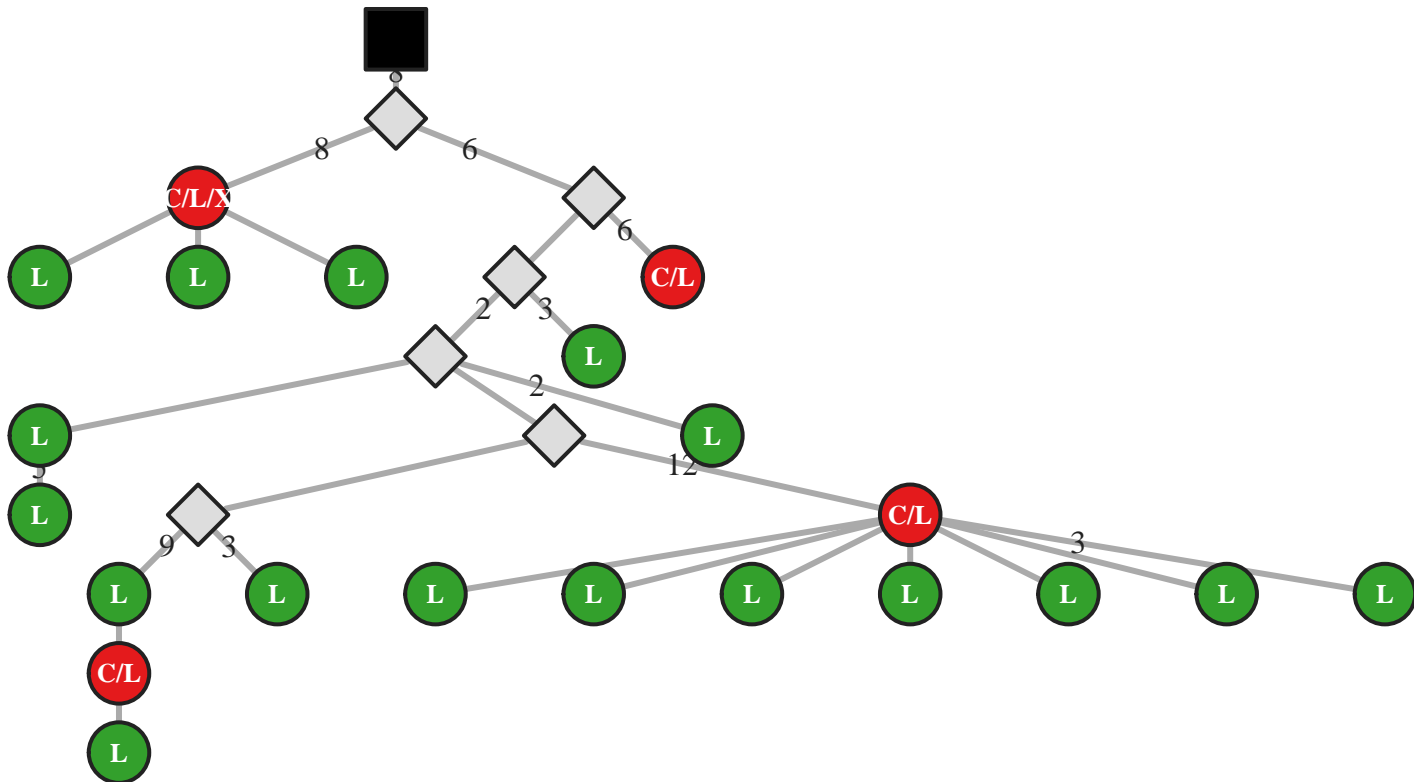

M5 IgA IGHV3-74/J4 45bp (3024)

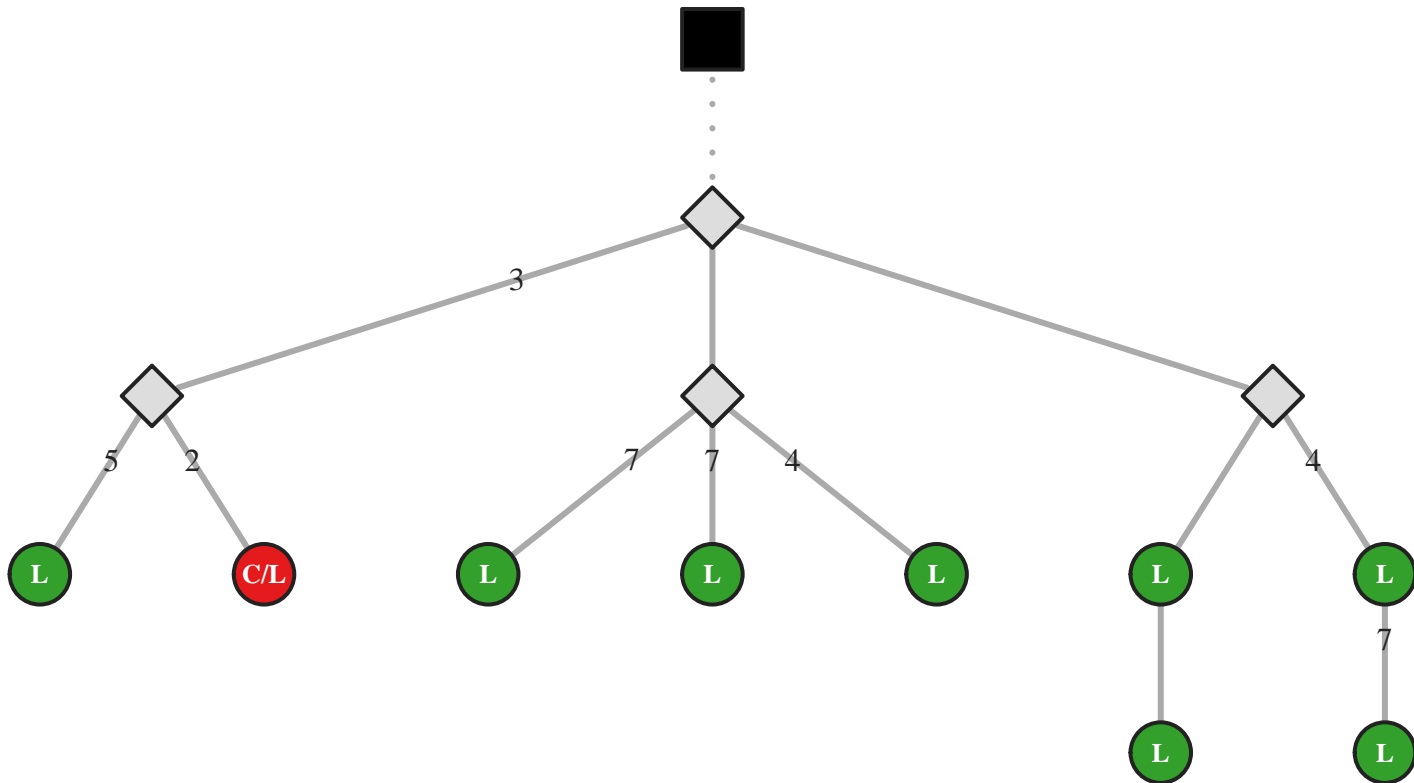

M5 IgG IGHV3-74/J4 45bp (27178)

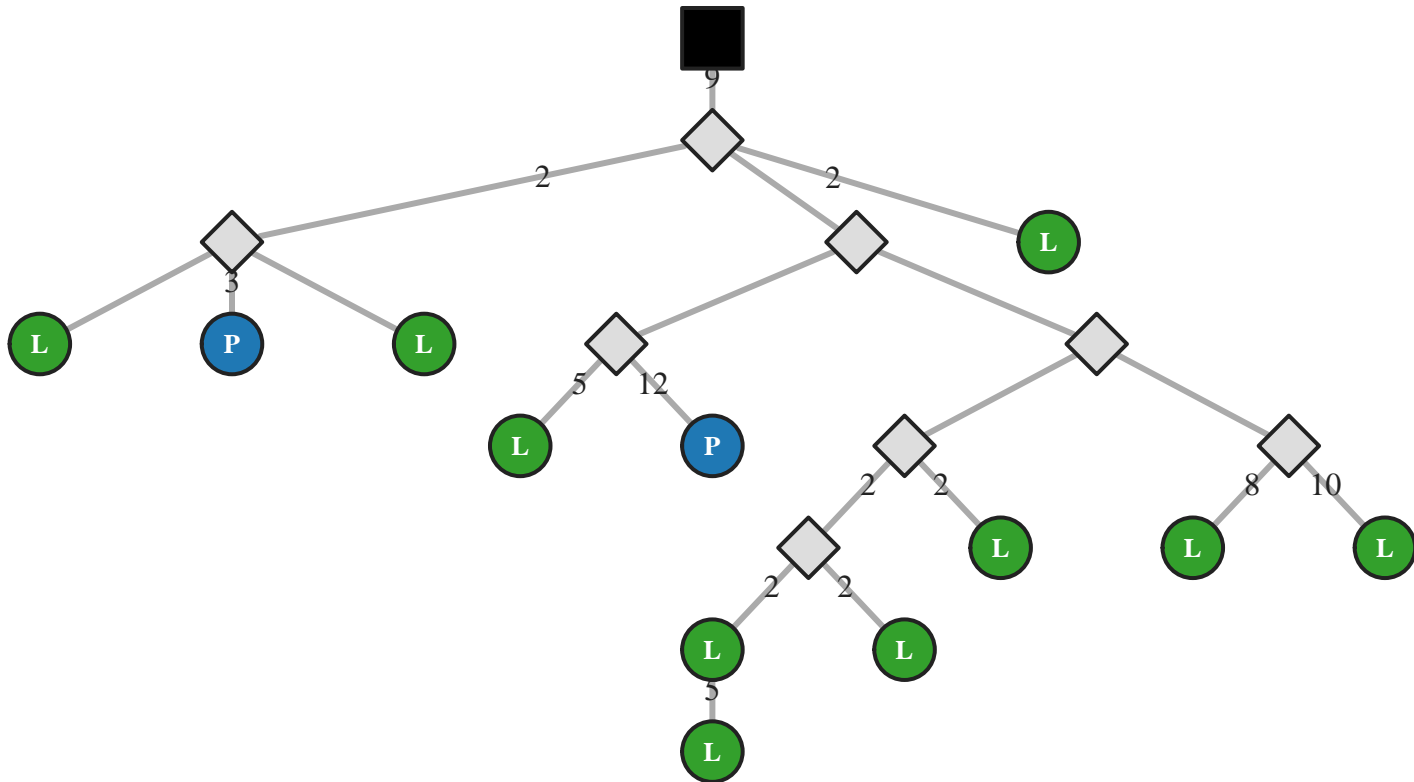

M5 IgM IGHV3-74/J4 45bp (54227)

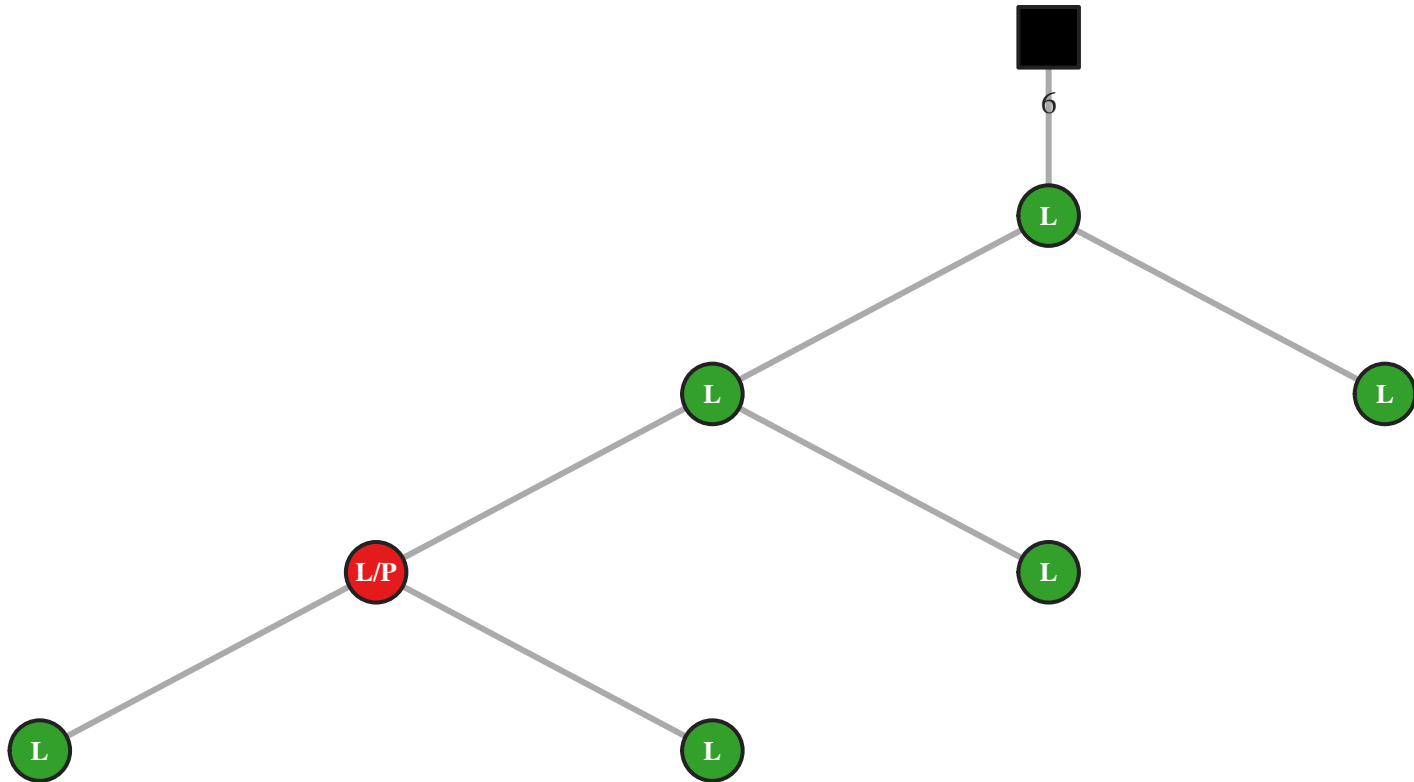

M5 IgM IGHV3-74/J4 45bp (54231)

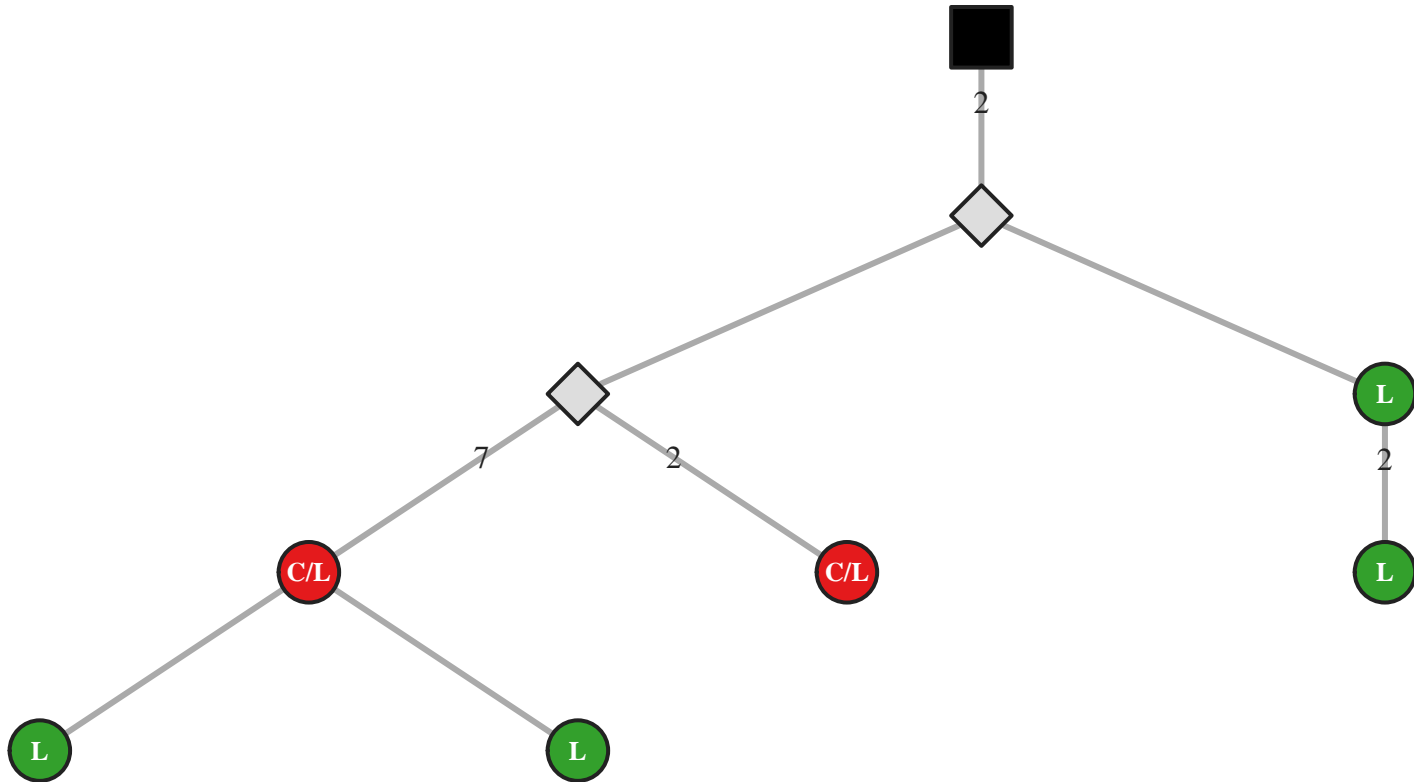

M5 IgG IGHV3-74/J4 48bp (52256)

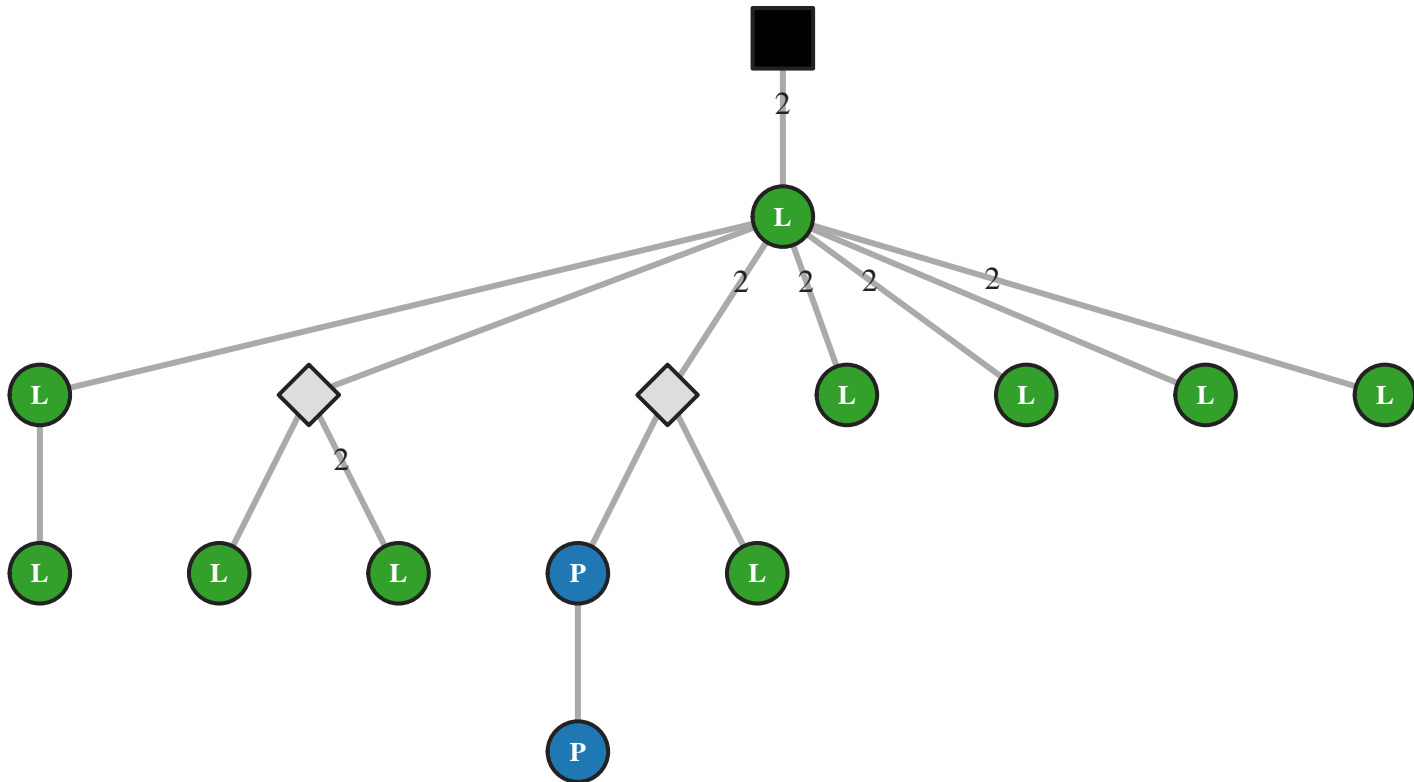

M5 IgG IGHV3-74/J4 48bp (52258)

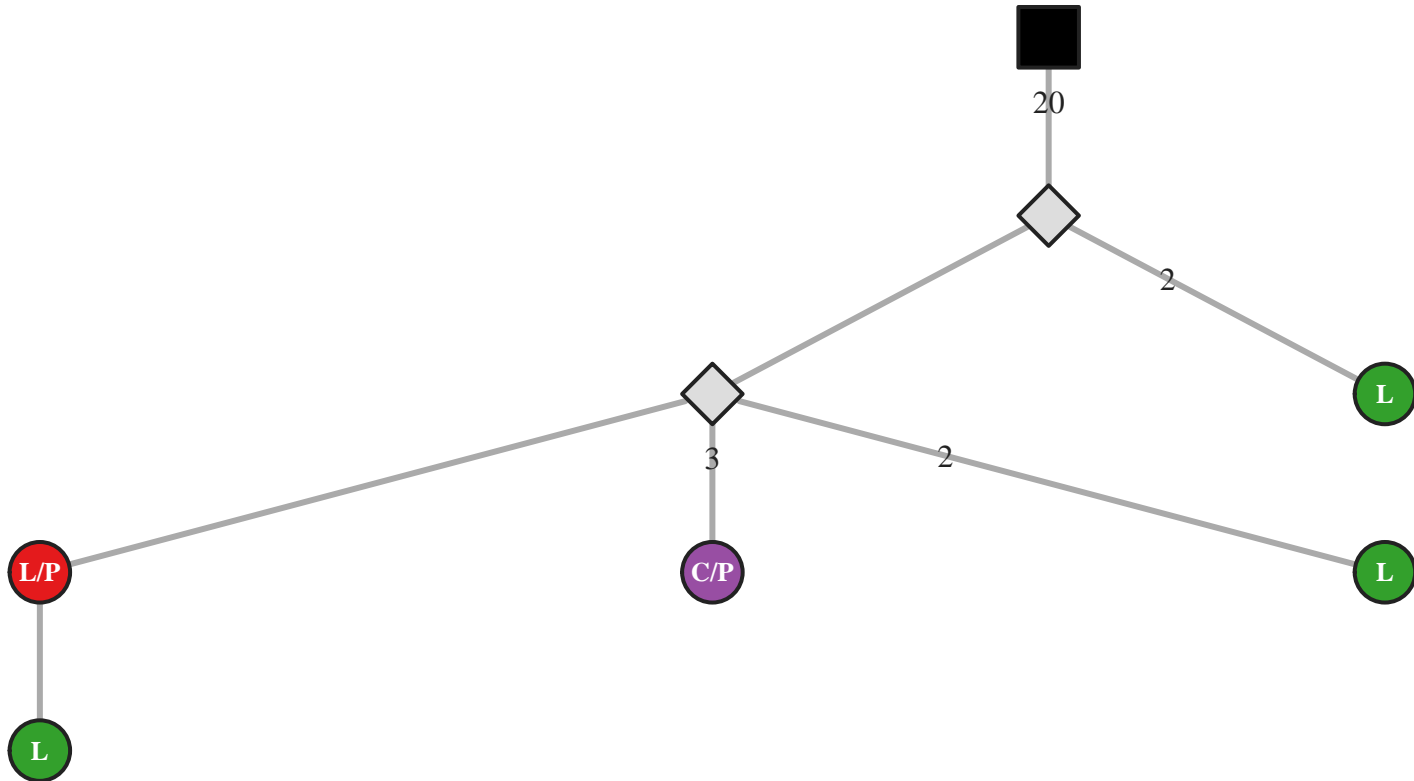

M5 IgM IGHV3-74/J4 48bp (48066)

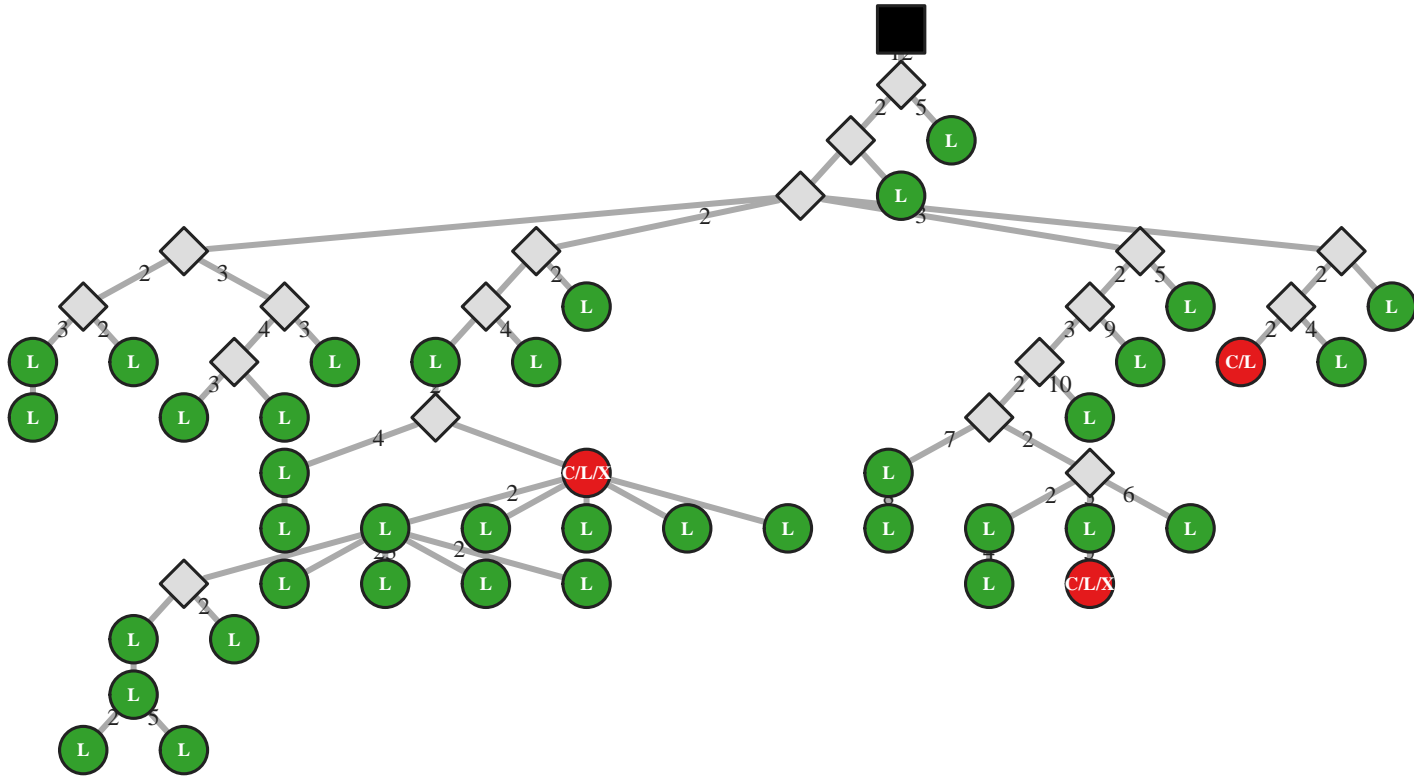

M5 IgM IGHV3-74/J4 51bp (54241)

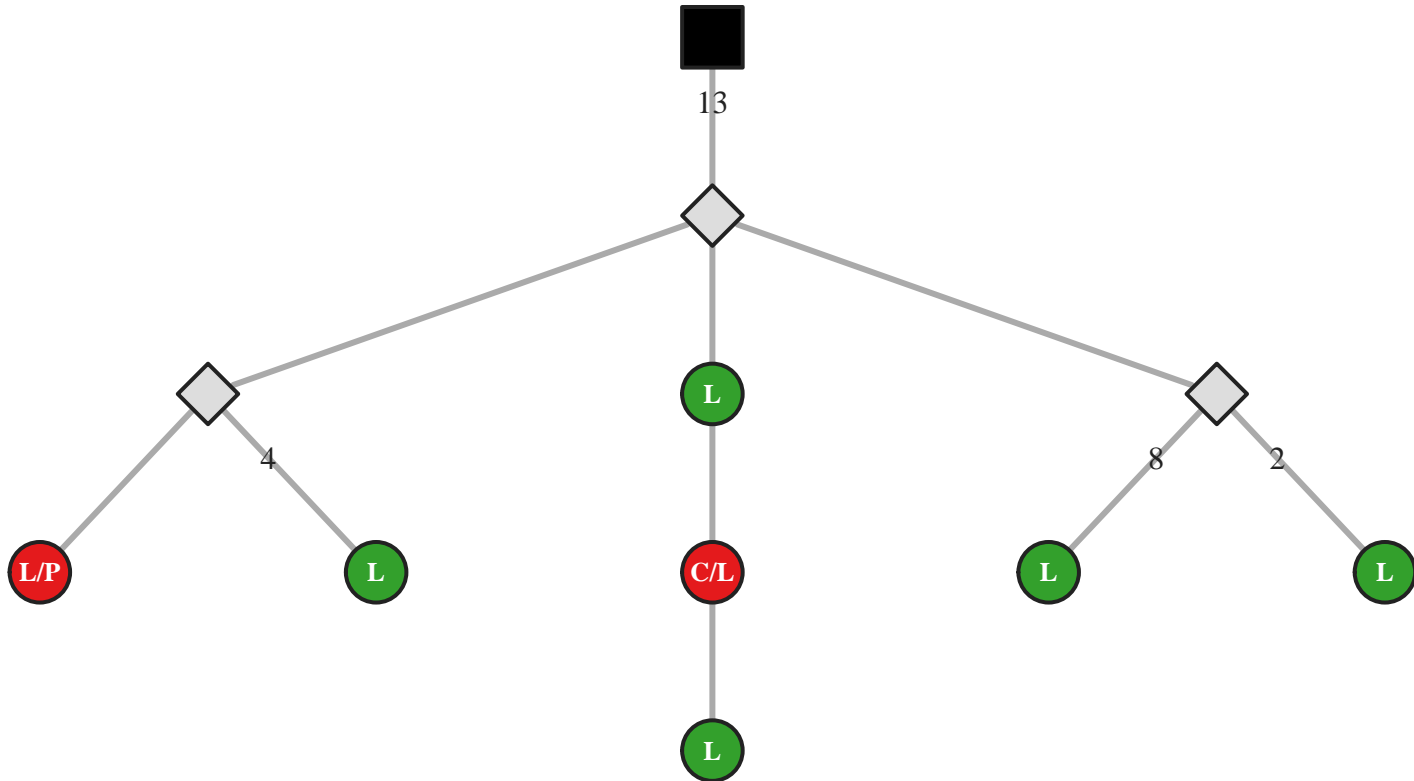

M5 IgG IGHV3-74/J5 27bp (18215)

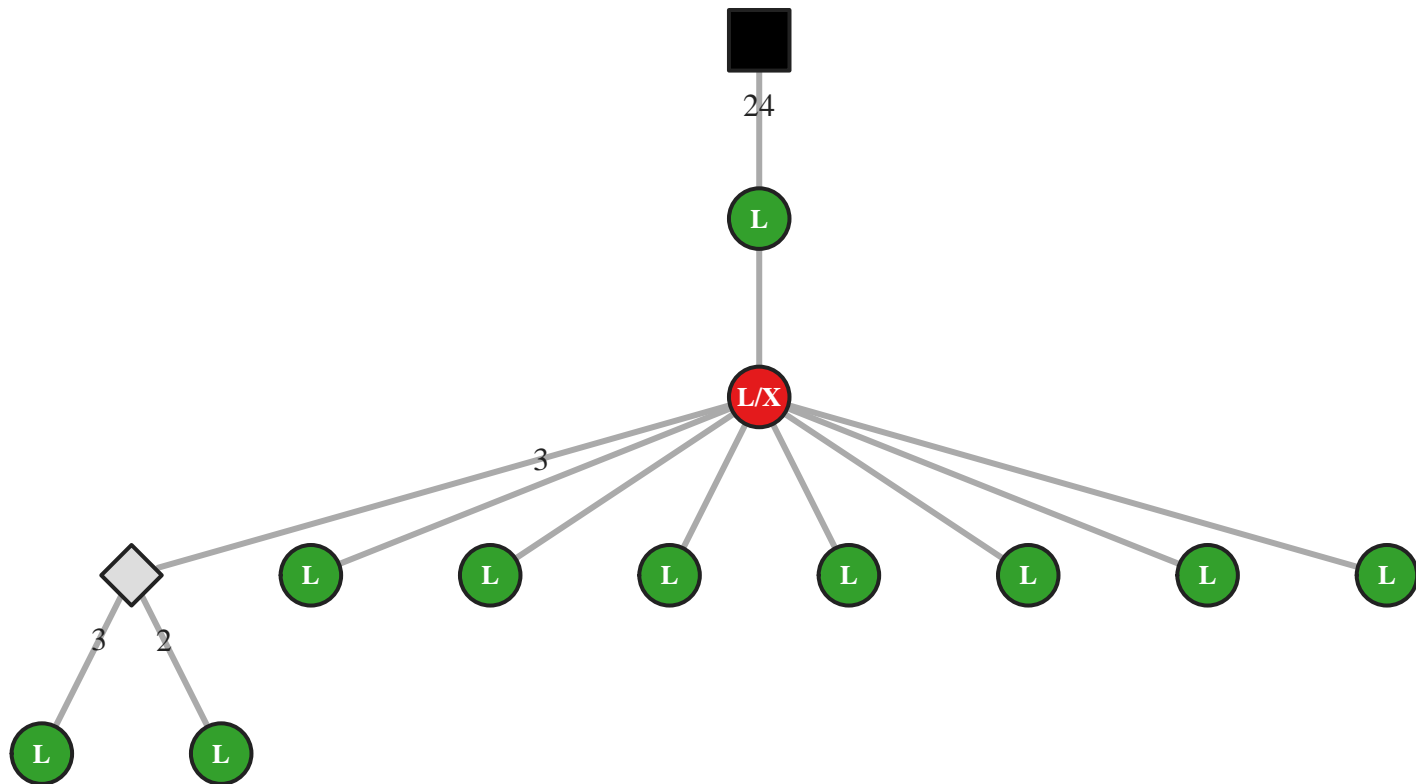

M5 IgG IGHV3-74/J5 36bp (45505)

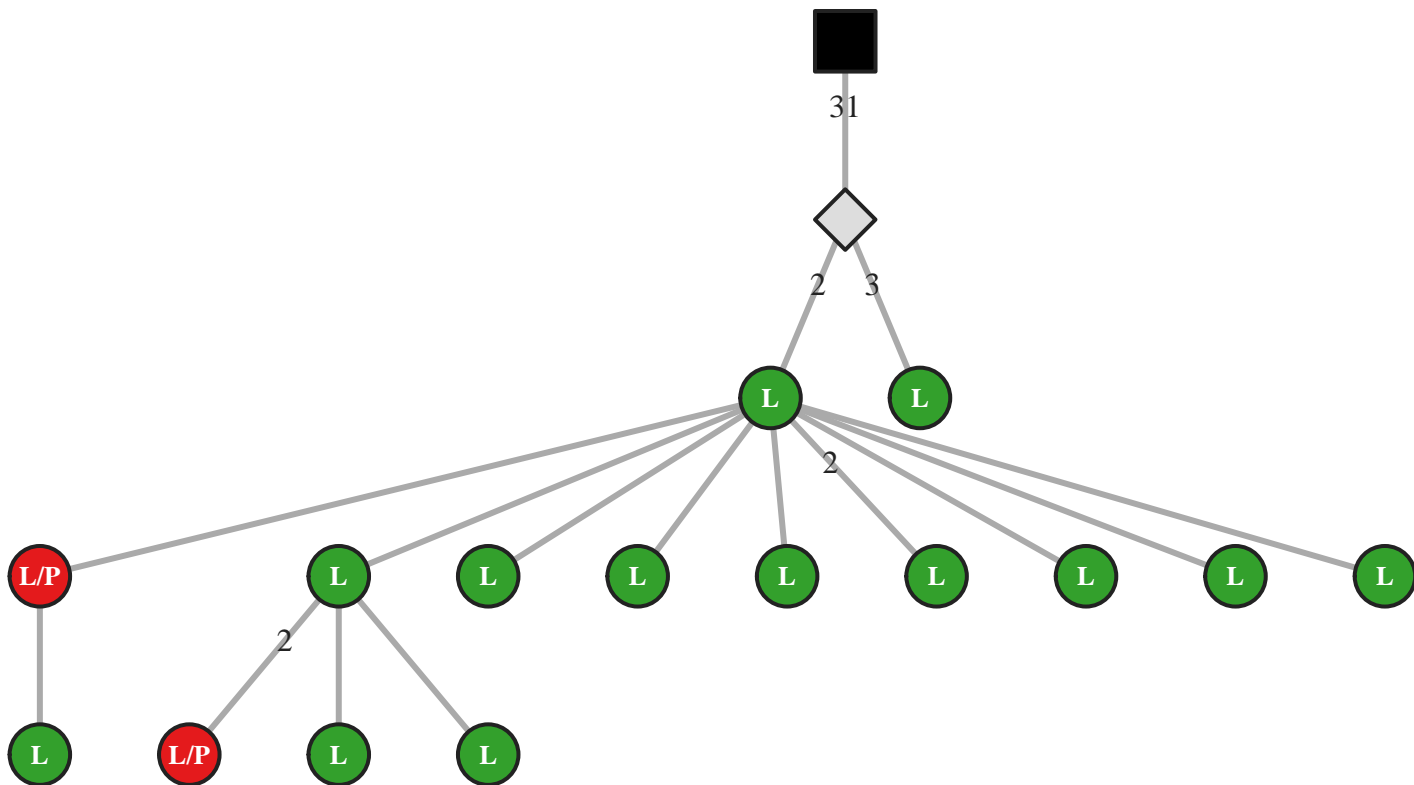

M5 IgG IGHV3-74/J5 60bp (52267)

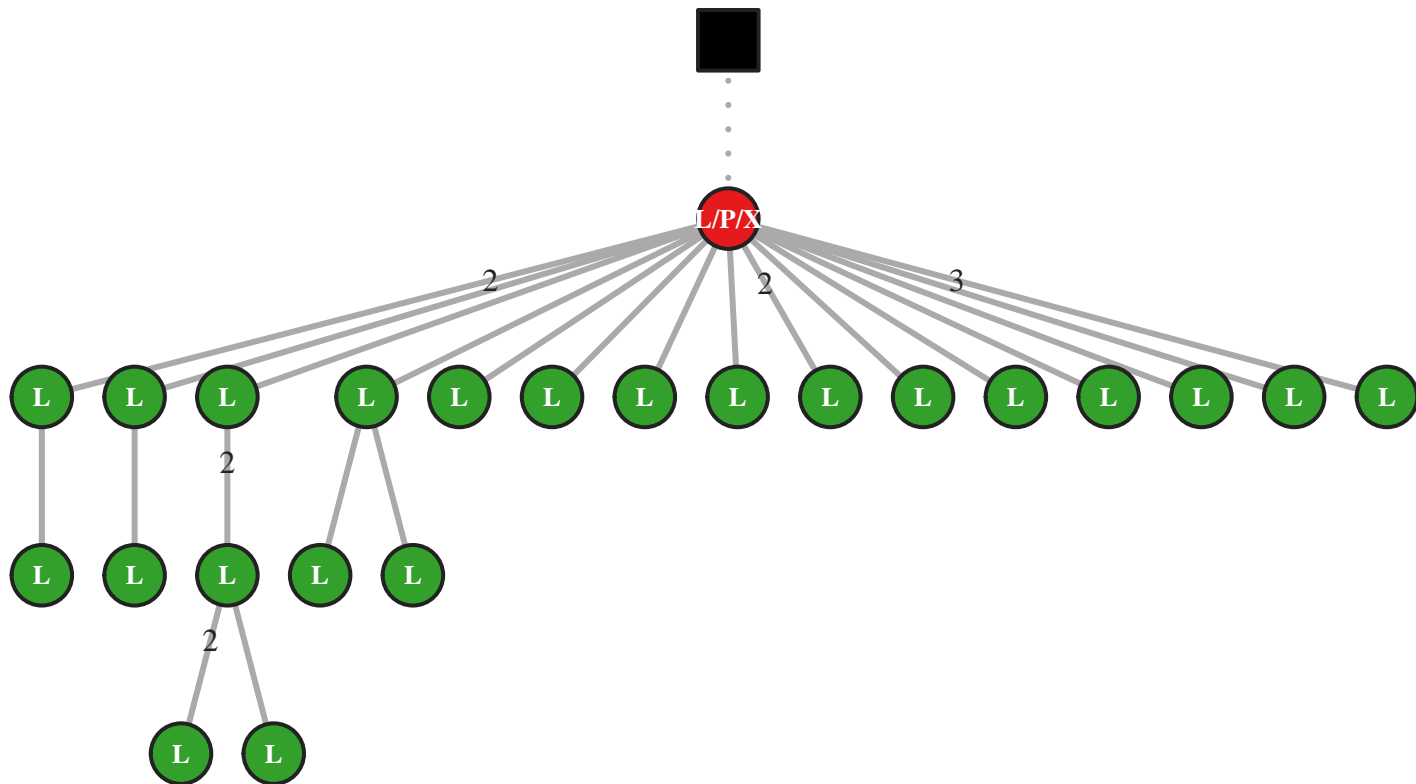

M5 IgG IGHV3-74/J6 57bp (52285)

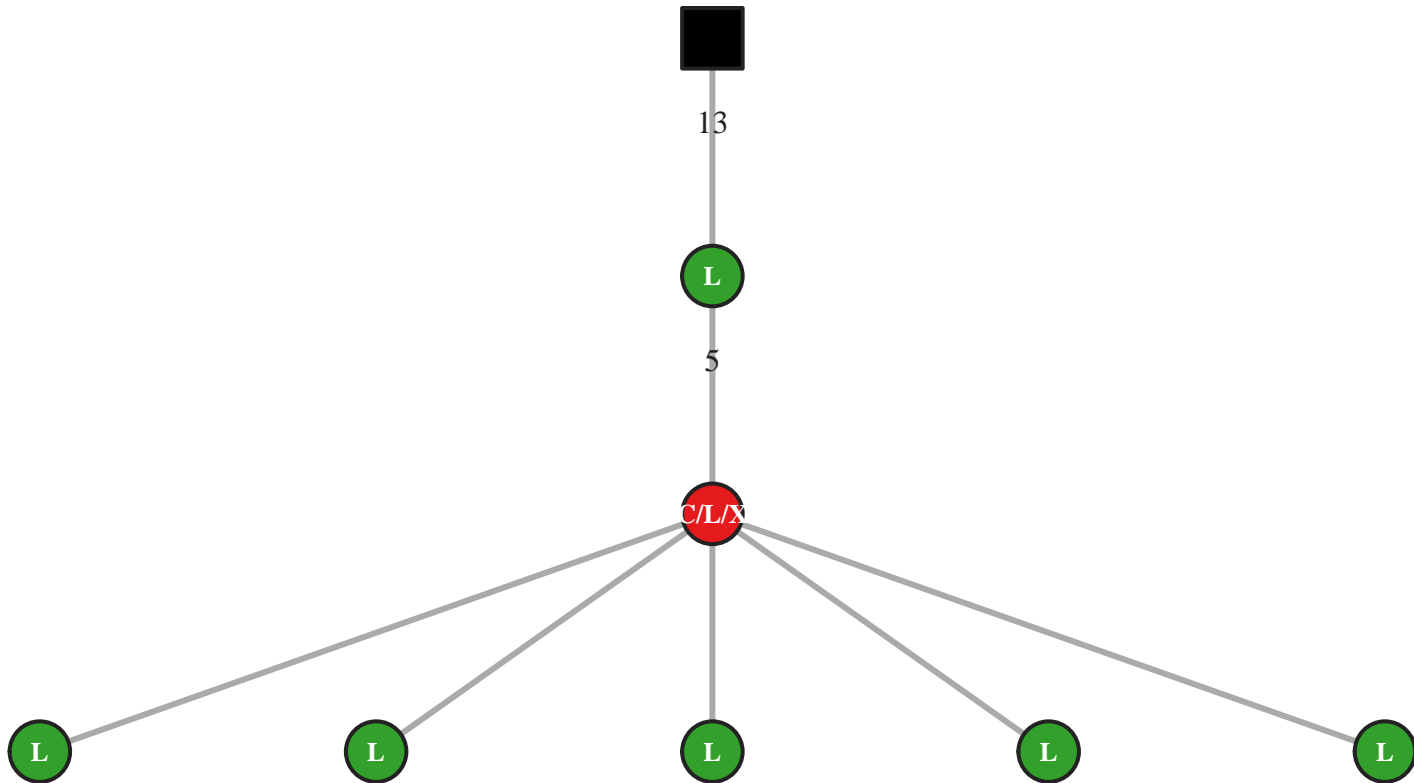

M5 IgG IGHV3-74/J6 60bp (8651)

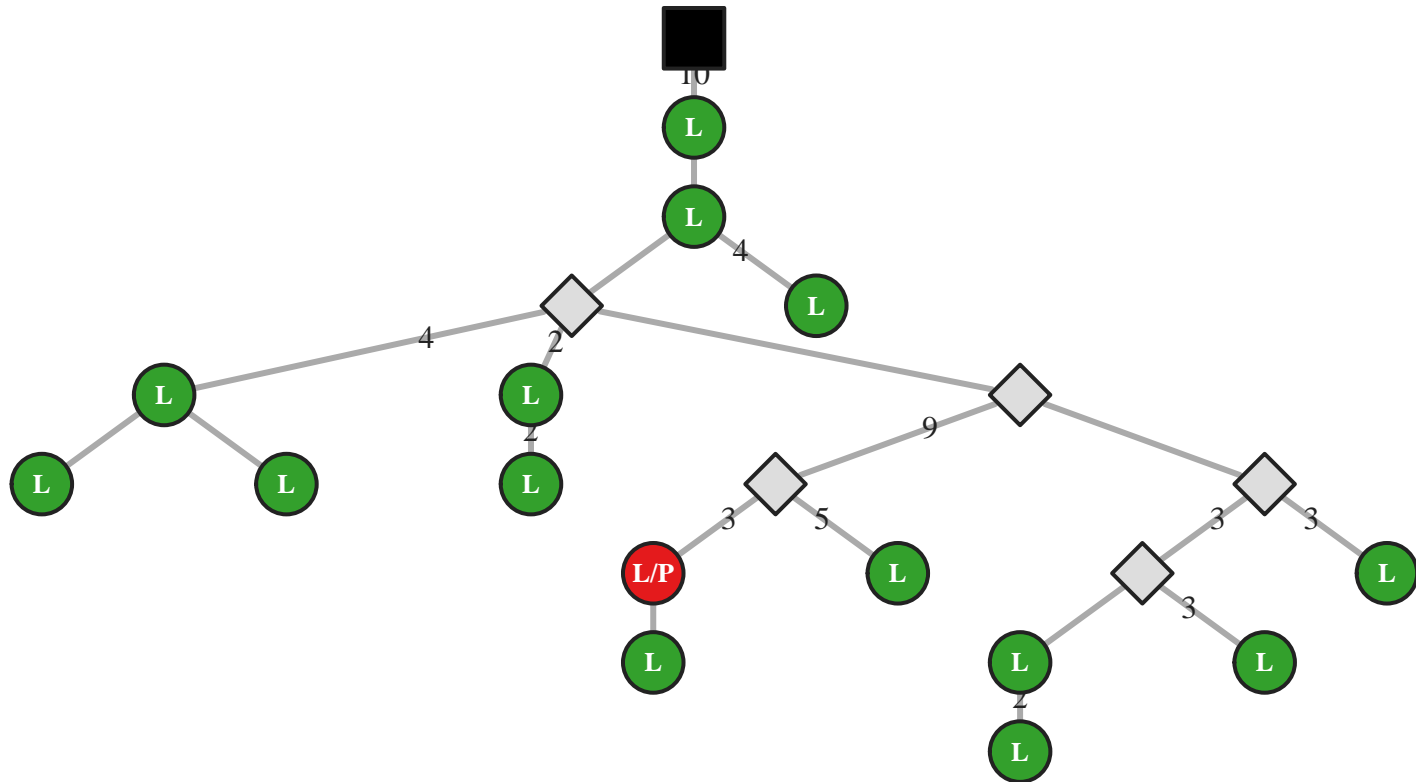

M5 IgA IGHV3-74/J6 66bp (30697)

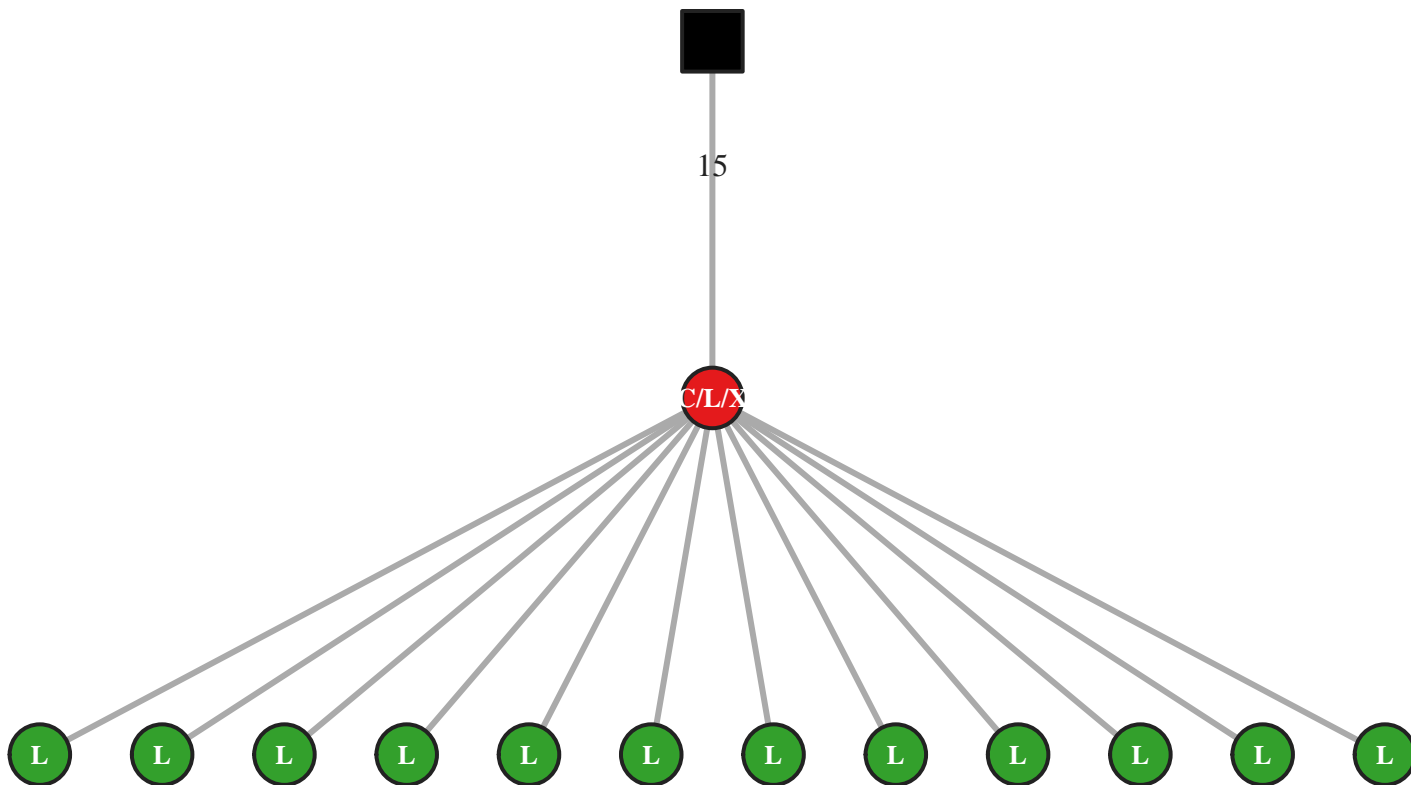

M5 IgG IGHV3-9/J3 48bp (45791)

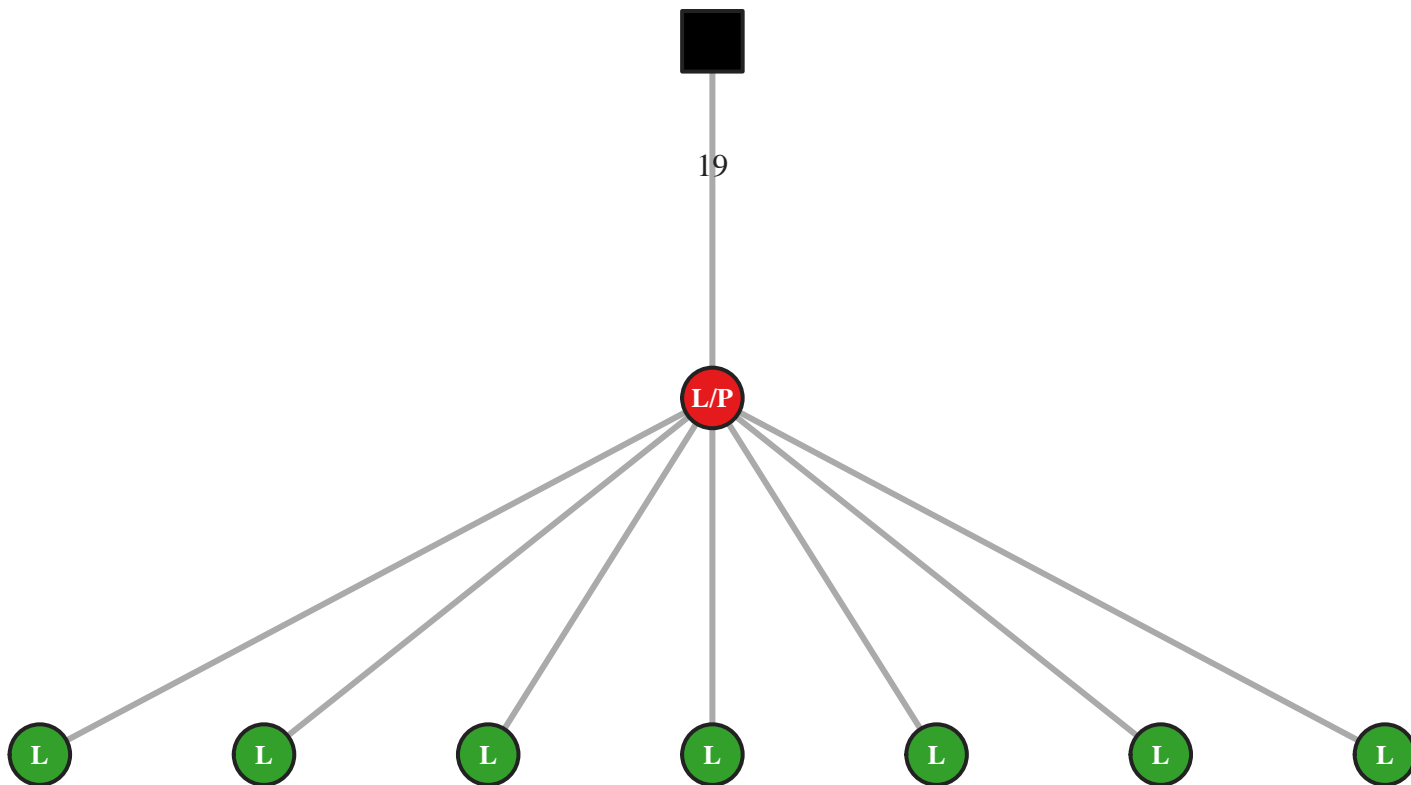

M5 IgG IGHV3-9/J3 48bp (45807)

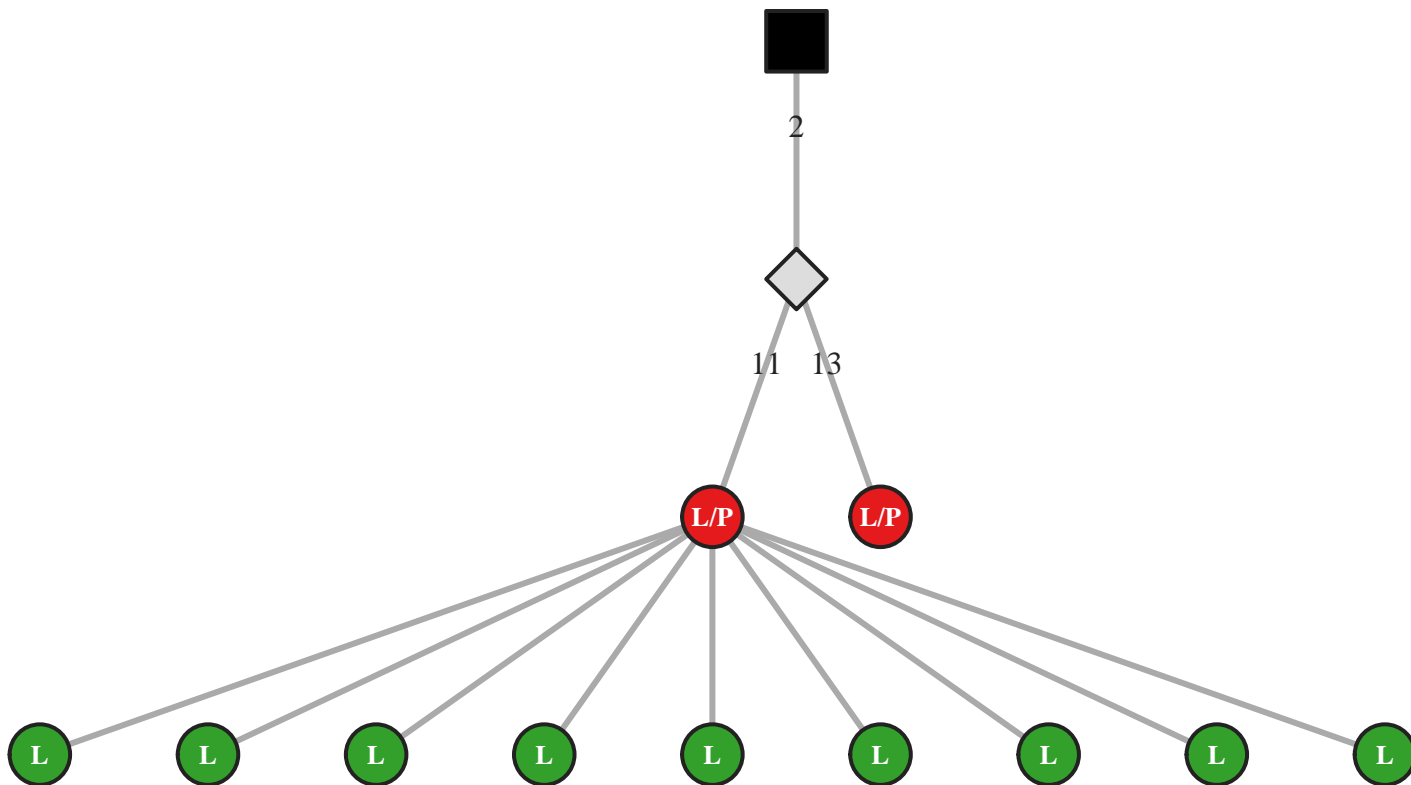

M5 IgG IGHV3-9/J3 48bp (45812)

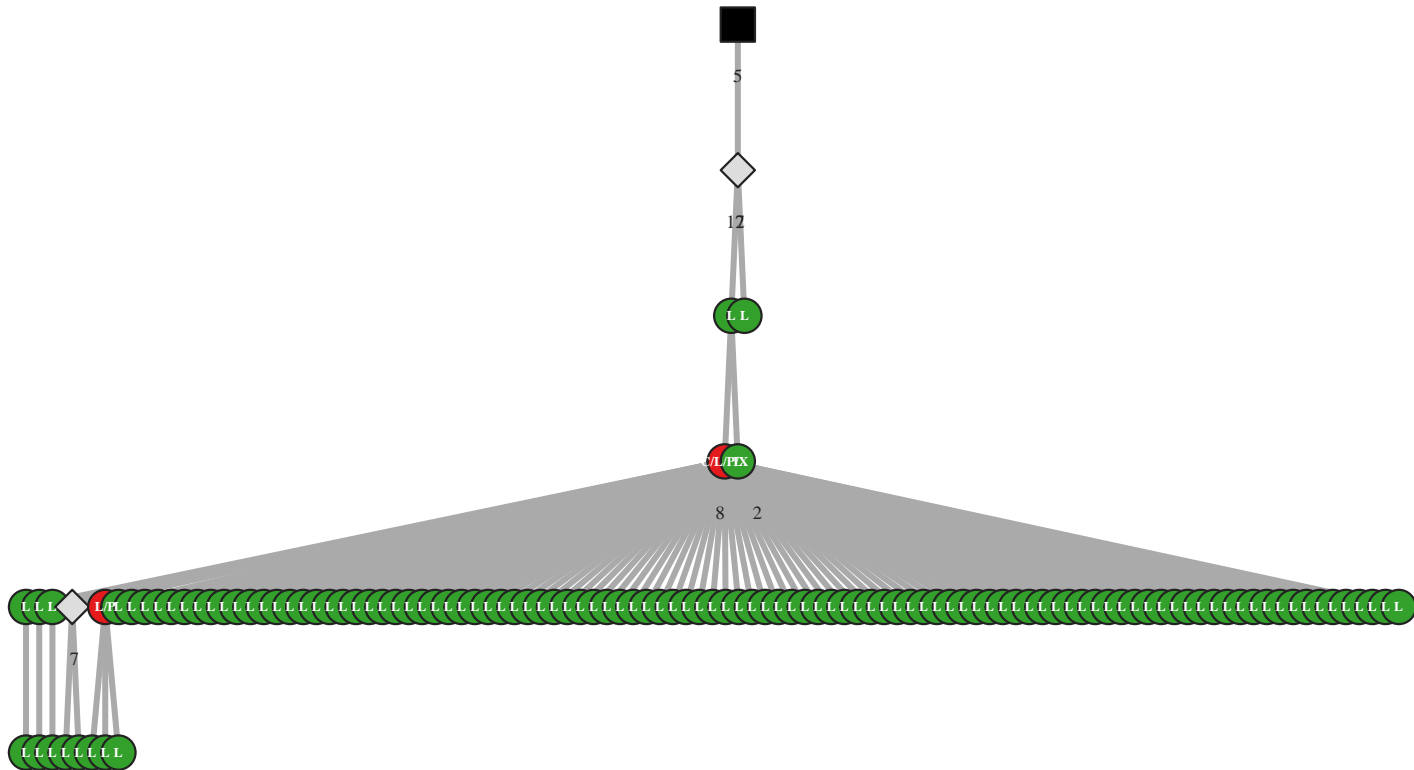

M5 IgG IGHV3-9/J4 42bp (18355)

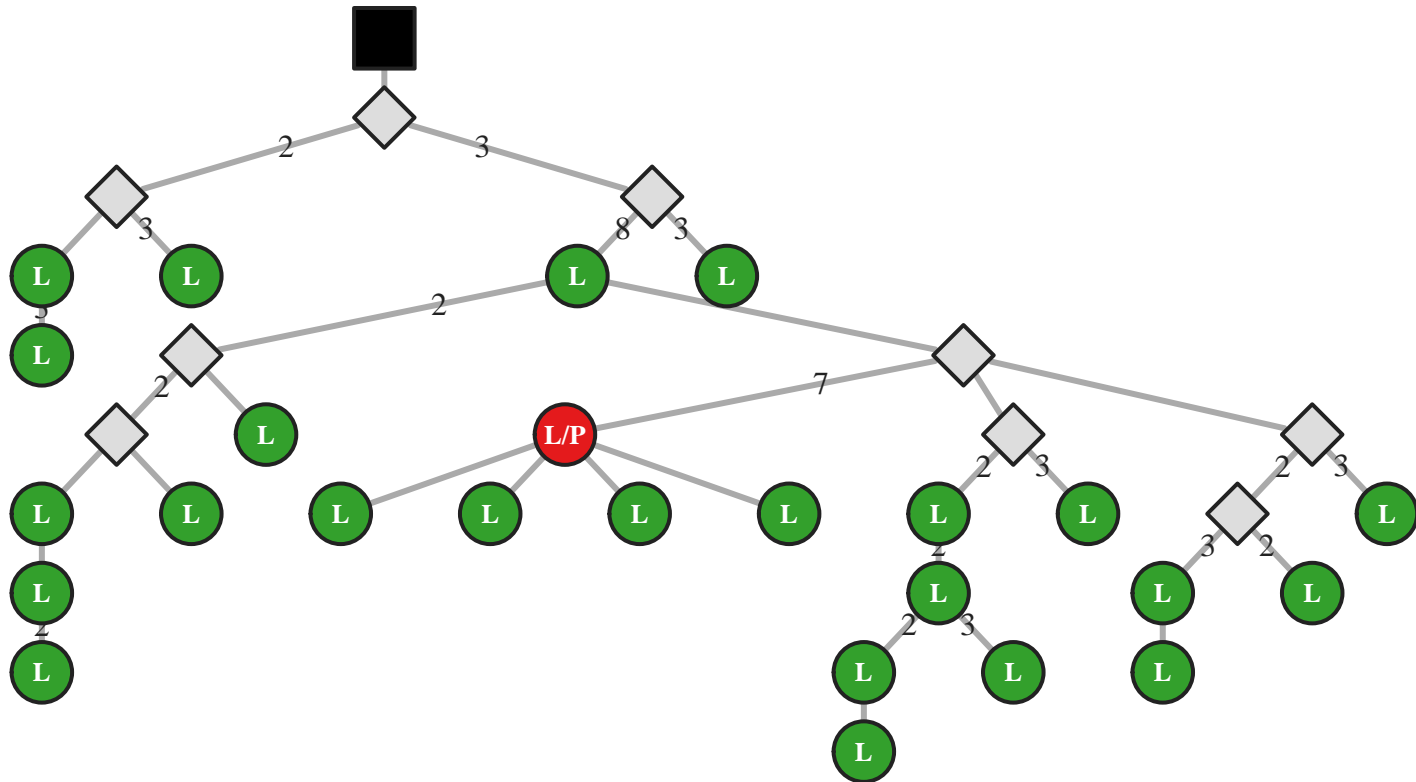

M5 IgG IGHV3-9/J4 42bp (18387)

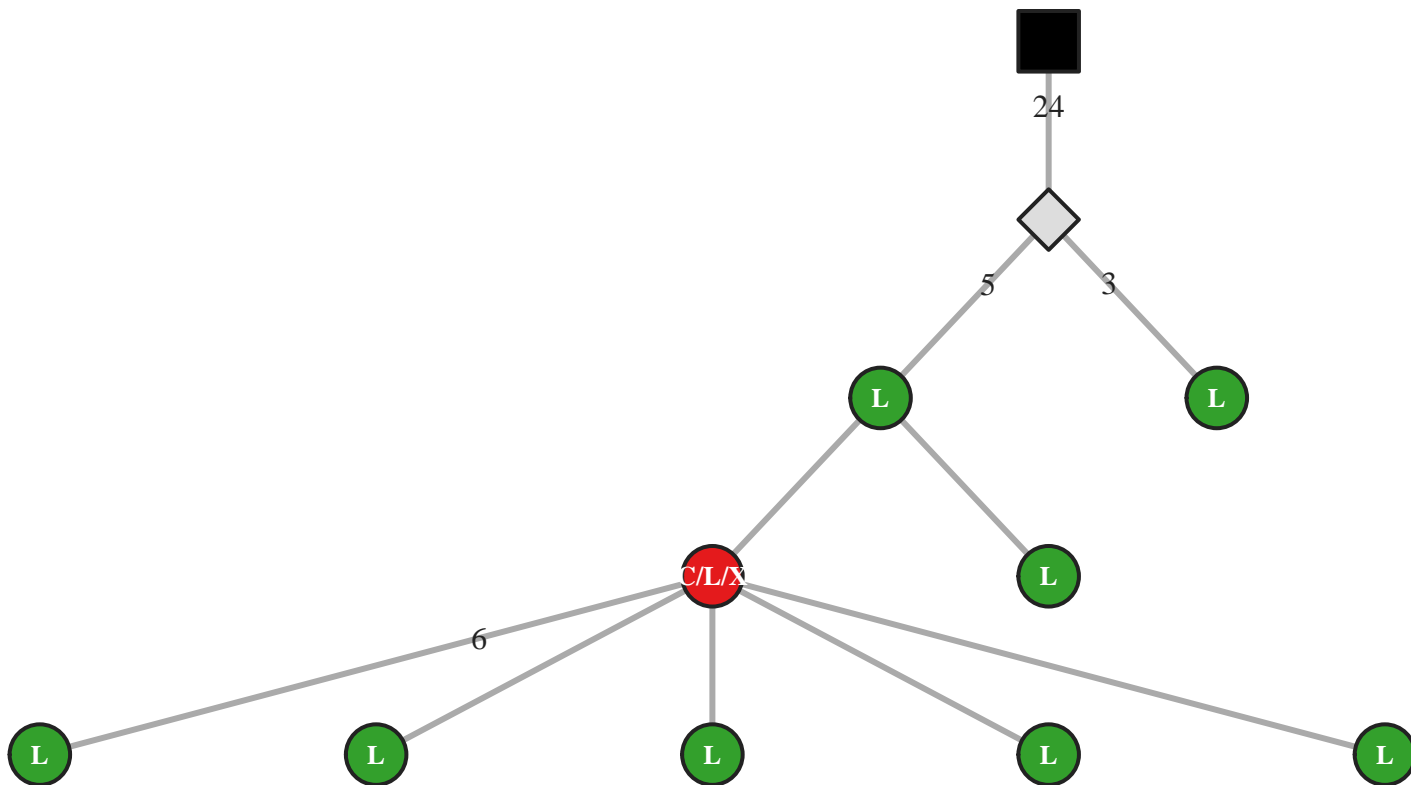

M5 IgA IGHV3-9/J4 45bp (3072)

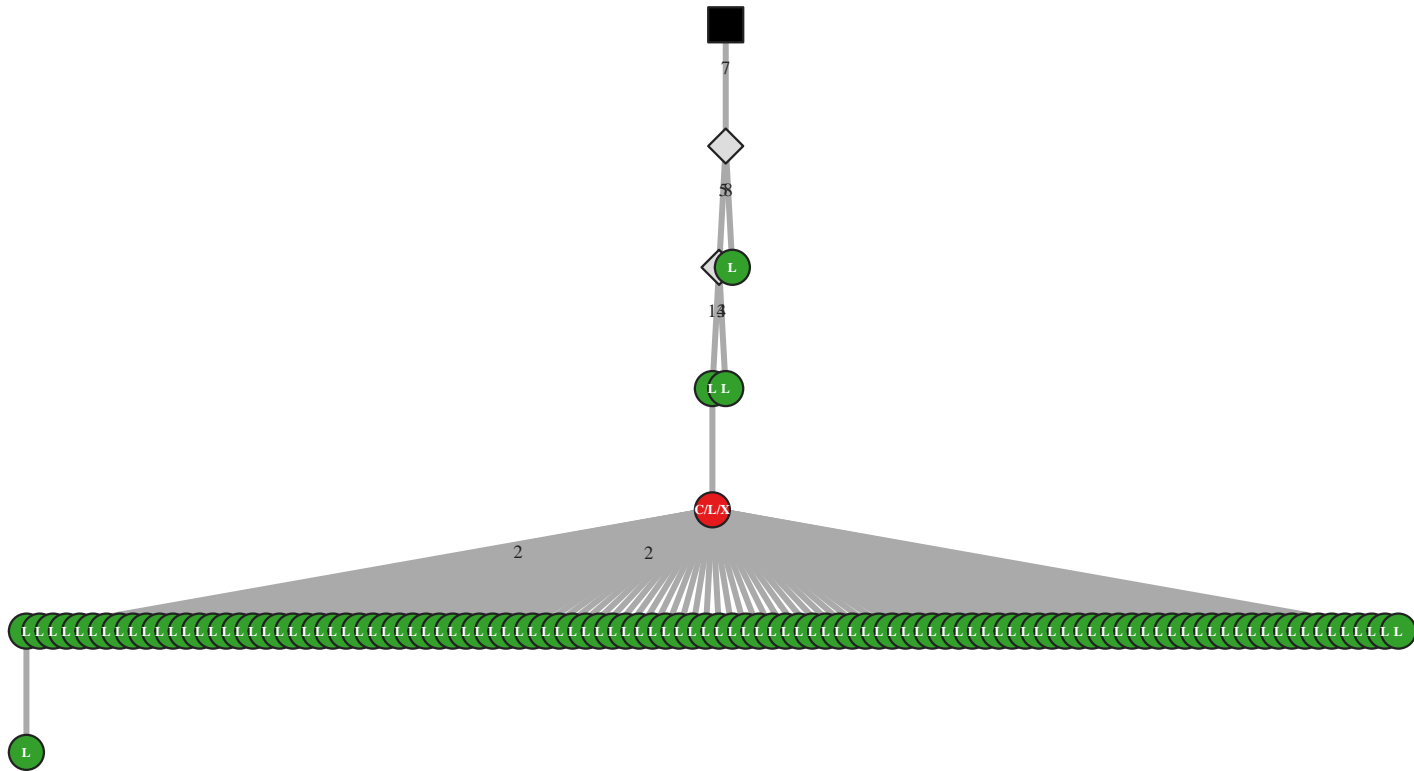

M5 IgG IGHV3-9/J4 45bp (27386)

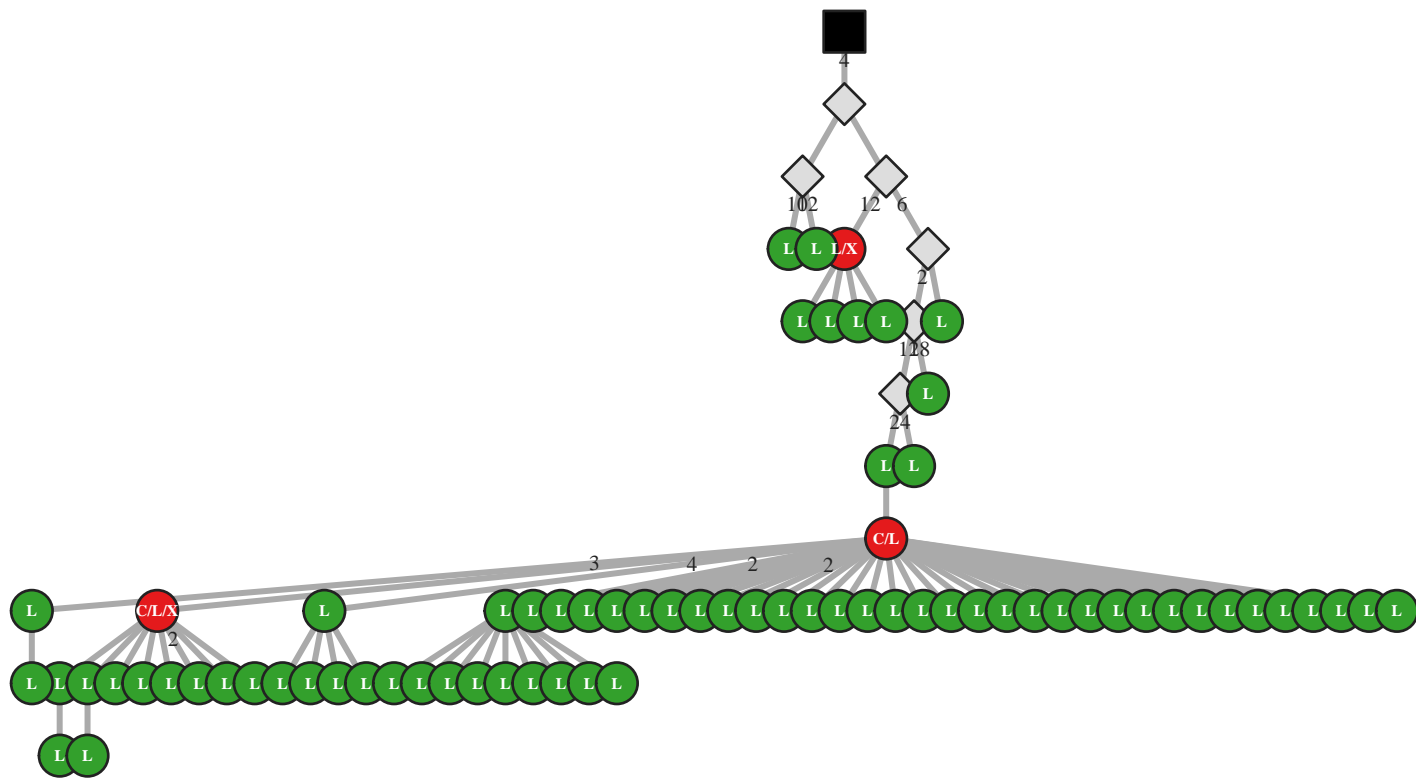

M5 IgG IGHV3-9/J4 45bp (27391)

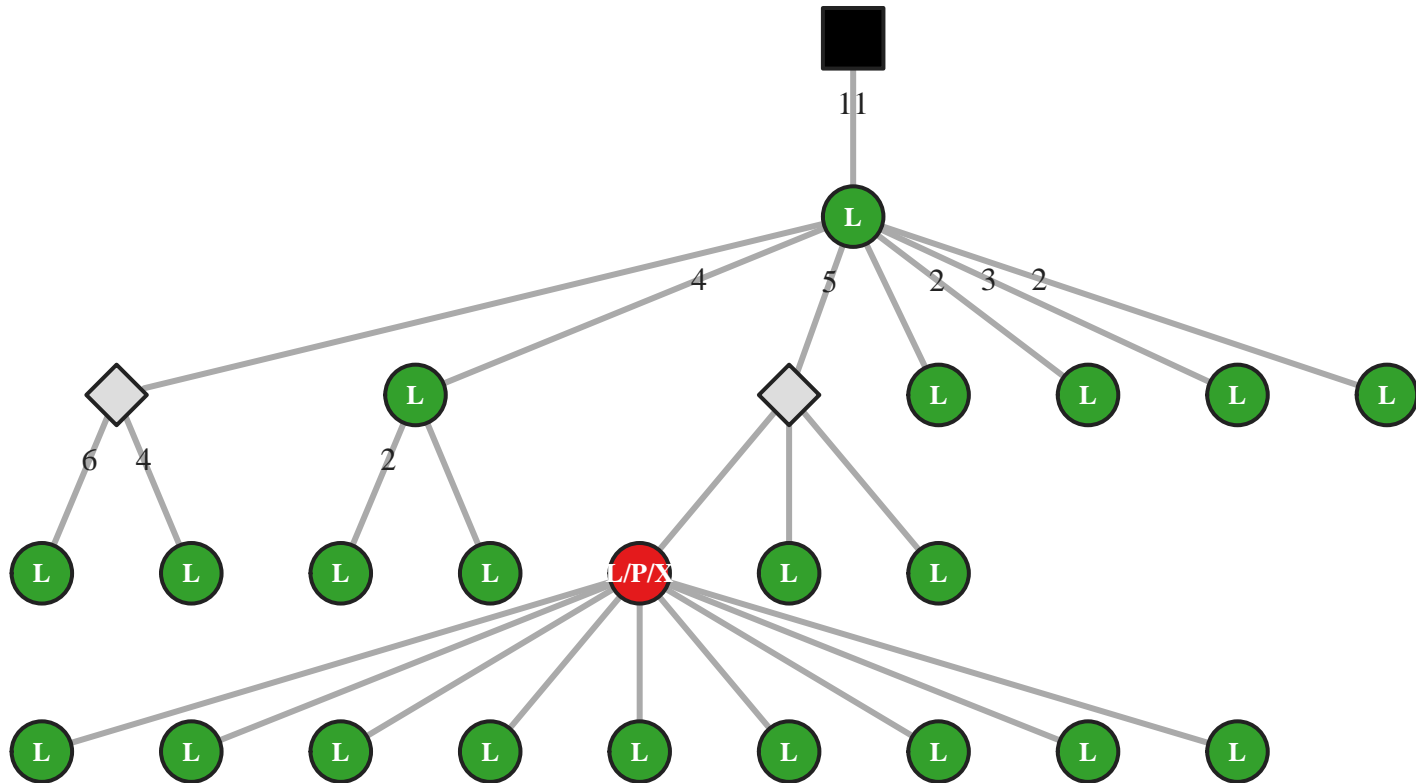

M5 IgG IGHV3-9/J4 45bp (27416)

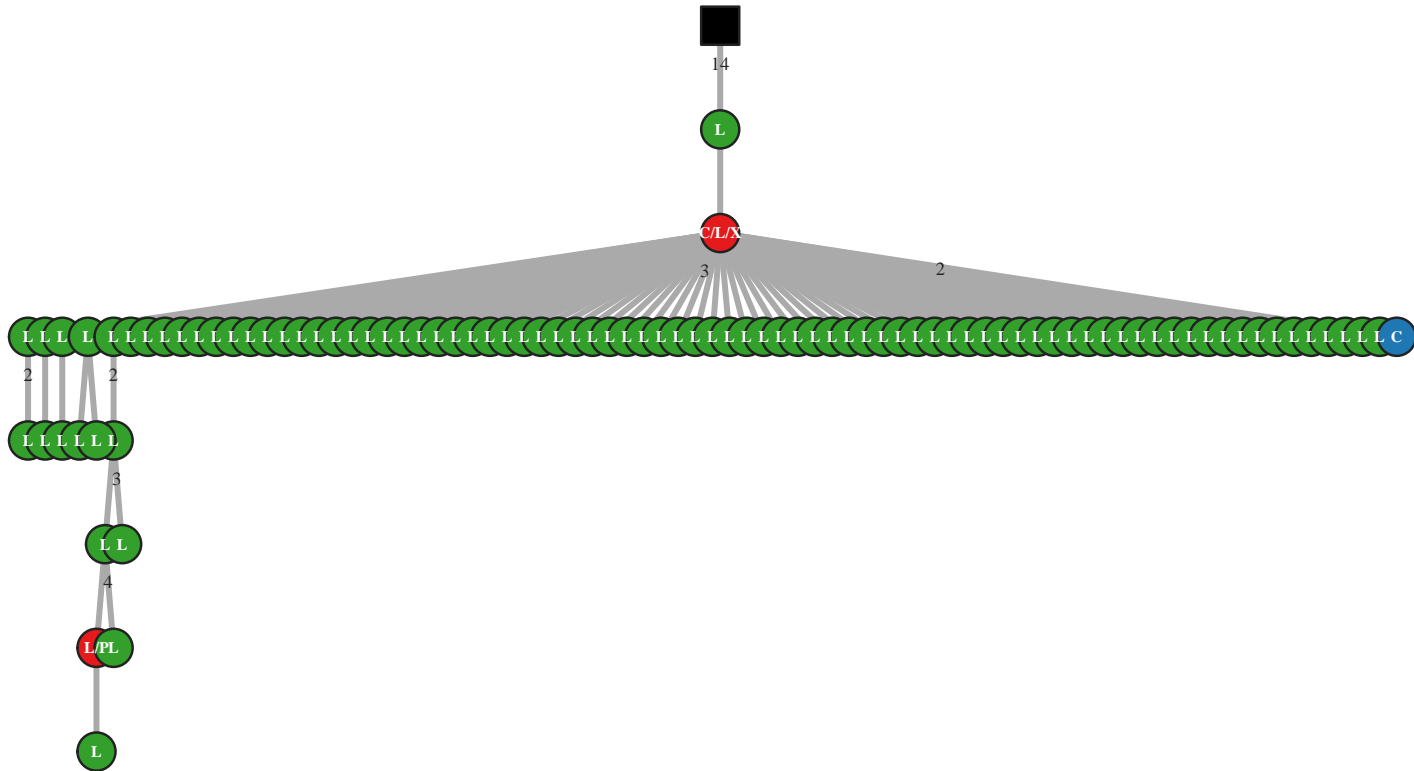

M5 IgG IGHV3-9/J4 45bp (27449)

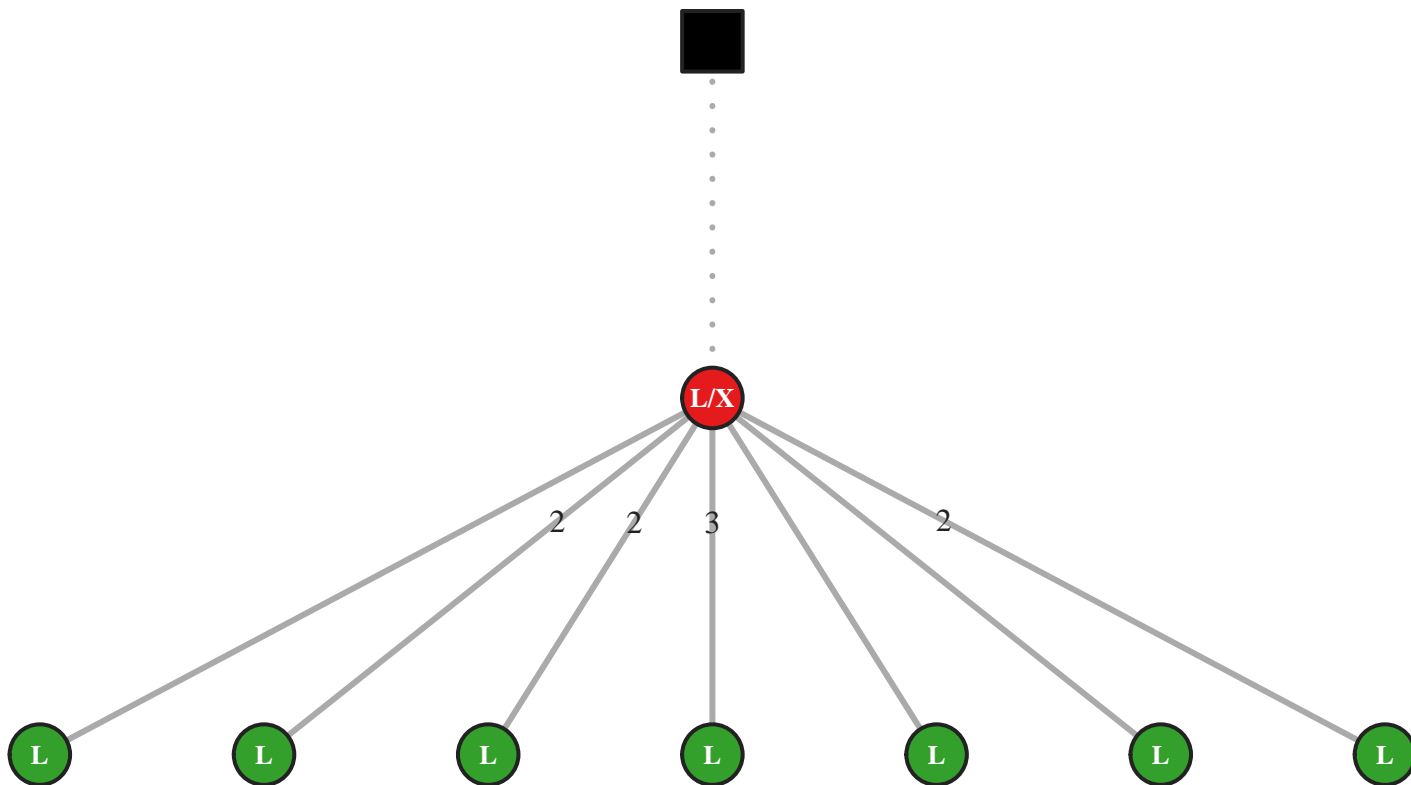

M5 IgG IGHV3-9/J4 45bp (27455)

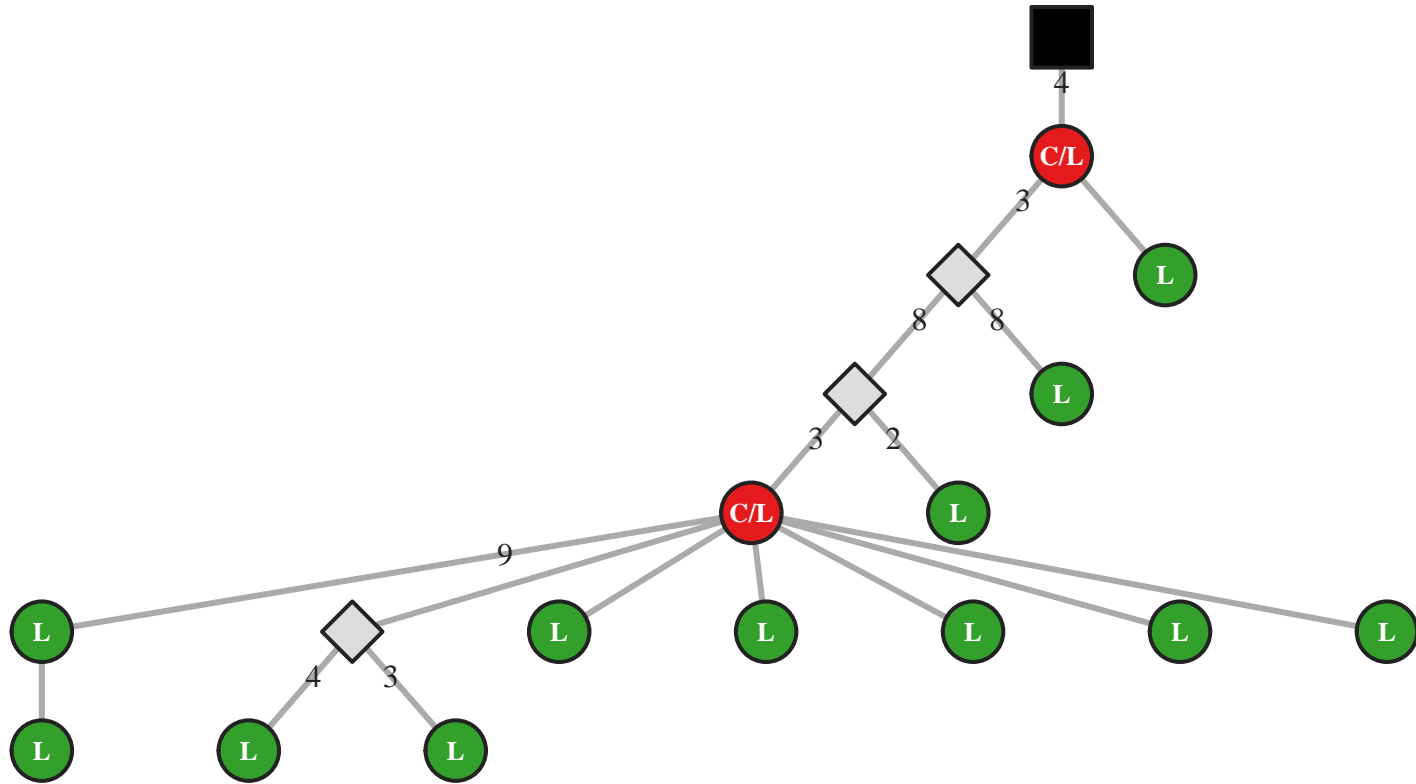

M5 IgG IGHV3-9/J4 48bp (9101)

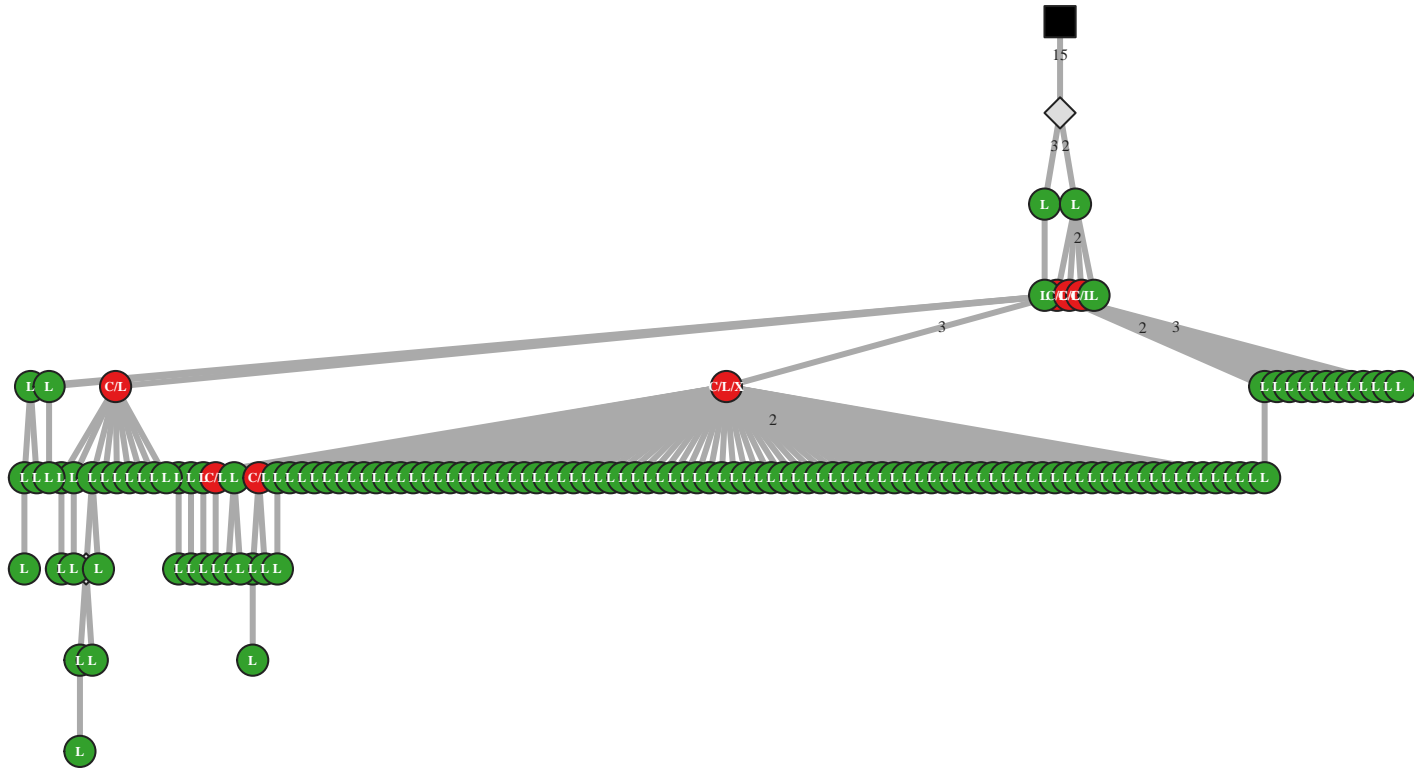

M5 IgG IGHV3-9/J4 48bp (9102)

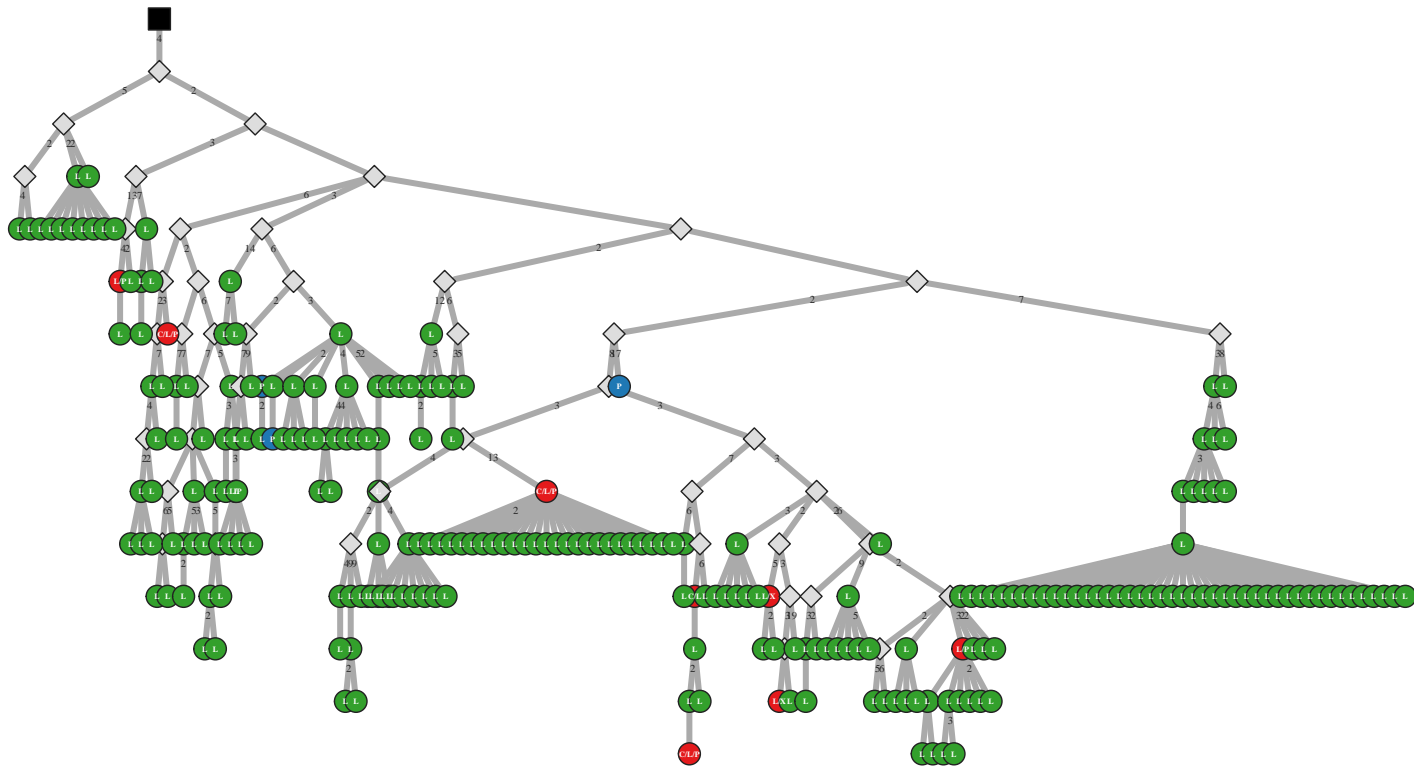

M5 IgG IGHV3-9/J4 48bp (9103)

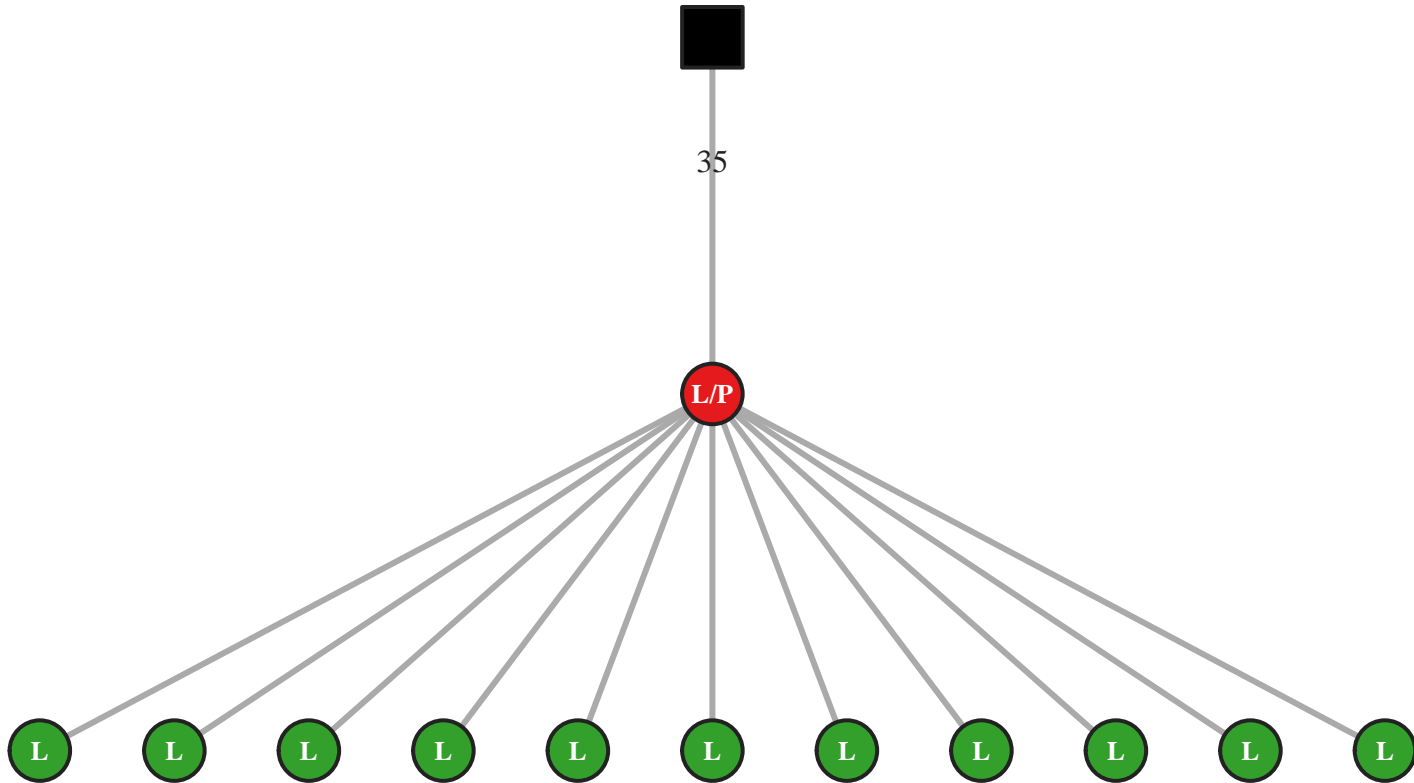

M5 IgG IGHV3-9/J4 48bp (9144)

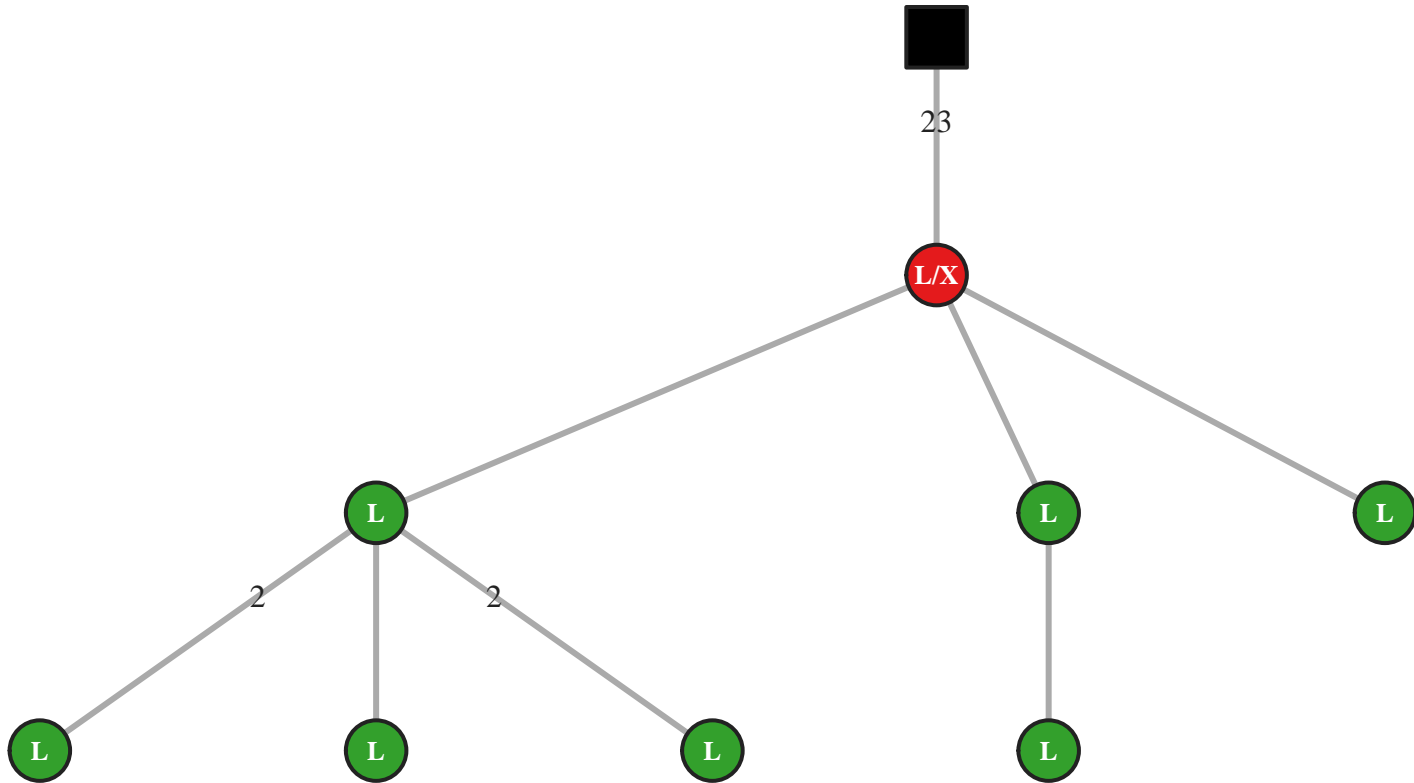

M5 IgG IGHV3-9/J4 48bp (9154)

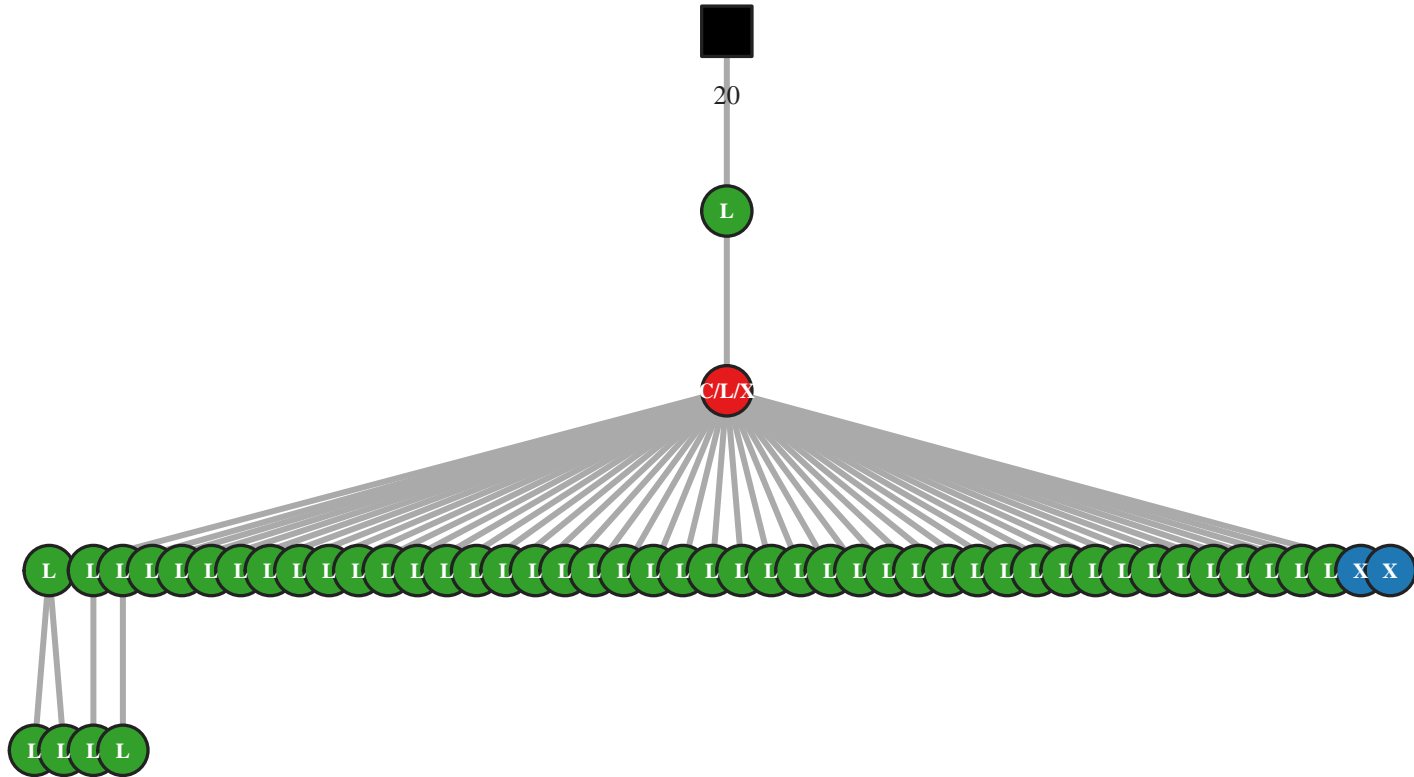

M5 IgG IGHV3-9/J4 51bp (27510)

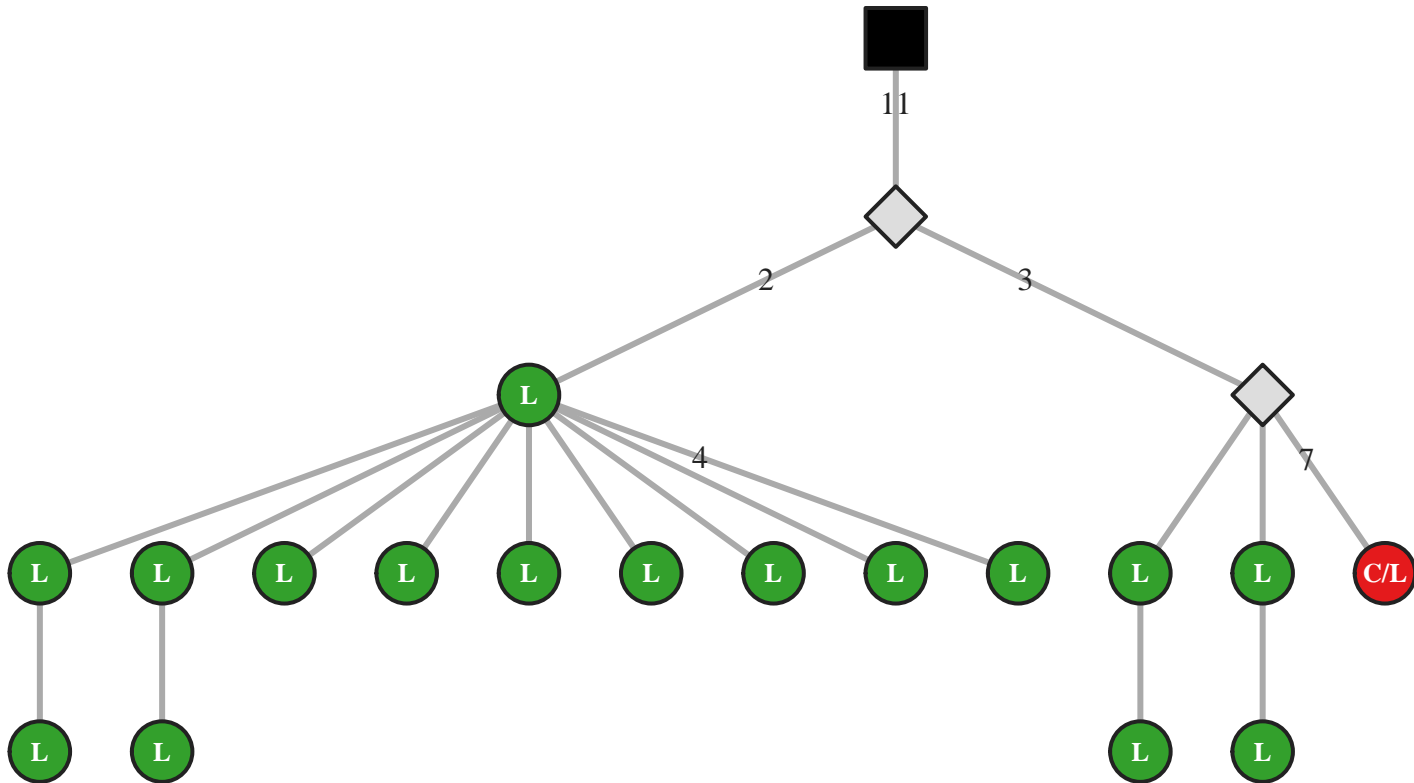

M5 IgG IGHV3-9/J4 51bp (27515)

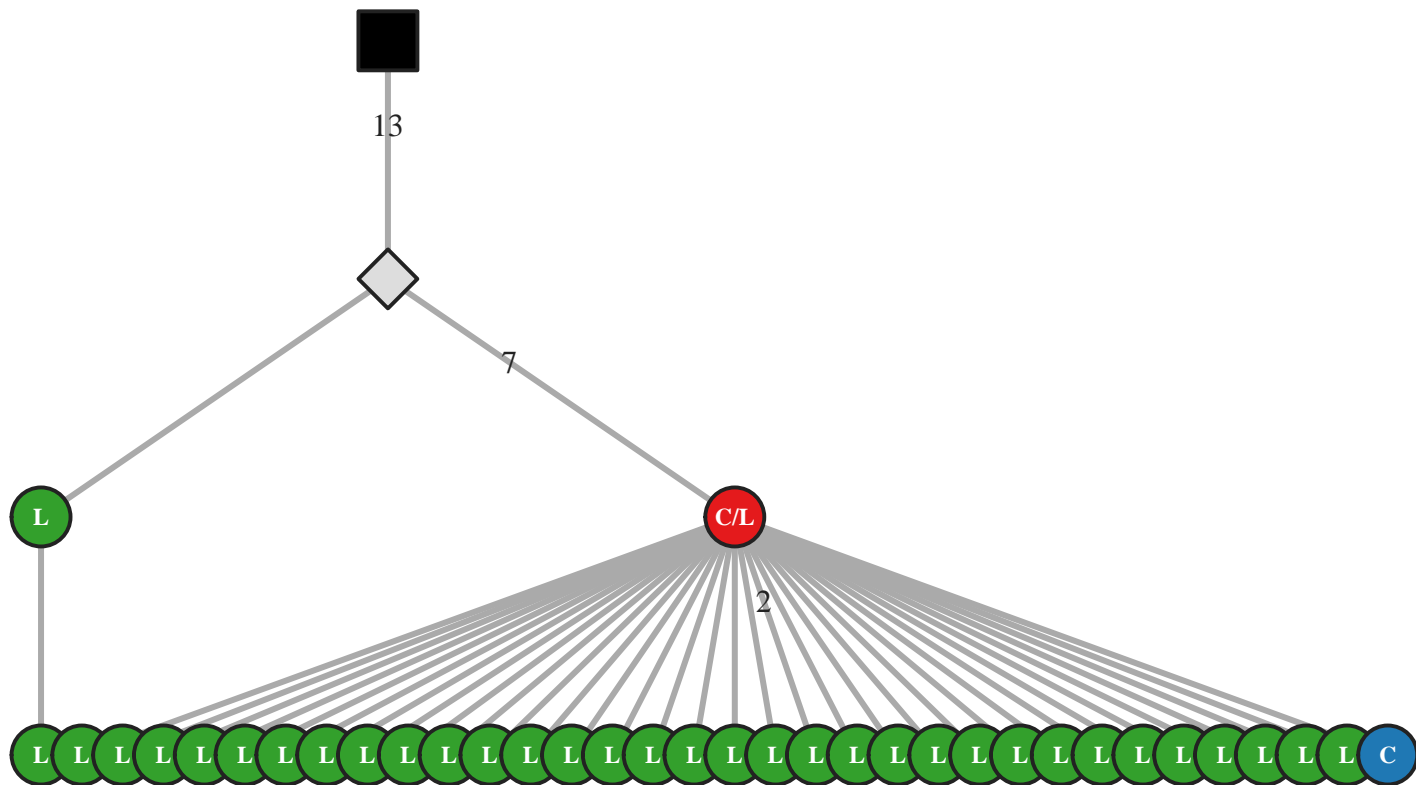

M5 IgG IGHV3-9/J4 54bp (45858)

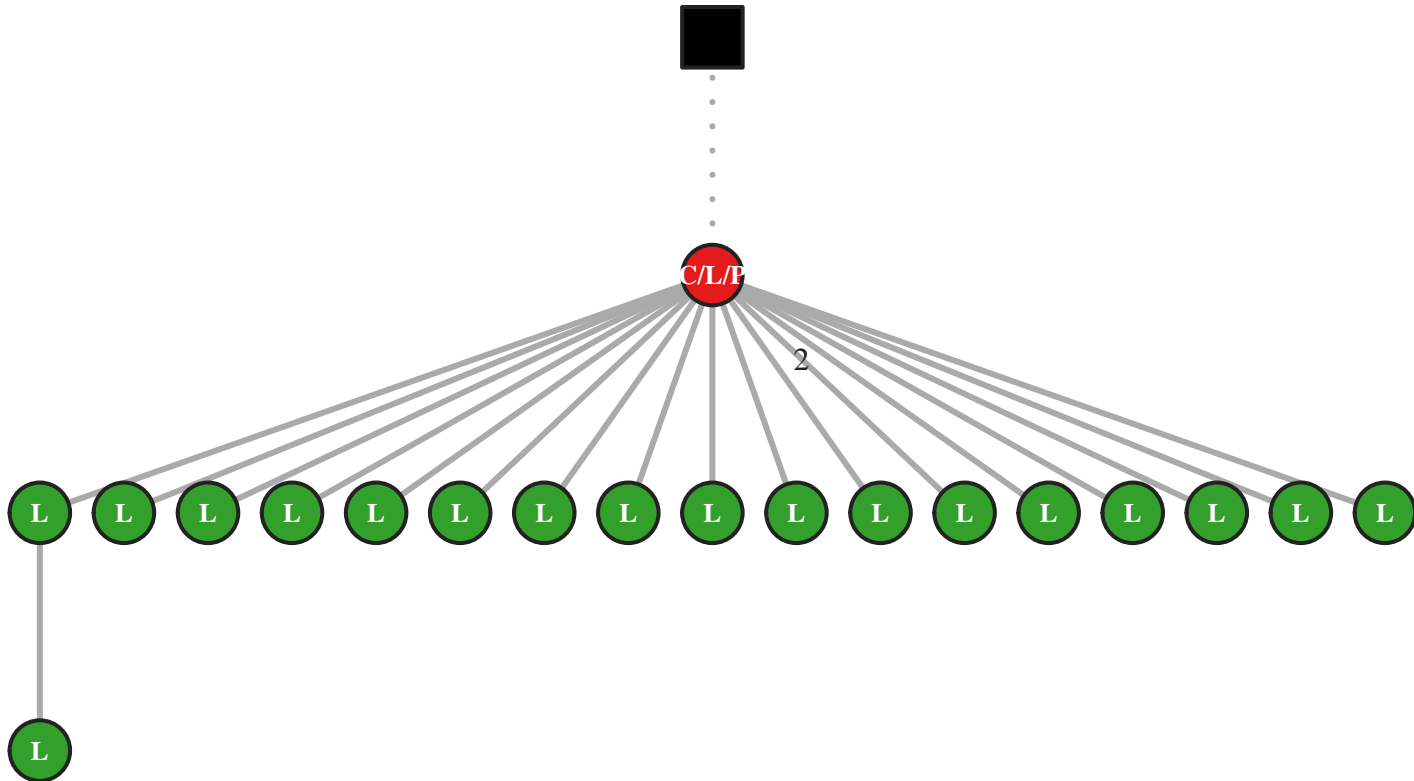

M5 IgG IGHV3-9/J4 54bp (45869)

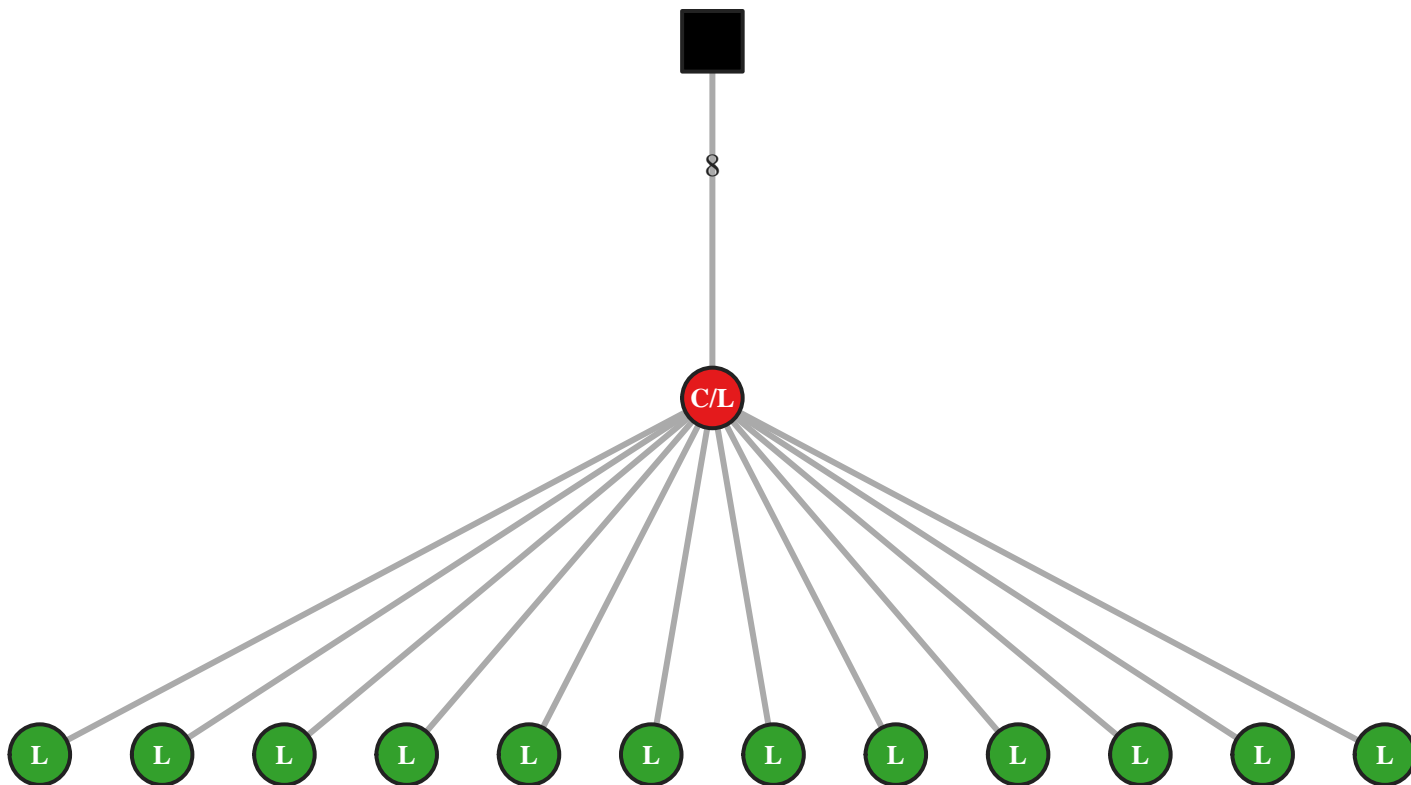

M5 IgG IGHV3-9/J4 54bp (45882)

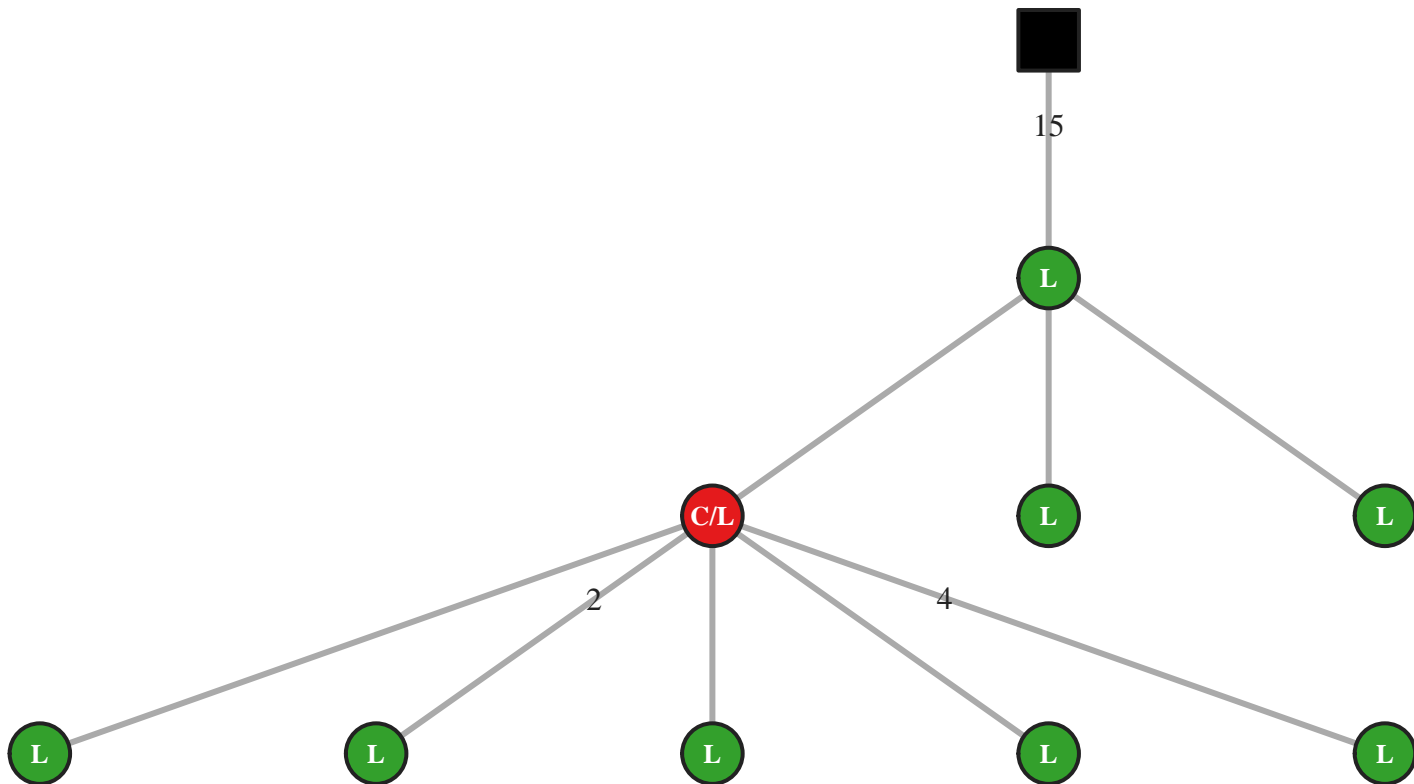

M5 IgG IGHV3-9/J4 54bp (45954)

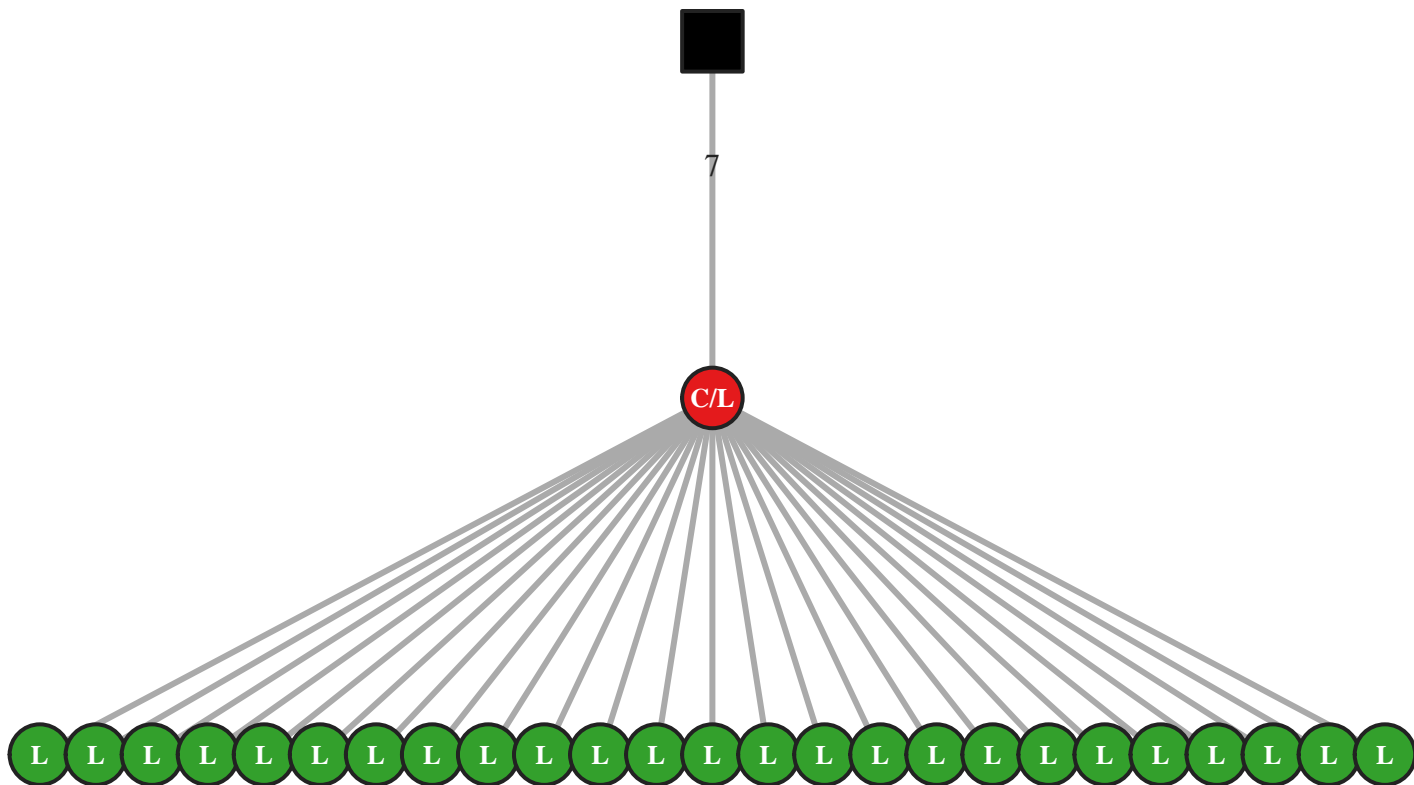

M5 IgG IGHV3-9/J4 60bp (9204)

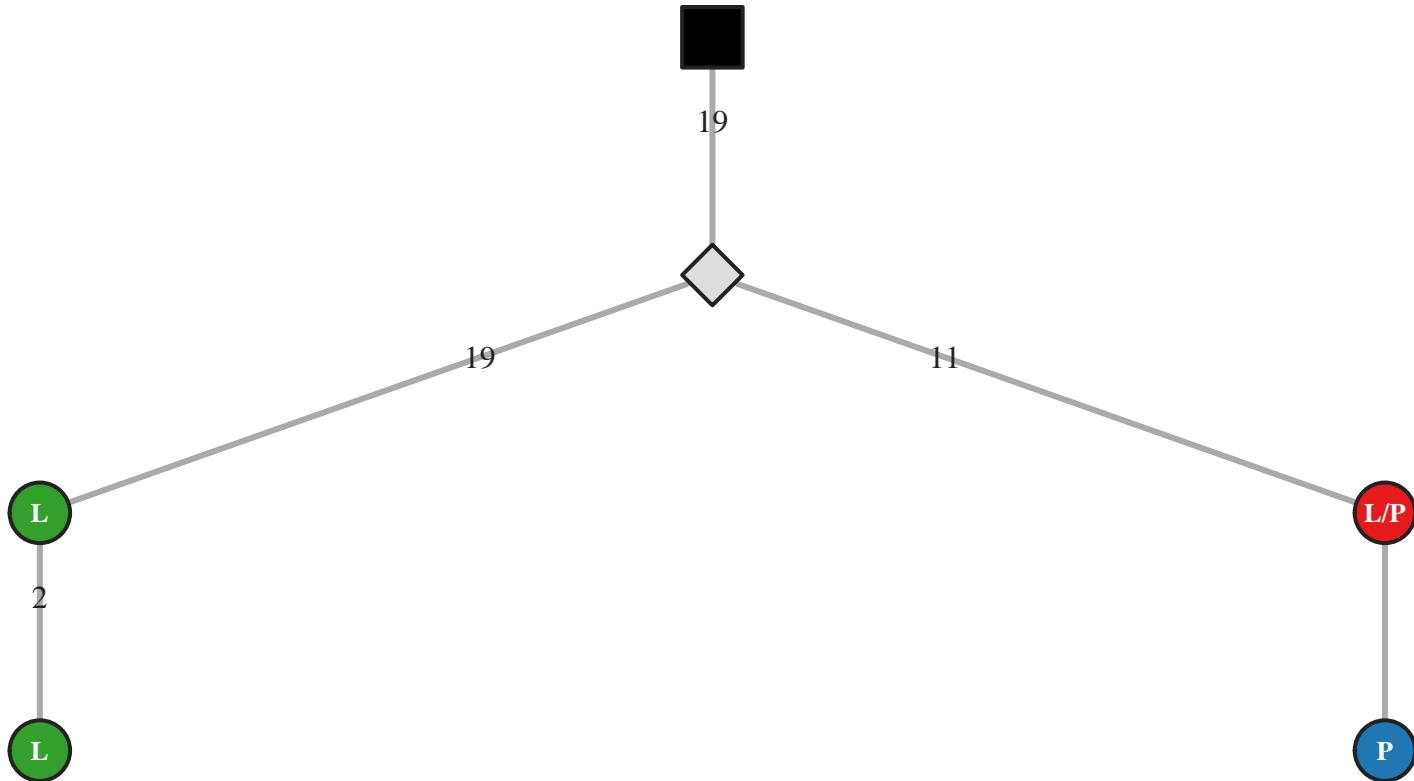

M5 IgG IGHV3-9/J4 60bp (9212)

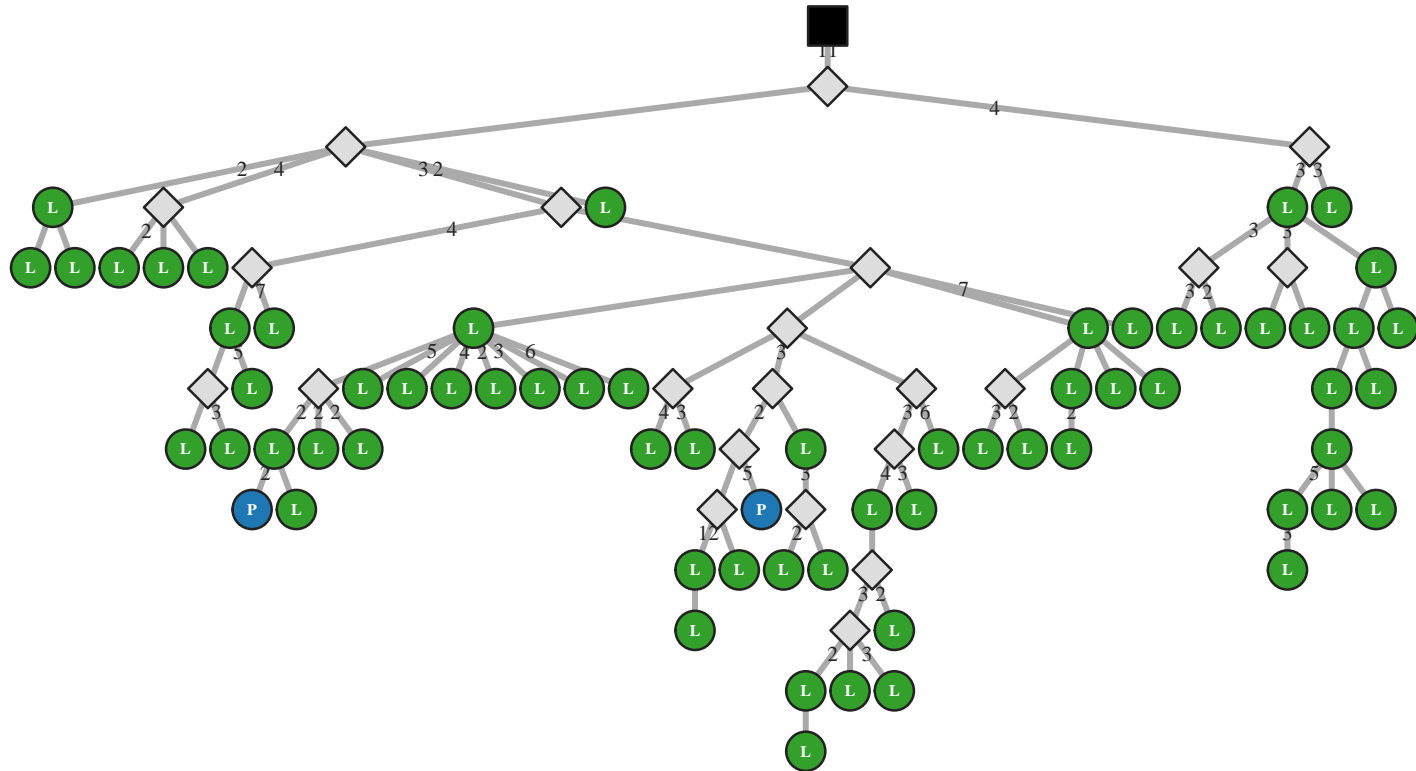

M5 IgG IGHV3-9/J5 48bp (45985)

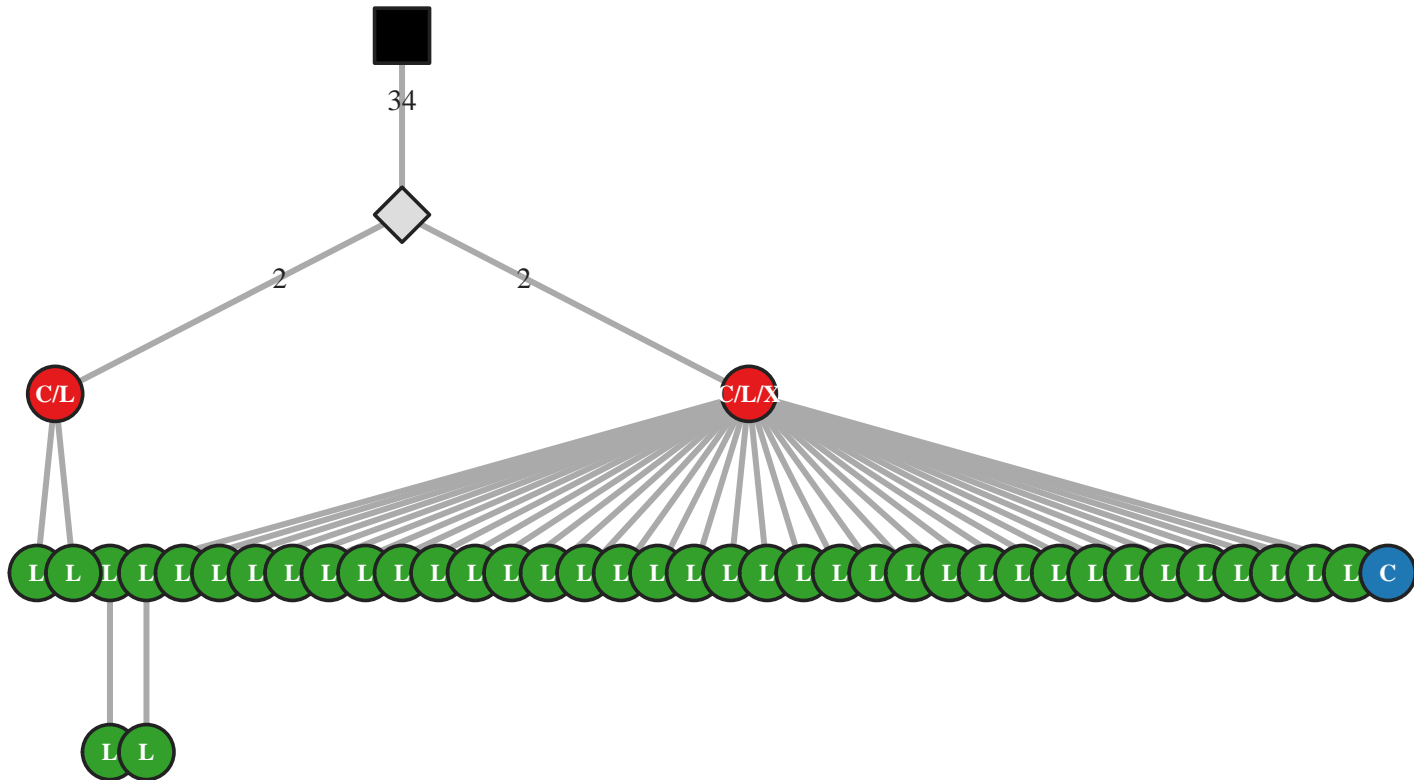

M5 IgG IGHV3-9/J5 51bp (9257)

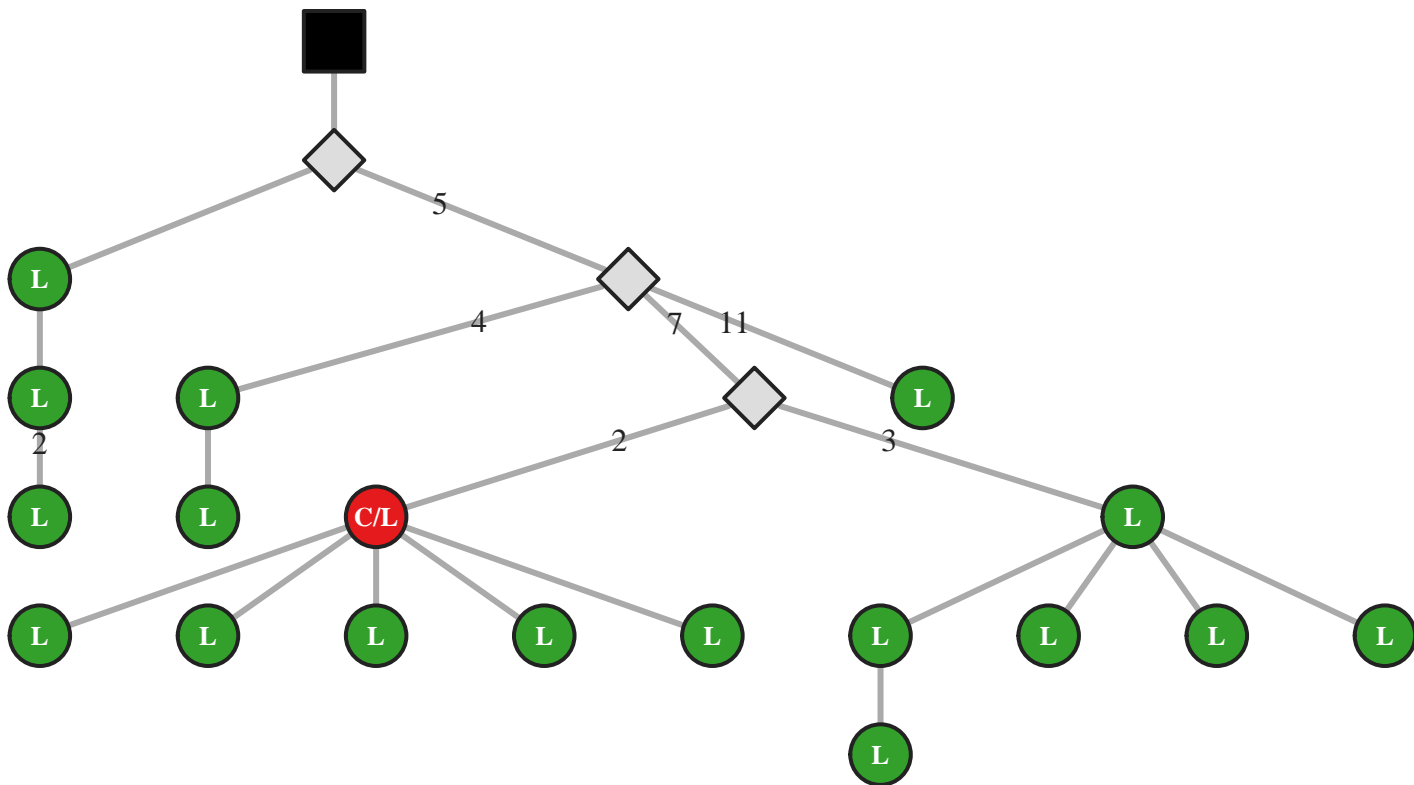

M5 IgG IGHV3-9/J5 54bp (18478)

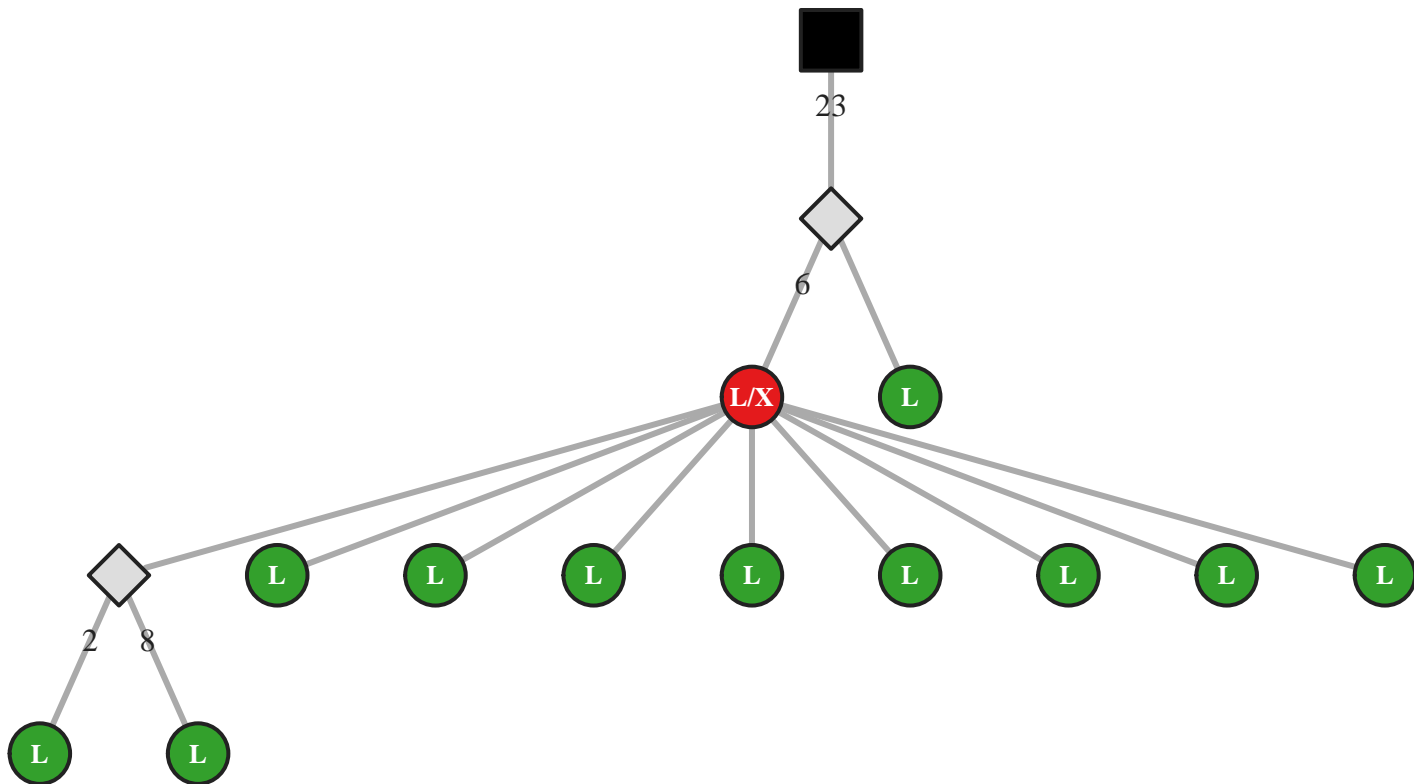

M5 IgG IGHV3-9/J5 54bp (18483)

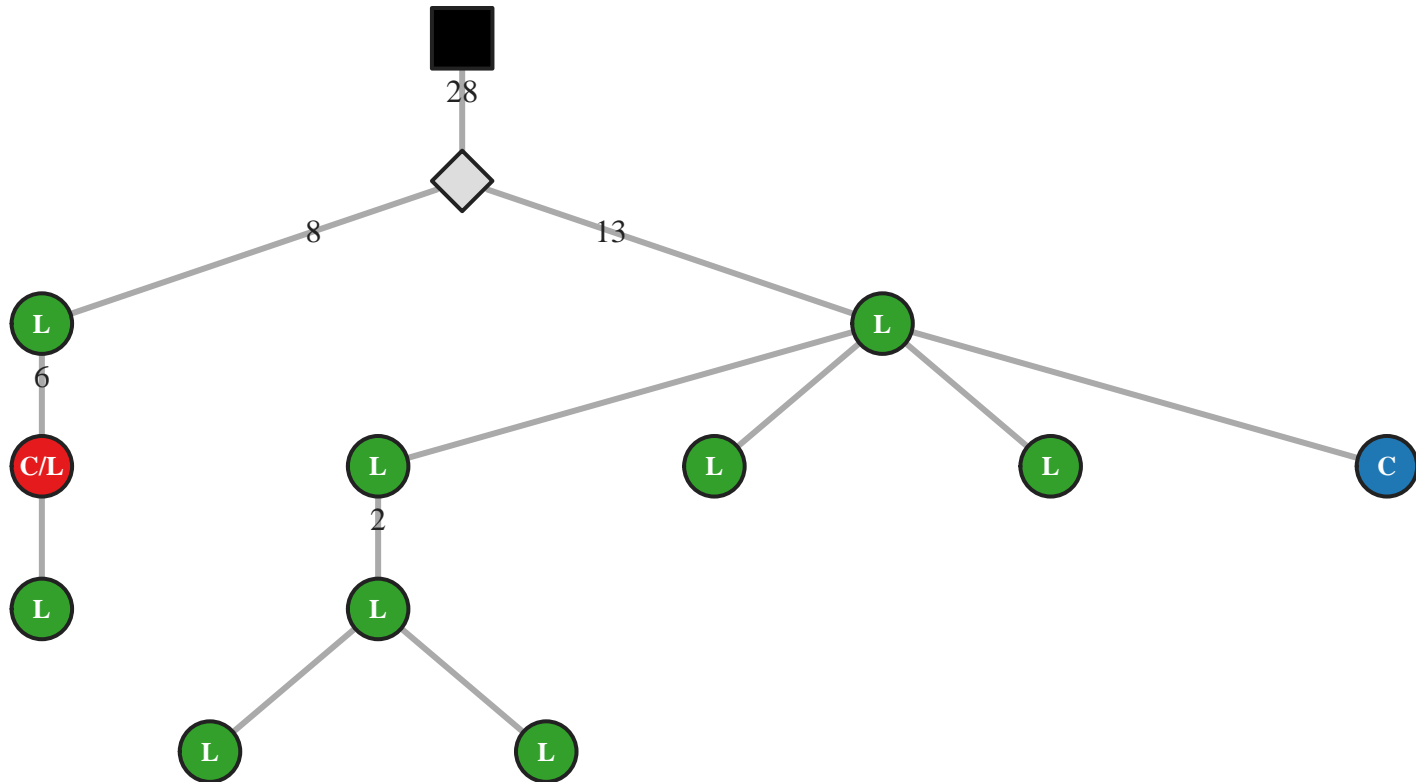

M5 IgG IGHV3-9/J5 54bp (18488)

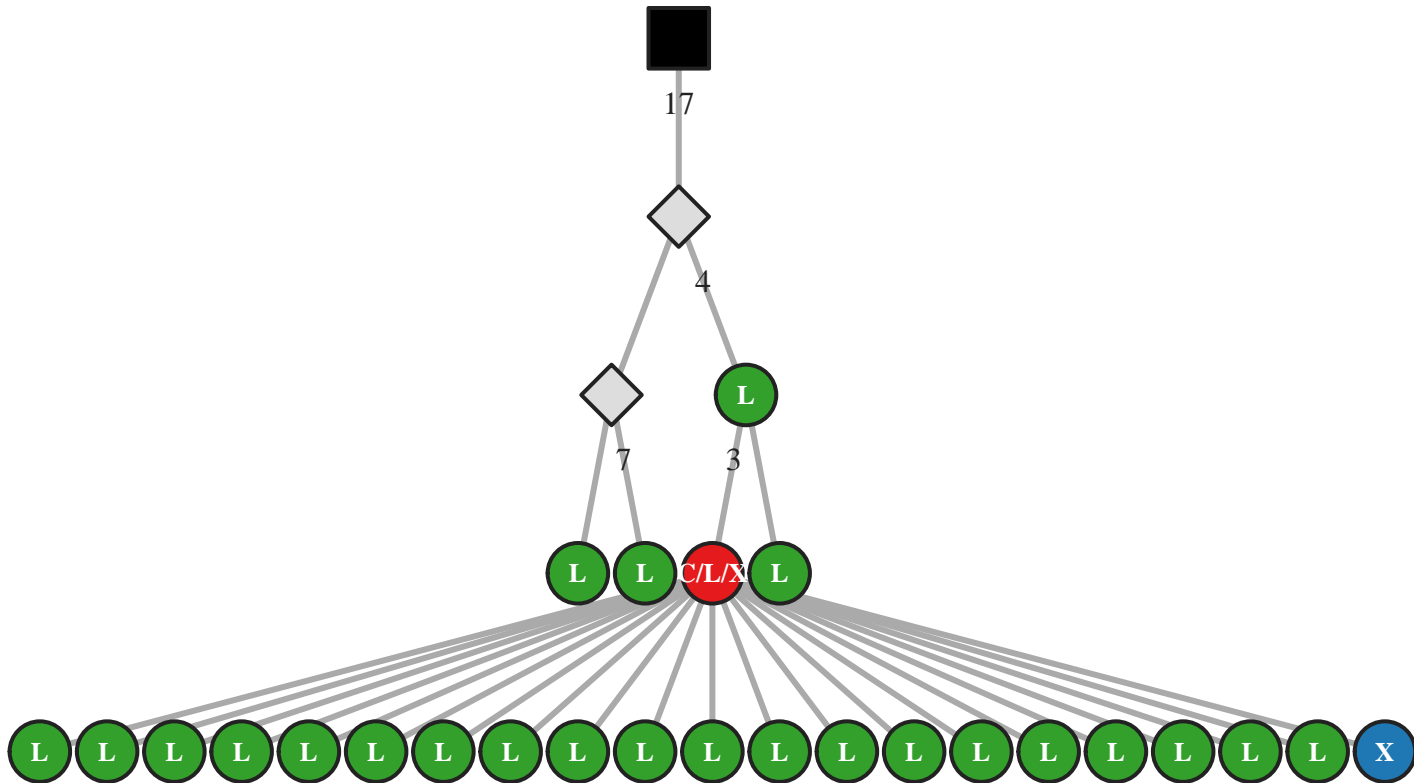

M5 IgG IGHV3-9/J6 42bp (9293)

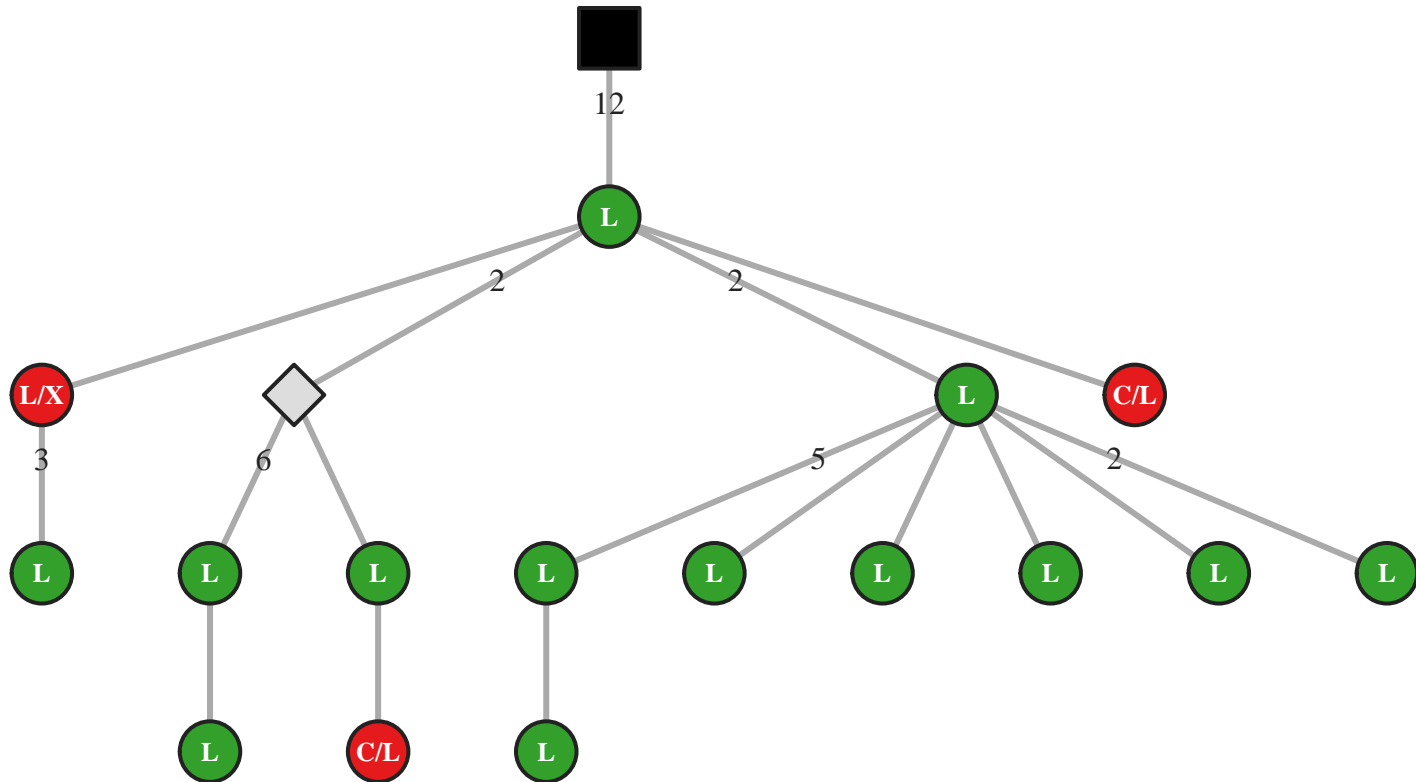

M5 IgG IGHV3-9/J6 48bp (52538)

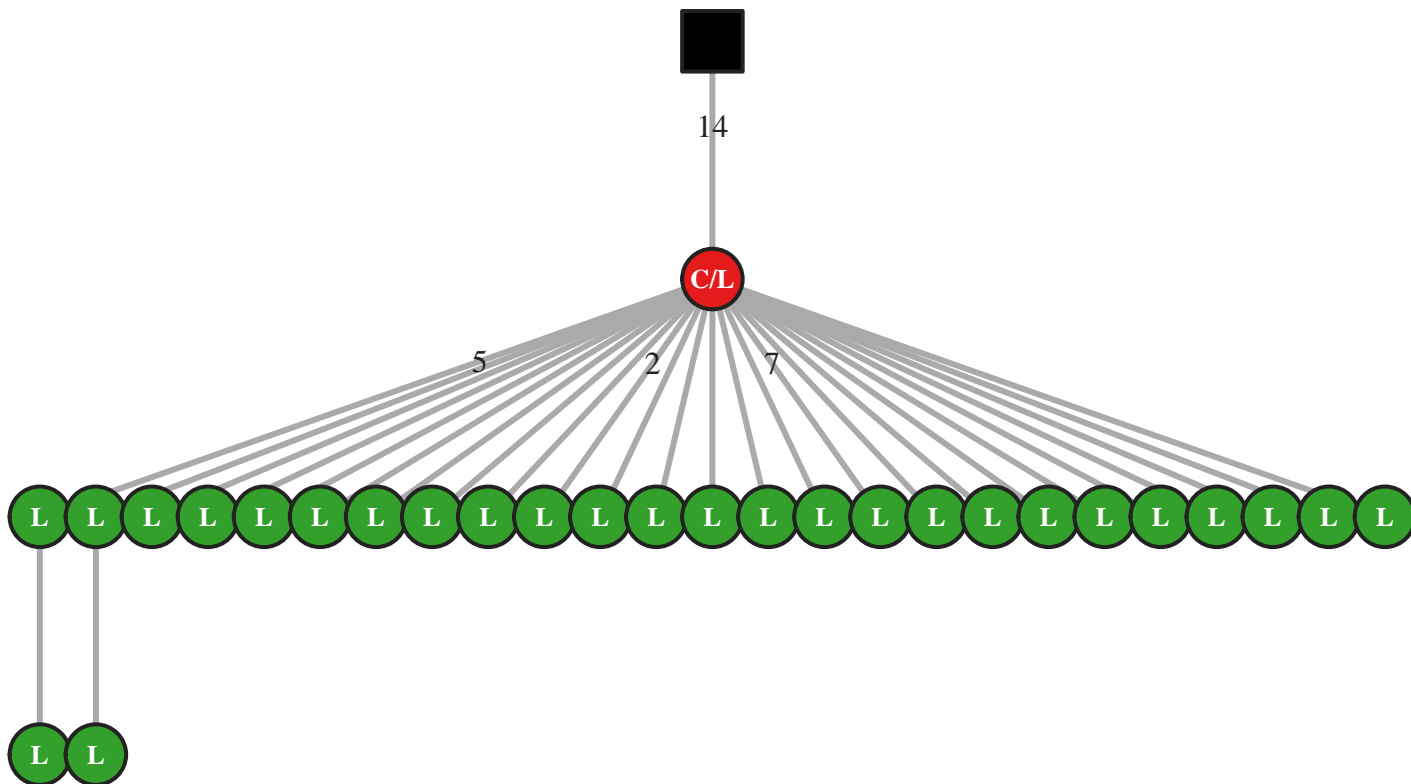

M5 IgG IGHV3-9/J6 51bp (46004)

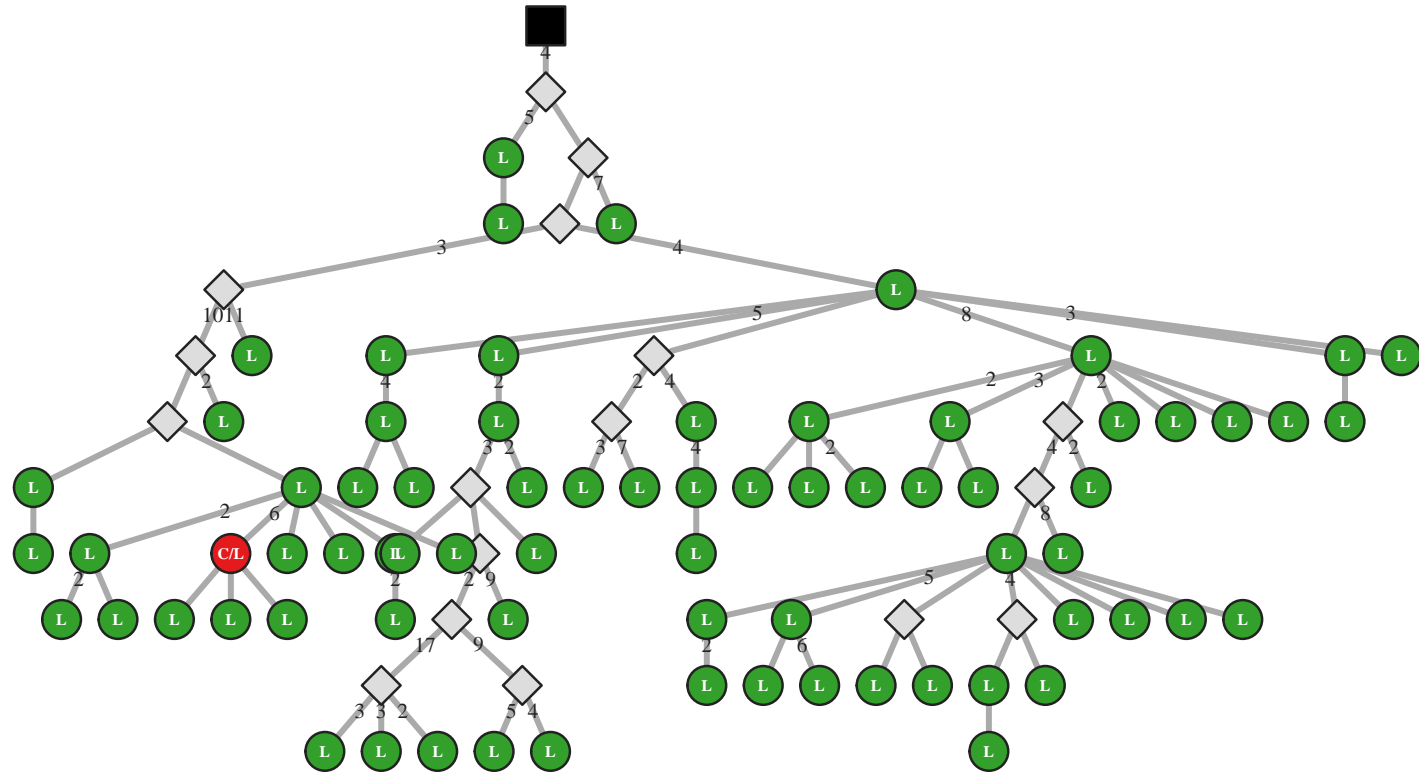

M5 IgG IGHV3-9/J6 57bp (18558)

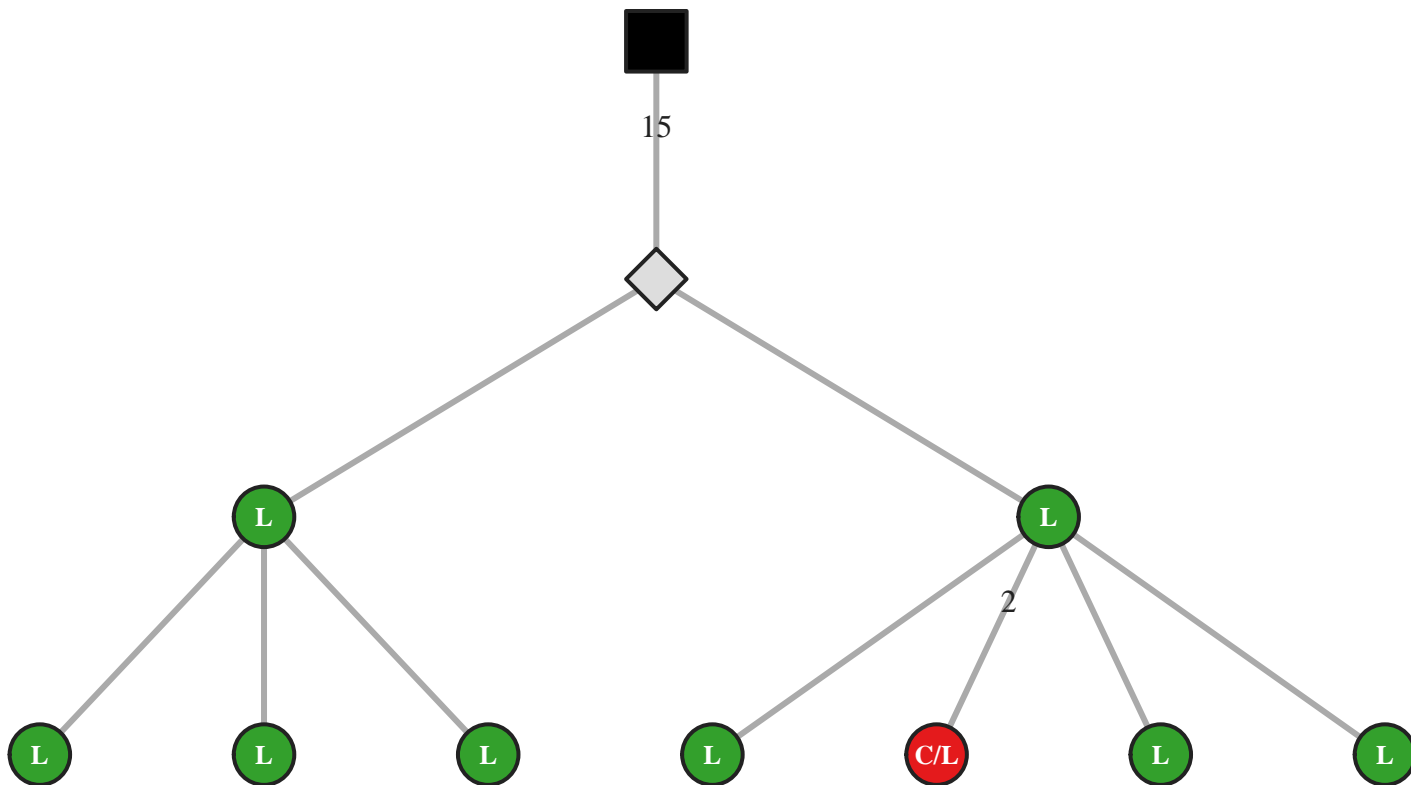

M5 IgG IGHV3-9/J6 57bp (18592)

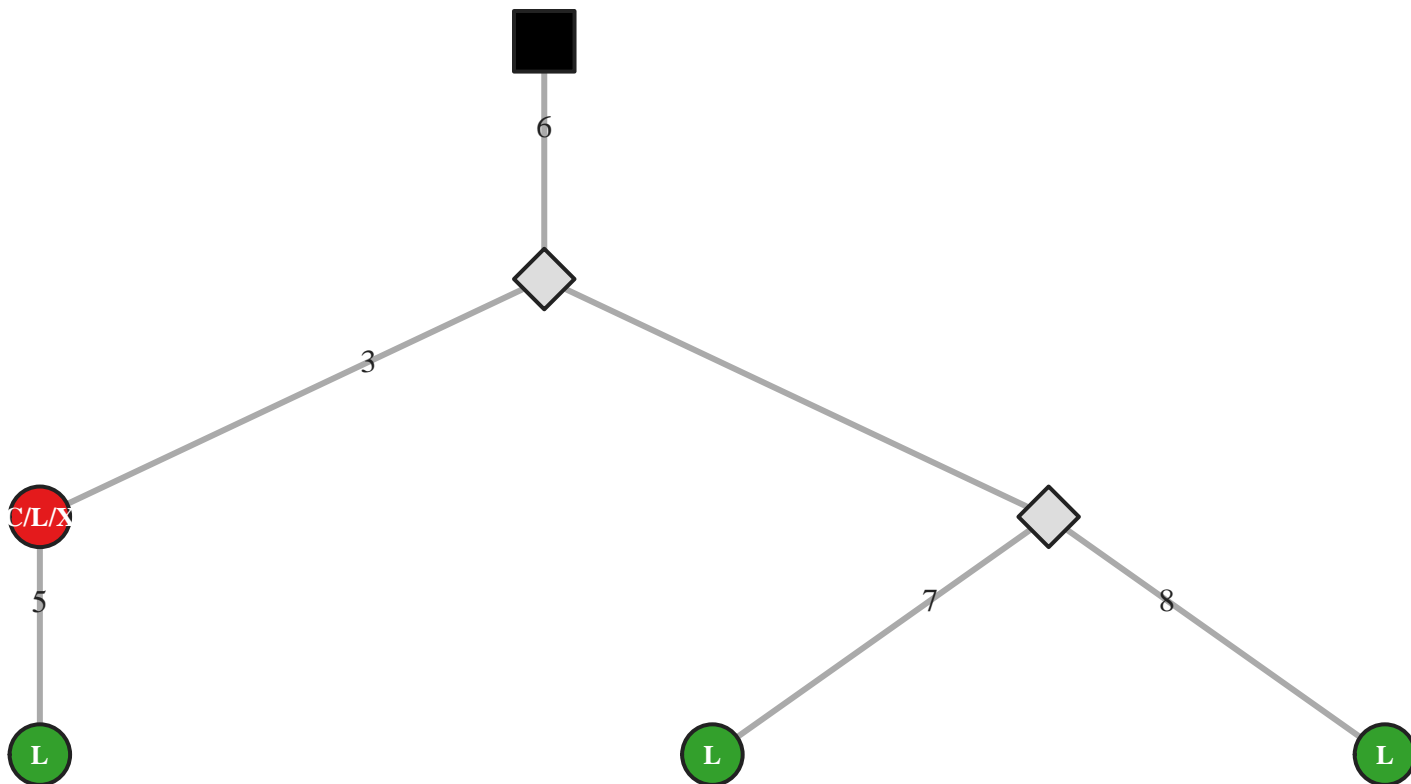

M5 IgG IGHV3-9/J6 60bp (18609)

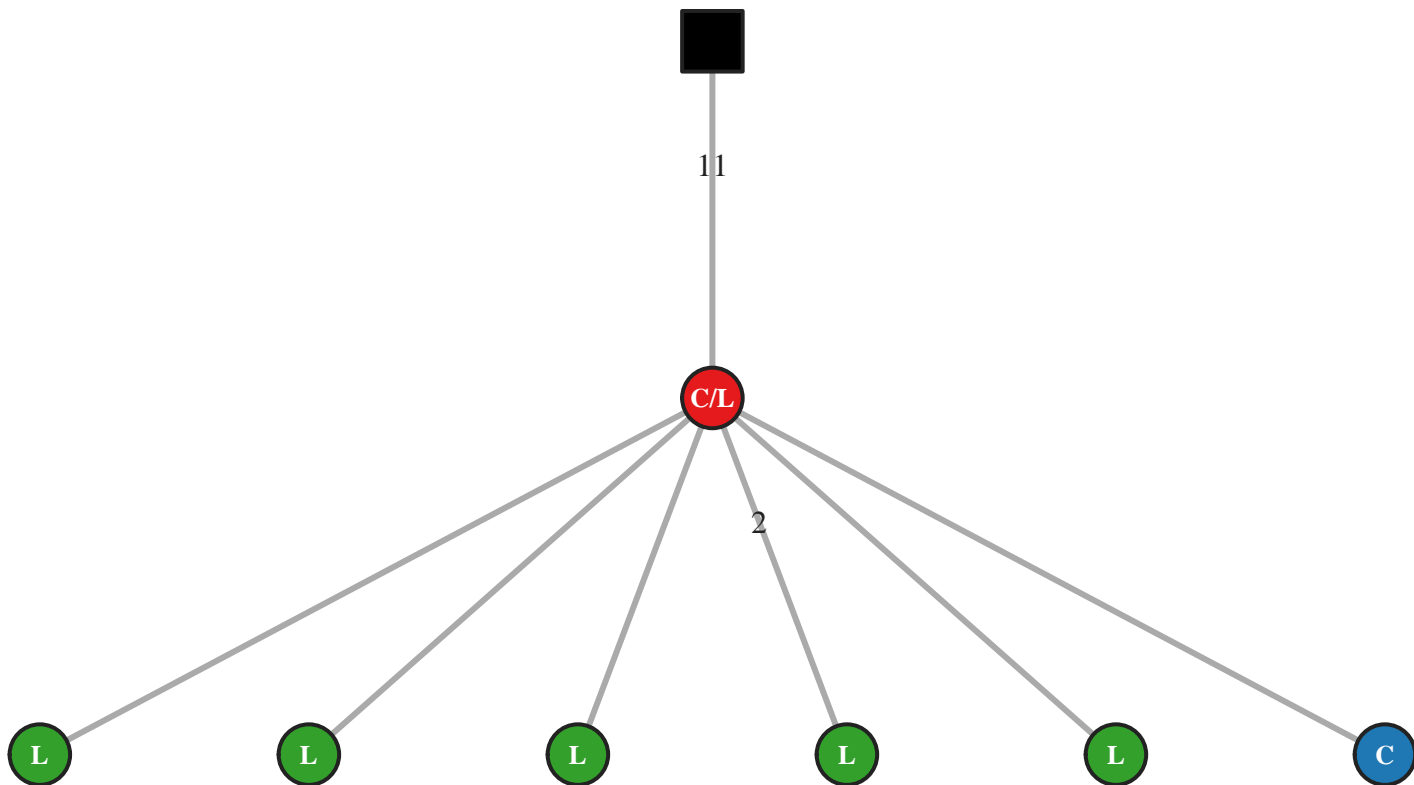

M5 IgG IGHV3-9/J6 60bp (18618)

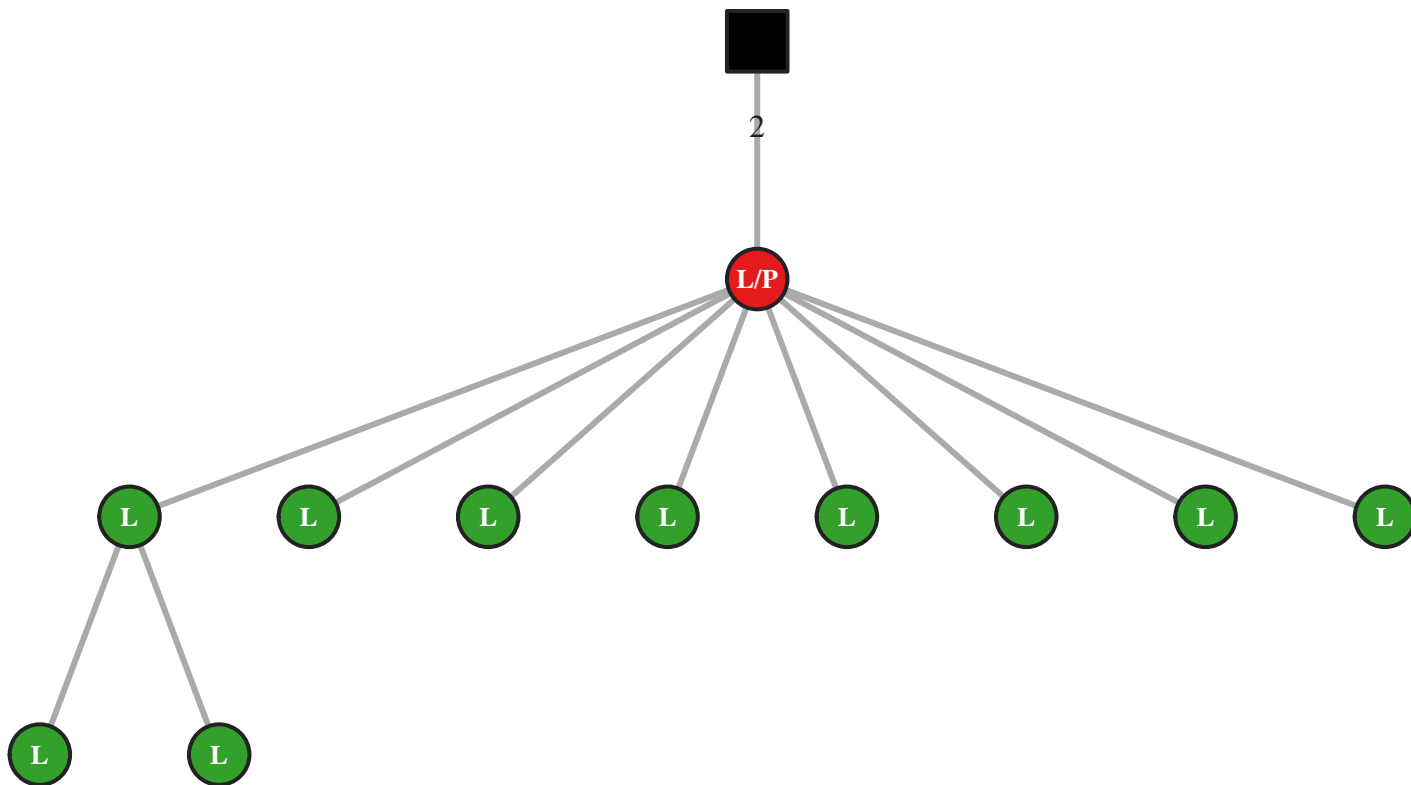

M5 IgG IGHV3-9/J6 60bp (18630)

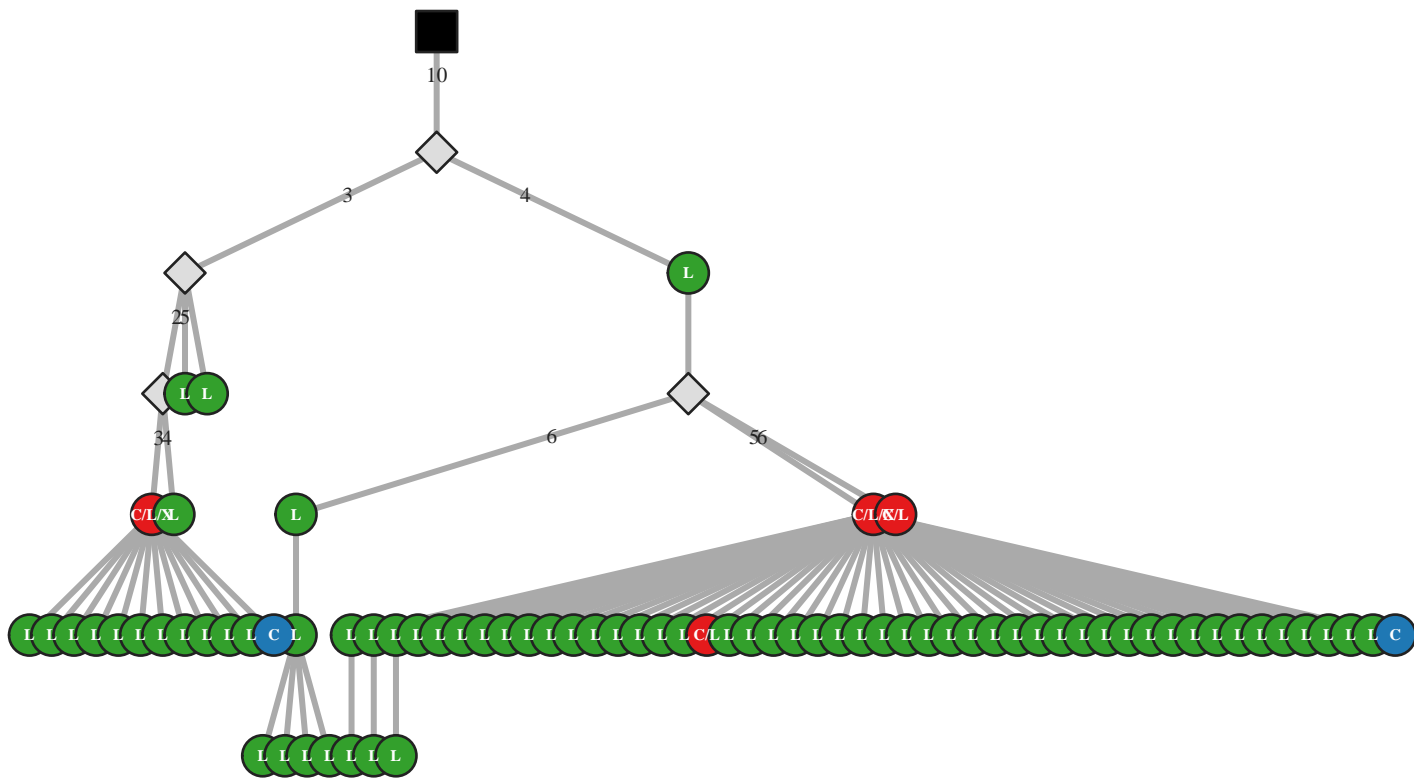

M5 IgG IGHV3-9/J6 63bp (35871)

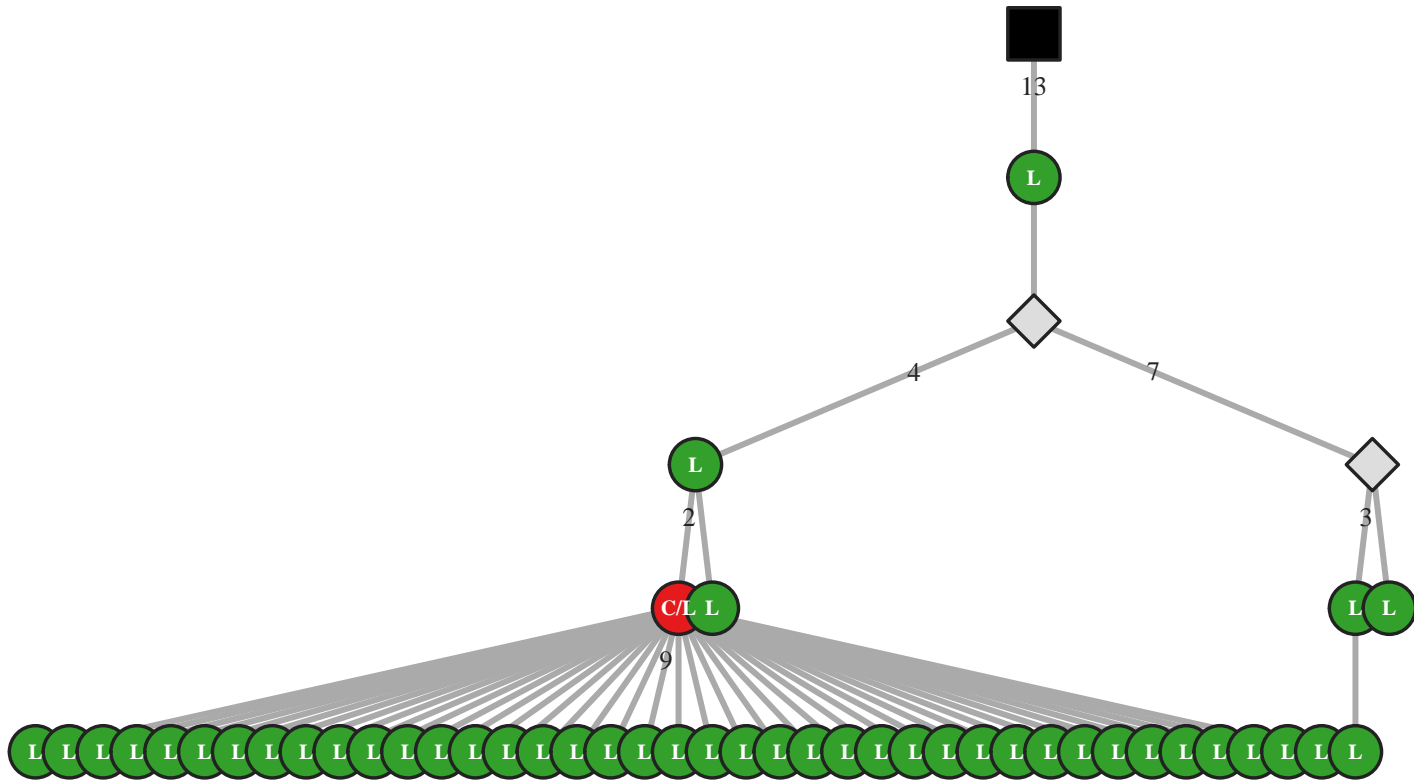

M5 IgG IGHV3-9/J6 72bp (18649)

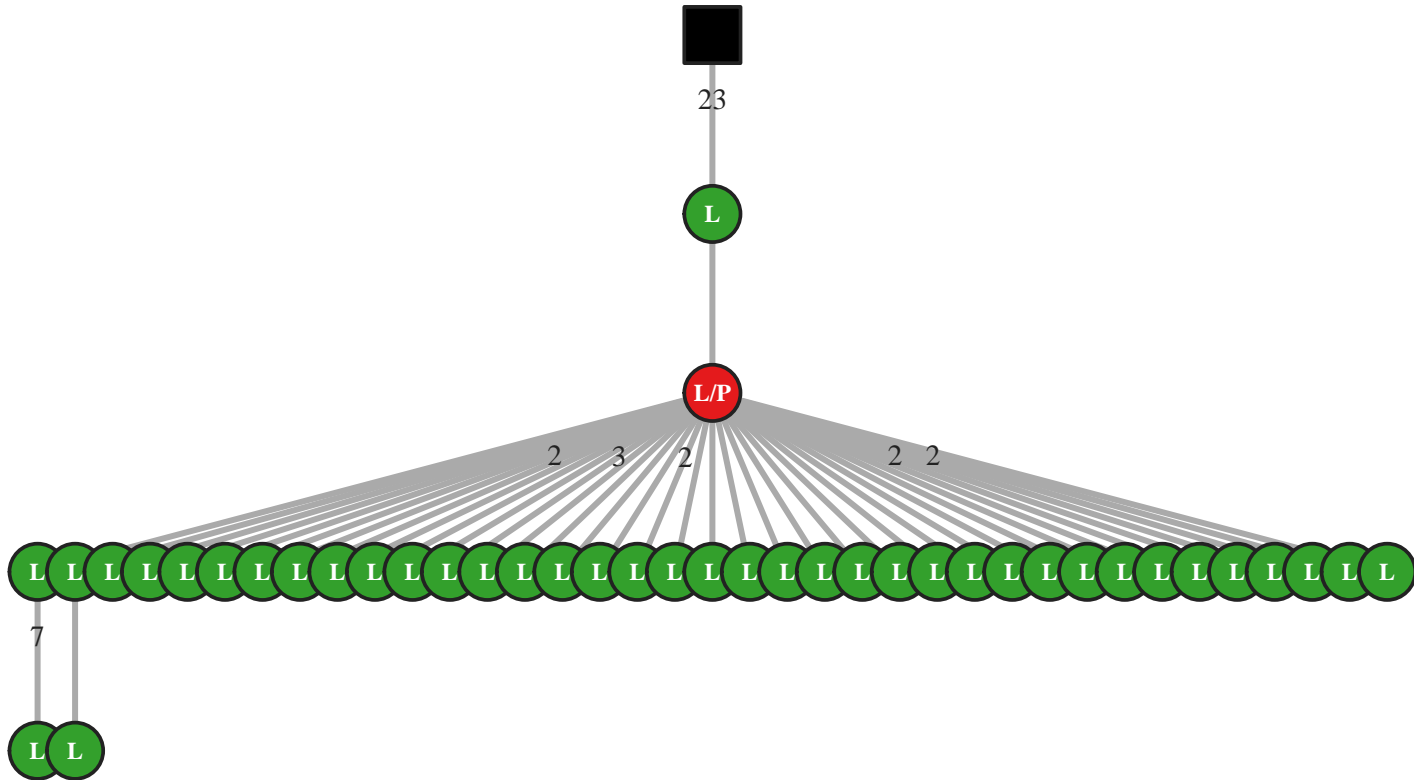

M5 IgG IGHV3-9/J6 72bp (18662)

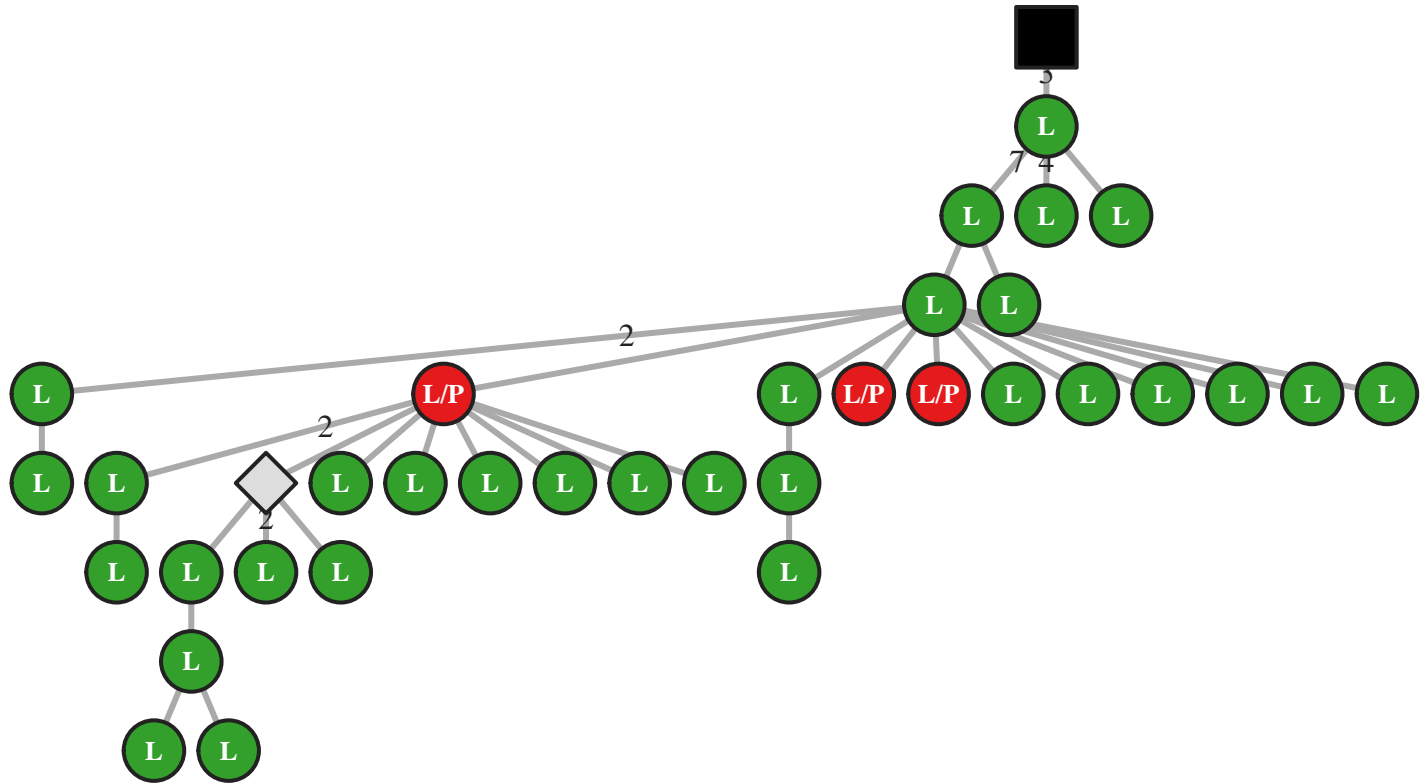

M5 IgG IGHV3/J4 54bp (18666)

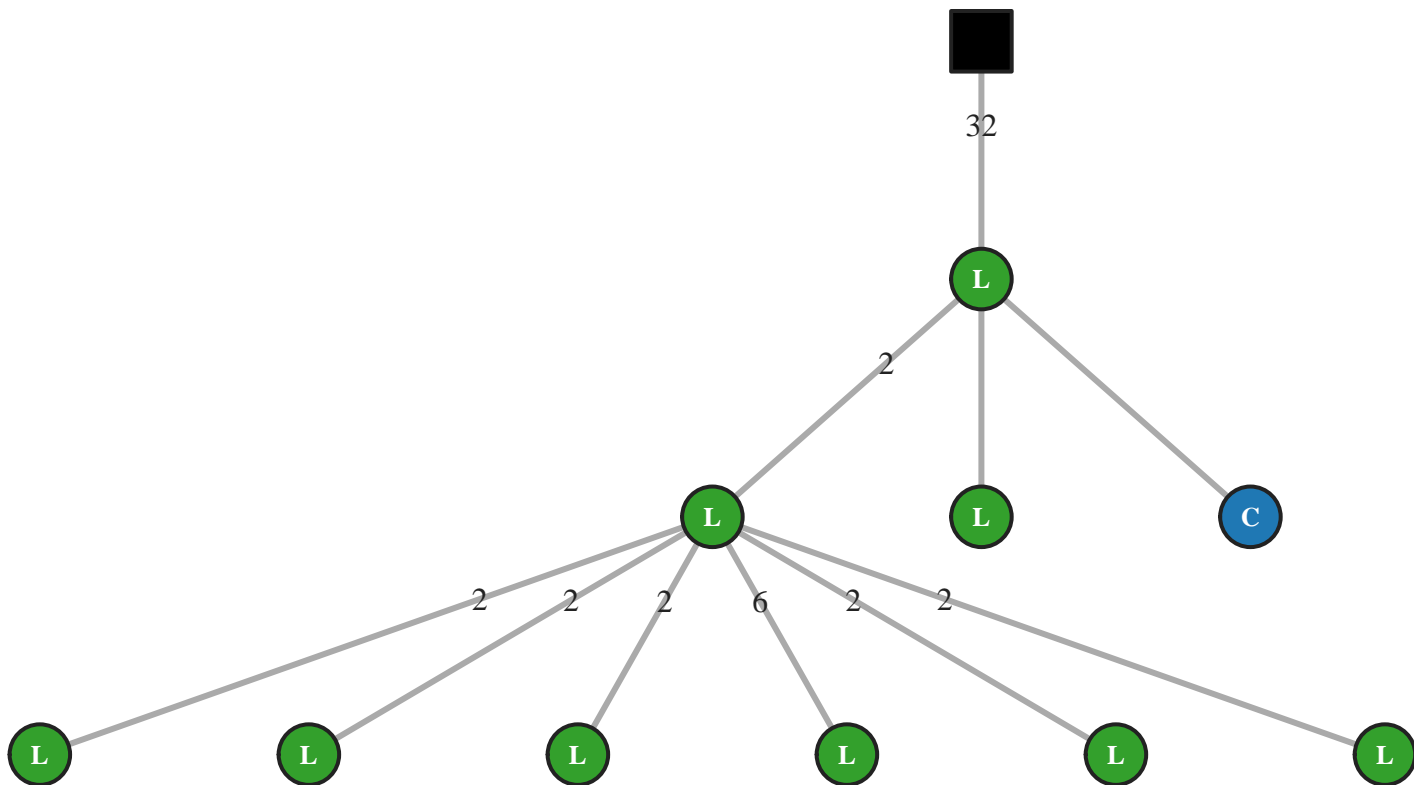

M5 IgG IGHV4-30-2/J3 45bp (9315)

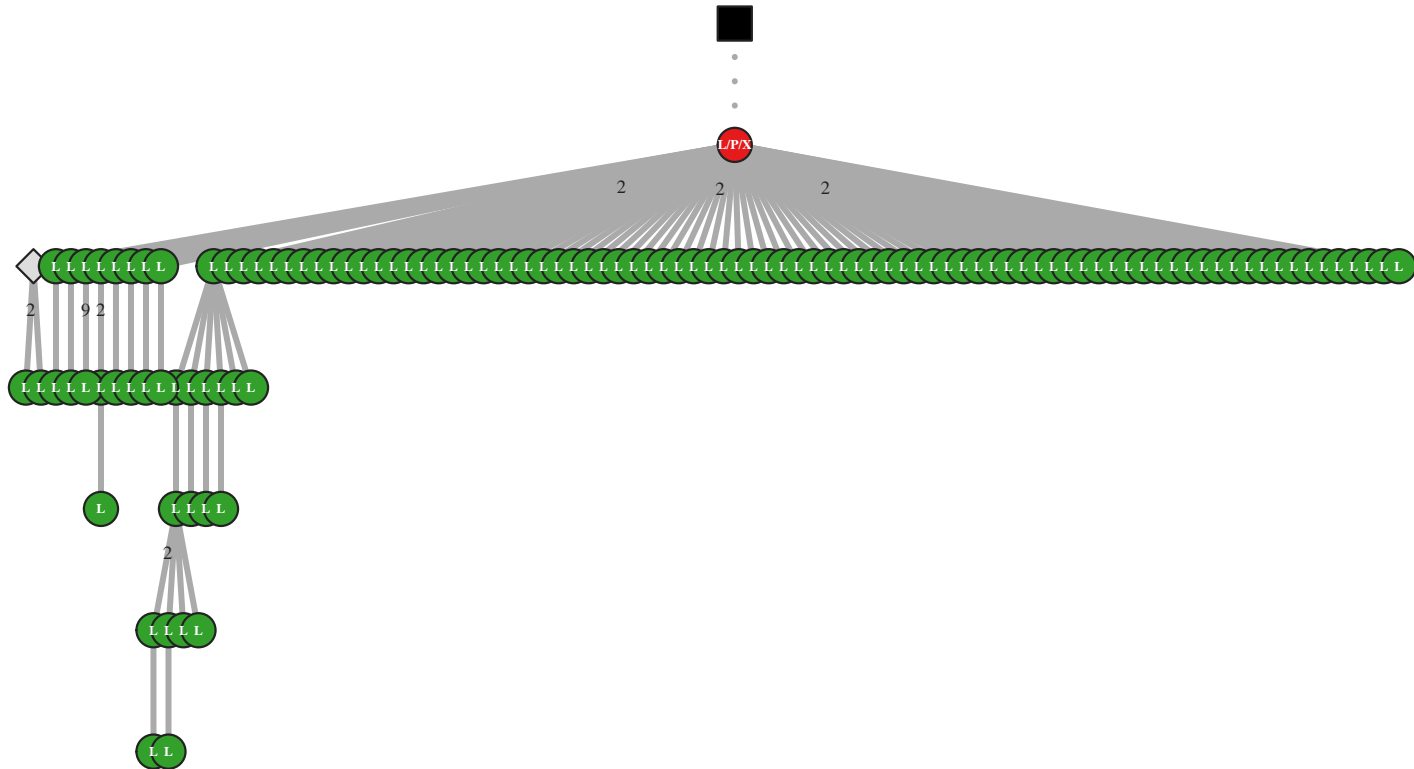

M5 IgG IGHV4-30-2/J3 51bp (18668)

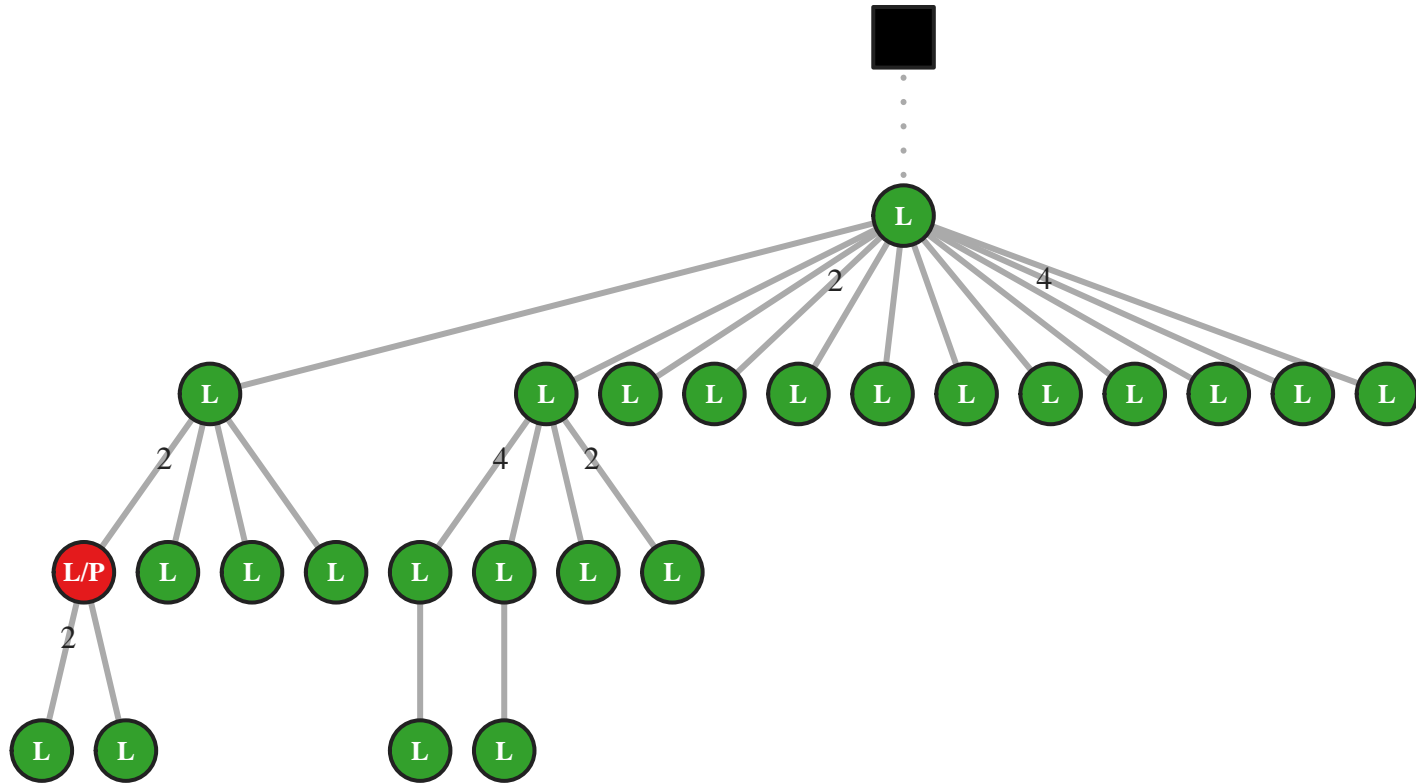

M5 IgG IGHV4-30-2/J3 66bp (18672)

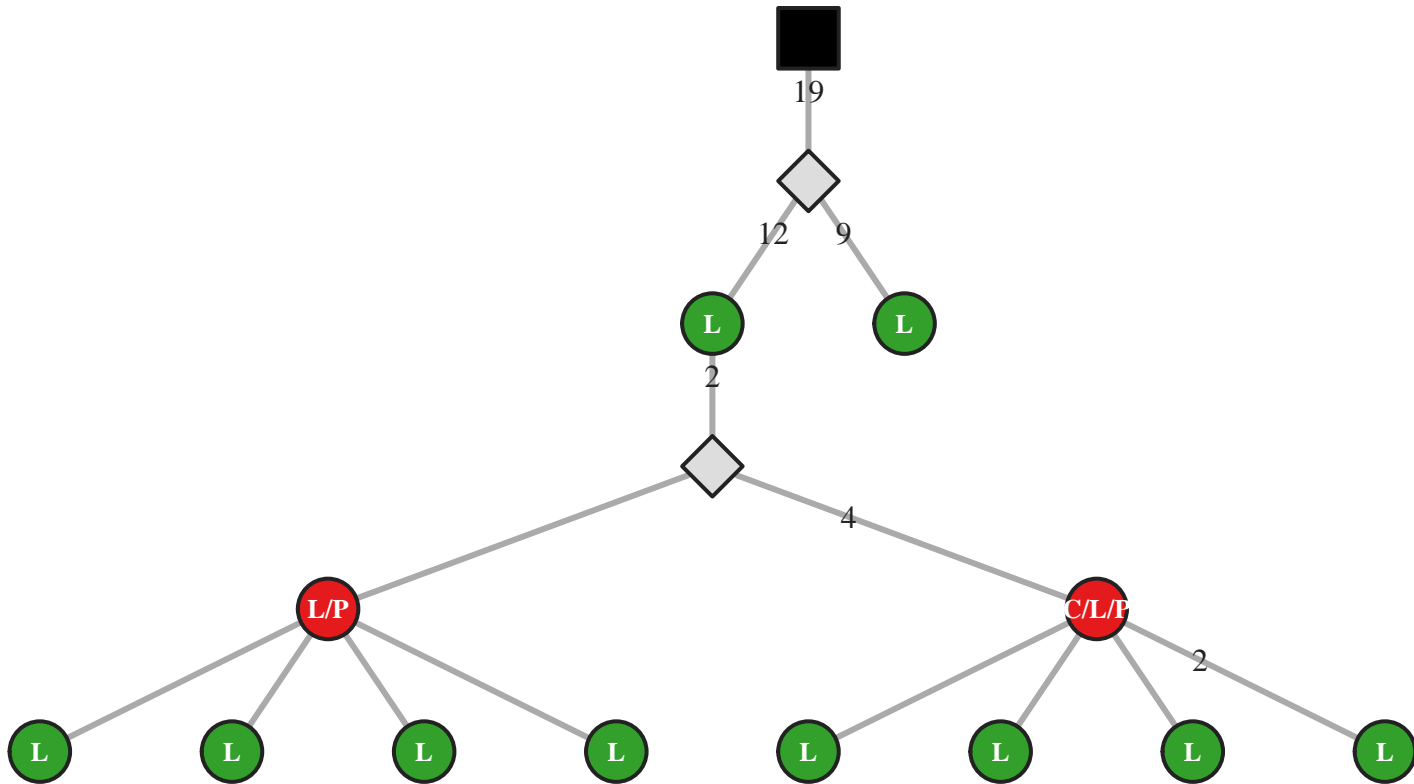

M5 IgG IGHV4-30-2/J4 33bp (9320)

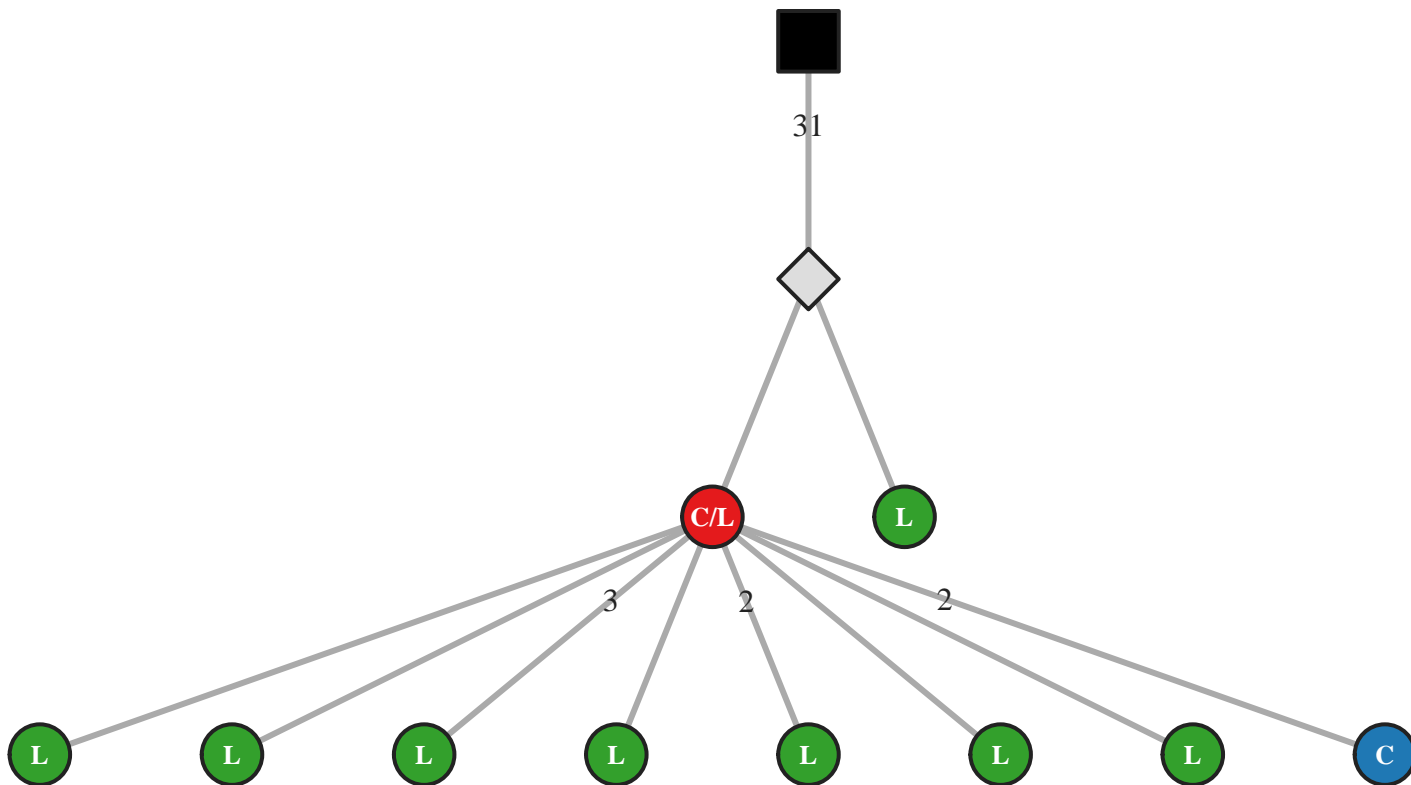

M5 IgG IGHV4-30-2/J4 33bp (9322)

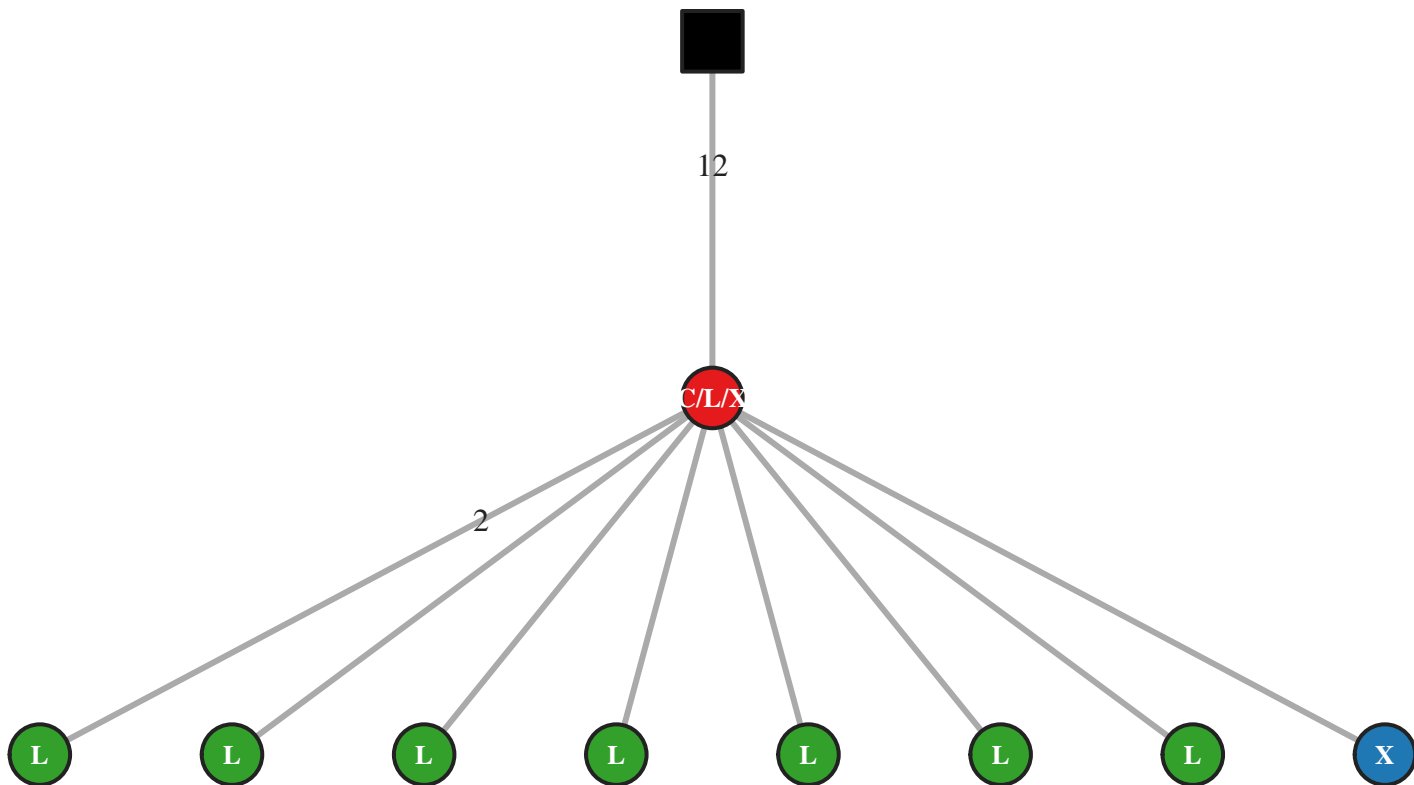

M5 IgG IGHV4-30-2/J4 51bp (46077)

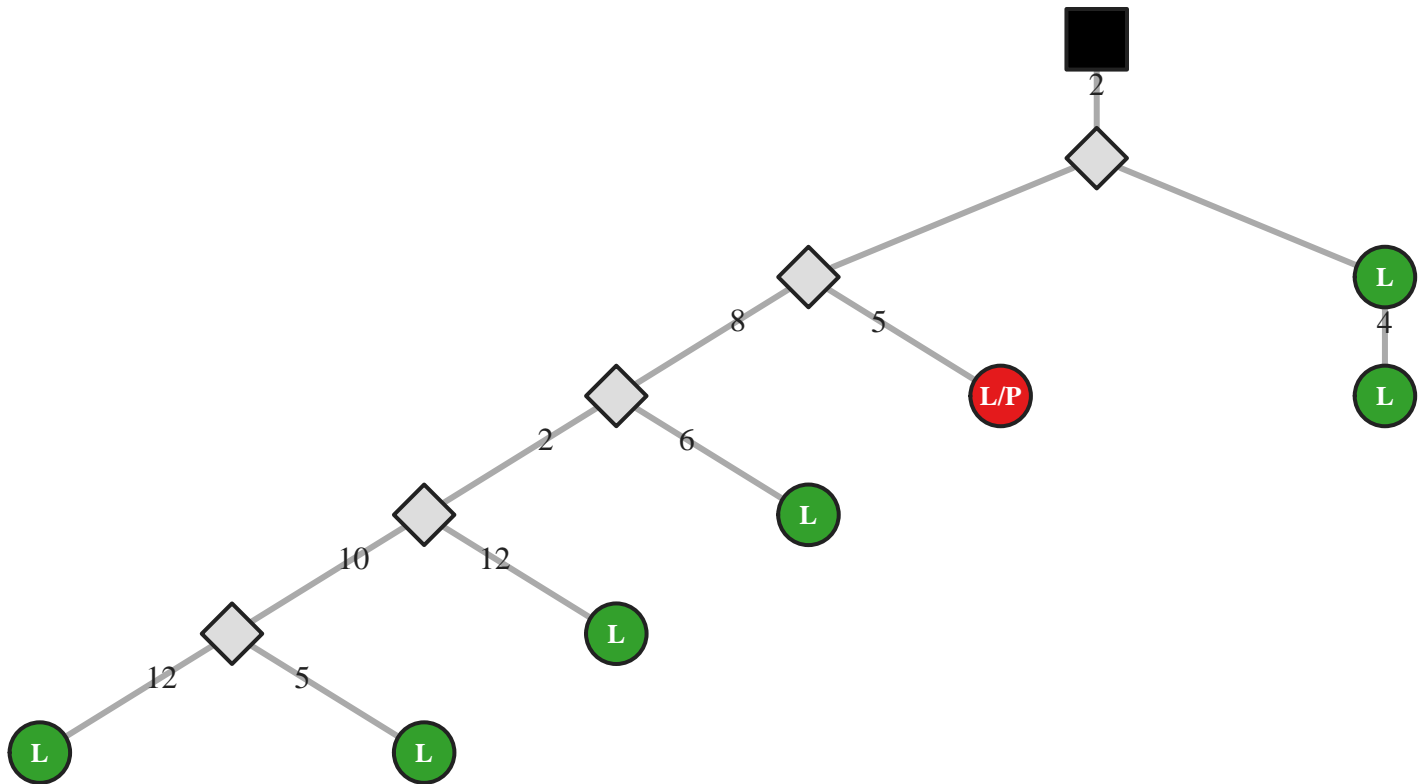

M5 IgG IGHV4-30-2/J4 54bp (46086)

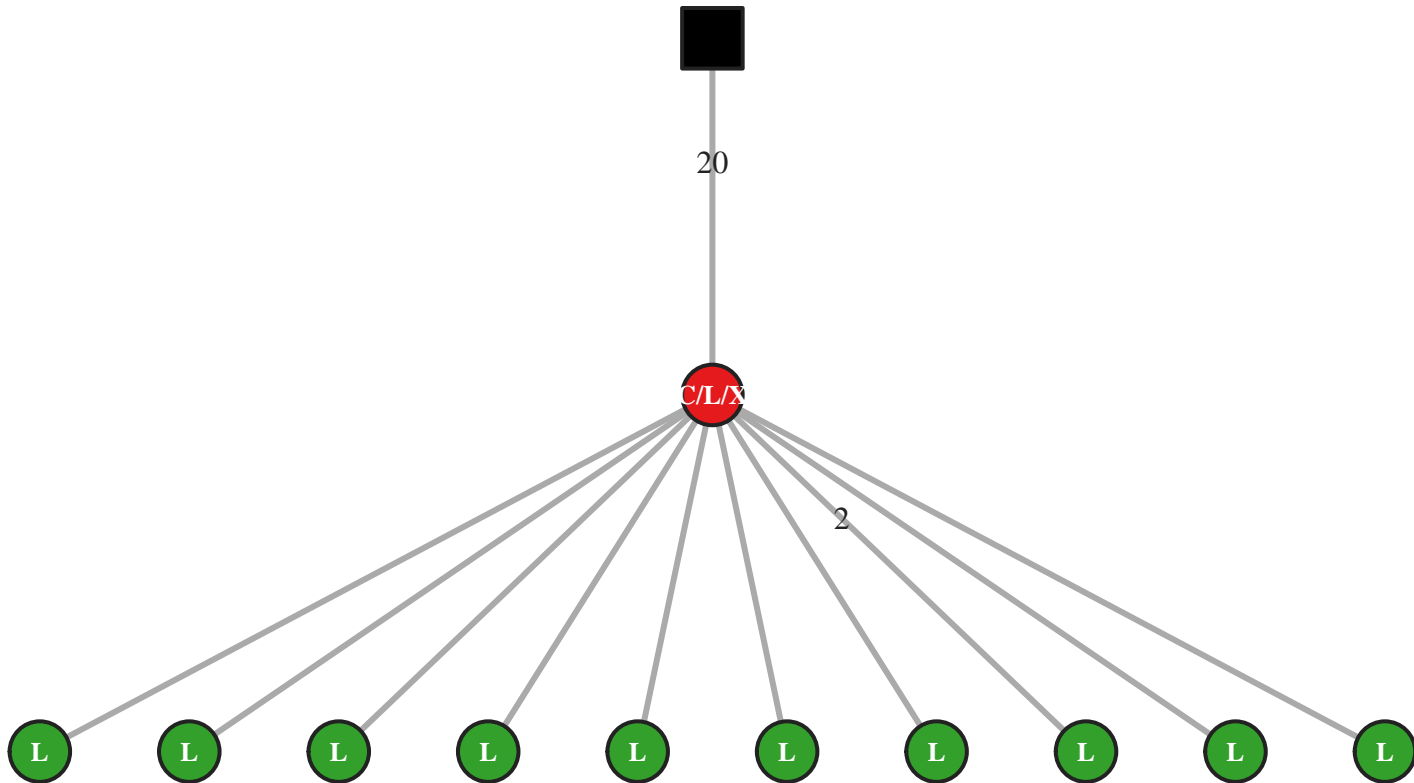

M5 IgG IGHV4-30-2/J5 39bp (9326)

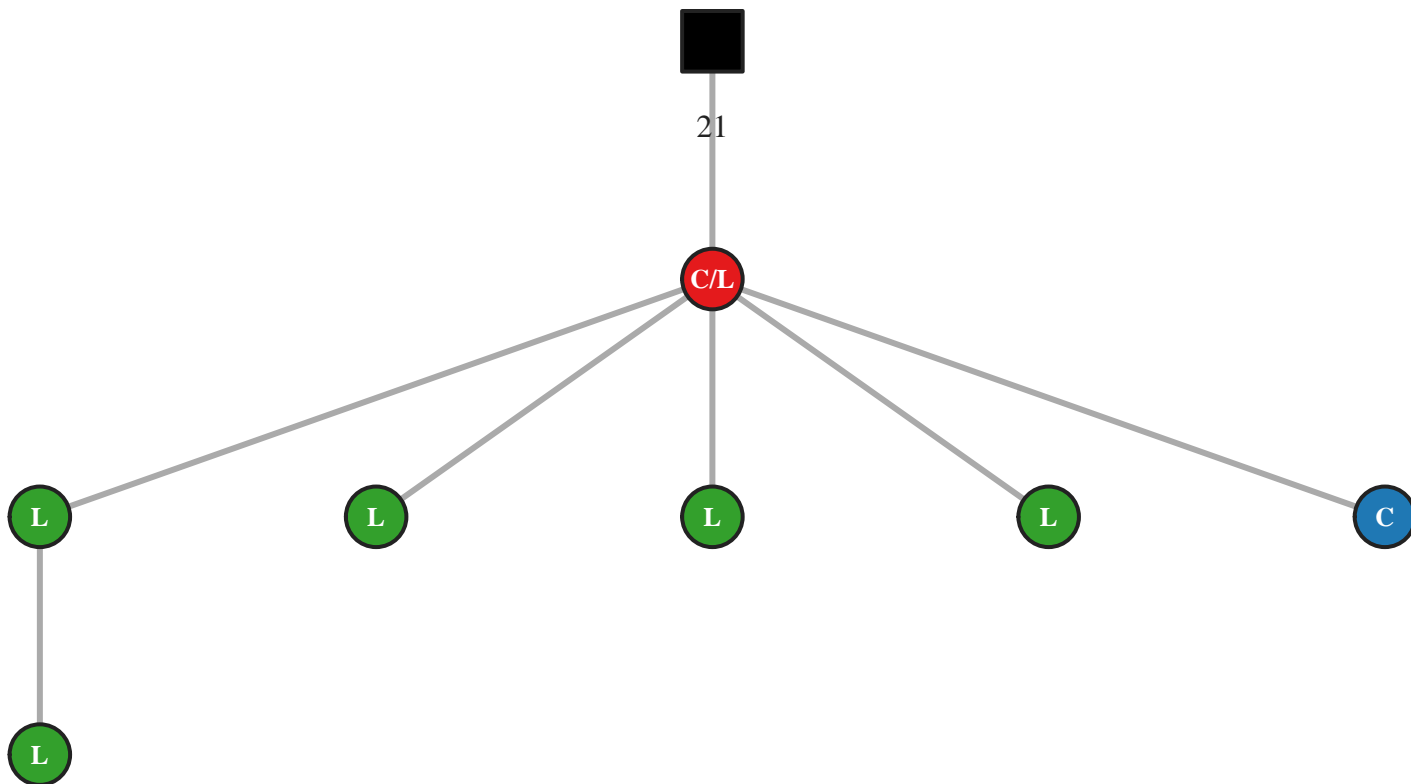

M5 IgG IGHV4-30-2/J5 45bp (9464)

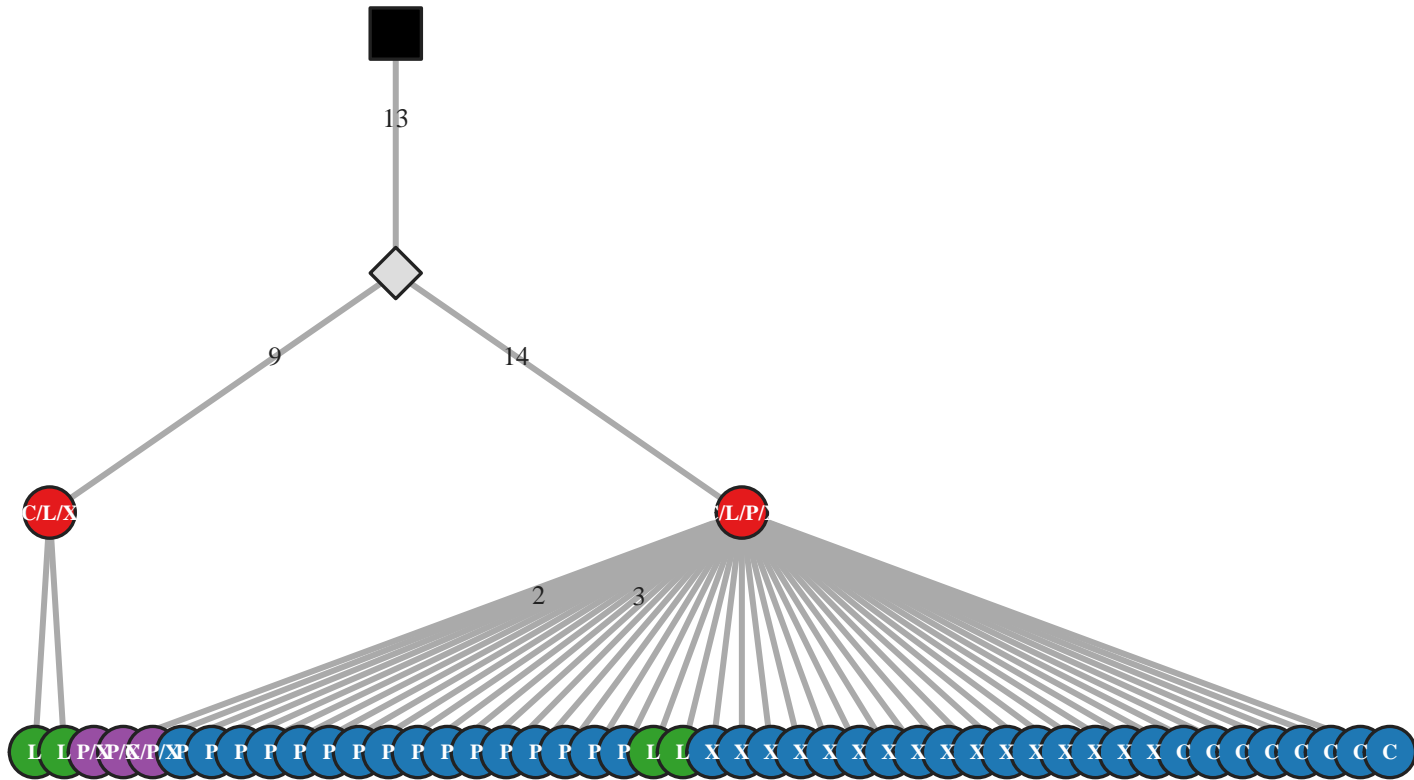

M5 IgG IGHV4-30-2/J6 57bp (35916)

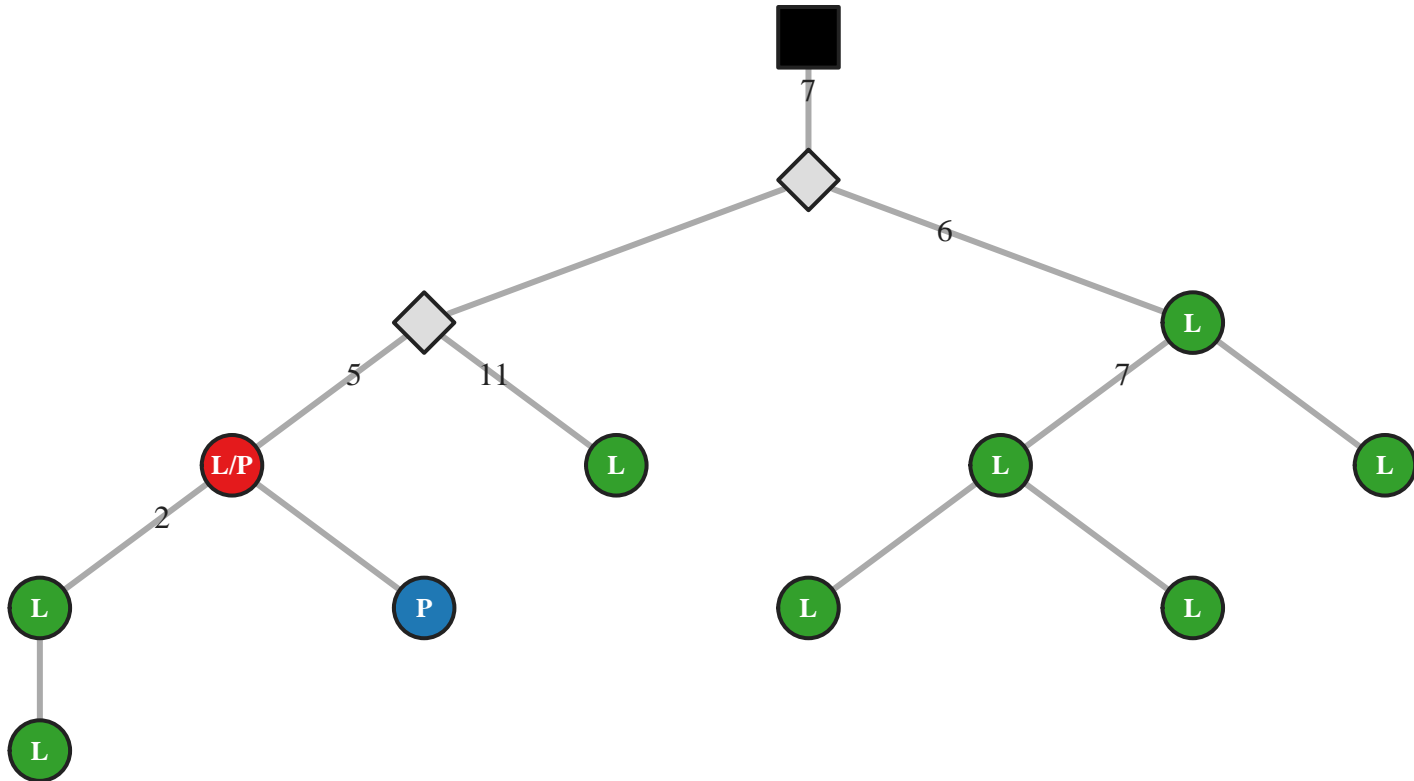

M5 IgG IGHV4-30-4/J3 69bp (35936)

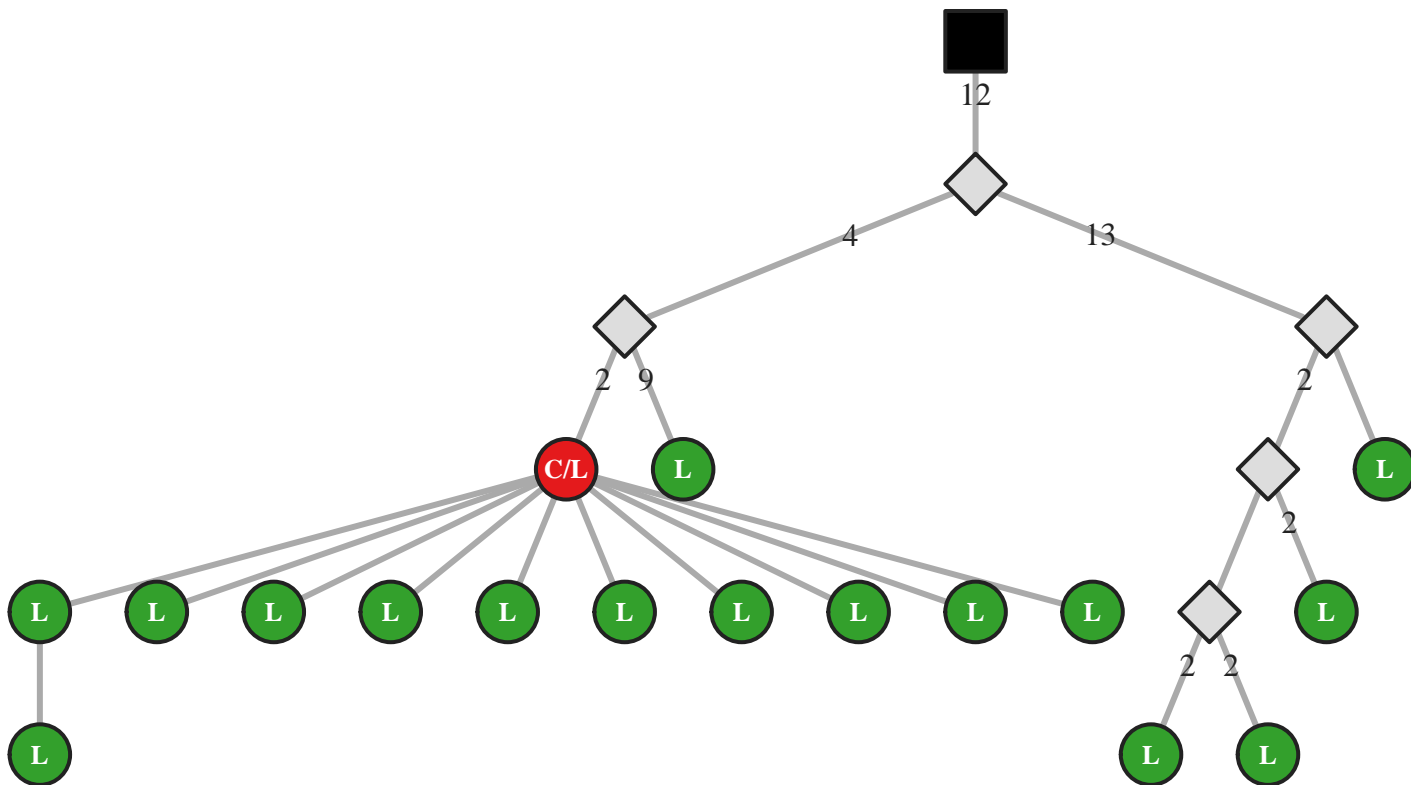

M5 IgG IGHV4-30-4/J4 36bp (35947)

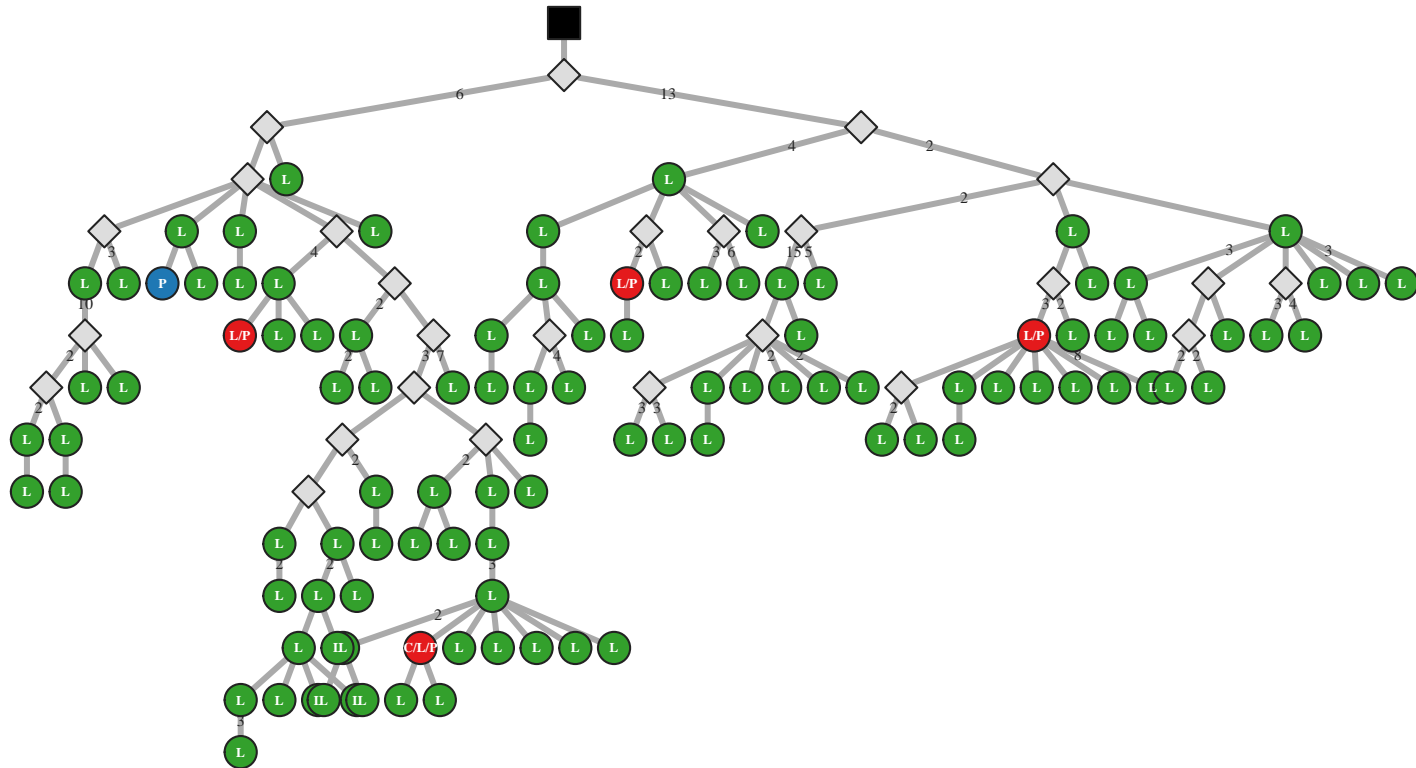

M5 IgG IGHV4-30-4/J4 39bp (9381)

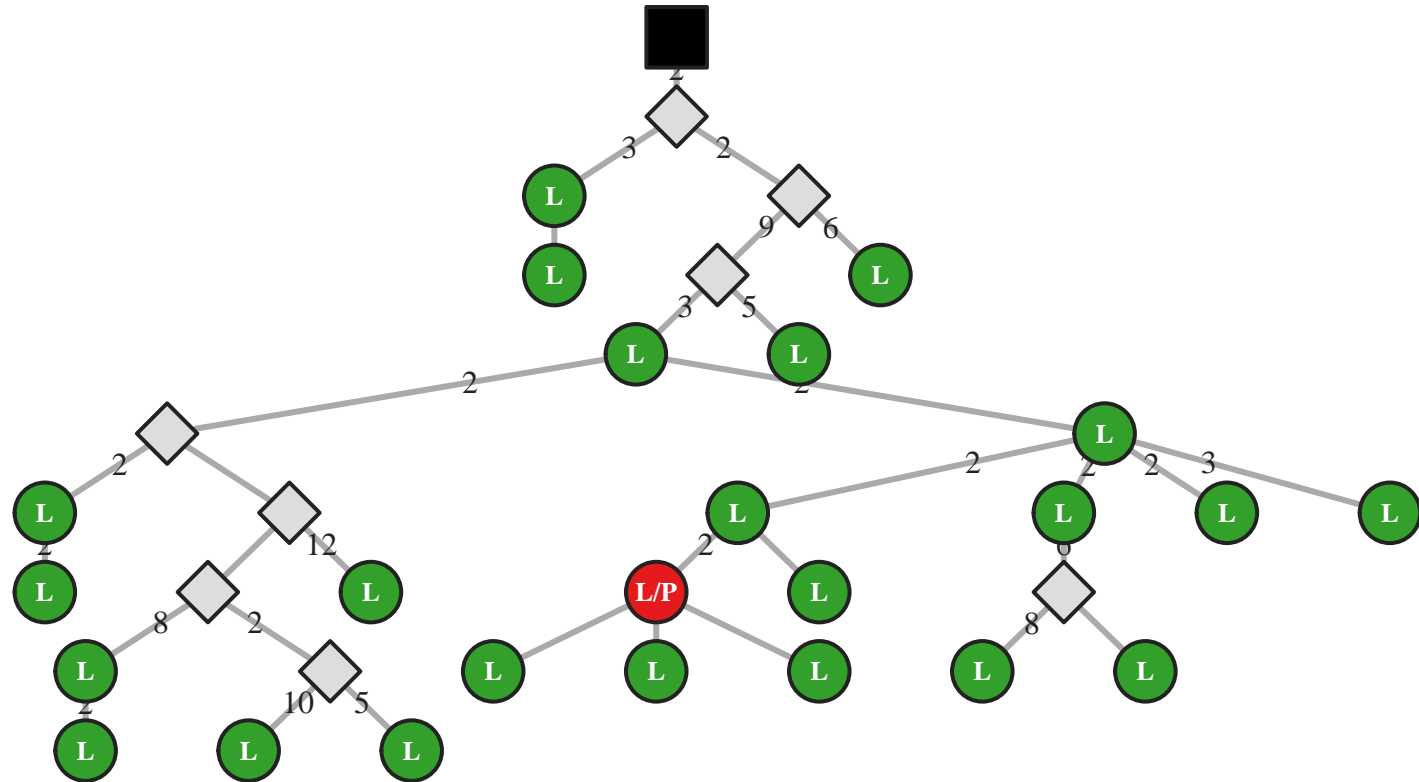

M5 IgG IGHV4-30-4/J4 39bp (9382)

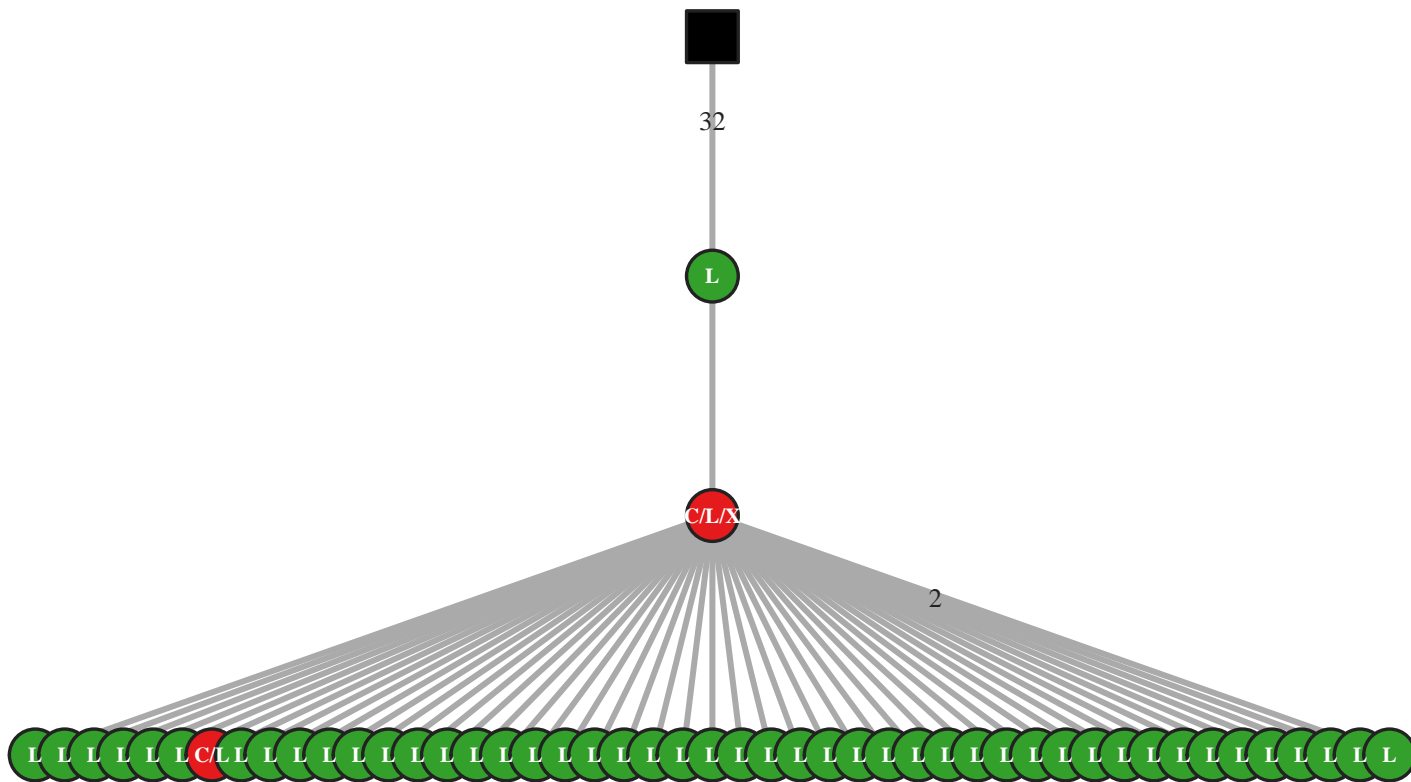

M5 IgG IGHV4-30-4/J4 42bp (18711)

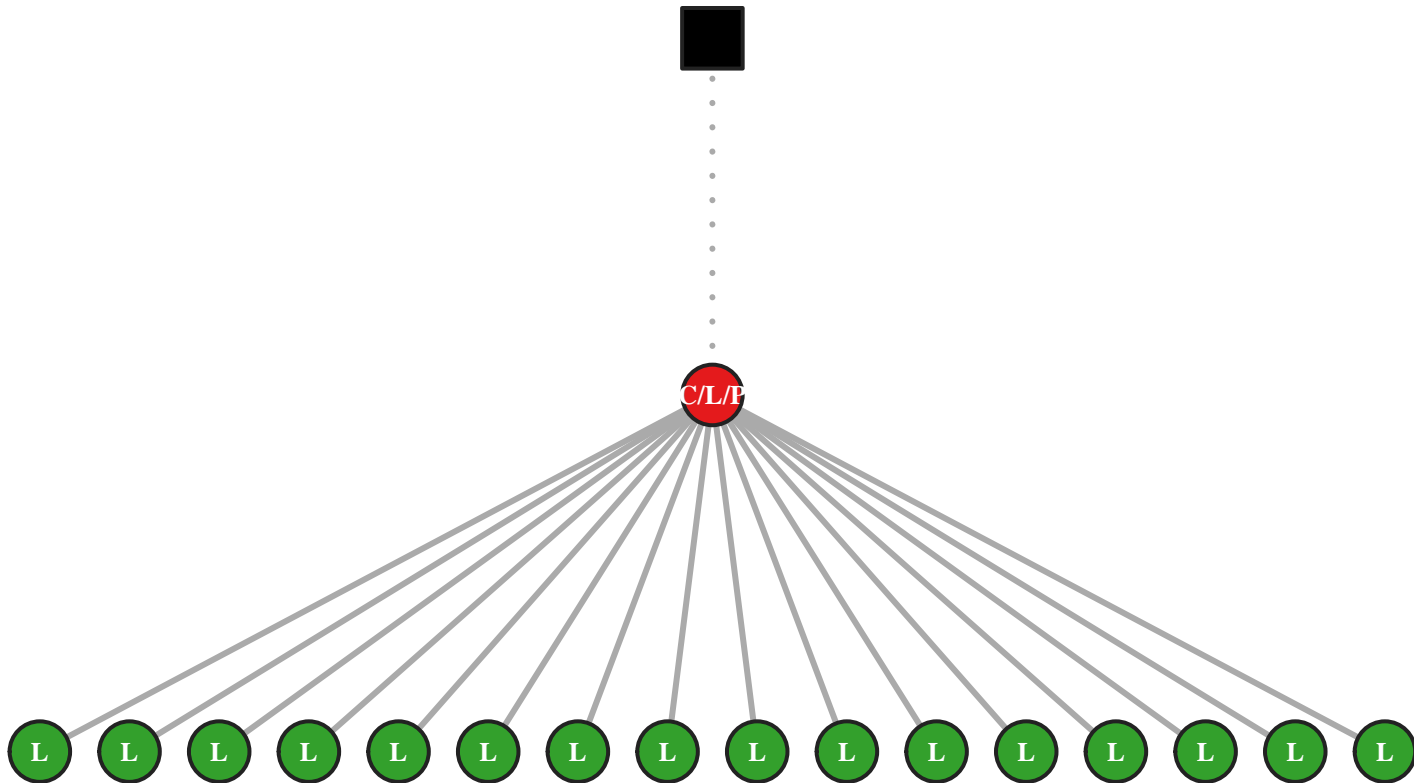

M5 IgG IGHV4-30-4/J4 42bp (18722)

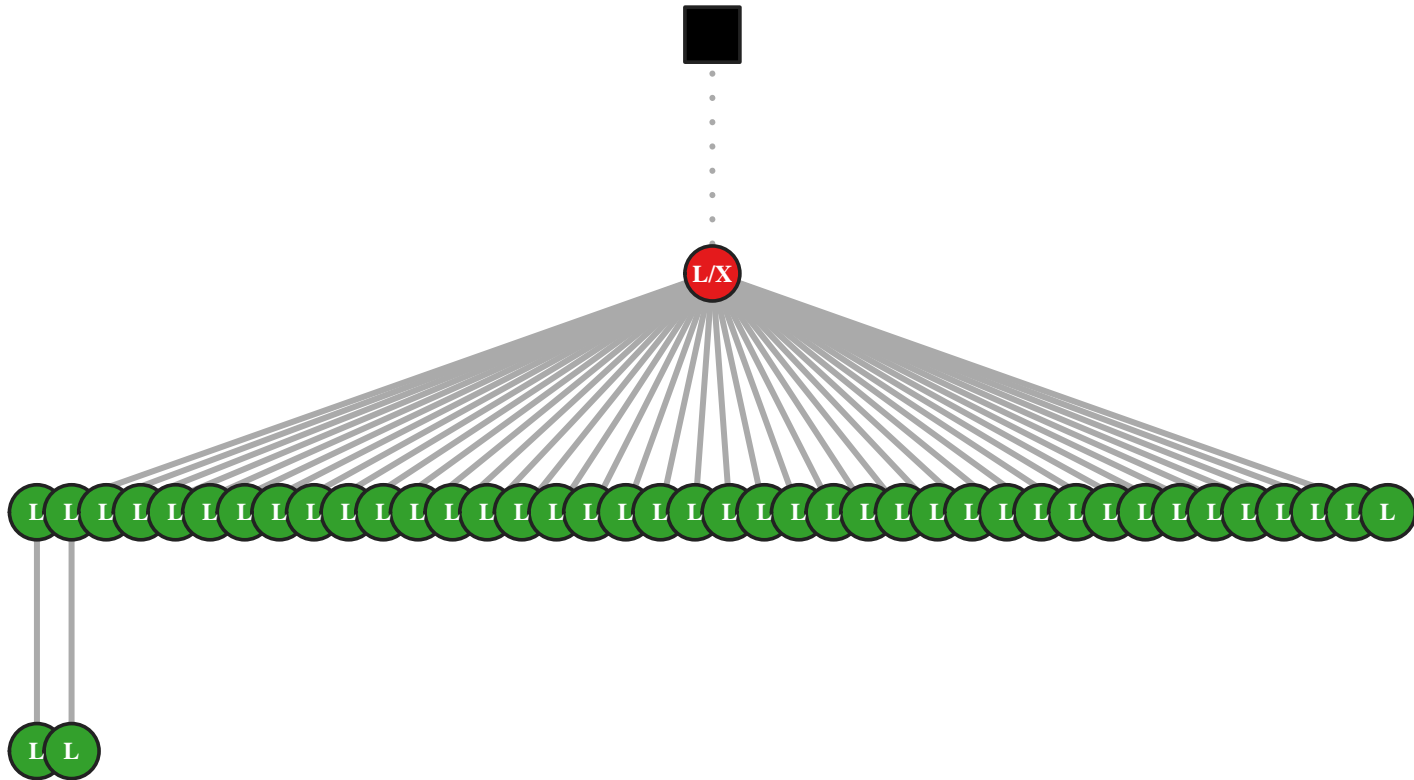

M5 IgG IGHV4-30-4/J4 45bp (18757)

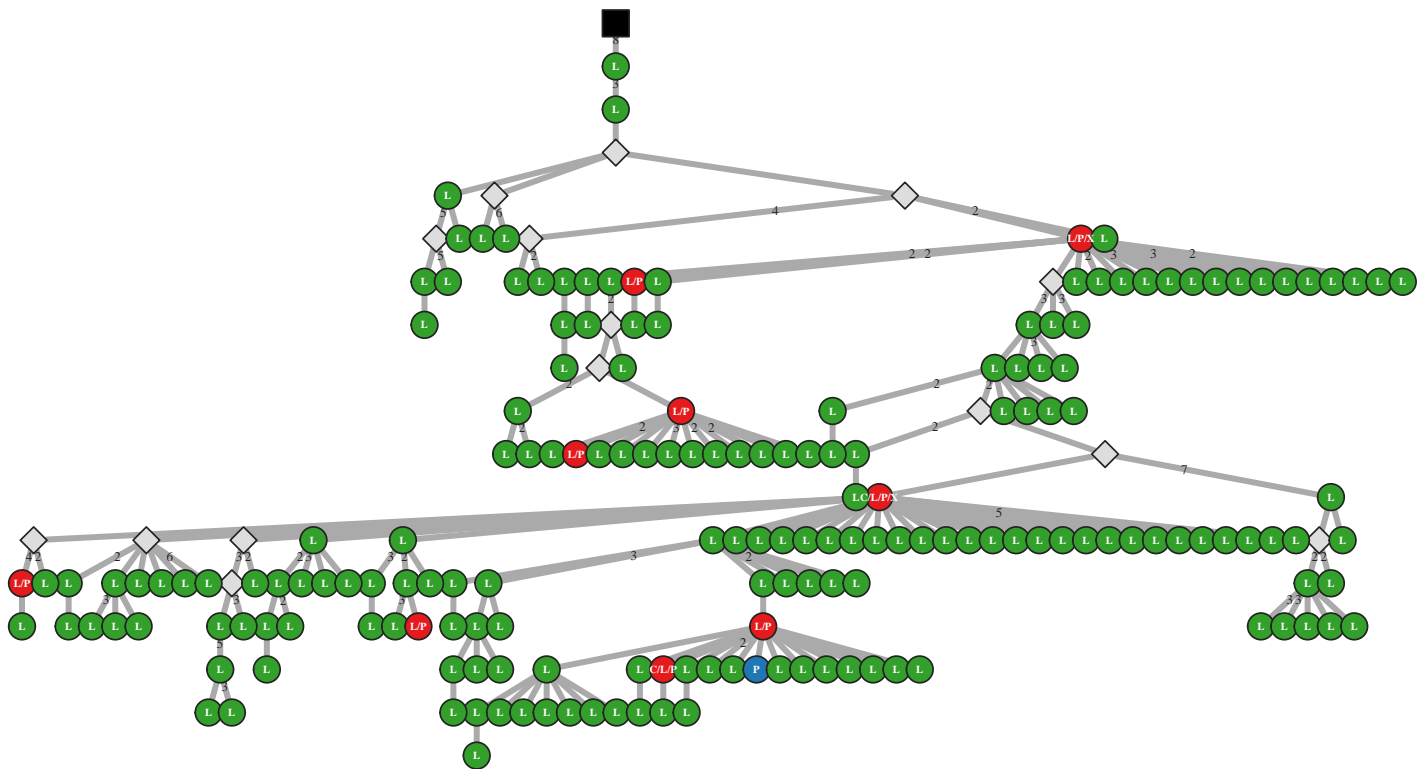

M5 IgG IGHV4-30-4/J4 51bp (35955)

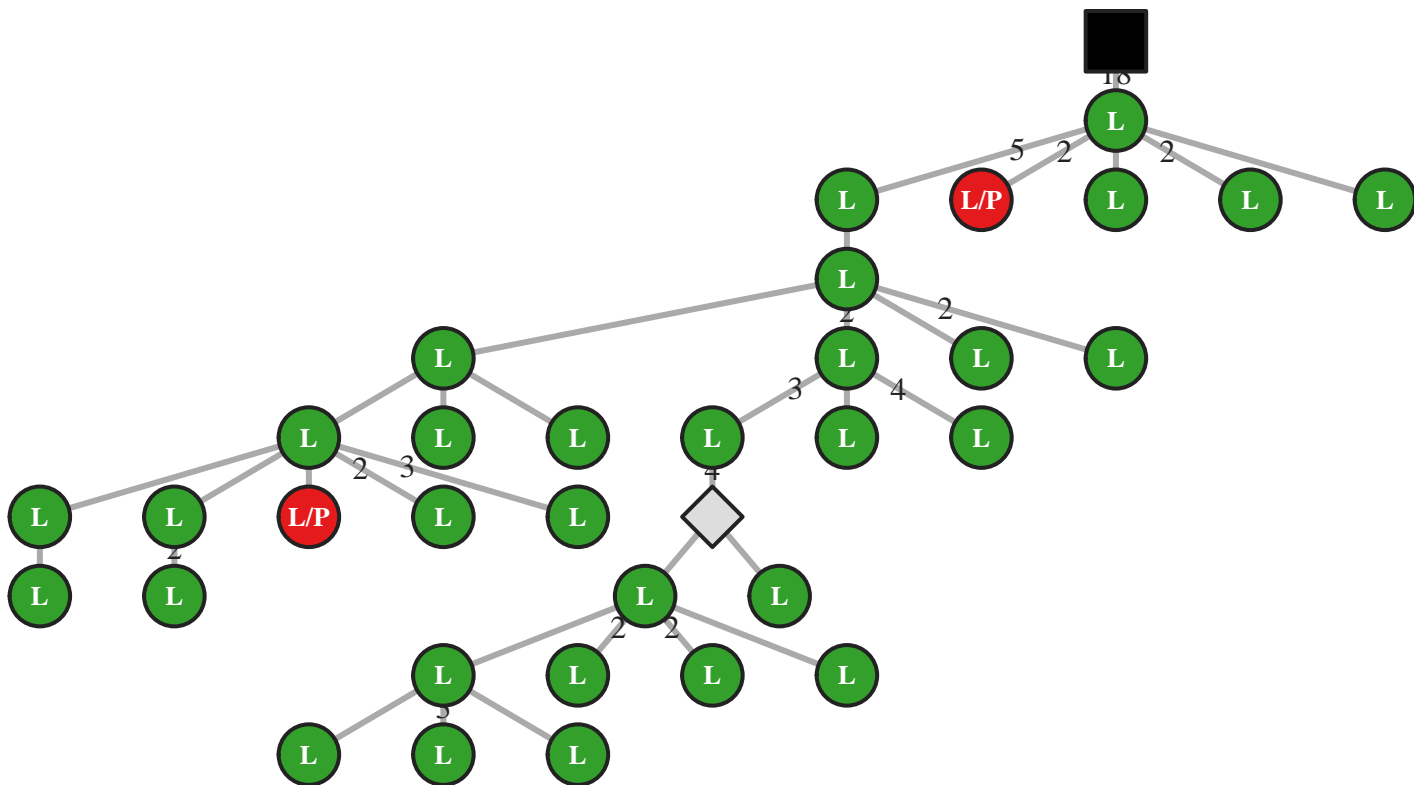

M5 IgG IGHV4-30-4/J4 51bp (35964)

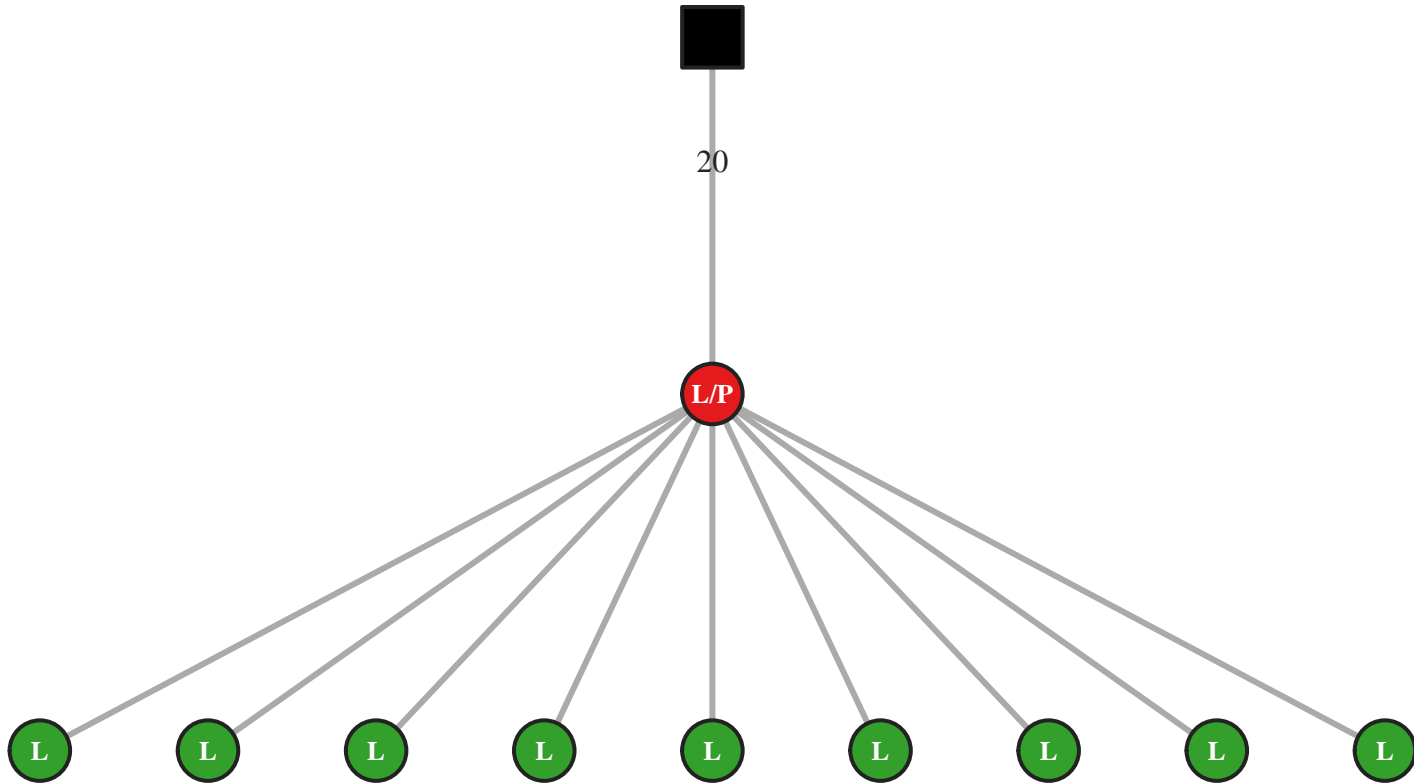

M5 IgG IGHV4-30-4/J4 51bp (35976)

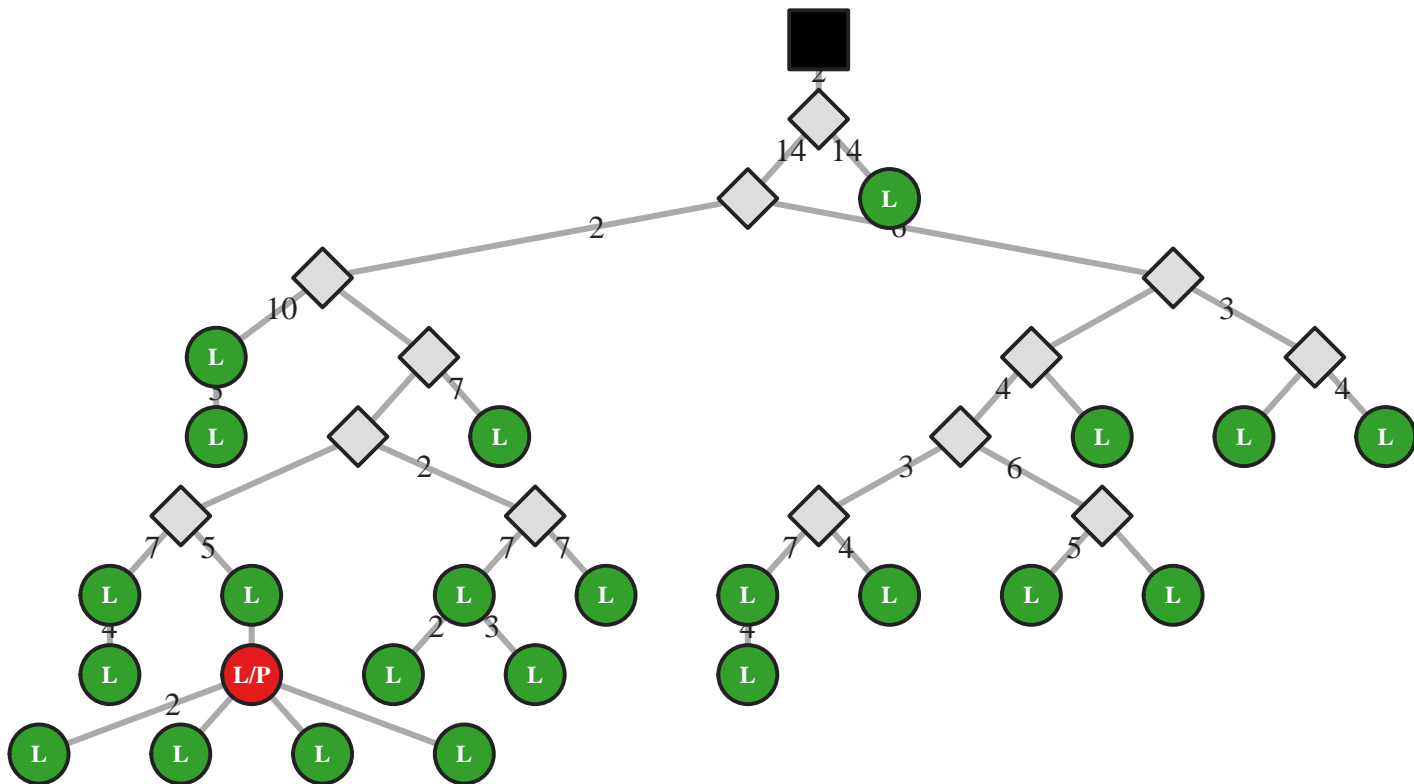

M5 IgG IGHV4-30-4/J4 57bp (46112)

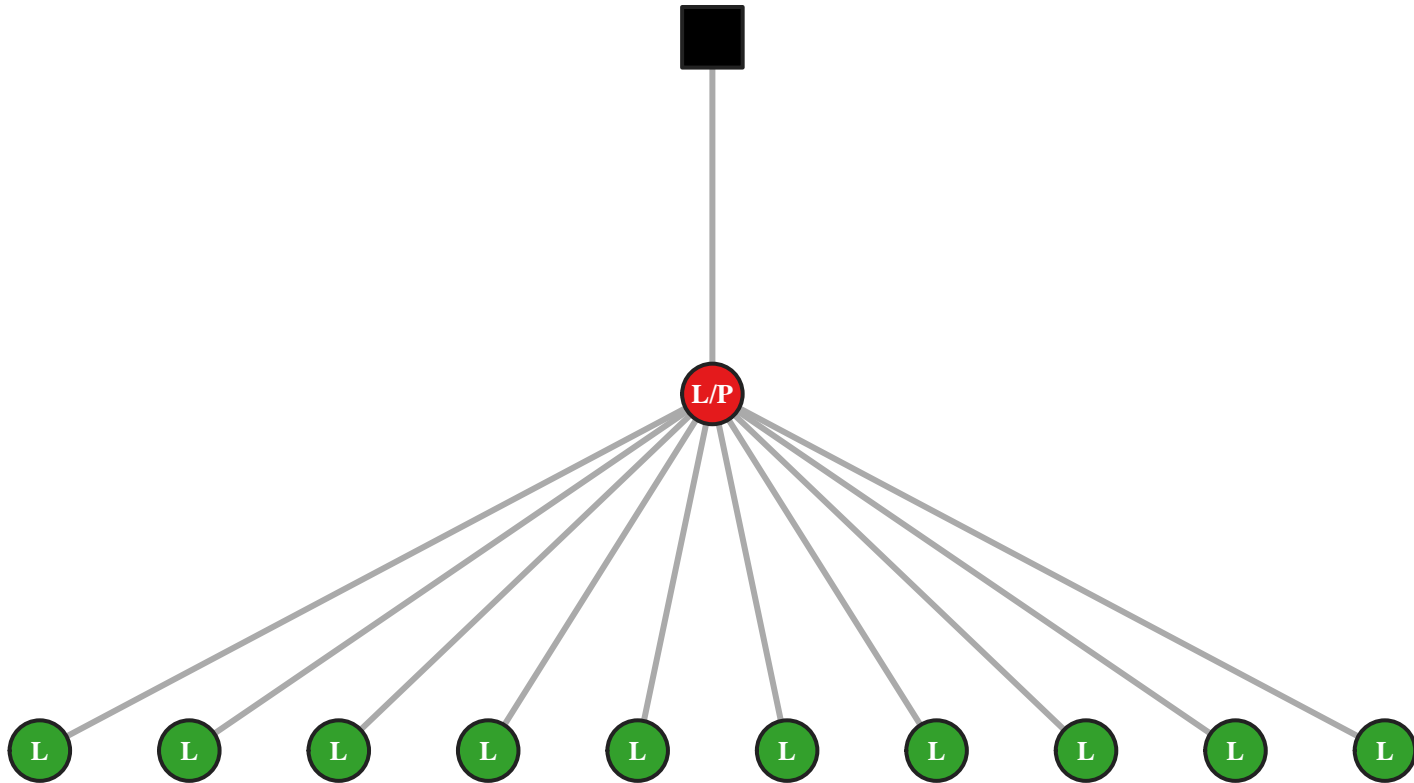

M5 IgG IGHV4-30-4/J4 57bp (46123)

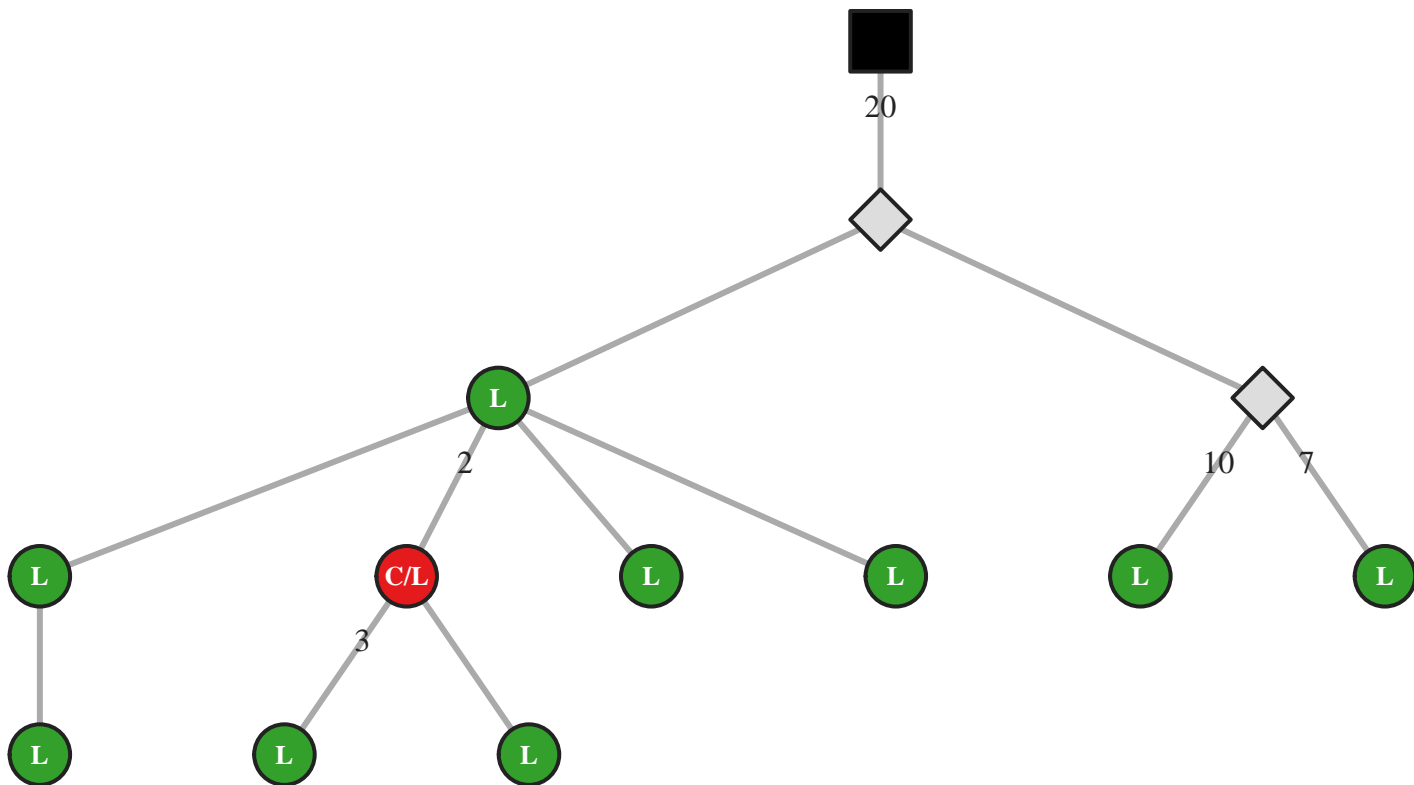

M5 IgA IGHV4-30-4/J5 54bp (30757)

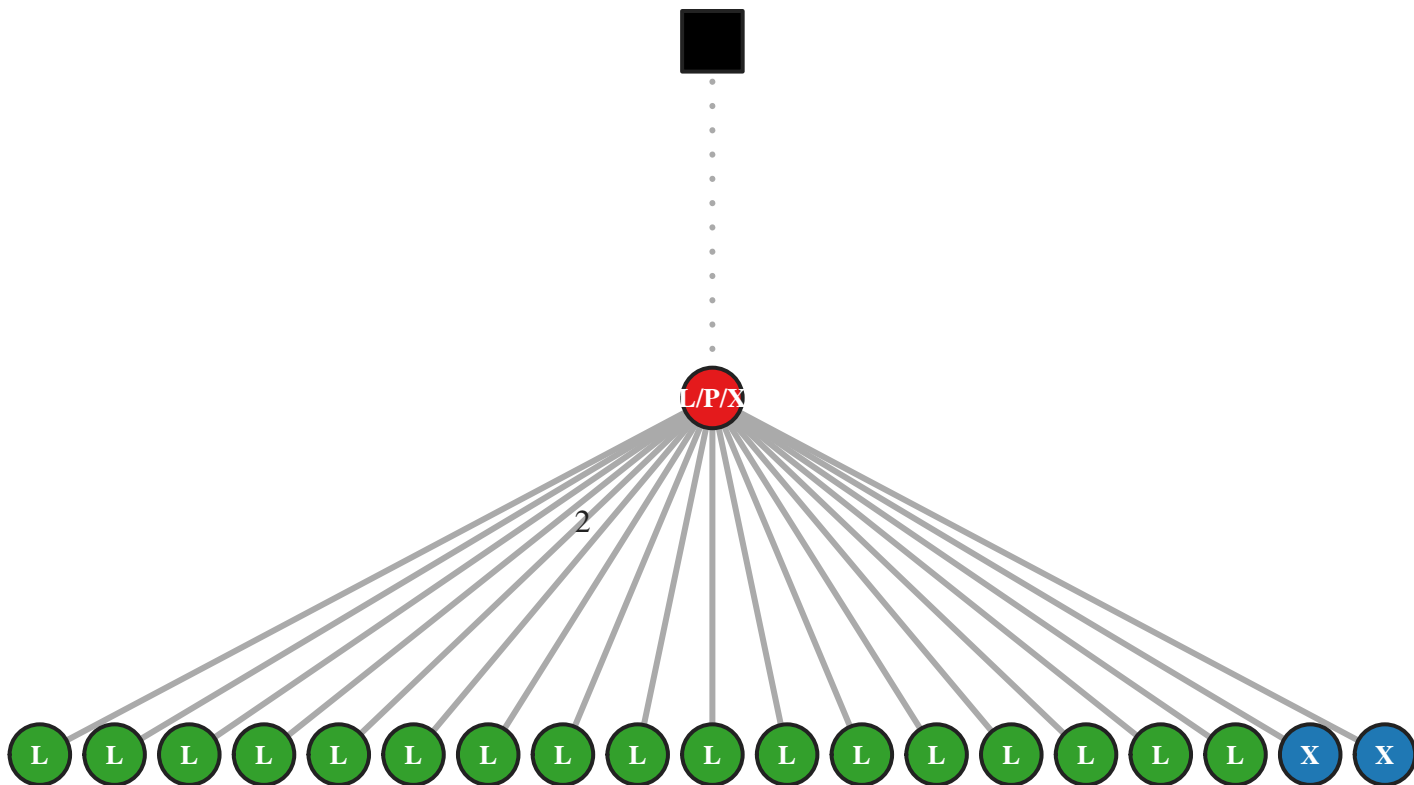

M5 IgG IGHV4-30-4/J5 54bp (46148)

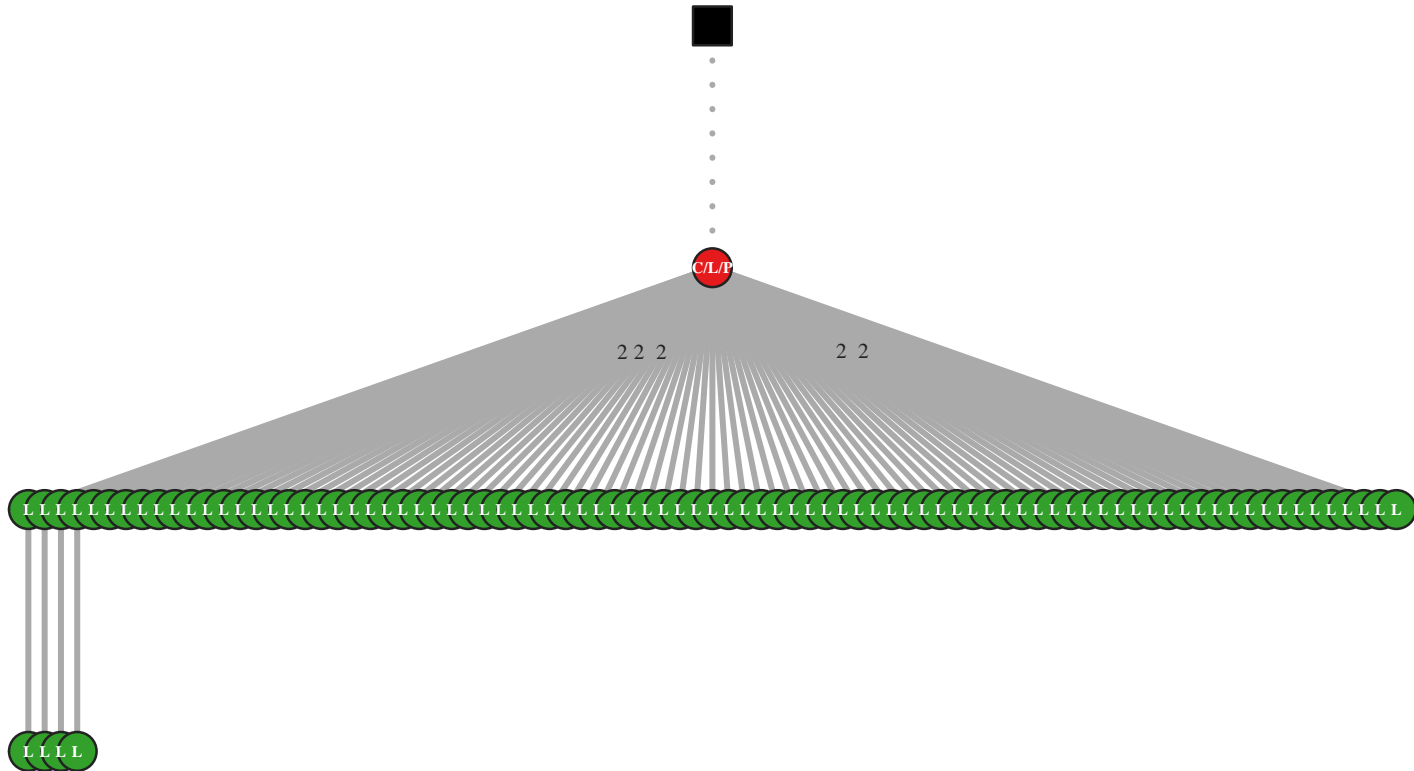

M5 IgG IGHV4-30-4/J6 51bp (9434)

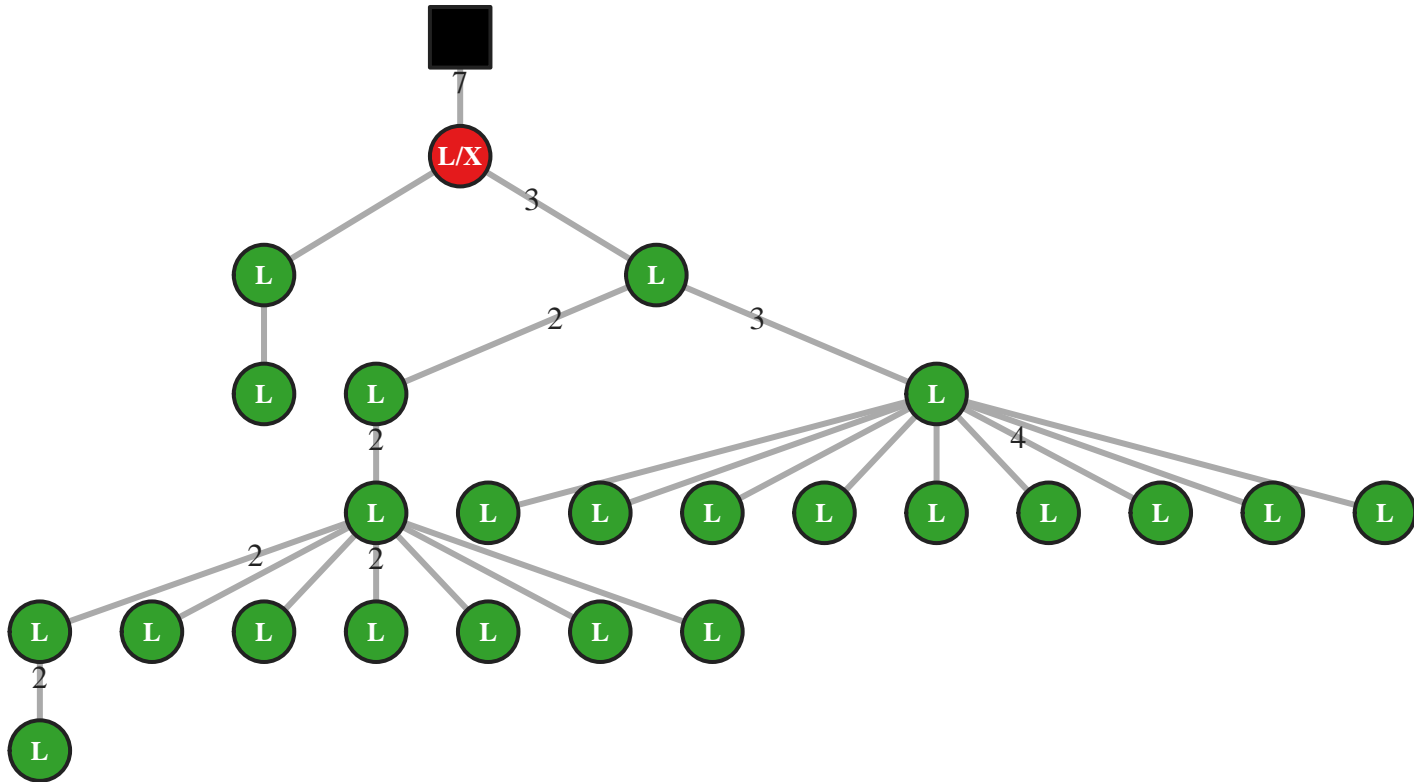

M5 IgG IGHV4-30-4/J6 51bp (9440)

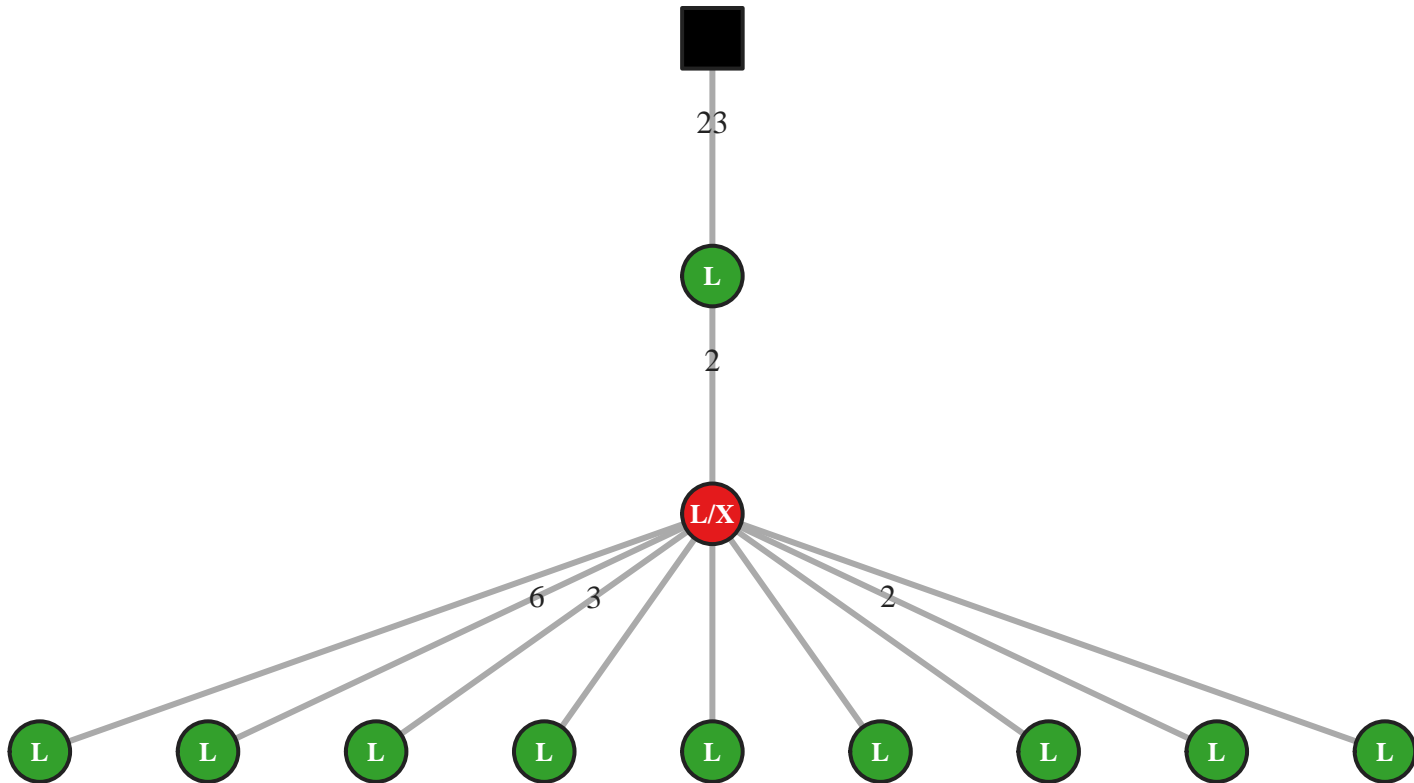

M5 IgG IGHV4-30-4/J6 54bp (18830)

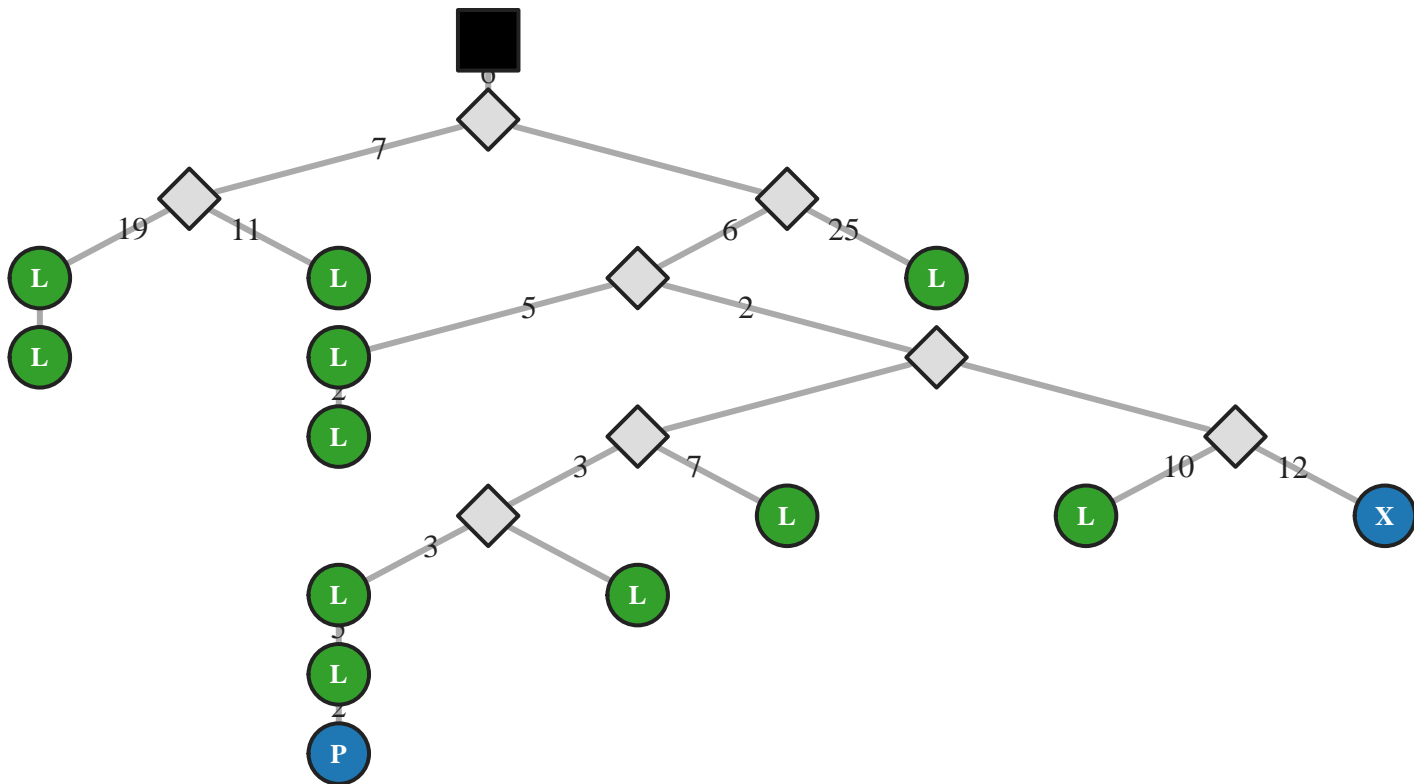

M5 IgG IGHV4-30-4/J6 57bp (27691)

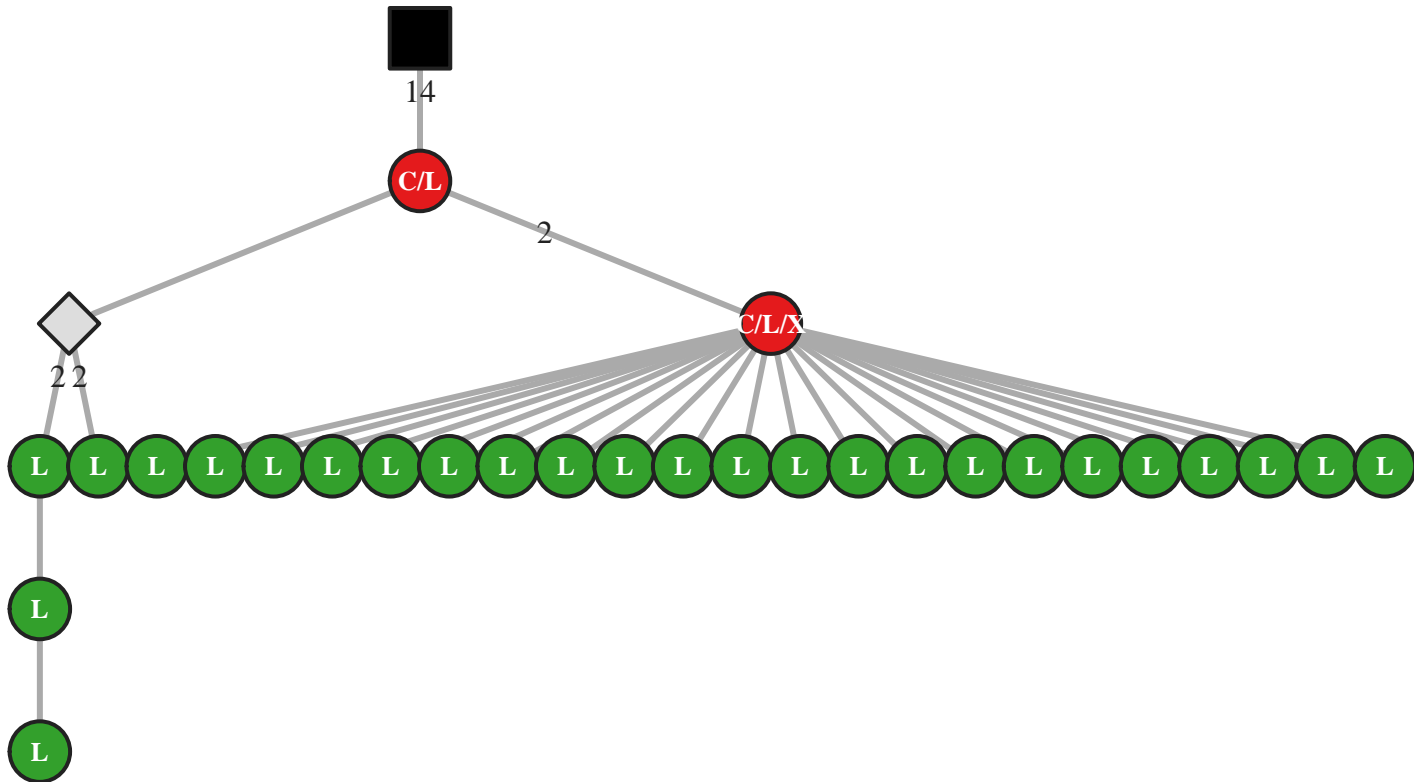

M5 IgG IGHV4-30-4/J6 69bp (52654)

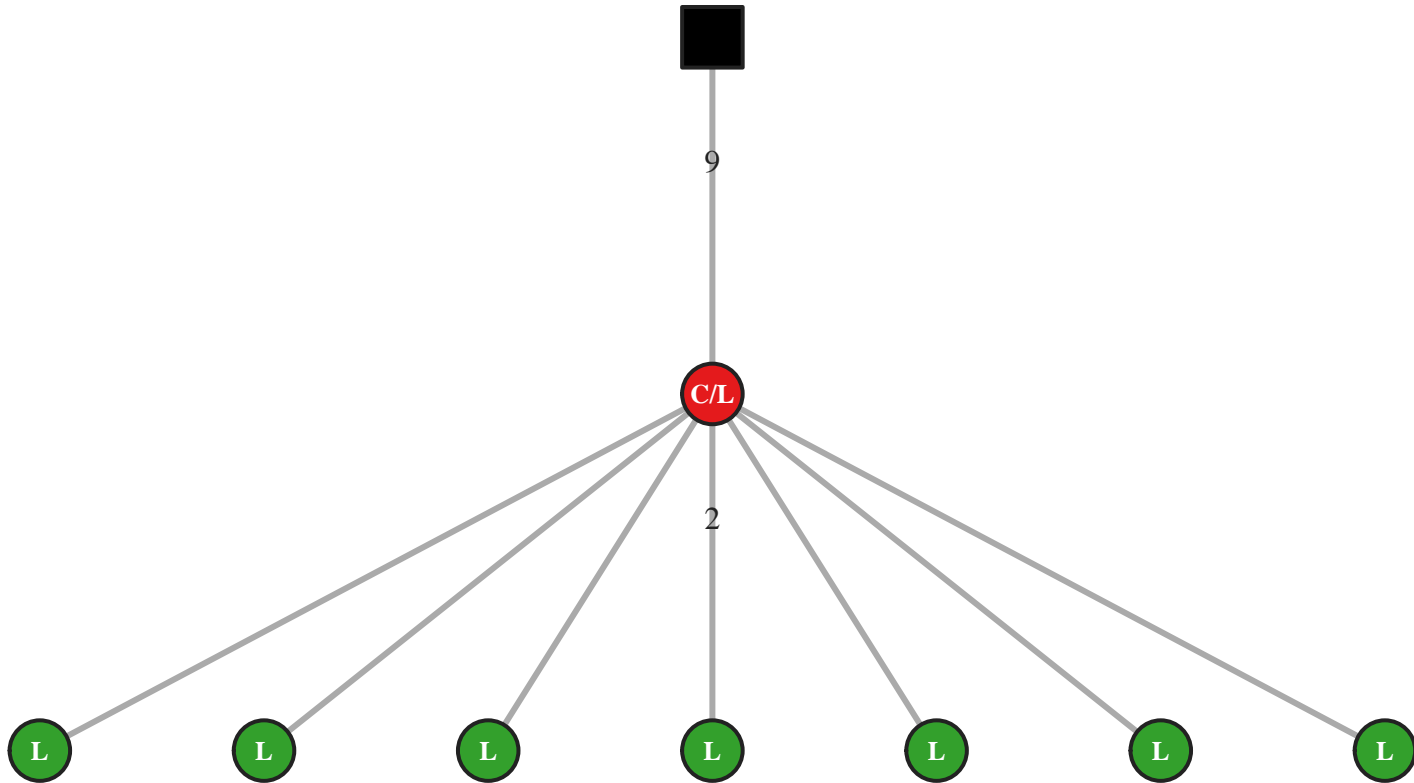

M5 IgG IGHV4-31/J2 48bp (52665)

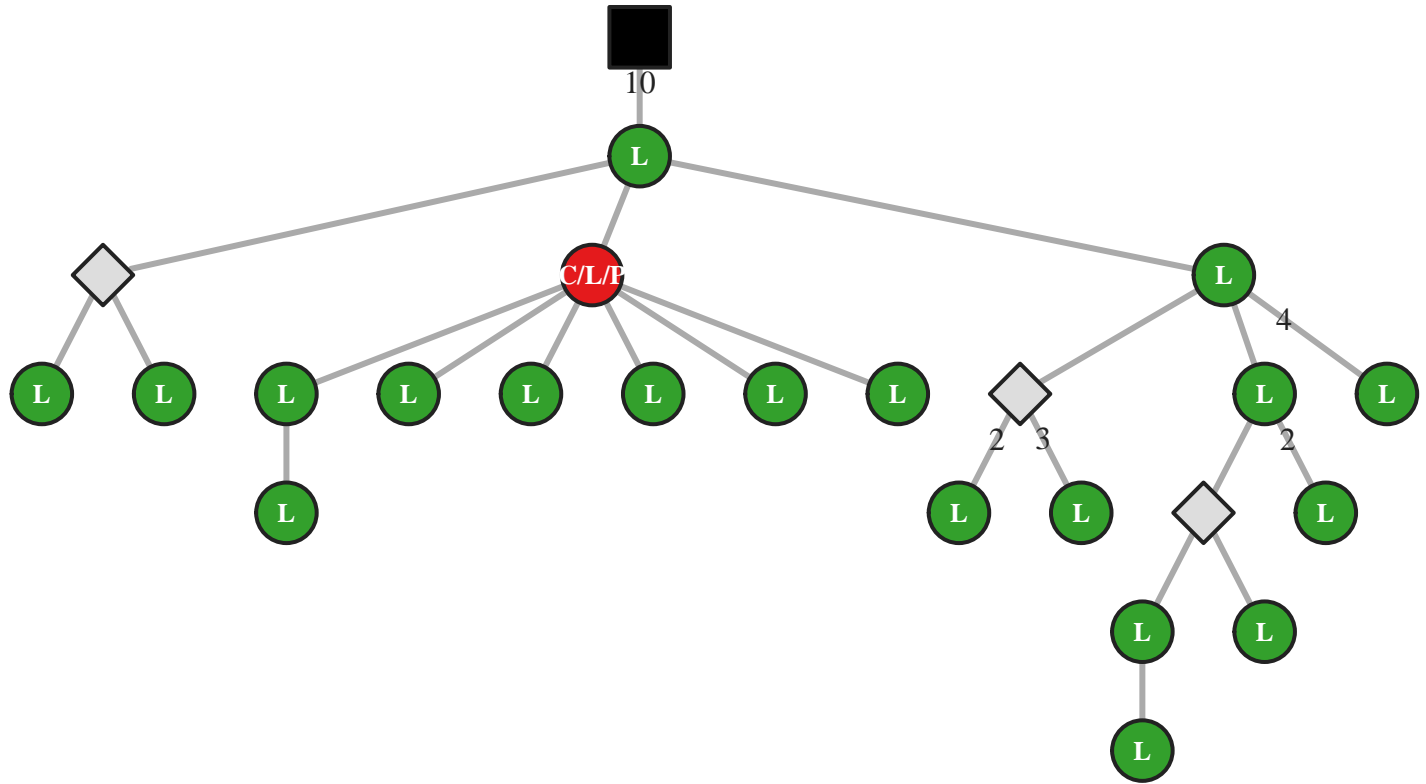

M5 IgG IGHV4-31/J3 39bp (27704)

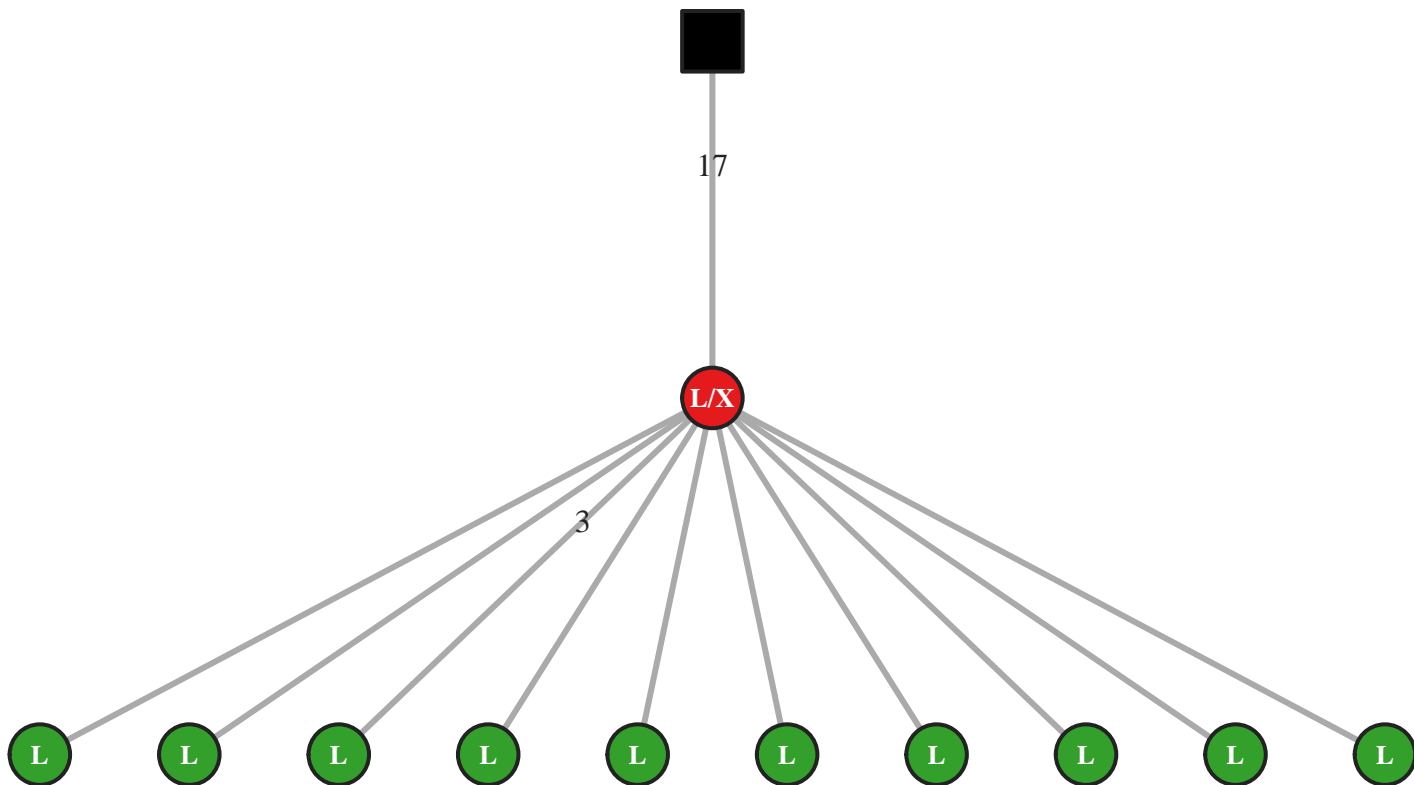

M5 IgG IGHV4-31/J3 63bp (9570)

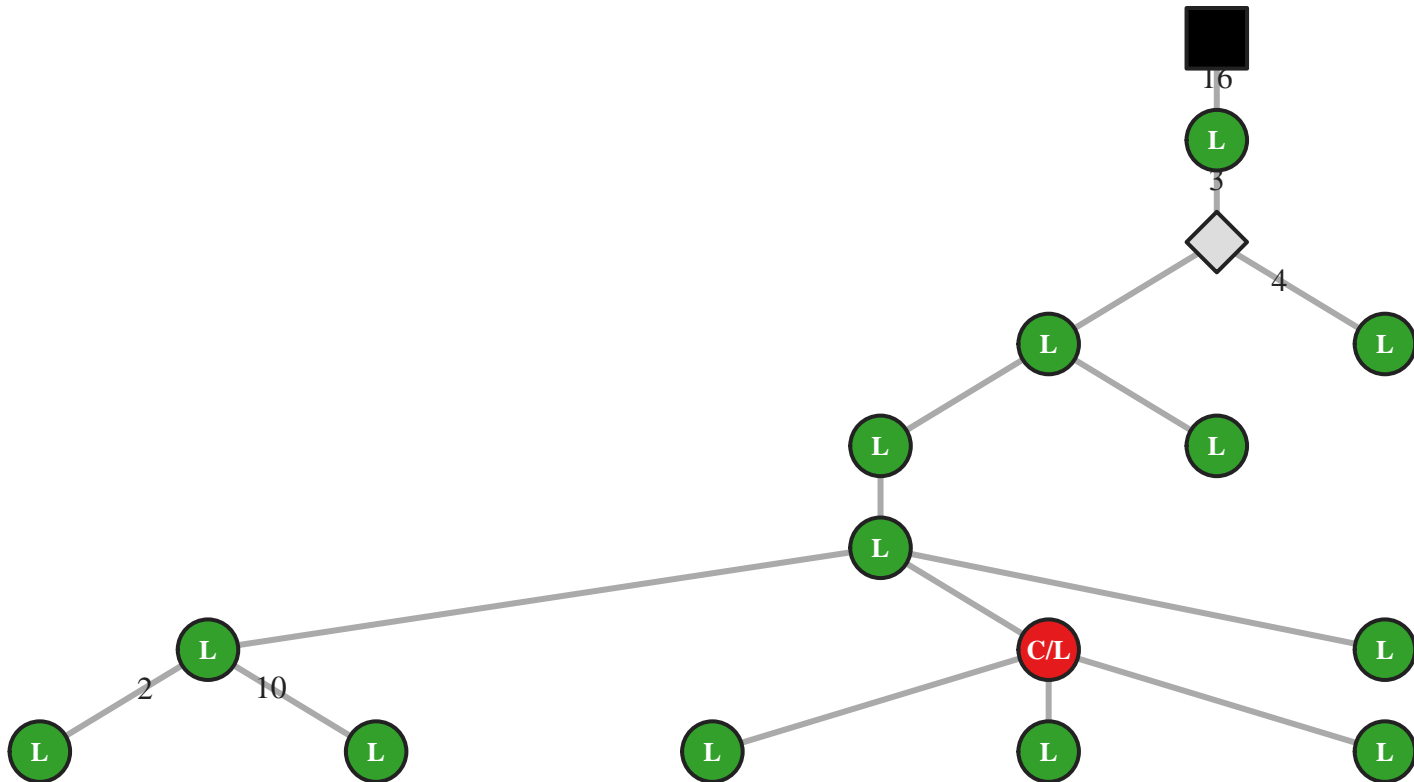

M5 IgG IGHV4-31/J3 63bp (9571)

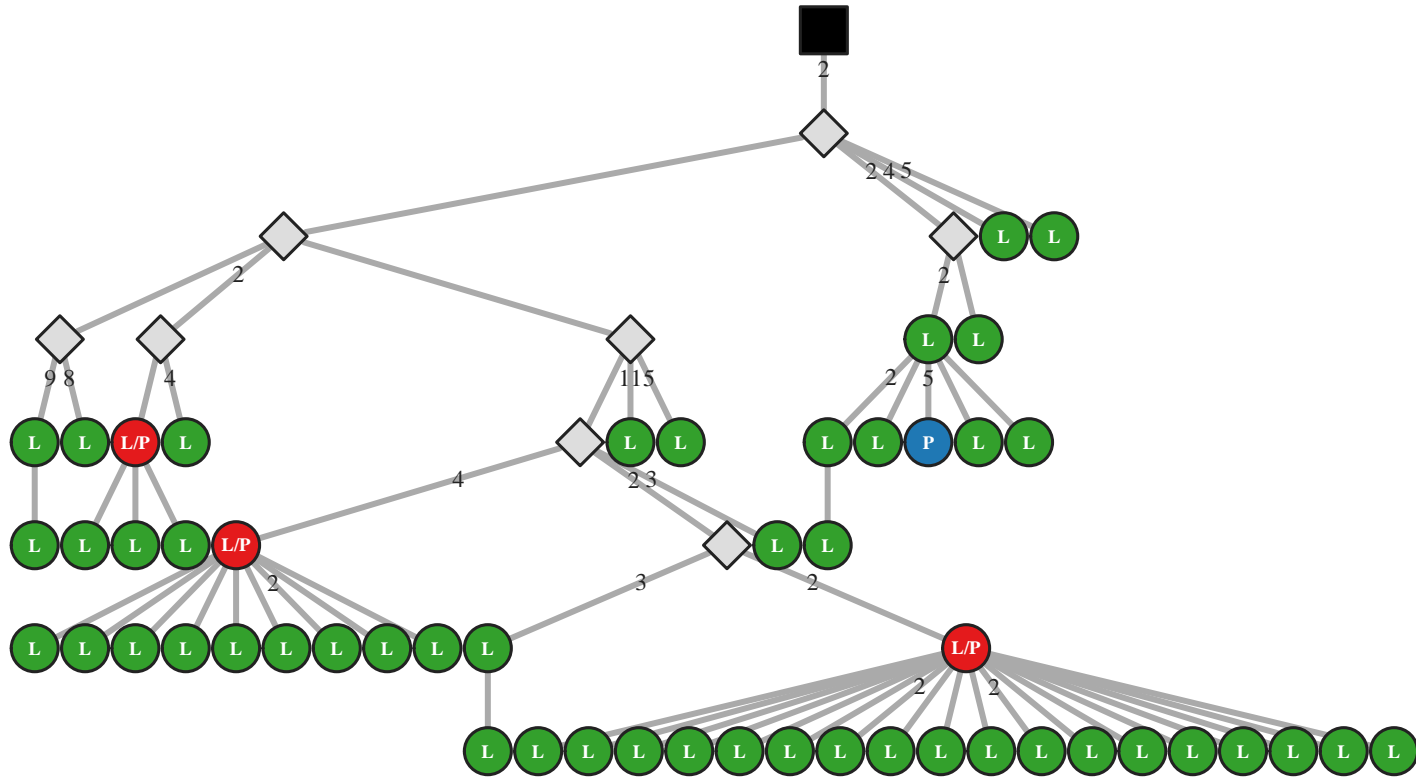

M5 IgG IGHV4-31/J3 66bp (18876)

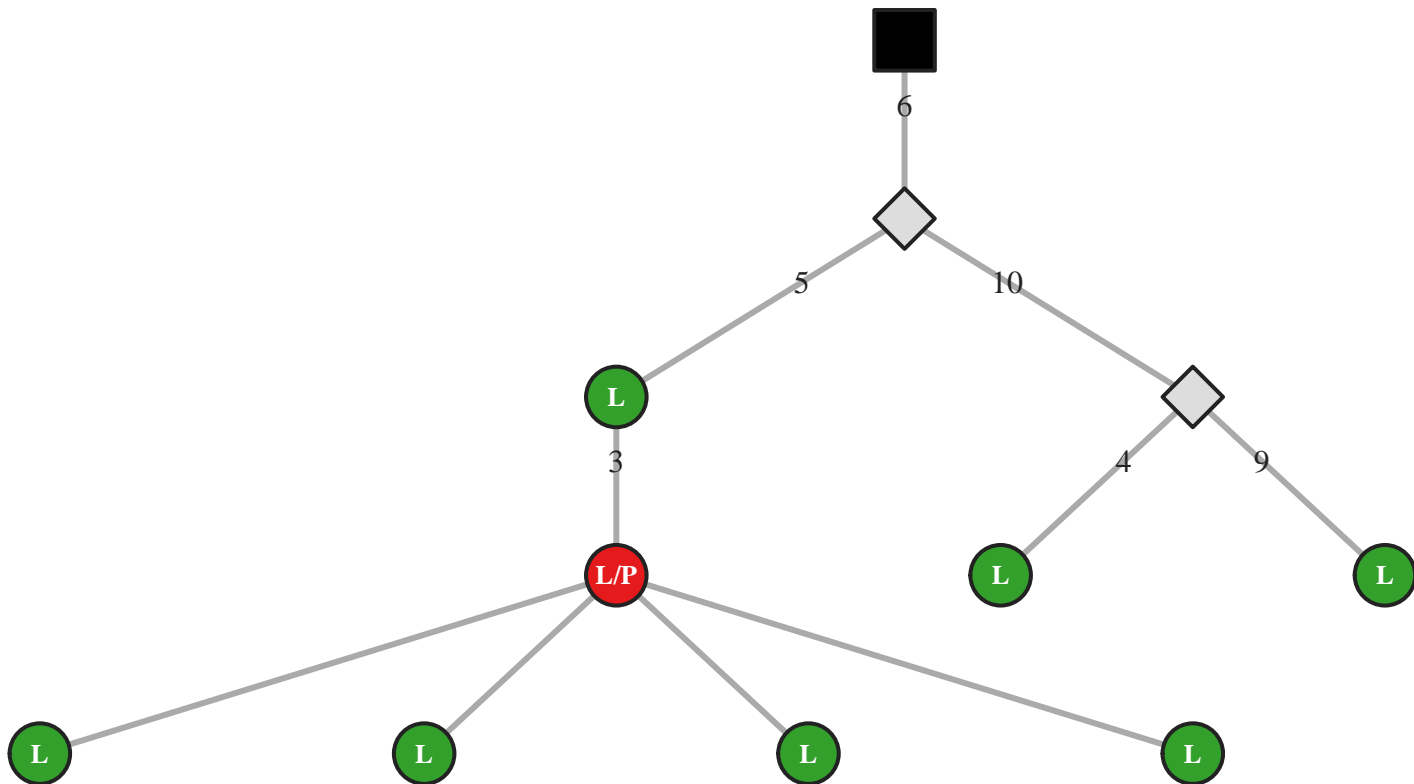

M5 IgG IGHV4-31/J4 33bp (27757)

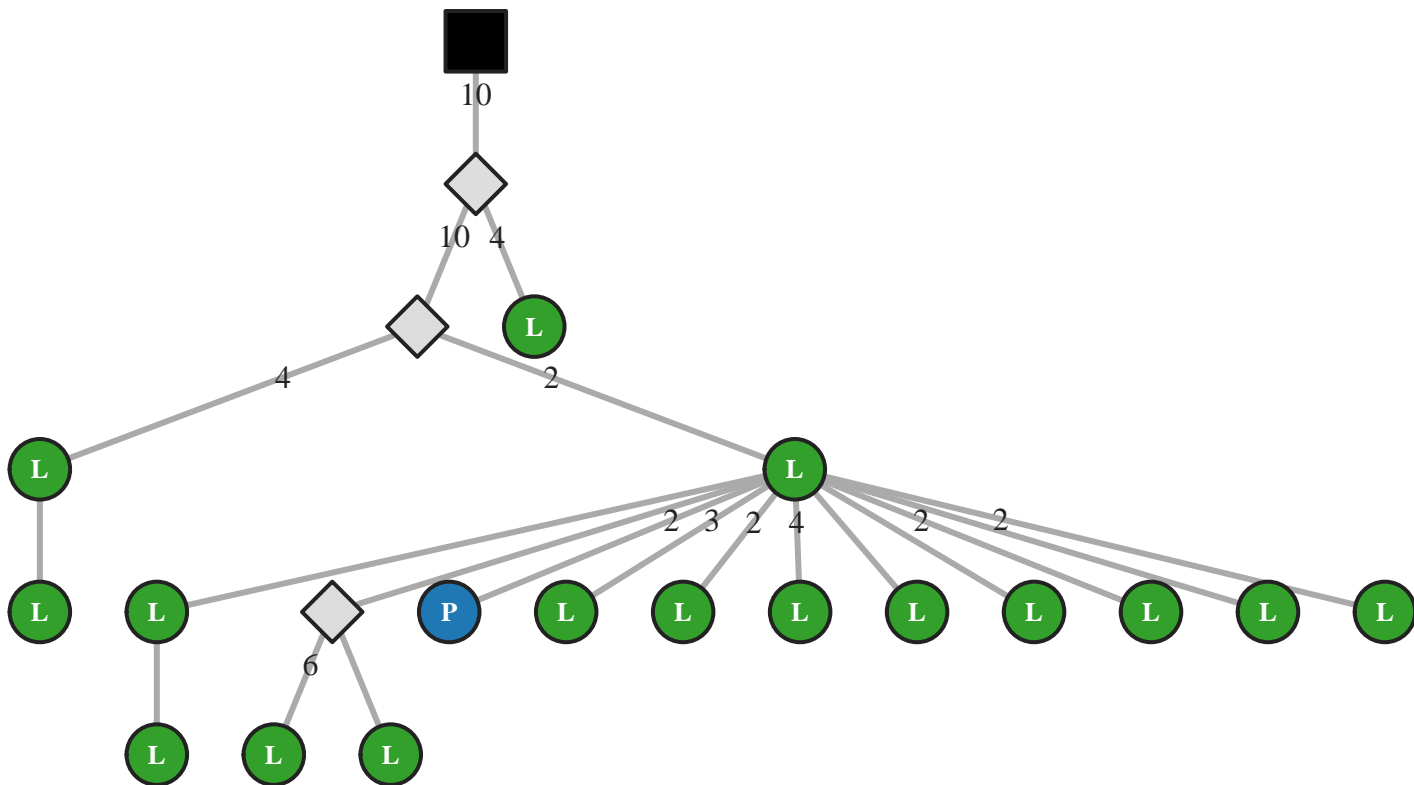

M5 IgG IGHV4-31/J4 36bp (9590)

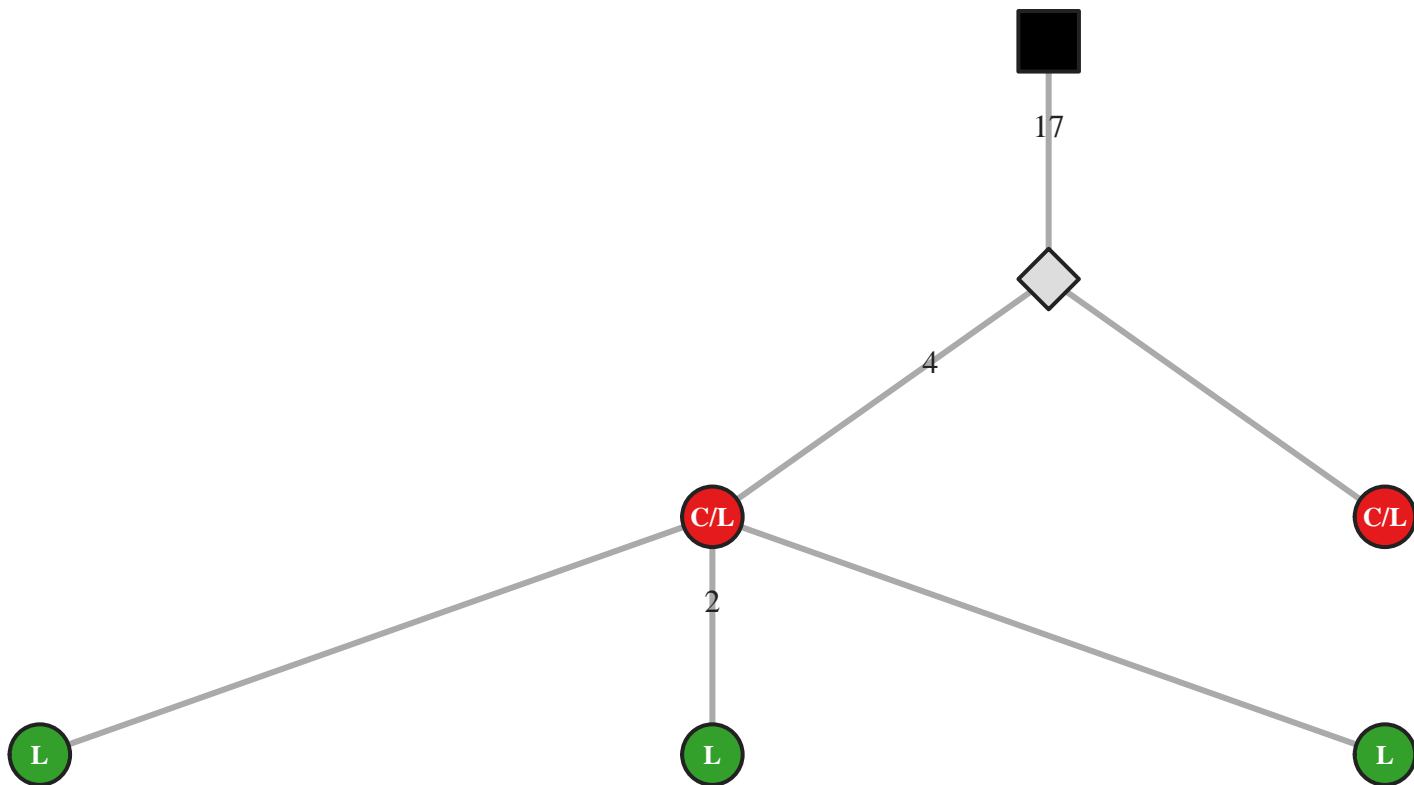

M5 IgG IGHV4-31/J4 39bp (52724)

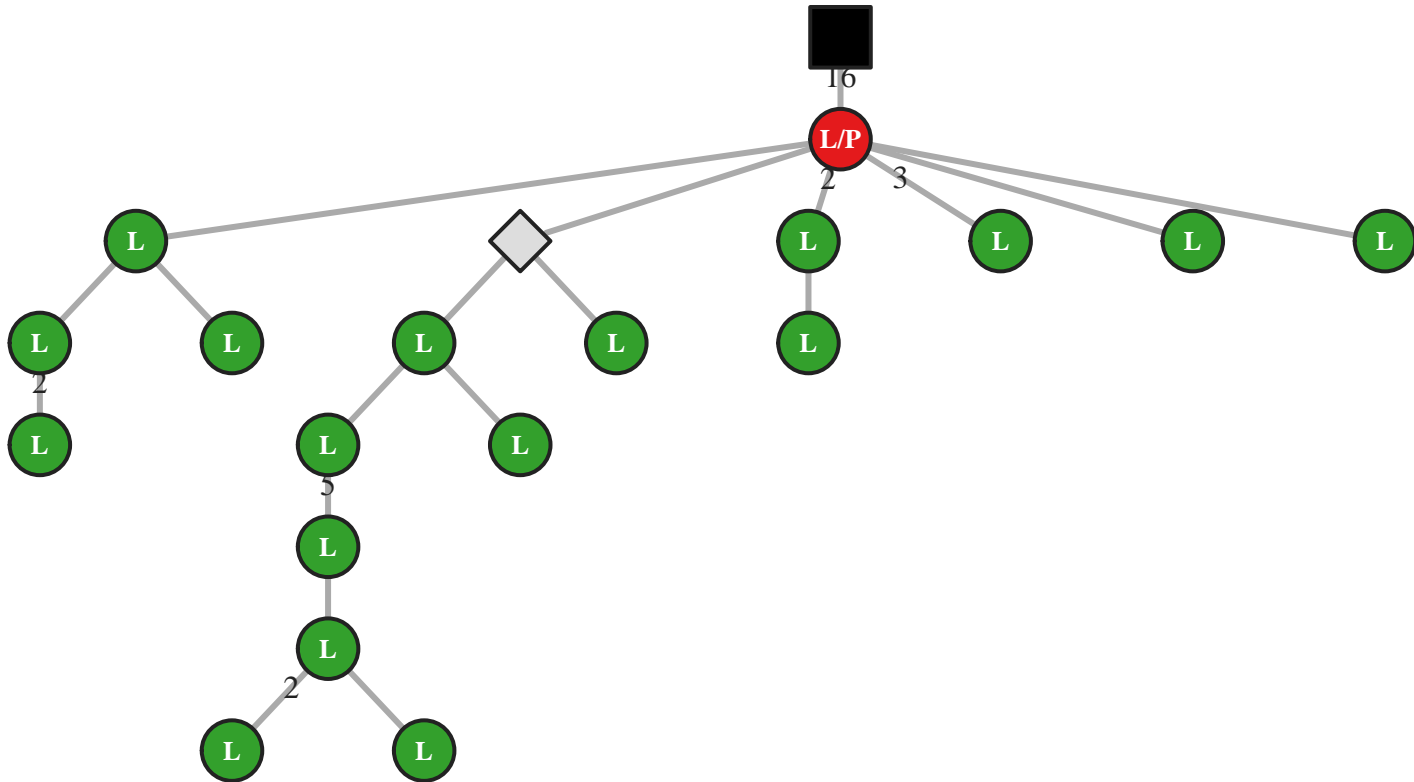

M5 IgG IGHV4-31/J4 39bp (52726)

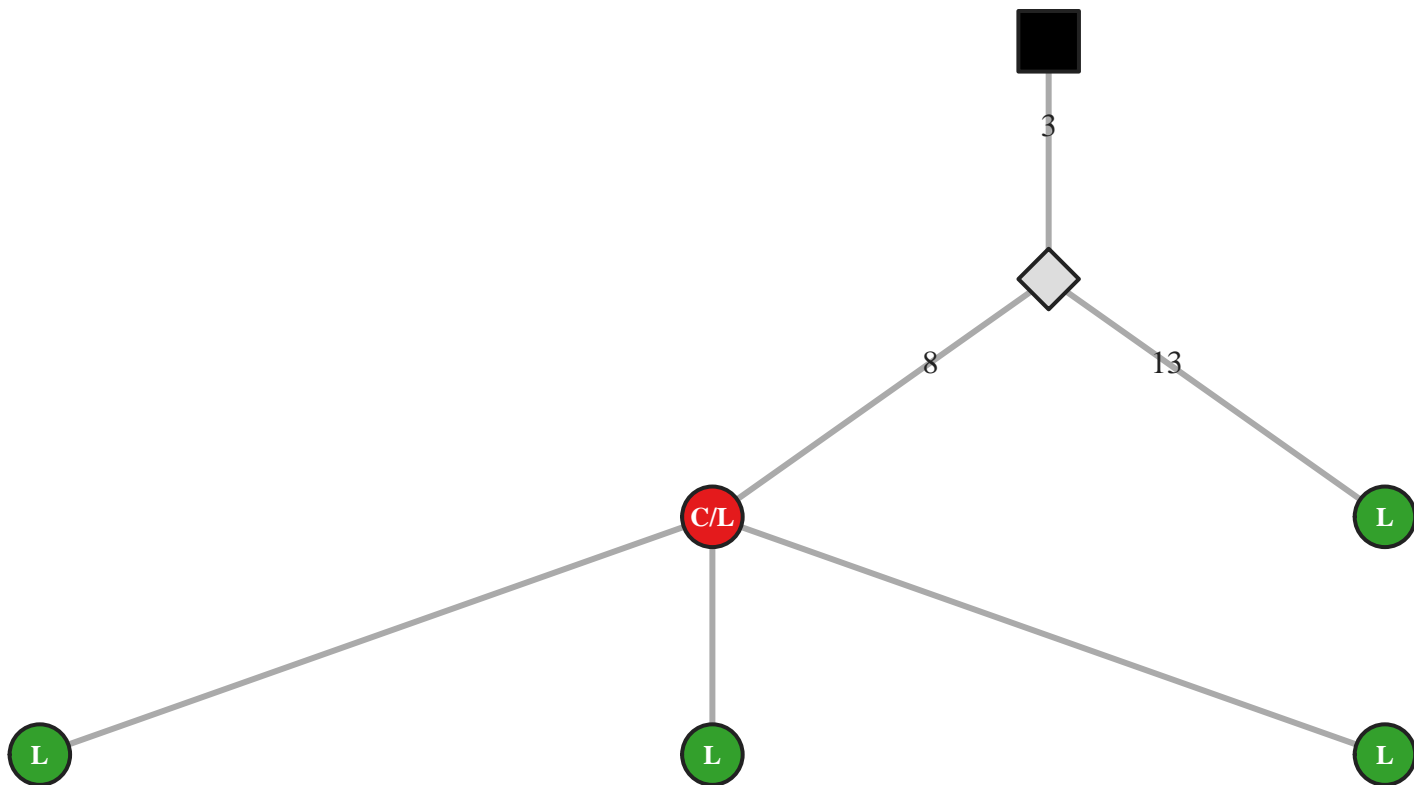

M5 IgG IGHV4-31/J4 39bp (52728)

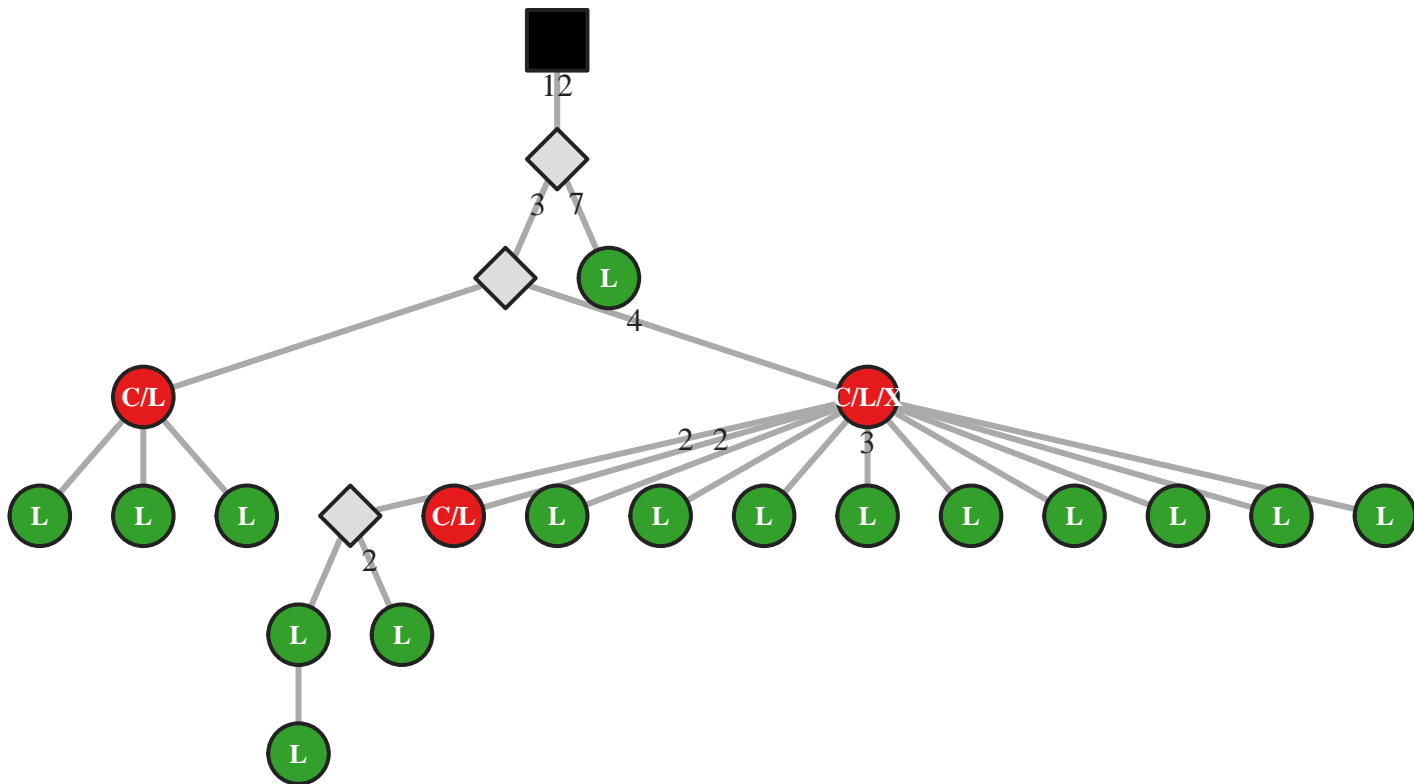

M5 IgA IGHV4-31/J4 42bp (30778)

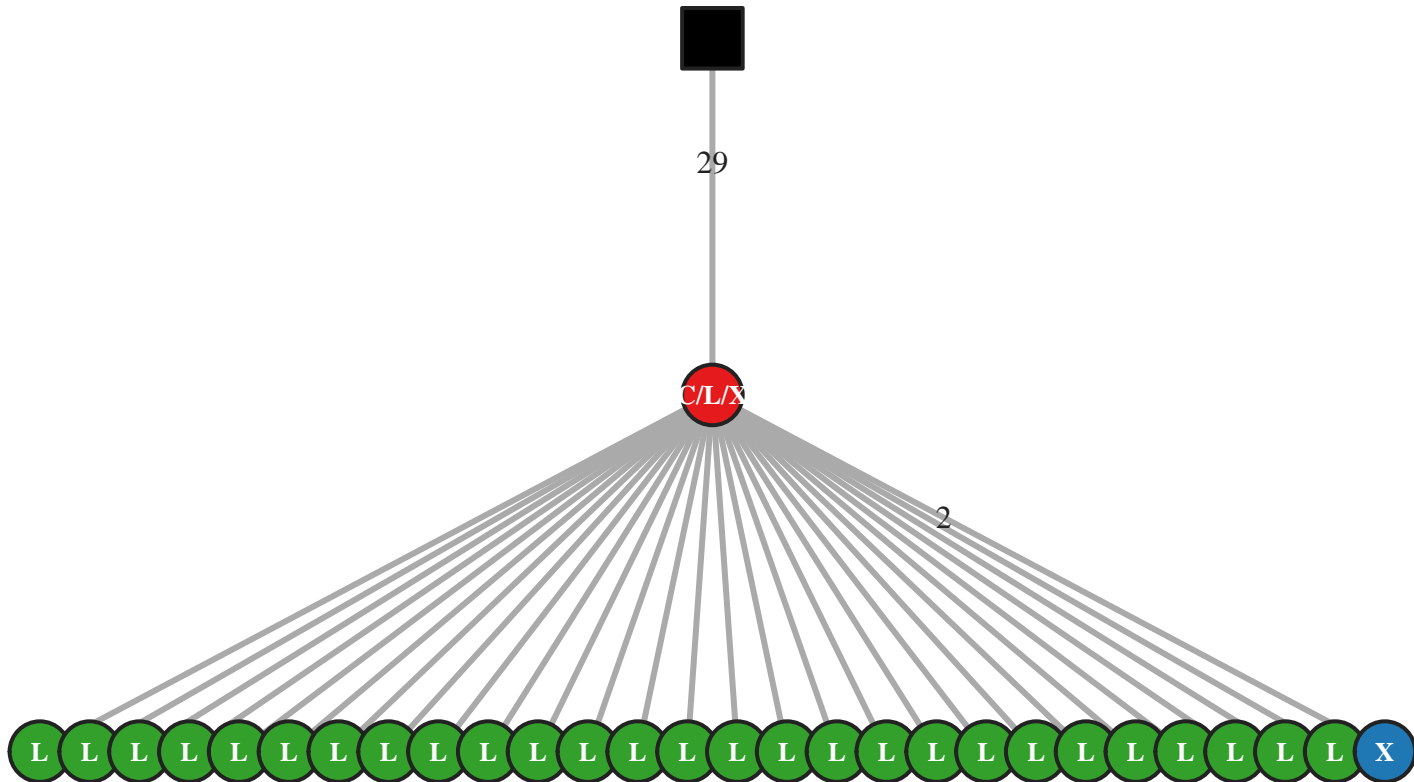

M5 IgG IGHV4-31/J4 42bp (52795)

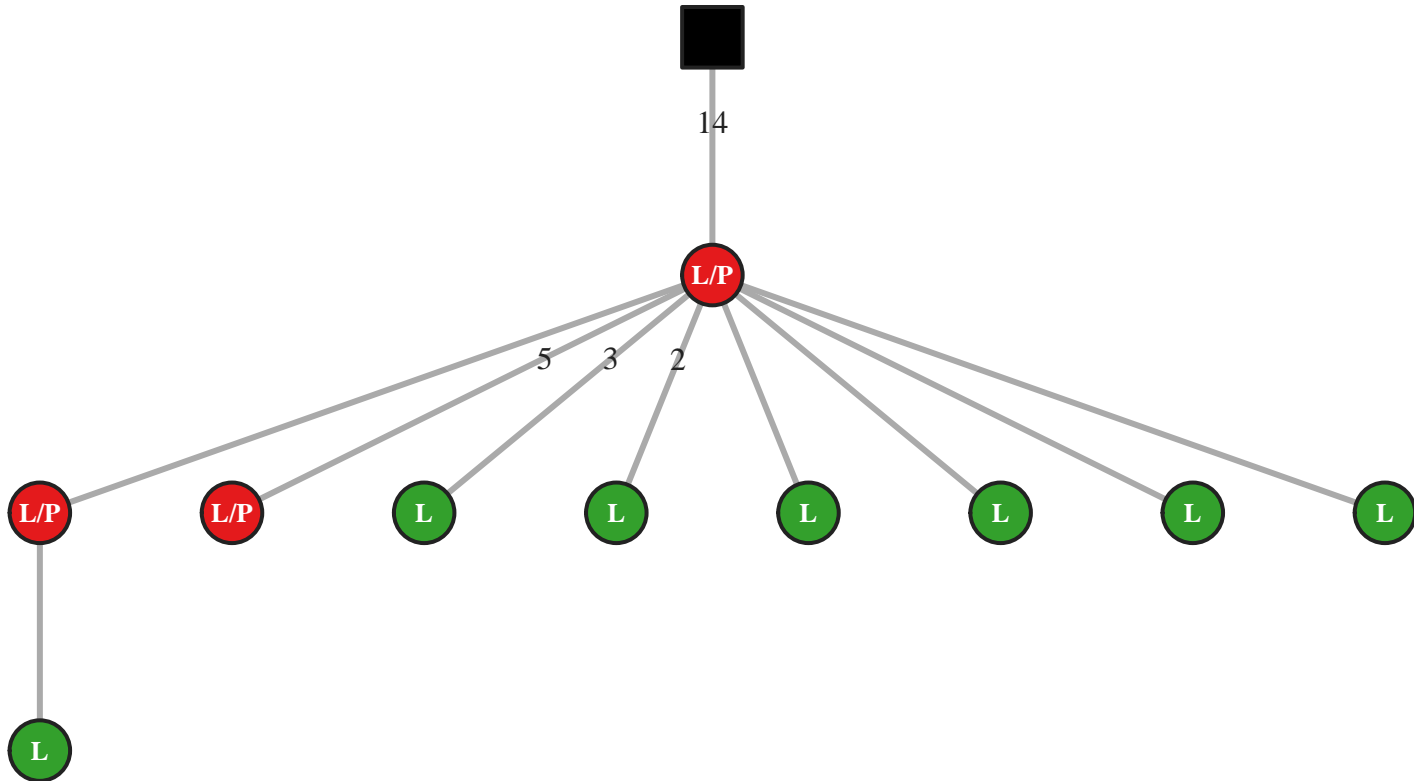

M5 IgG IGHV4-31/J4 42bp (52805)

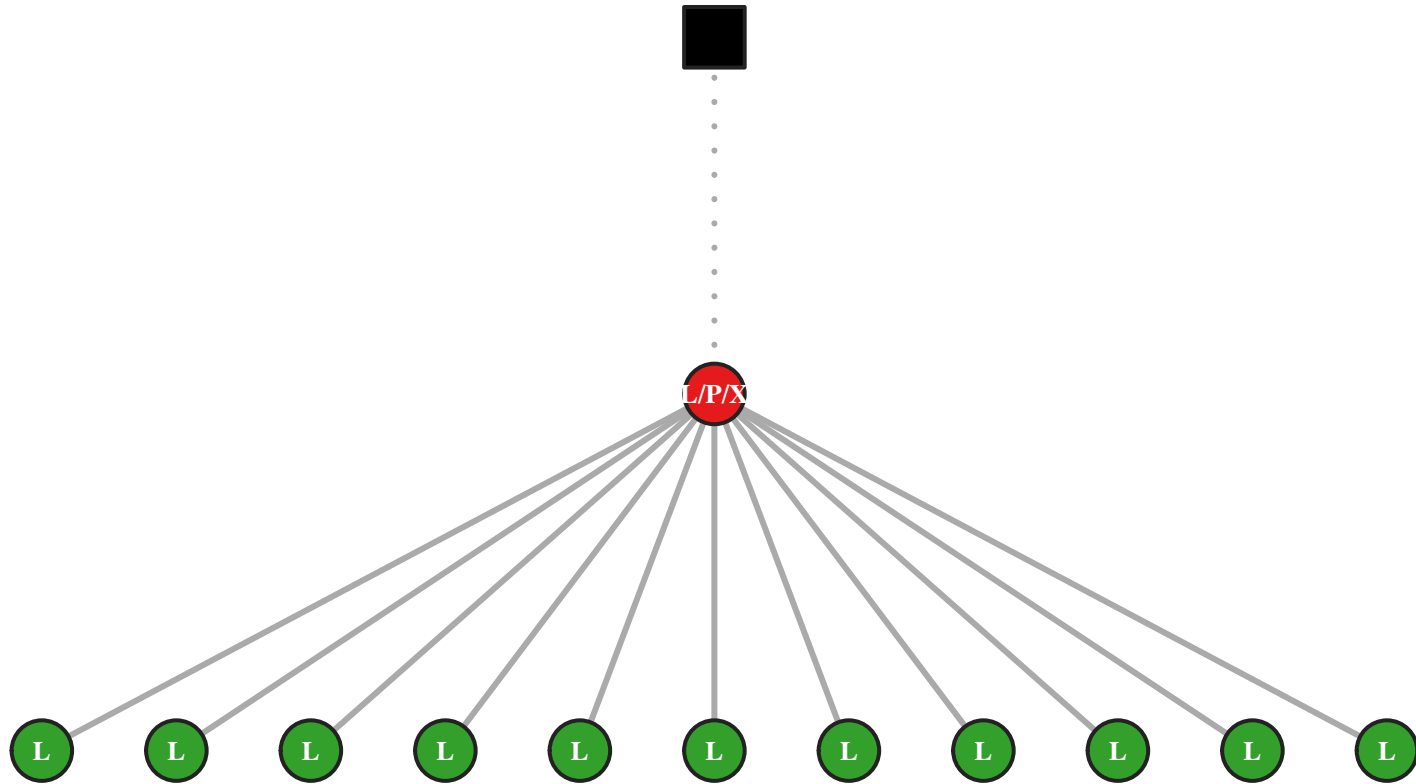

M5 IgG IGHV4-31/J4 42bp (52811)

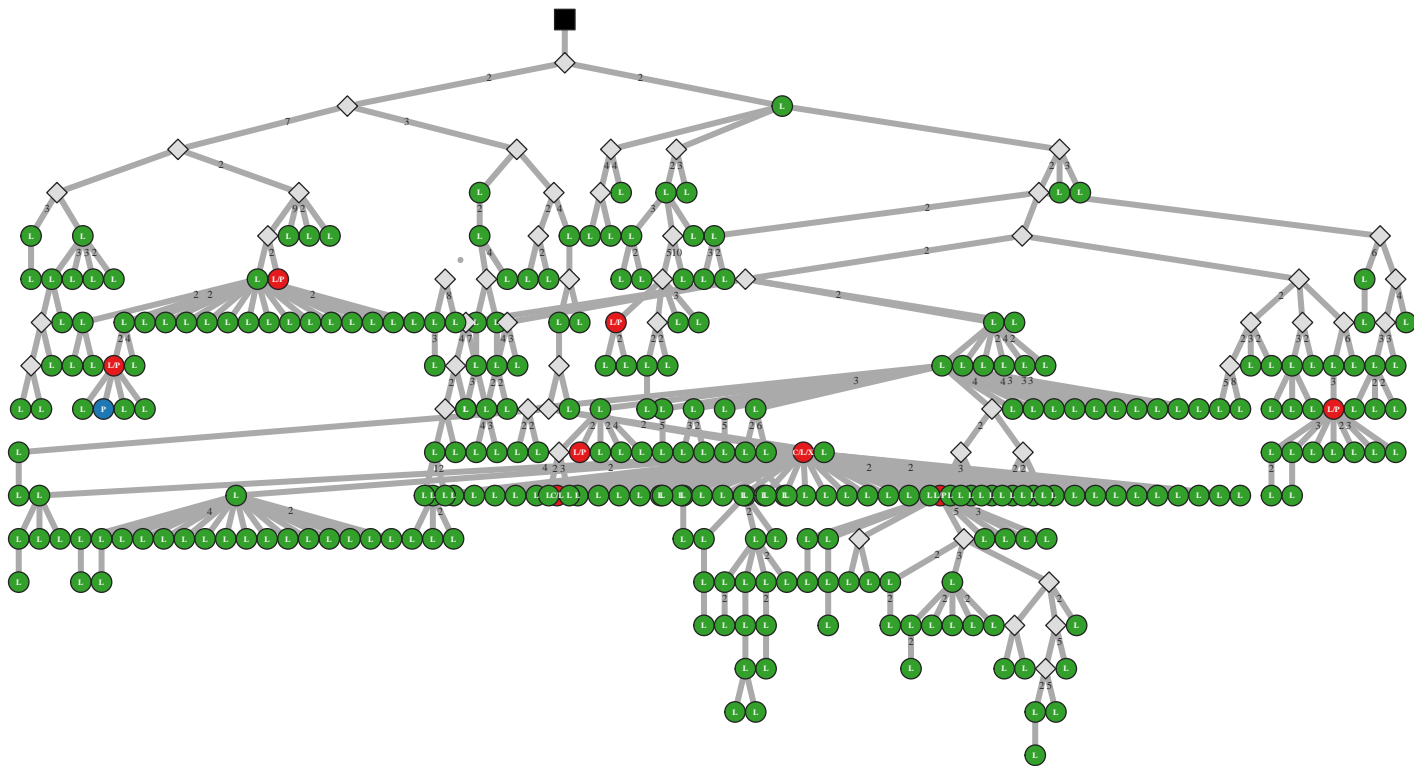

M5 IgG IGHV4-31/J4 42bp (52837)

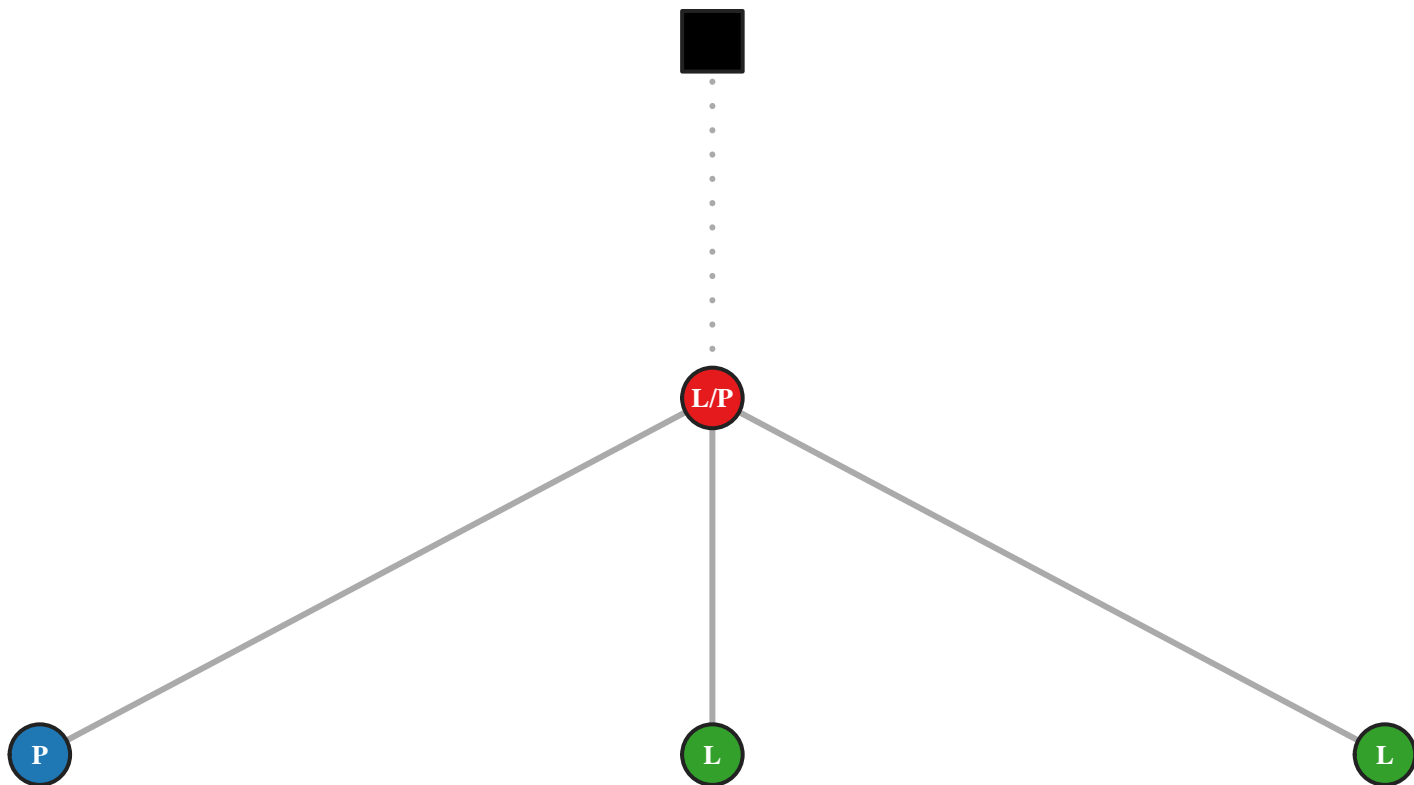

M5 IgG IGHV4-31/J4 42bp (52844)

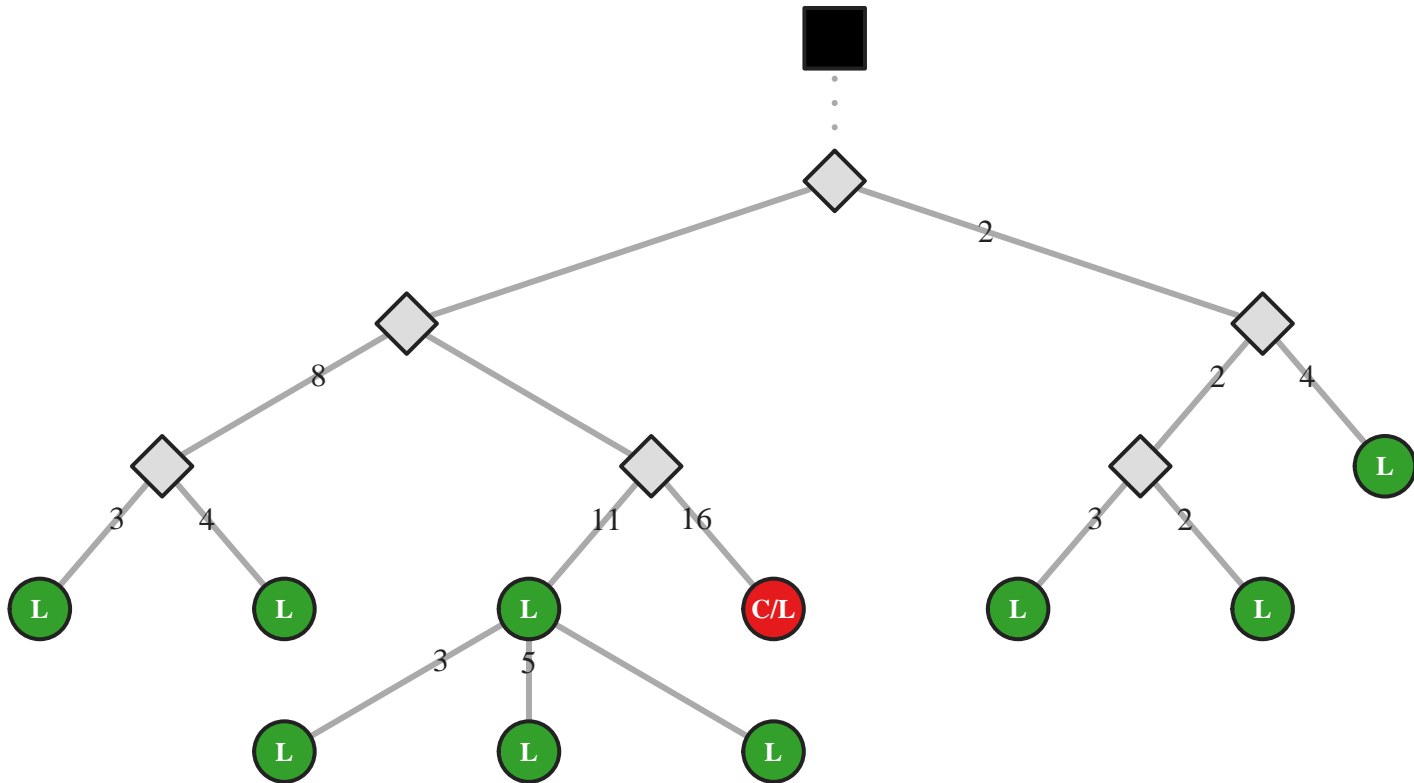

M5 IgG IGHV4-31/J4 45bp (9601)

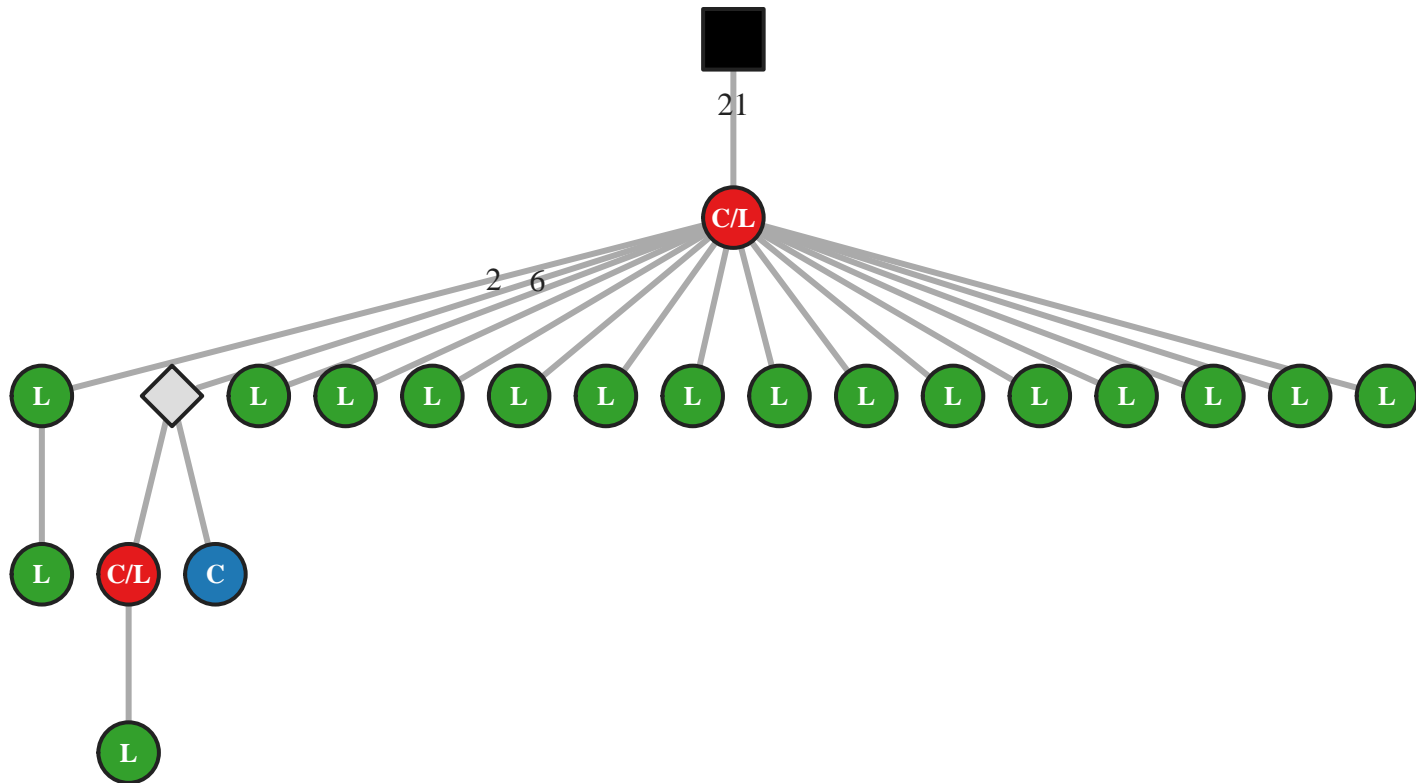

M5 IgG IGHV4-31/J4 45bp (9602)

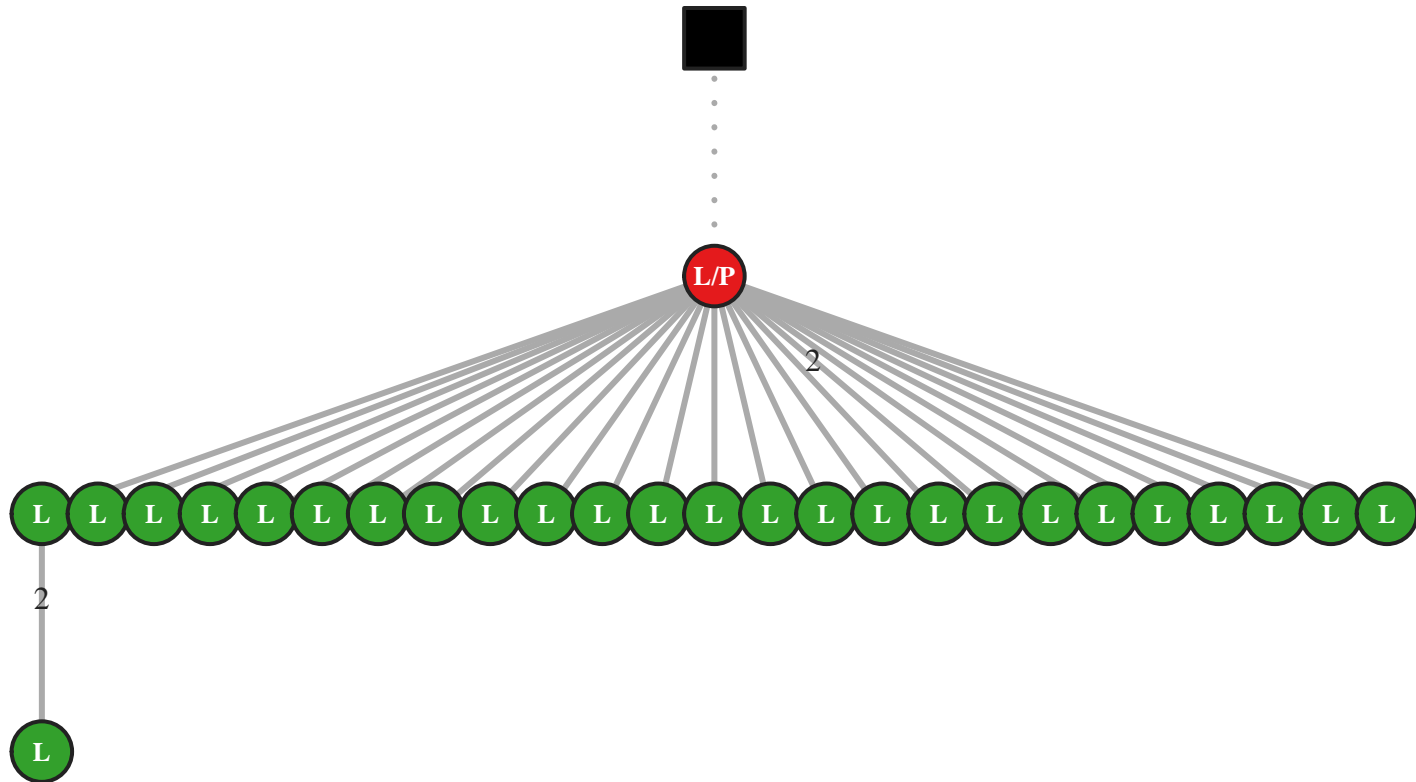

M5 IgG IGHV4-31/J4 45bp (9662)

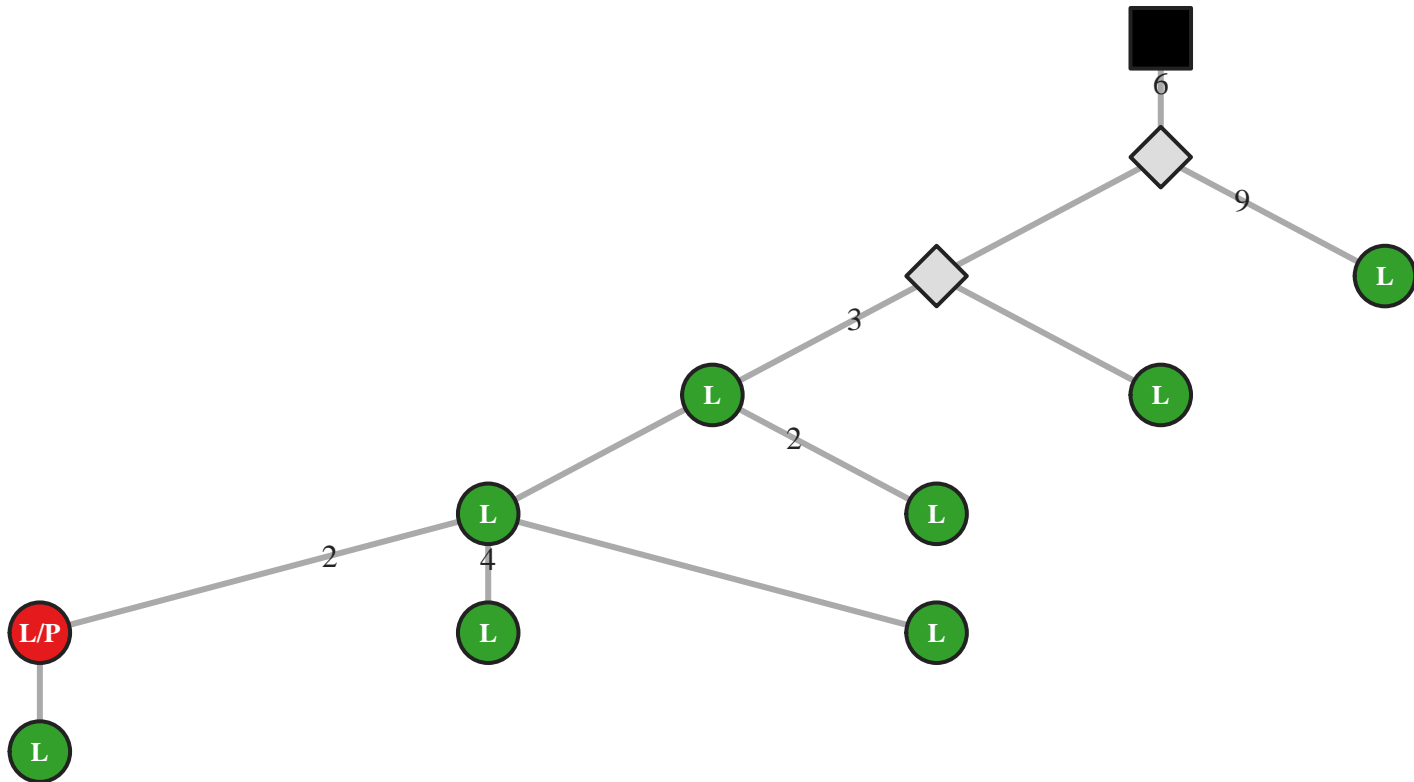

M5 IgG IGHV4-31/J4 48bp (46225)

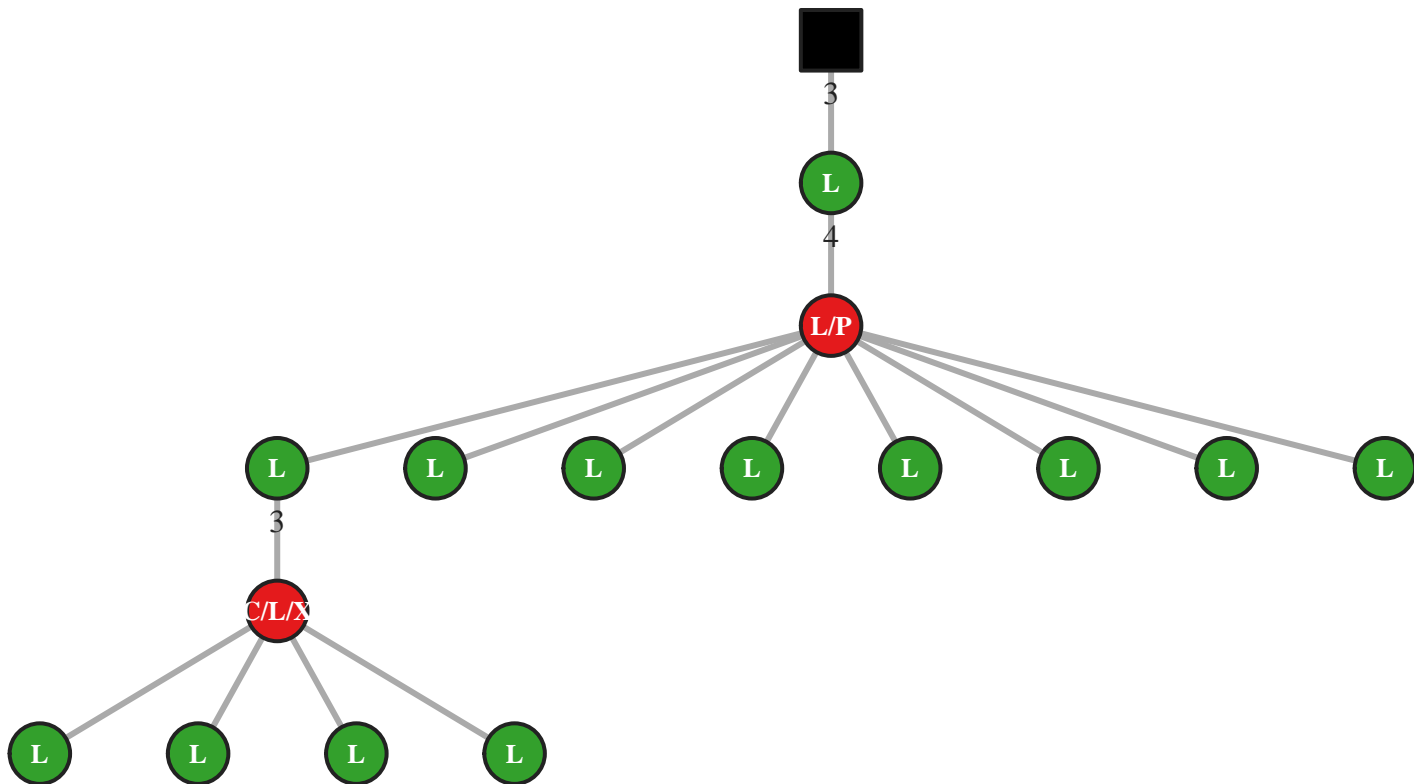

M5 IgG IGHV4-31/J4 48bp (46281)

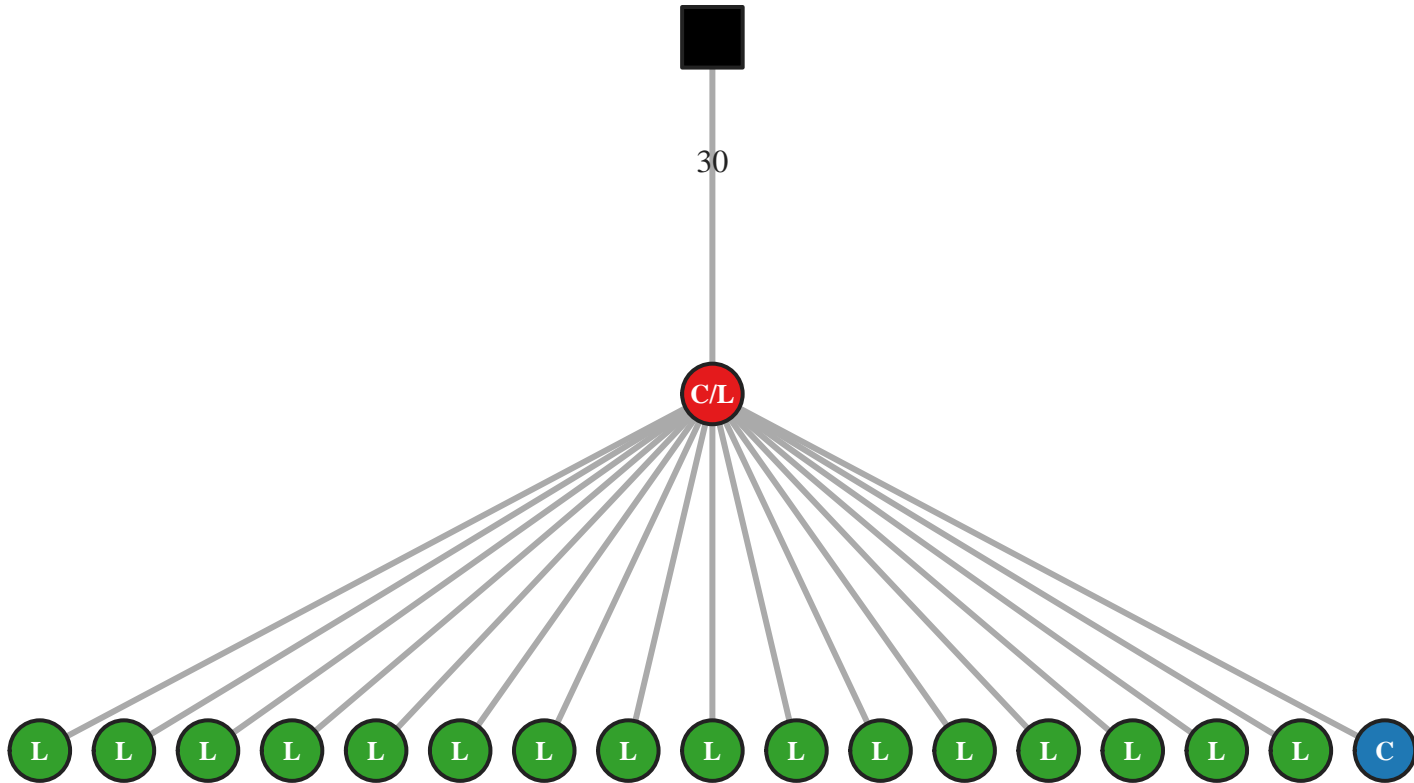

M5 IgG IGHV4-31/J4 51bp (18904)

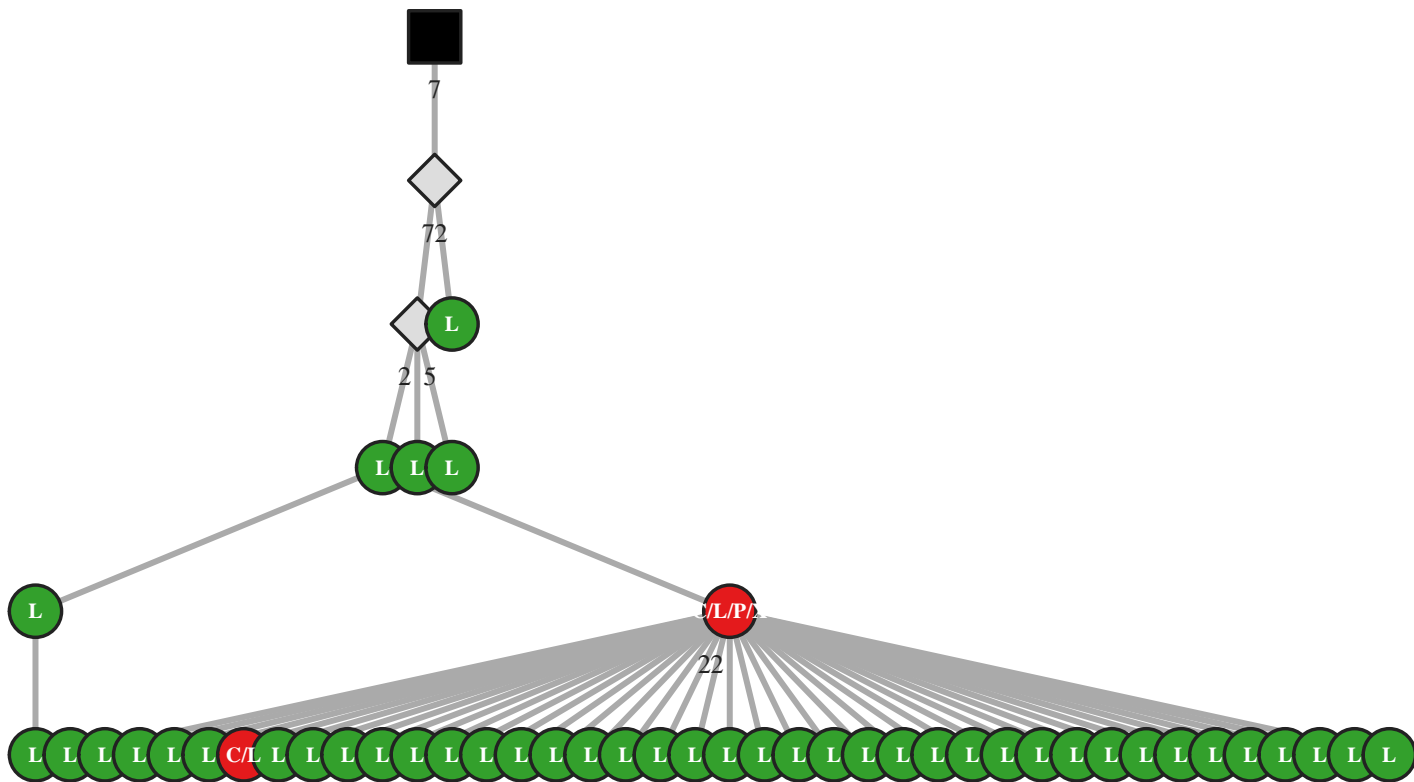

M5 IgA IGHV4-31/J4 54bp (3127)

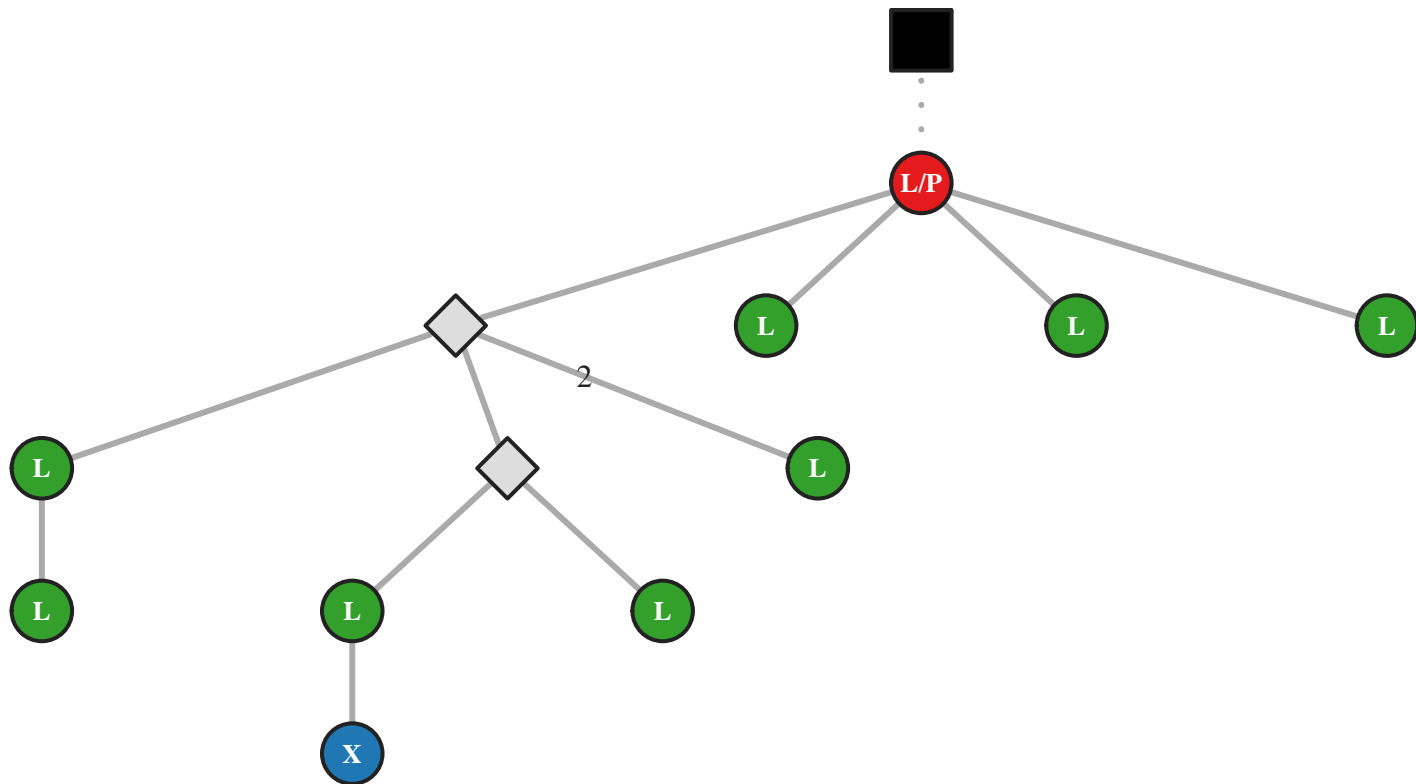

M5 IgA IGHV4-31/J4 54bp (3133)

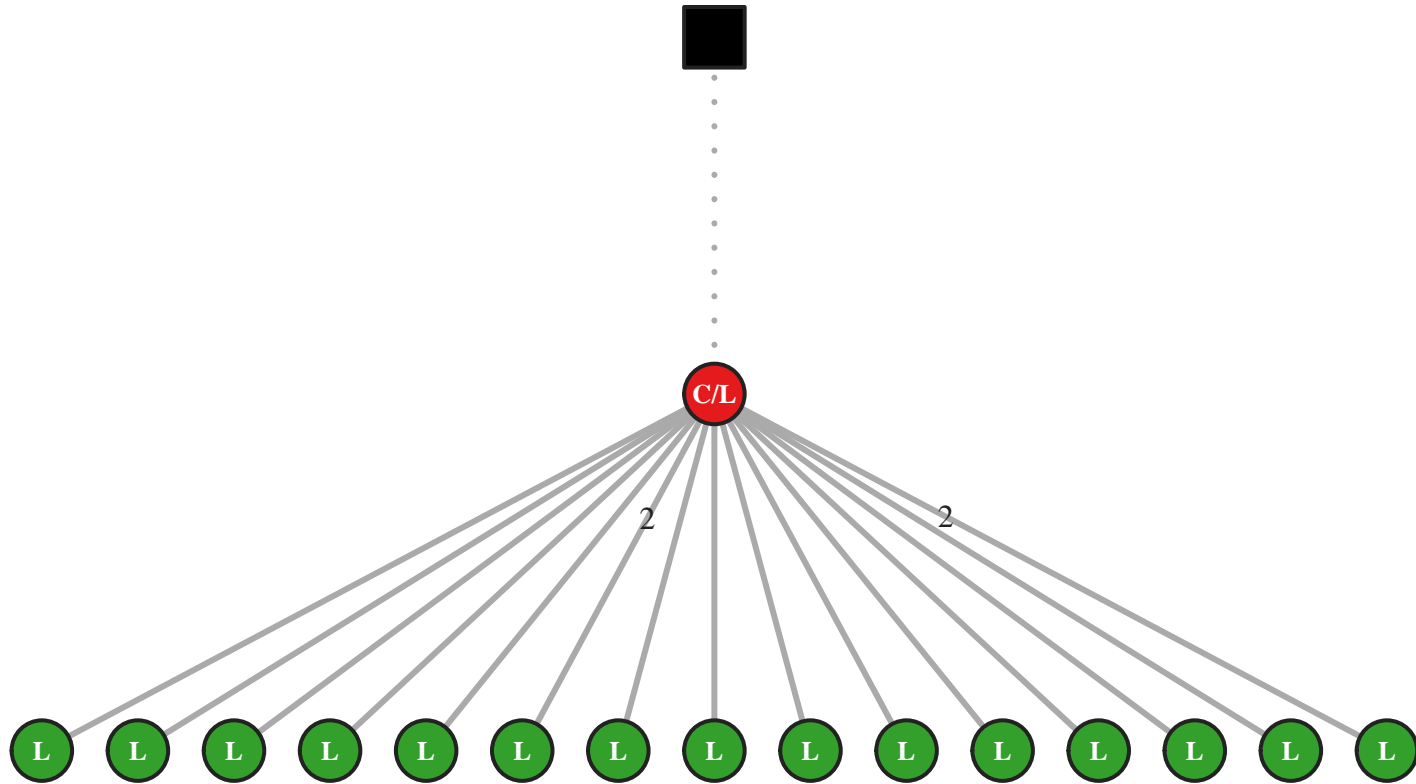

M5 IgG IGHV4-31/J4 54bp (36012)

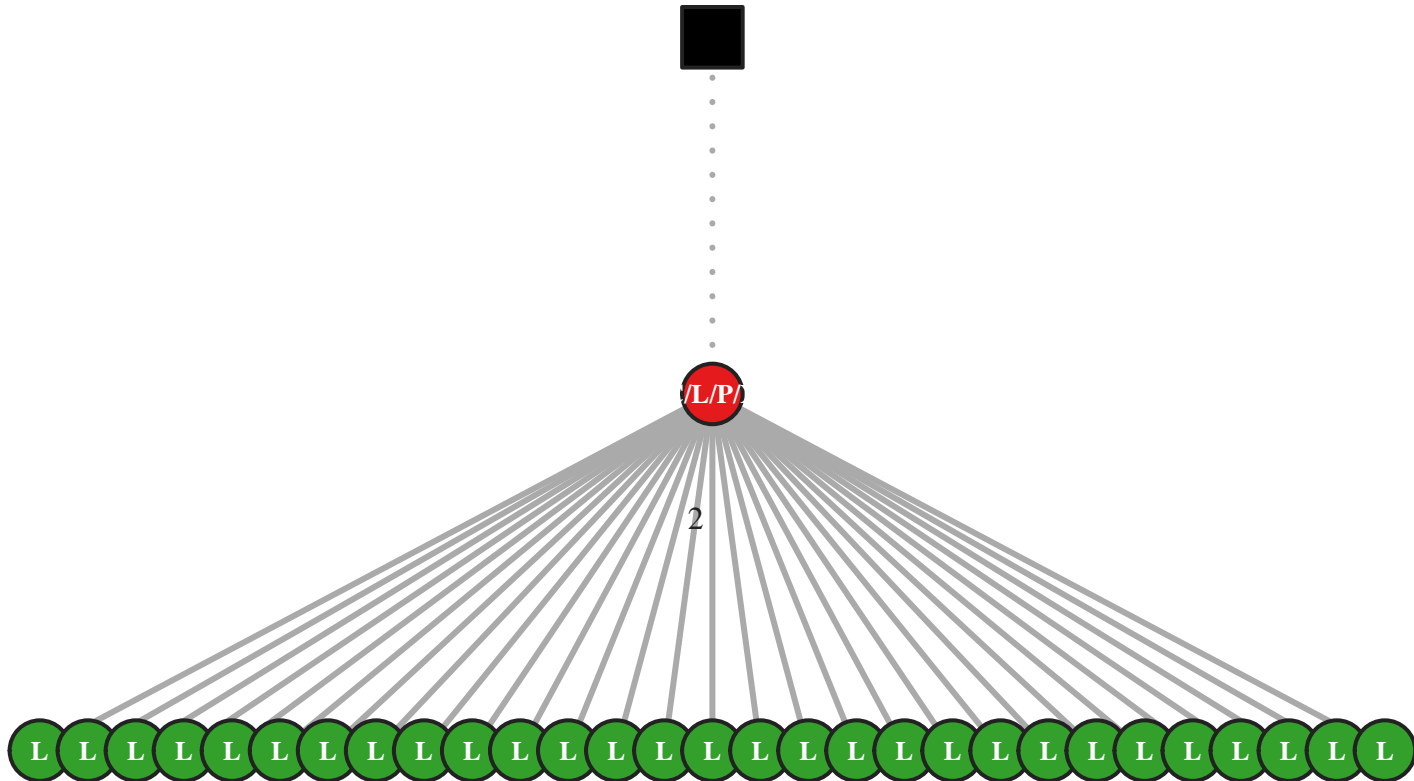

M5 IgG IGHV4-31/J4 54bp (36015)

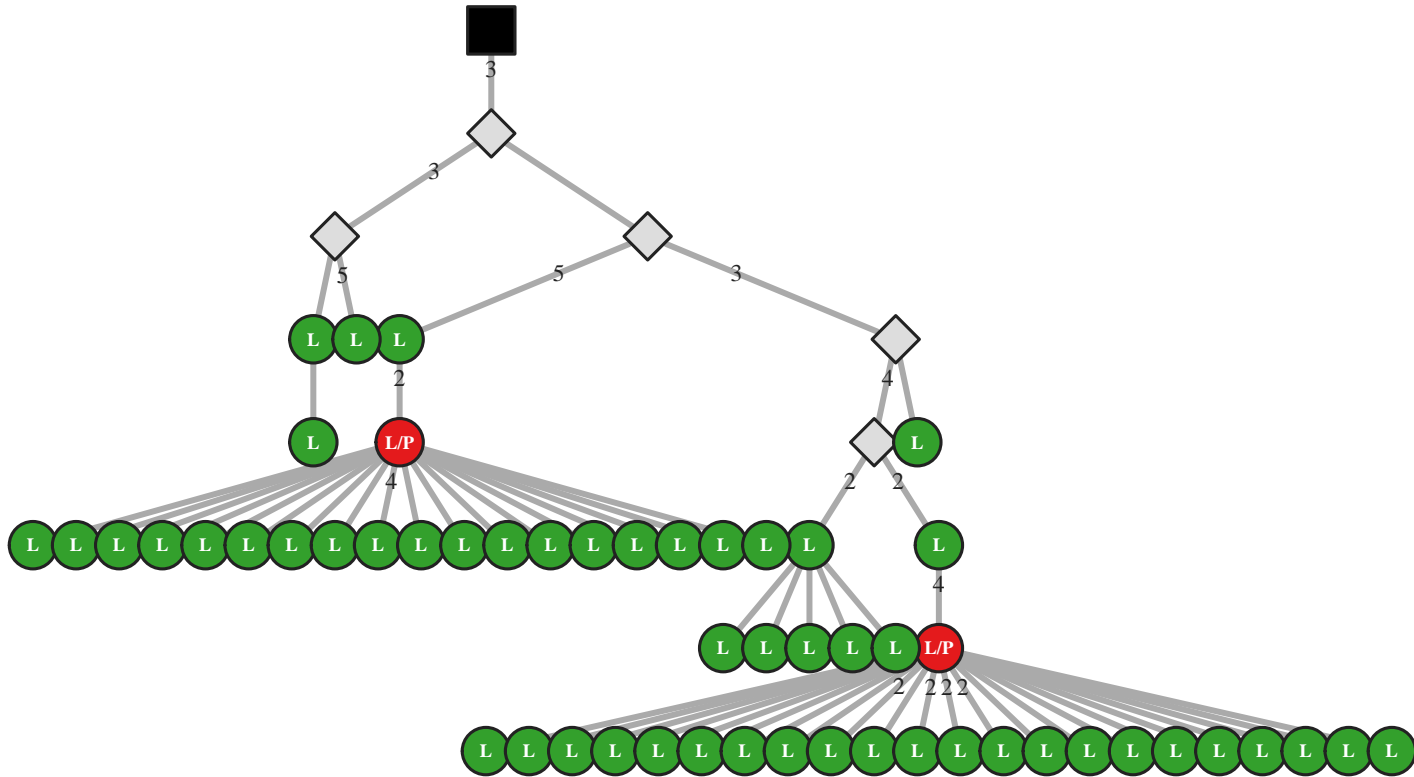

M5 IgG IGHV4-31/J4 54bp (36022)

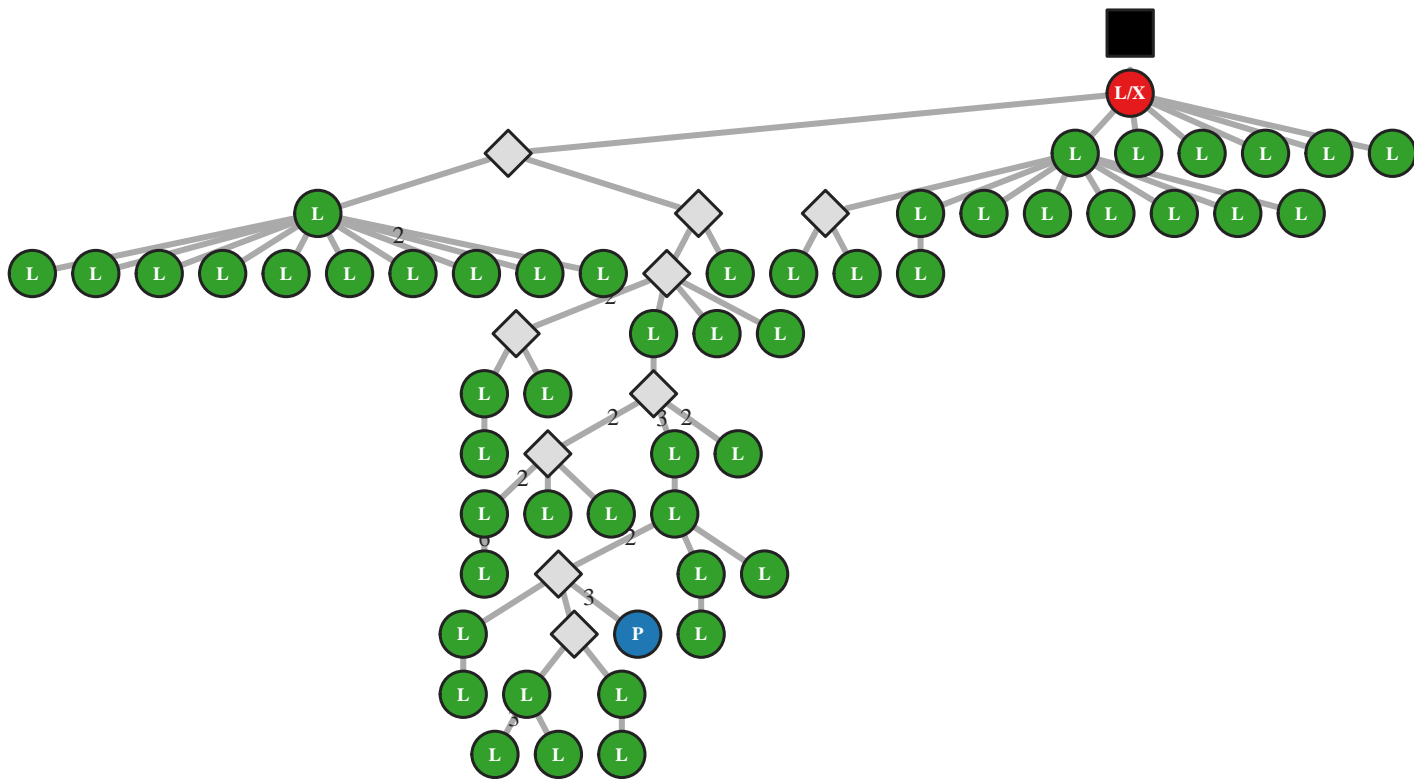

M5 IgG IGHV4-31/J4 54bp (36024)

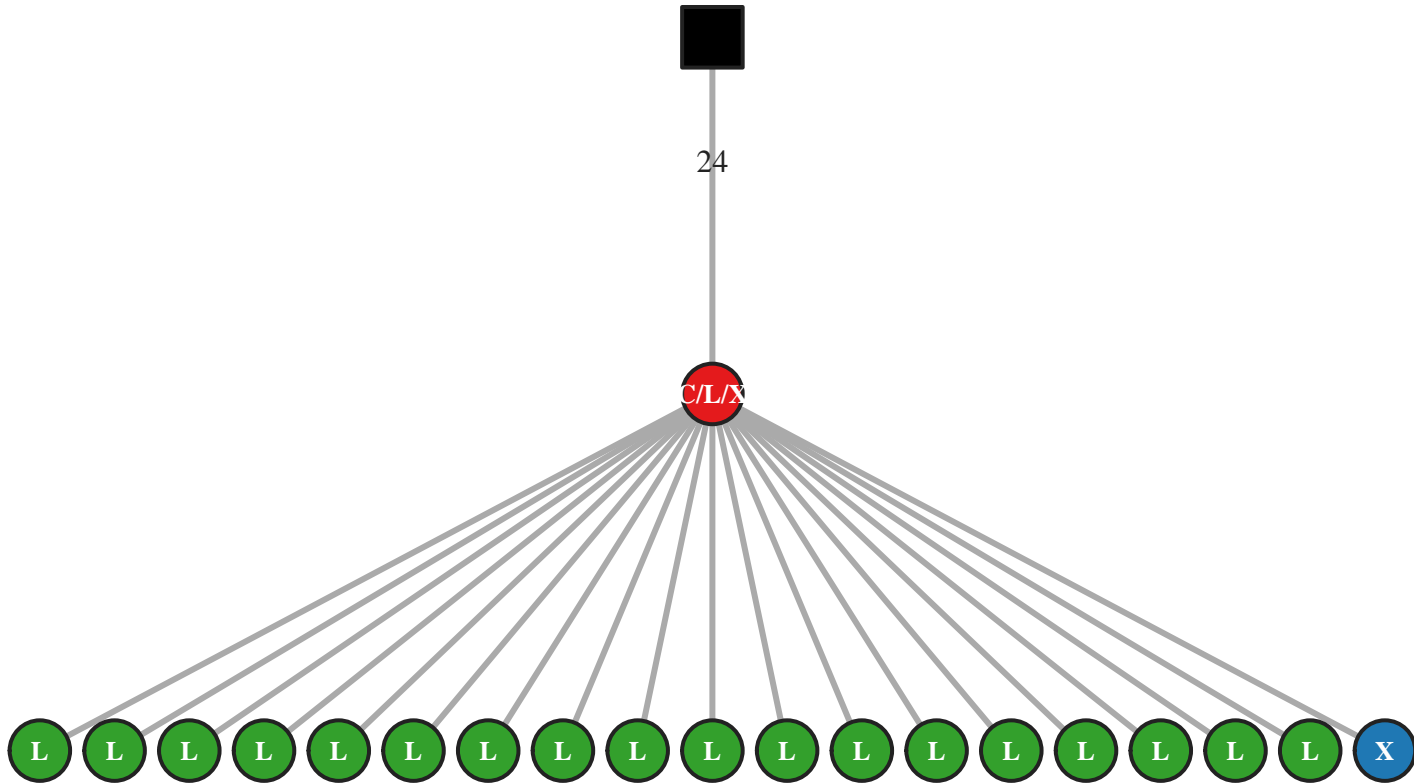

M5 IgG IGHV4-31/J4 54bp (36035)

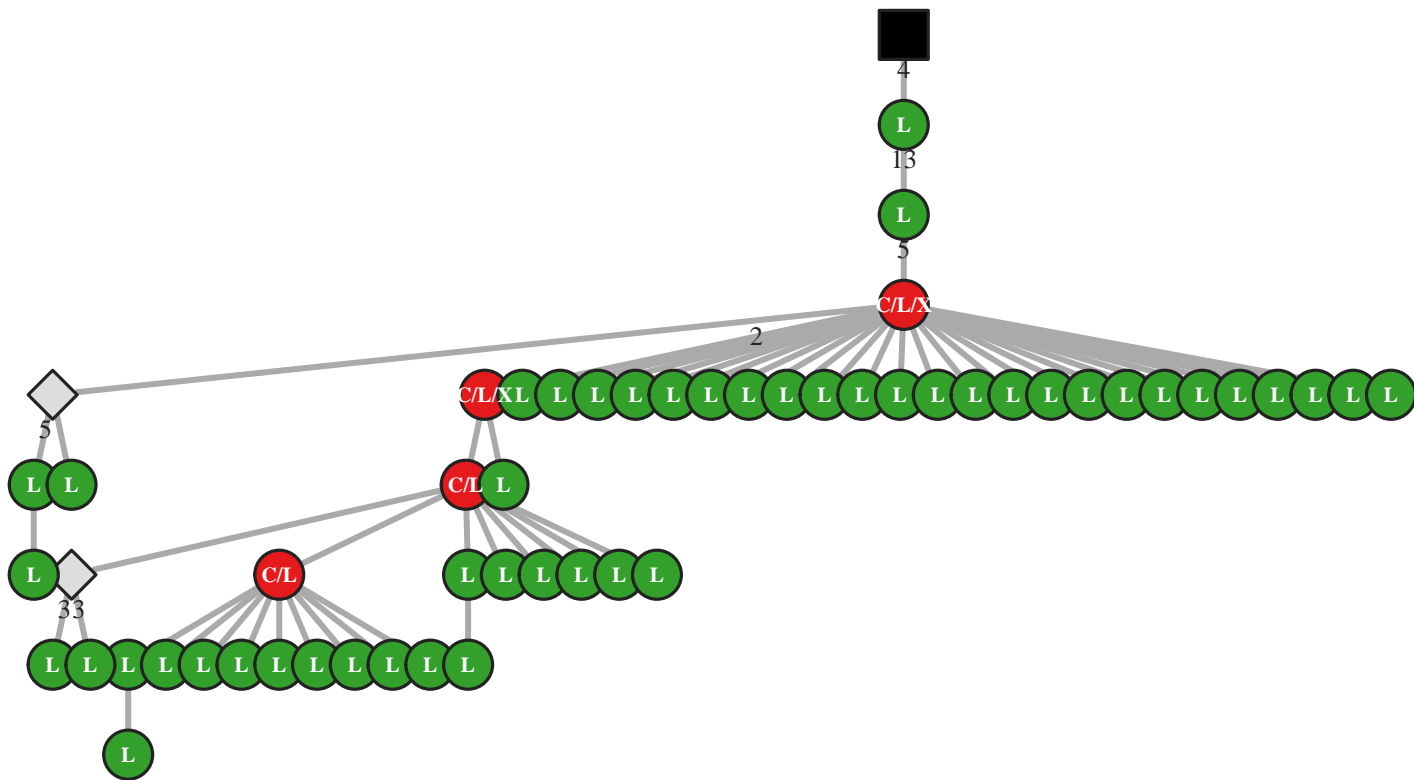

M5 IgG IGHV4-31/J4 54bp (36084)

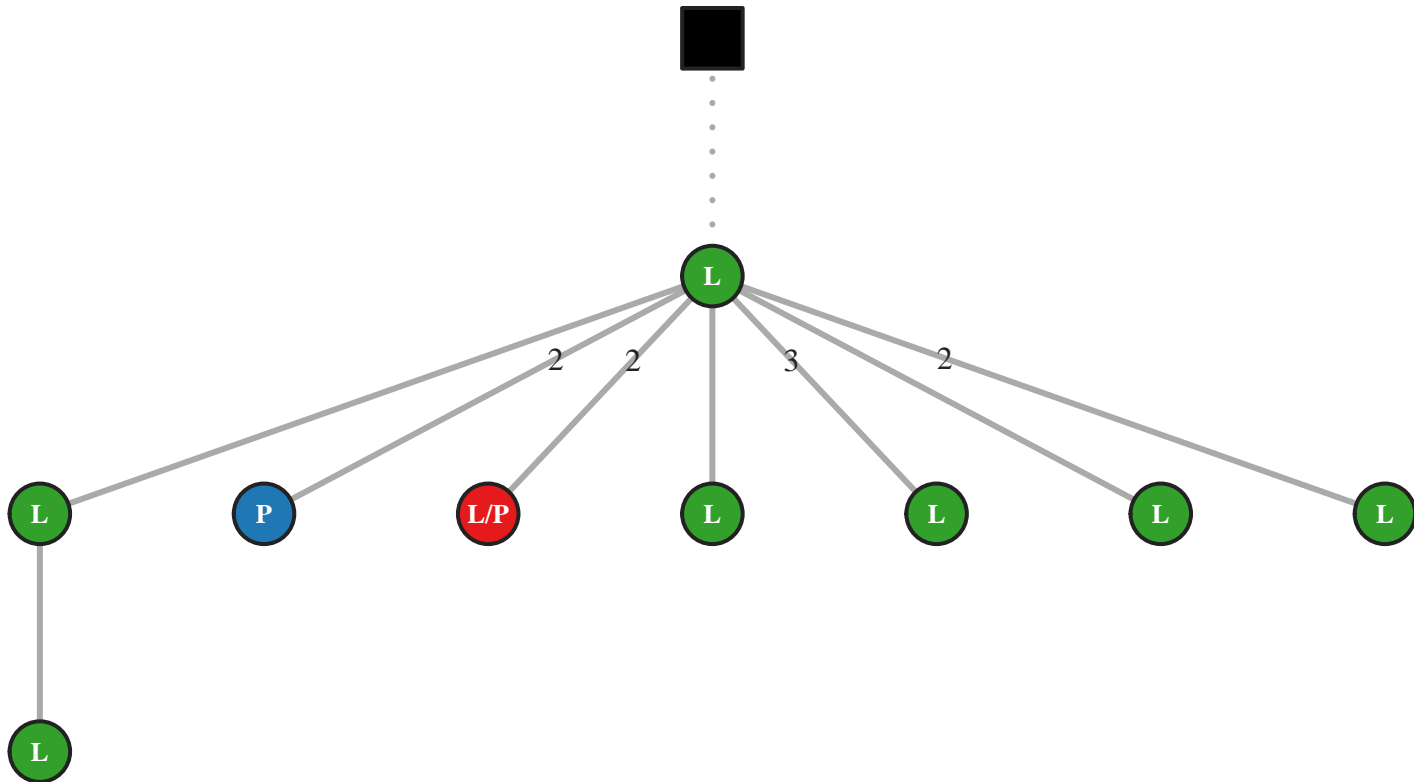

M5 IgG IGHV4-31/J4 57bp (27775)

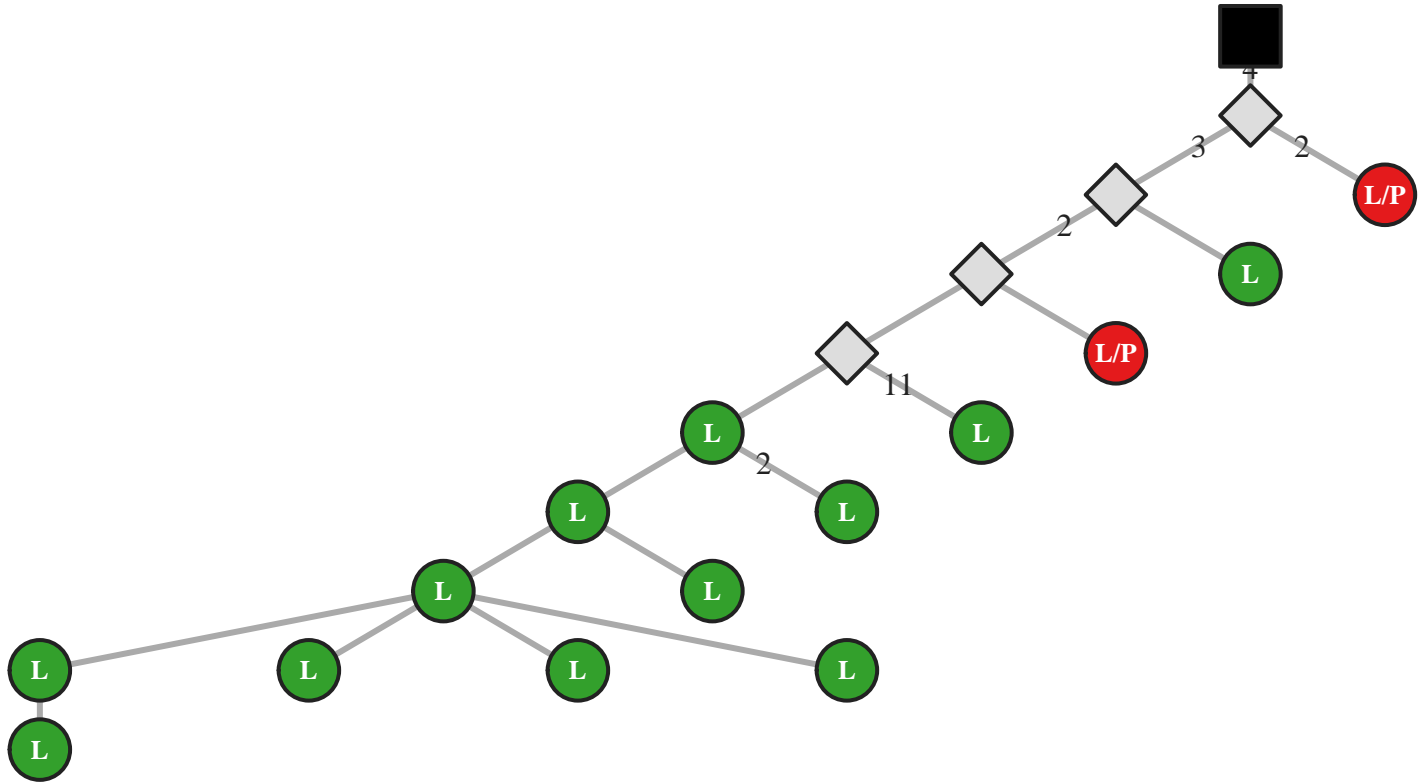

M5 IgG IGHV4-31/J4 69bp (46349)

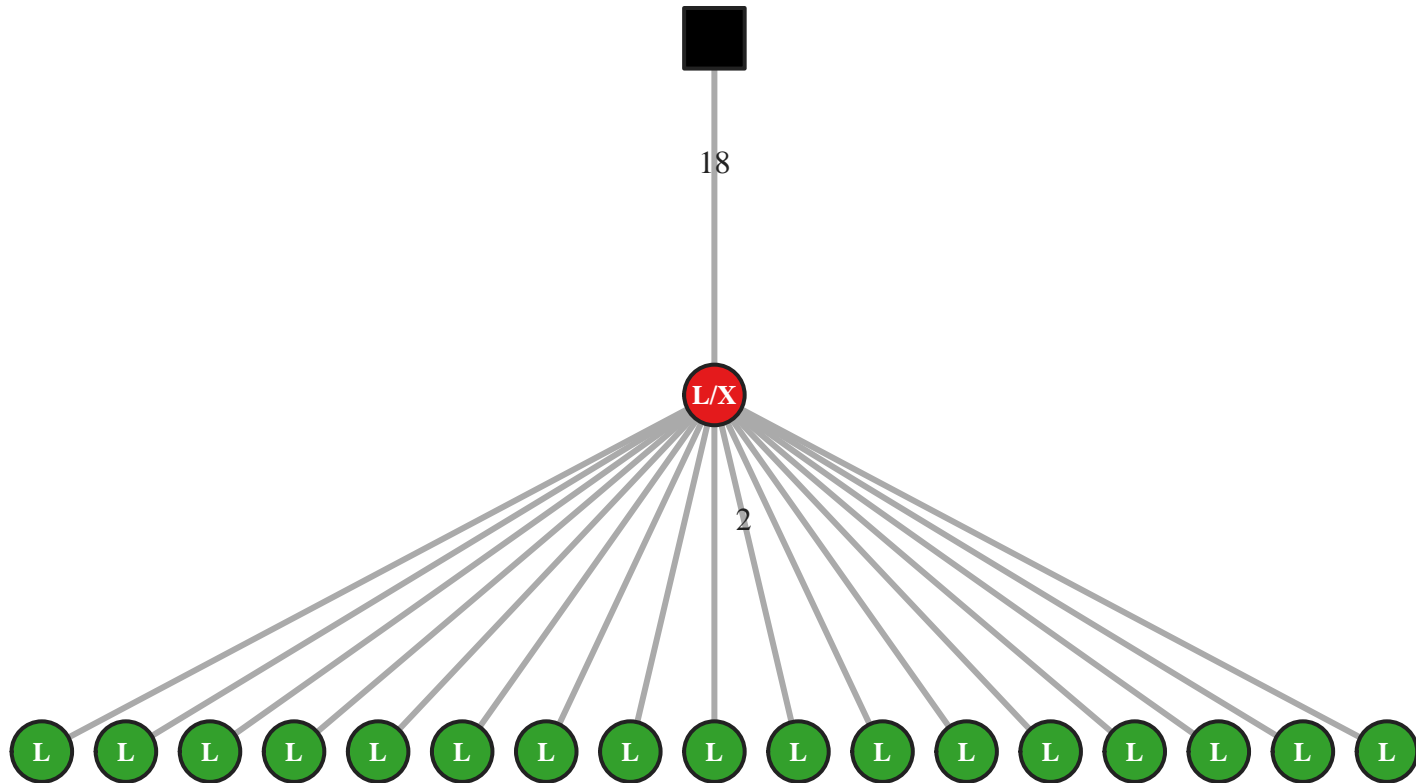

M5 IgG IGHV4-31/J5 21bp (46355)

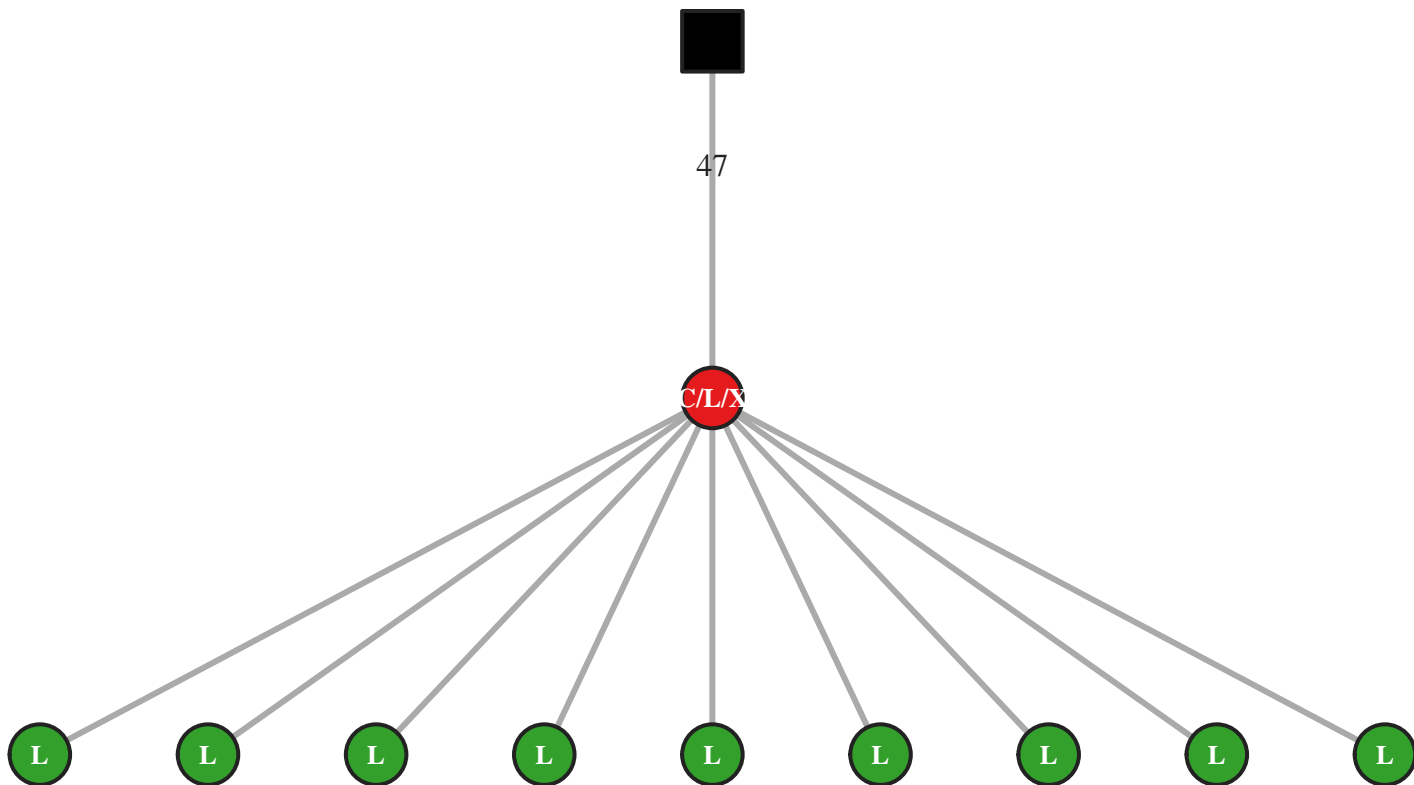

M5 IgG IGHV4-31/J5 42bp (9697)

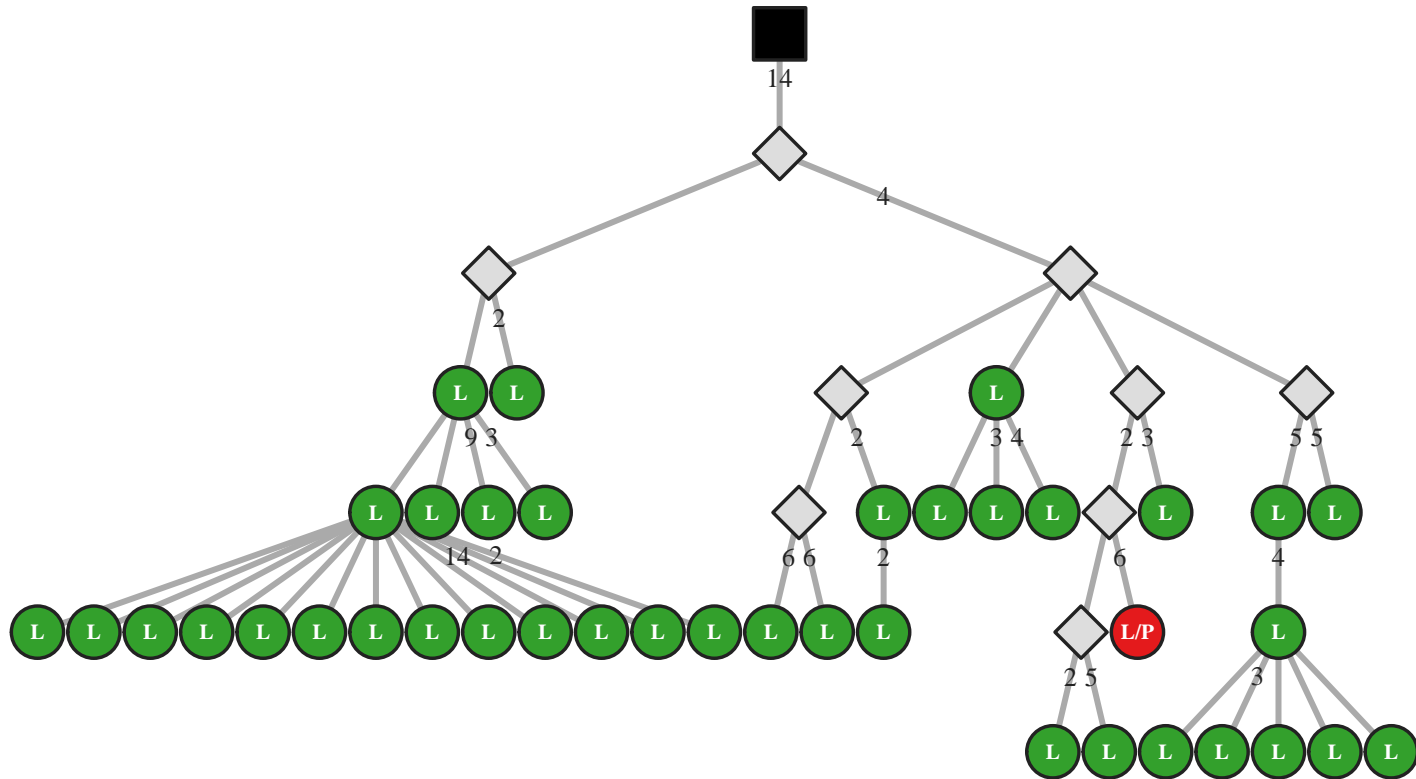

M5 IgG IGHV4-31/J5 45bp (9467)

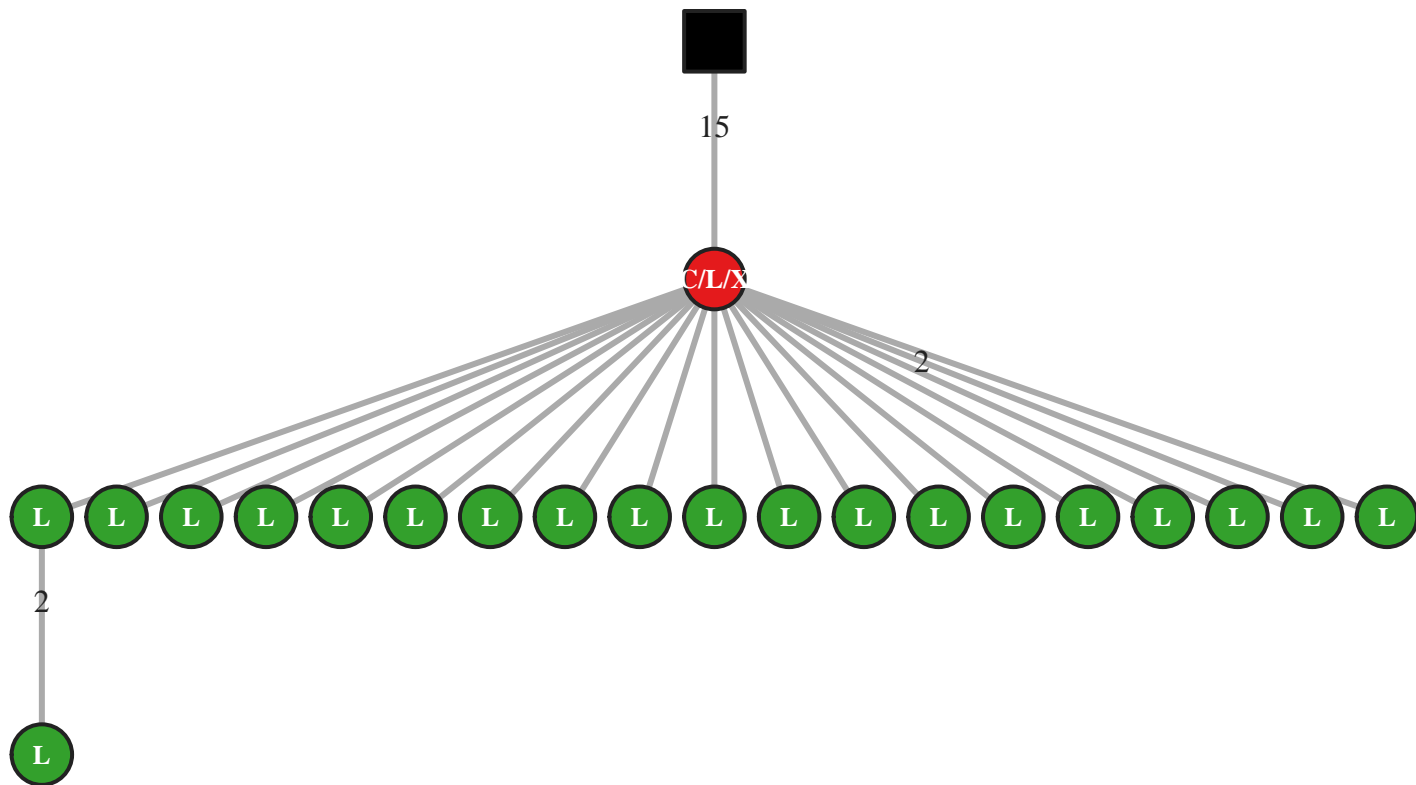

M5 IgG IGHV4-31/J5 48bp (27858)

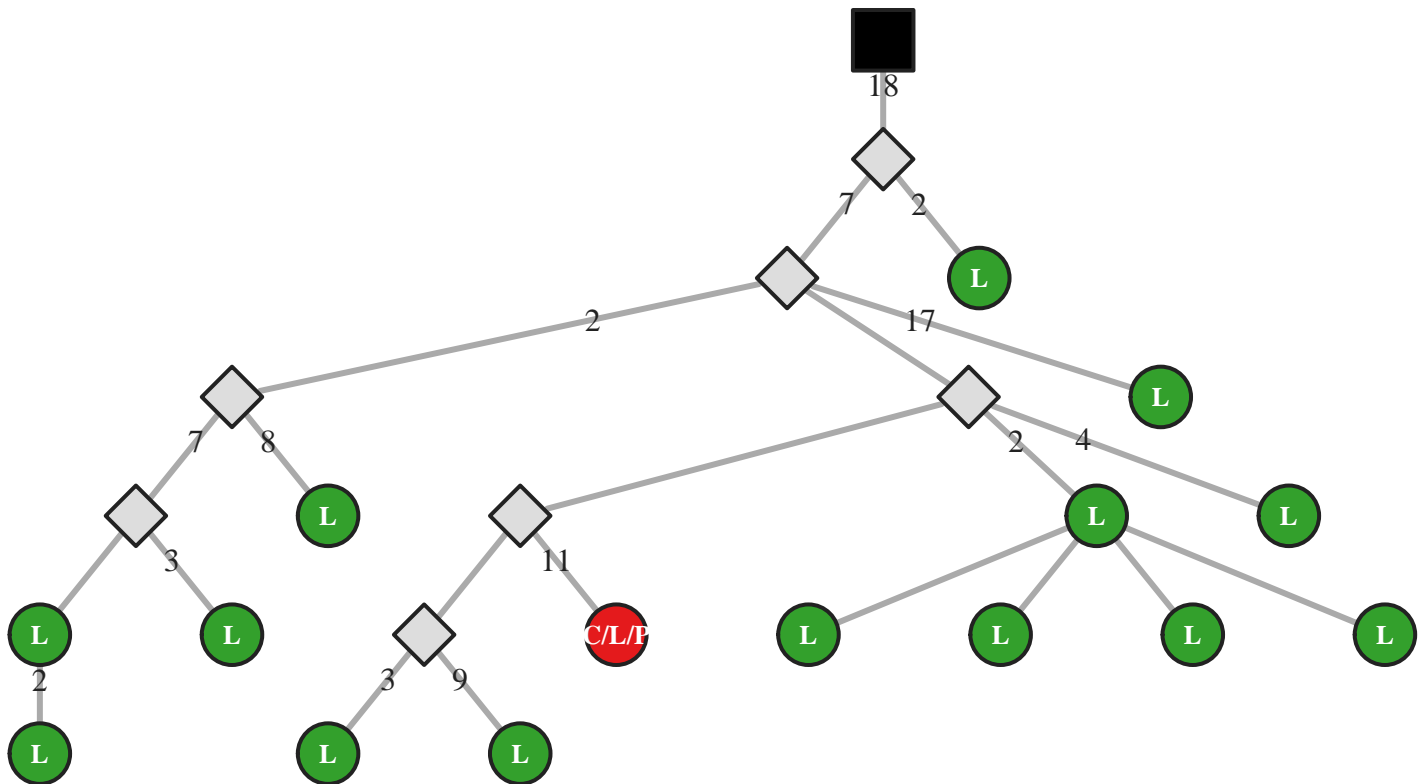

M5 IgG IGHV4-31/J5 48bp (27860)

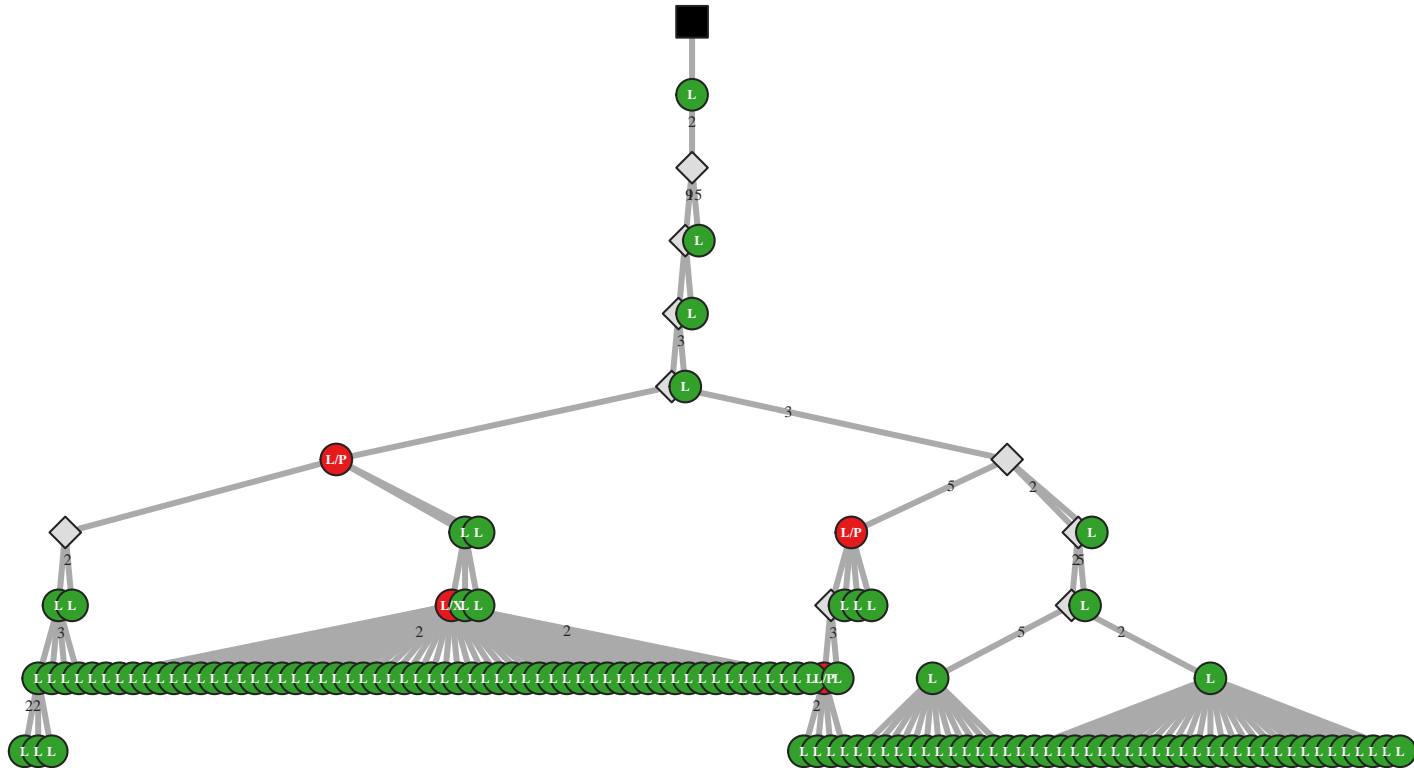

M5 IgG IGHV4-31/J5 54bp (27873)

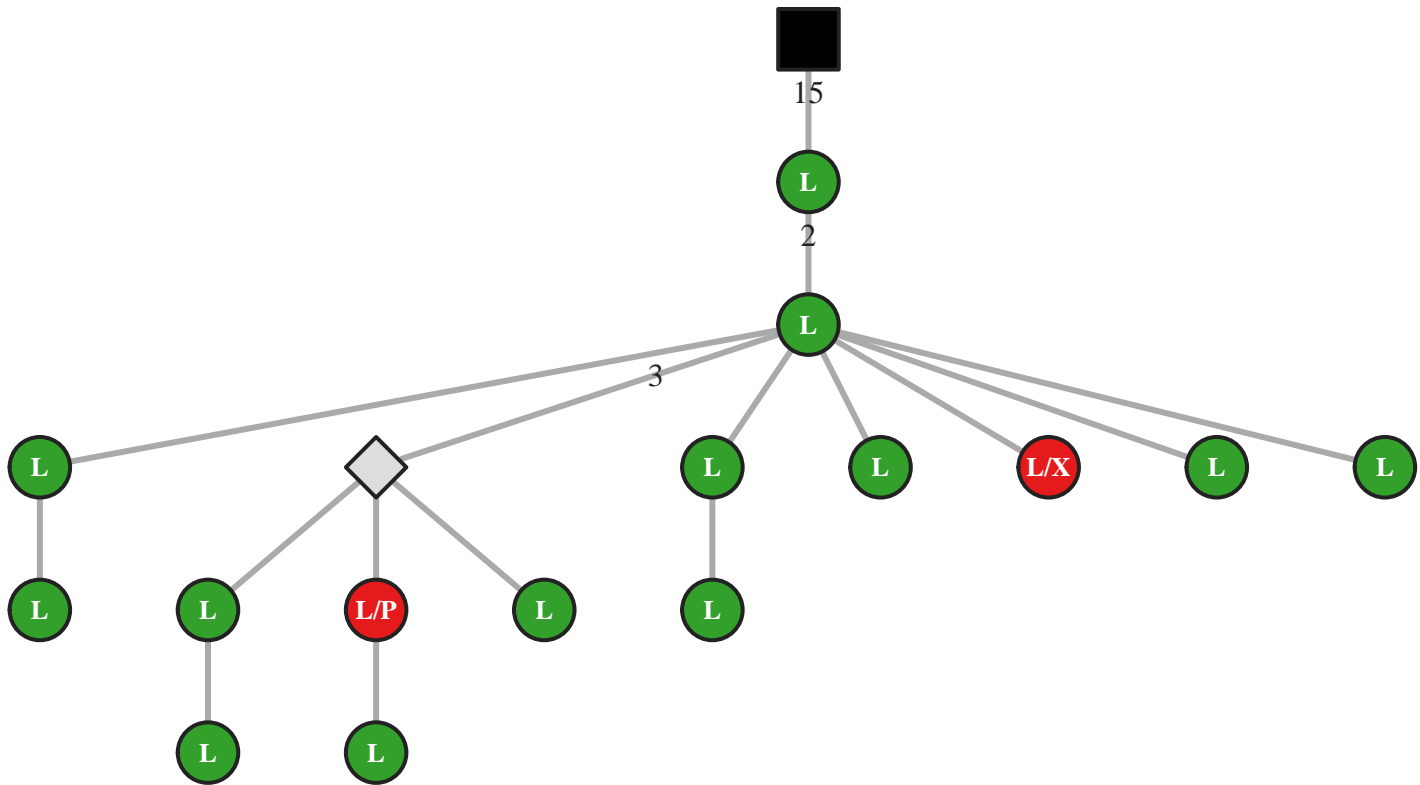

M5 IgG IGHV4-31/J5 54bp (27876)

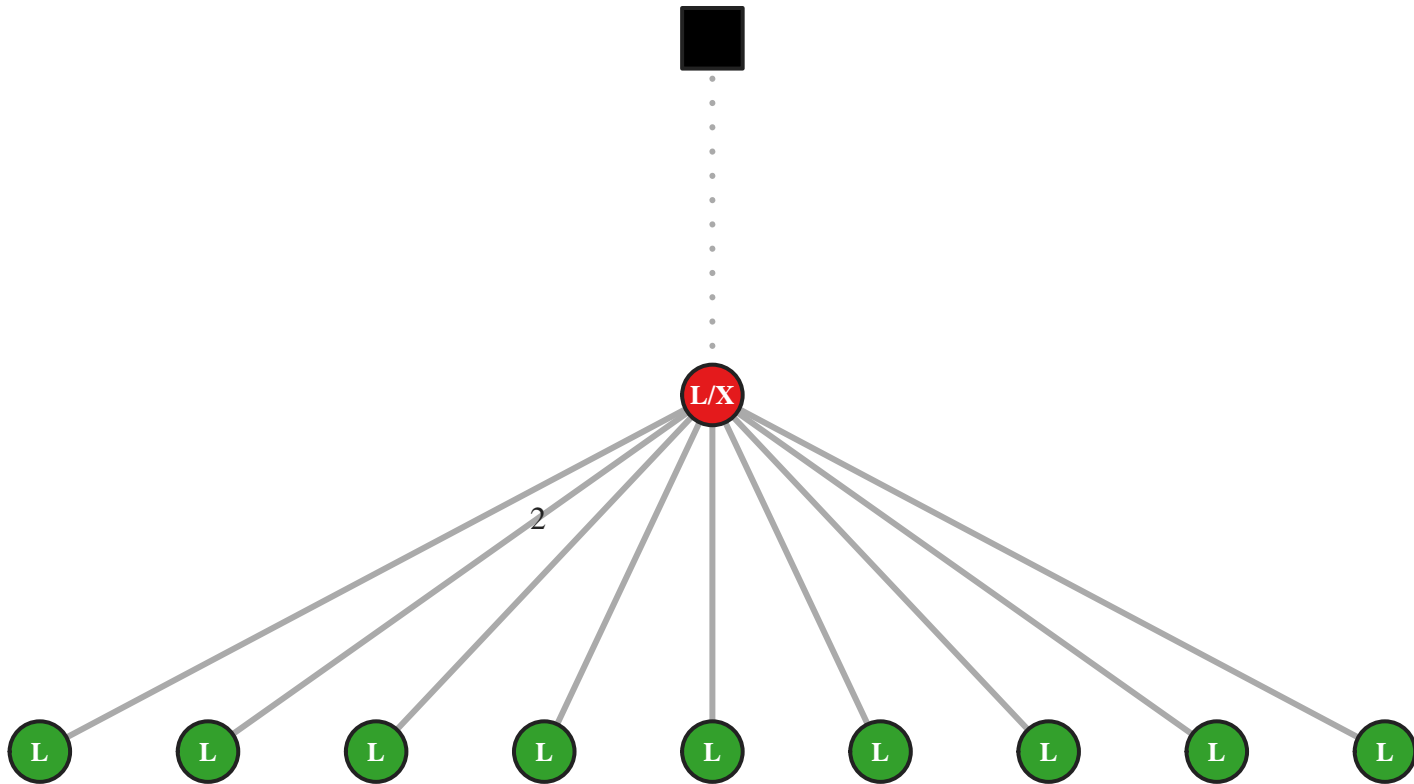

M5 IgG IGHV4-31/J5 57bp (9752)

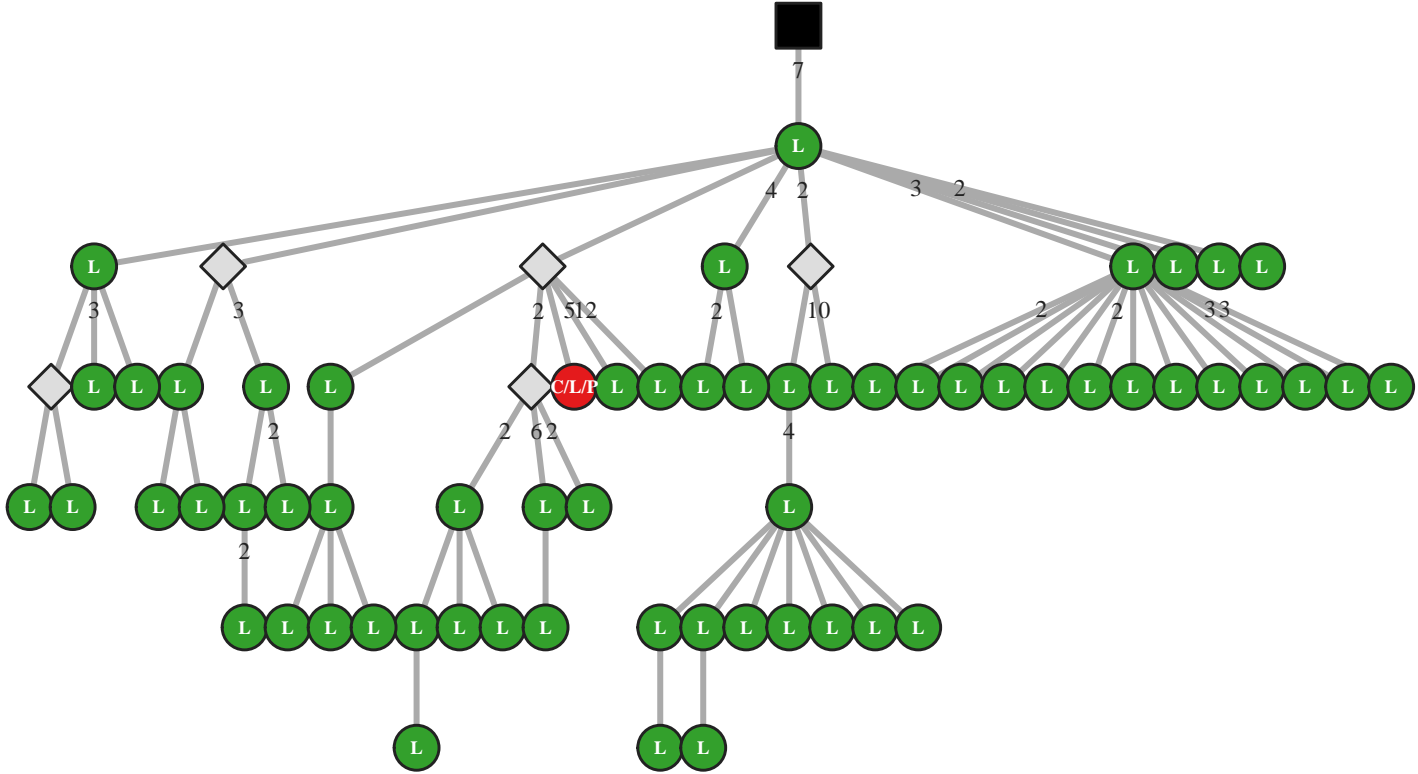

M5 IgG IGHV4-31/J6 42bp (18990)

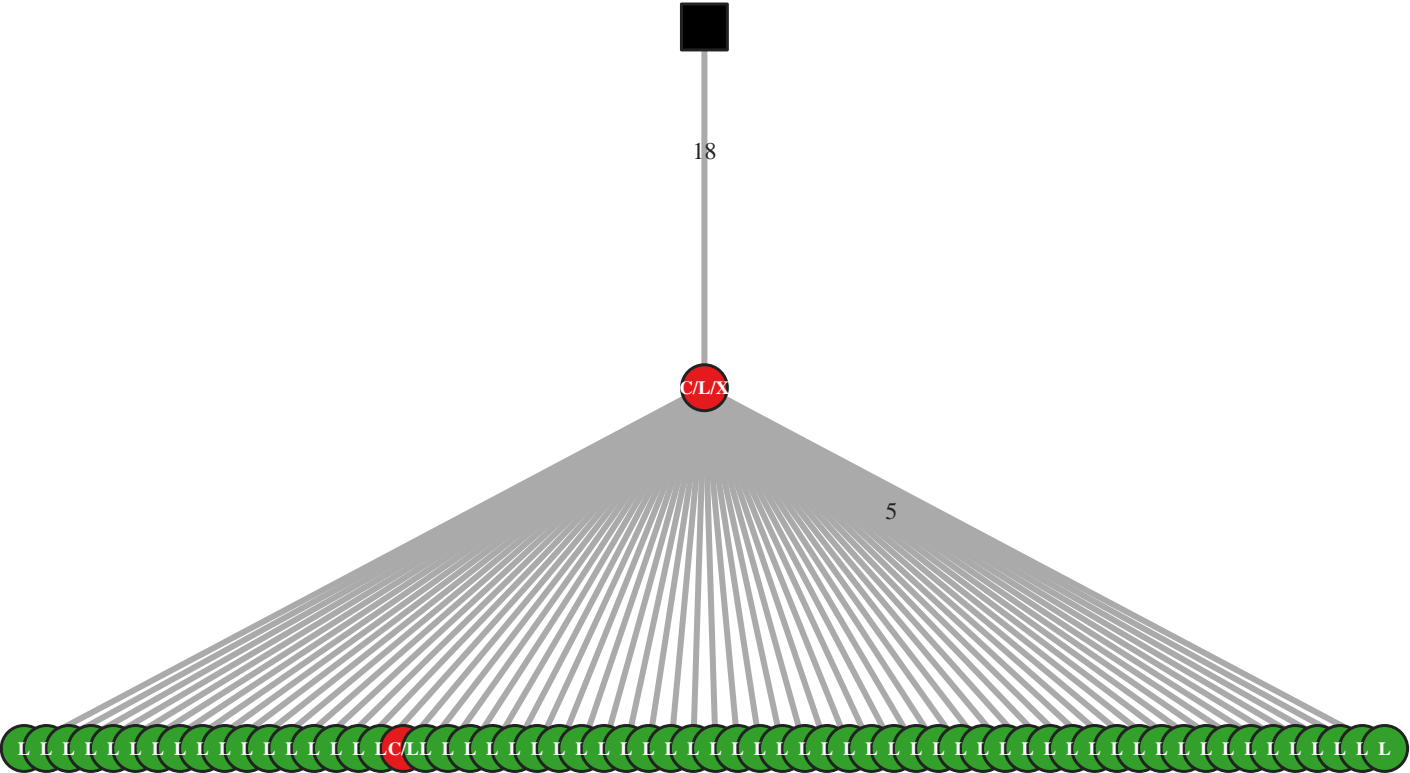

M5 IgG IGHV4-31/J6 48bp (52886)

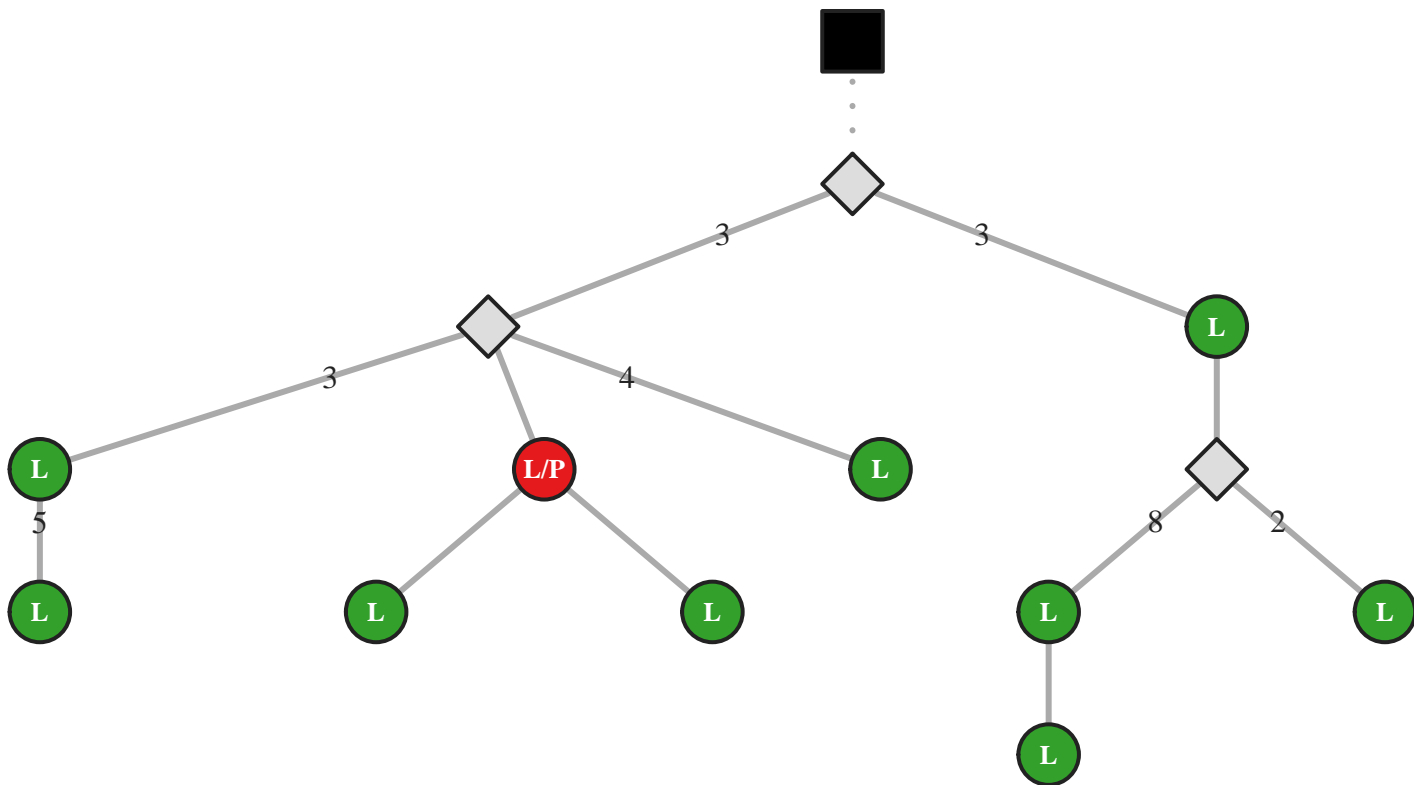

M5 IgG IGHV4-31/J6 51bp (27901)

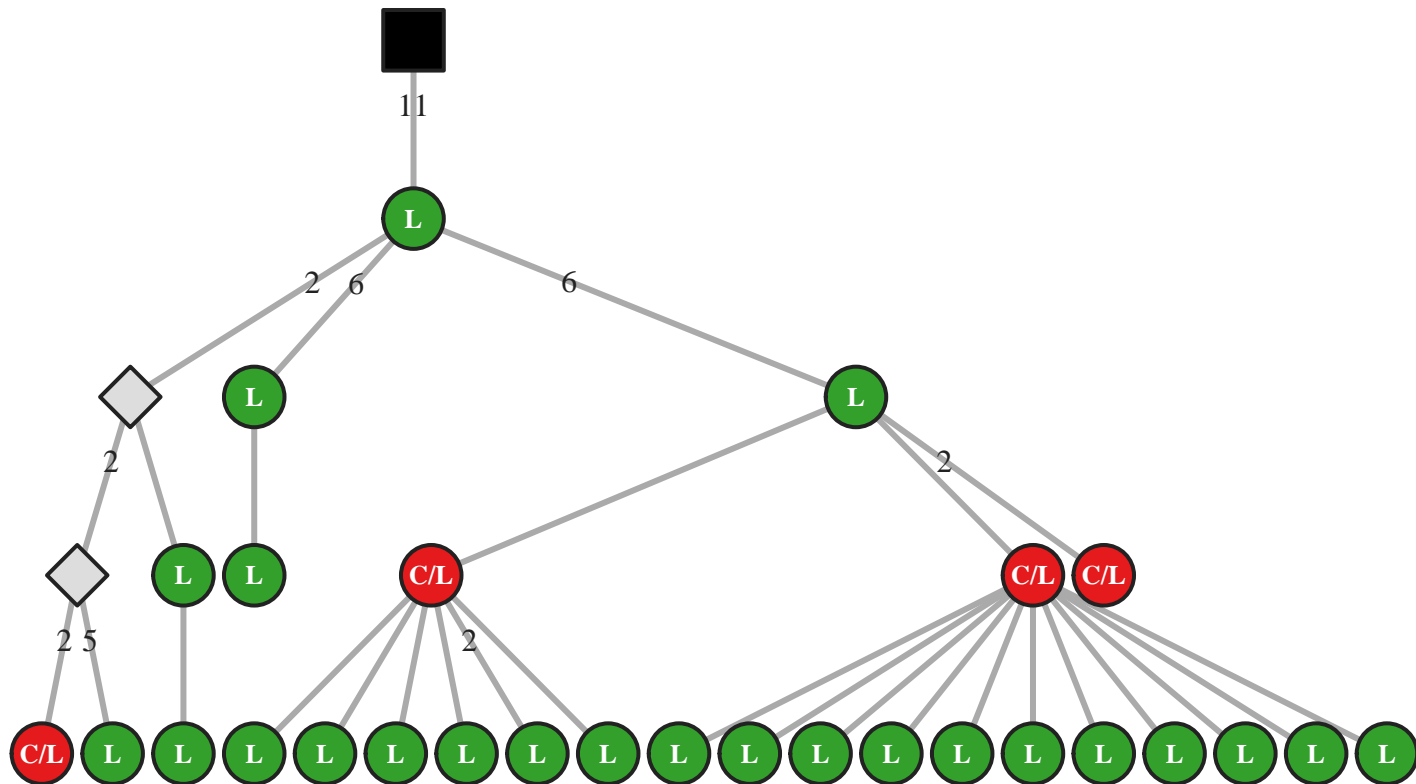

M5 IgG IGHV4-31/J6 57bp (52899)

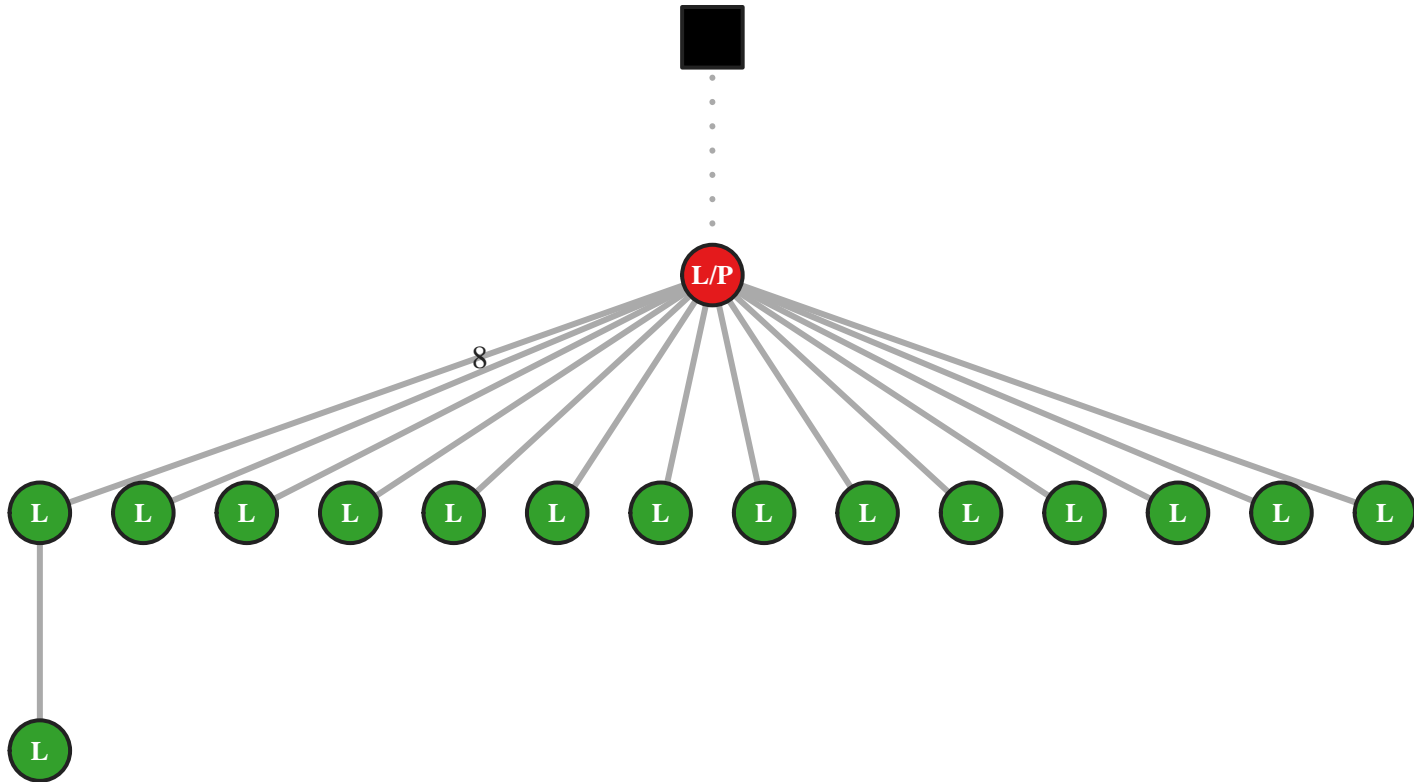

M5 IgG IGHV4-31/J6 57bp (52907)

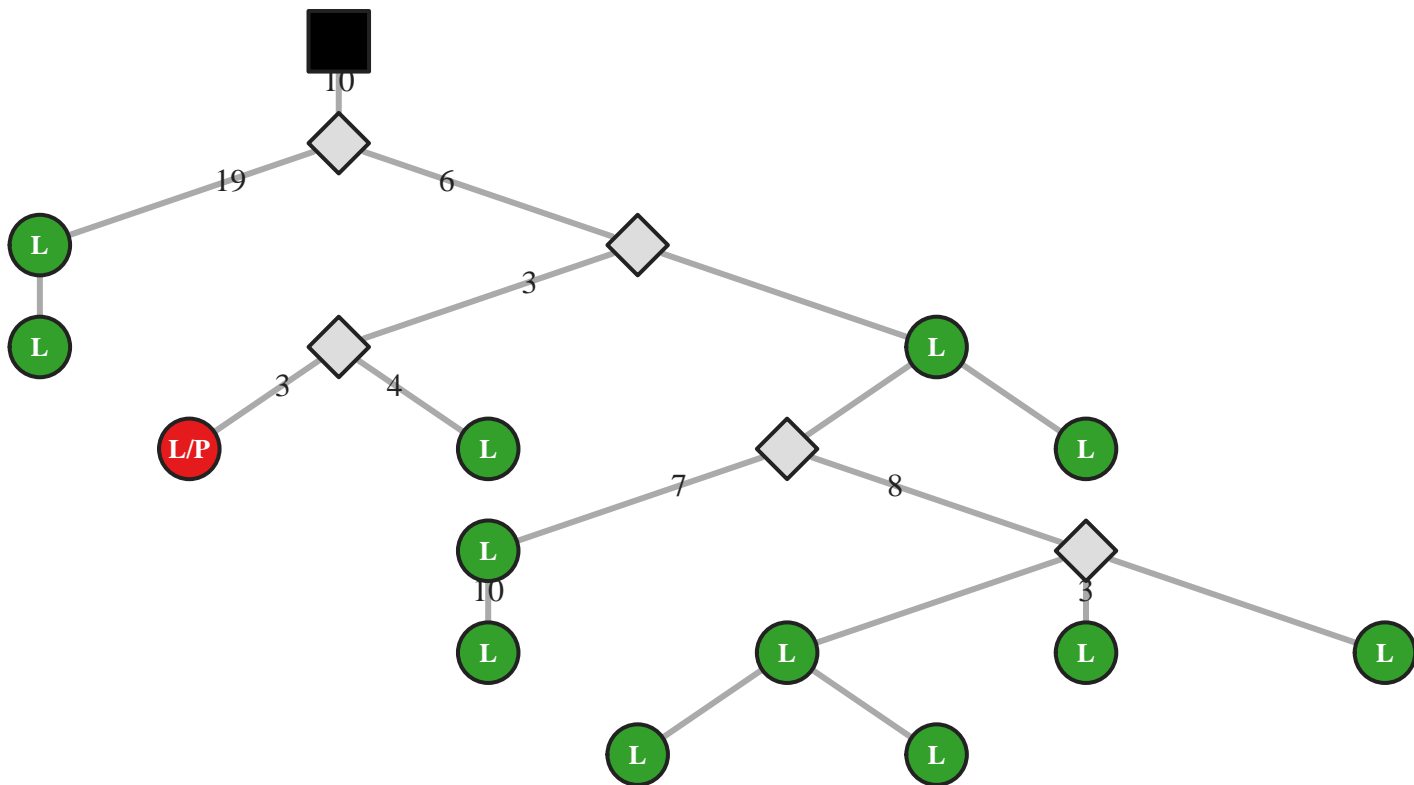

M5 IgA IGHV4-34/J3 45bp (12721)

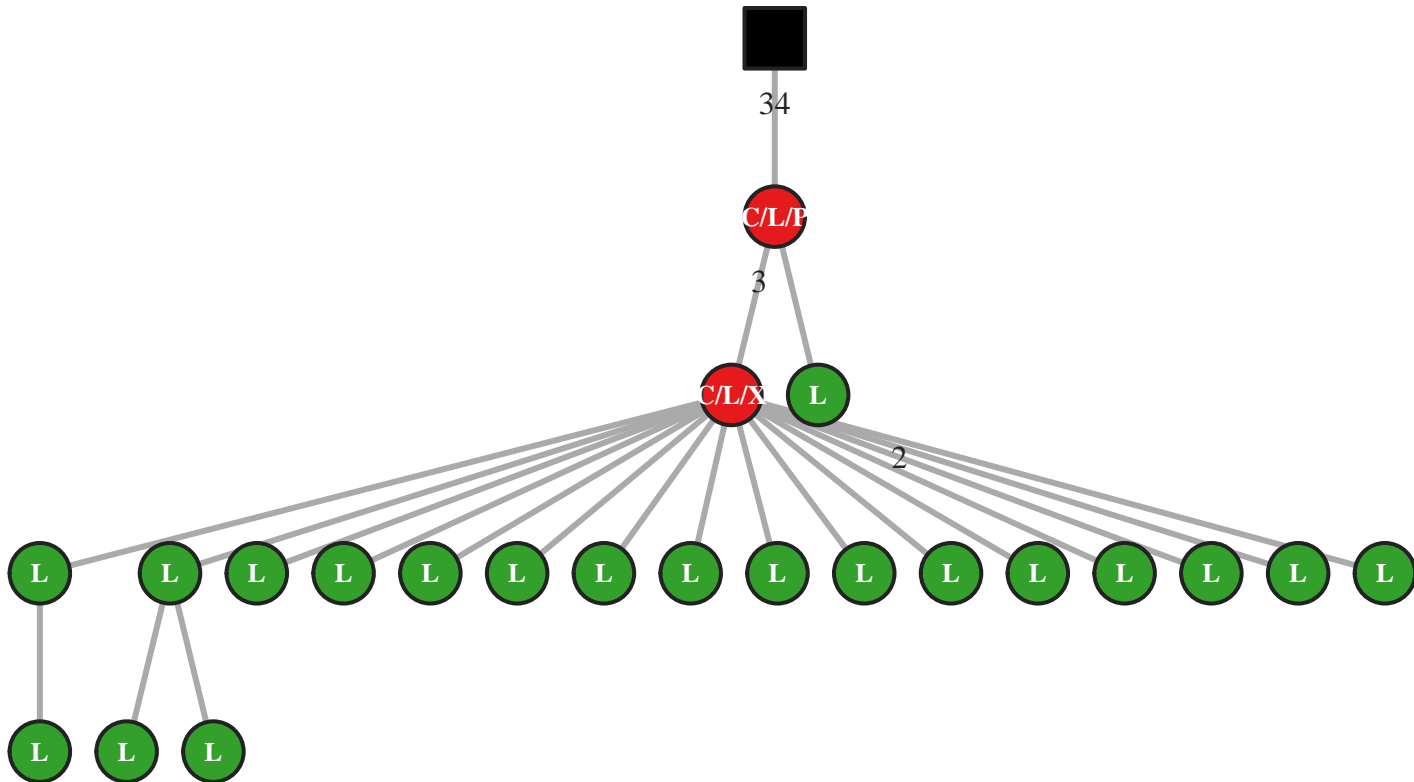

M5 IgG IGHV4-34/J3 60bp (52919)

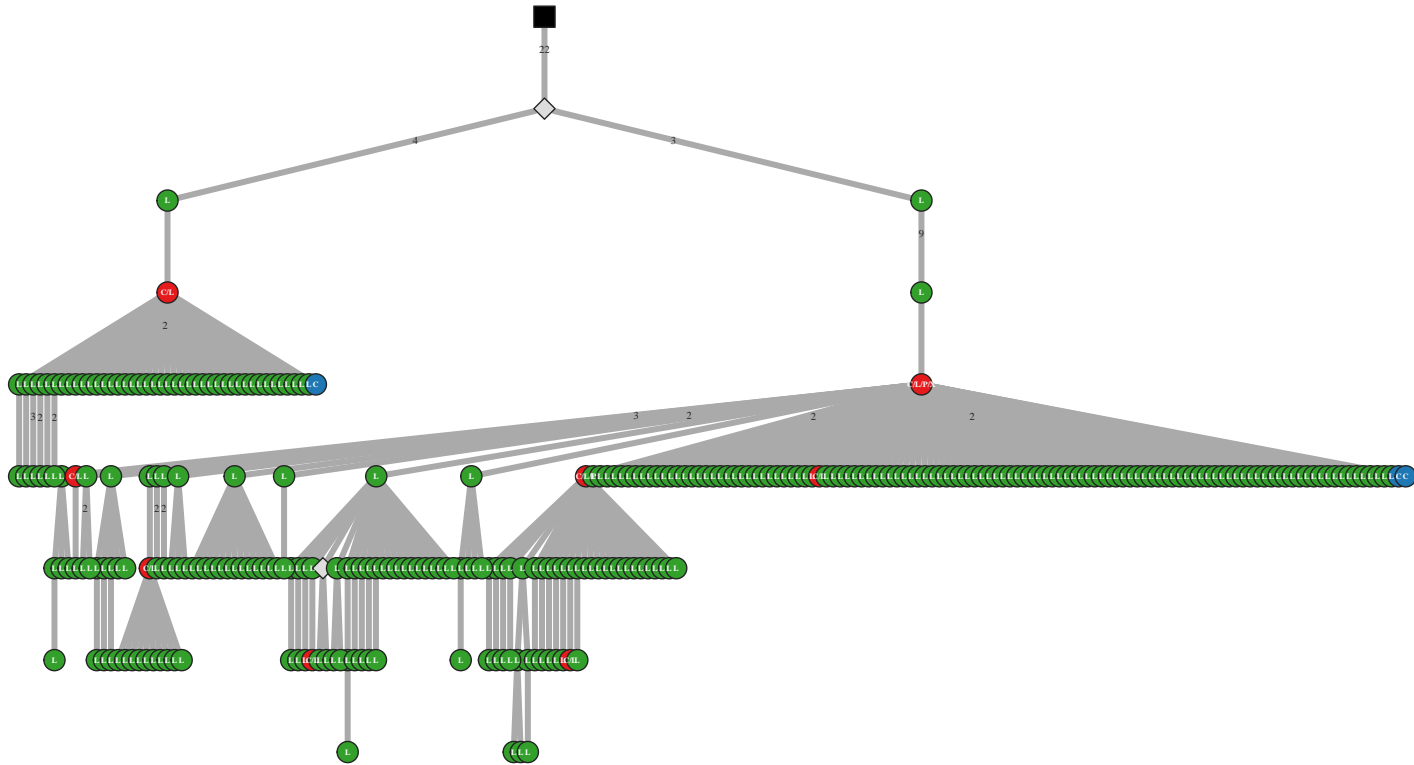

M5 IgG IGHV4-34/J4 51bp (36156)

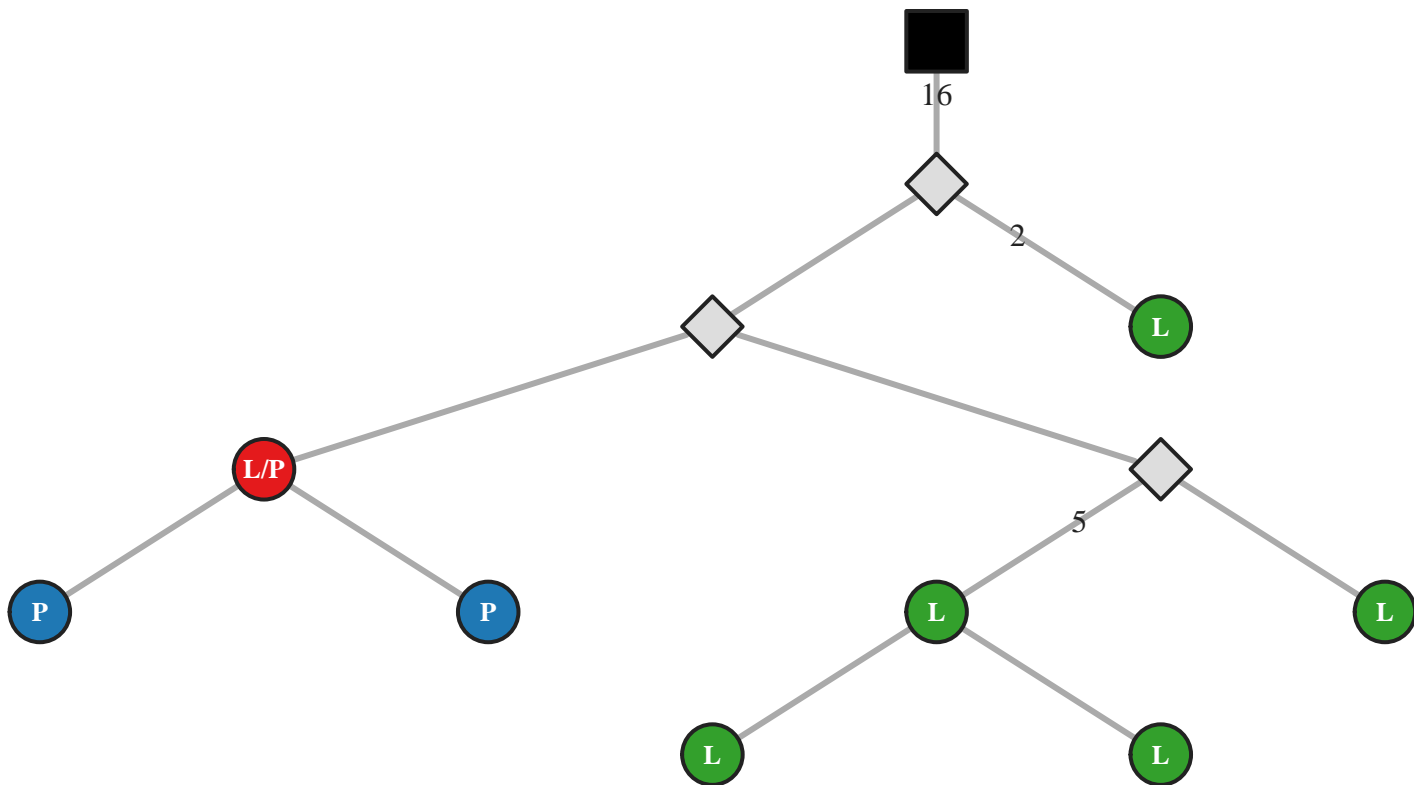

M5 IgG IGHV4-34/J4 51bp (36167)

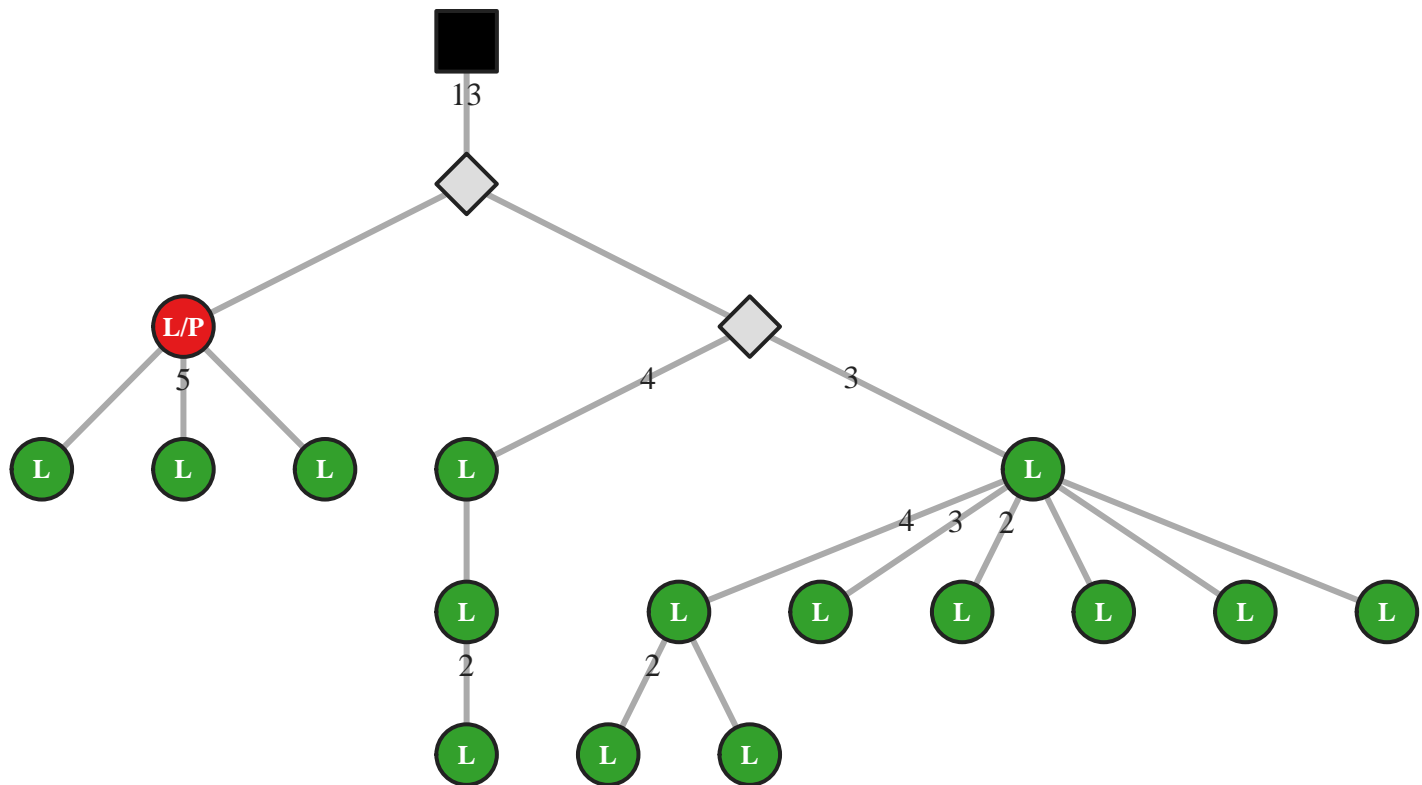

M5 IgG IGHV4-34/J5 51bp (46435)

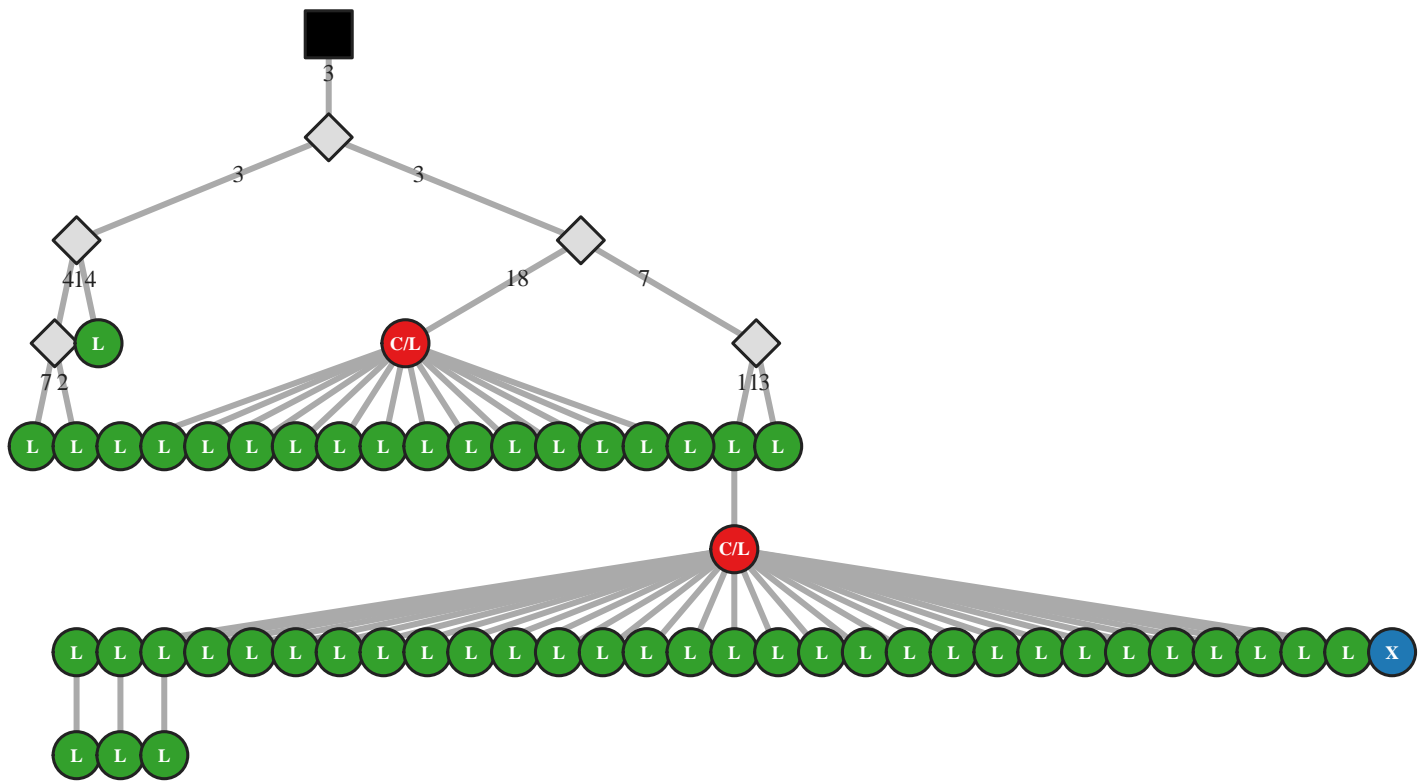

M5 IgG IGHV4-34/J5 51bp (46444)

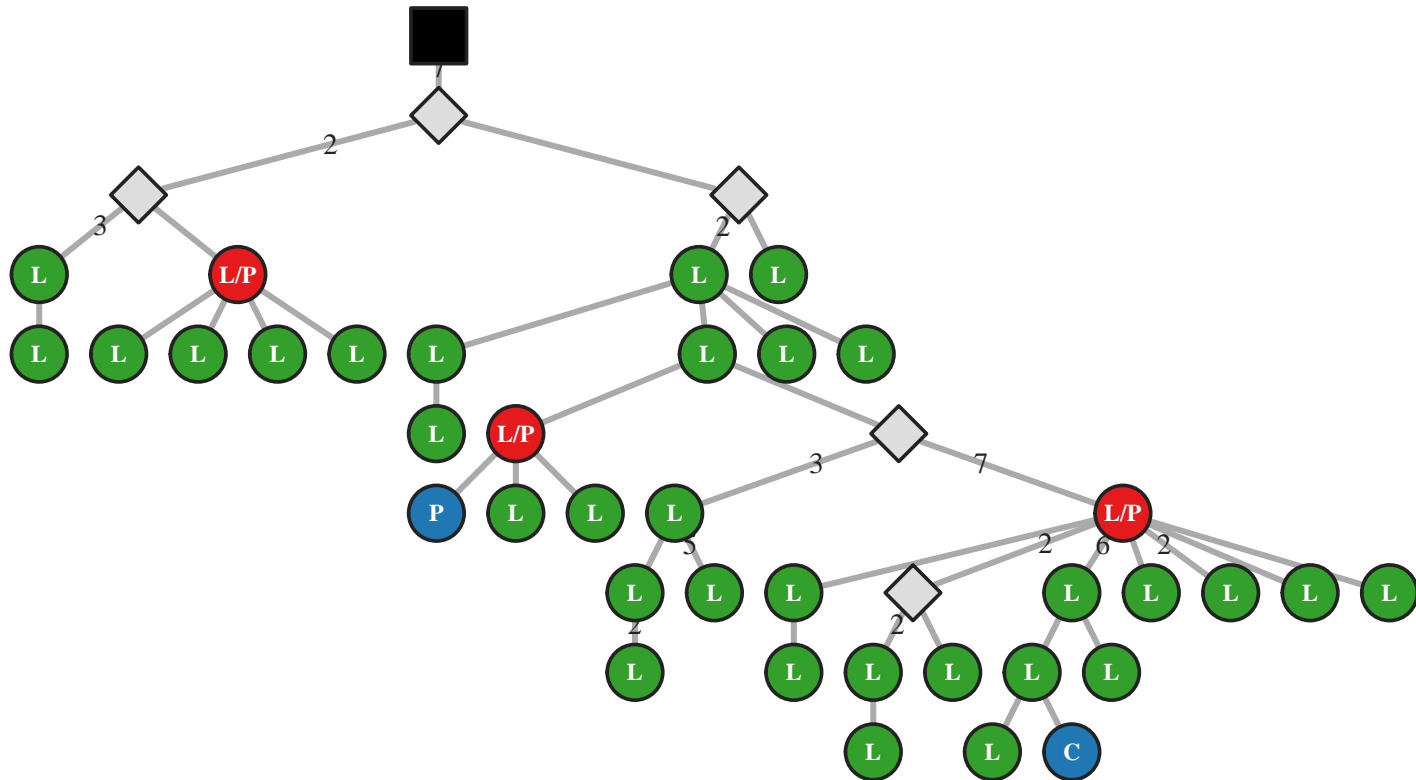

M5 IgG IGHV4-34/J6 54bp (46461)

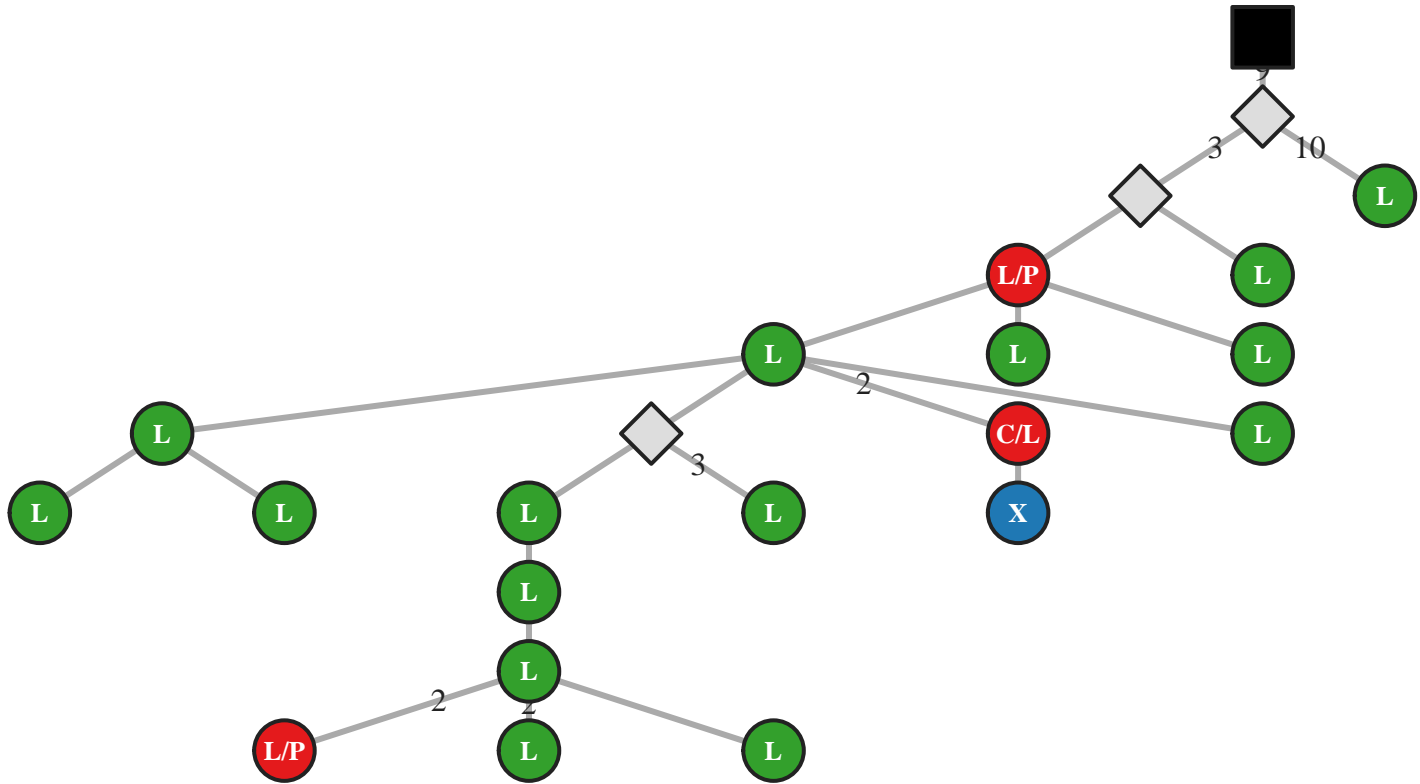

M5 IgG IGHV4-34/J6 78bp (19067)

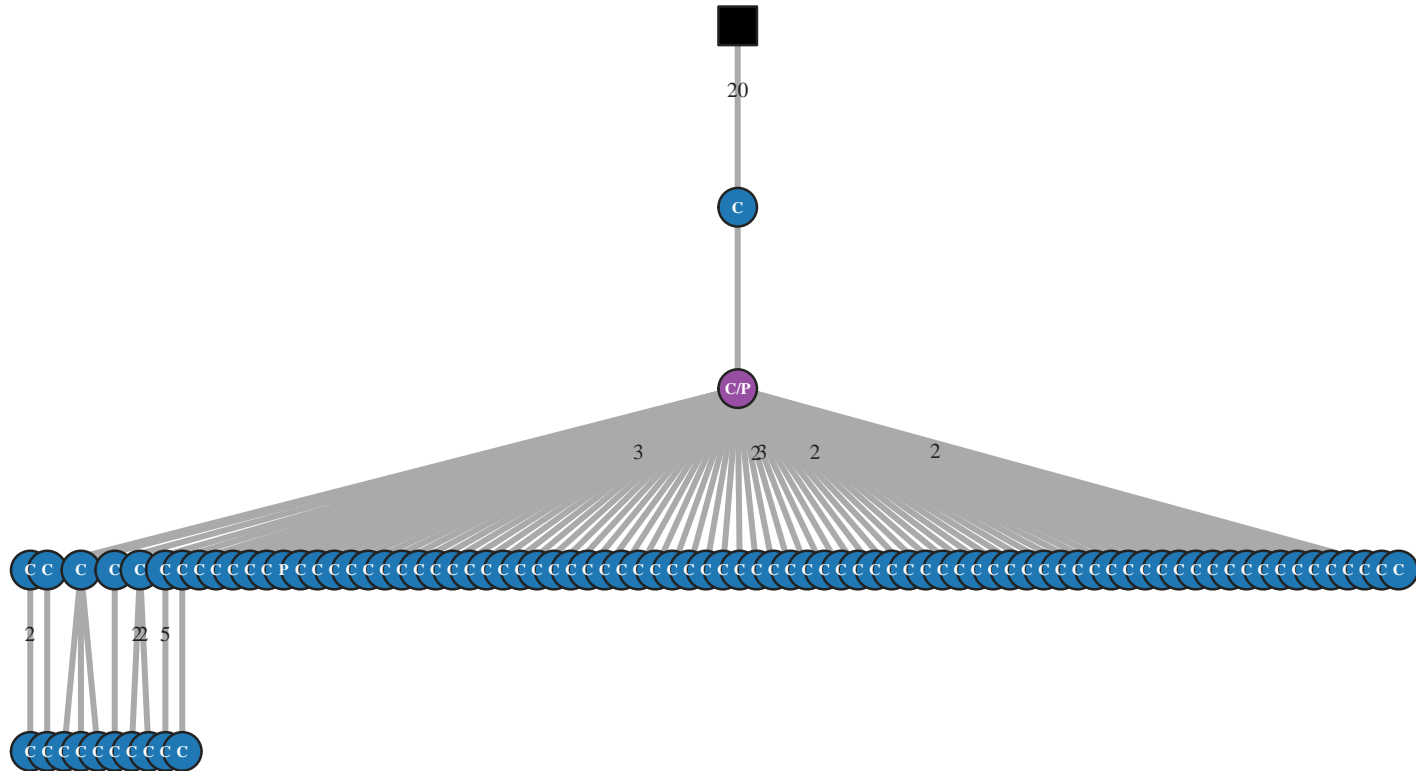

M5 IgG IGHV4-39/J2 60bp (52973)

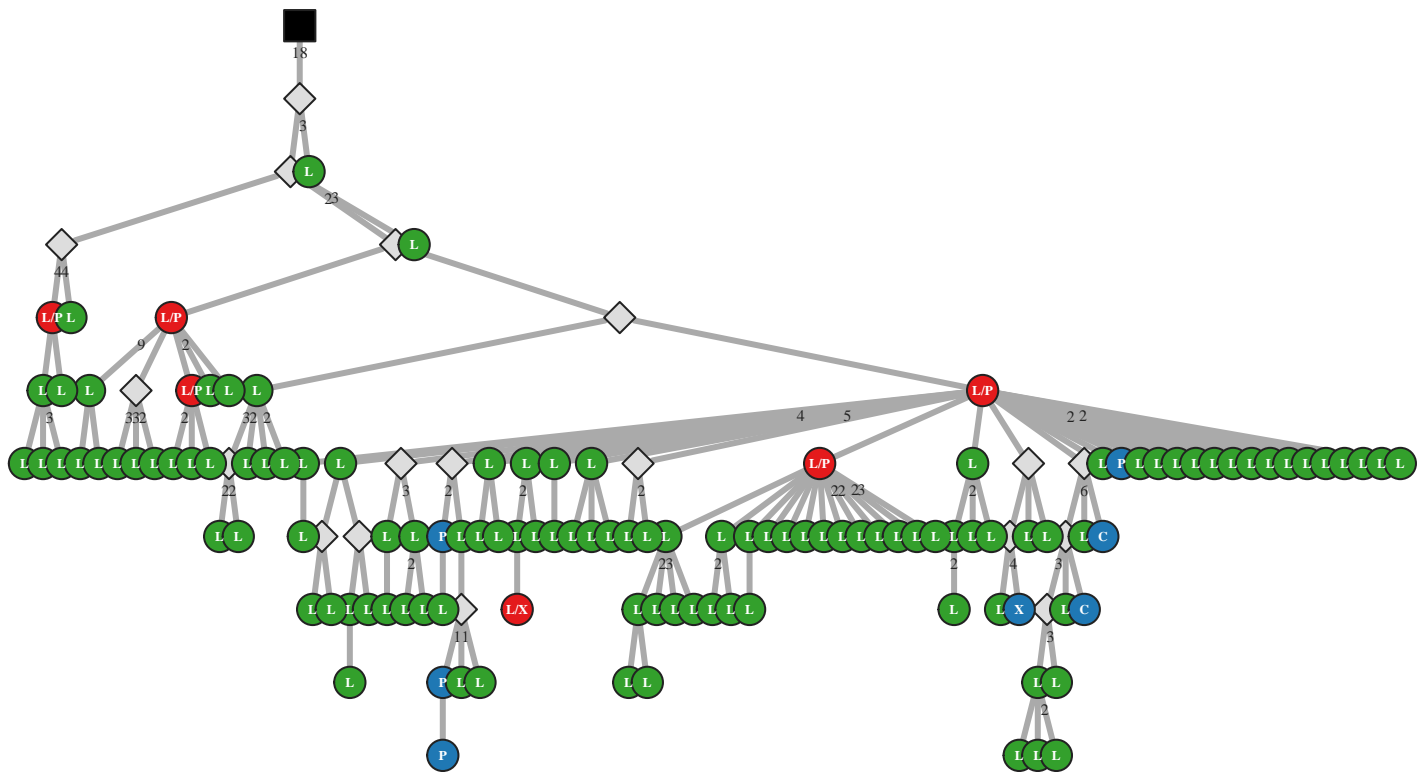

M5 IgA IGHV4-39/J3 48bp (30813)

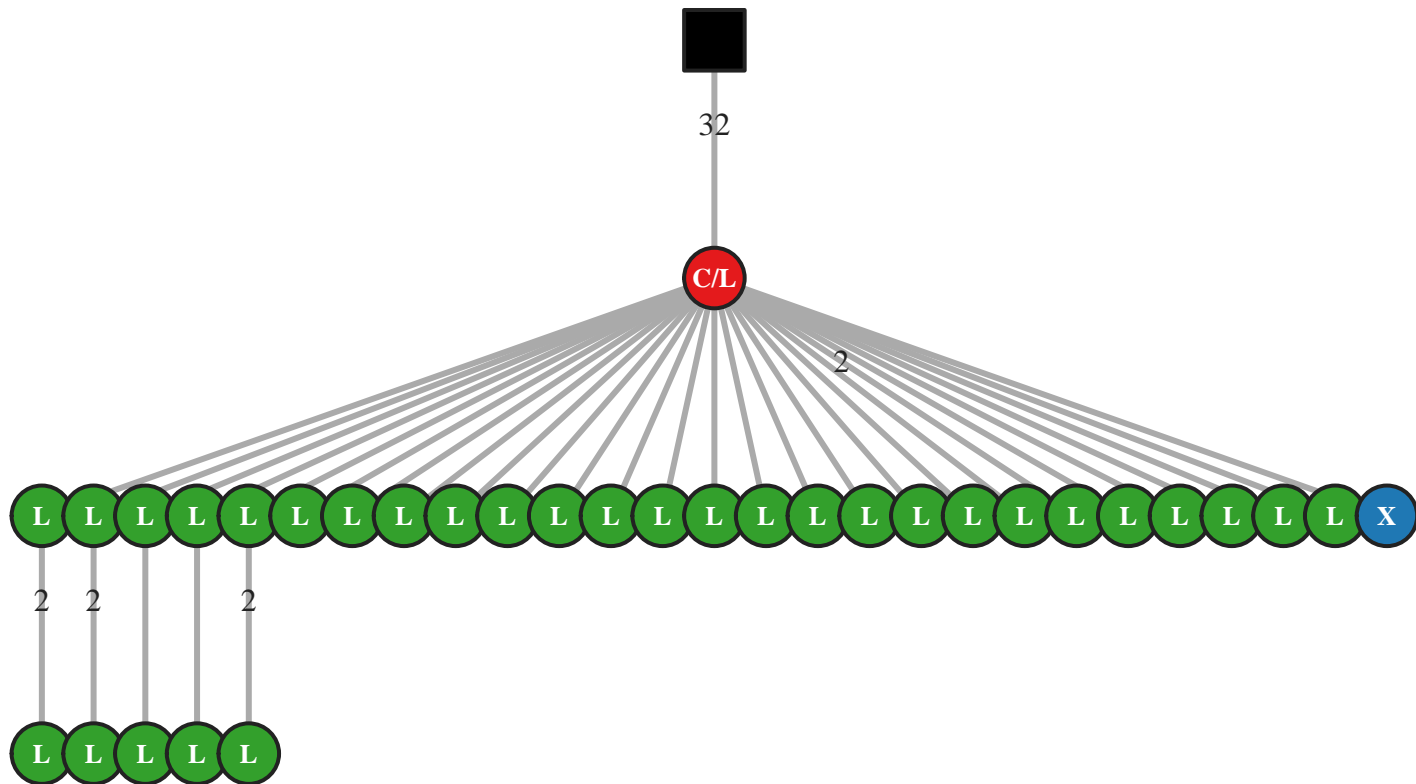

M5 IgG IGHV4-39/J3 57bp (19086)

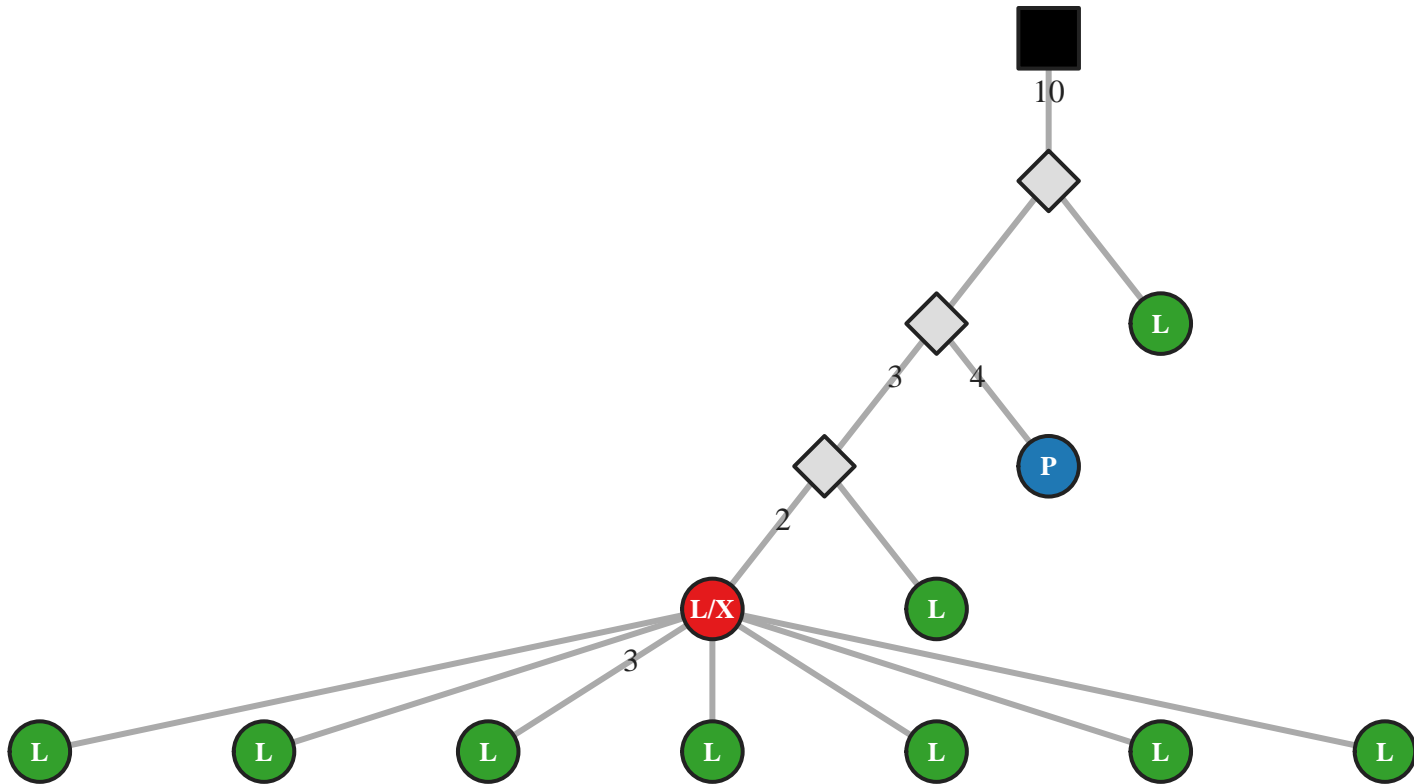

M5 IgG IGHV4-39/J4 39bp (52993)

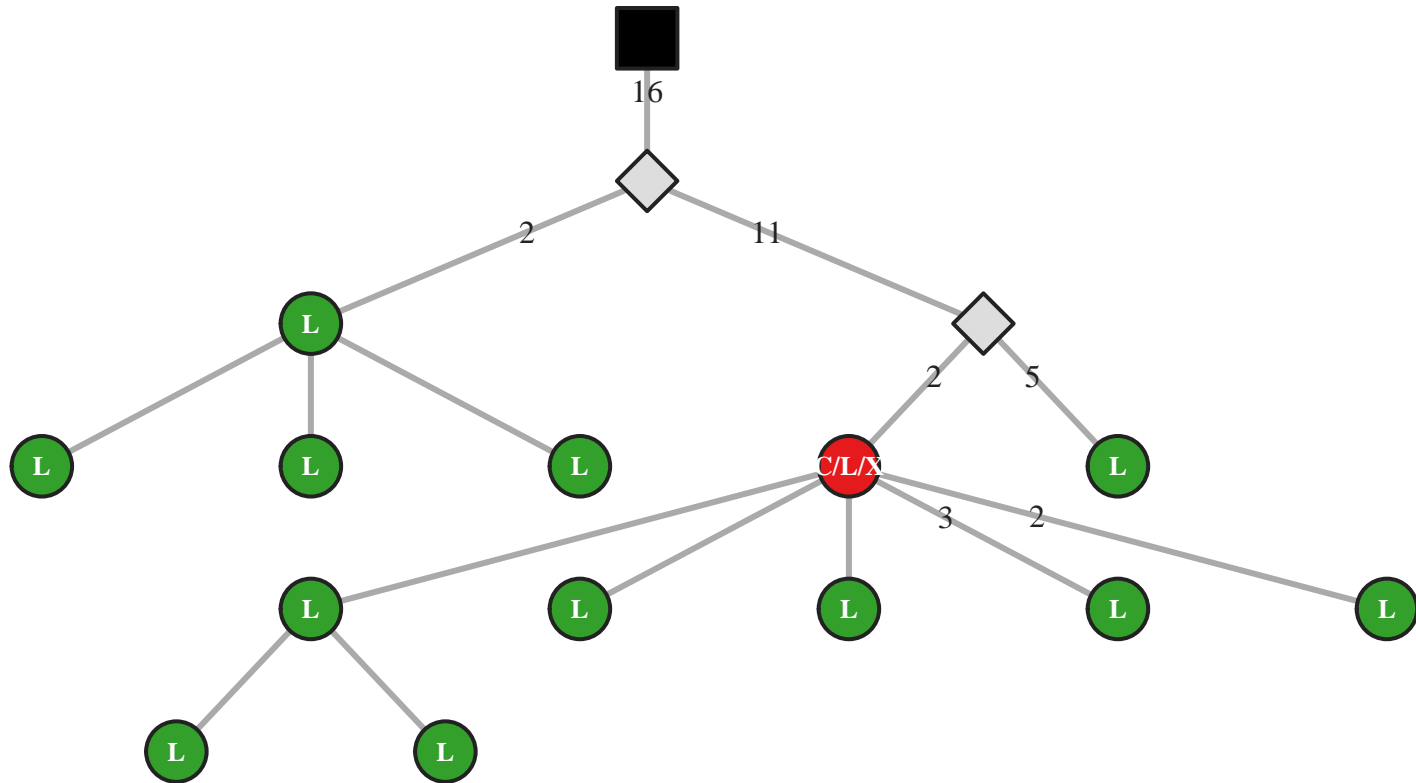

M5 IgG IGHV4-39/J4 39bp (53004)

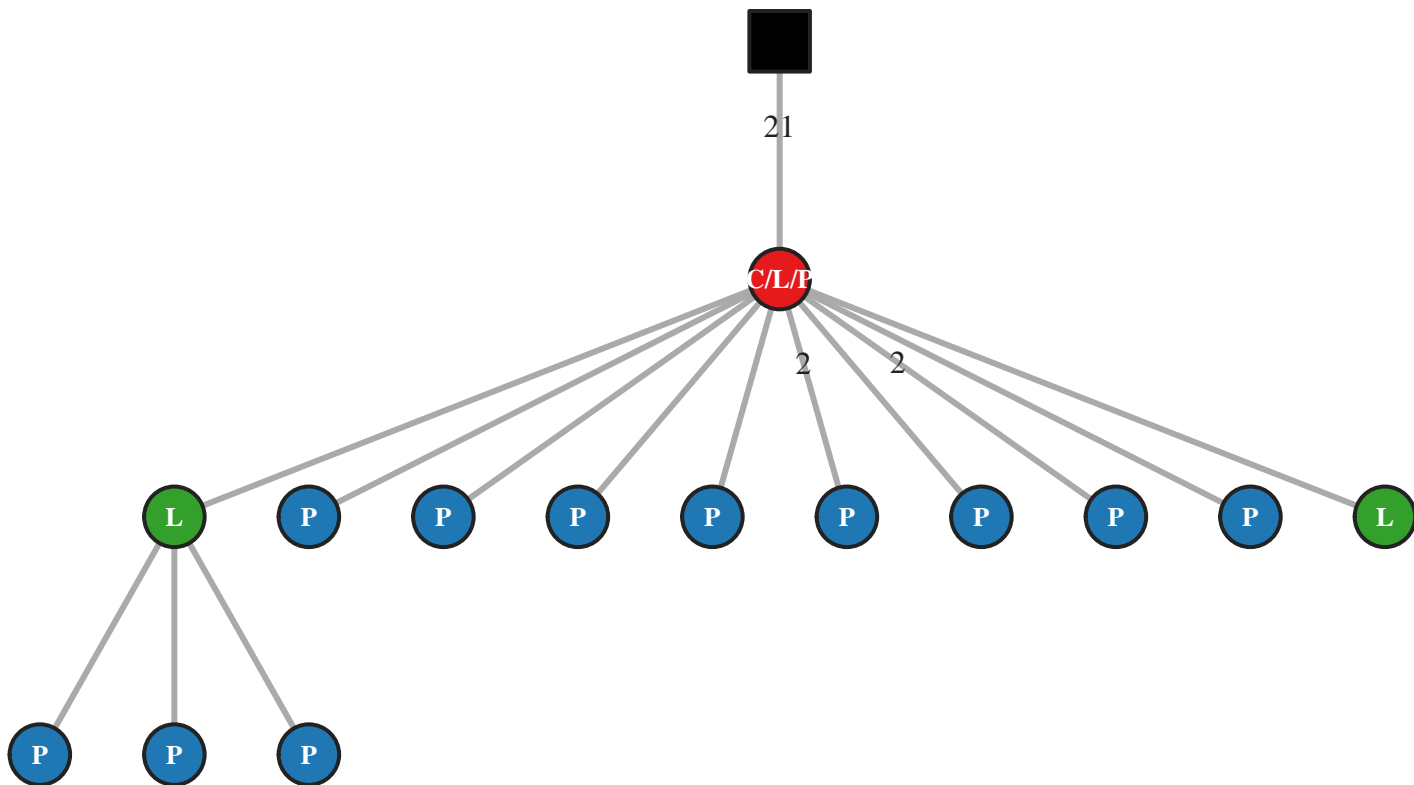

M5 IgG IGHV4-39/J4 39bp (53006)

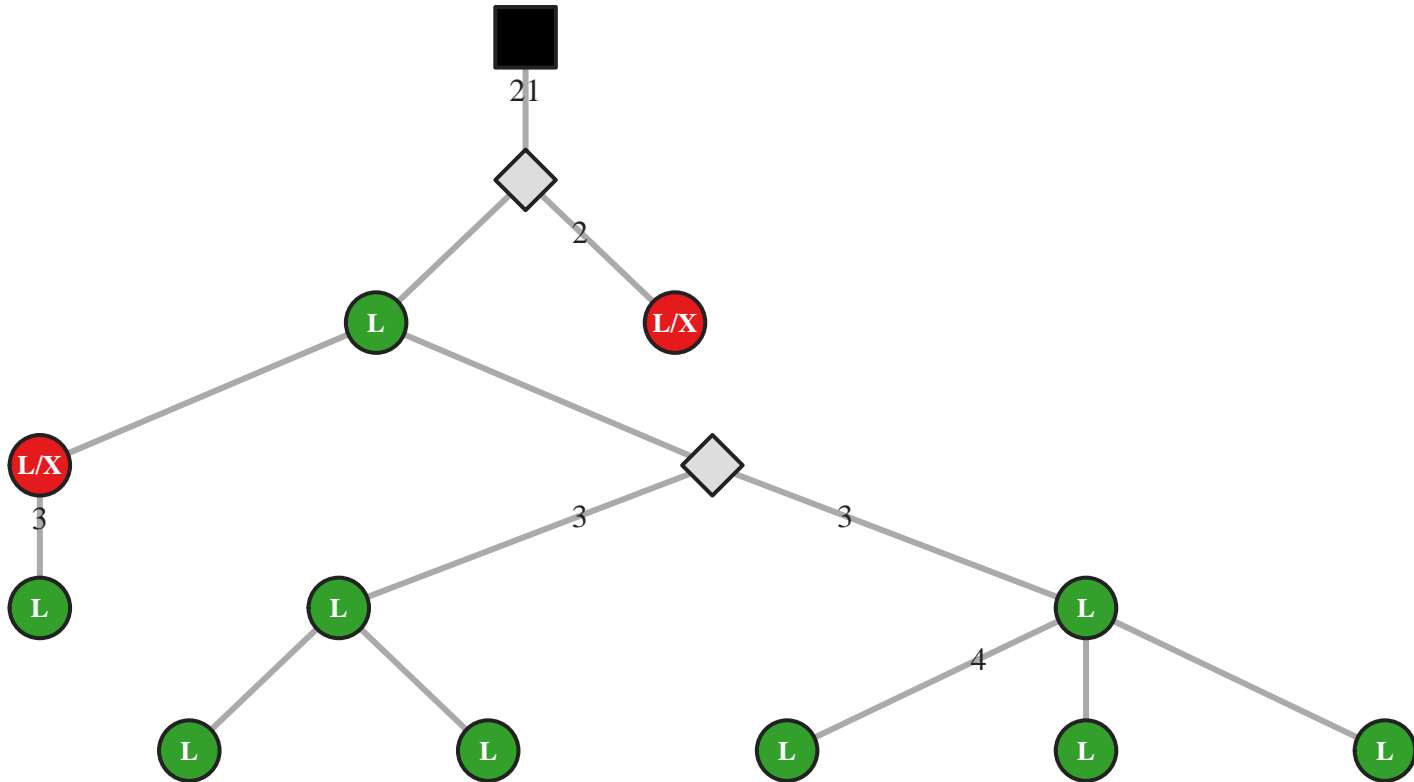

M5 IgA IGHV4-39/J4 42bp (12741)

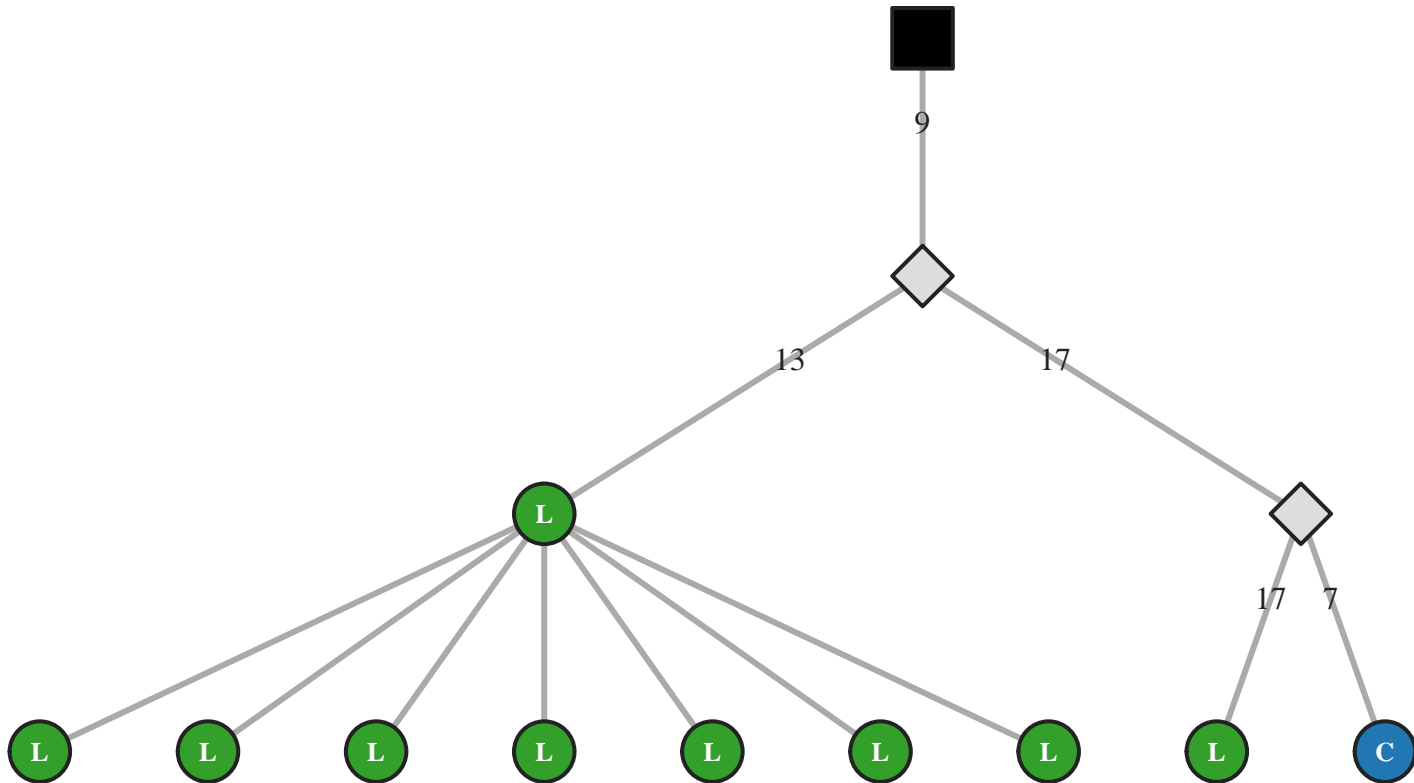

M5 IgG IGHV4-39/J4 42bp (36213)

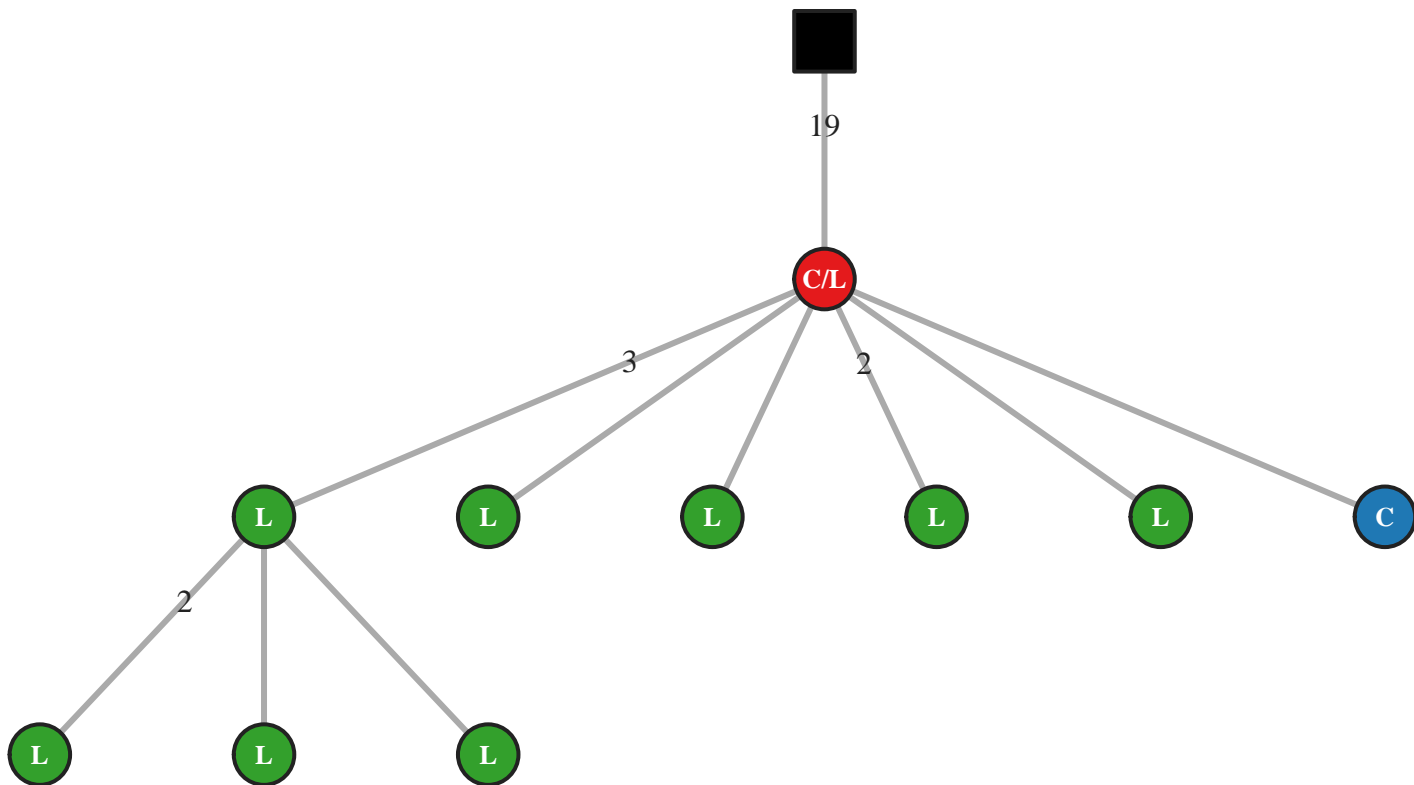

M5 IgG IGHV4-39/J4 42bp (36217)

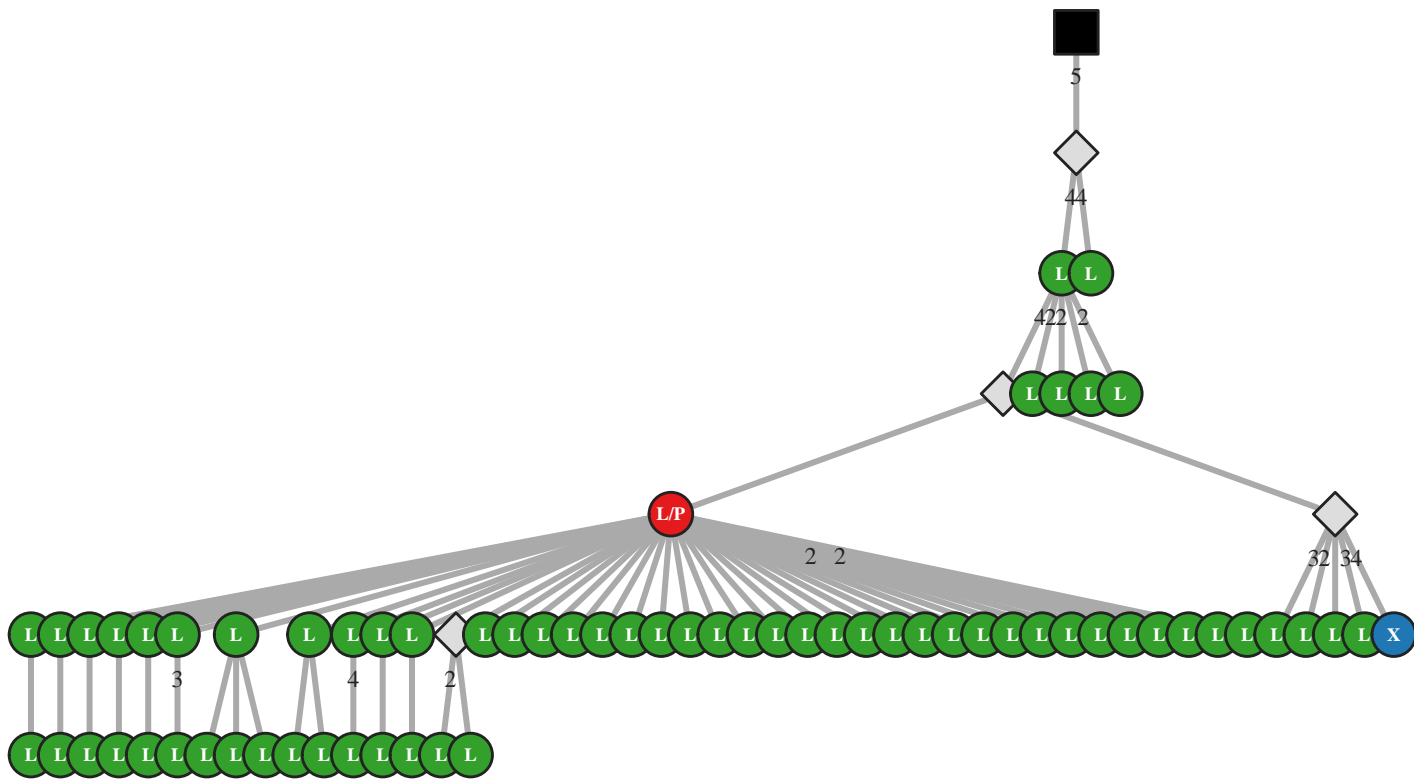

M5 IgG IGHV4-39/J4 42bp (36219)

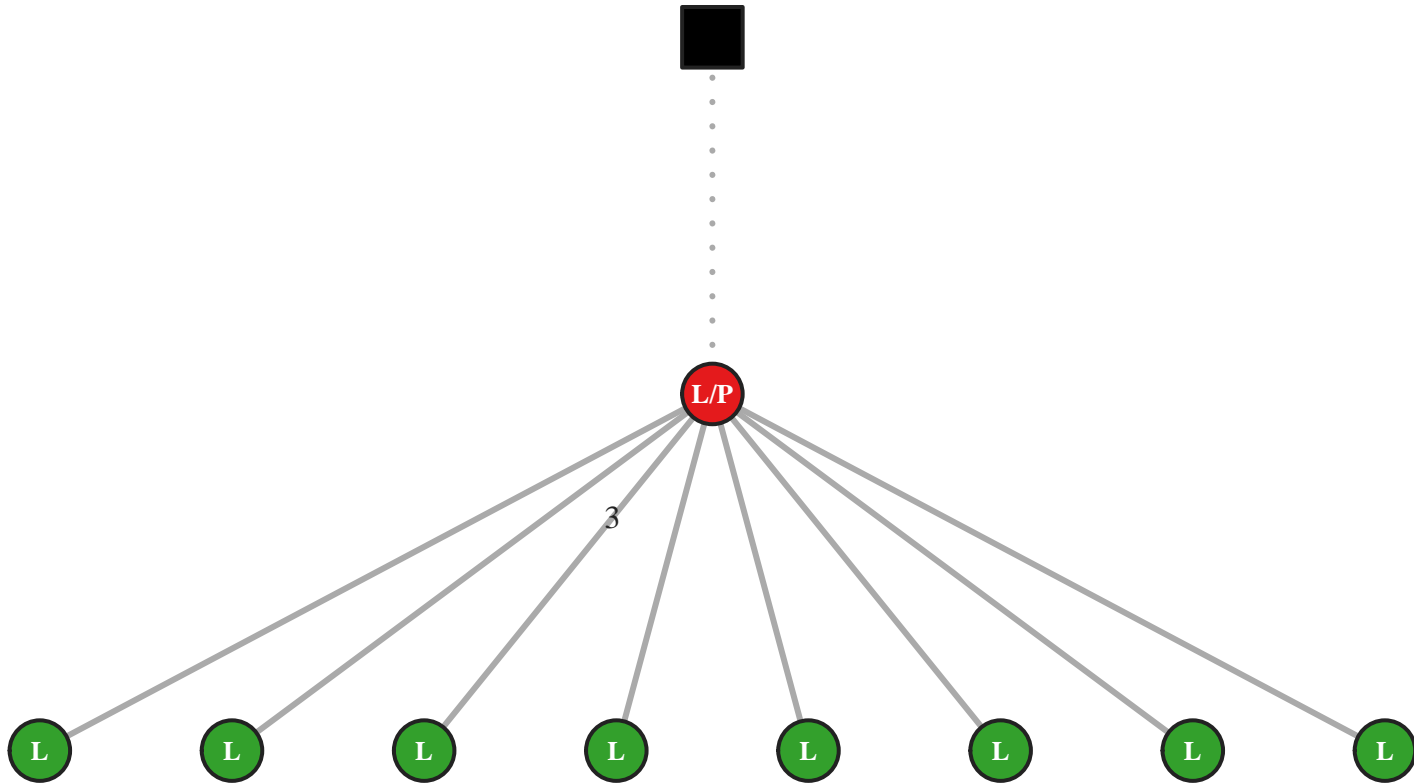

M5 IgG IGHV4-39/J4 45bp (46528)

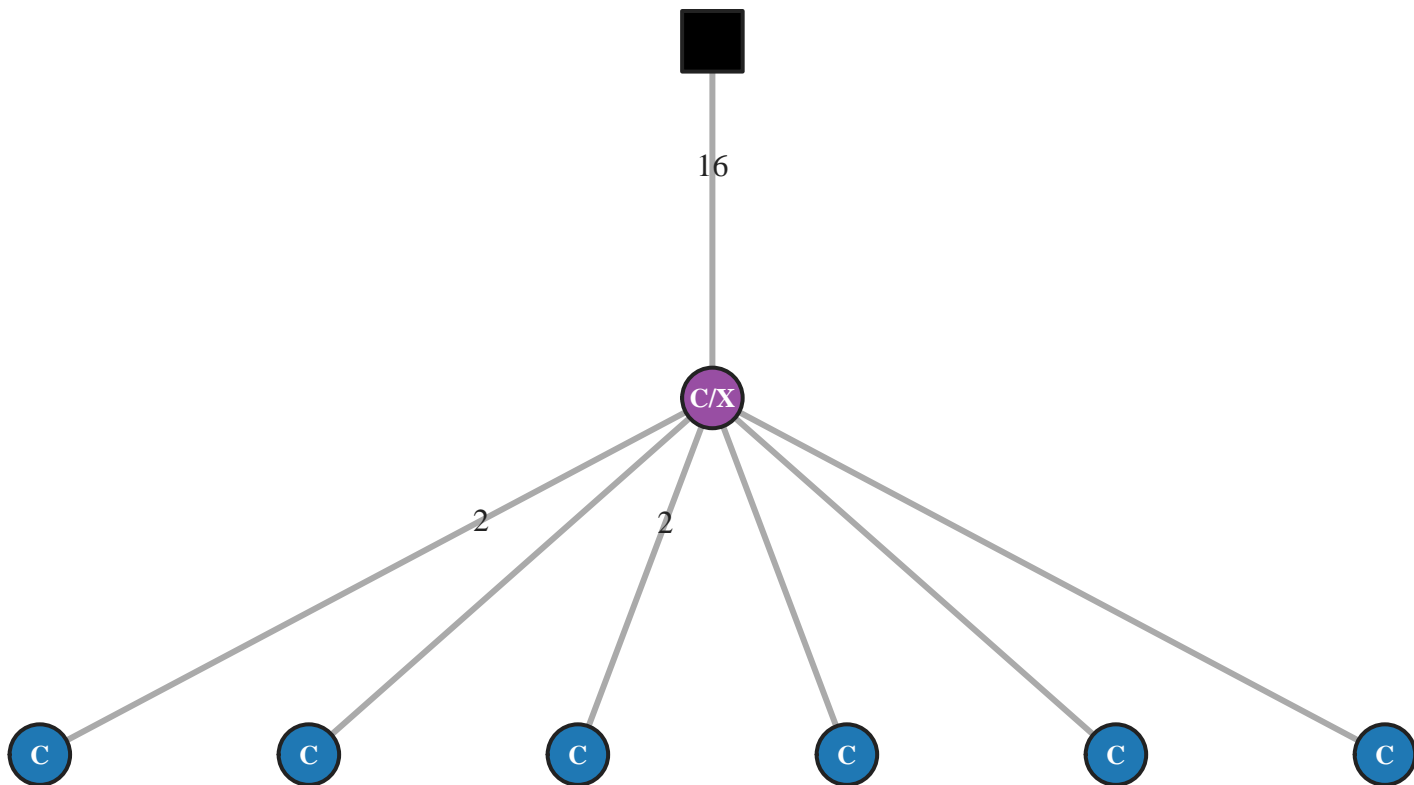

M5 IgG IGHV4-39/J4 45bp (46561)

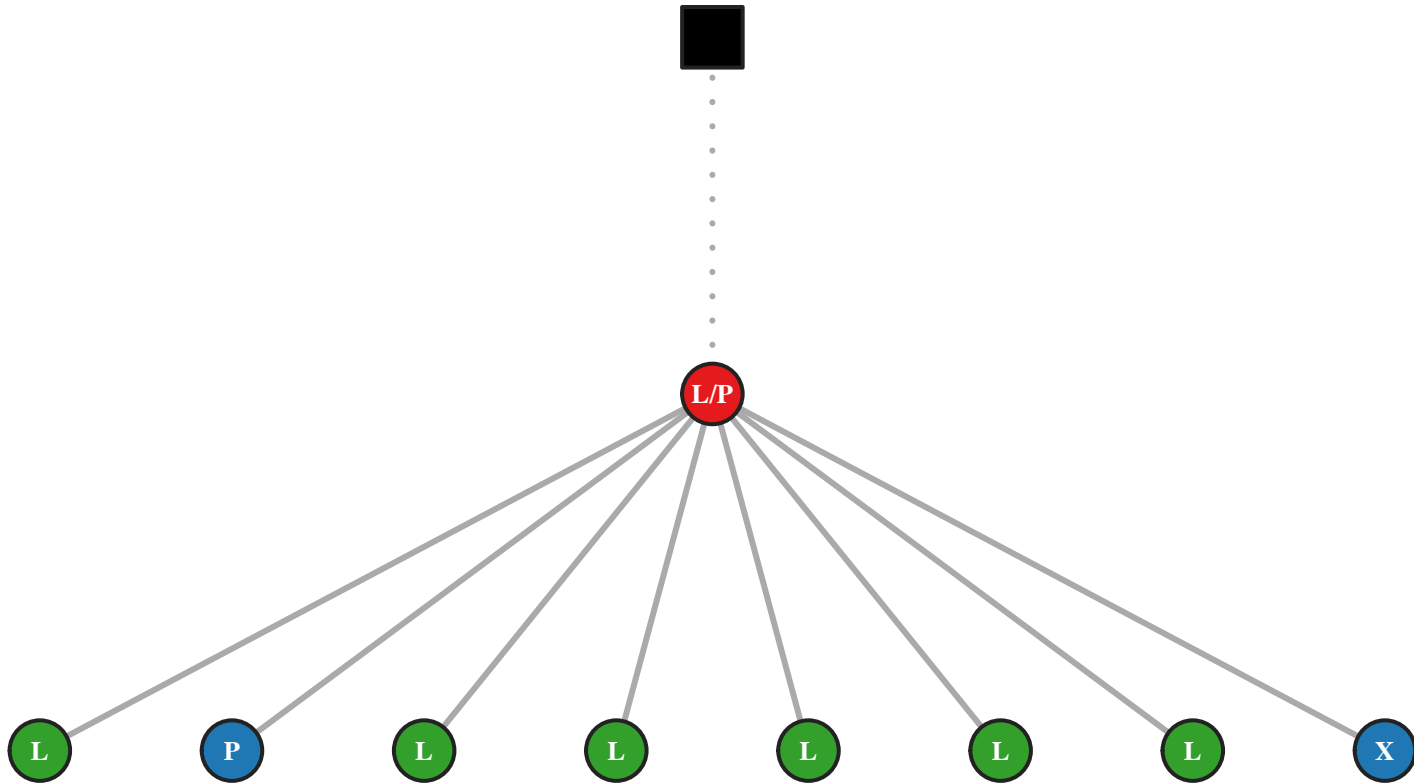

M5 IgG IGHV4-39/J4 48bp (53020)

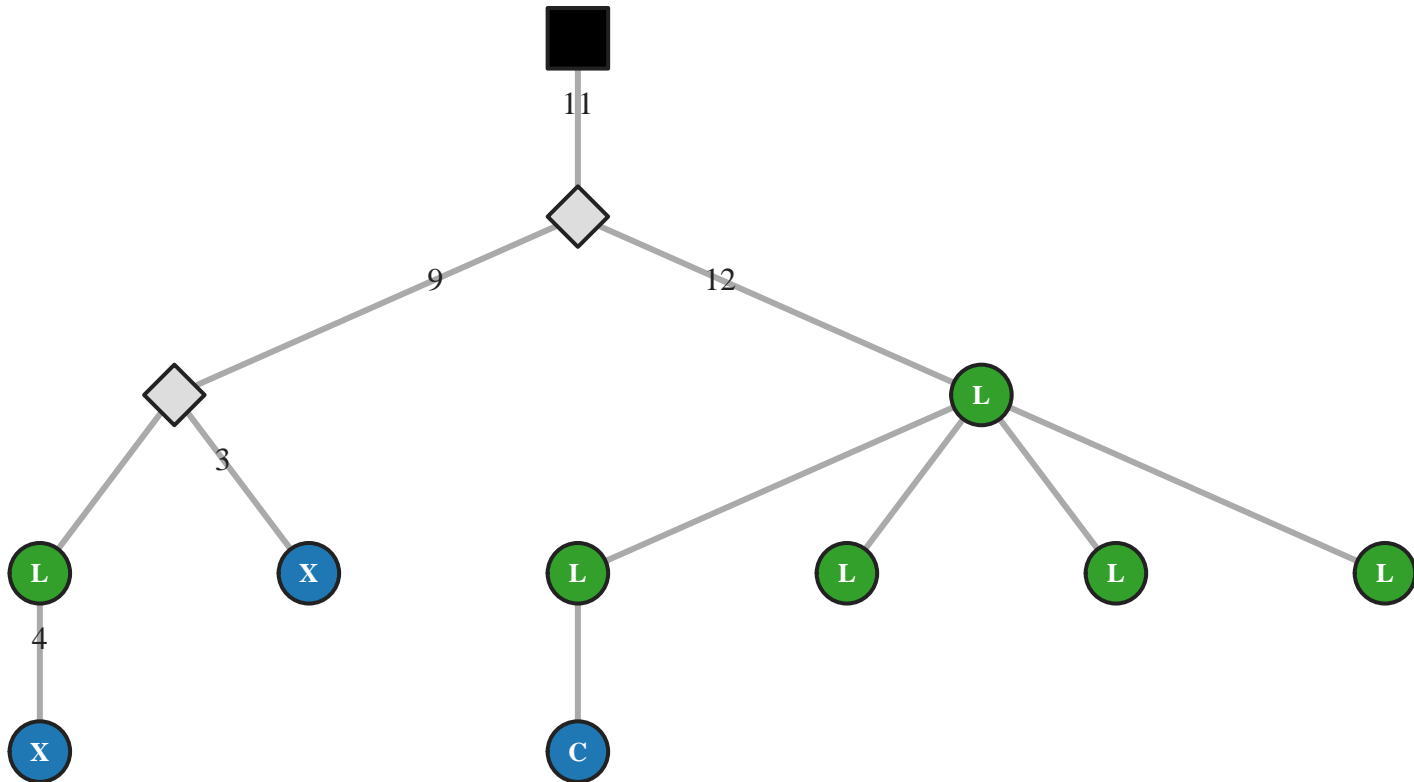

M5 IgG IGHV4-39/J4 48bp (53022)

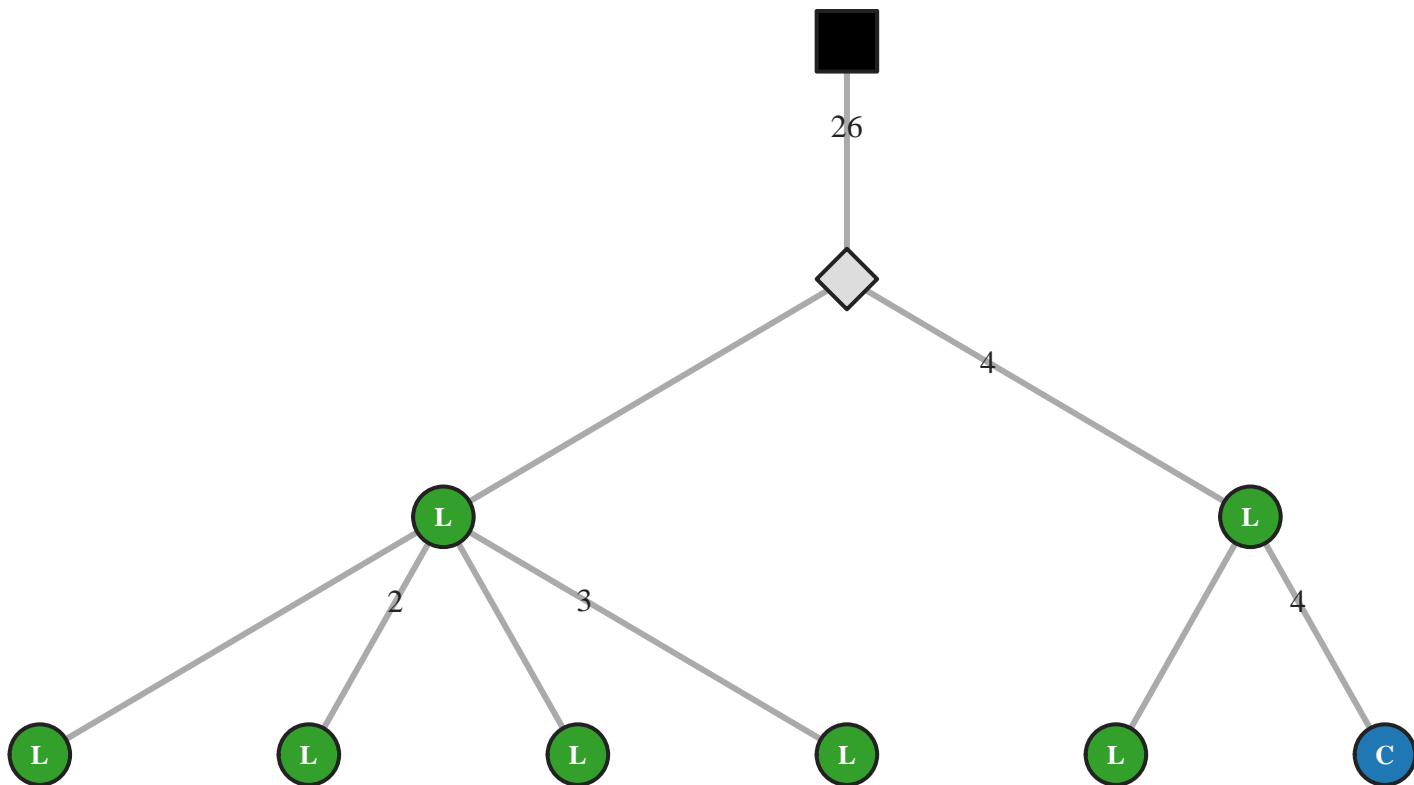

M5 IgG IGHV4-39/J4 48bp (53045)

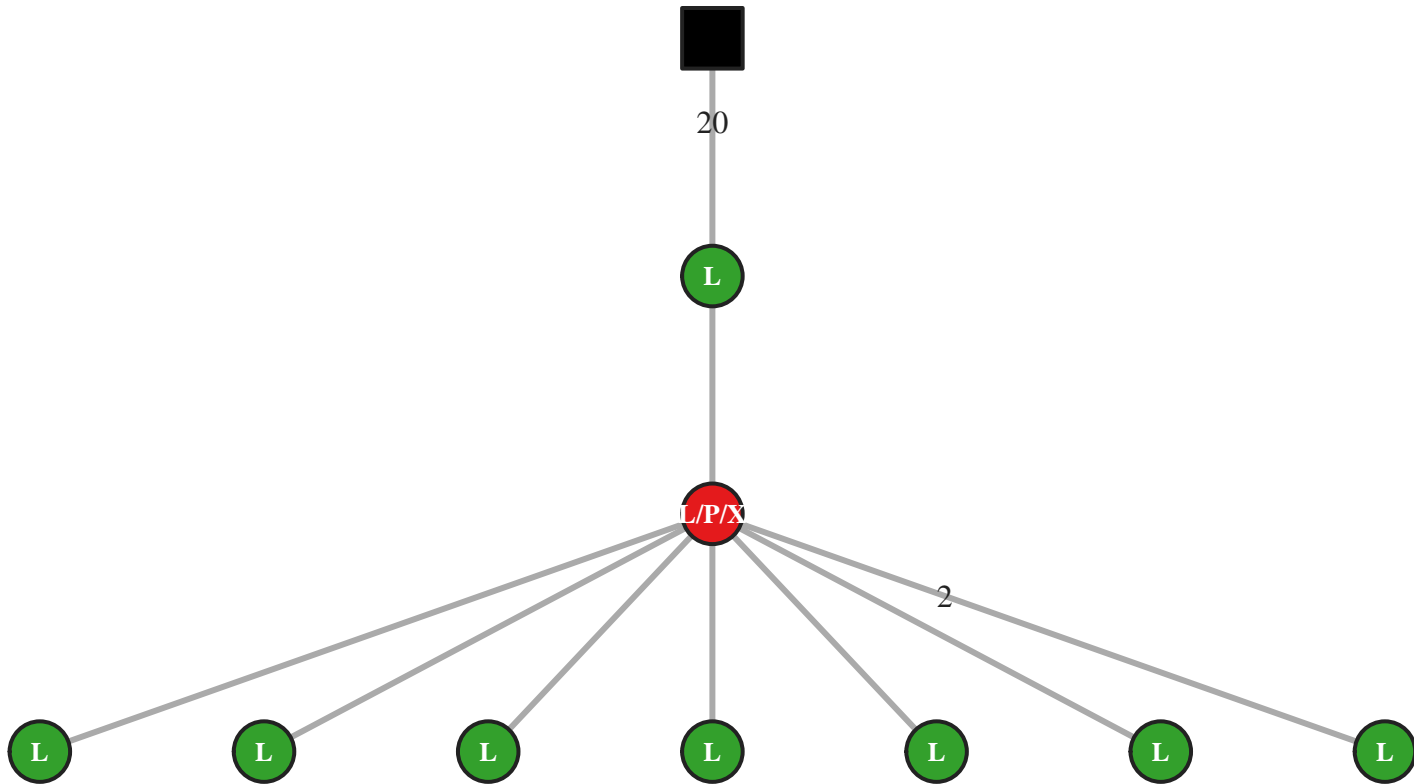

M5 IgG IGHV4-39/J4 48bp (53055)

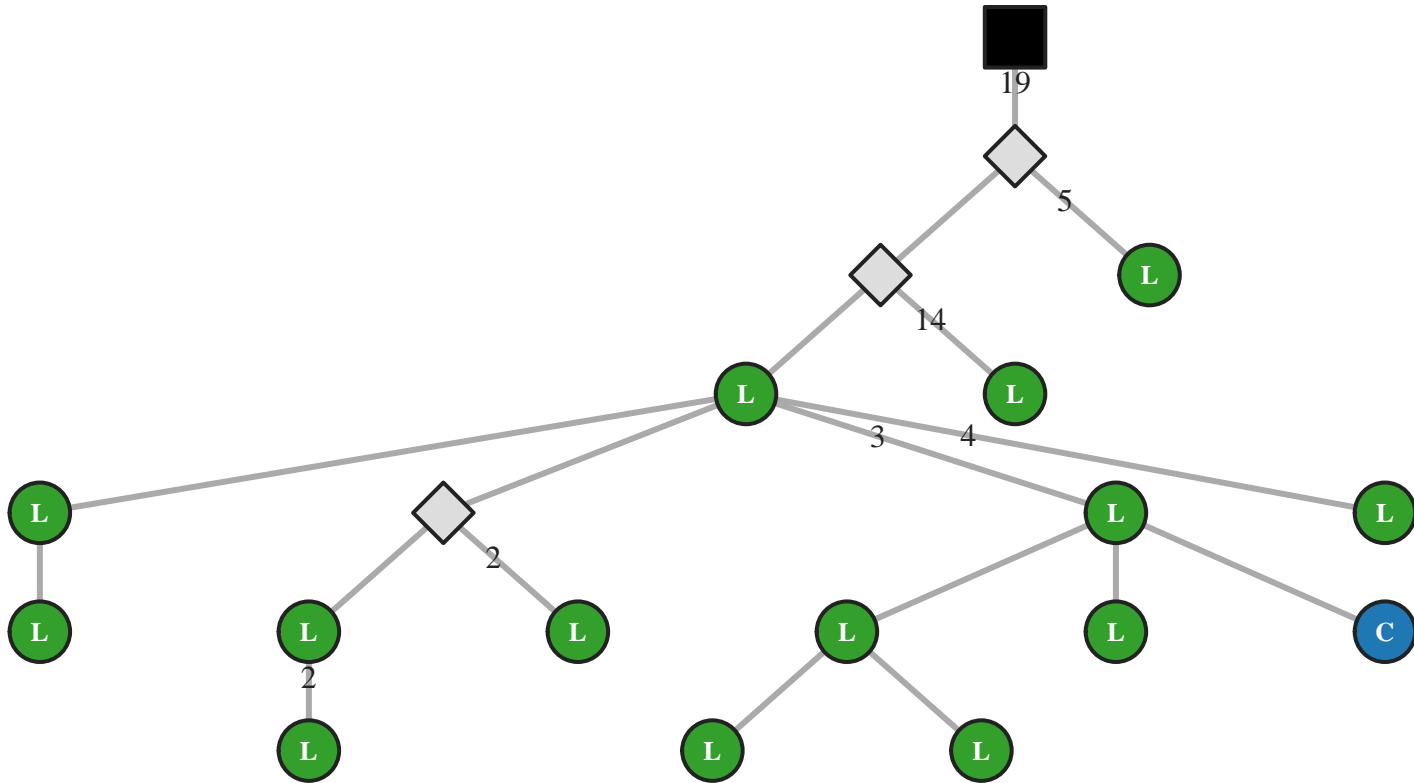

M5 IgG IGHV4-39/J4 51bp (36296)

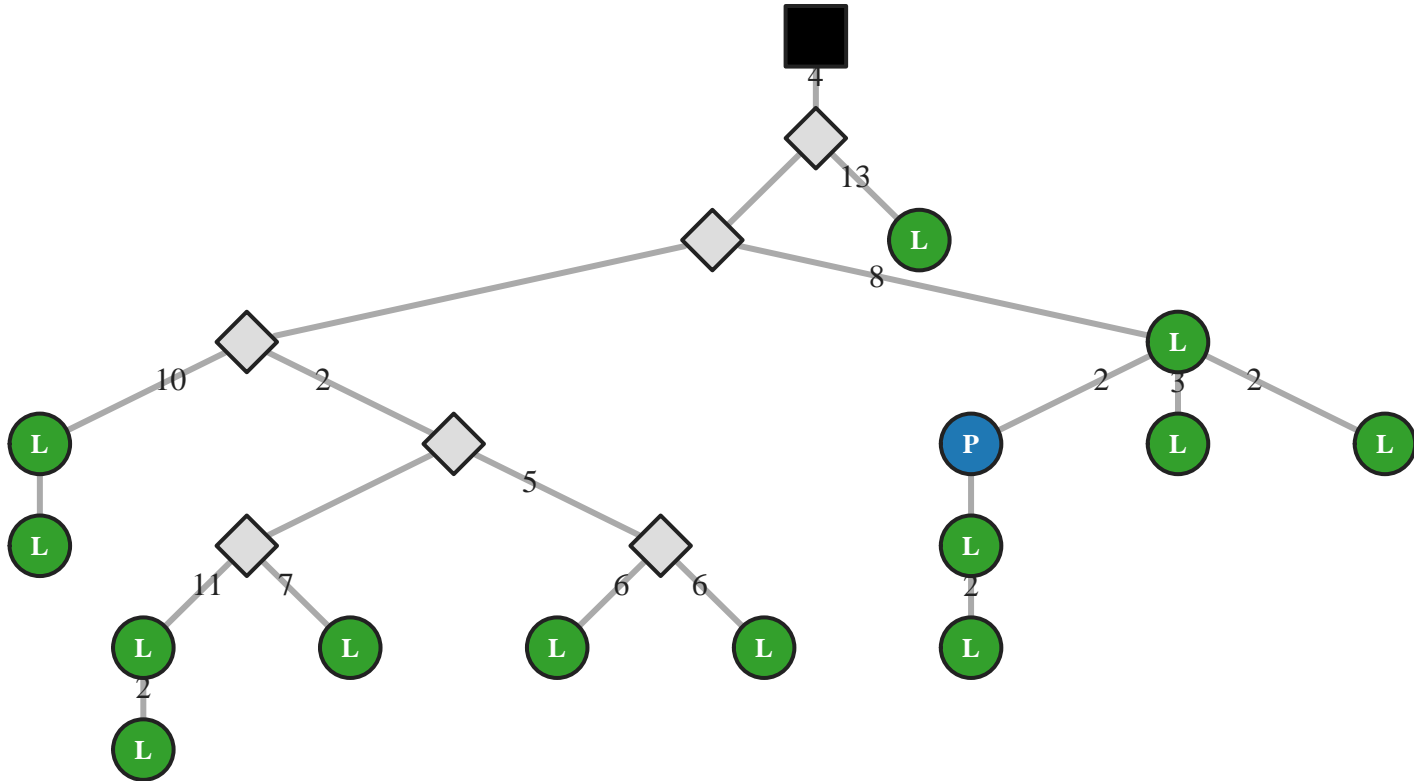

M5 IgG IGHV4-39/J4 57bp (46584)

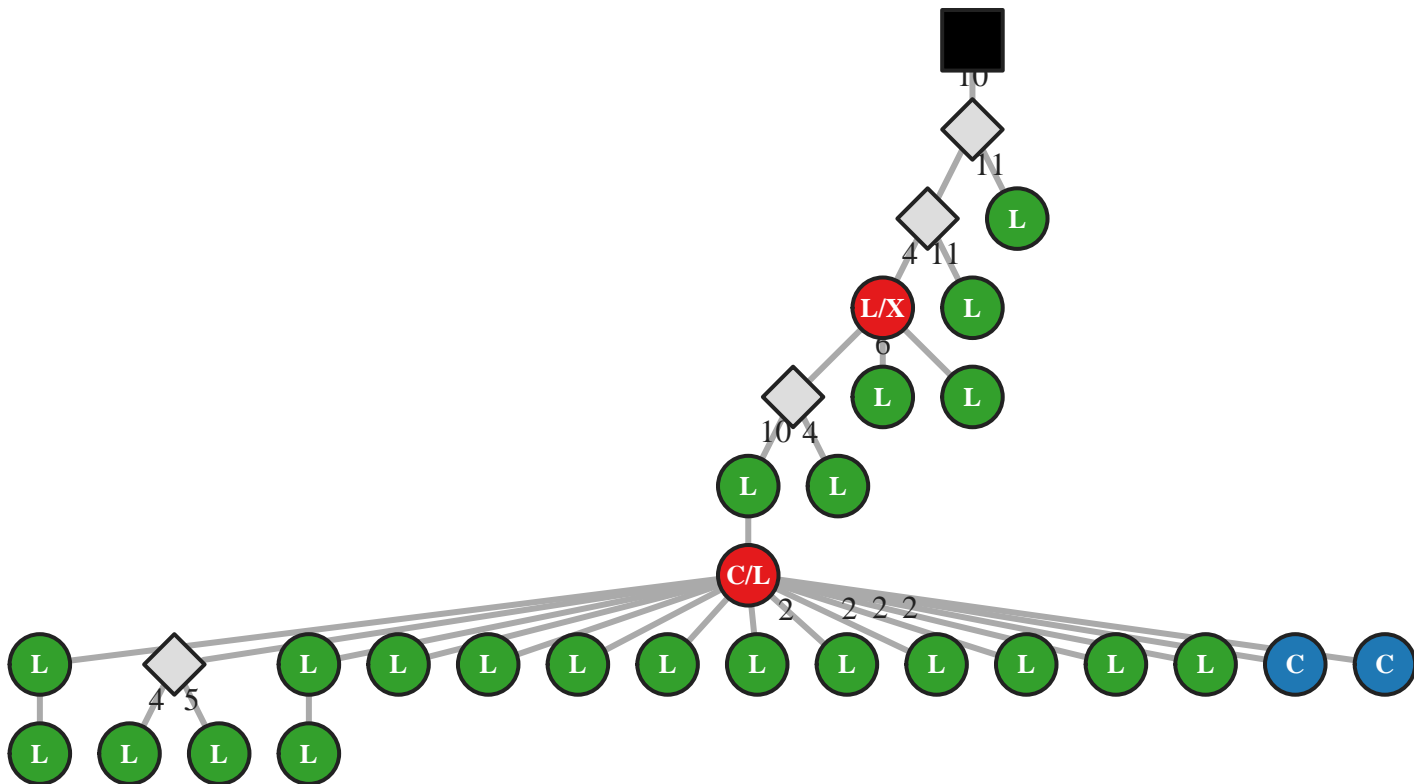

M5 IgG IGHV4-39/J4 66bp (36302)

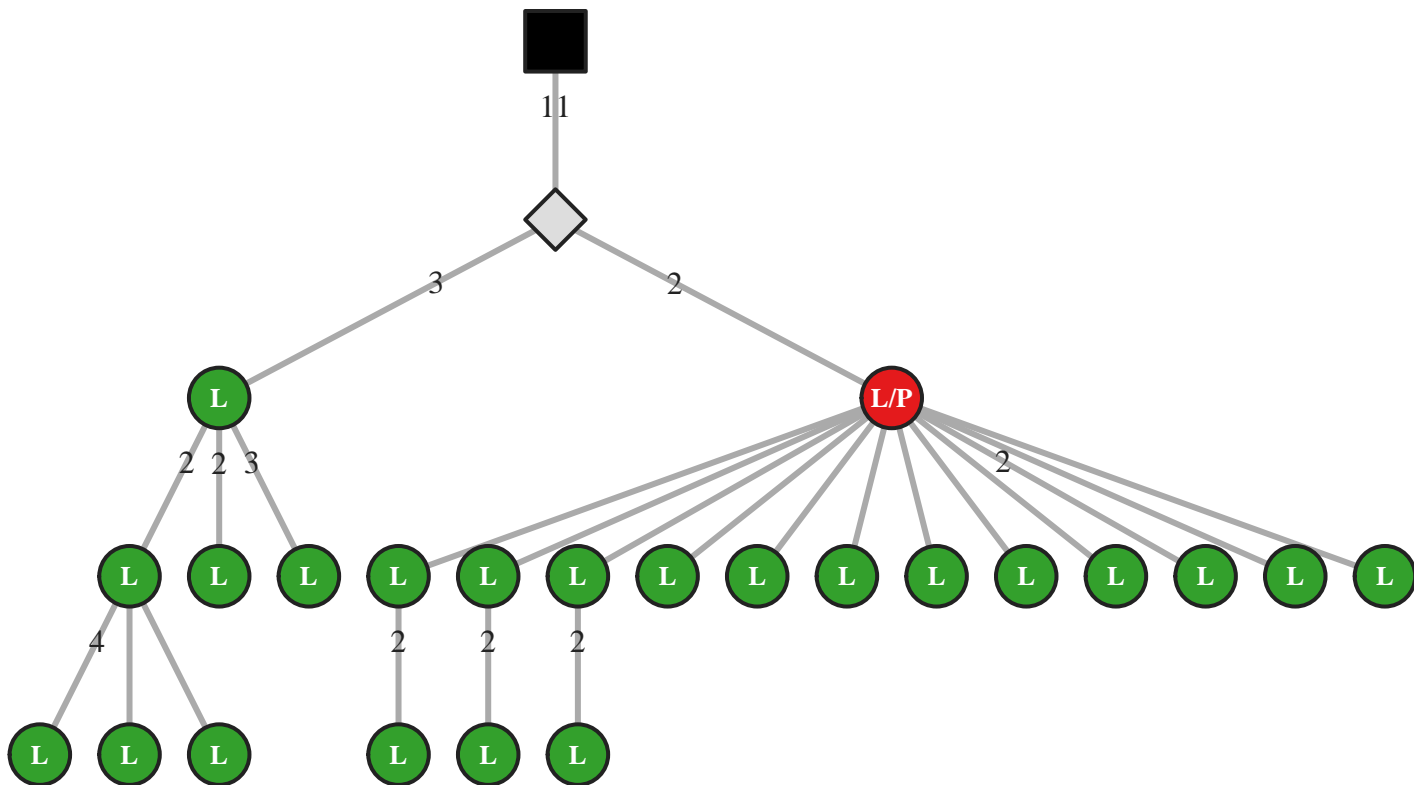

M5 IgG IGHV4-39/J4 81bp (28014)

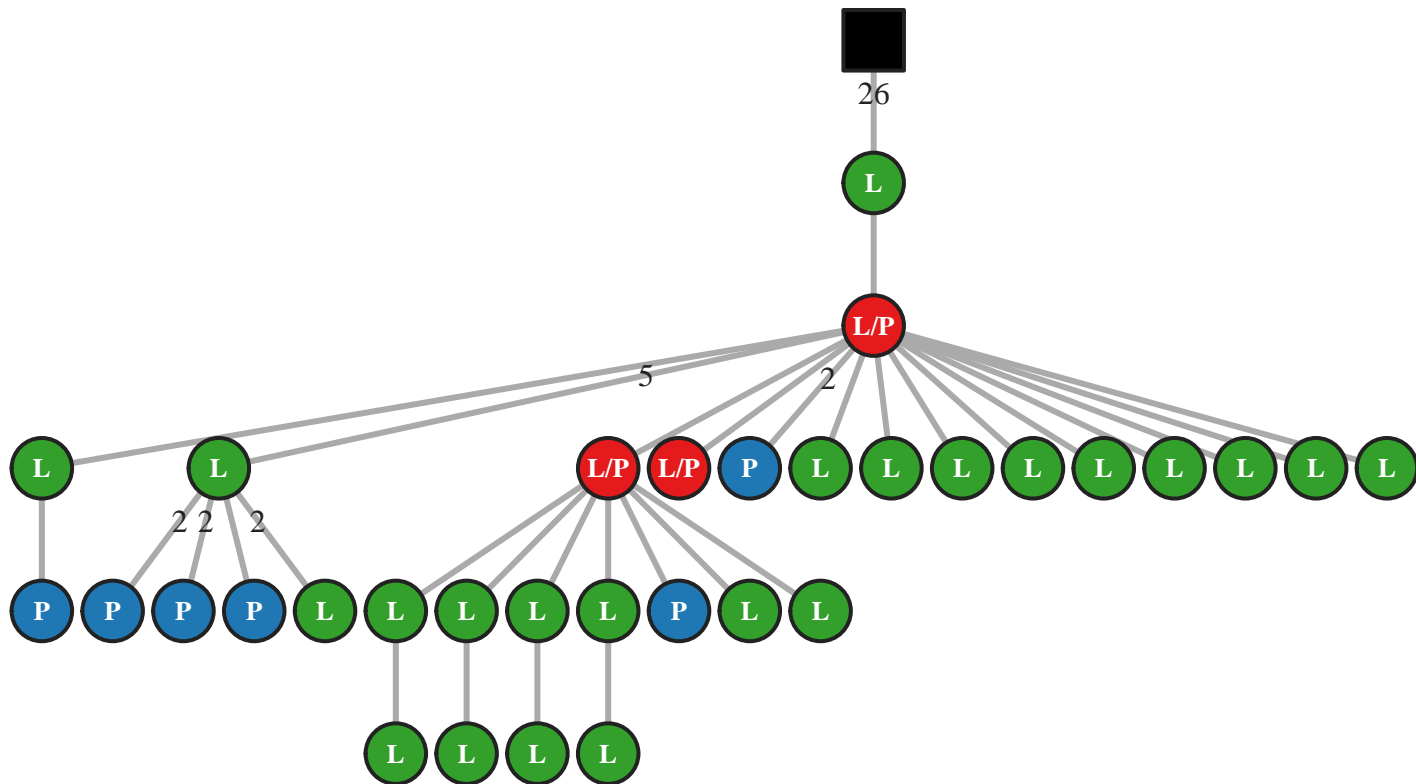

M5 IgG IGHV4-39/J5 39bp (53084)

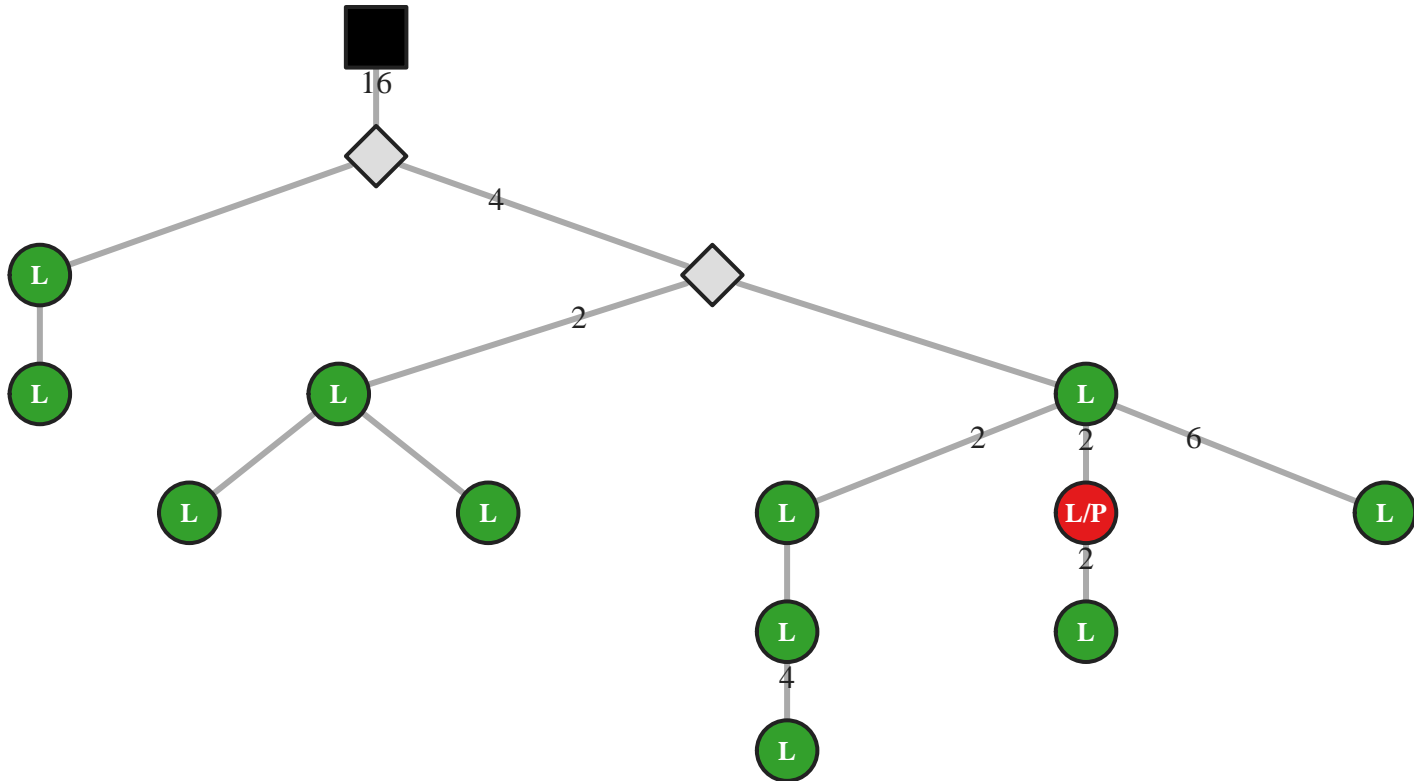

M5 IgG IGHV4-39/J5 45bp (9888)

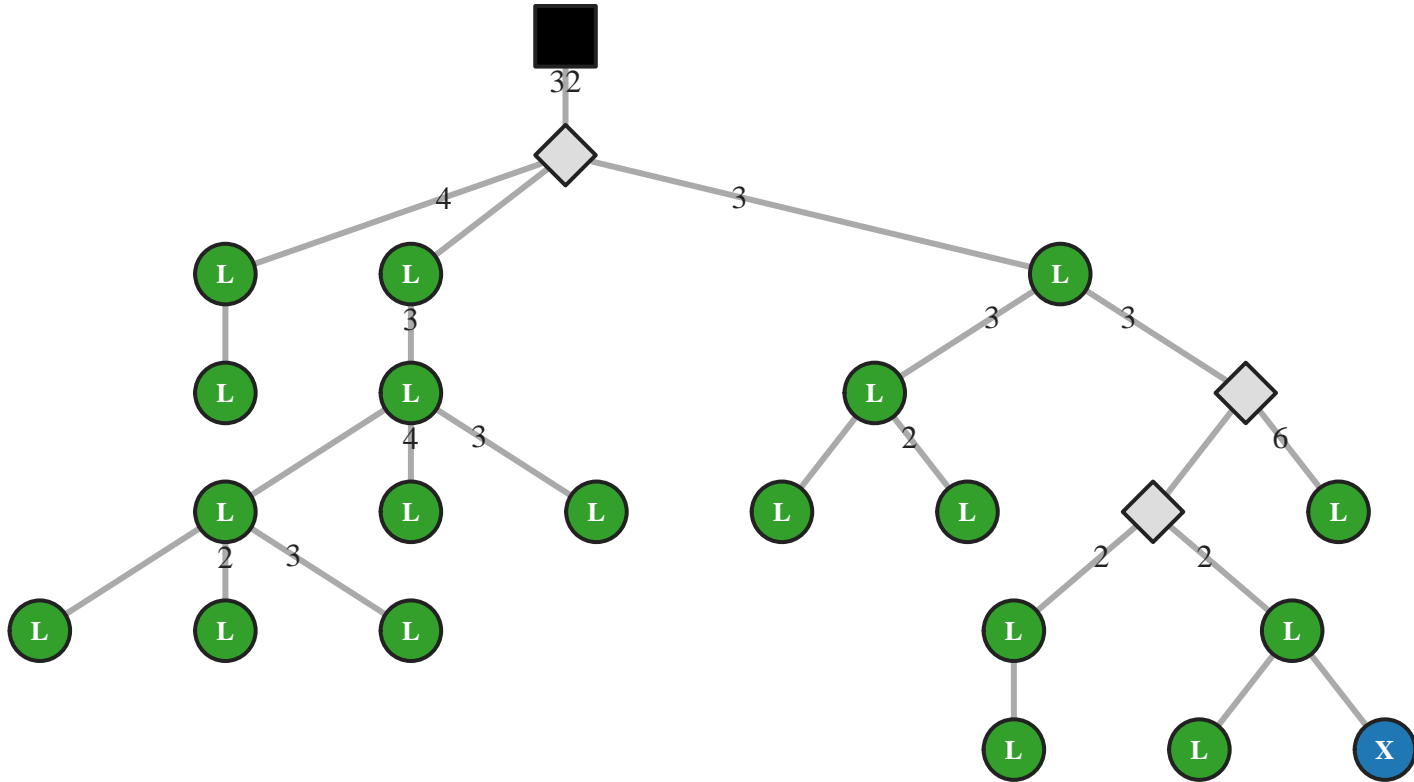

M5 IgA IGHV4-39/J5 51bp (30825)

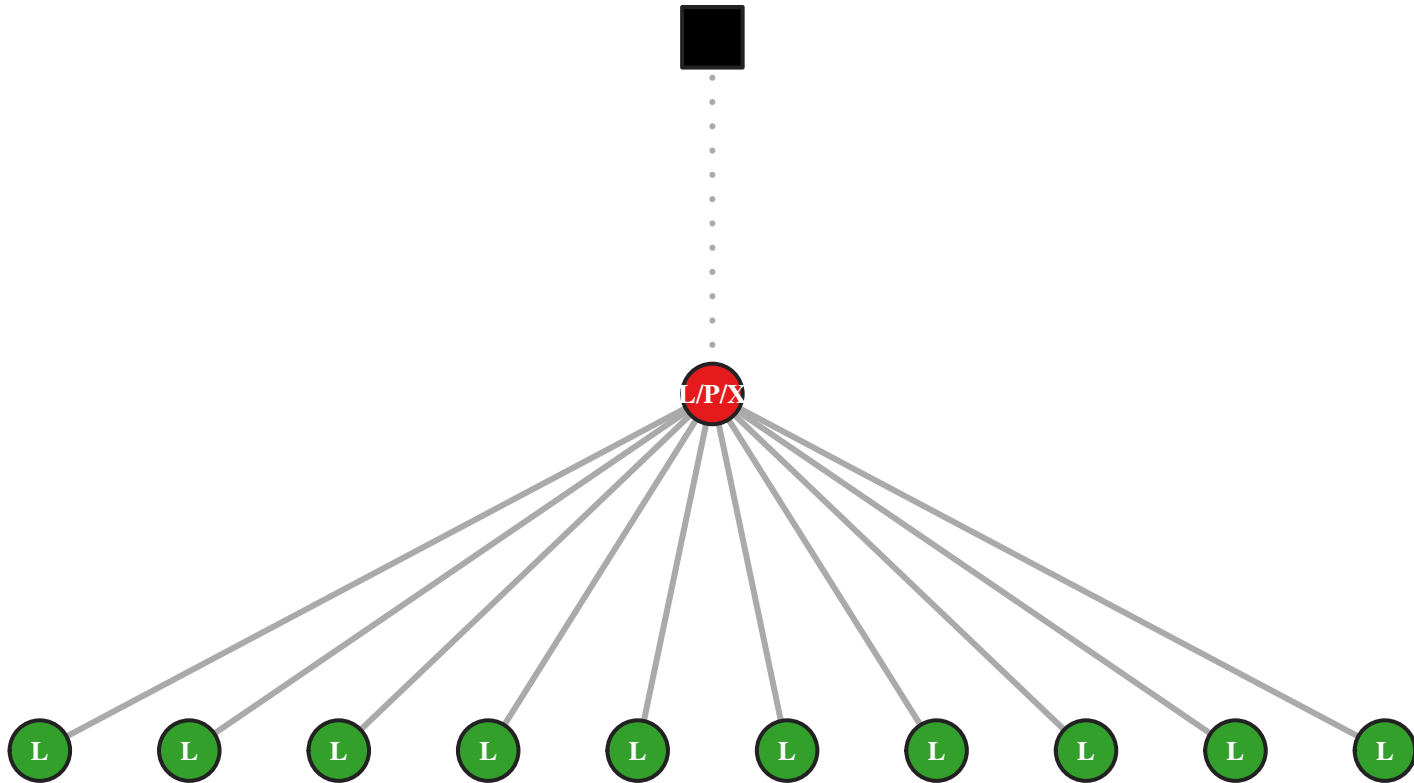

M5 IgG IGHV4-39/J5 51bp (53111)

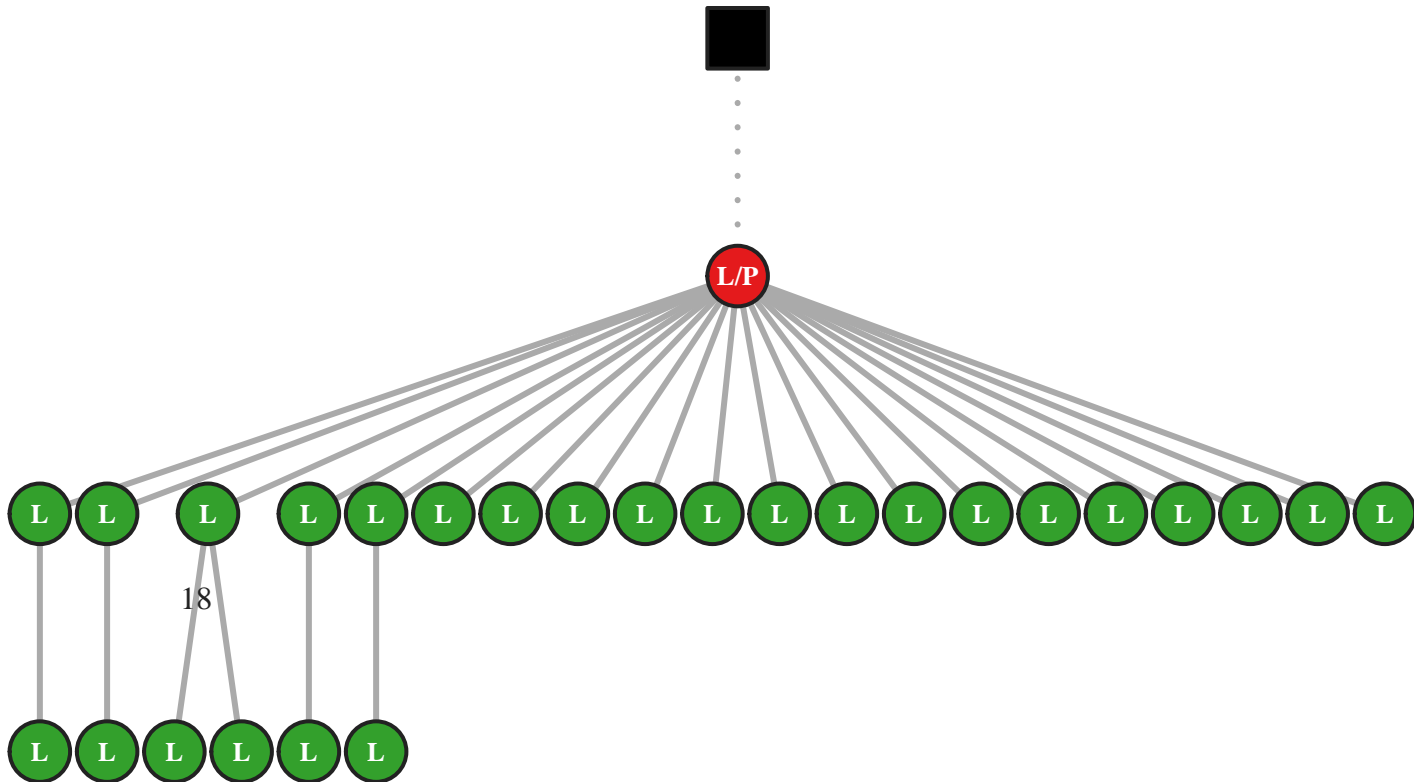

M5 IgG IGHV4-39/J5 54bp (36313)

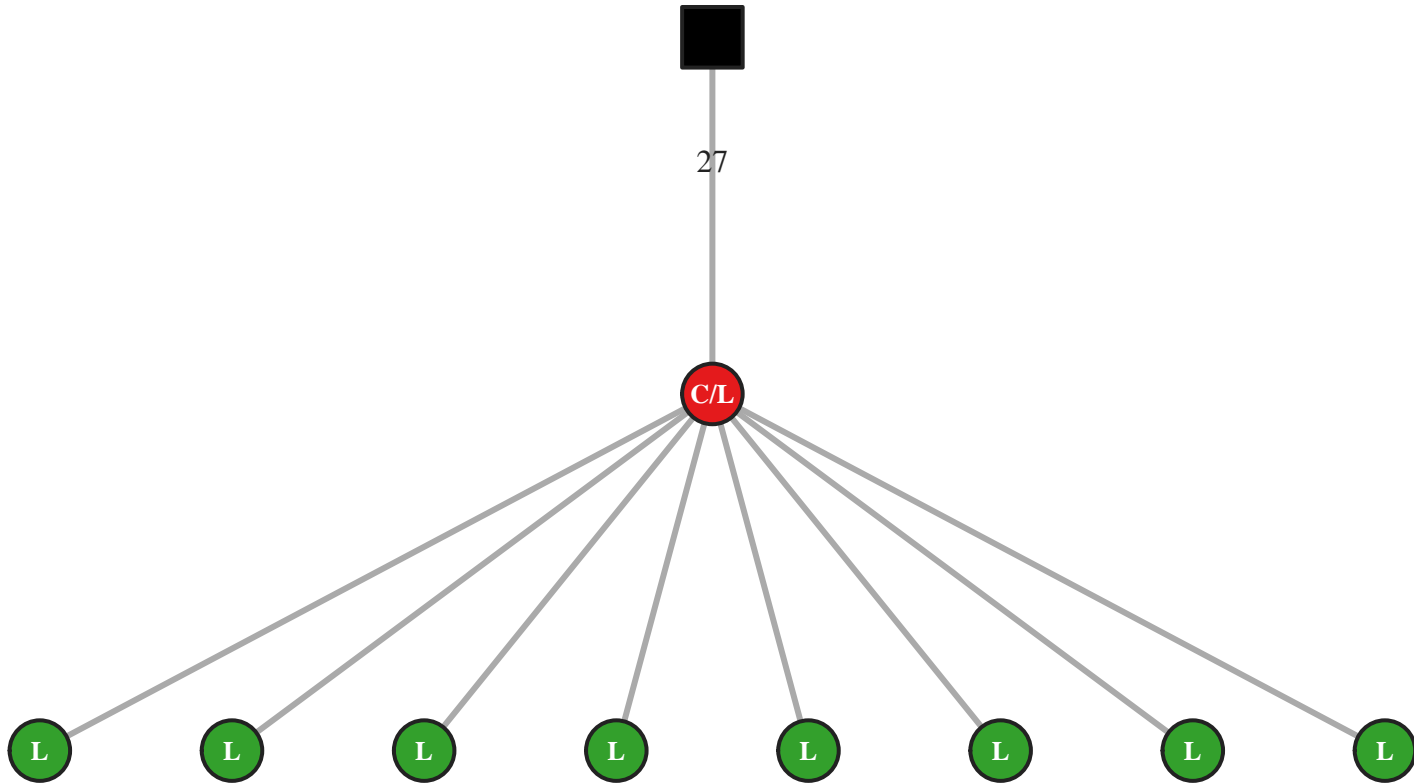

M5 IgG IGHV4-39/J5 57bp (19153)

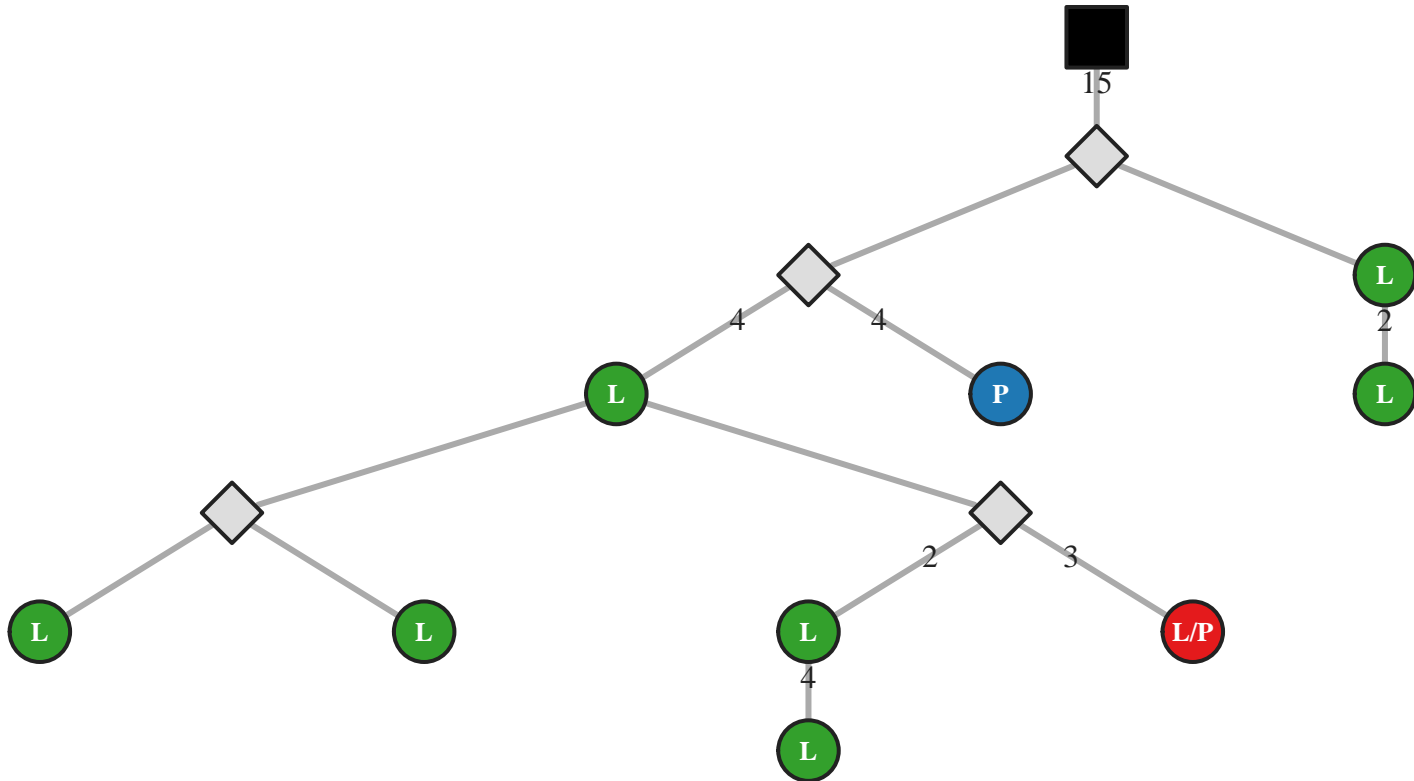

M5 IgG IGHV4-39/J5 60bp (9901)

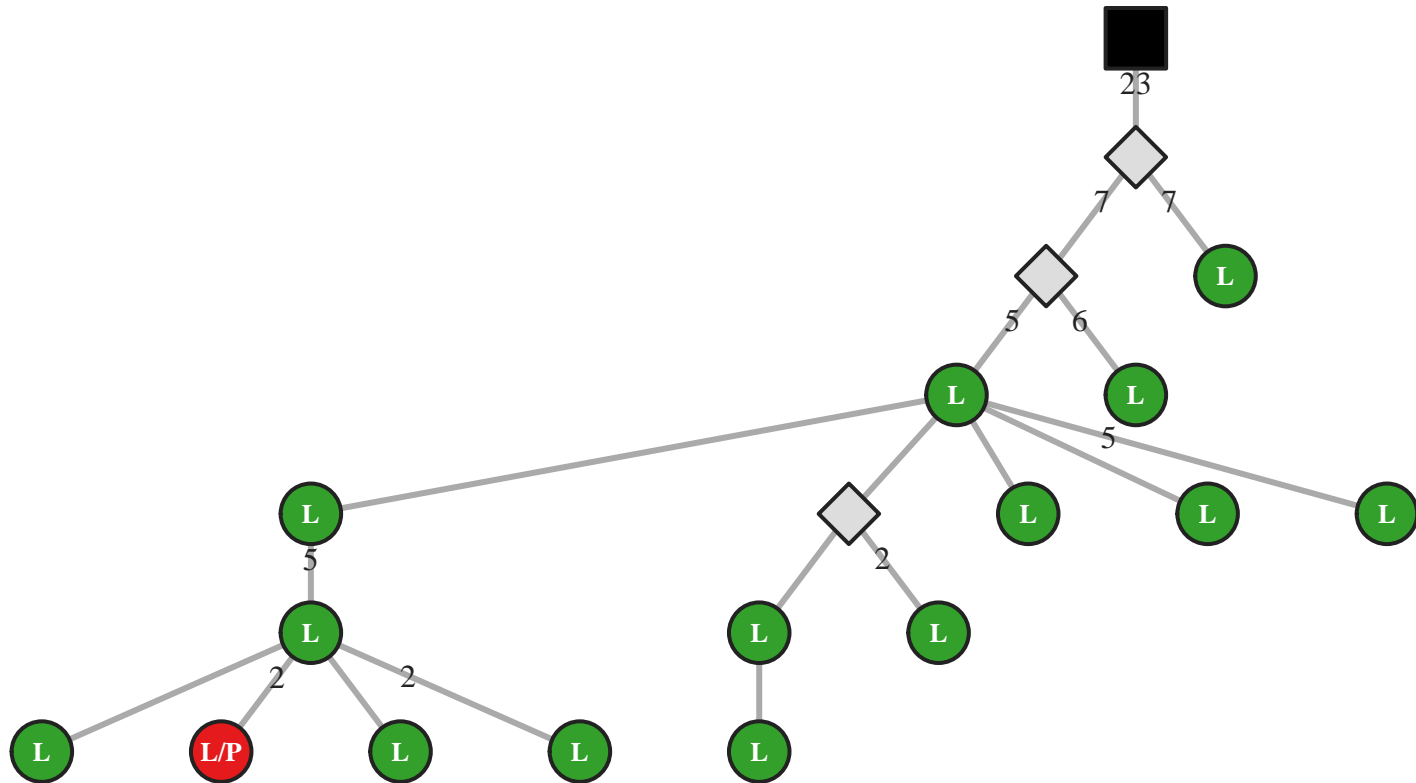

M5 IgG IGHV4-4/J2 33bp (28020)

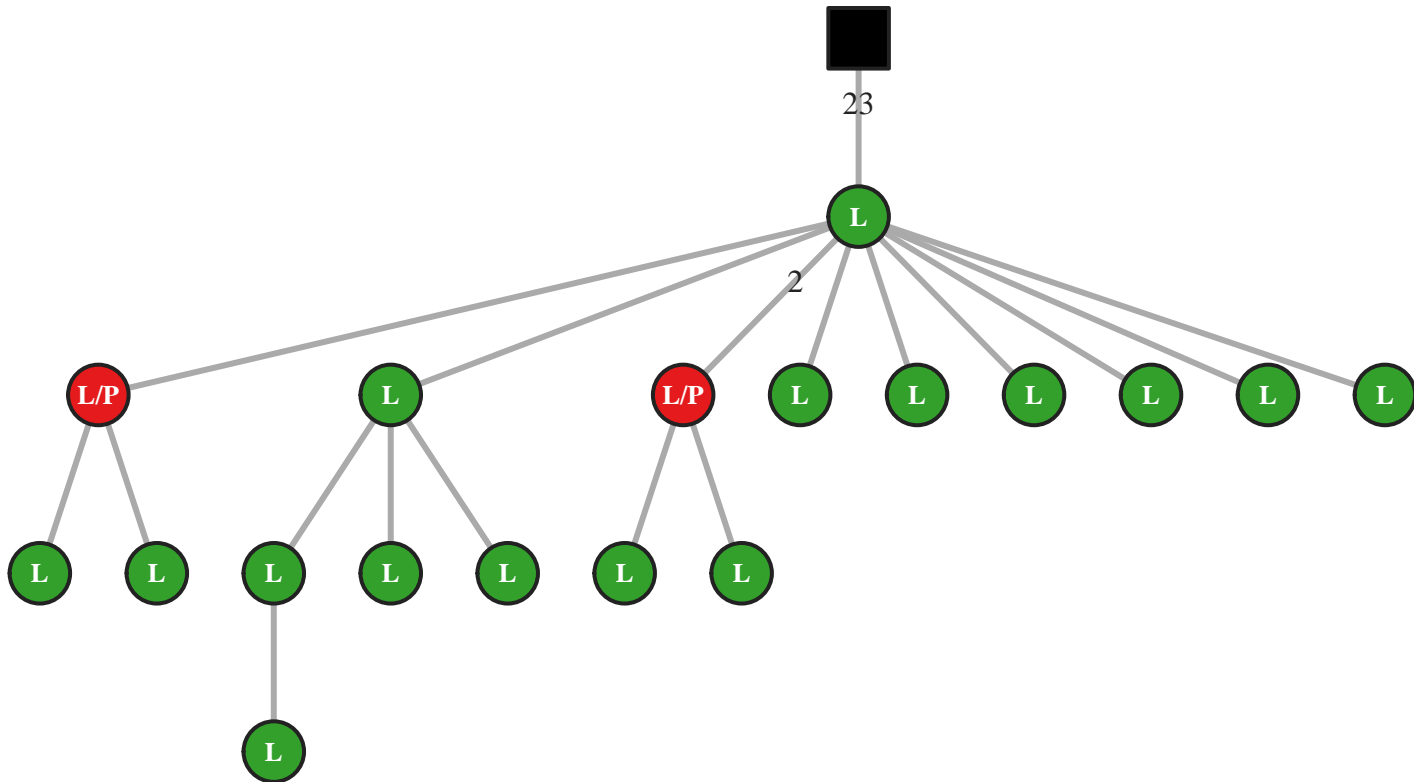

M5 IgG IGHV4-4/J2 66bp (53117)

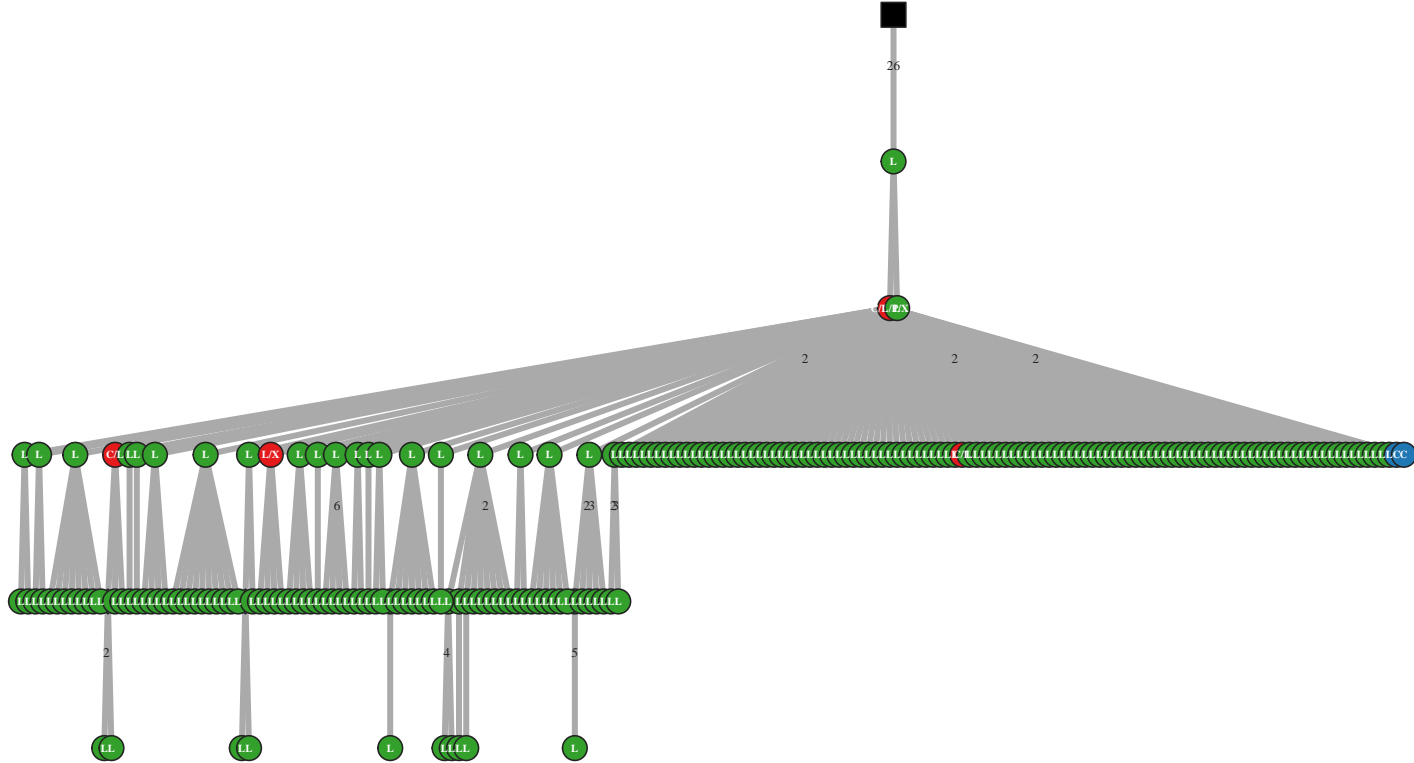

M5 IgG IGHV4-4/J3 39bp (36356)

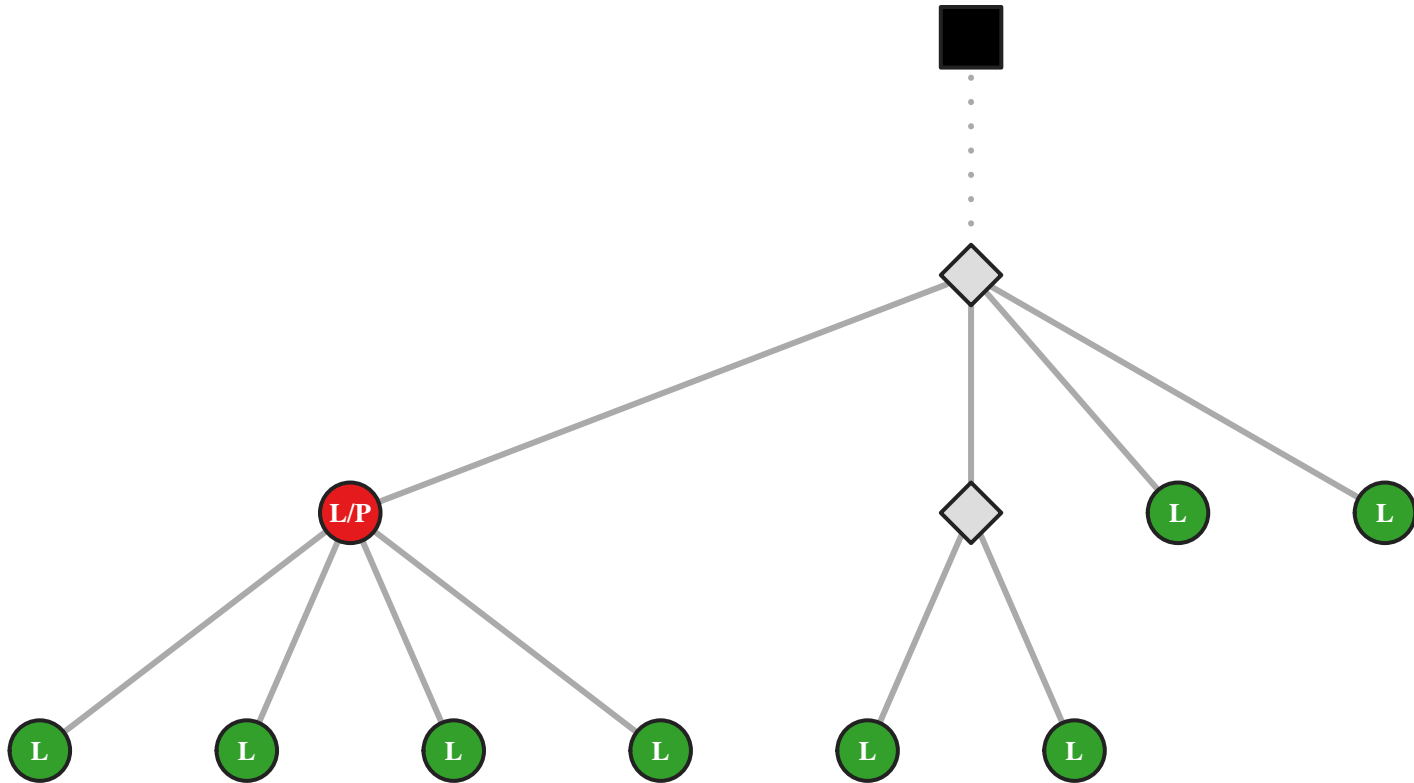

M5 IgG IGHV4-4/J3 39bp (36358)

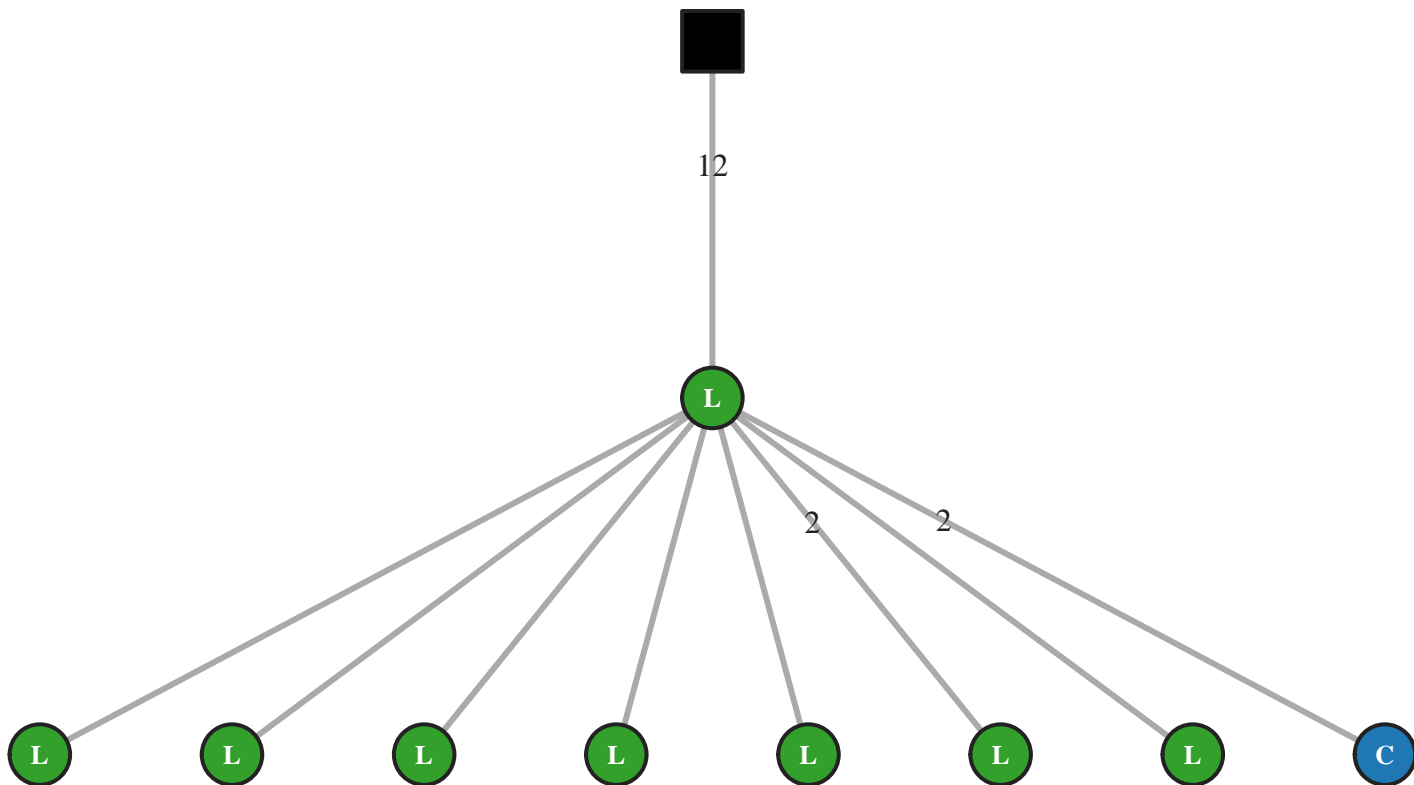

M5 IgG IGHV4-4/J4 30bp (9937)

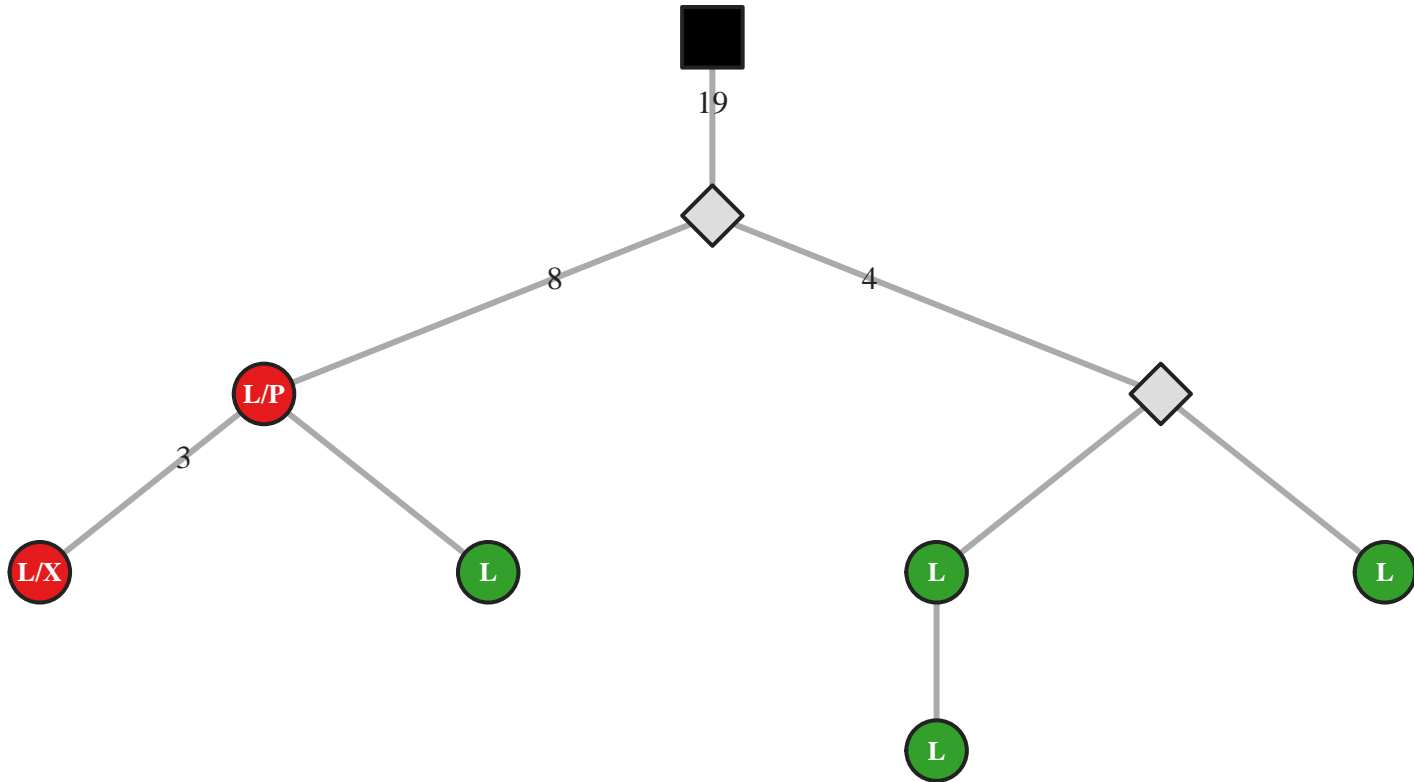

M5 IgG IGHV4-4/J4 39bp (28041)

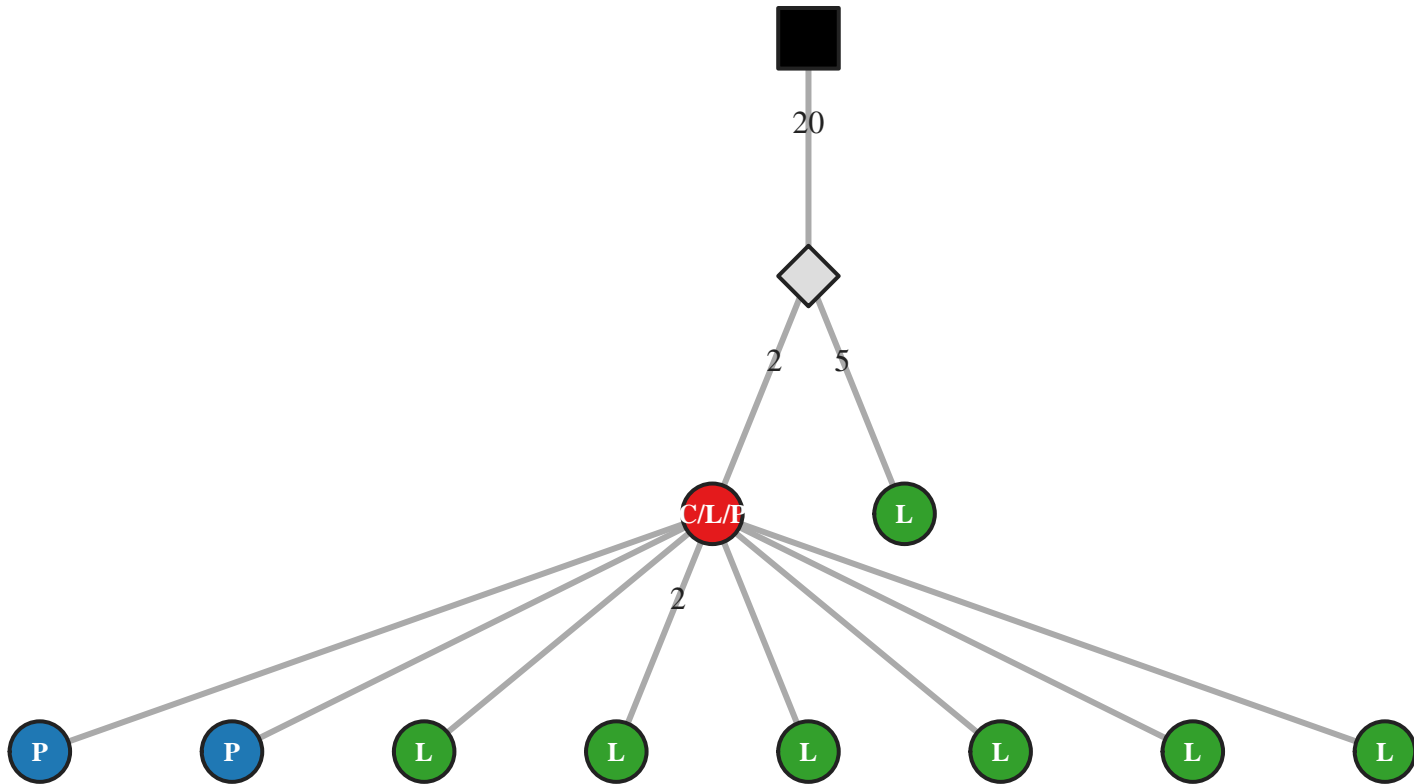

M5 IgG IGHV4-4/J4 39bp (28074)

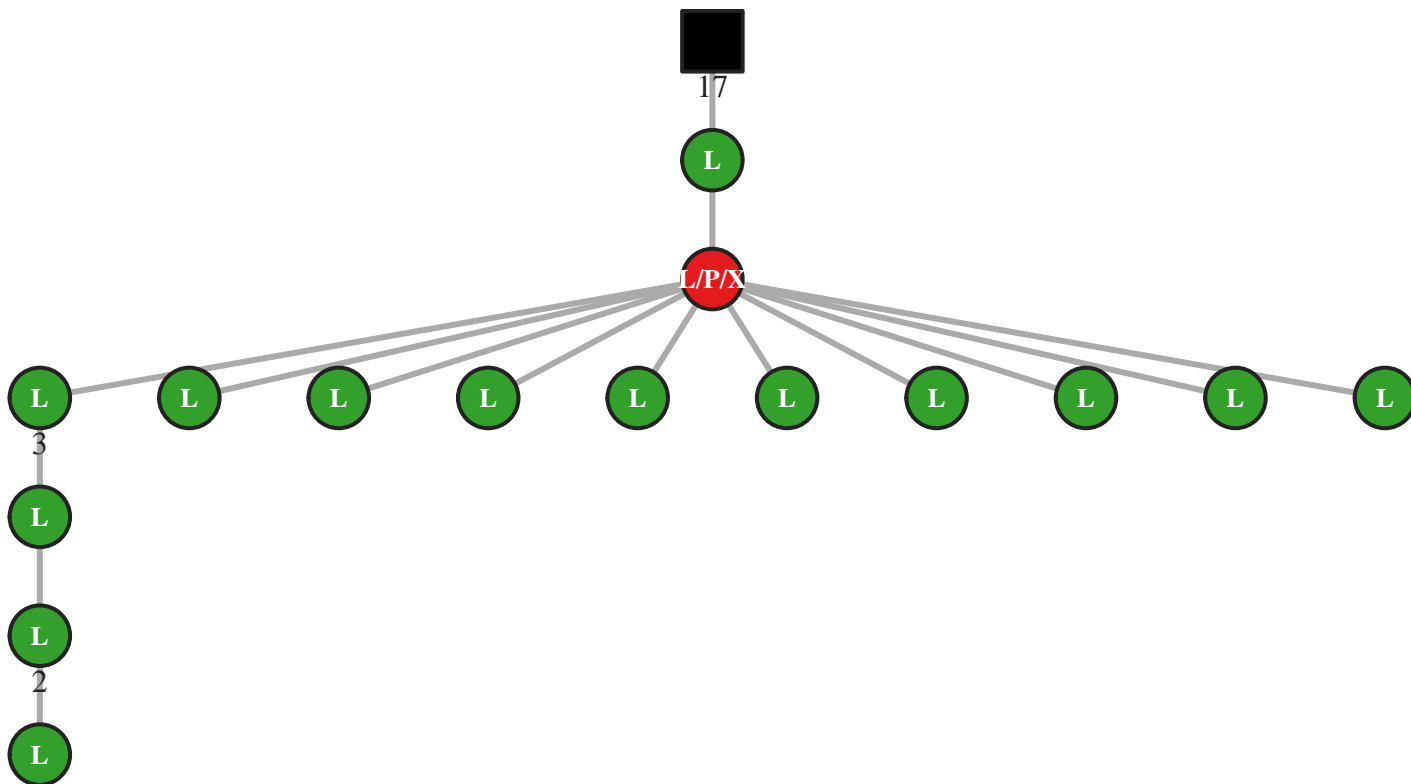

M5 IgG IGHV4-4/J4 42bp (36440)

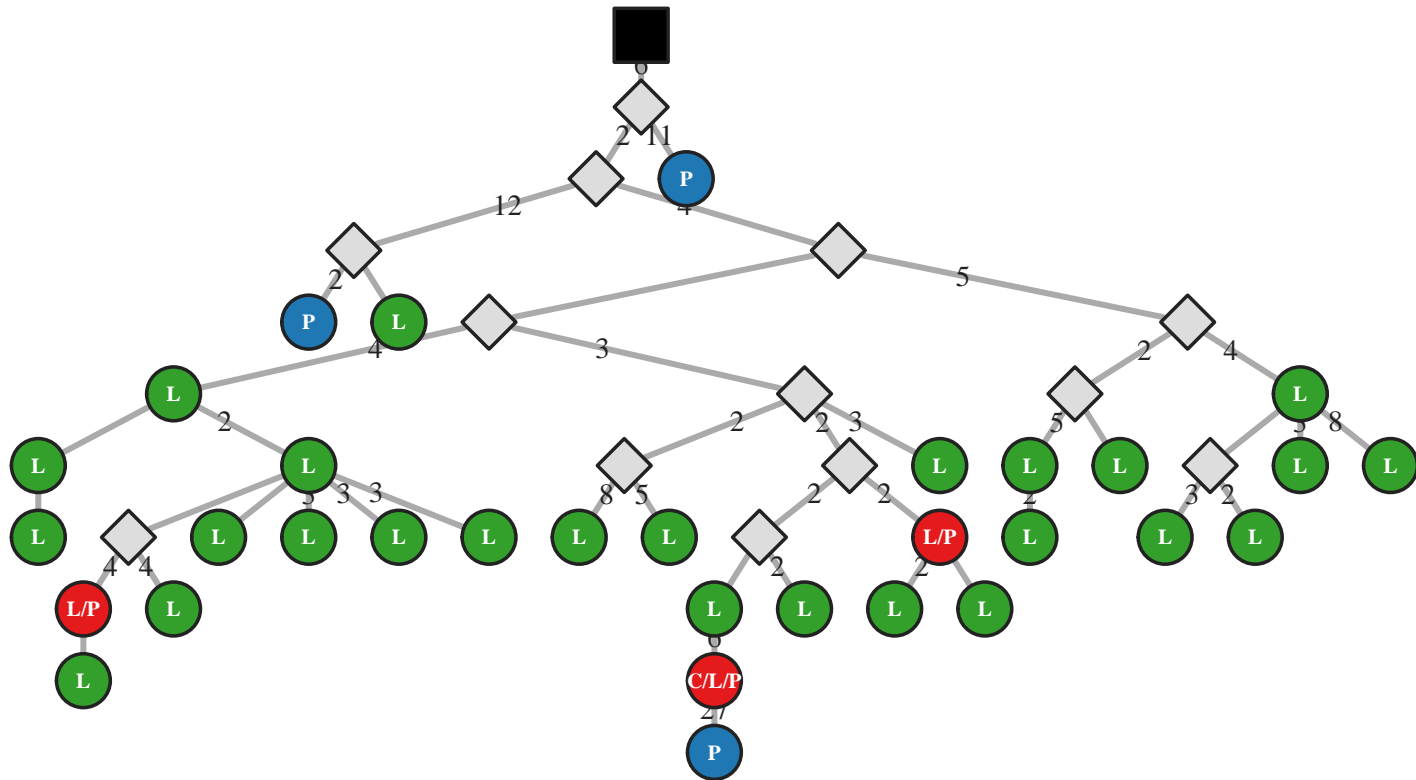

M5 IgA IGHV4-4/J4 45bp (3159)

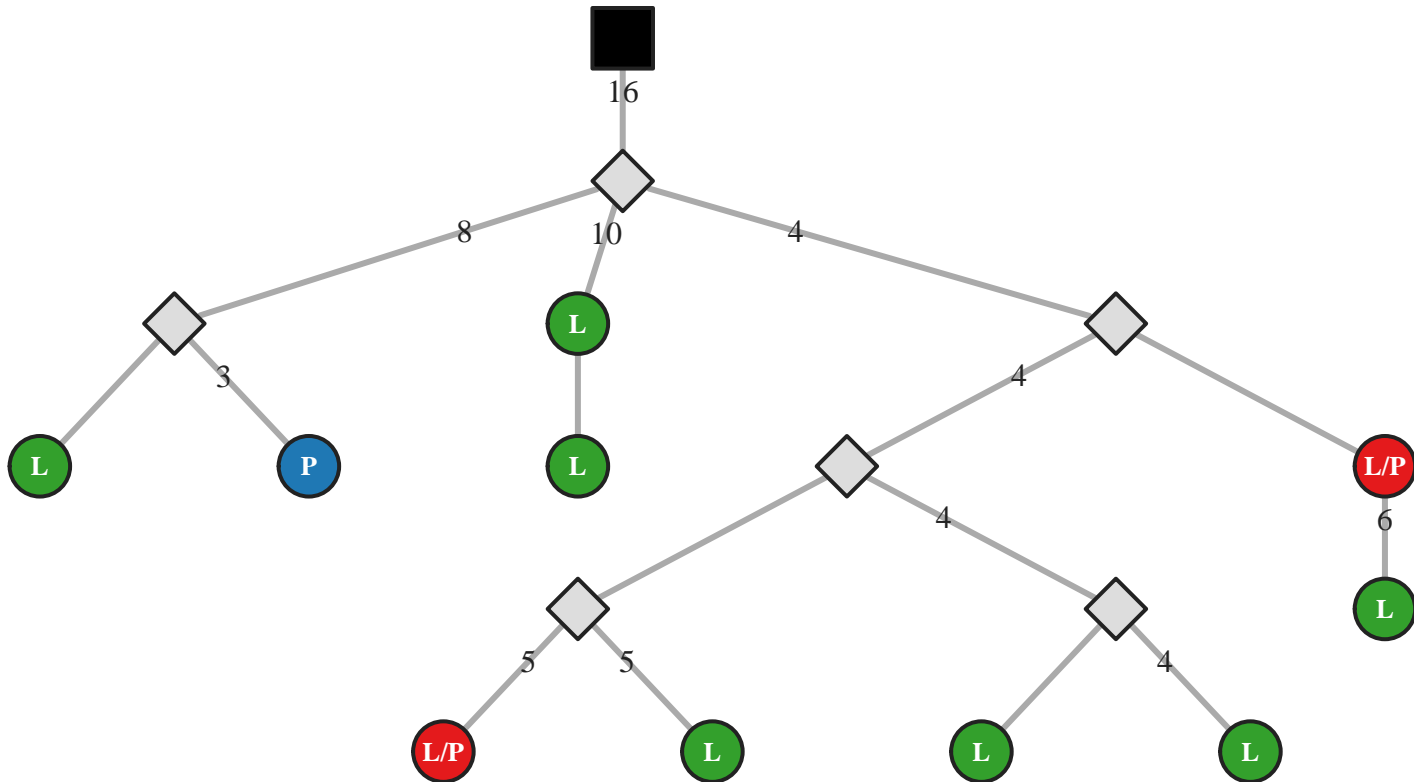

M5 IgA IGHV4-4/J4 45bp (3160)

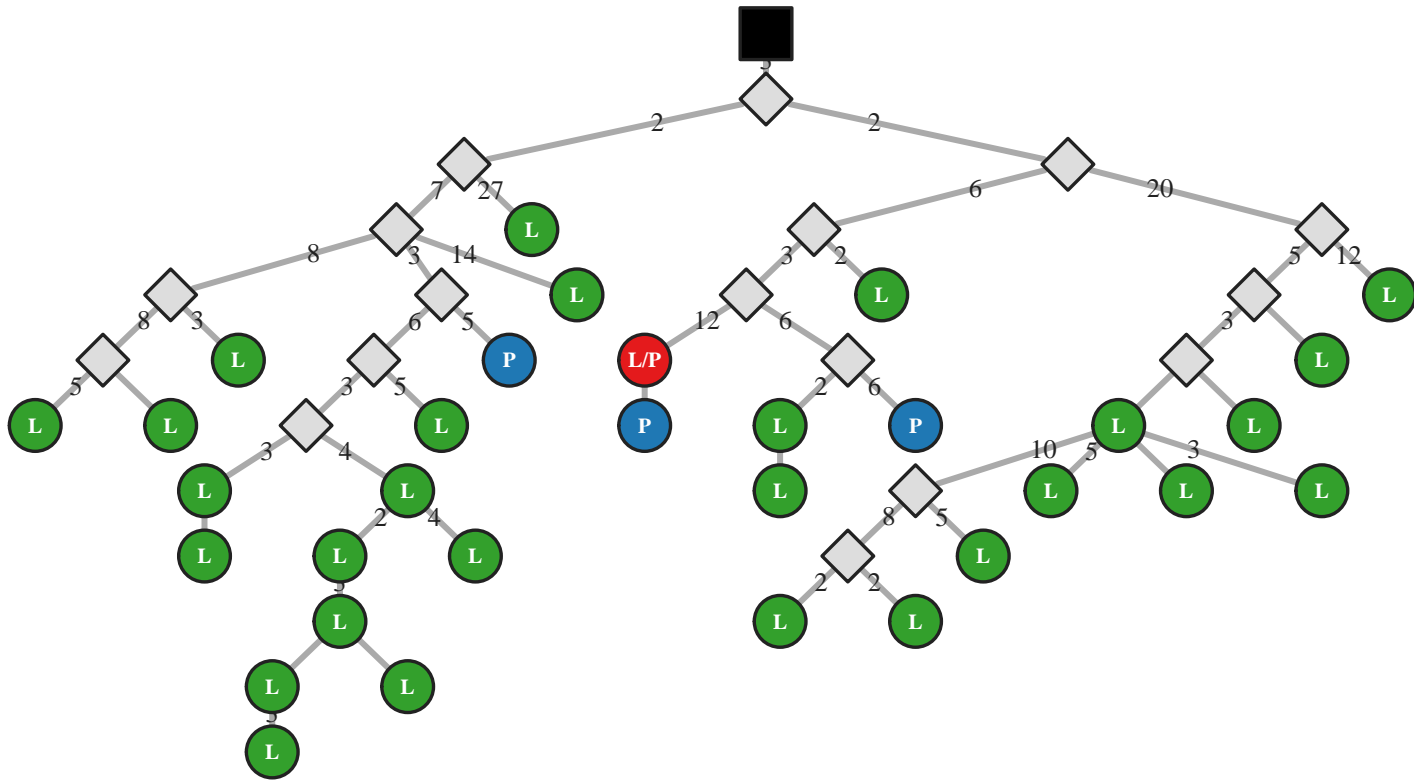

M5 IgG IGHV4-4/J4 45bp (9961)

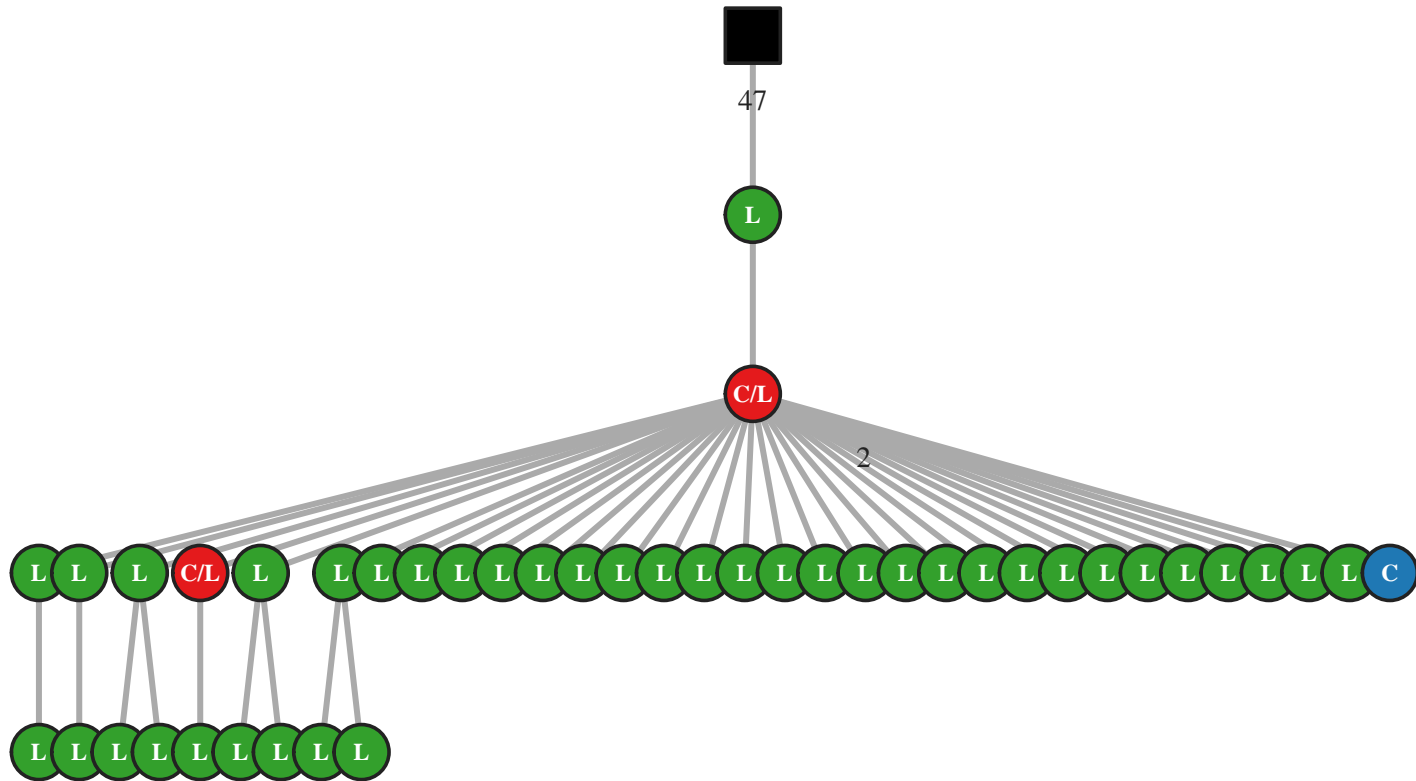

M5 IgG IGHV4-4/J4 45bp (9988)

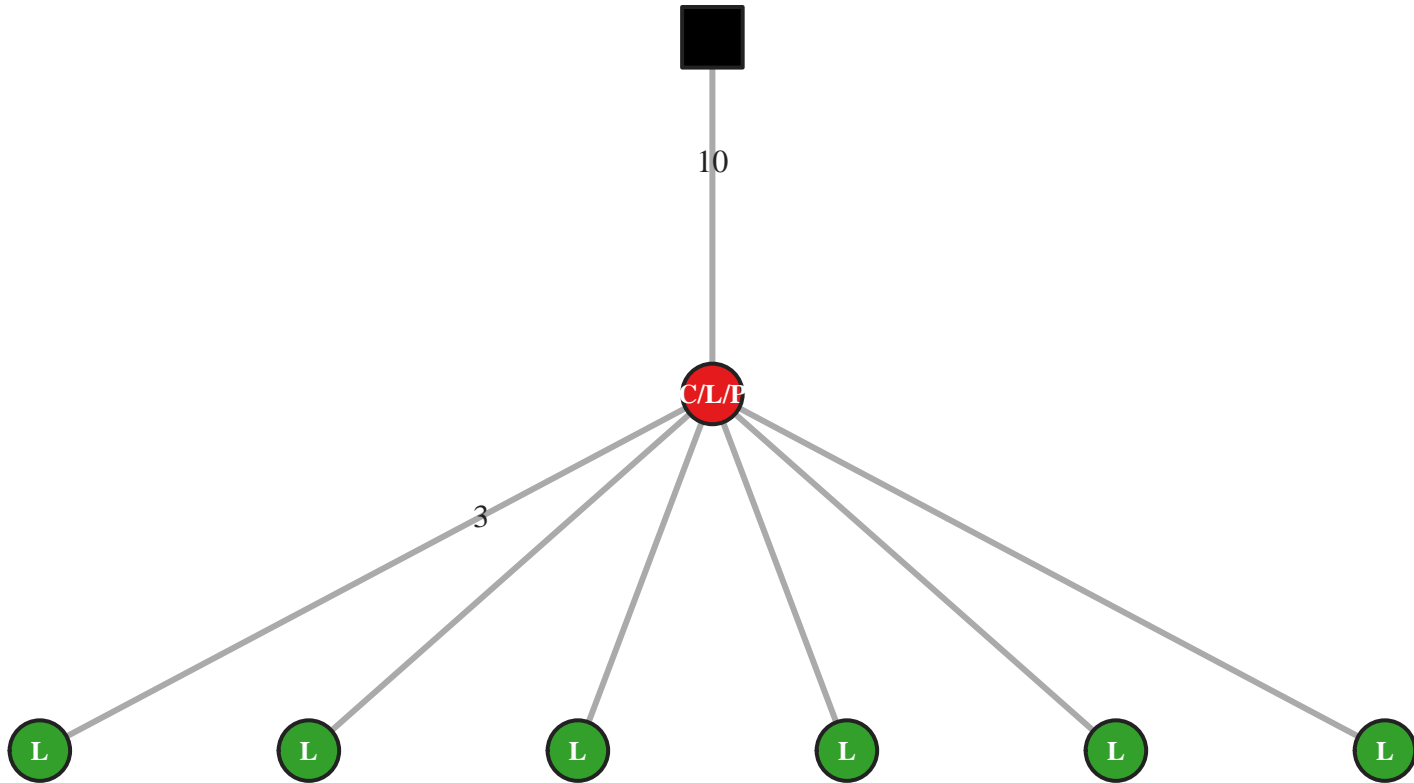

M5 IgG IGHV4-4/J4 45bp (9989)

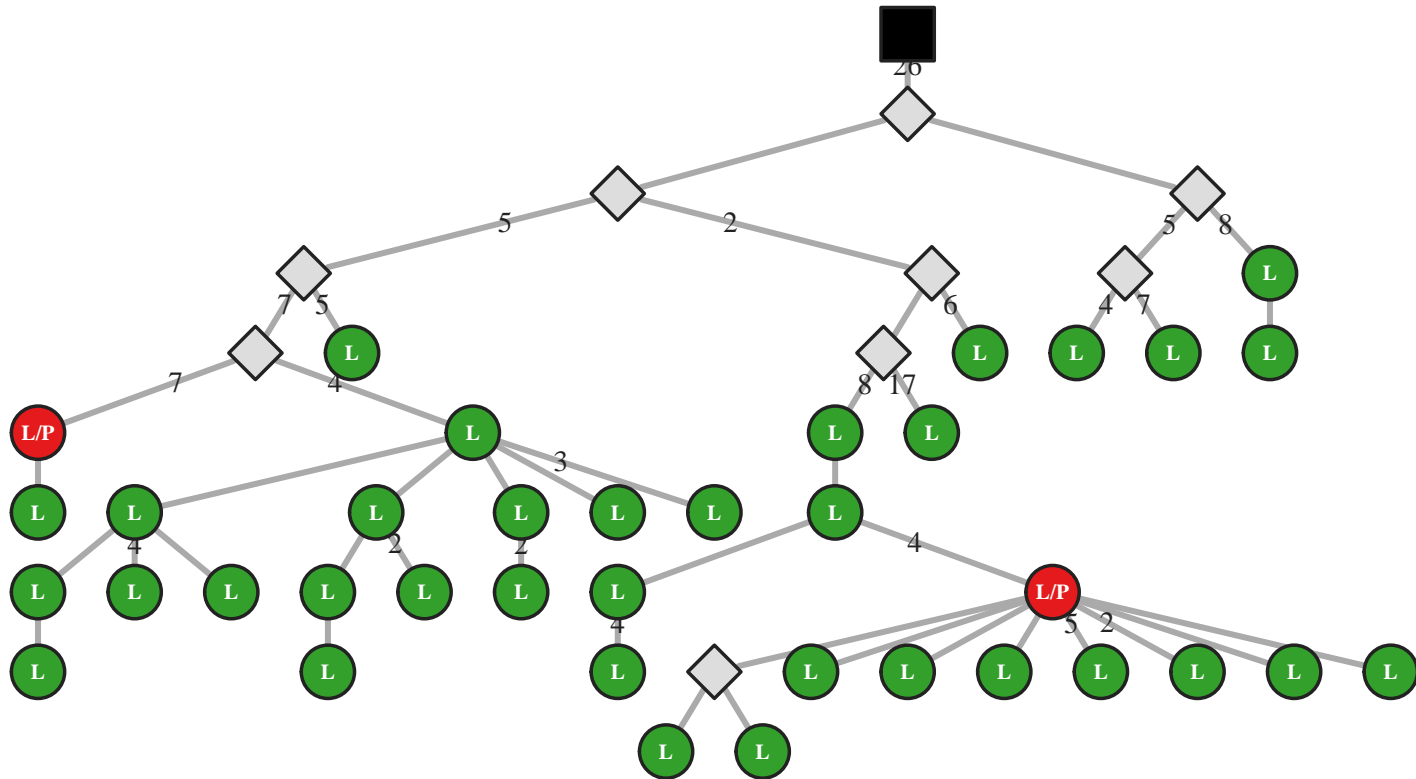

M5 IgG IGHV4-4/J4 51bp (46638)

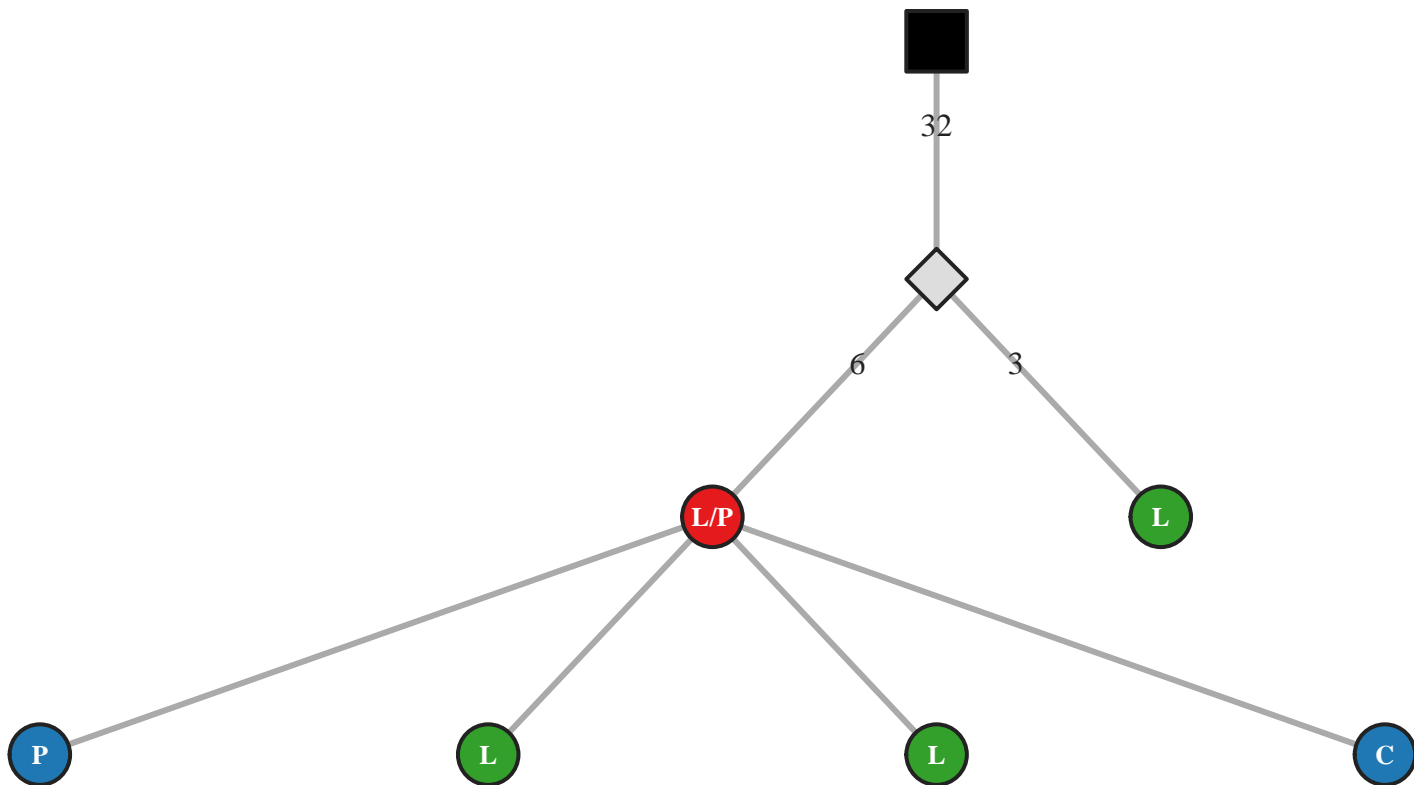

M5 IgG IGHV4-4/J4 57bp (10087)

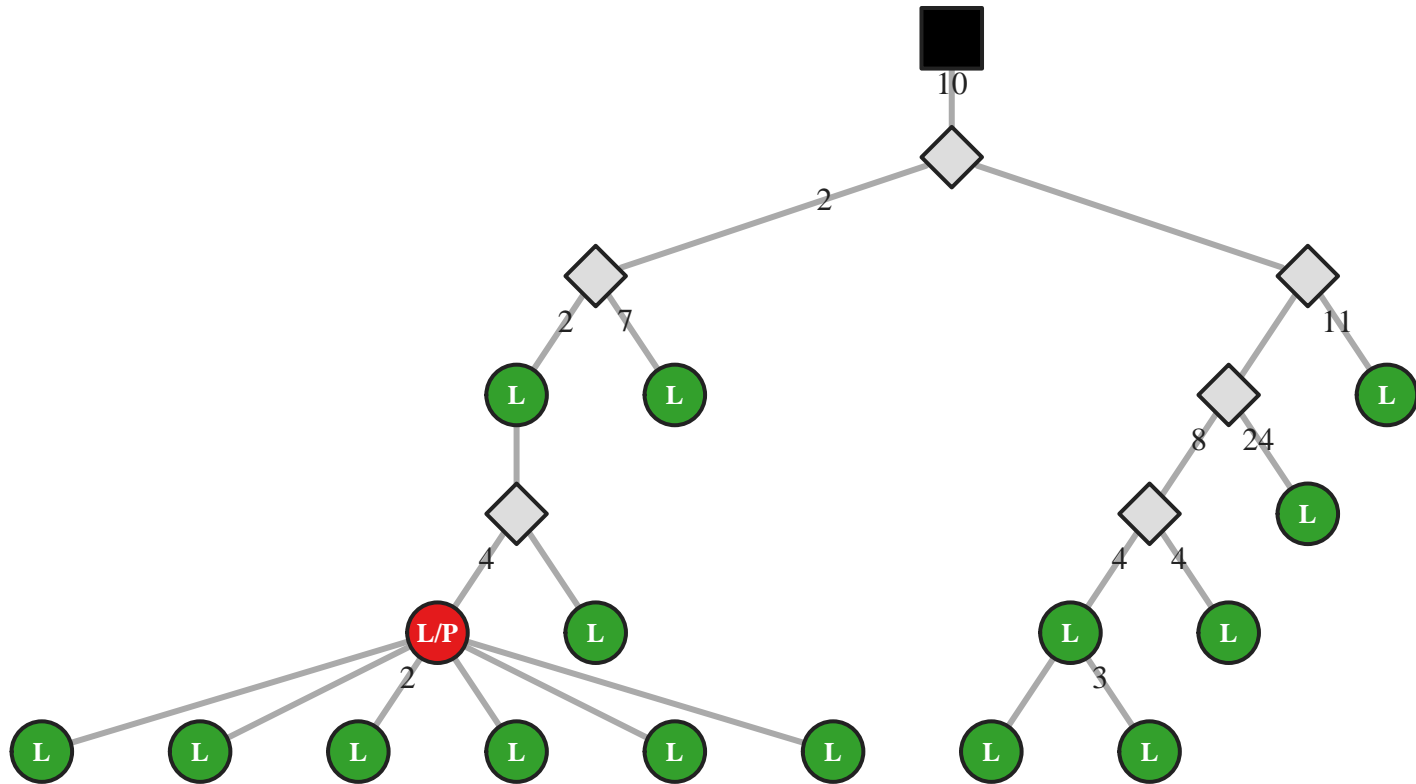

M5 IgM IGHV4-4/J4 63bp (29750)

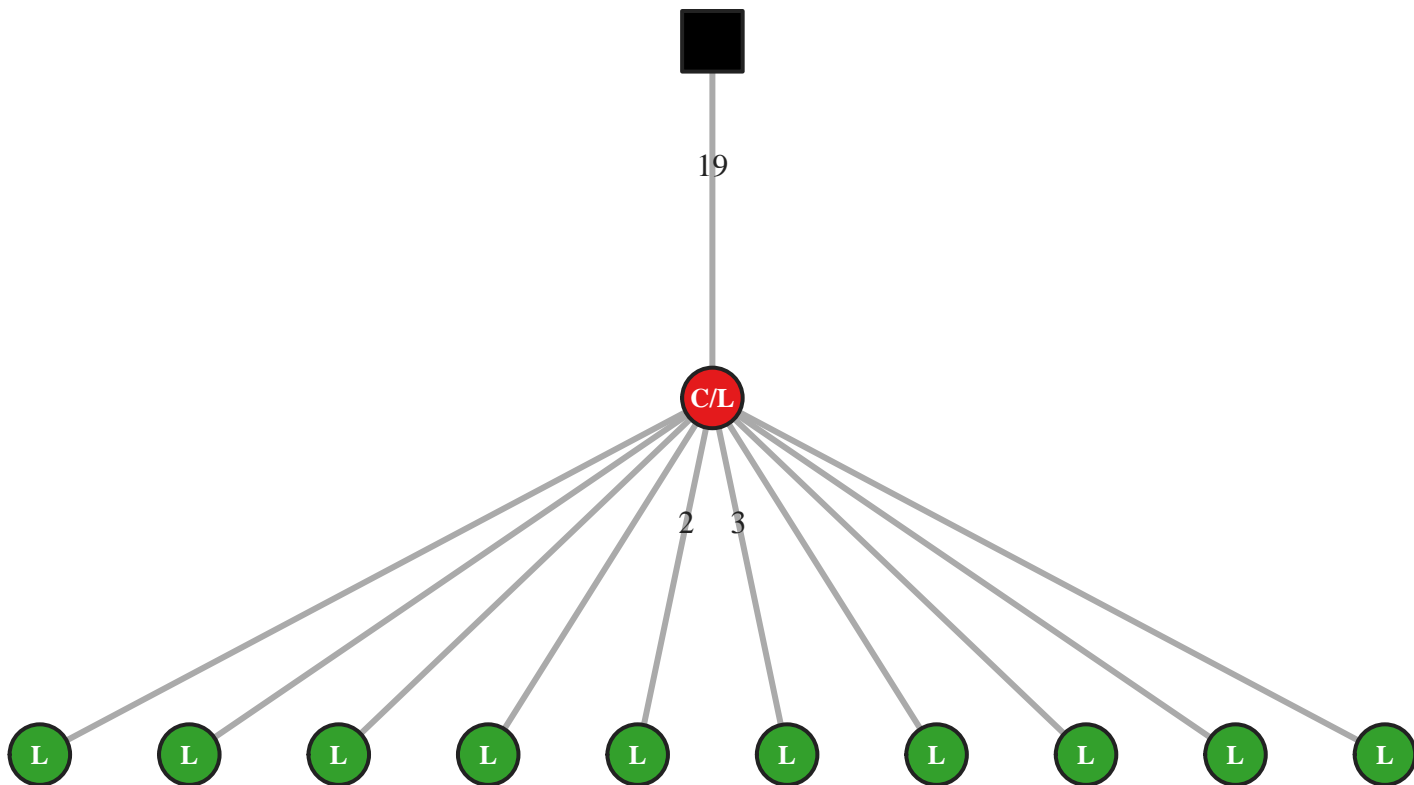

M5 IgG IGHV4-4/J5 30bp (46664)

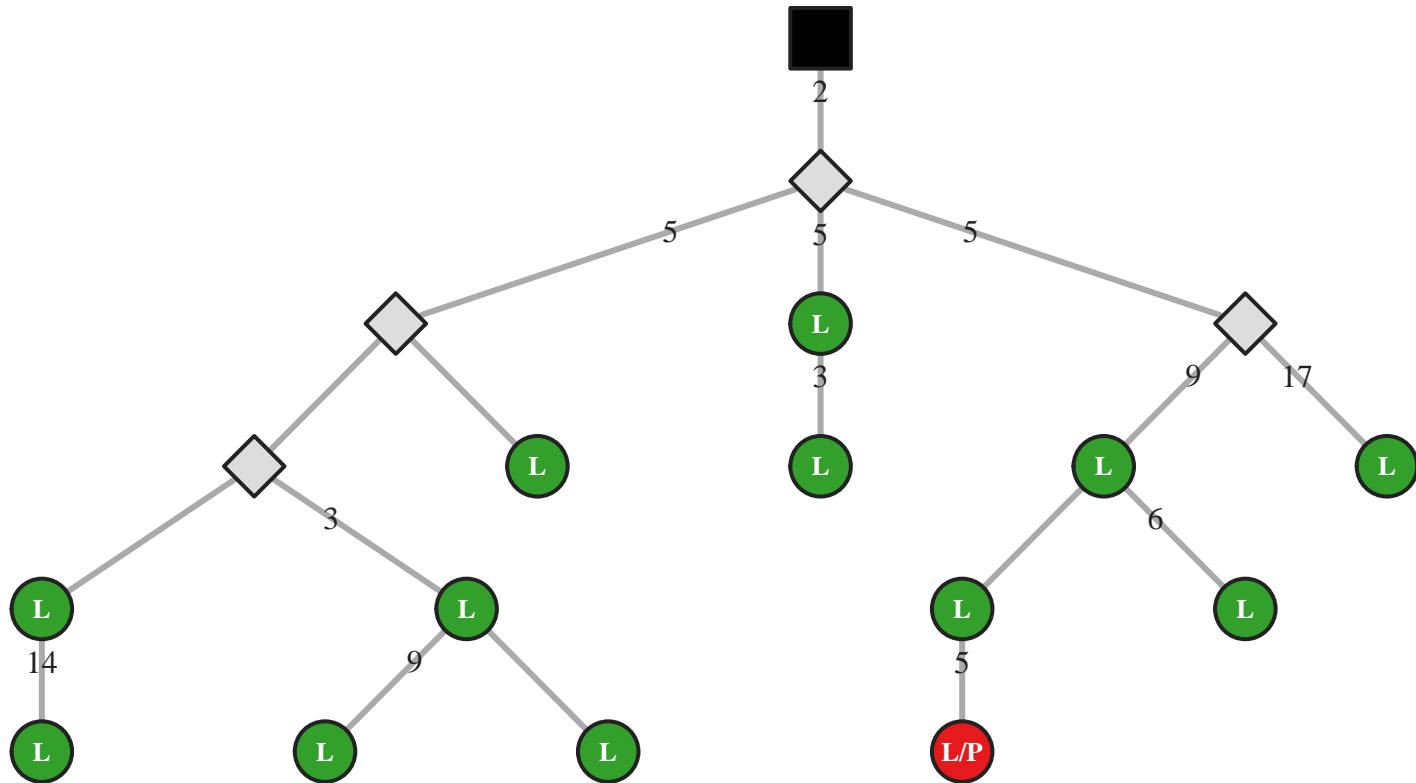

M5 IgG IGHV4-4/J5 39bp (10094)

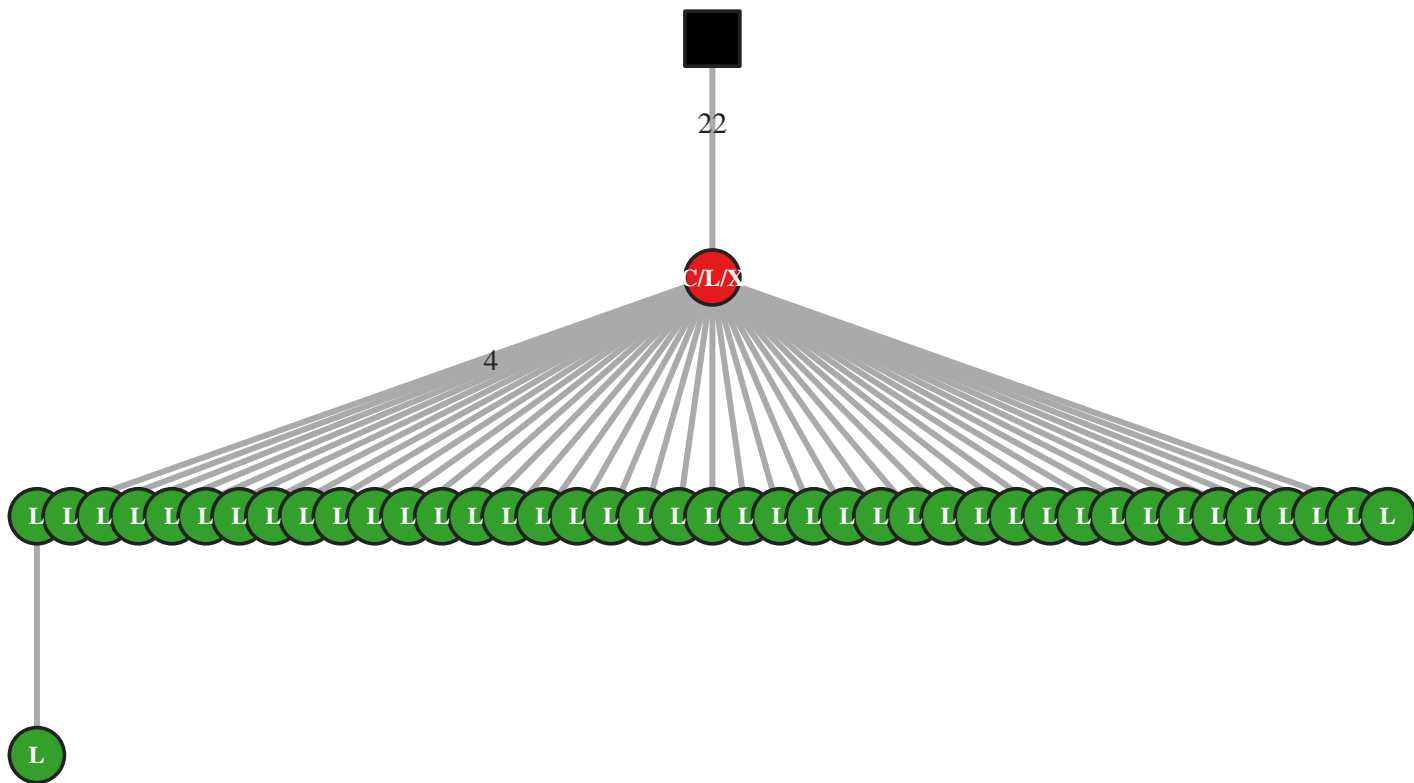

M5 IgG IGHV4-4/J5 42bp (28082)

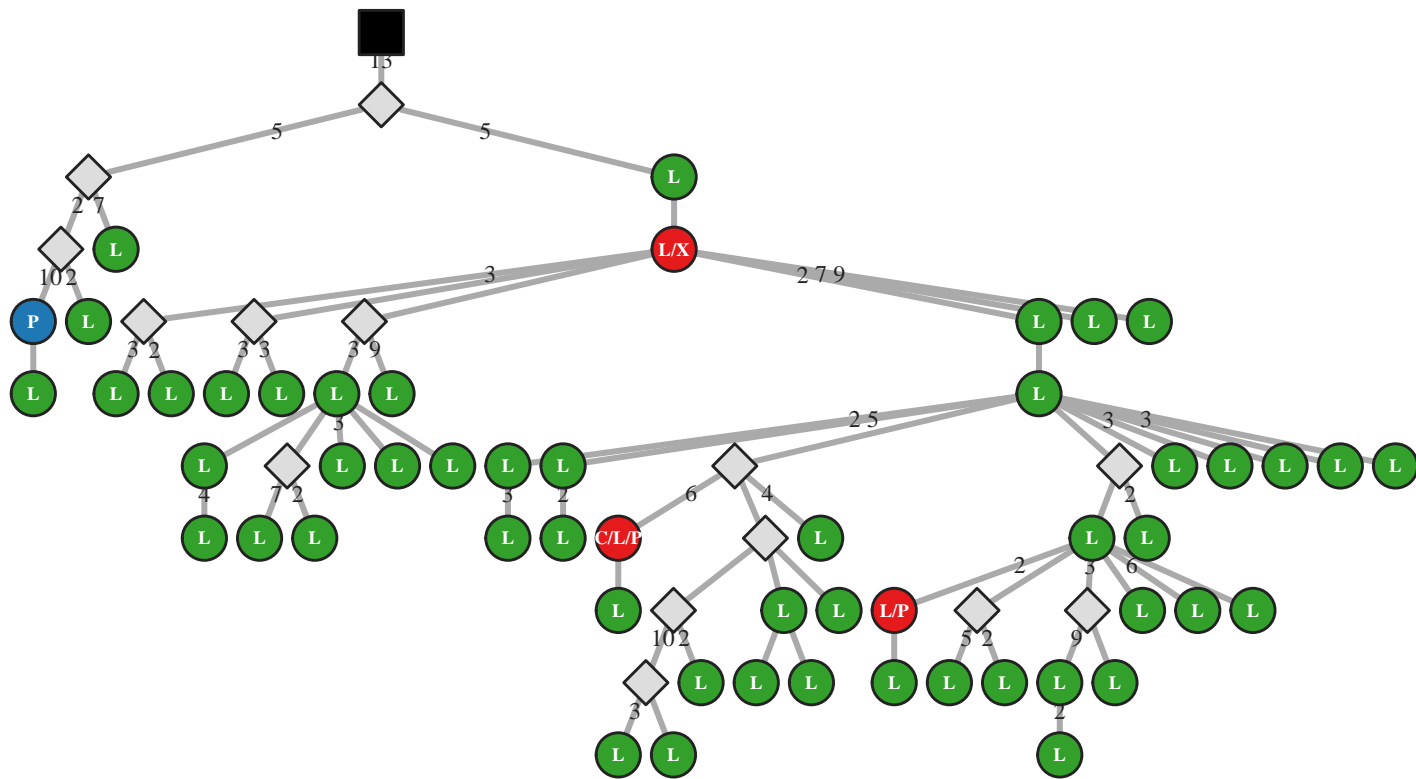

M5 IgG IGHV4-4/J5 48bp (46686)

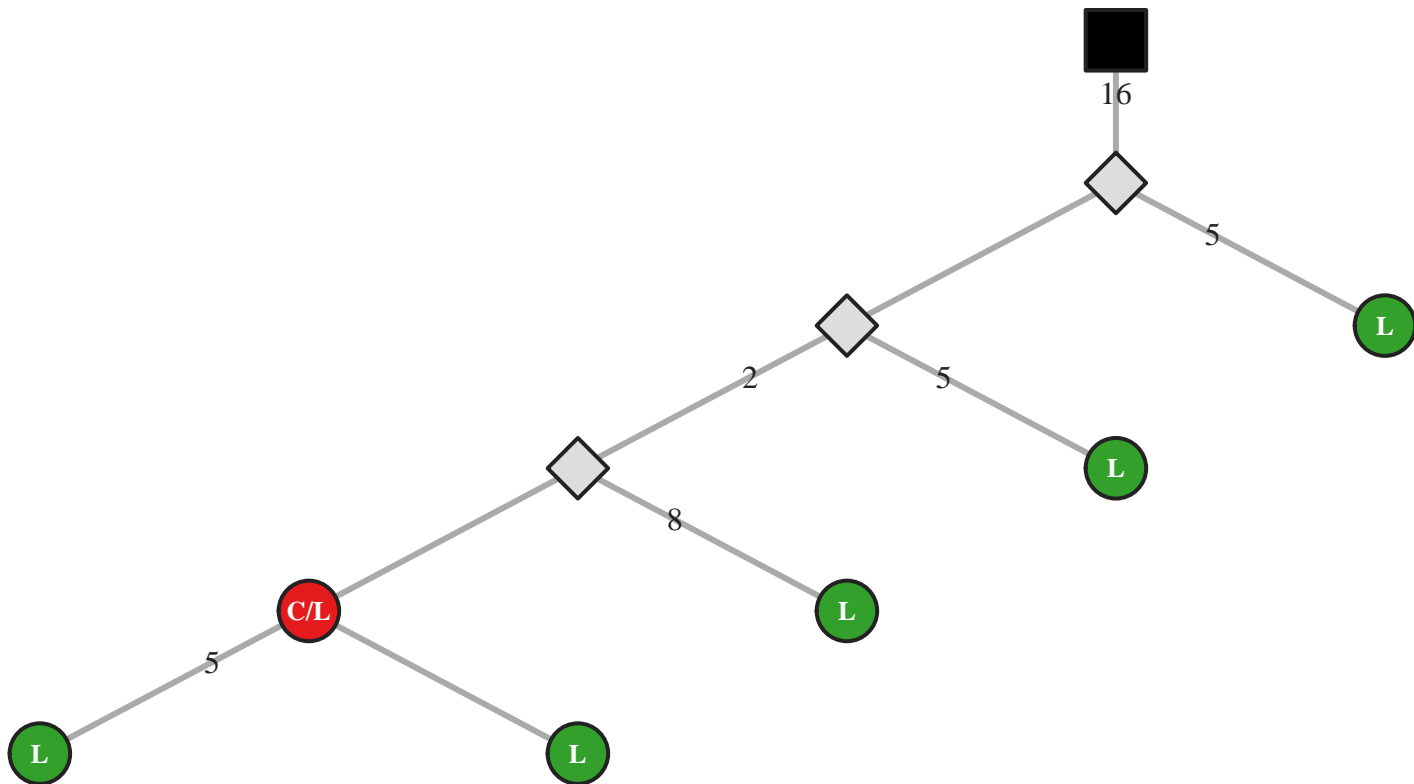

M5 IgG IGHV4-4/J6 48bp (53171)

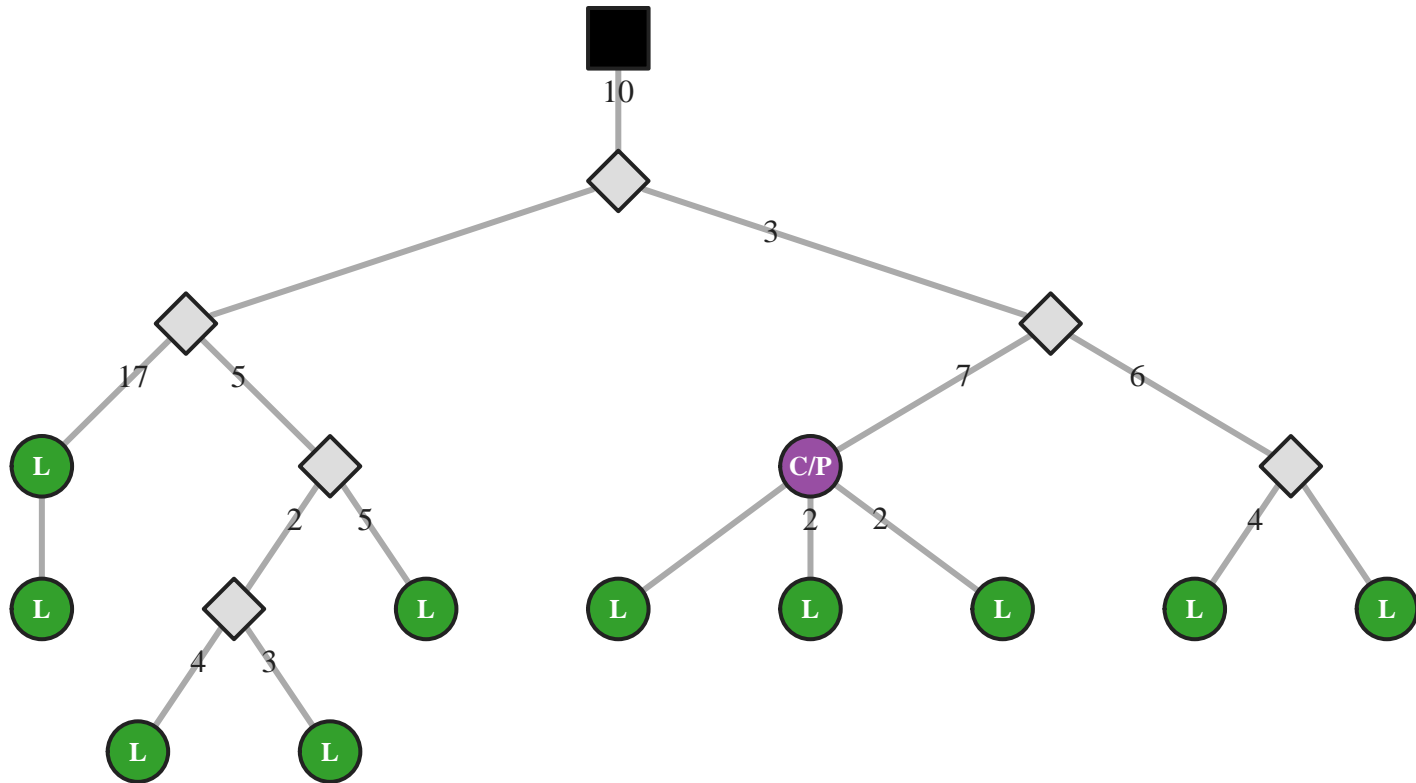

M5 IgG IGHV4-4/J6 54bp (10112)

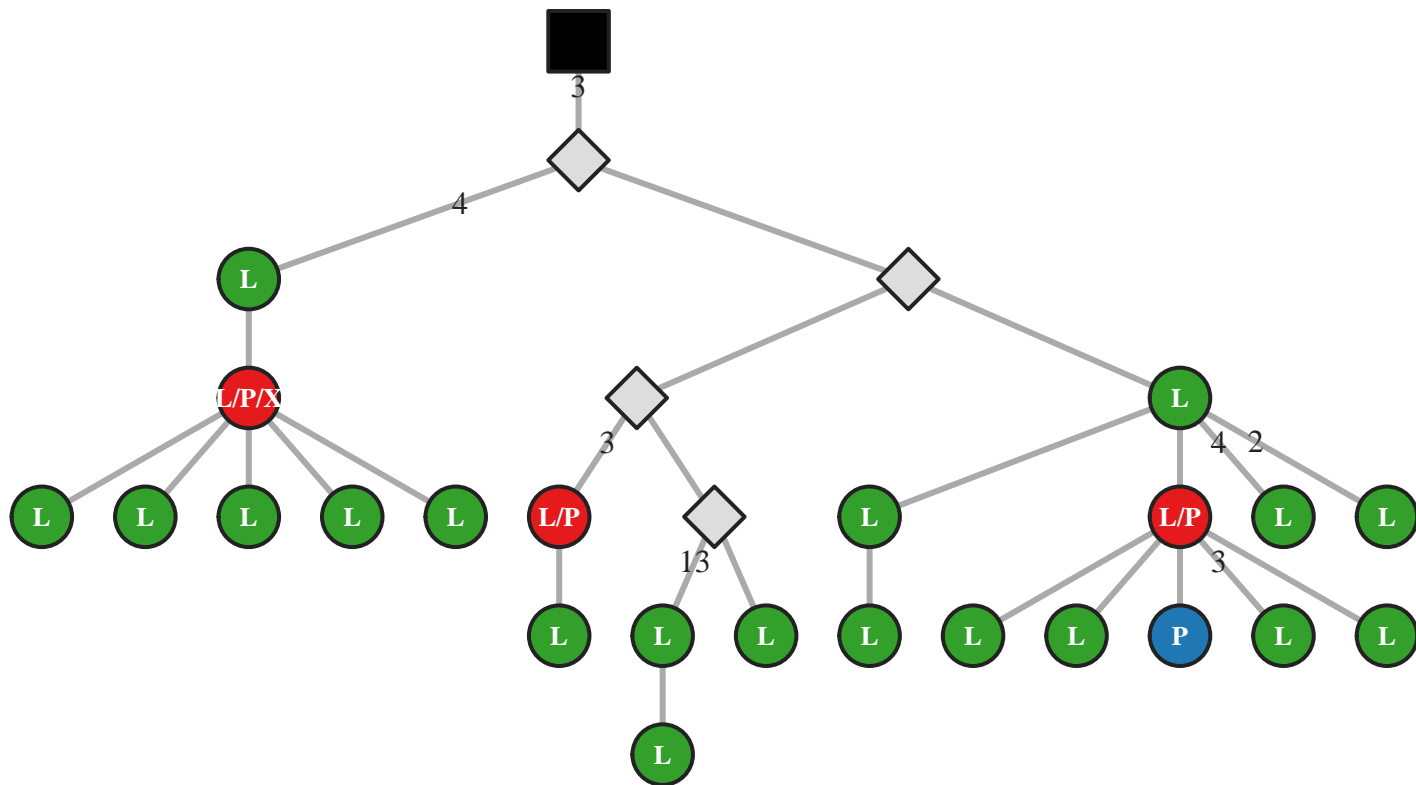

M5 IgG IGHV4-4/J6 57bp (46726)

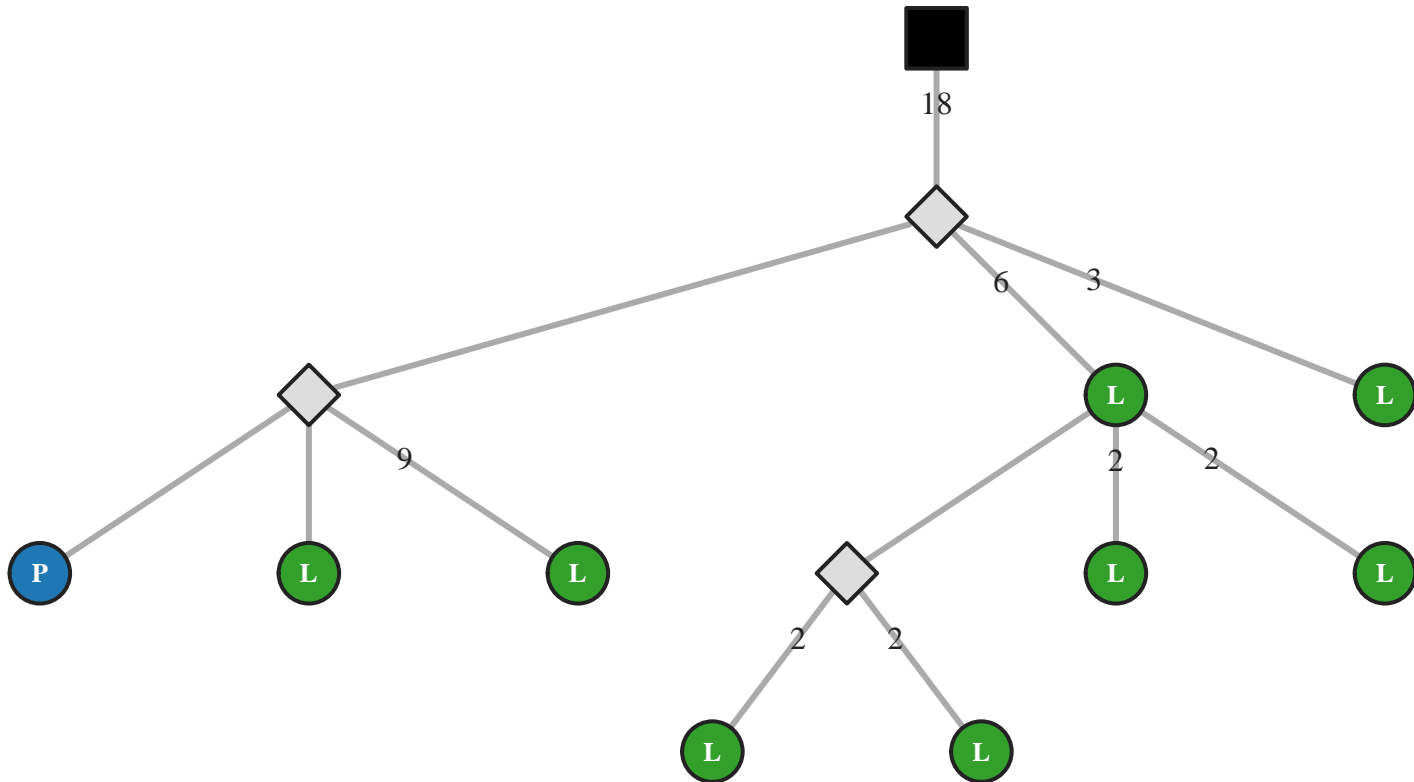

M5 IgG IGHV4-4/J6 63bp (53177)

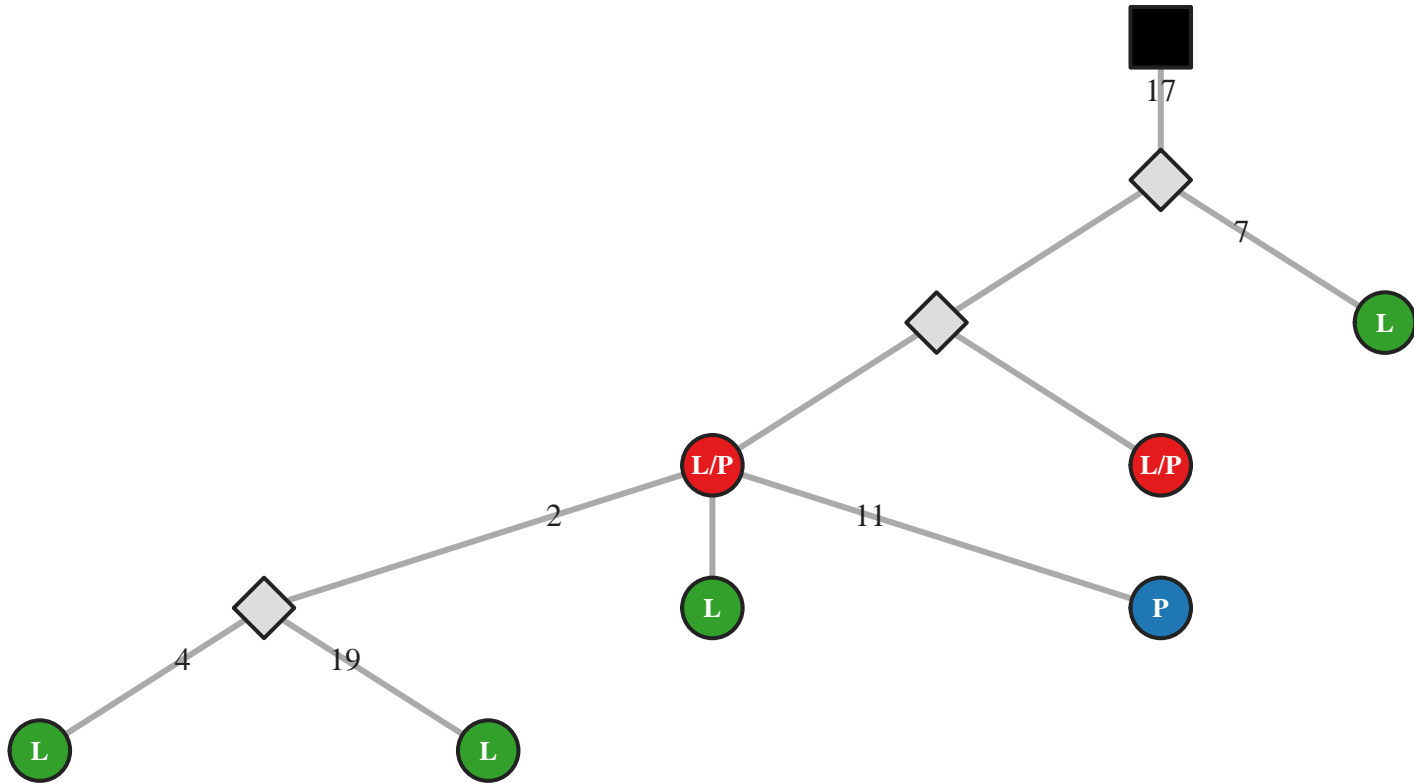

M5 IgG IGHV4-4/J6 69bp (36500)

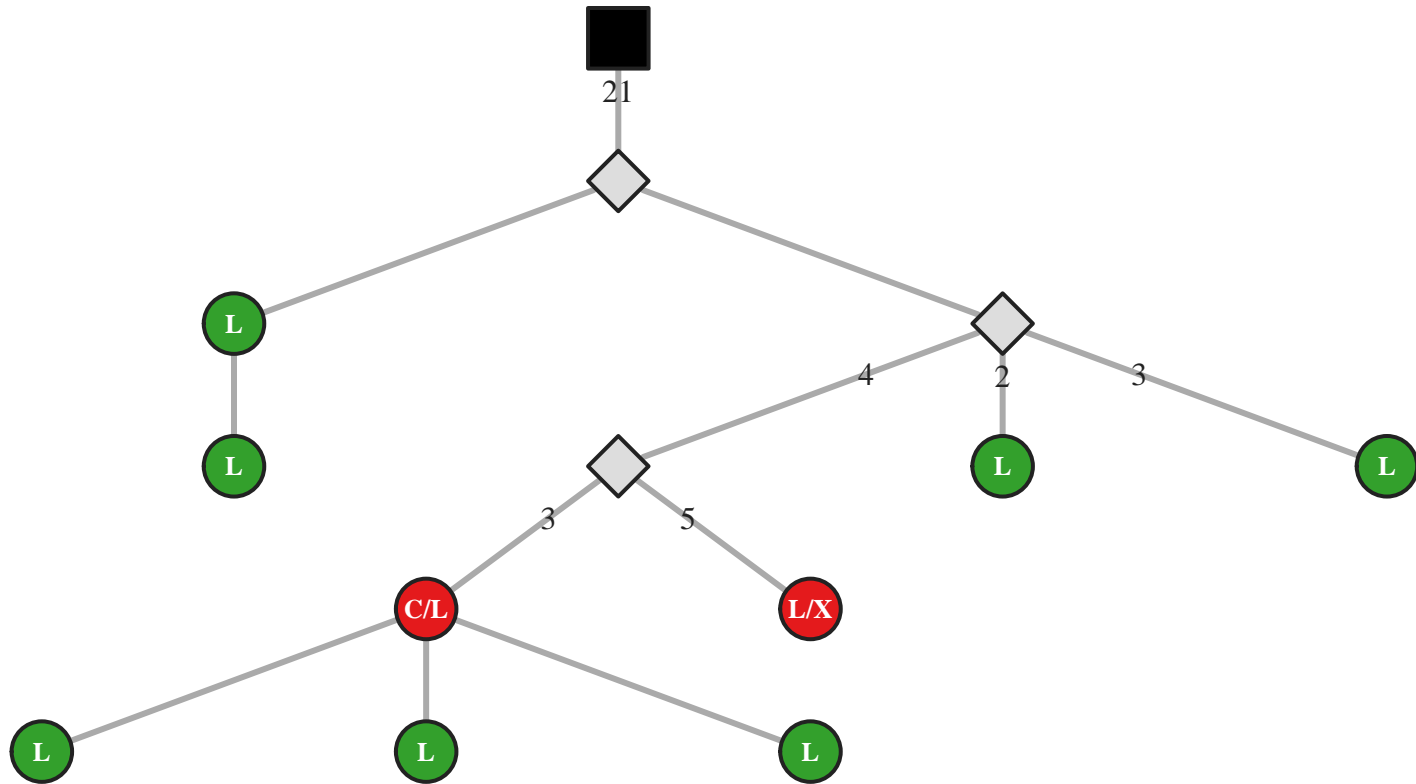

M5 IgG IGHV4-4/J6 72bp (53199)

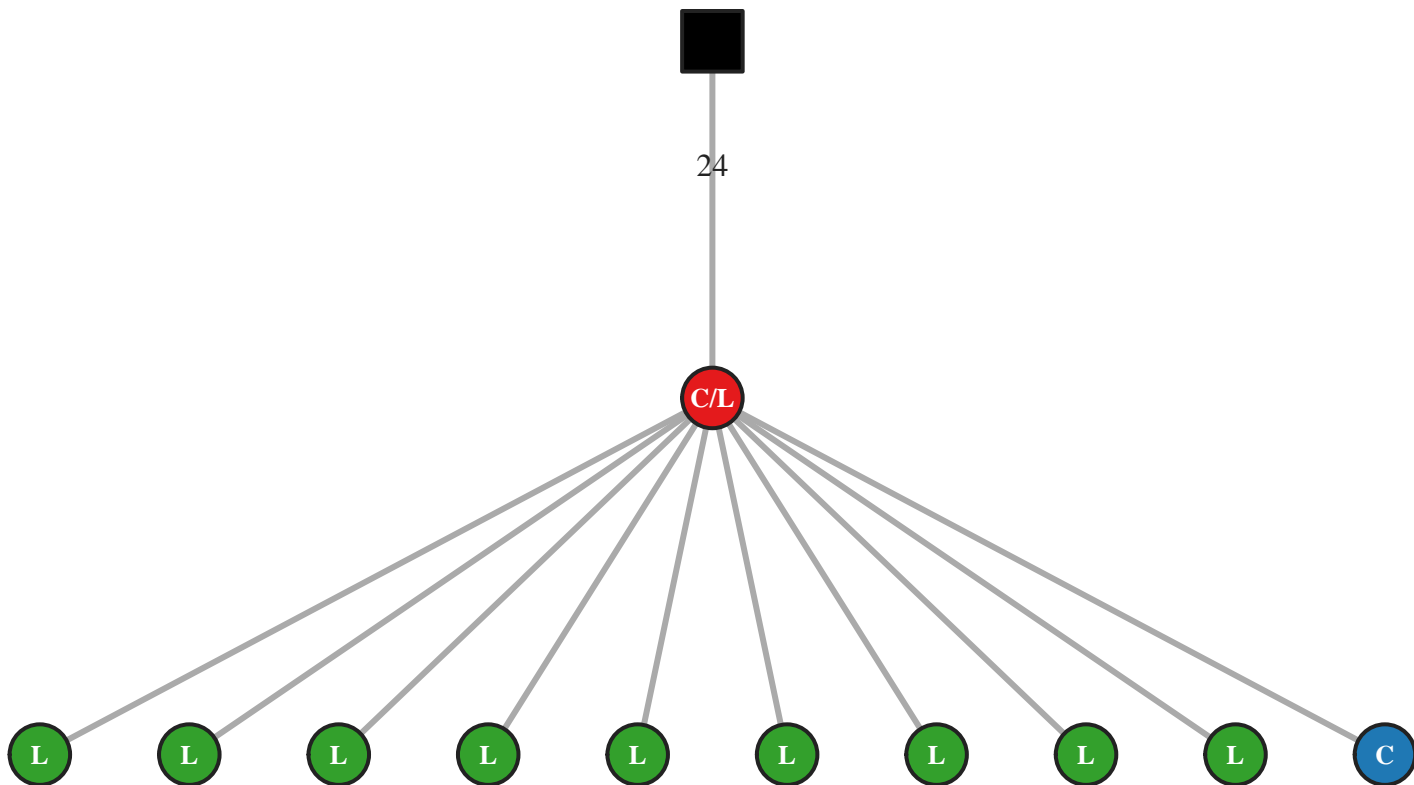

M5 IgG IGHV4-59/J1 27bp (46771)

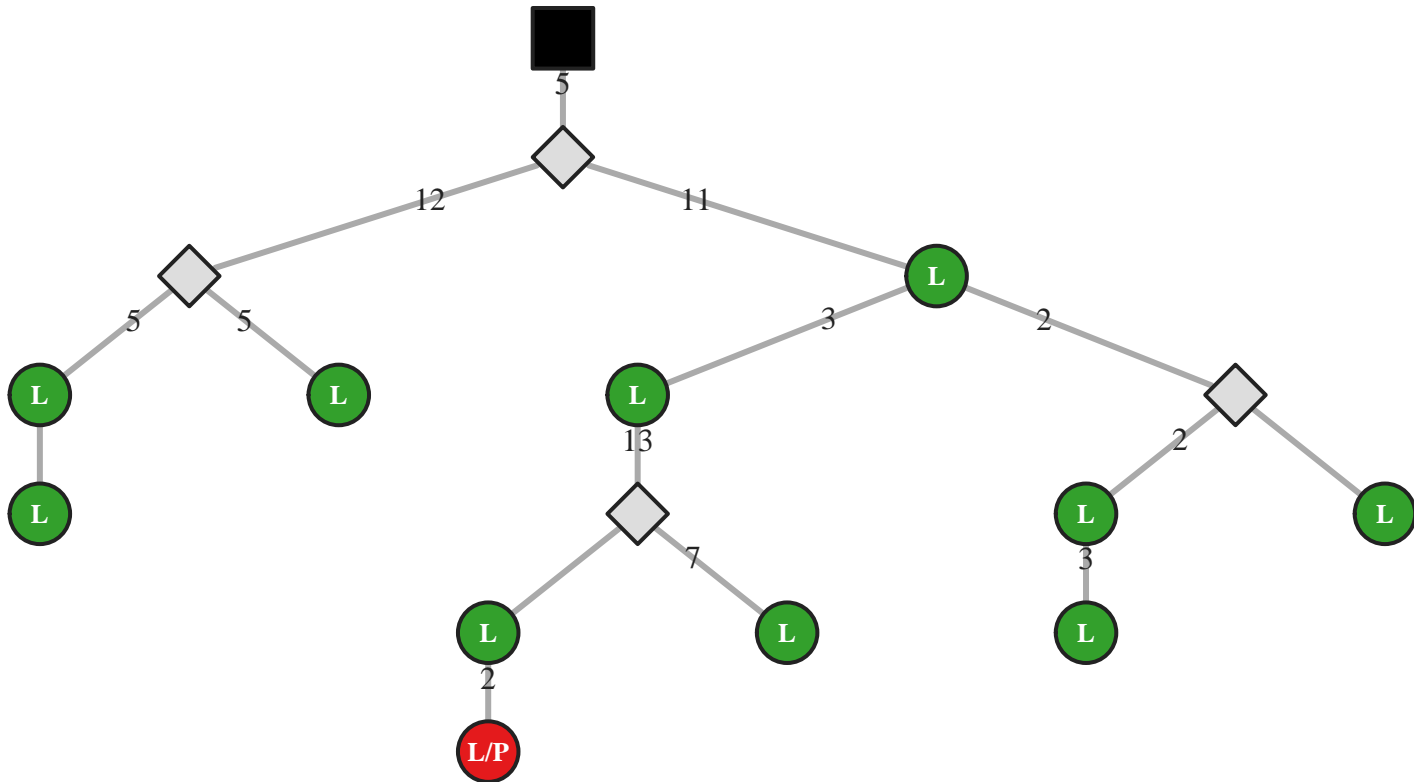

M5 IgG IGHV4-59/J2 48bp (28608)

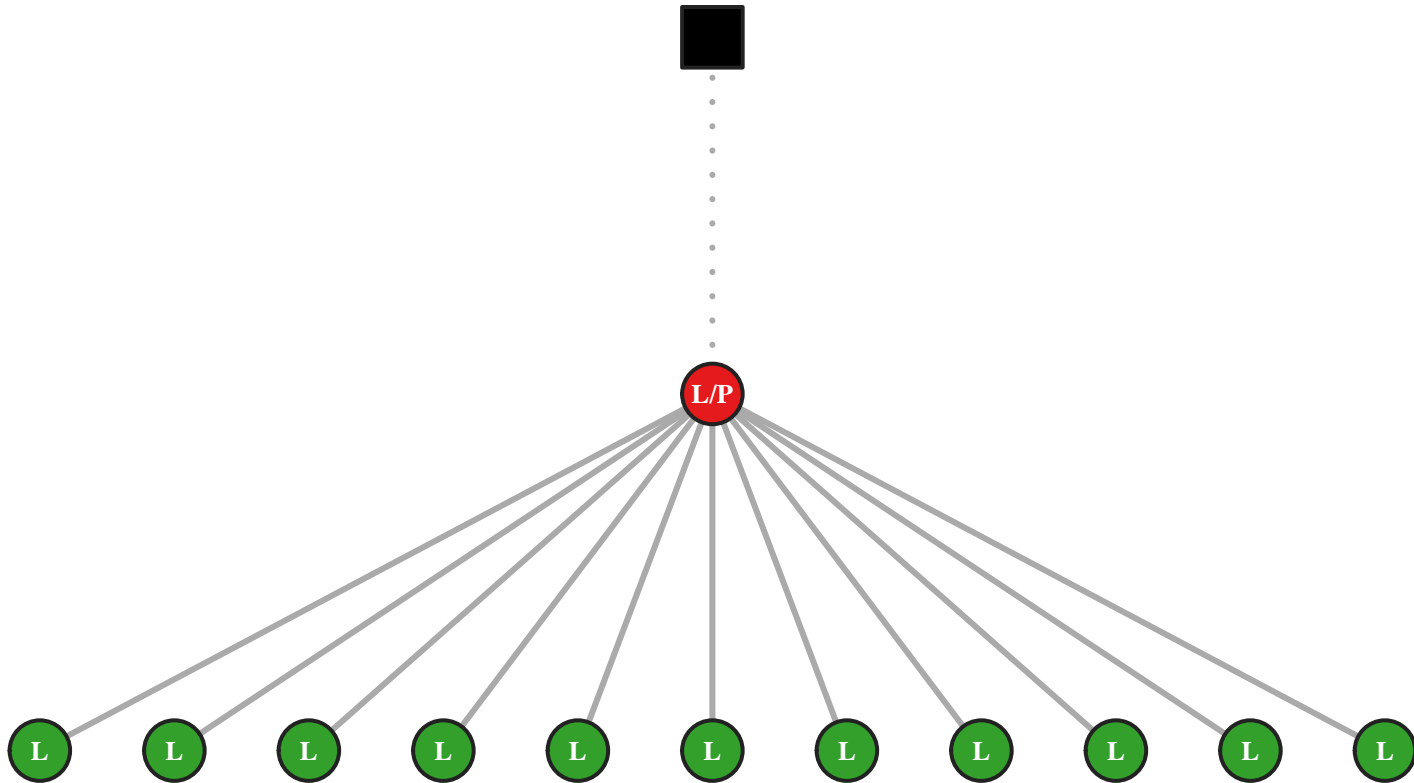

M5 IgG IGHV4-59/J2 63bp (10135)

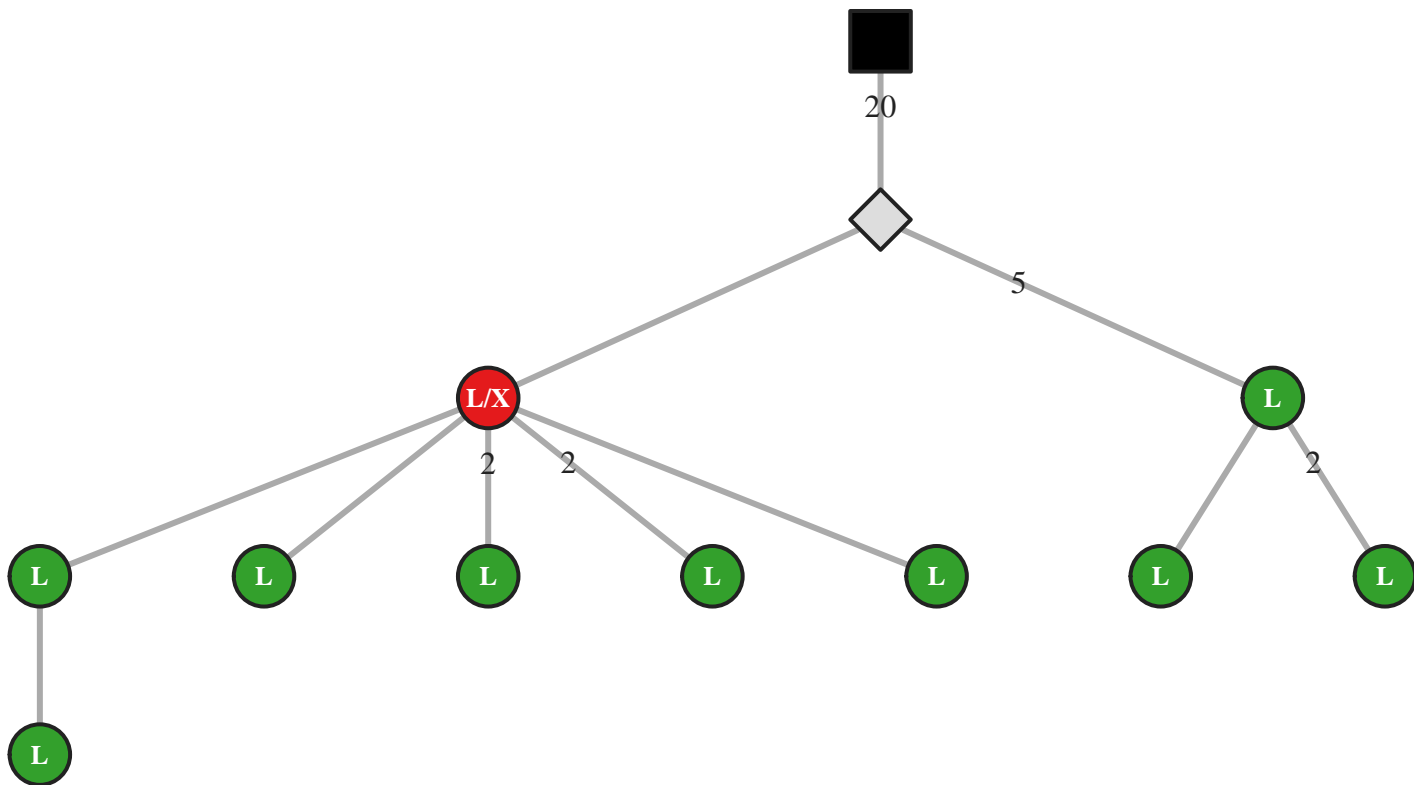

M5 IgG IGHV4-59/J3 45bp (10184)

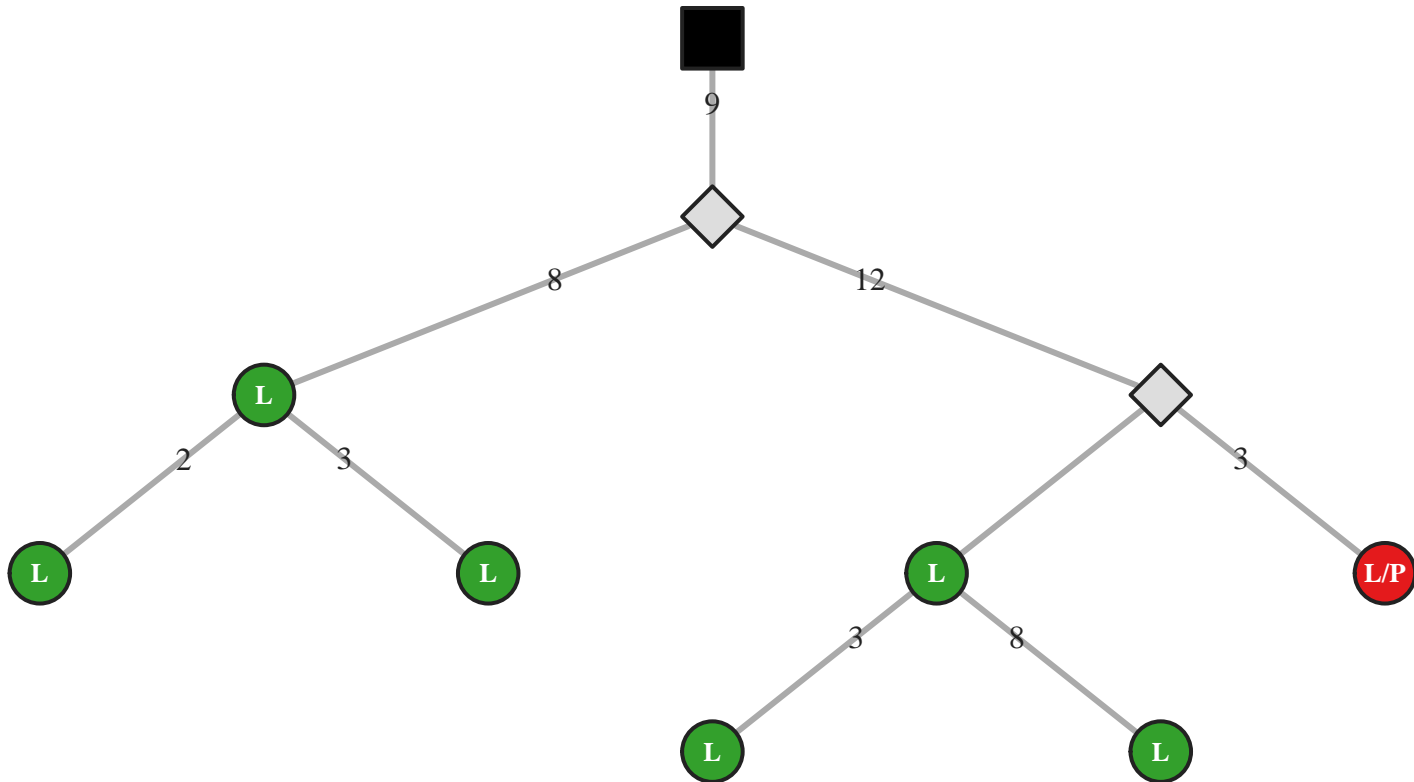

M5 IgG IGHV4-59/J3 48bp (19204)

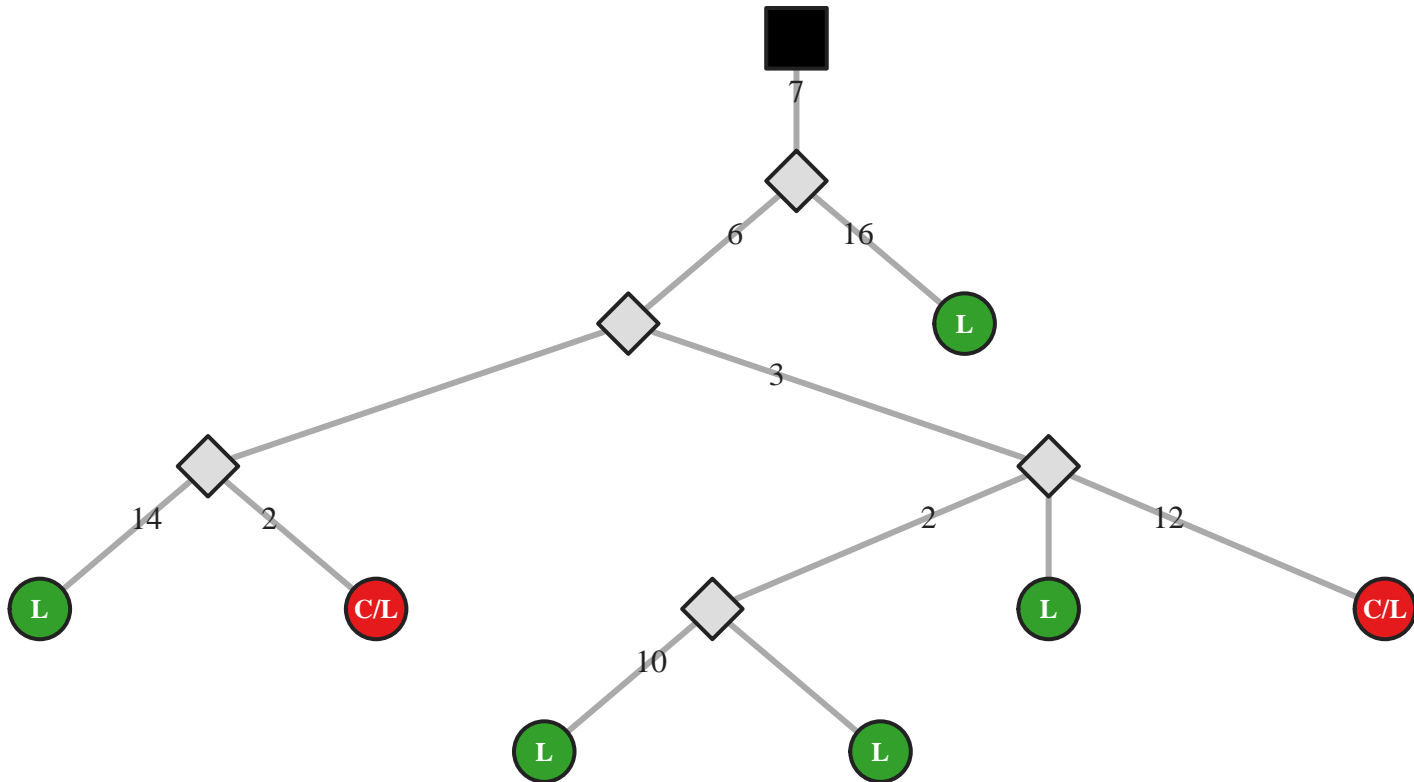

M5 IgG IGHV4-59/J3 48bp (19223)

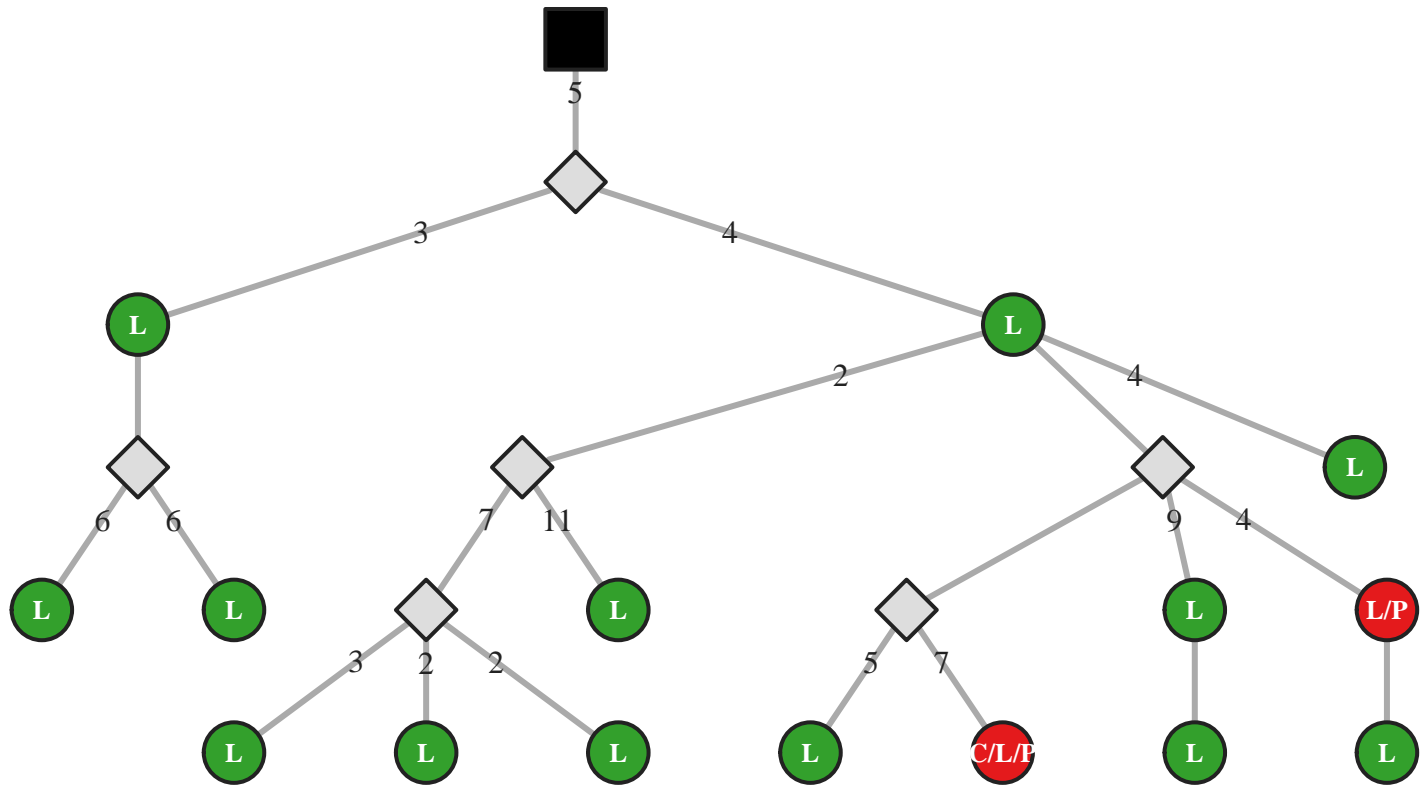

M5 IgG IGHV4-59/J3 51bp (36530)

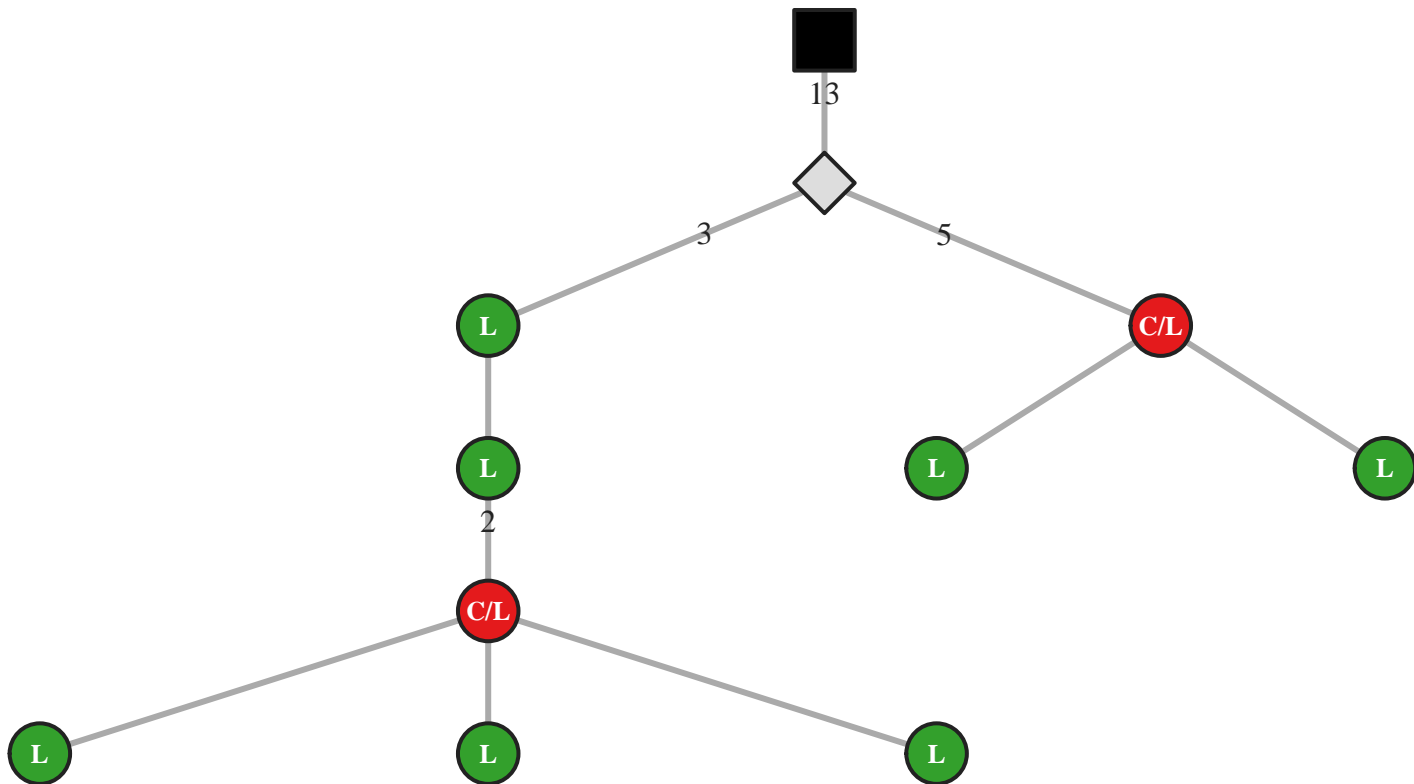

M5 IgG IGHV4-59/J3 60bp (19234)

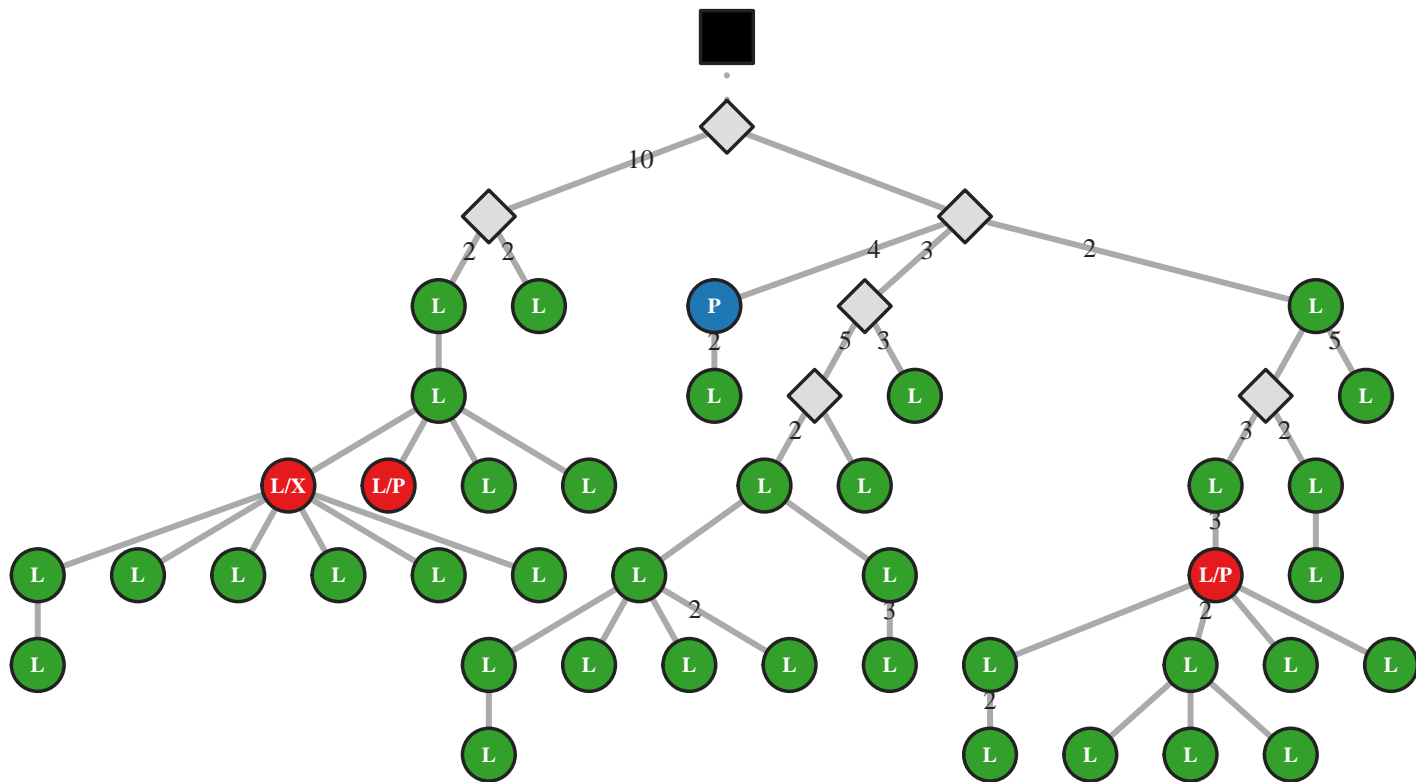

M5 IgG IGHV4-59/J4 30bp (19448)

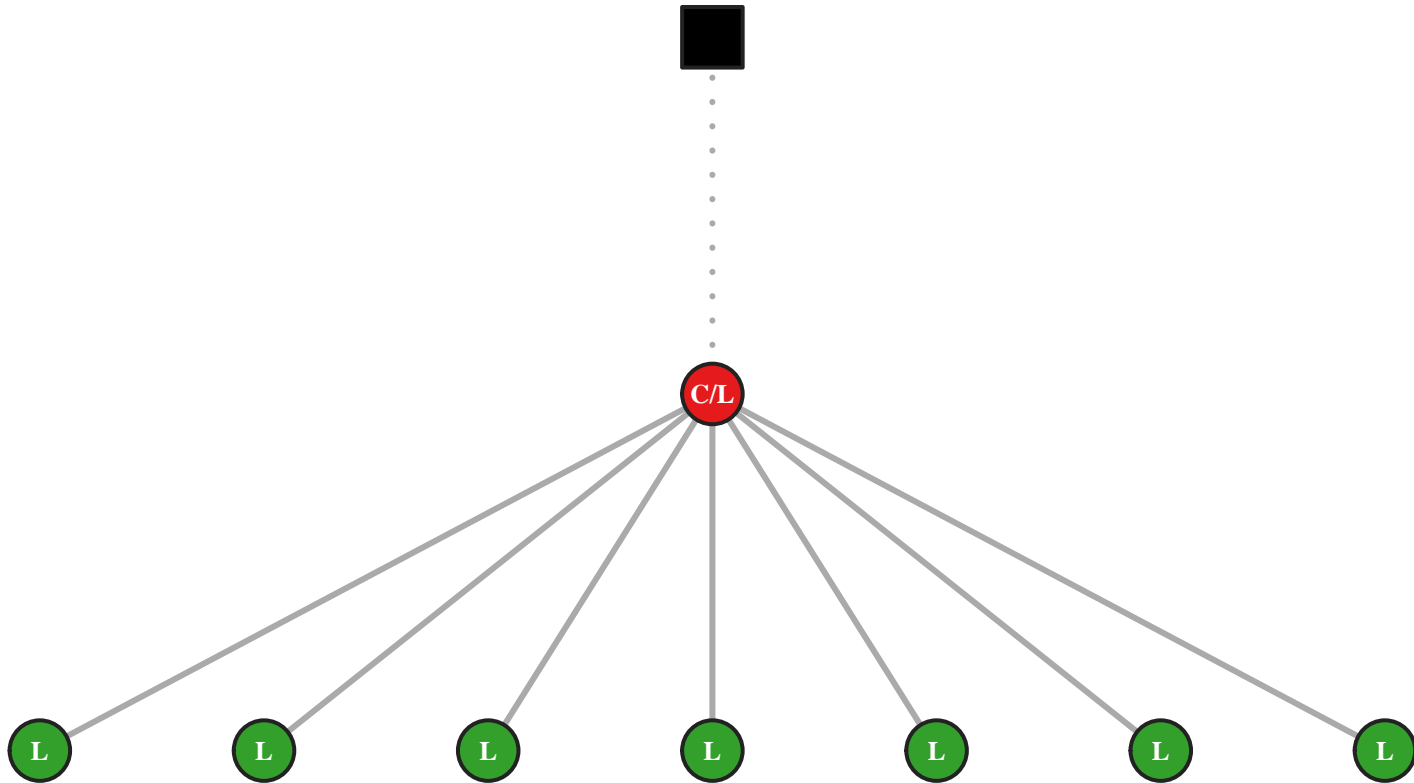

M5 IgG IGHV4-59/J4 36bp (53204)

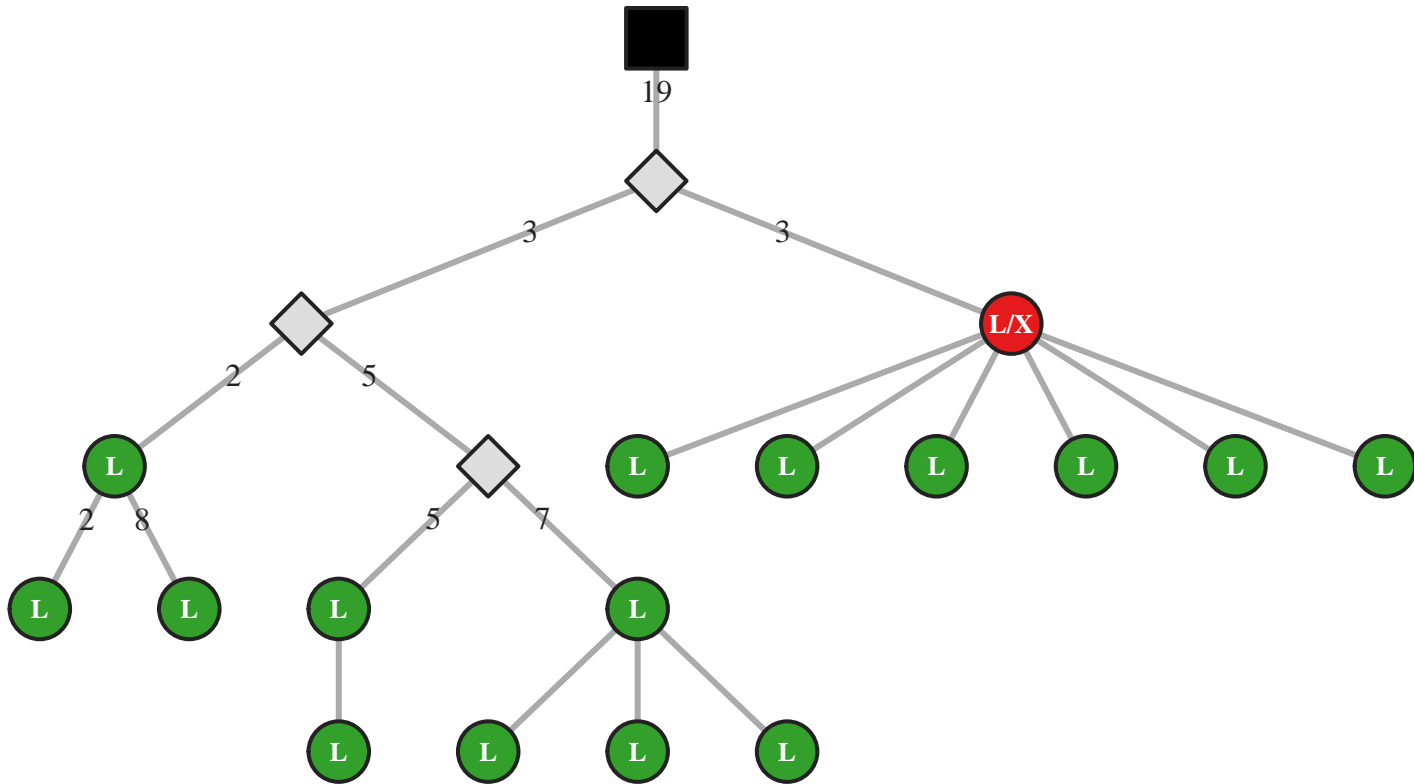

M5 IgG IGHV4-59/J4 36bp (53206)

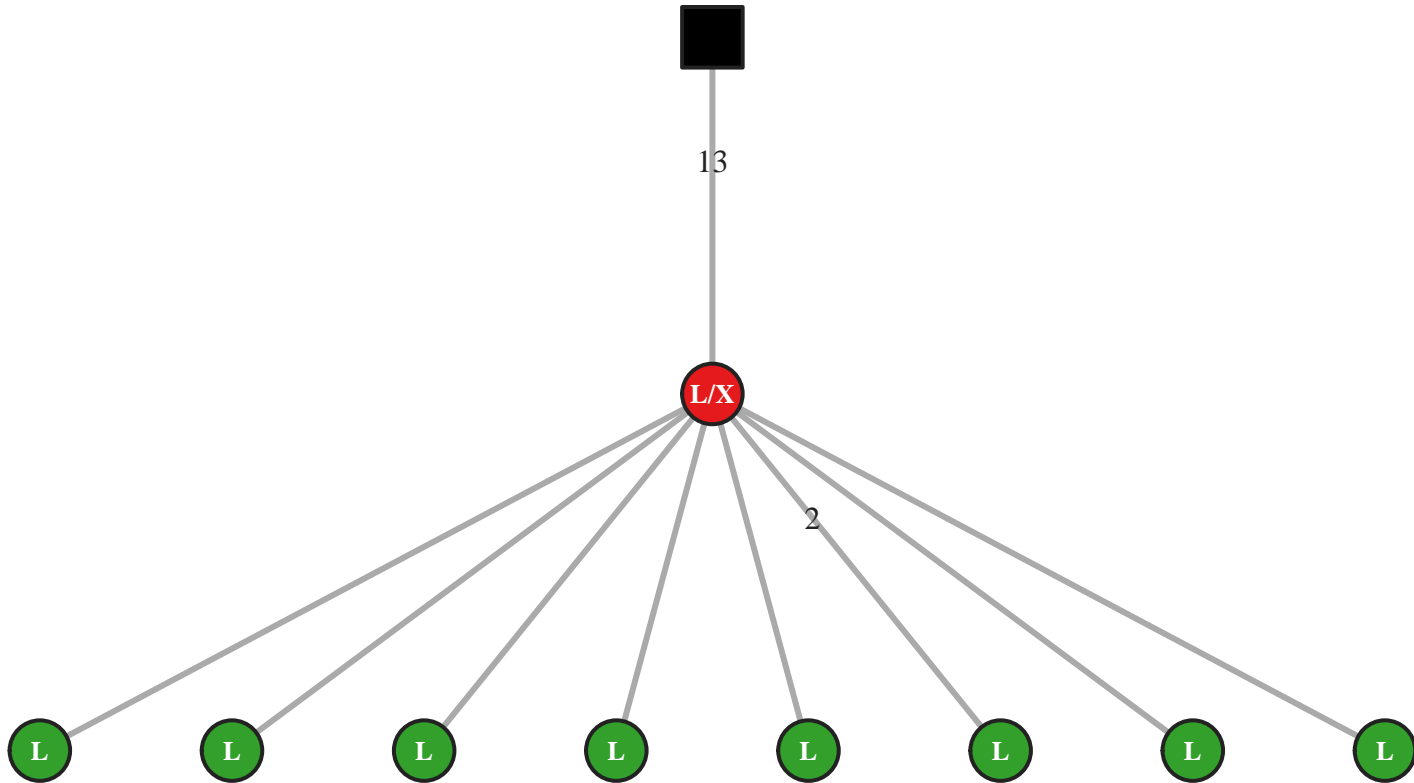

M5 IgG IGHV4-59/J4 36bp (53234)

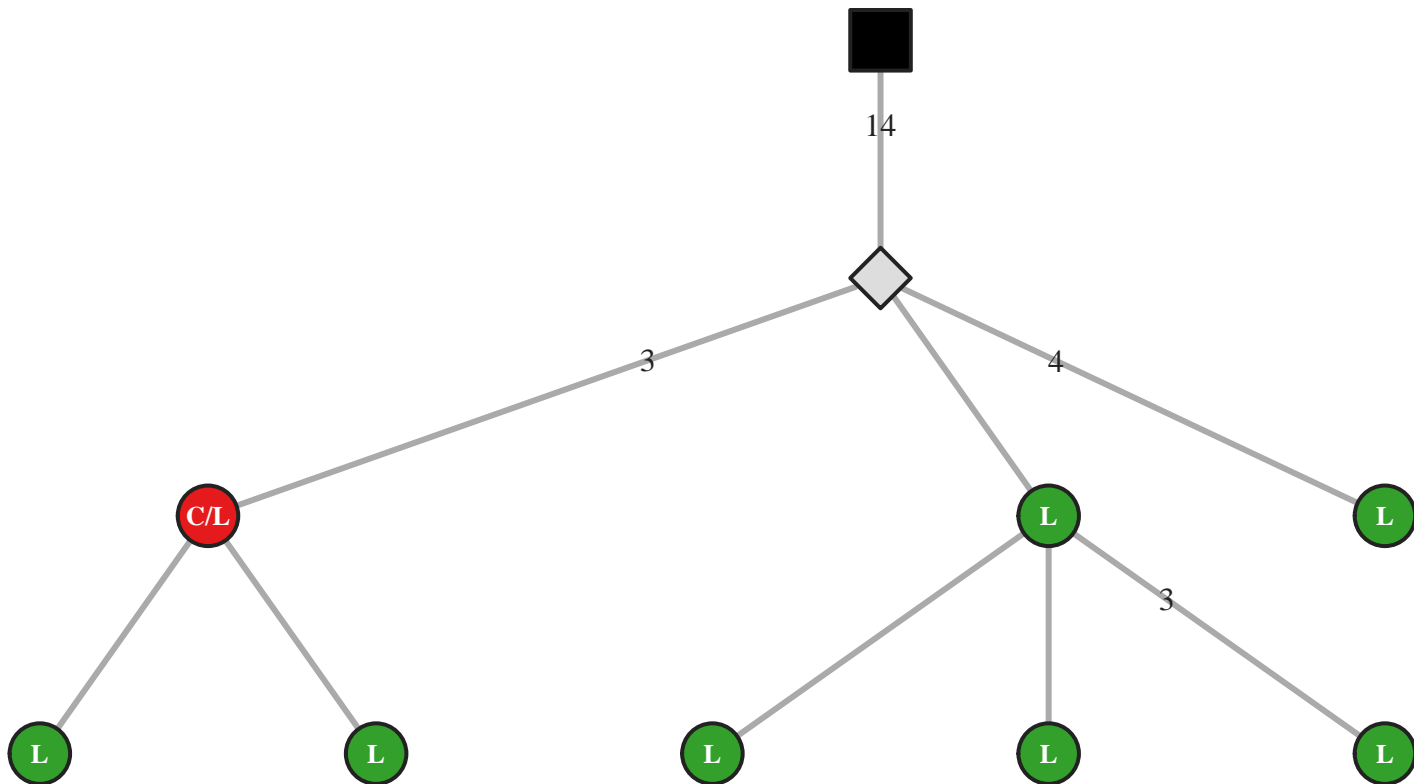

M5 IgG IGHV4-59/J4 36bp (53255)

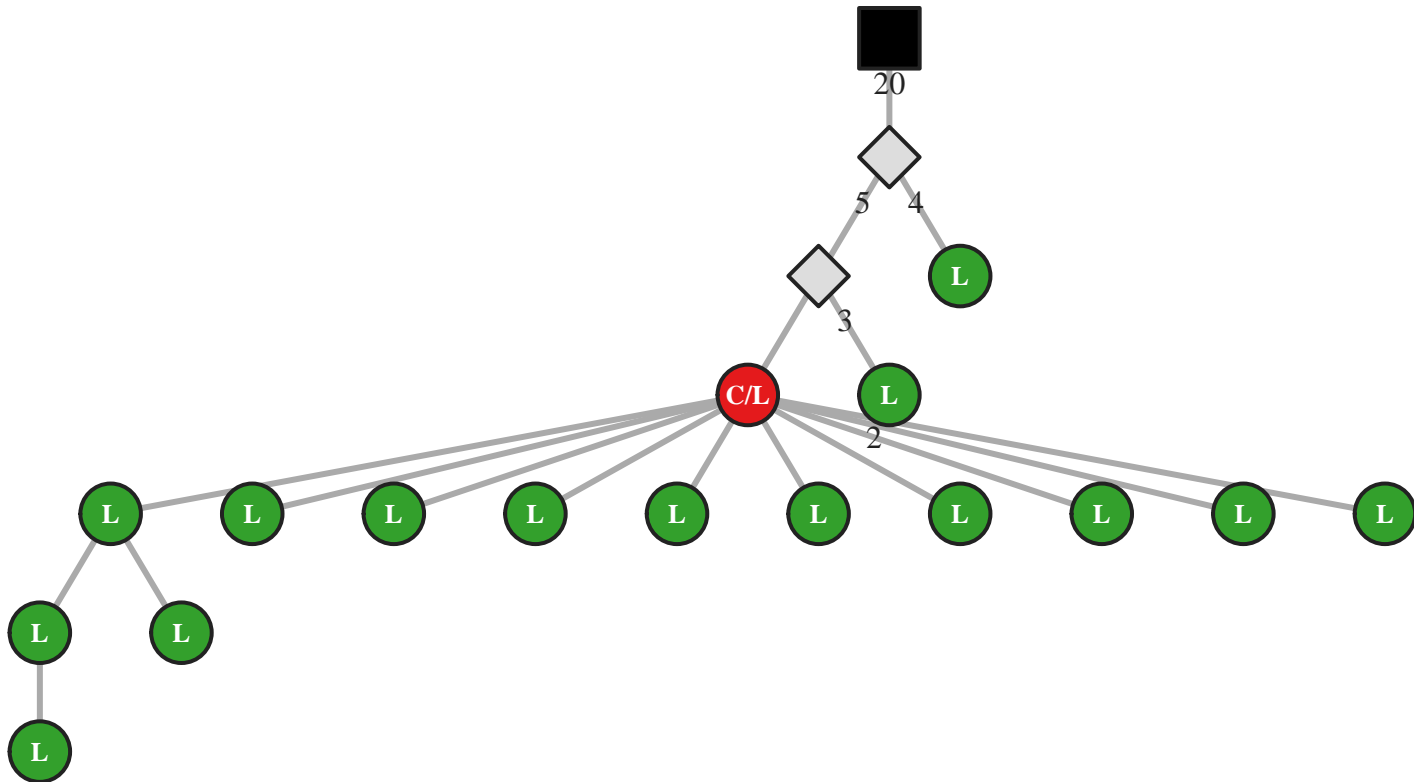

M5 IgA IGHV4-59/J4 39bp (39054)

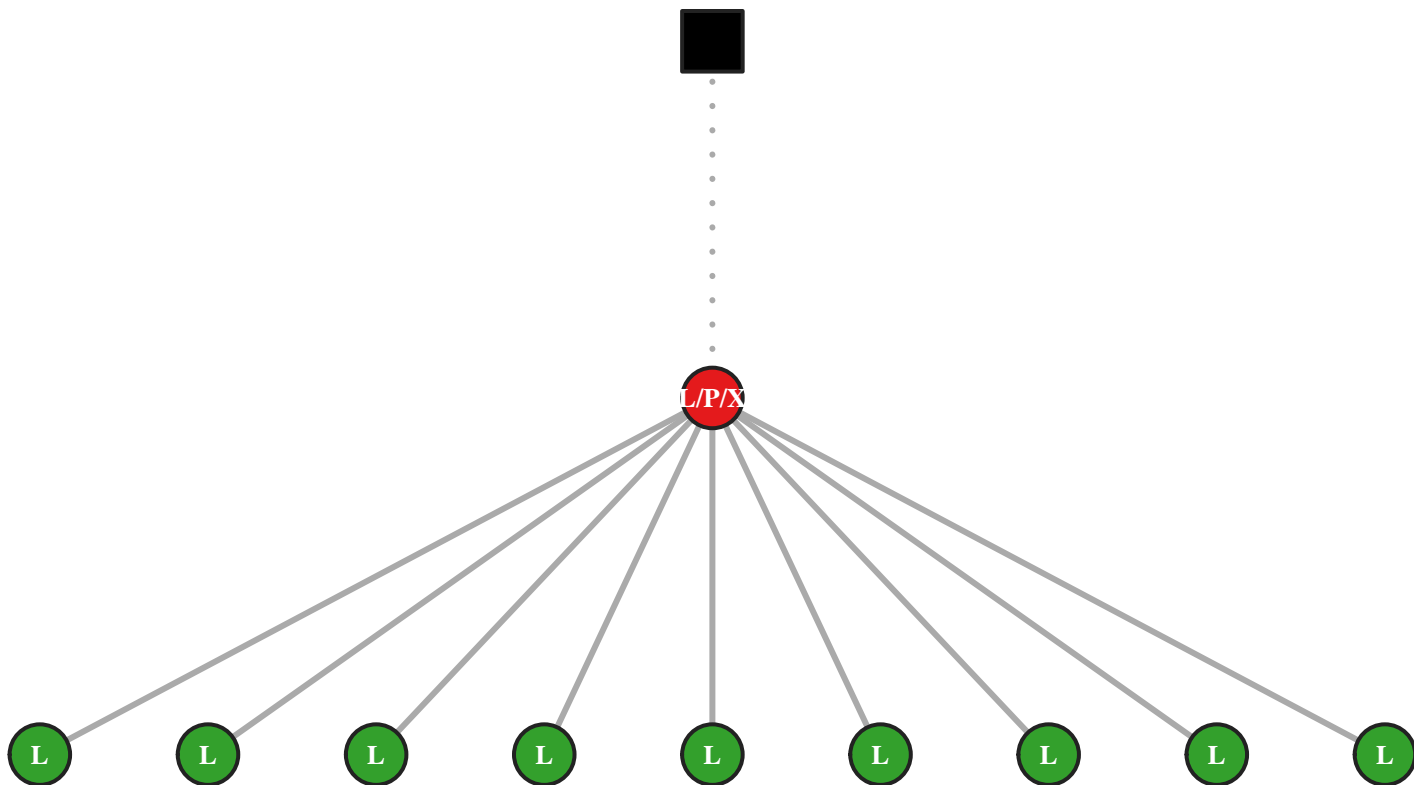

M5 IgG IGHV4-59/J4 39bp (28176)

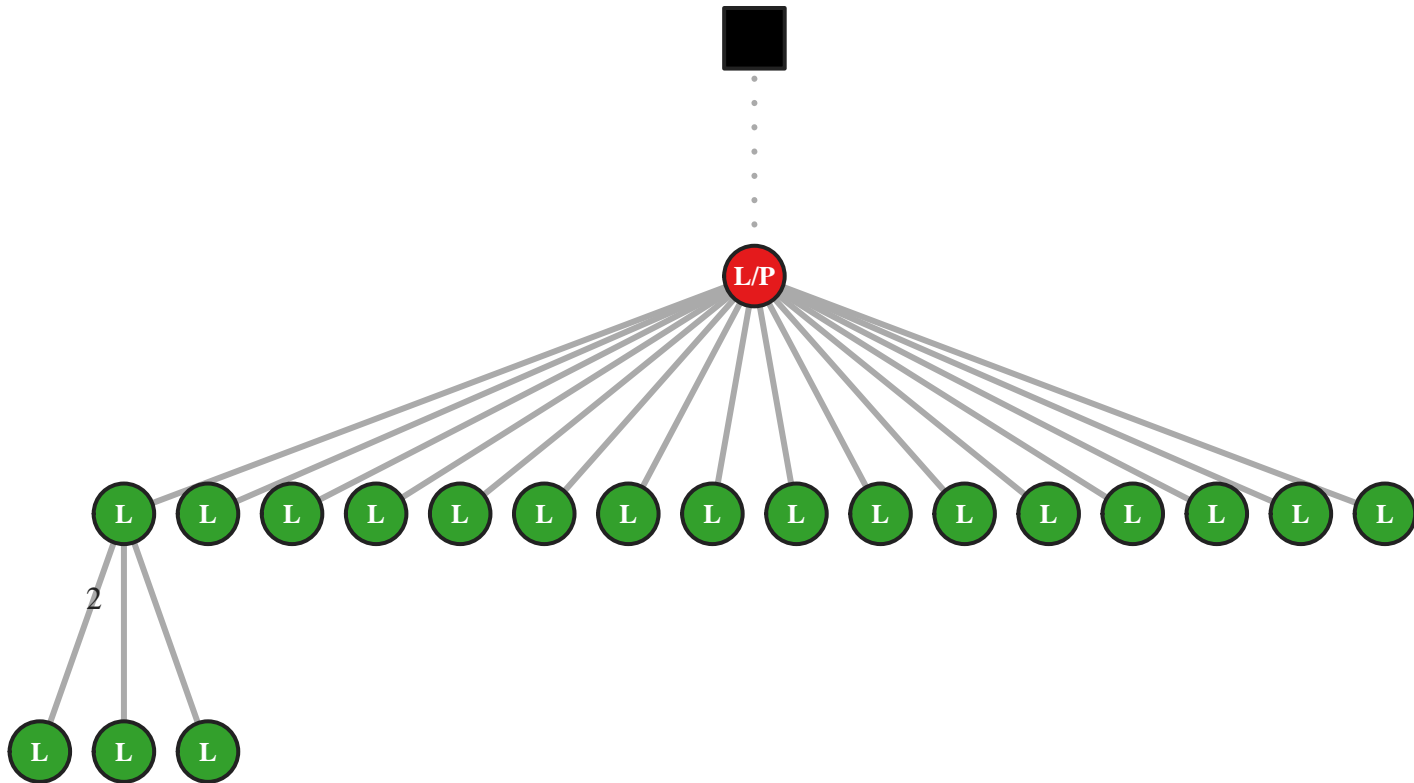

M5 IgG IGHV4-59/J4 39bp (28181)

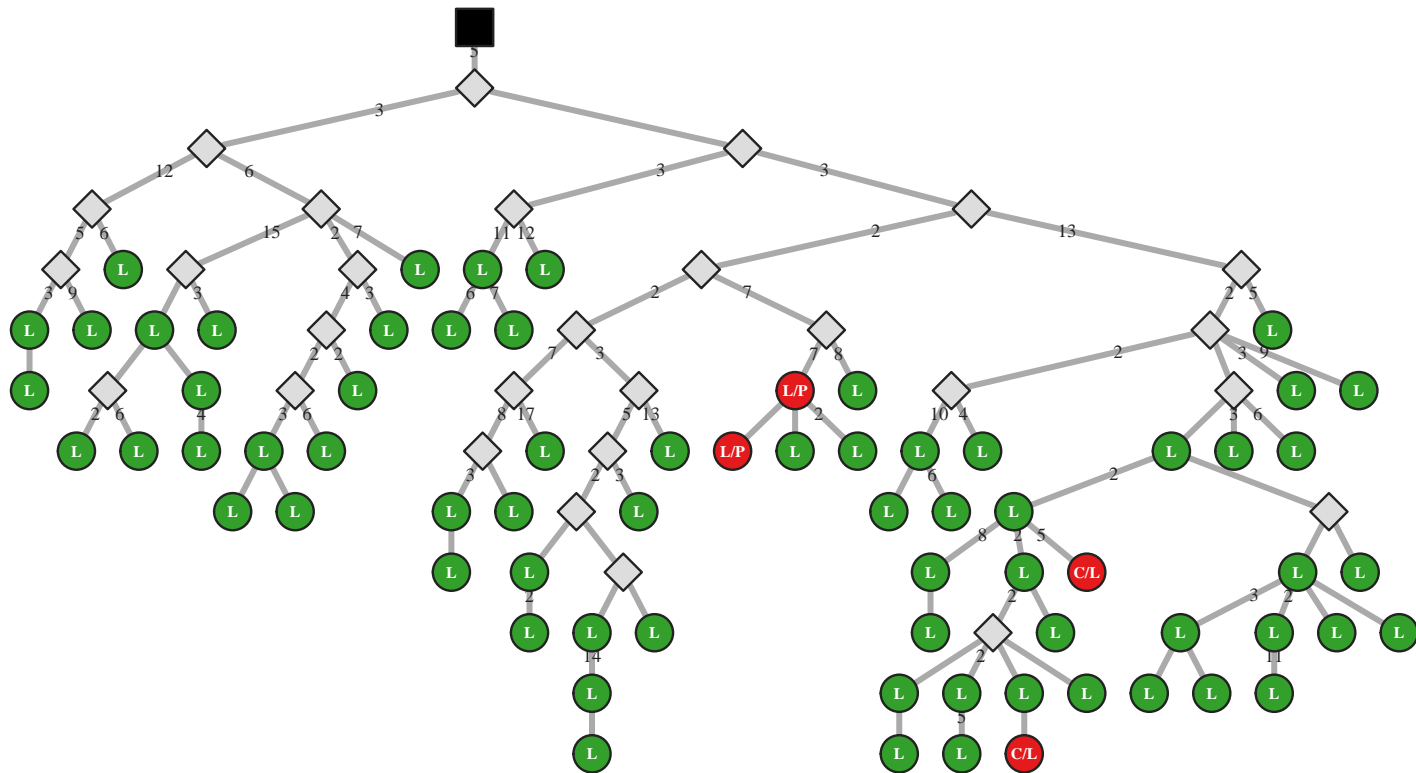

M5 IgA IGHV4-59/J4 42bp (49015)

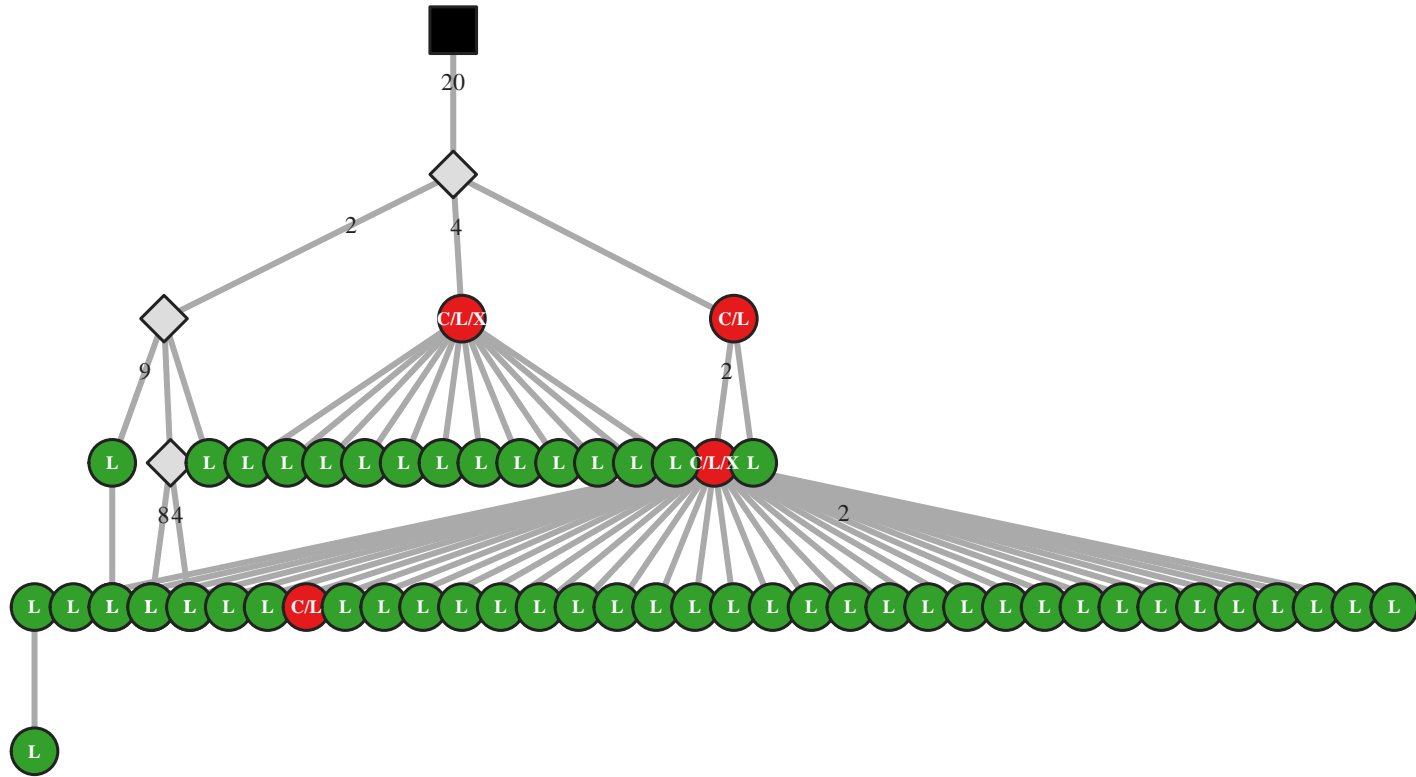

M5 IgG IGHV4-59/J4 42bp (53274)

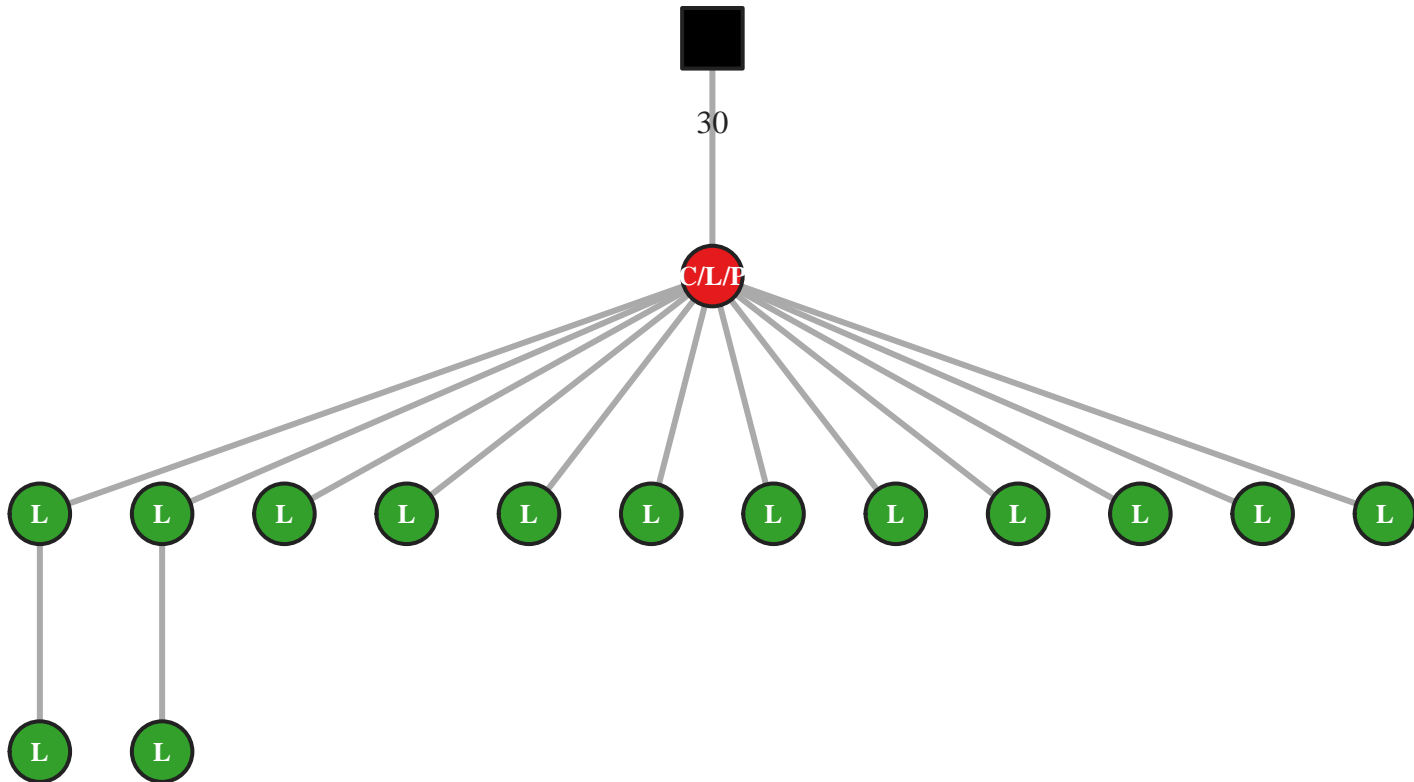

M5 IgG IGHV4-59/J4 42bp (53323)

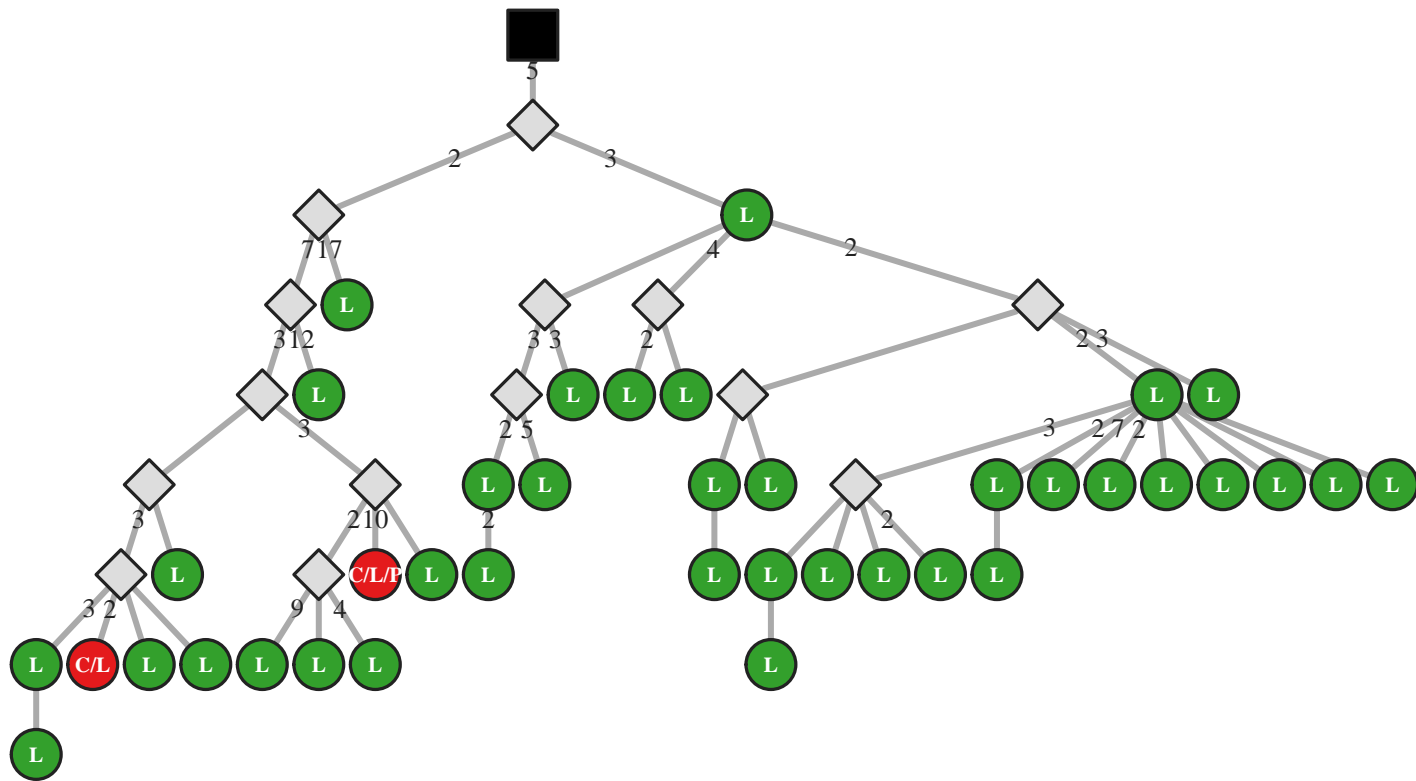

M5 IgG IGHV4-59/J4 42bp (53330)

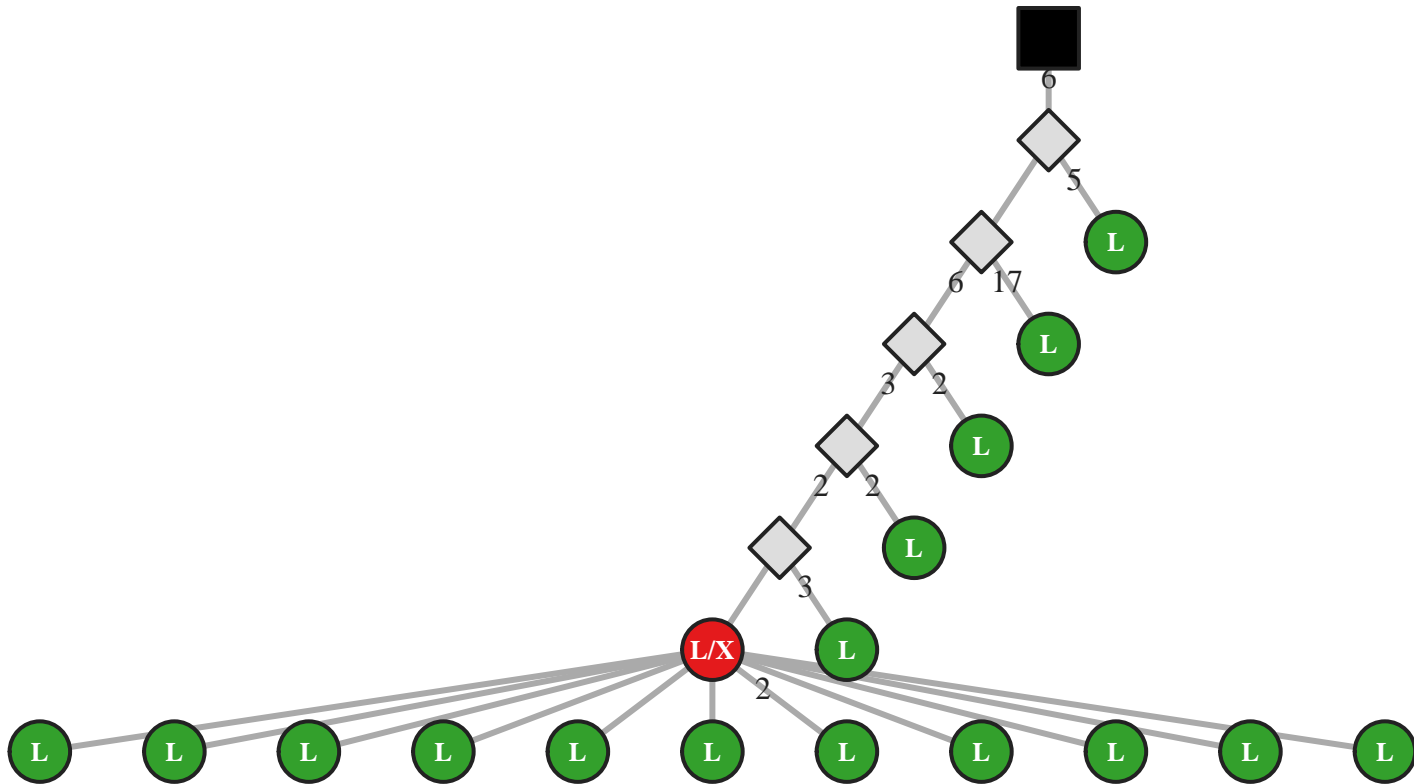

M5 IgG IGHV4-59/J4 42bp (53356)

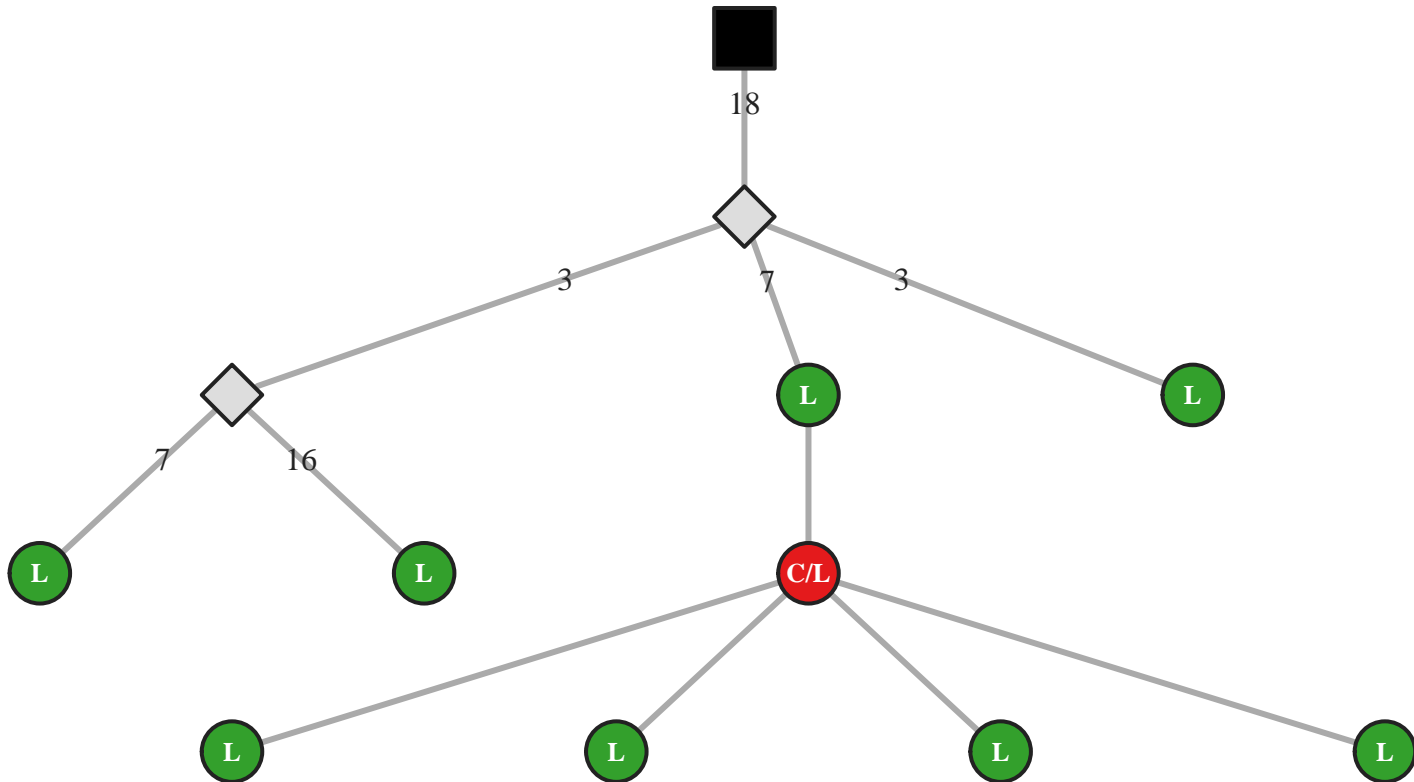

M5 IgG IGHV4-59/J4 42bp (53389)

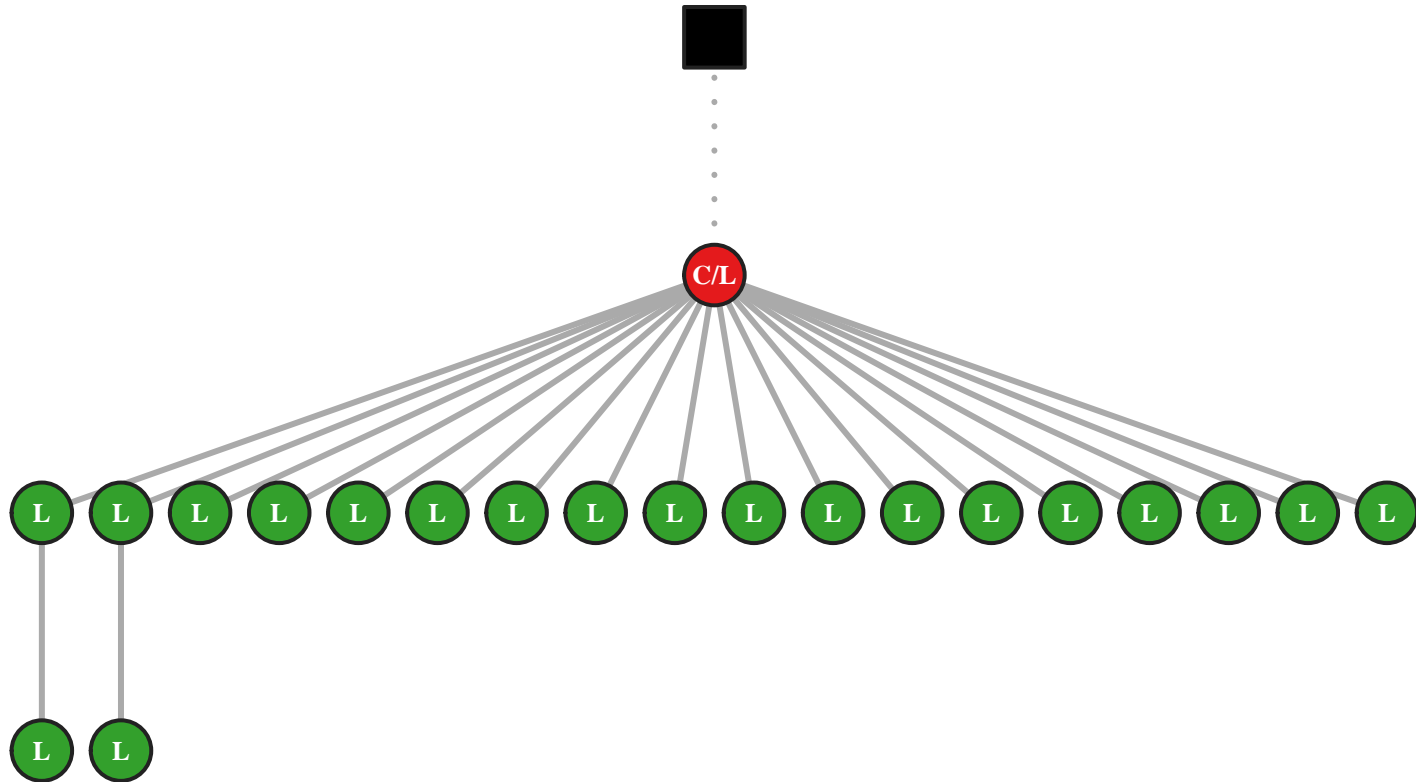

M5 IgA IGHV4-59/J4 45bp (12821)

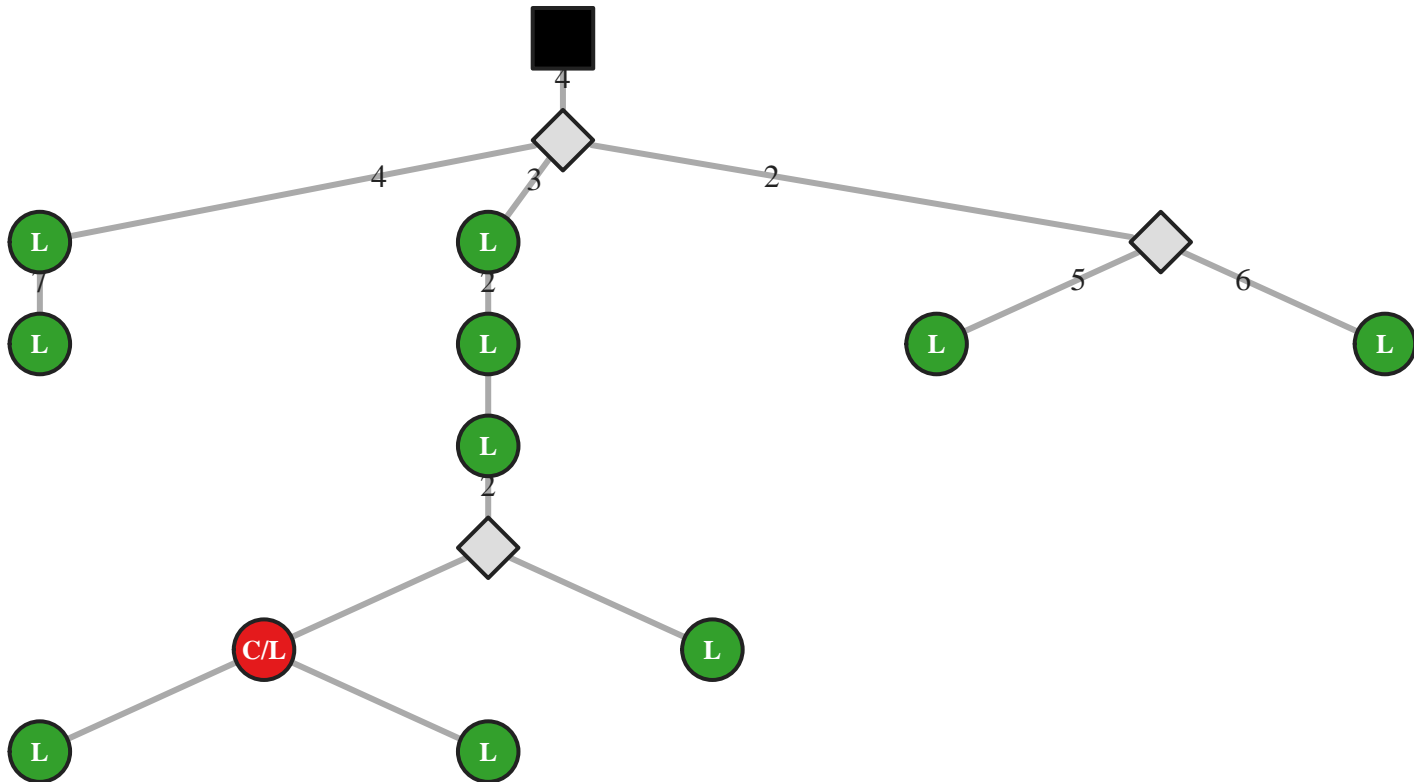

M5 IgG IGHV4-59/J4 48bp (10332)

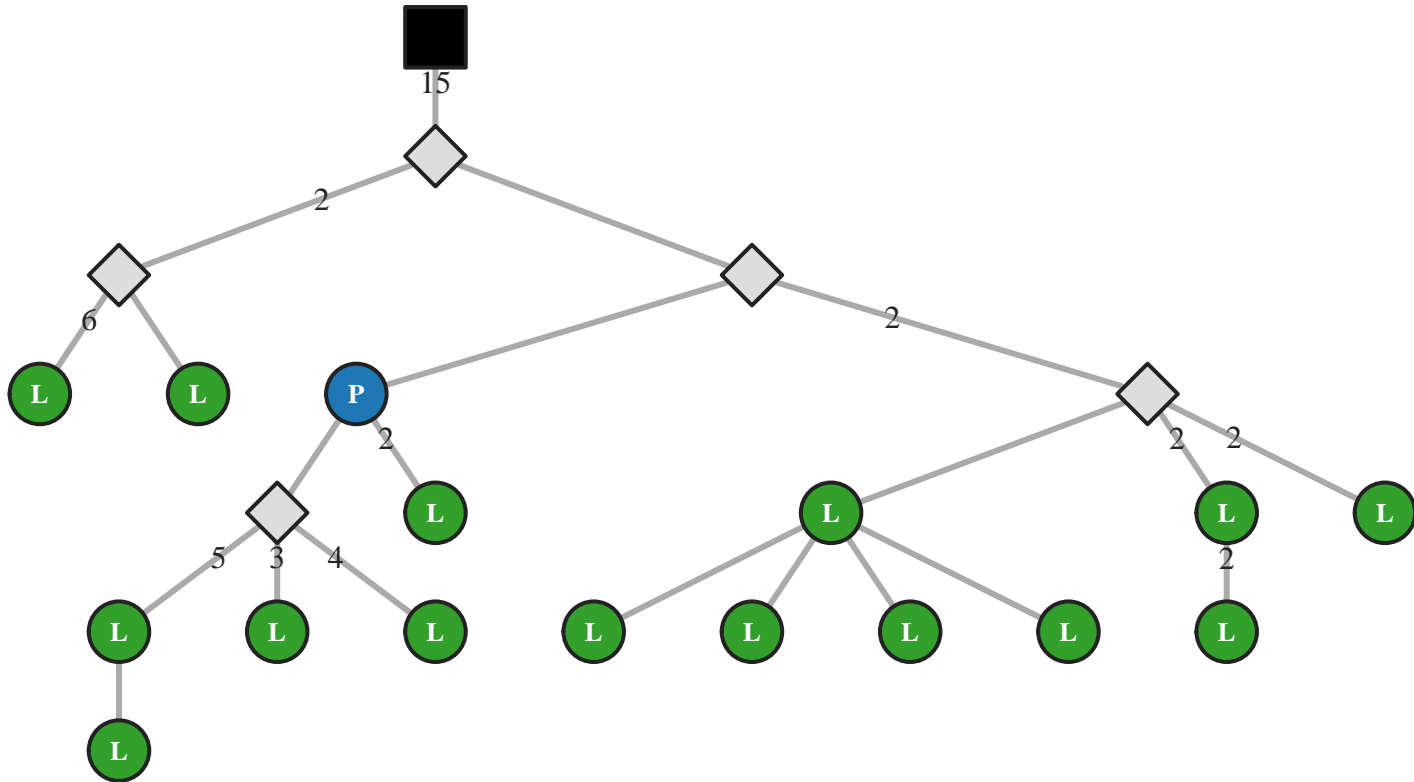

M5 IgG IGHV4-59/J4 48bp (10385)

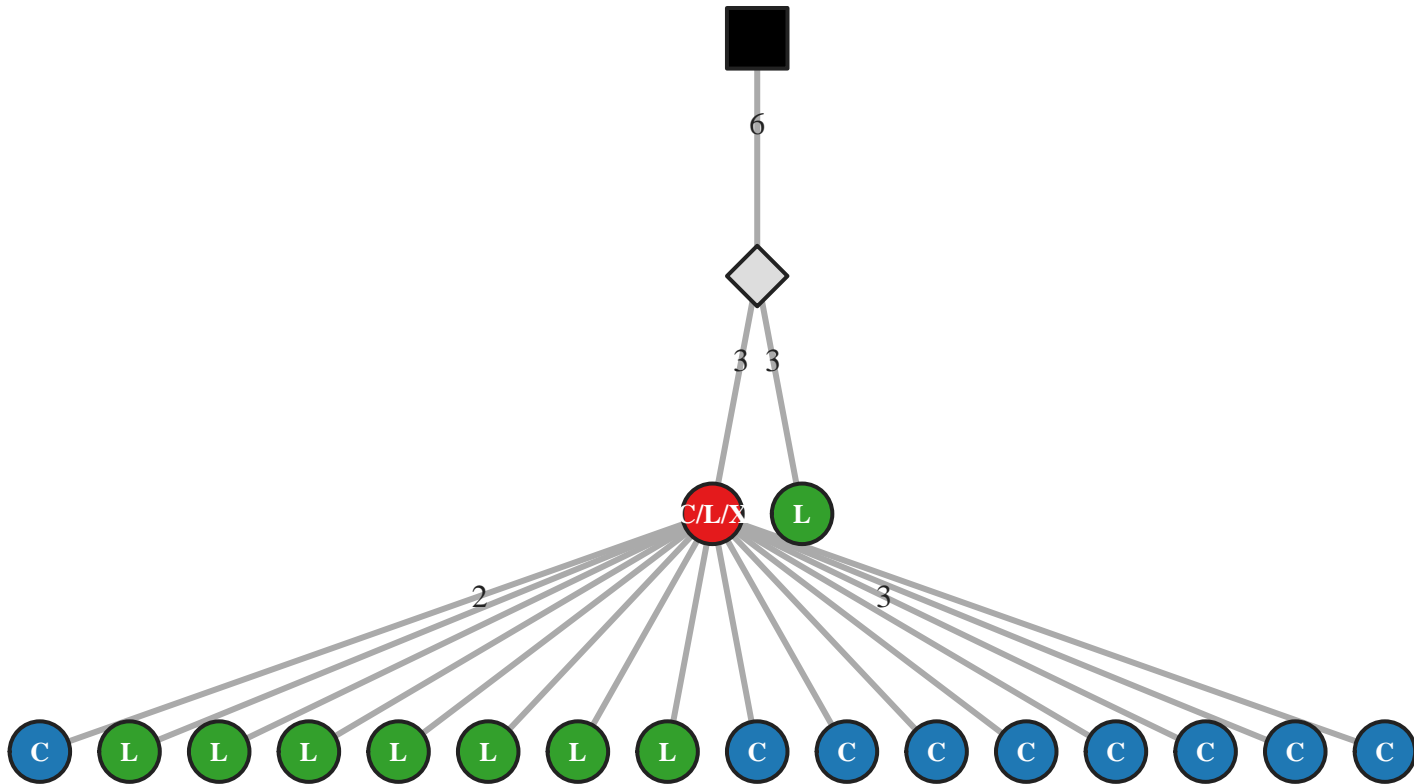

M5 IgG IGHV4-59/J4 54bp (28410)

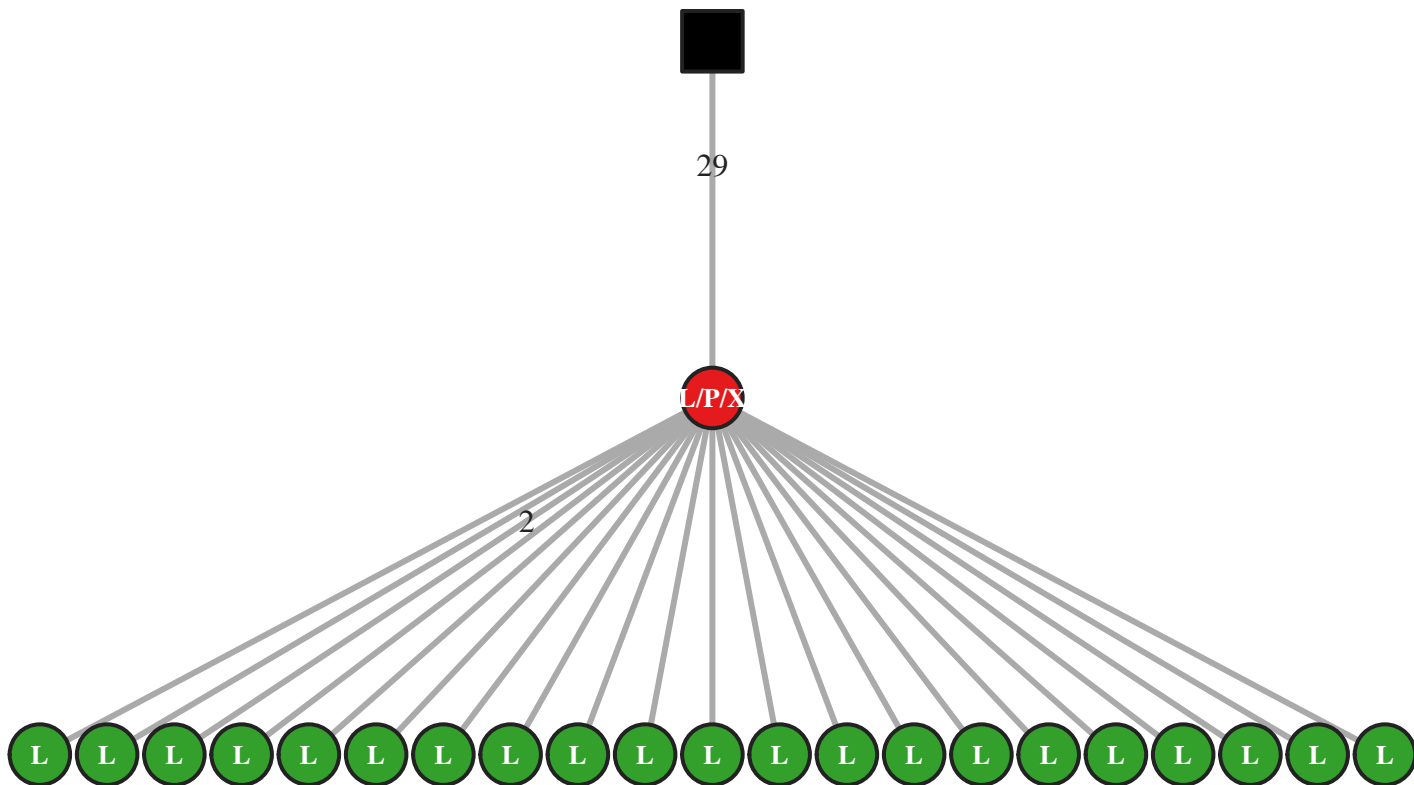

M5 IgA IGHV4-59/J4 57bp (12884)

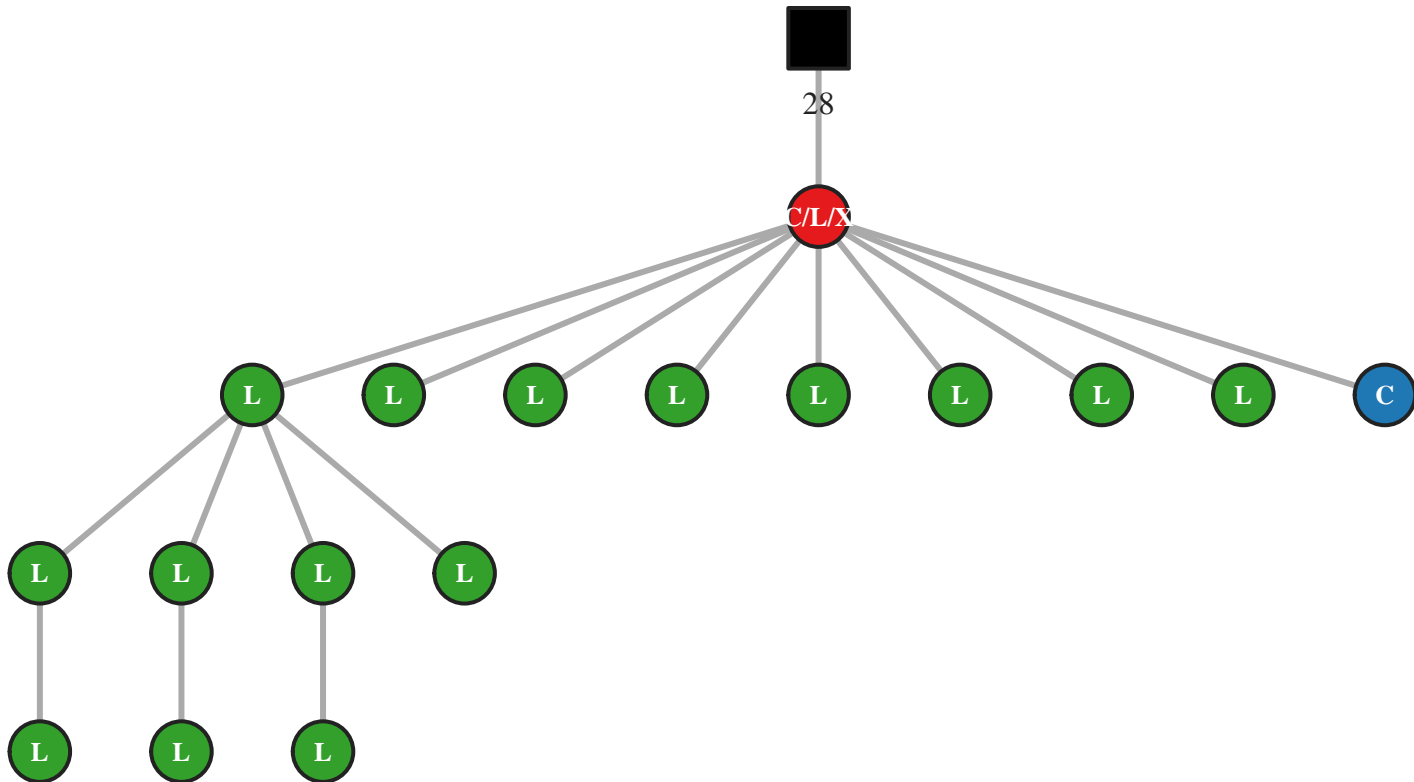

M5 IgG IGHV4-59/J4 57bp (28508)

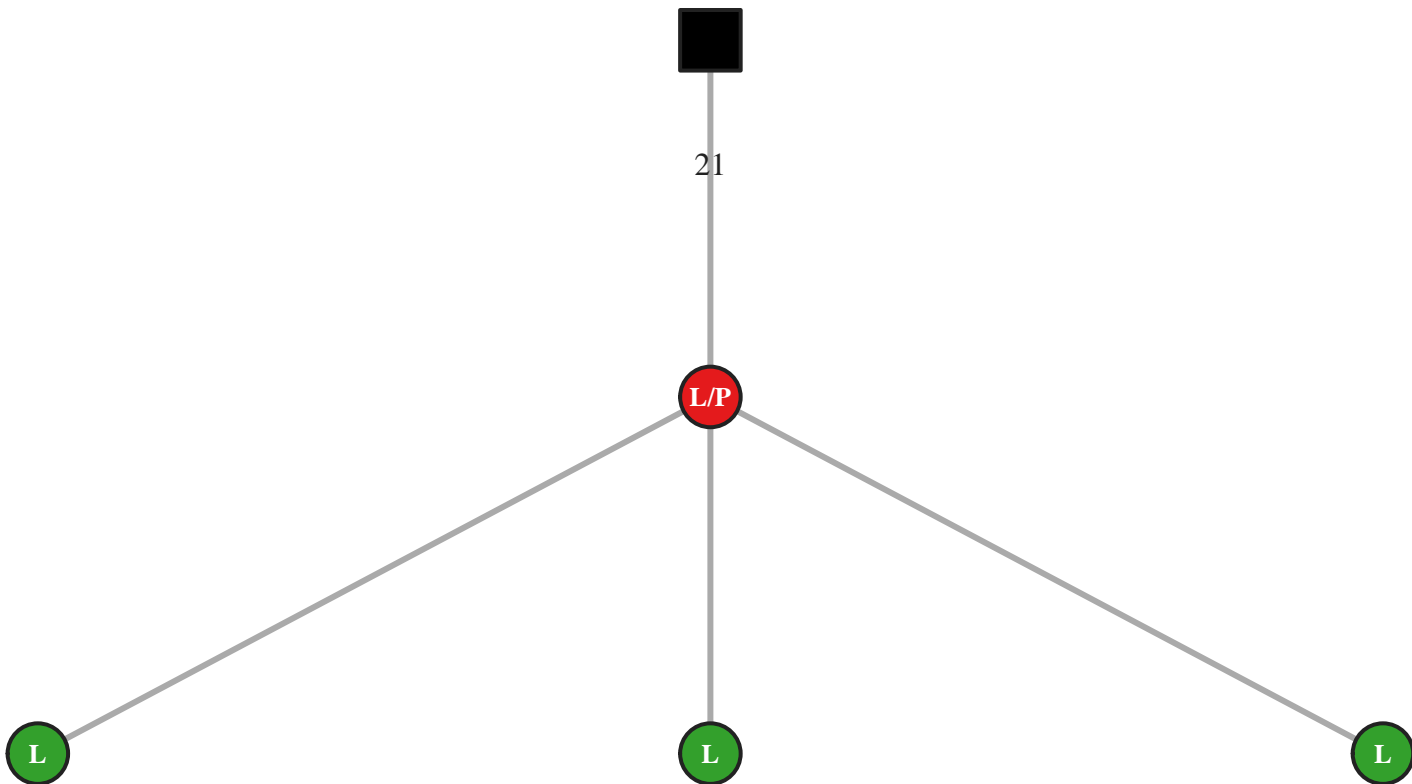

M5 IgA IGHV4-59/J4 60bp (30859)

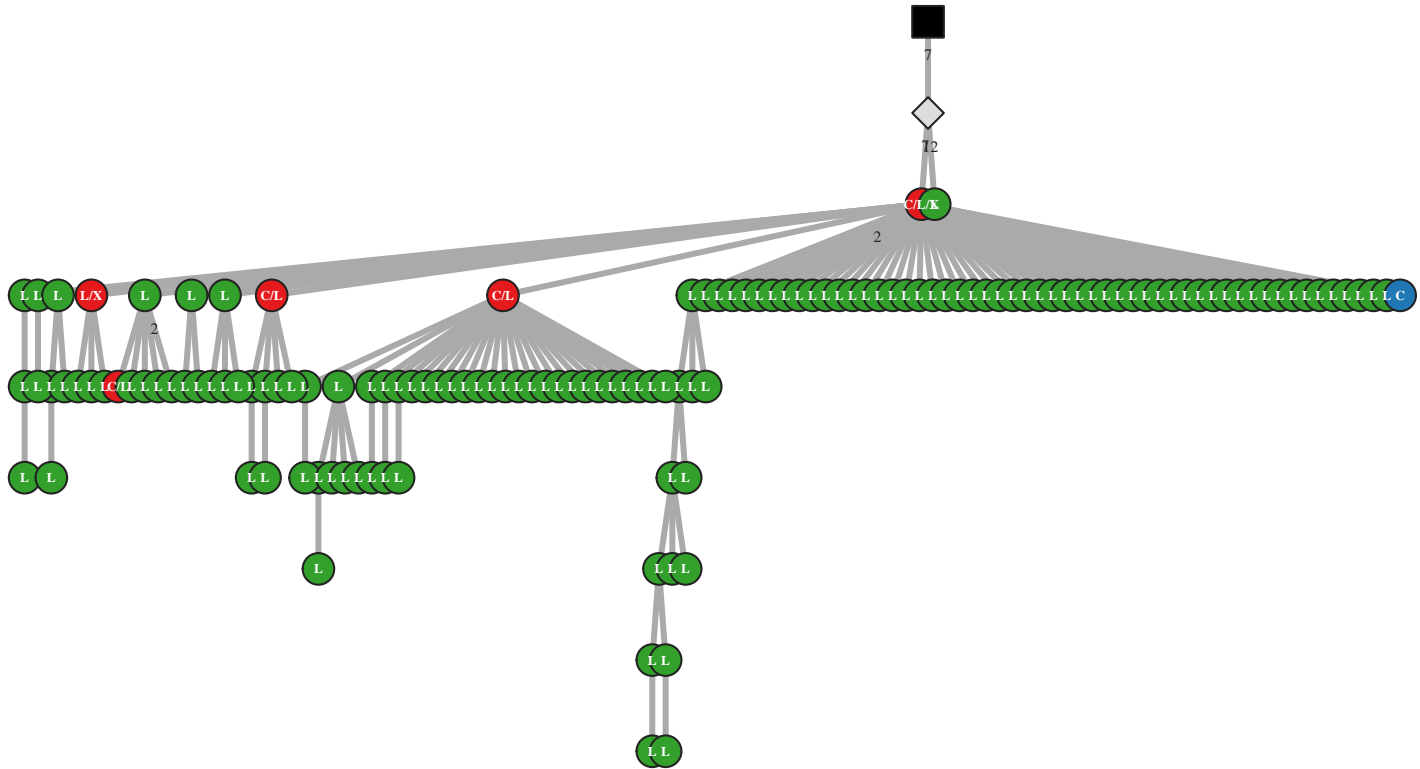

M5 IgG IGHV4-59/J4 63bp (36556)

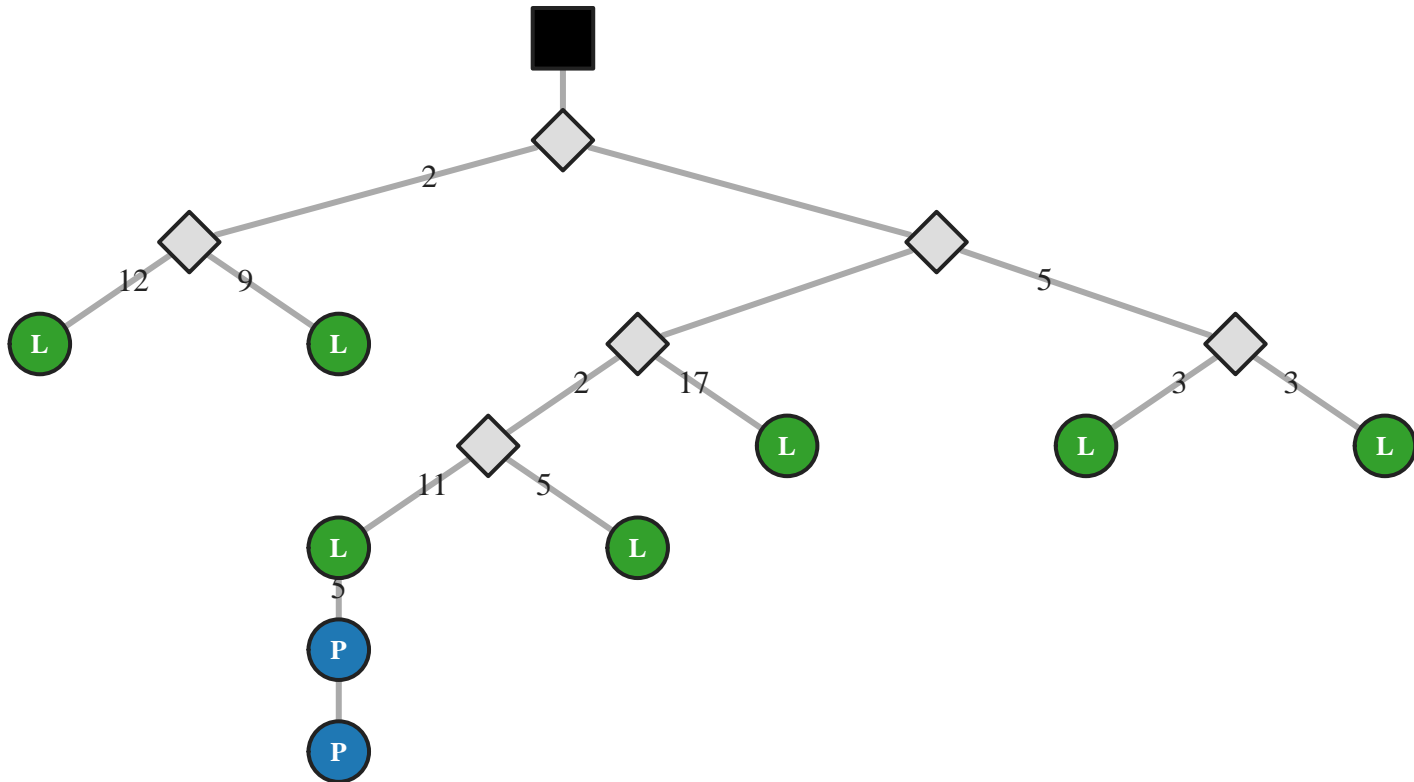

M5 IgA IGHV4-59/J4 69bp (3199)

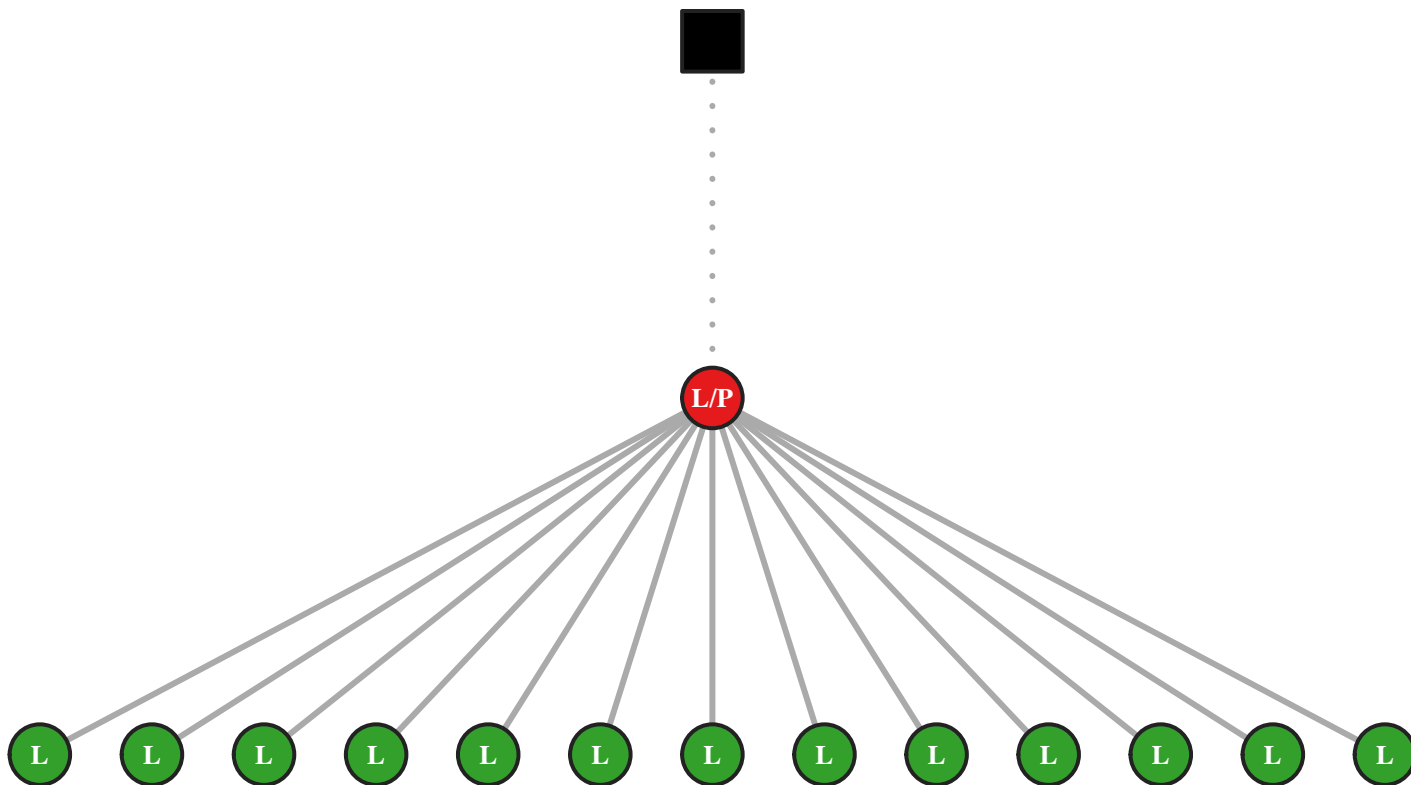

M5 IgG IGHV4-59/J4 69bp (46923)

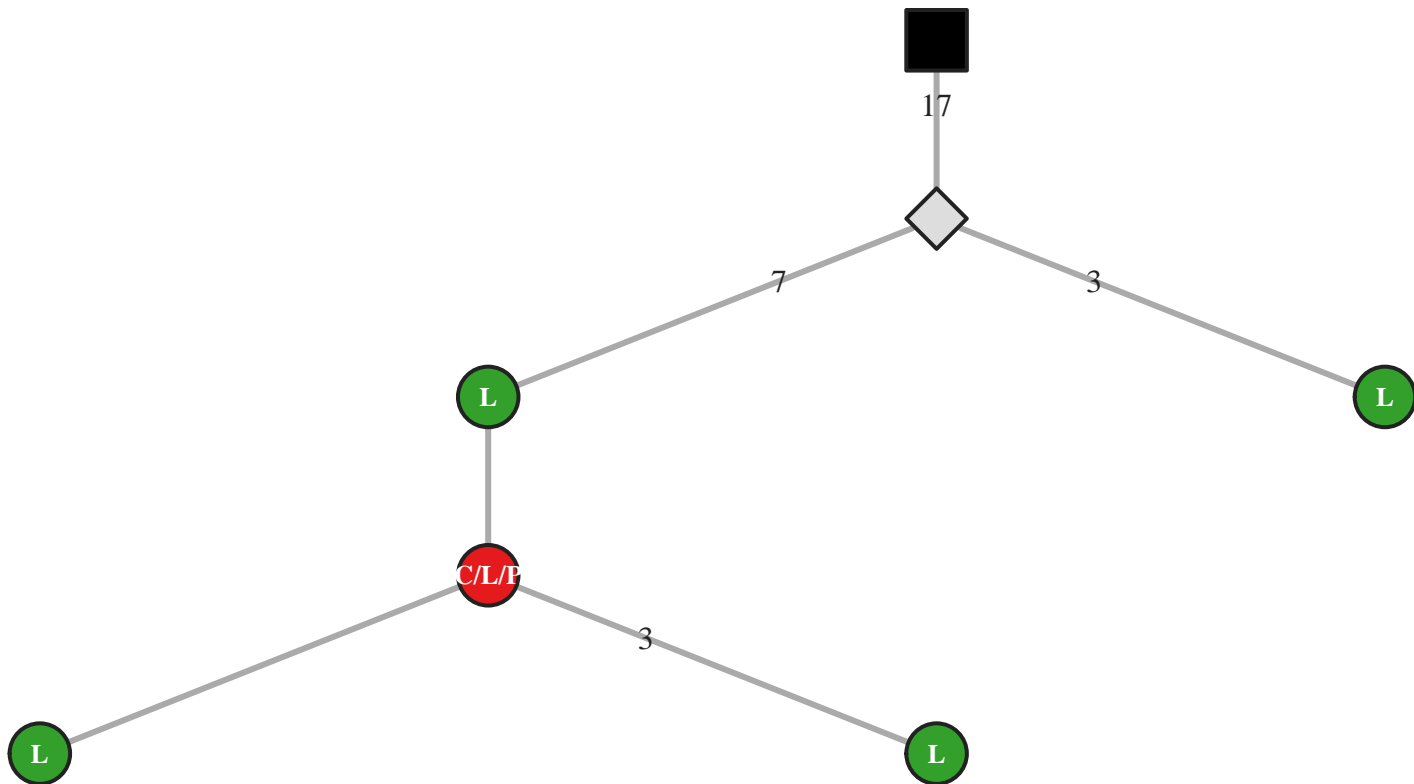

M5 IgG IGHV4-59/J4 69bp (46926)

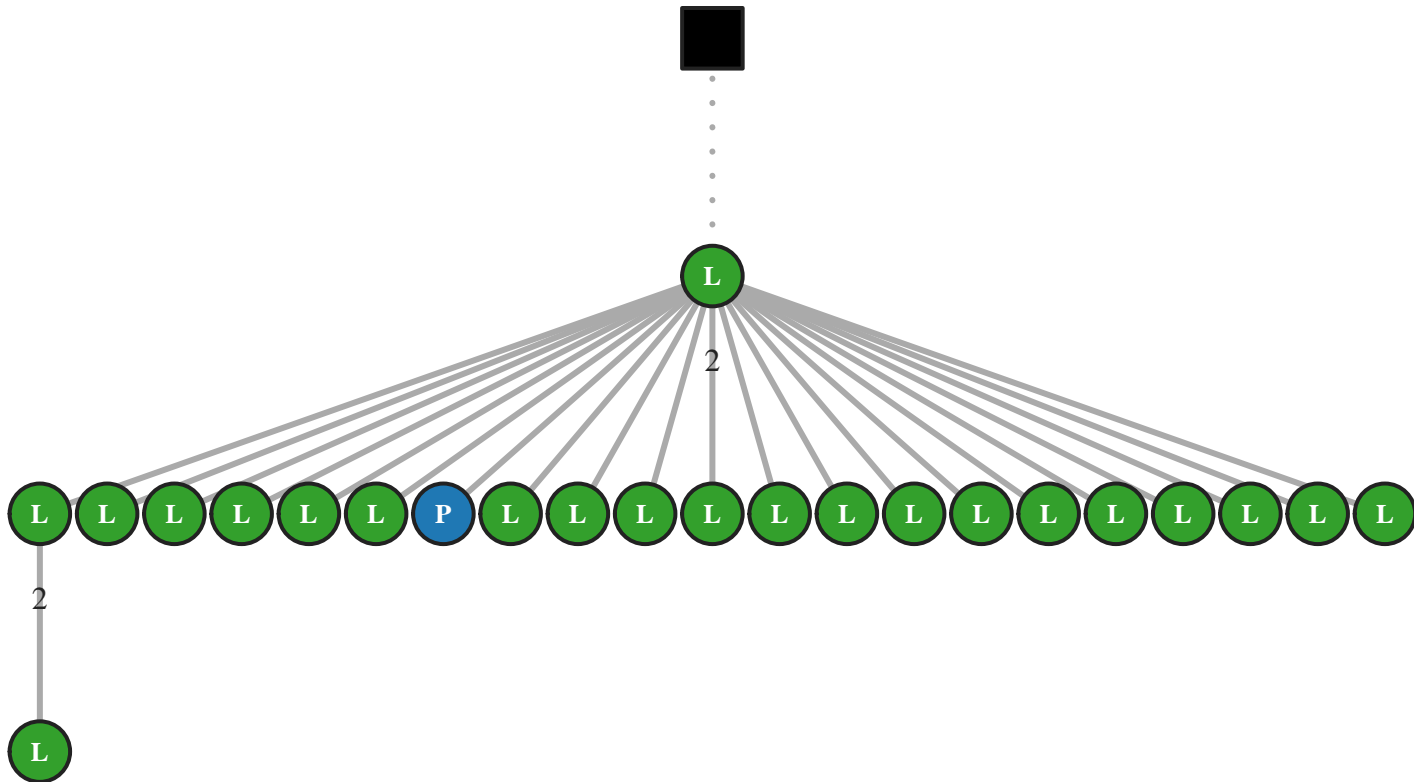

M5 IgG IGHV4-59/J5 33bp (19452)

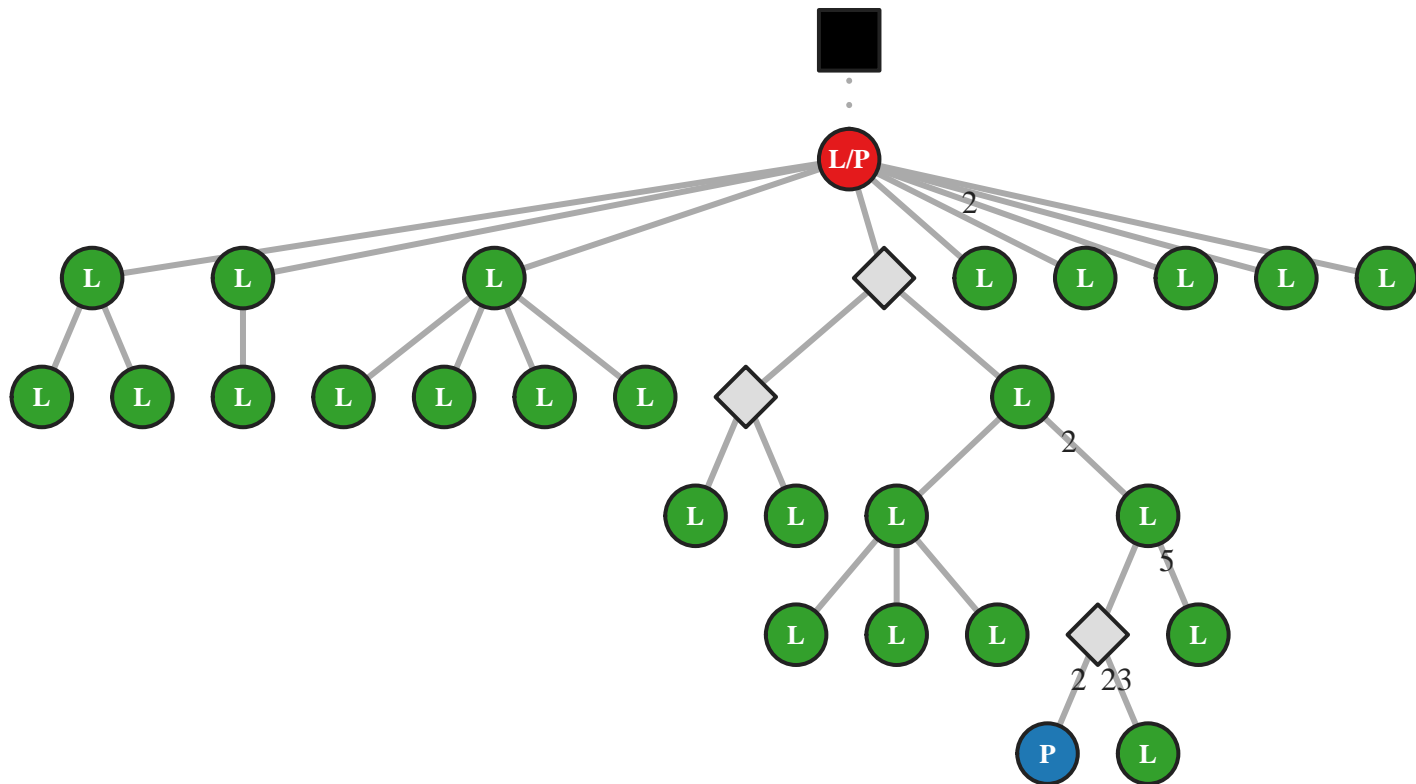

M5 IgA IGHV4-59/J5 36bp (3201)

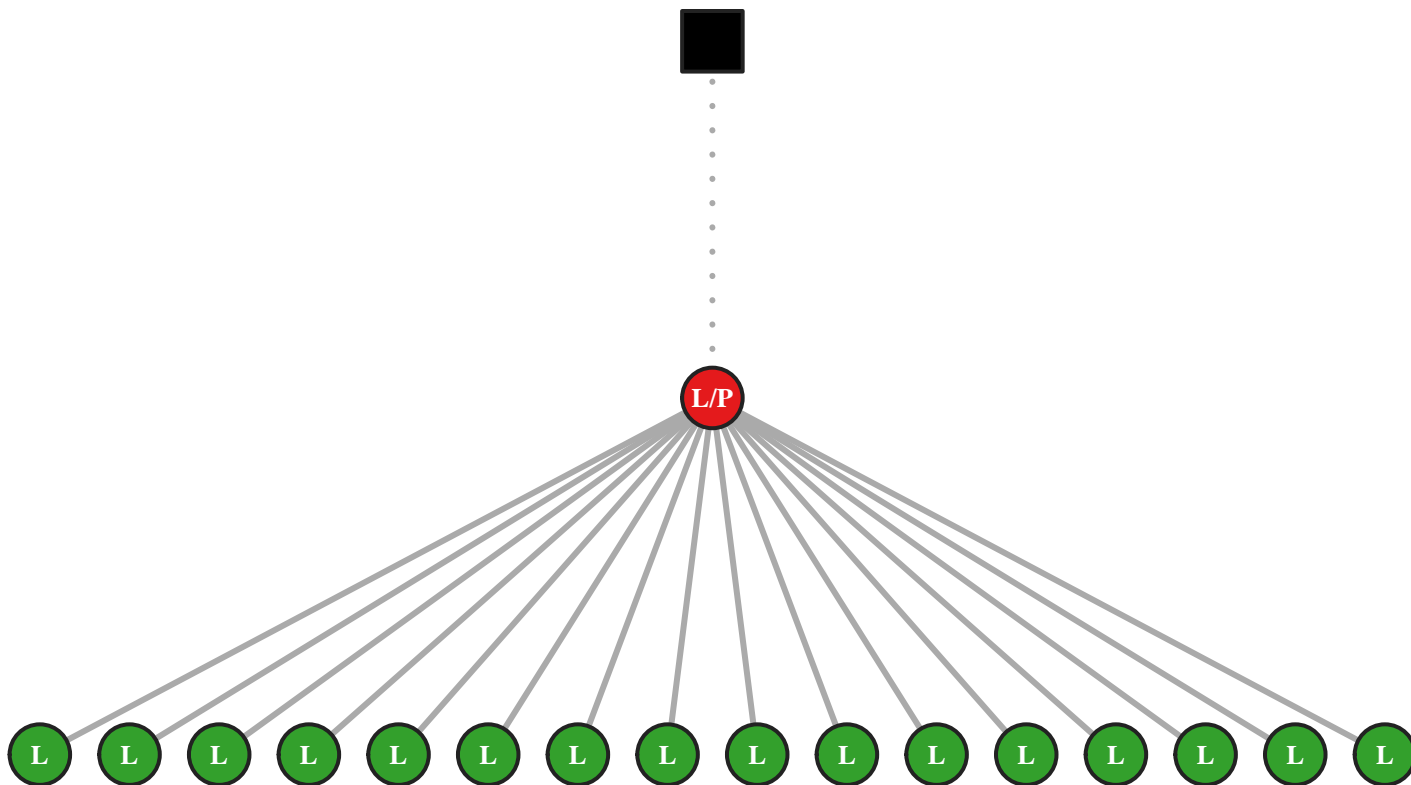

M5 IgG IGHV4-59/J5 36bp (19368)

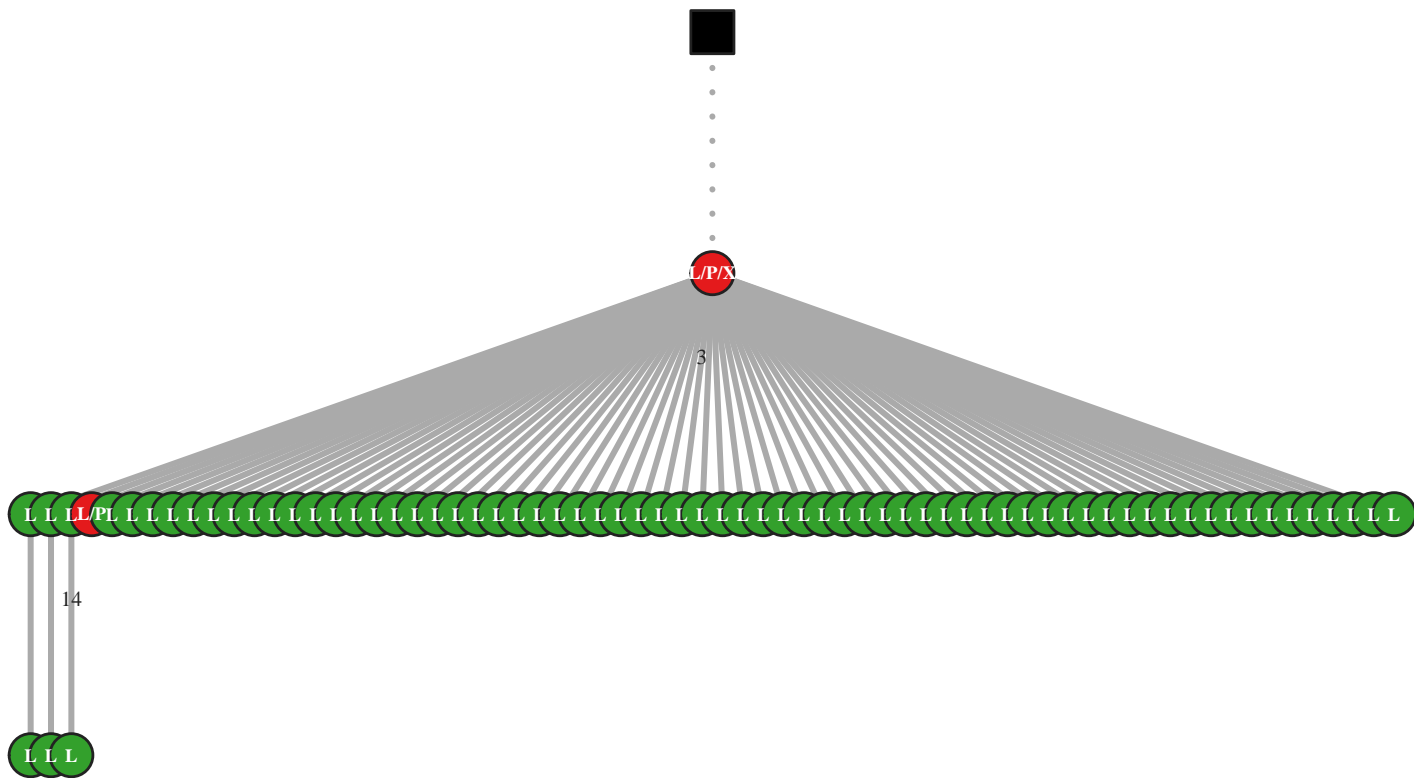

M5 IgG IGHV4-59/J5 42bp (28523)

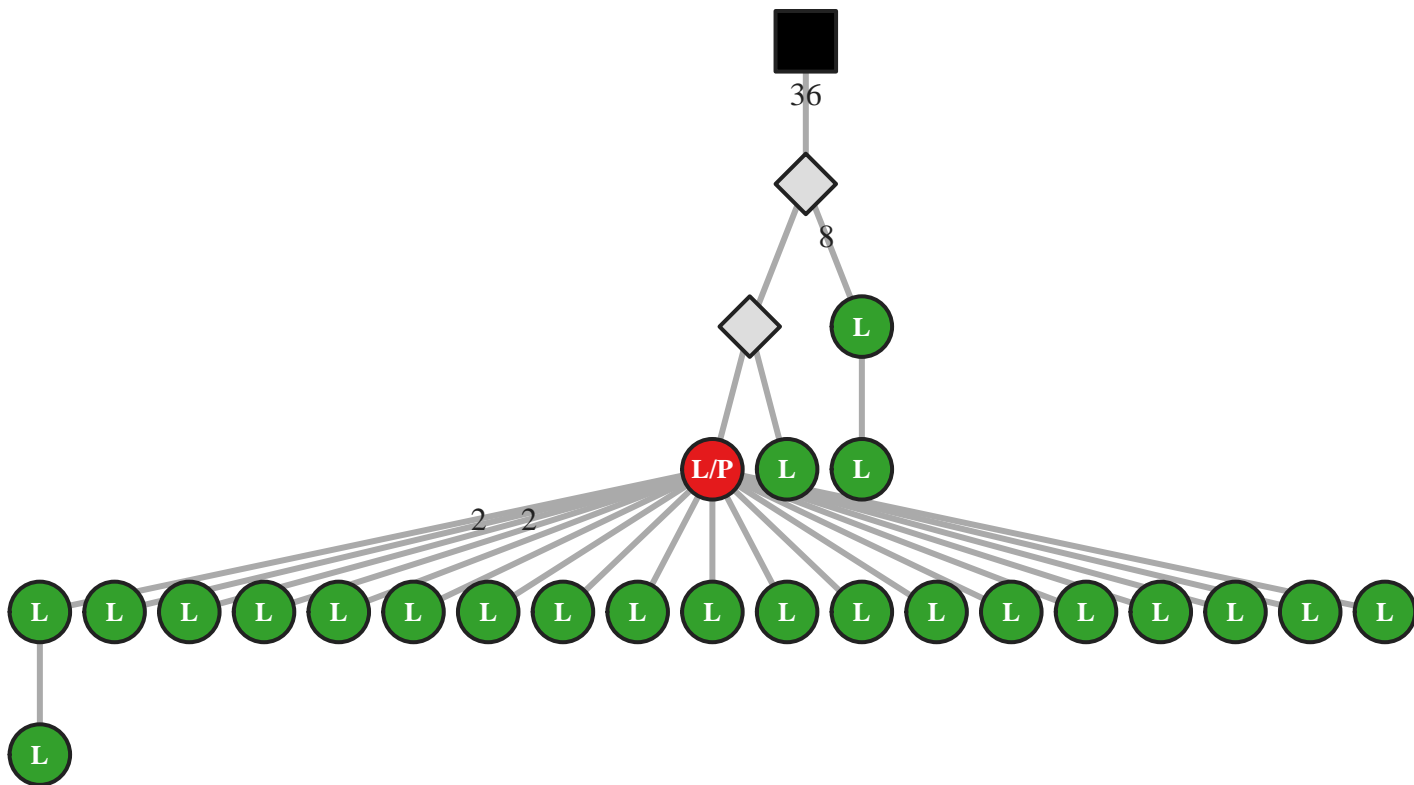

M5 IgG IGHV4-59/J5 42bp (28551)

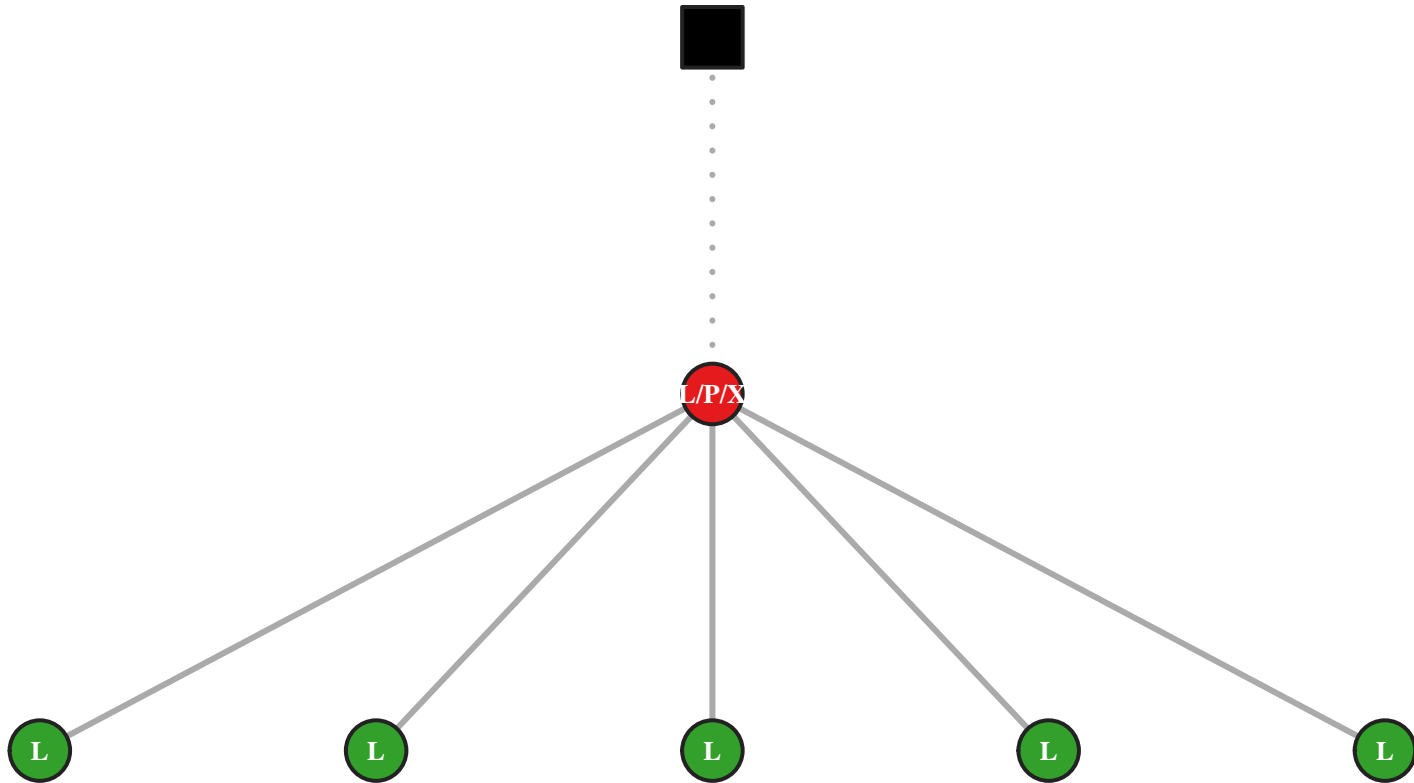

M5 IgG IGHV4-59/J5 45bp (46765)

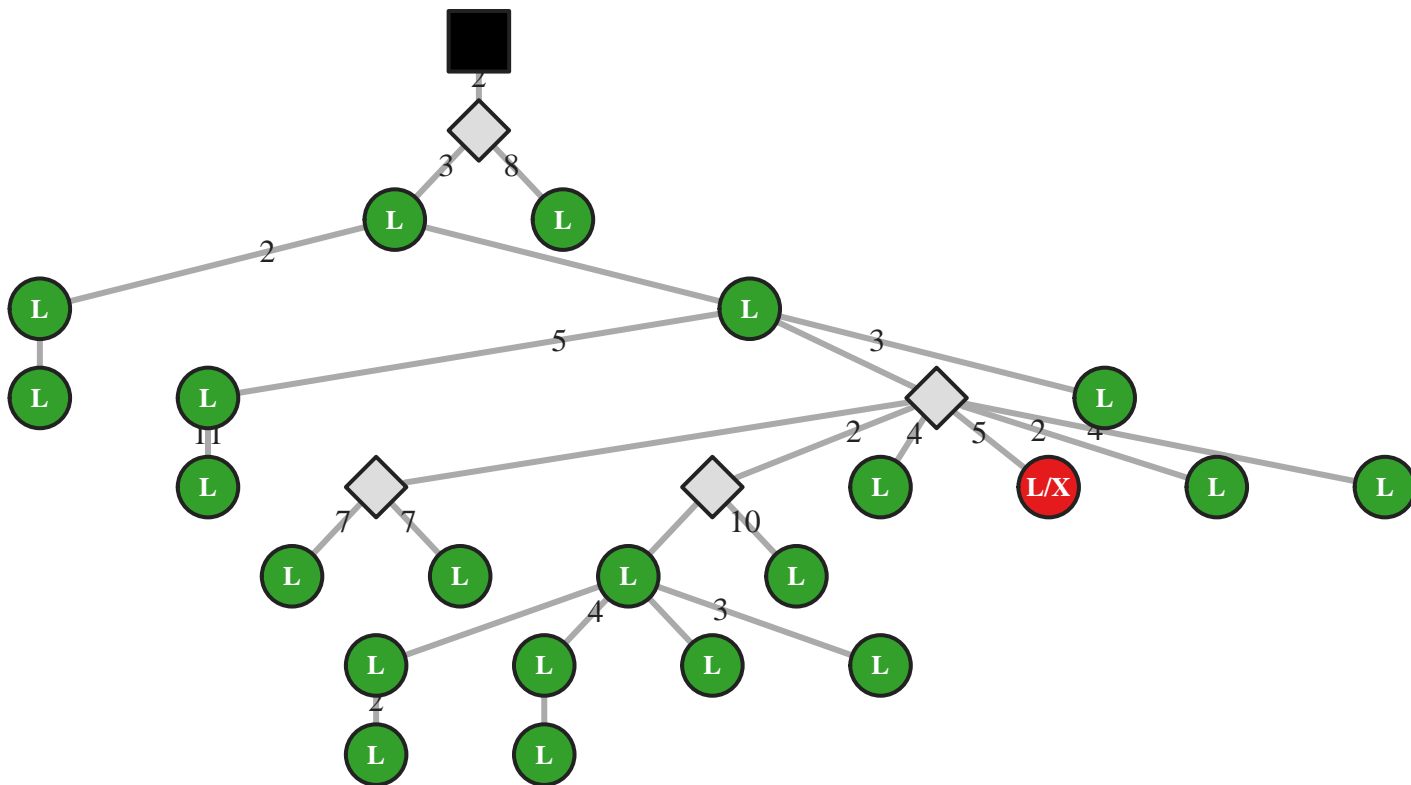

M5 IgG IGHV4-59/J5 48bp (53417)

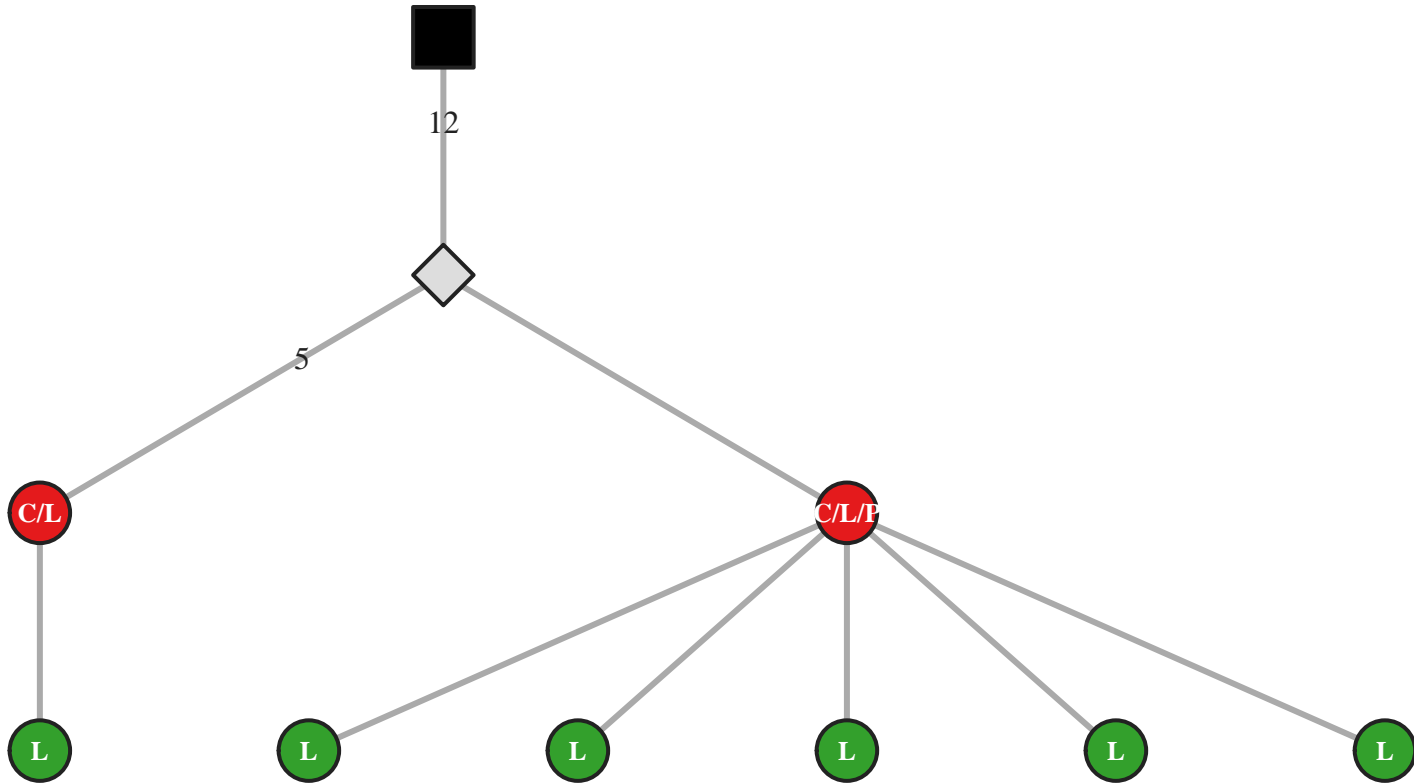

M5 IgG IGHV4-59/J5 48bp (53419)

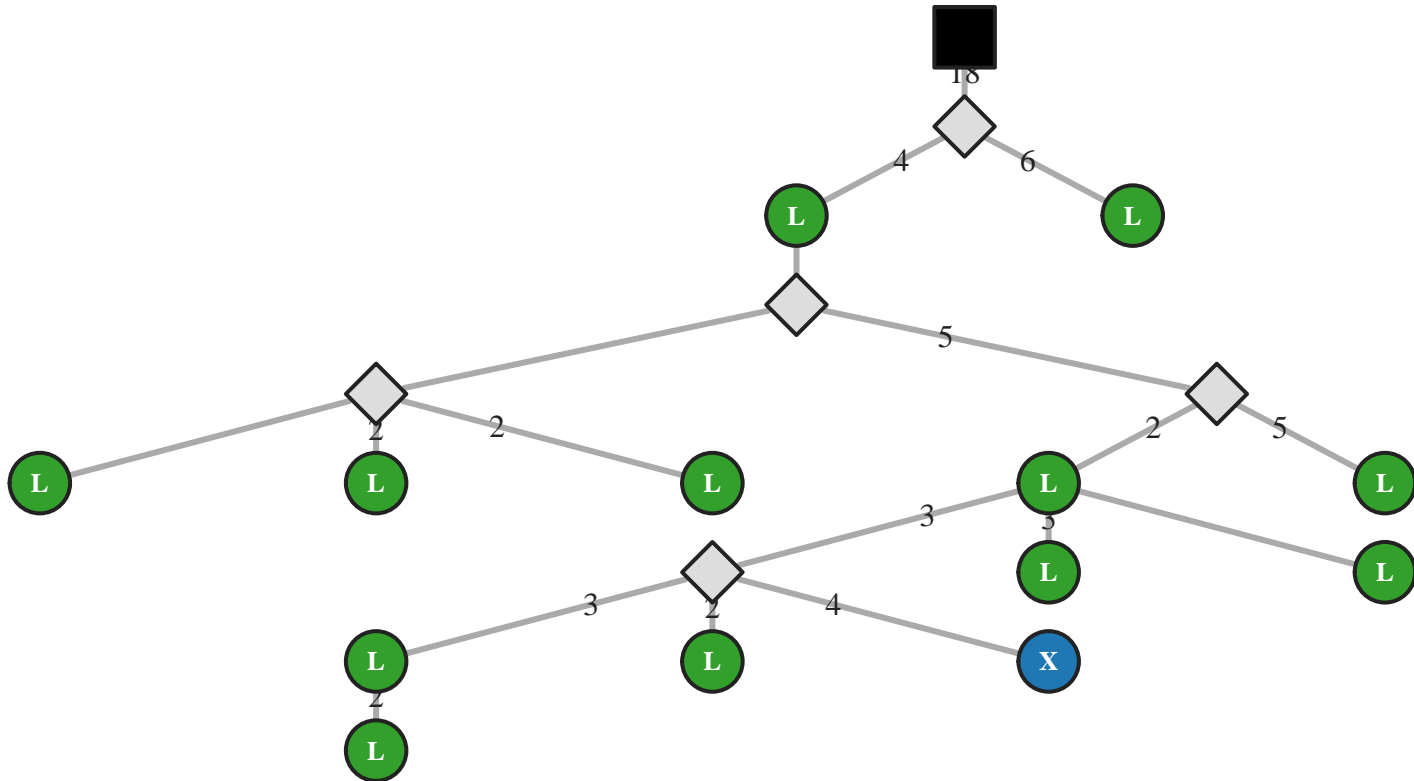

M5 IgG IGHV4-59/J5 48bp (53446)

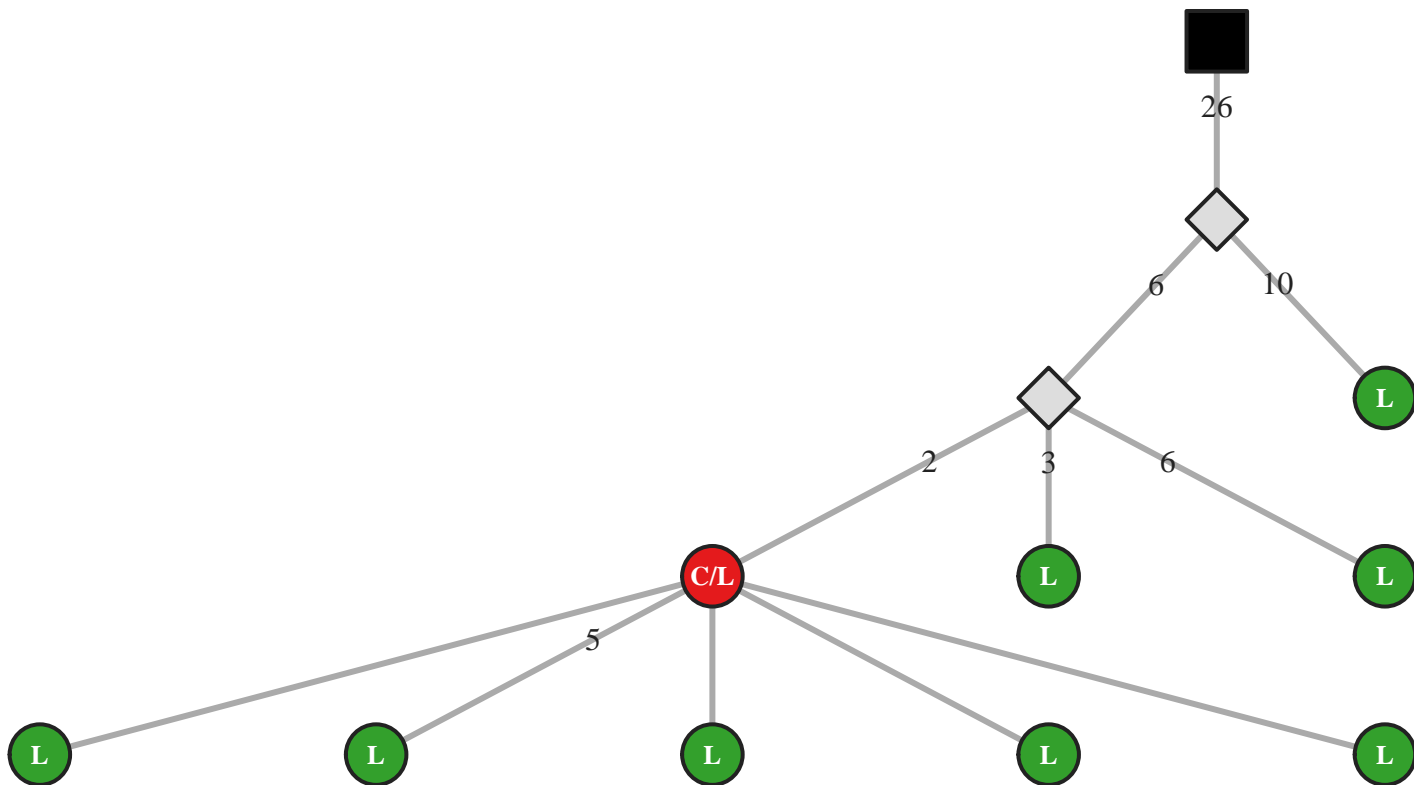

M5 IgG IGHV4-59/J5 51bp (36606)

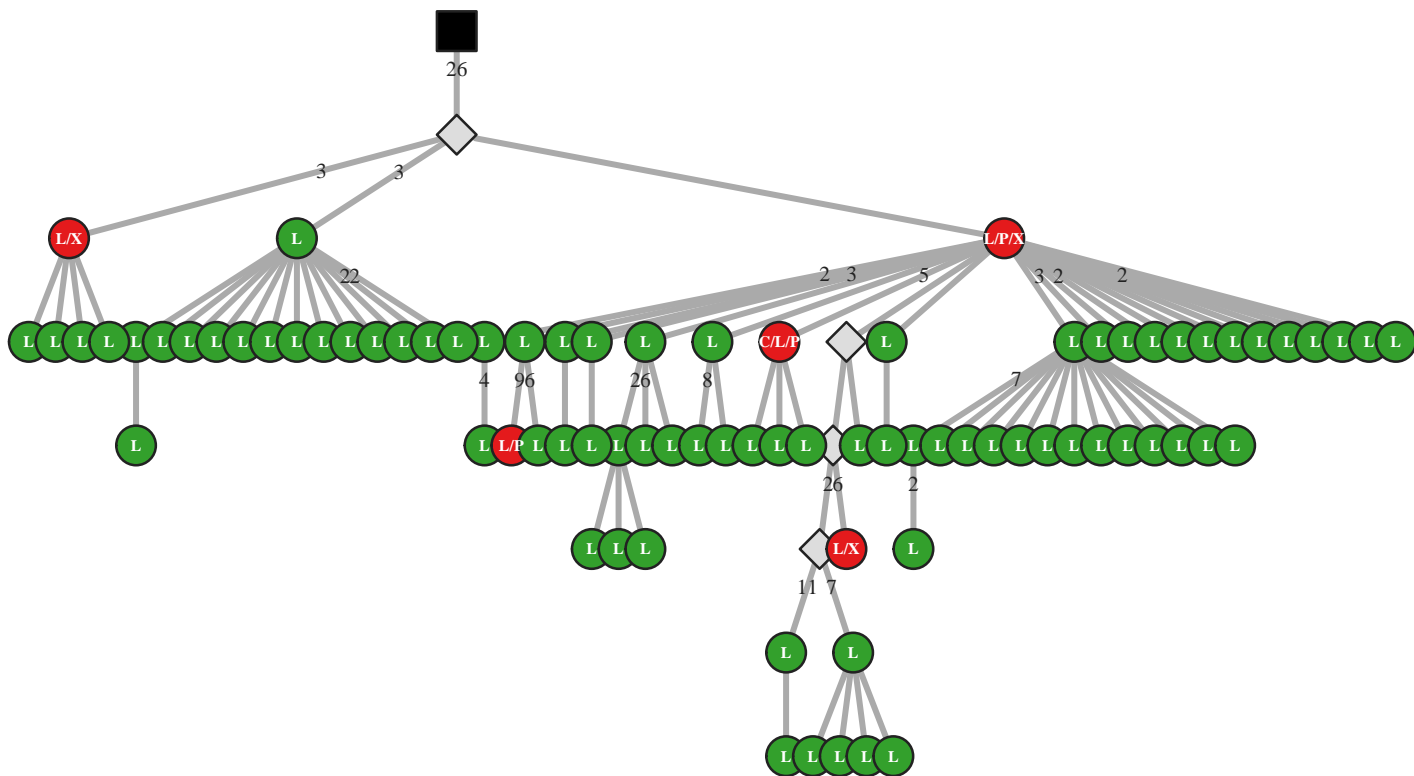

M5 IgA IGHV4-59/J5 54bp (30846)

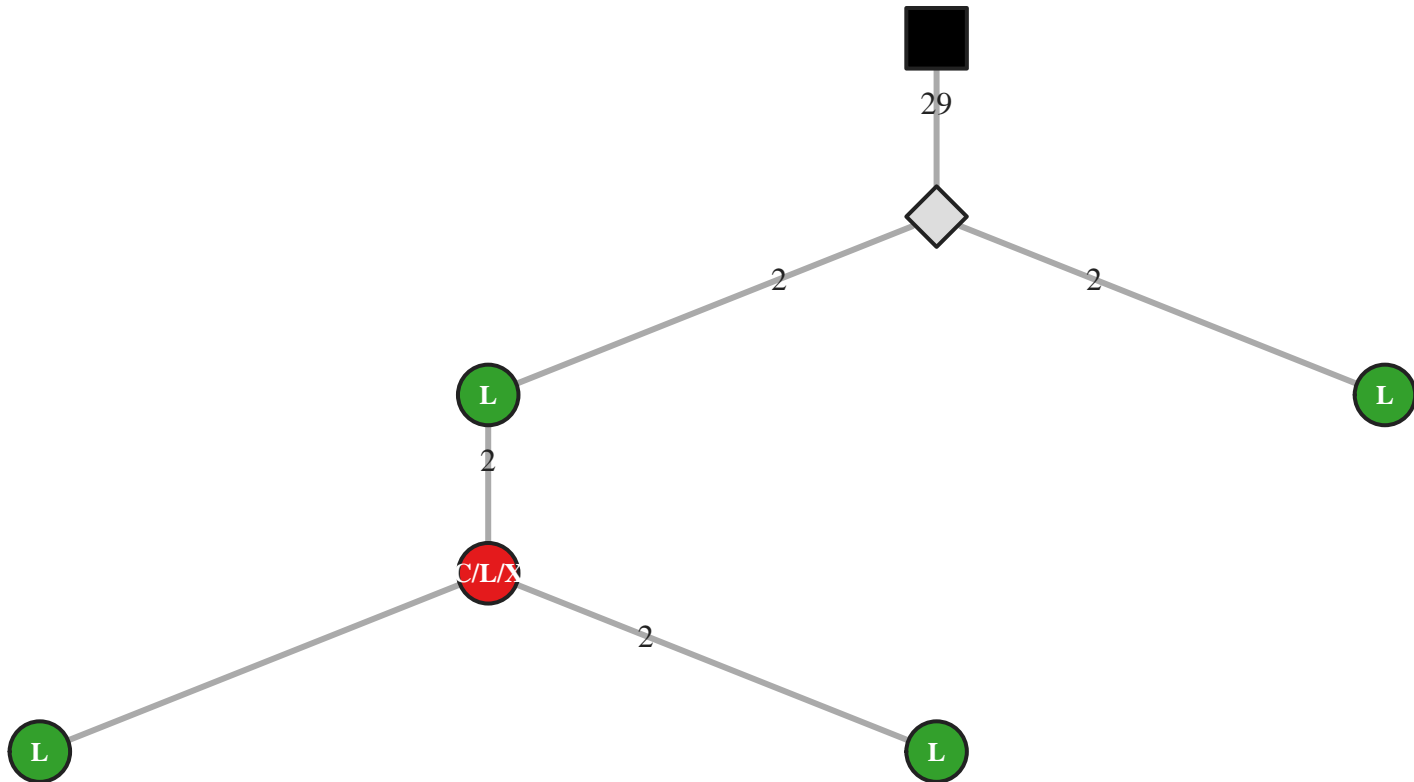

M5 IgG IGHV4-59/J5 60bp (28643)

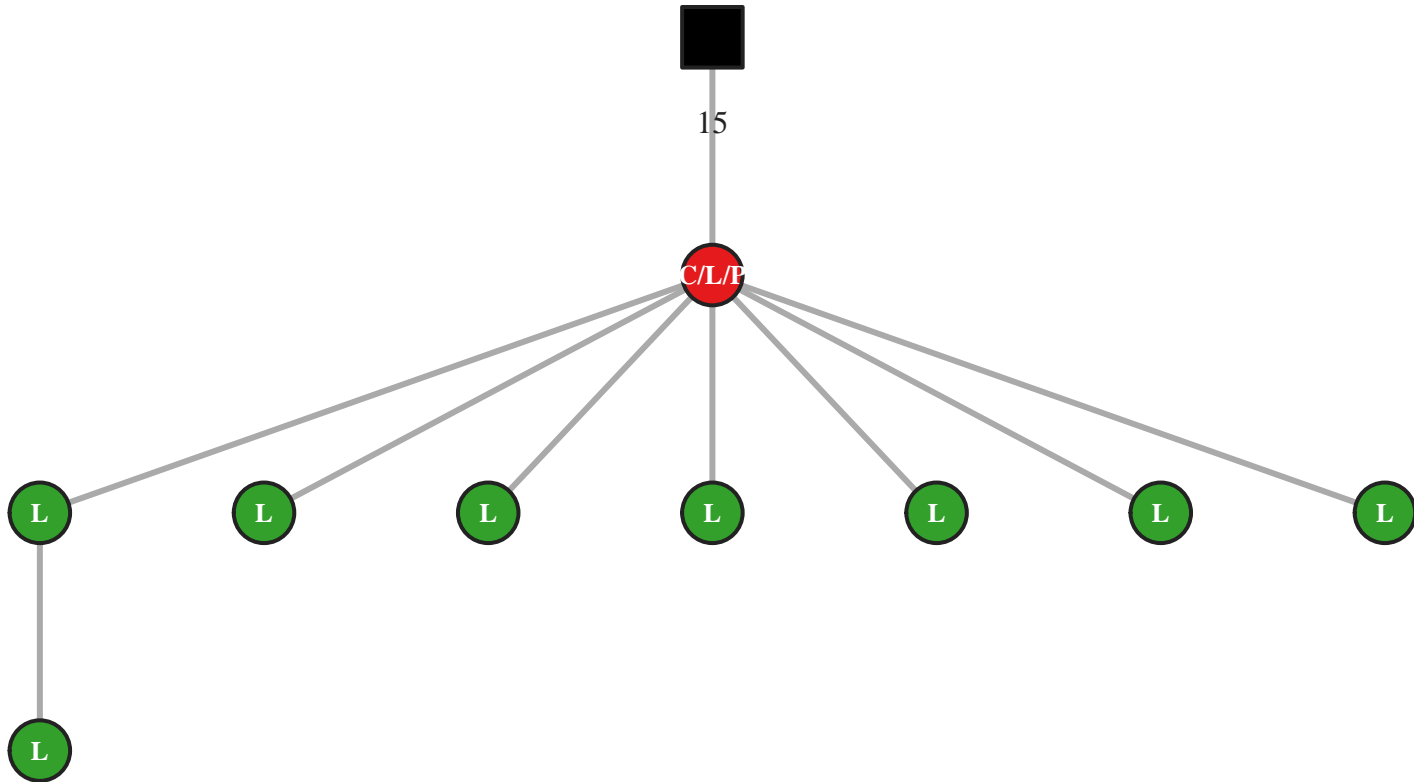

M5 IgG IGHV4-59/J6 51bp (19399)

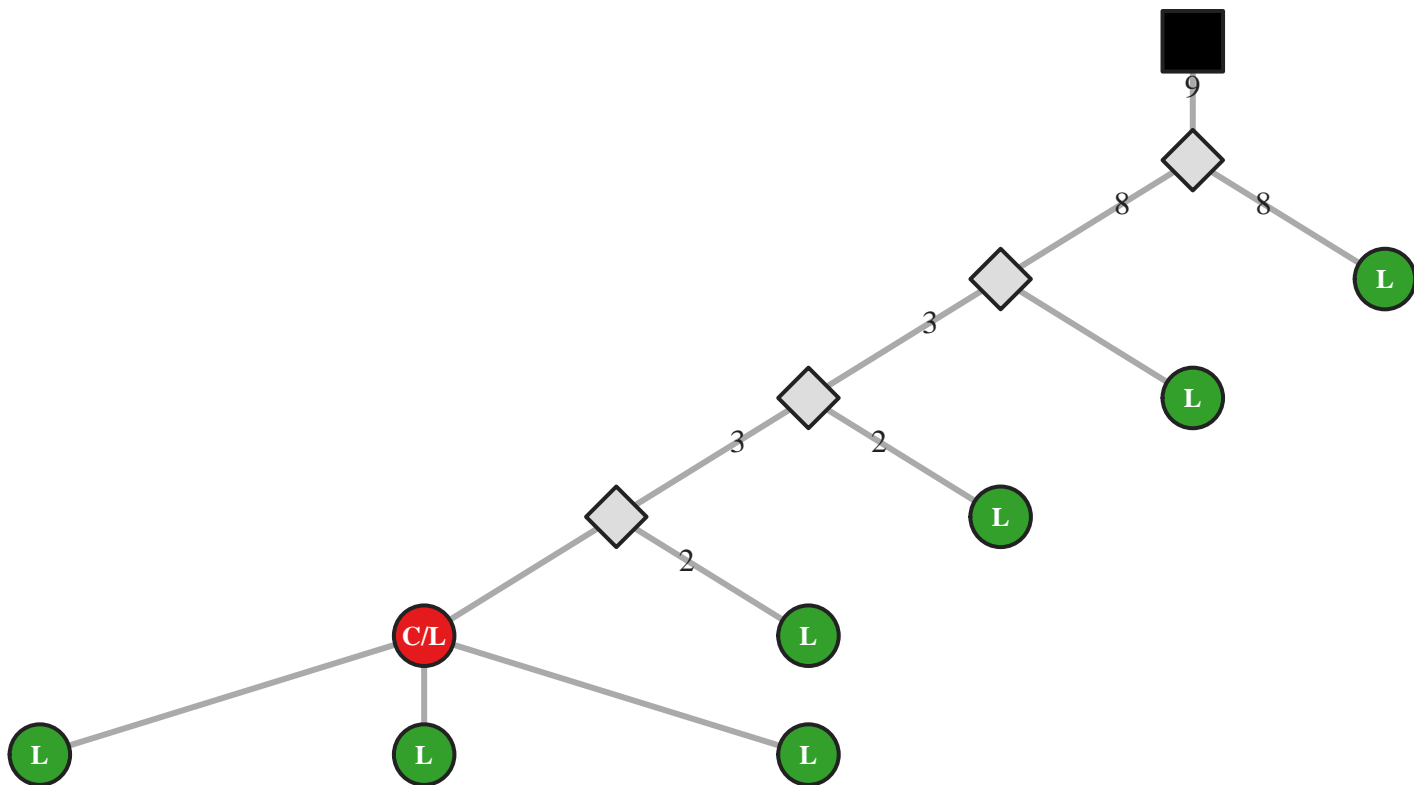

M5 IgG IGHV4-59/J6 51bp (19413)

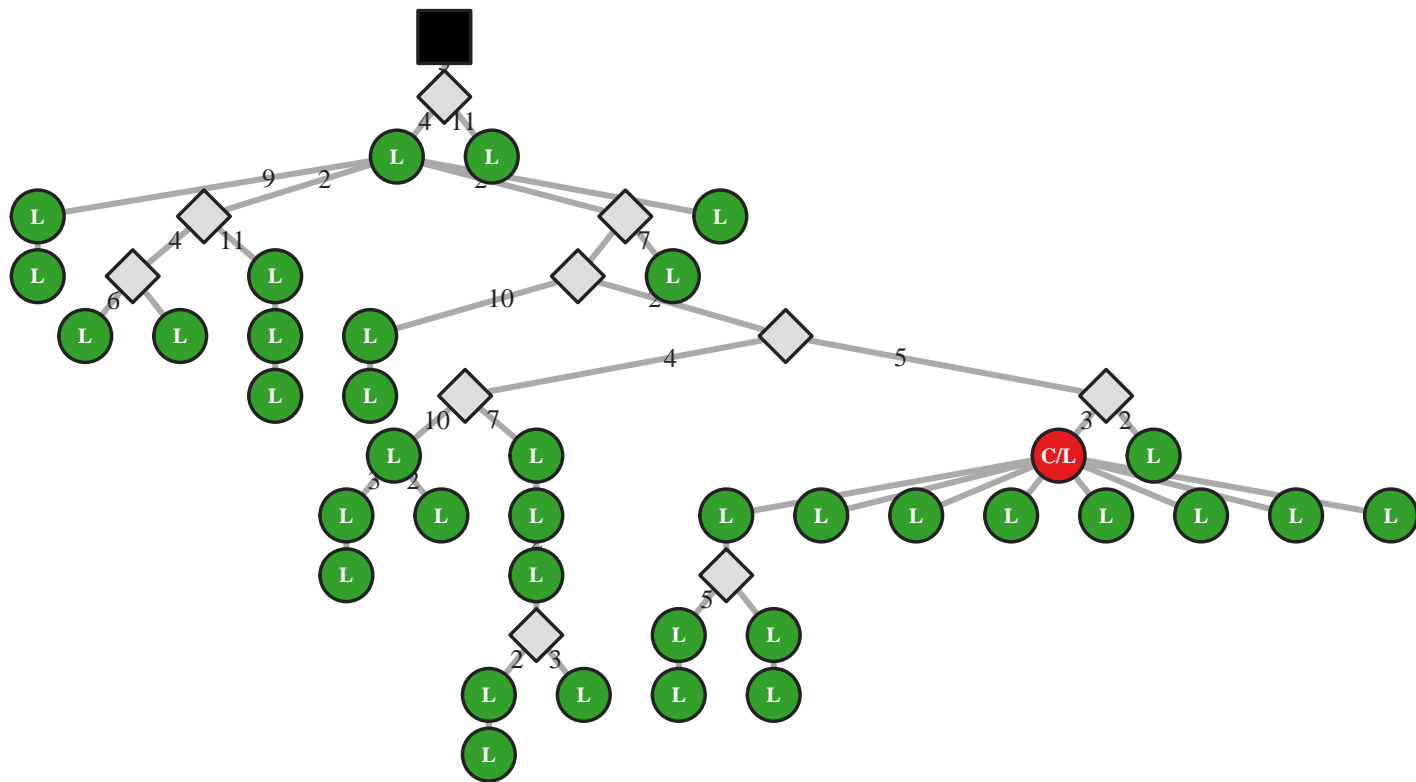

M5 IgG IGHV4-59/J6 57bp (28558)

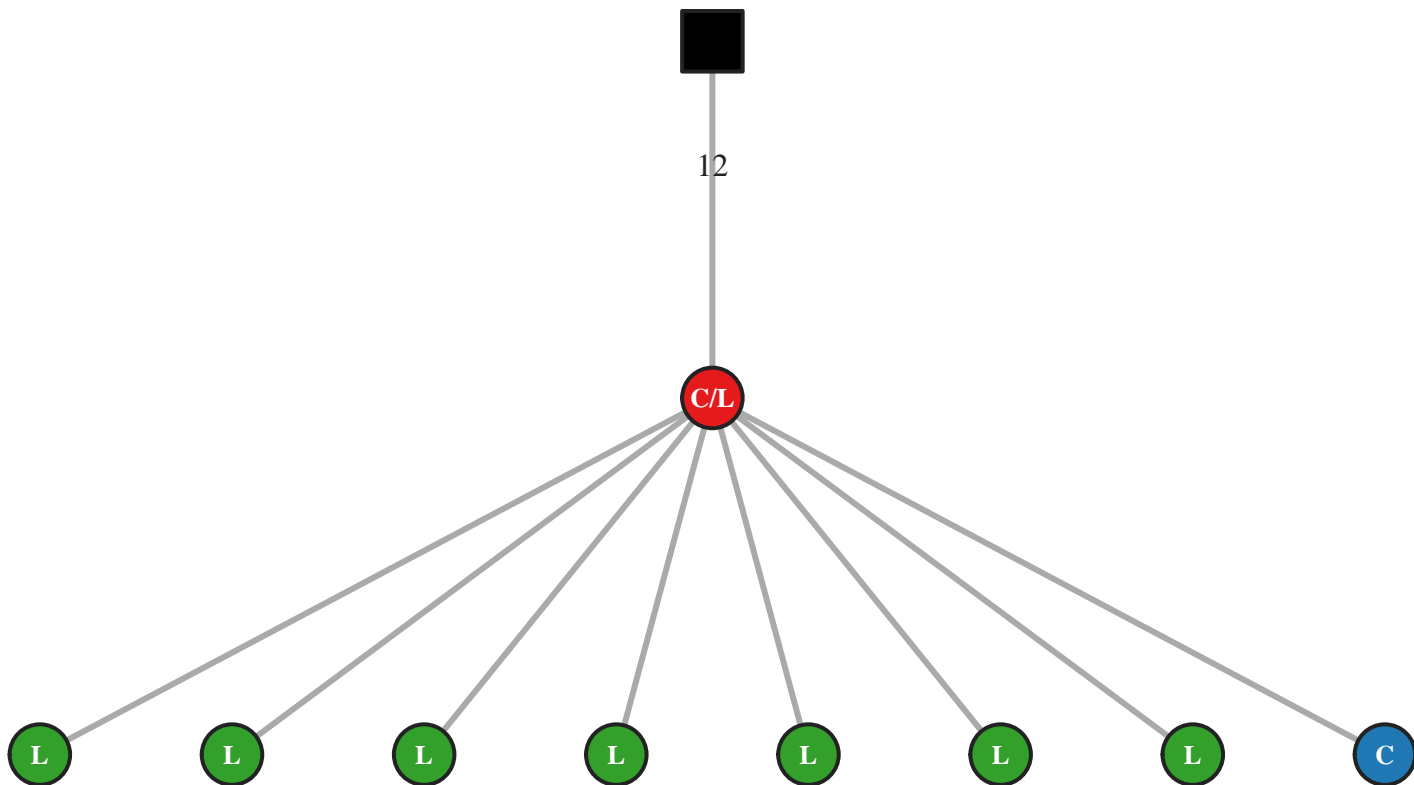

M5 IgG IGHV4-59/J6 57bp (28568)

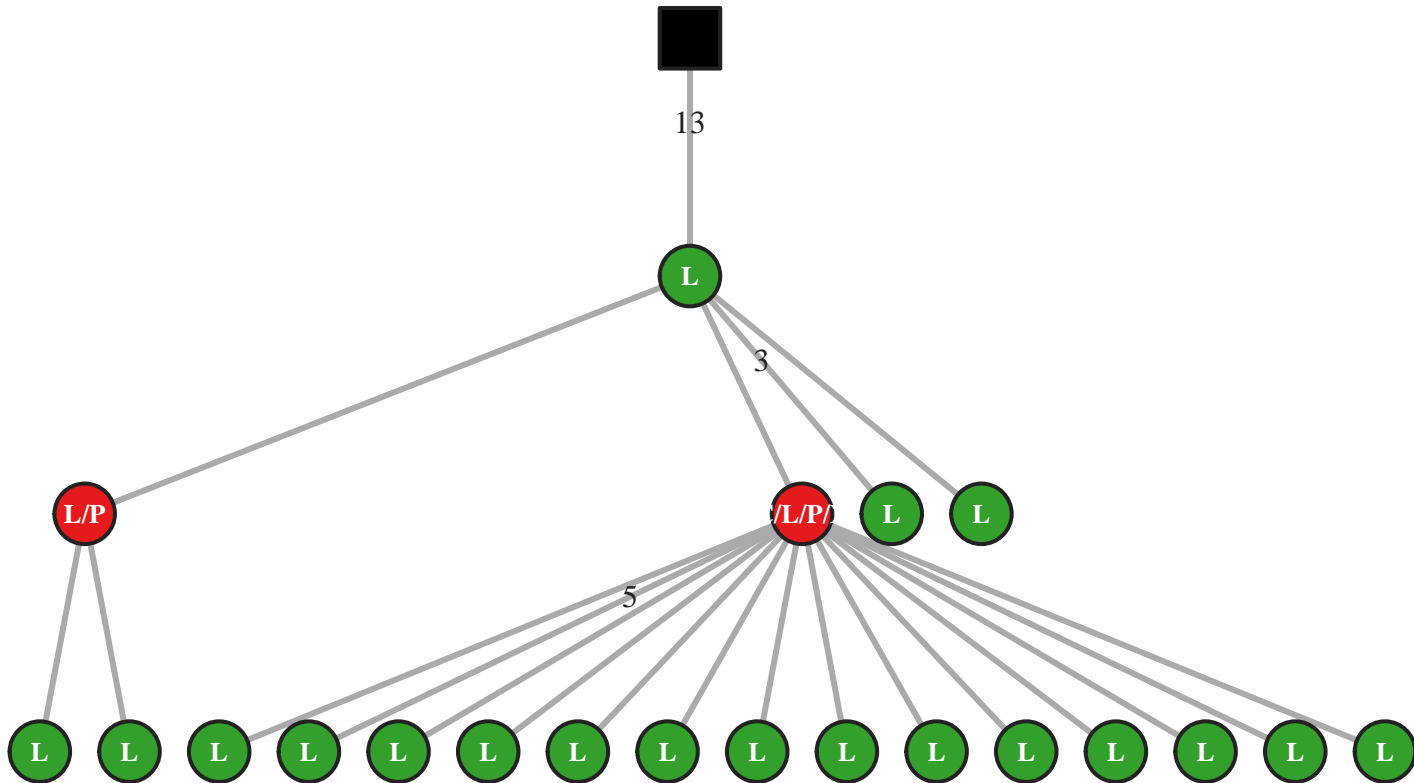

M5 IgG IGHV4-59/J6 60bp (46826)

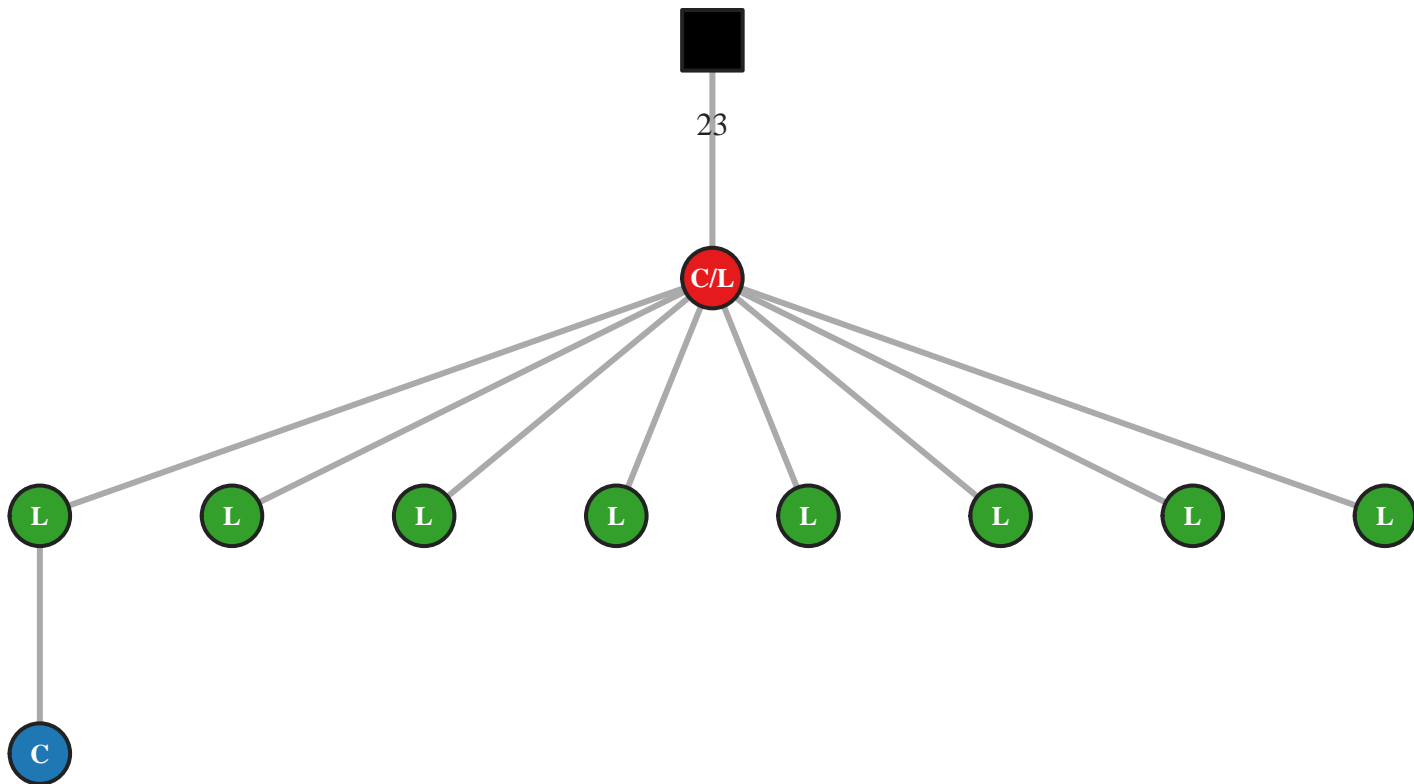

M5 IgG IGHV4-59/J6 63bp (46859)

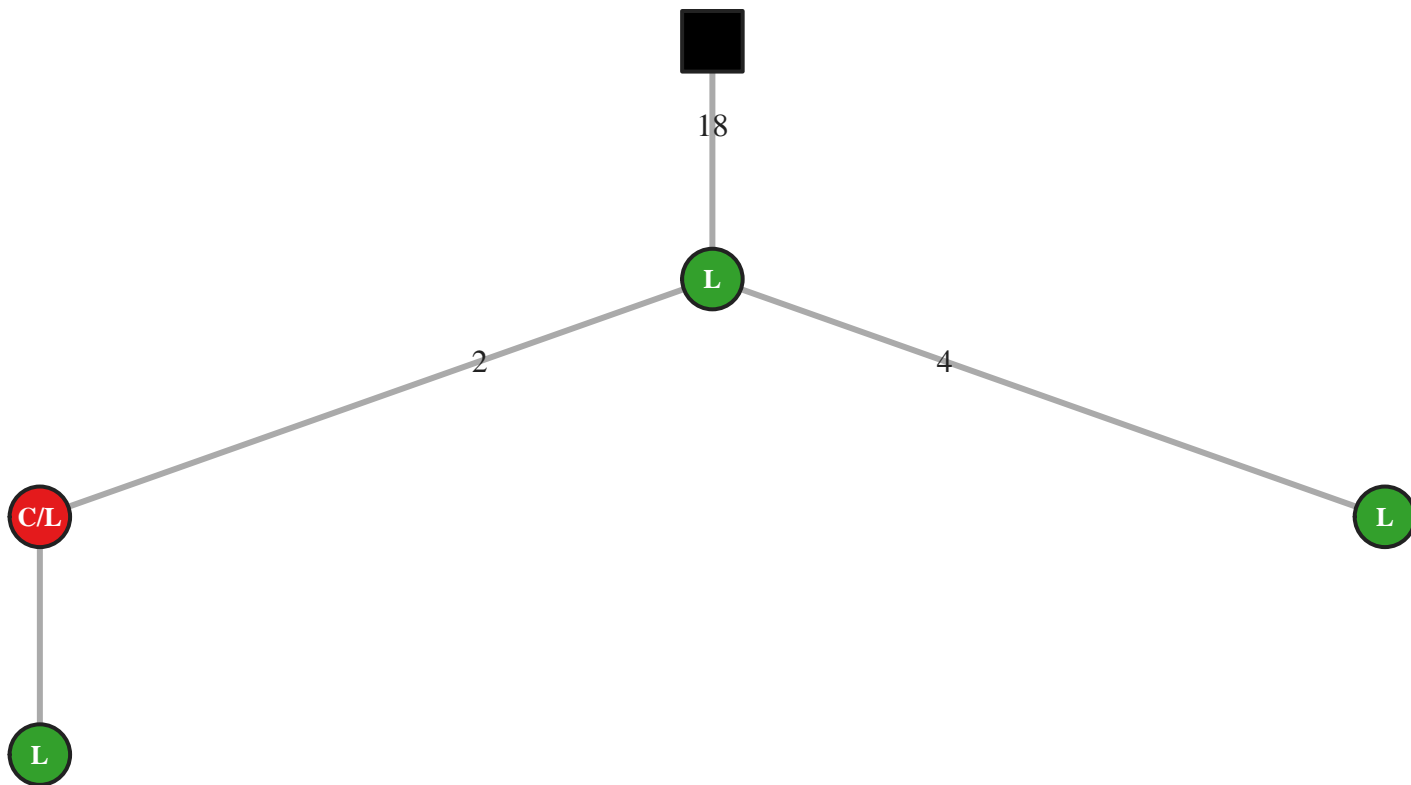

M5 IgG IGHV4-59/J6 66bp (10442)

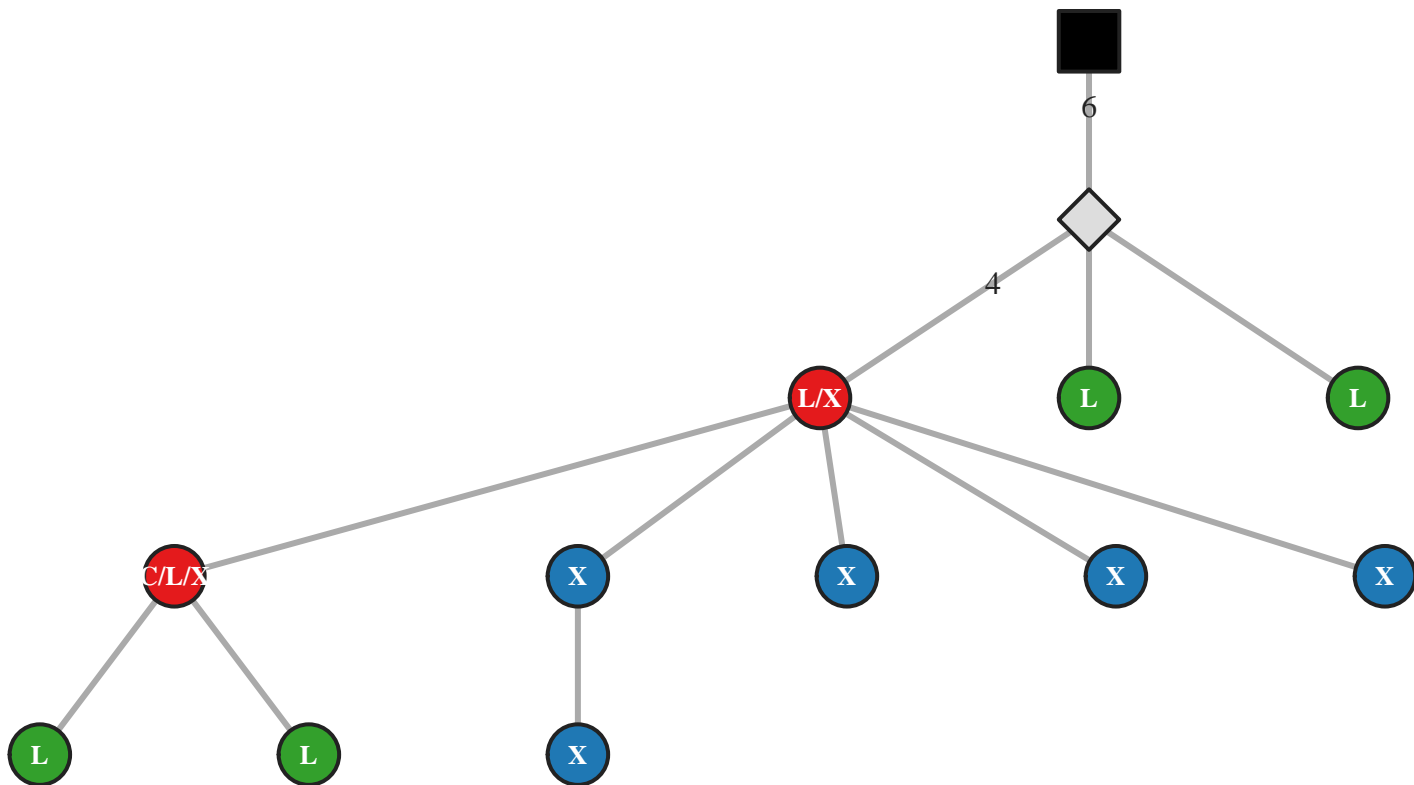

M5 IgA IGHV4-59/J6 69bp (30873)

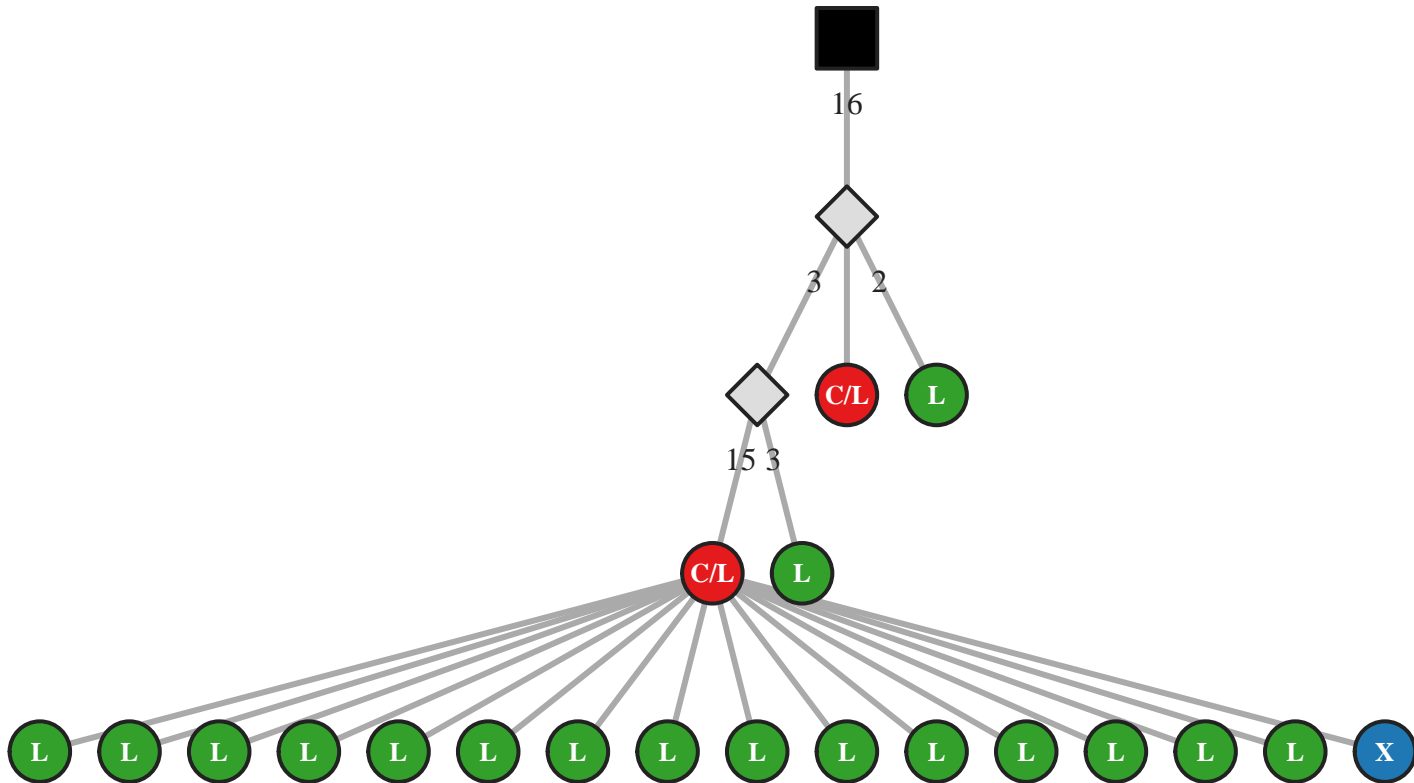

M5 IgG IGHV4-59/J6 81bp (36709)

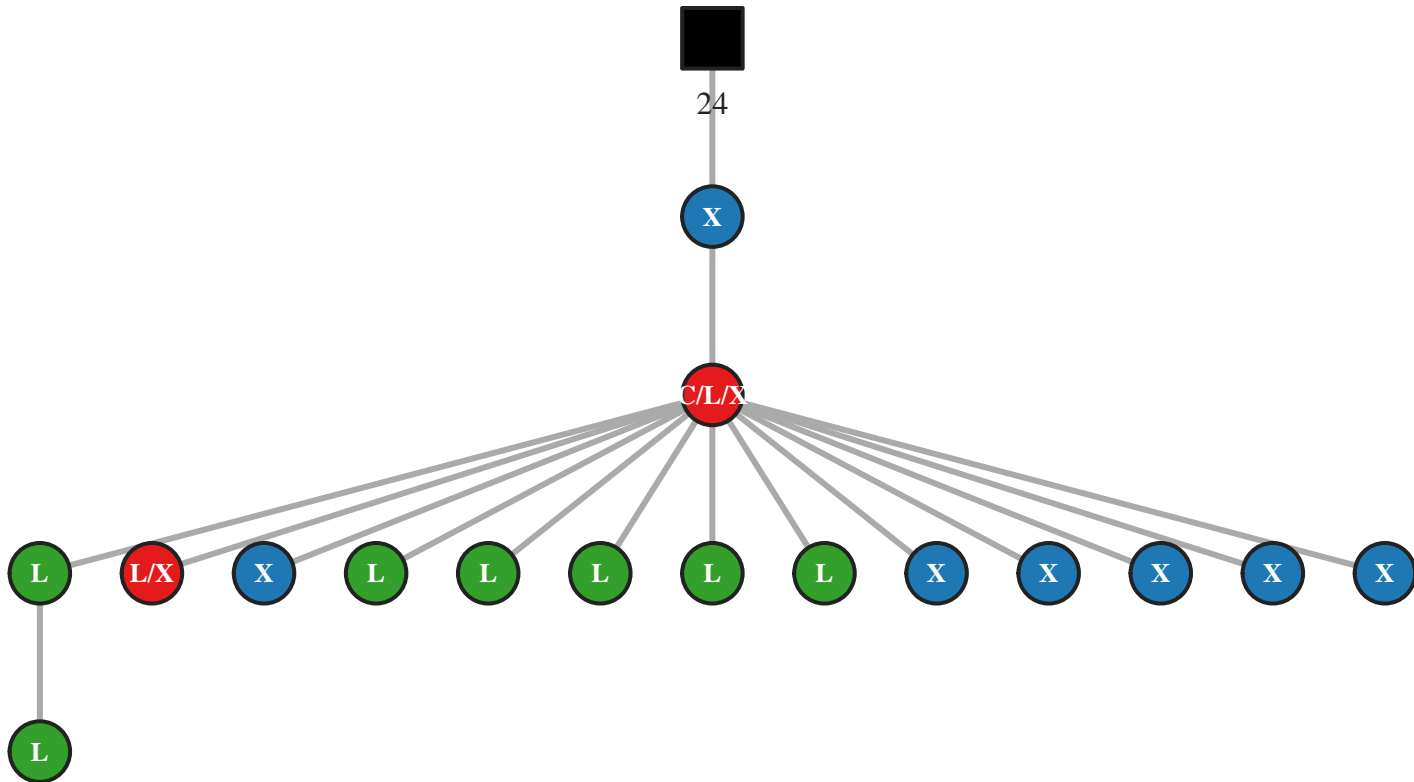

M5 IgG IGHV4-61/J4 36bp (53211)

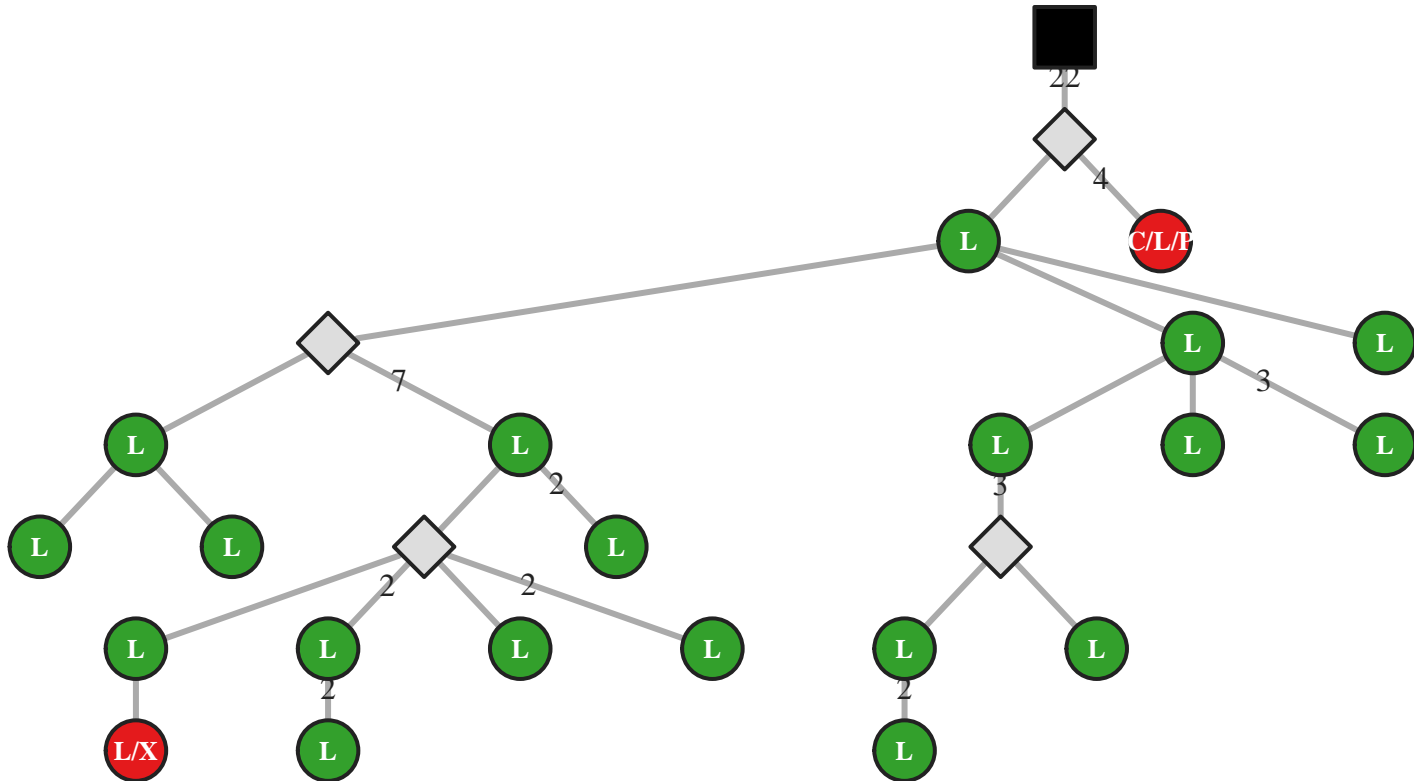

M5 IgA IGHV4-61/J4 42bp (49018)

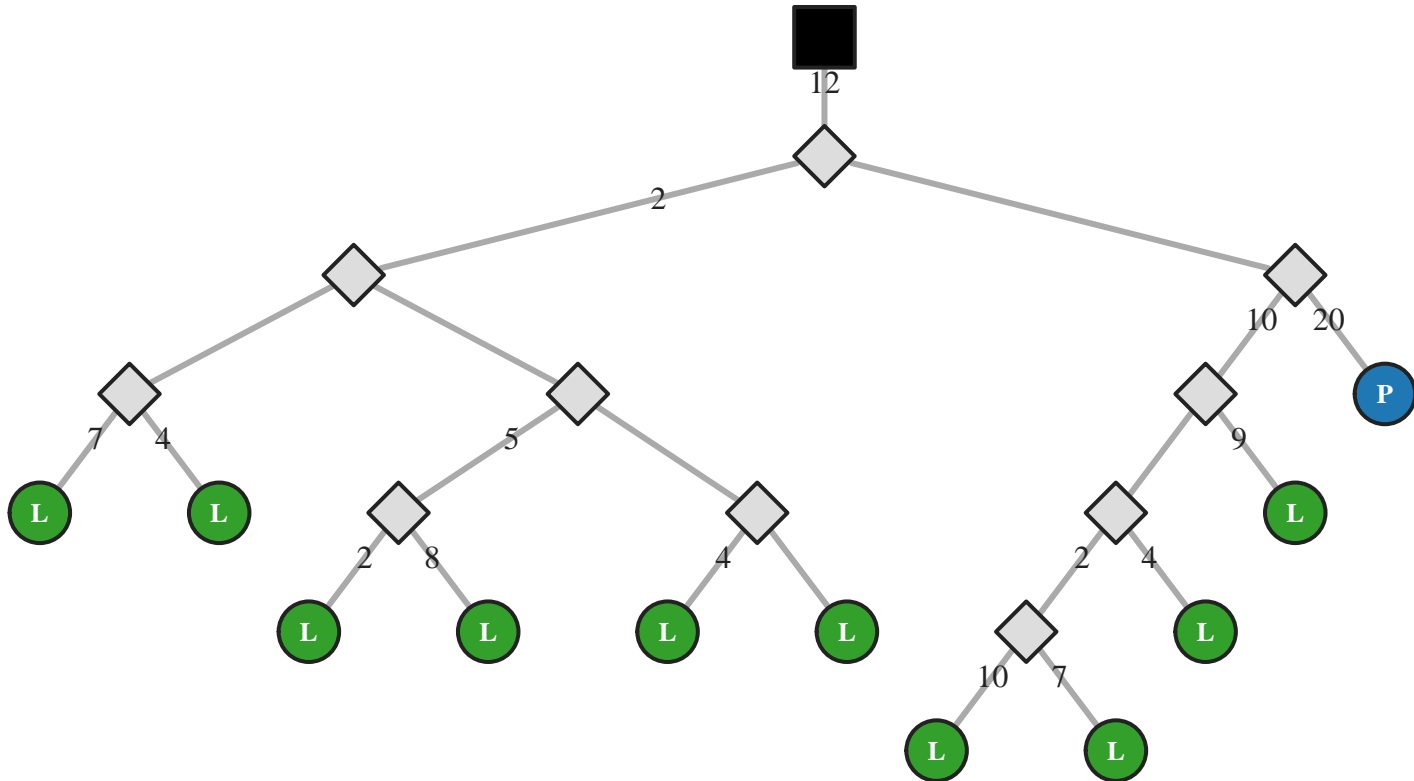

M5 IgA IGHV4-61/J4 45bp (12783)

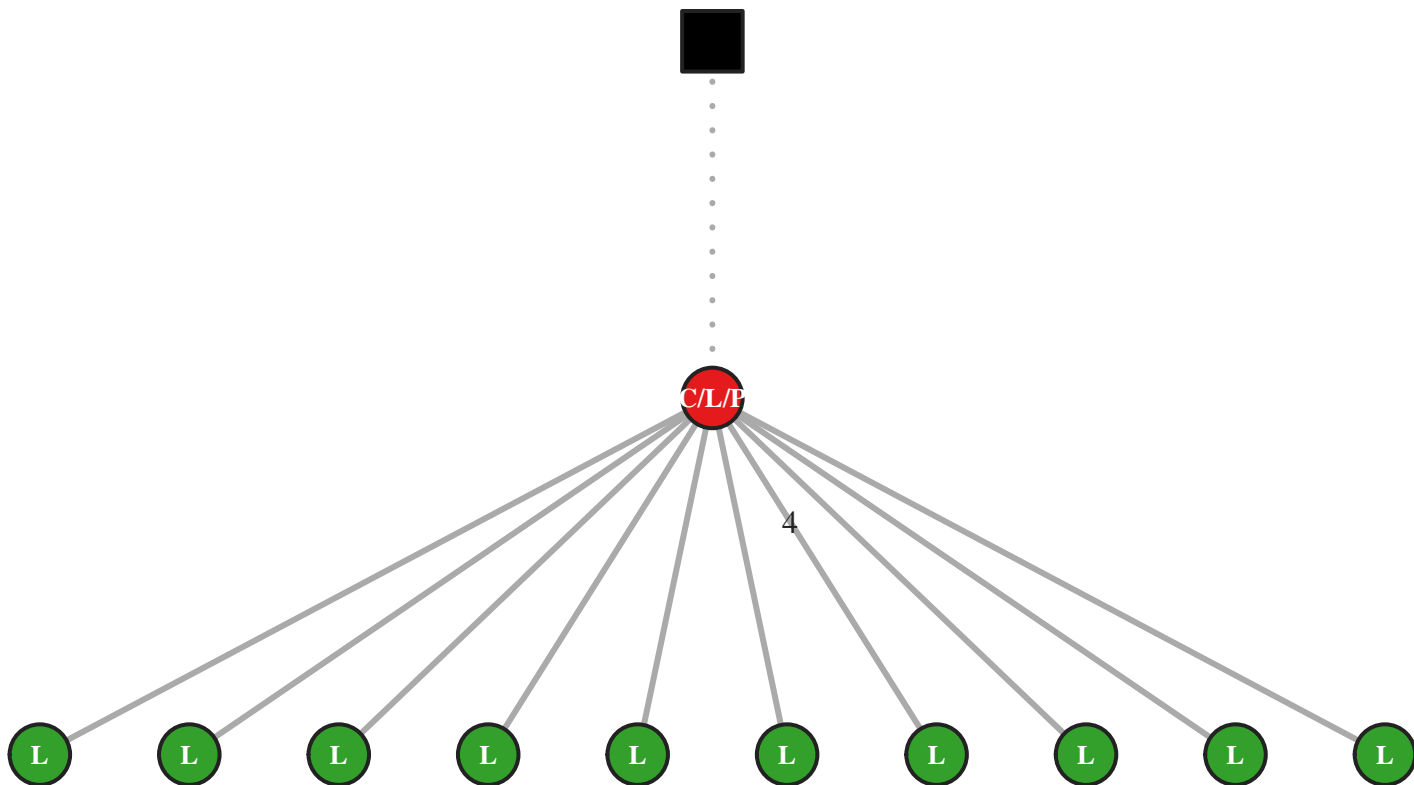

M5 IgA IGHV4-61/J4 45bp (12803)

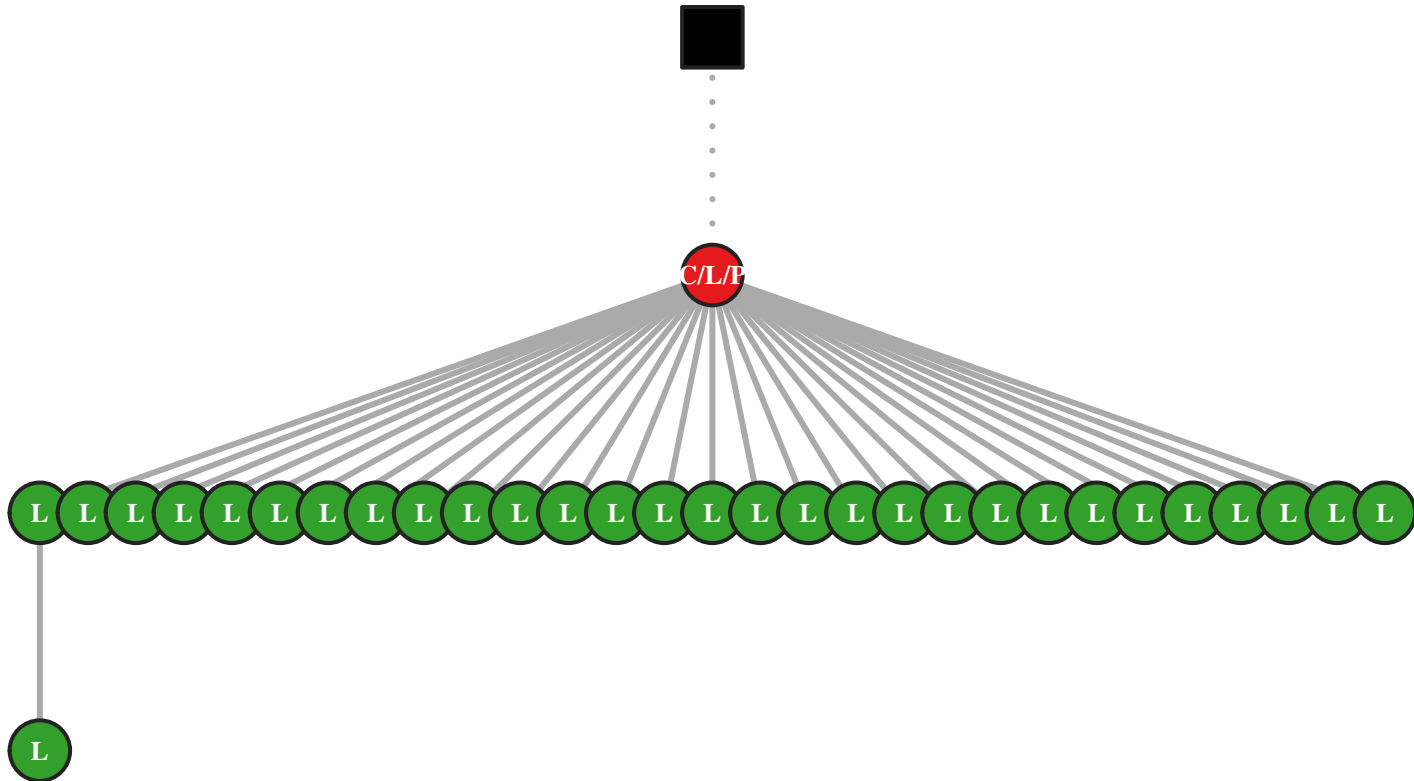

M5 IgG IGHV4-61/J4 45bp (28306)

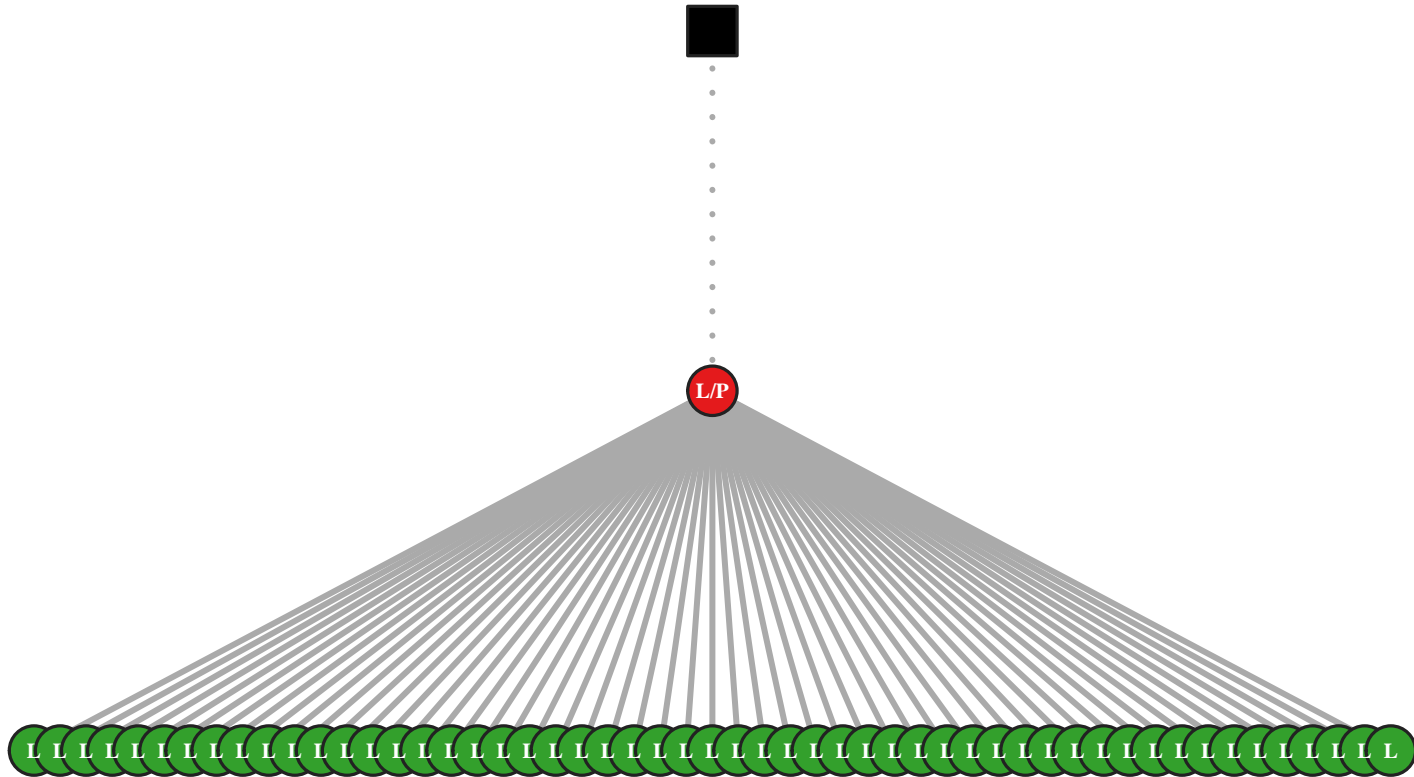

M5 IgG IGHV4-61/J4 45bp (28321)

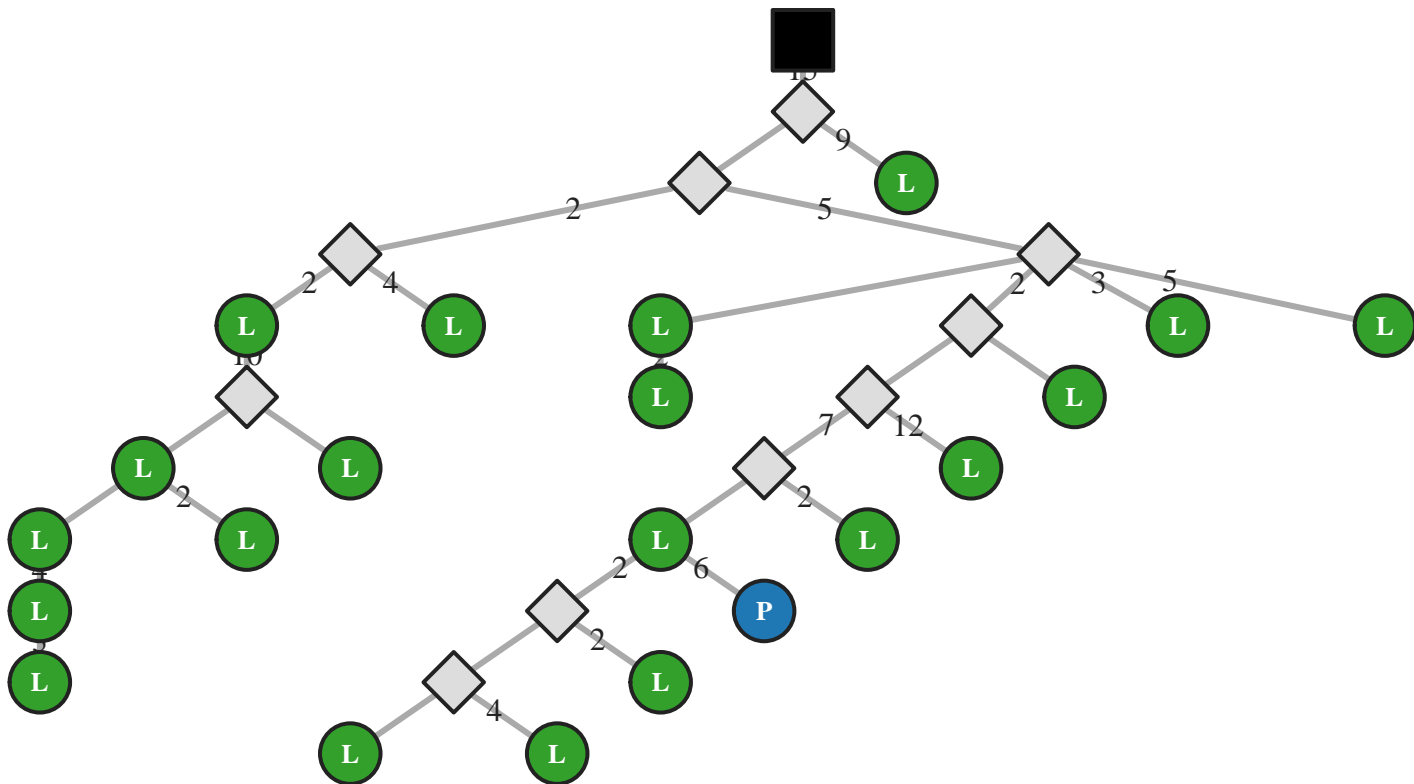

M5 IgG IGHV4-61/J4 45bp (28368)

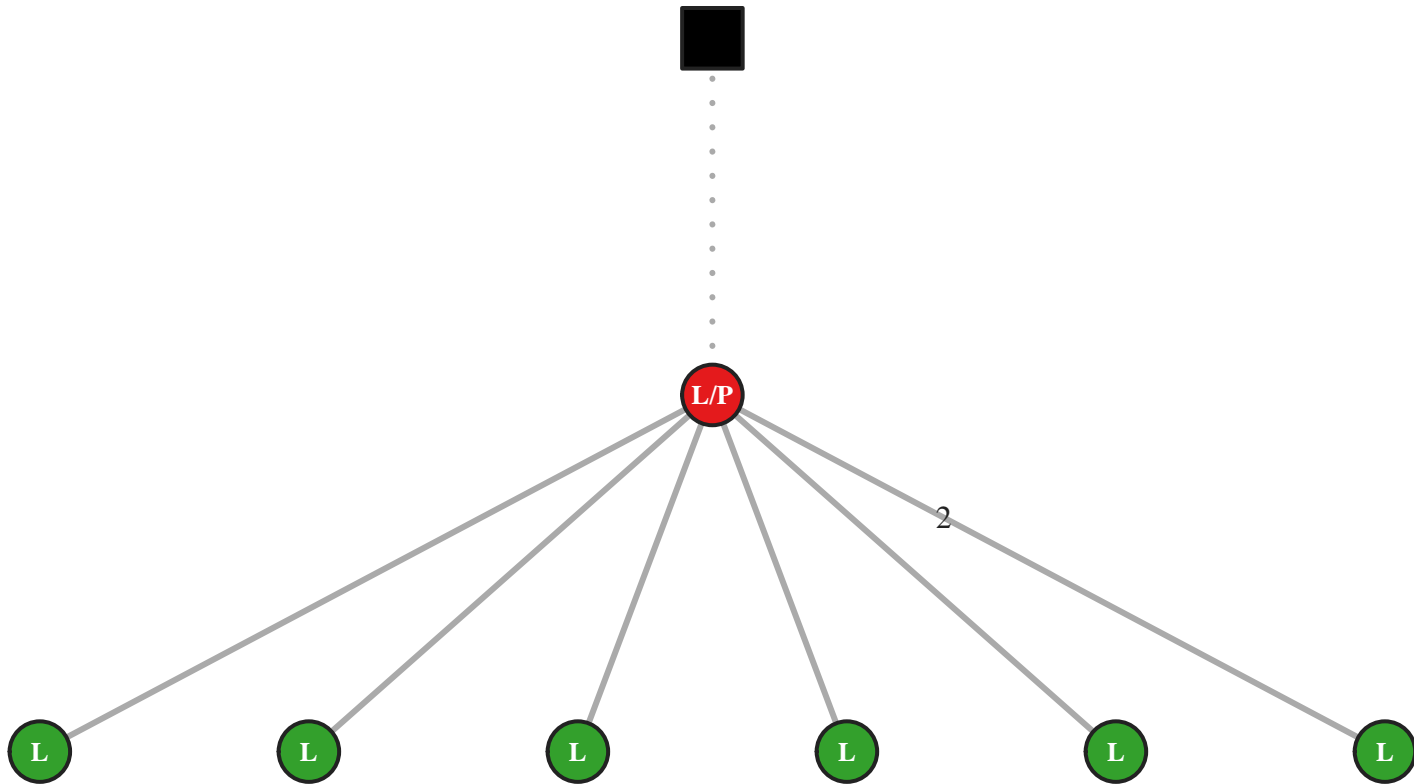

M5 IgG IGHV4-61/J4 45bp (28380)

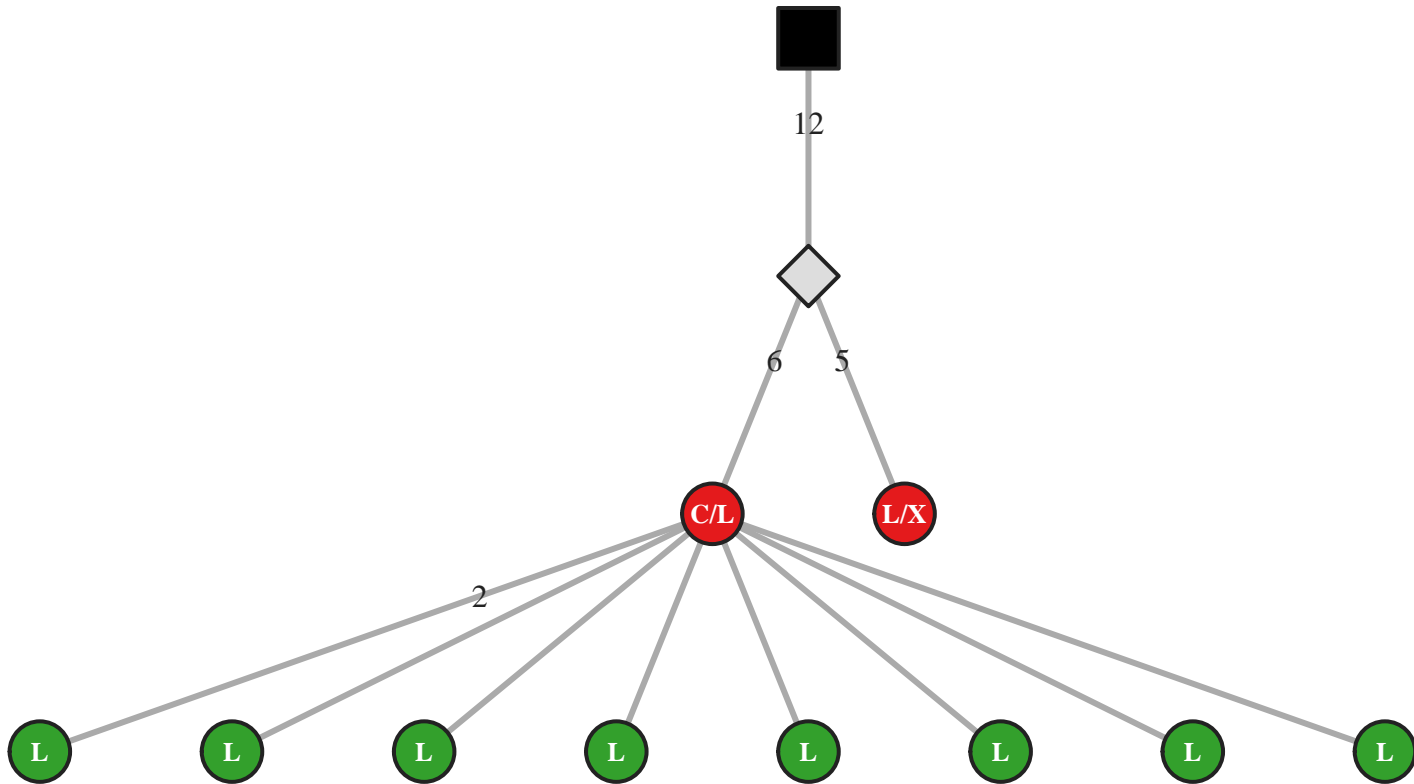

M5 IgG IGHV4-61/J4 45bp (28391)

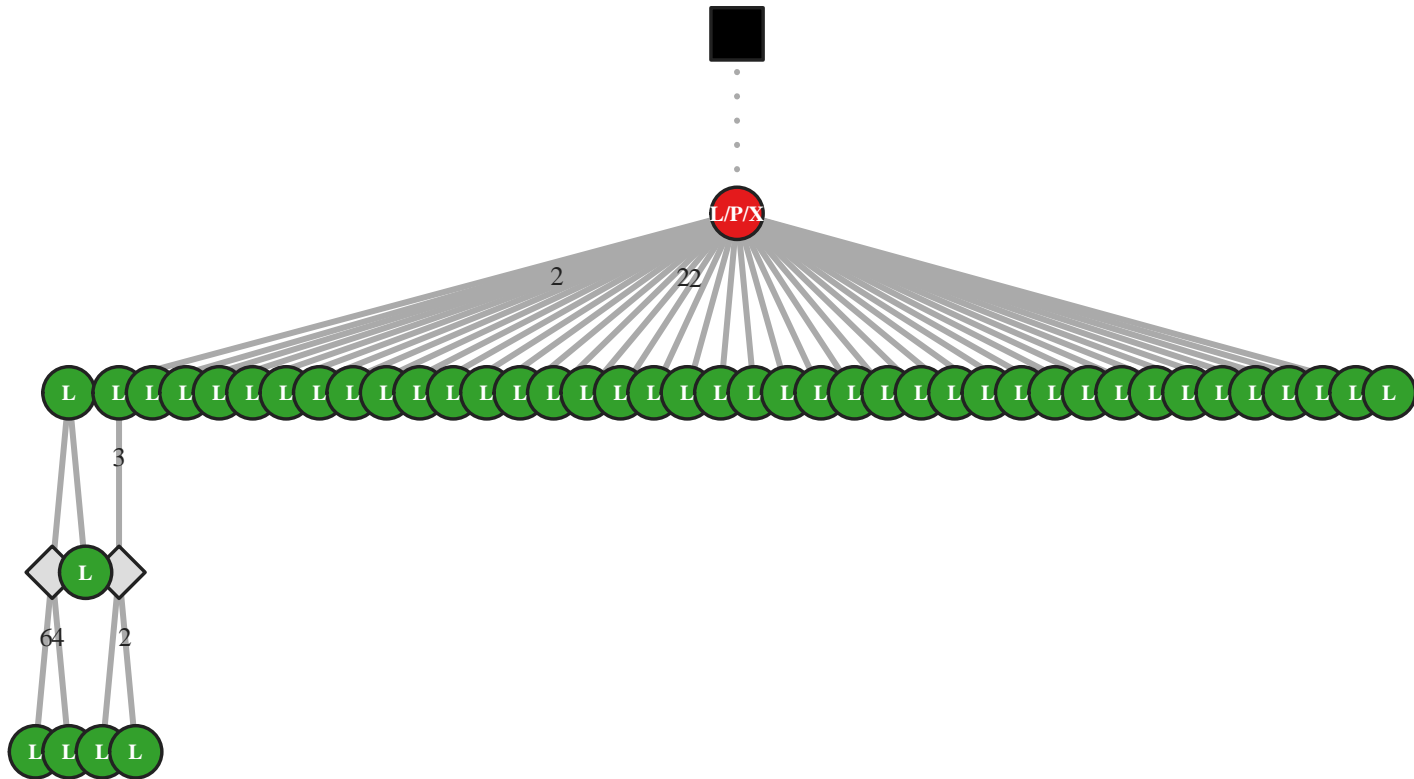

M5 IgG IGHV4-61/J4 48bp (19469)

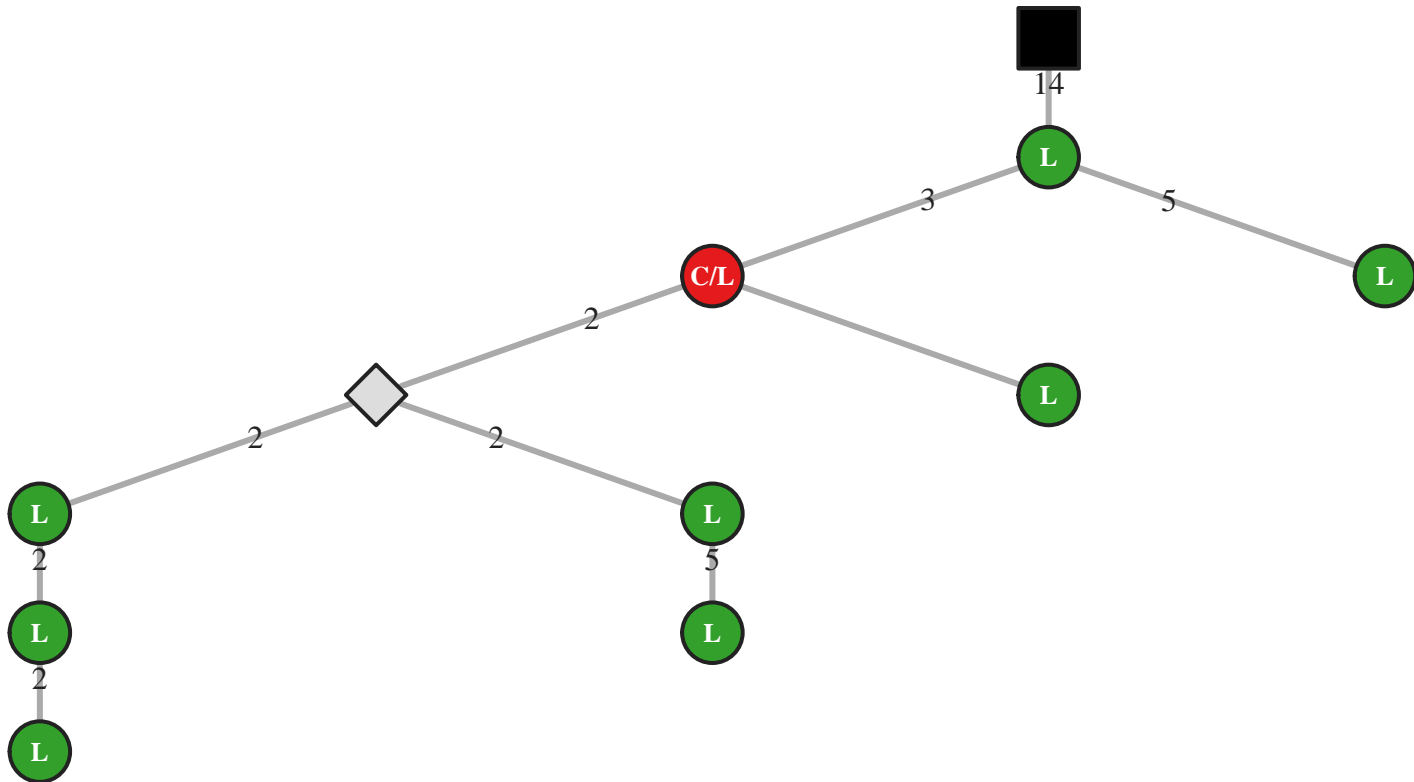

M5 IgG IGHV4-61/J4 48bp (19509)

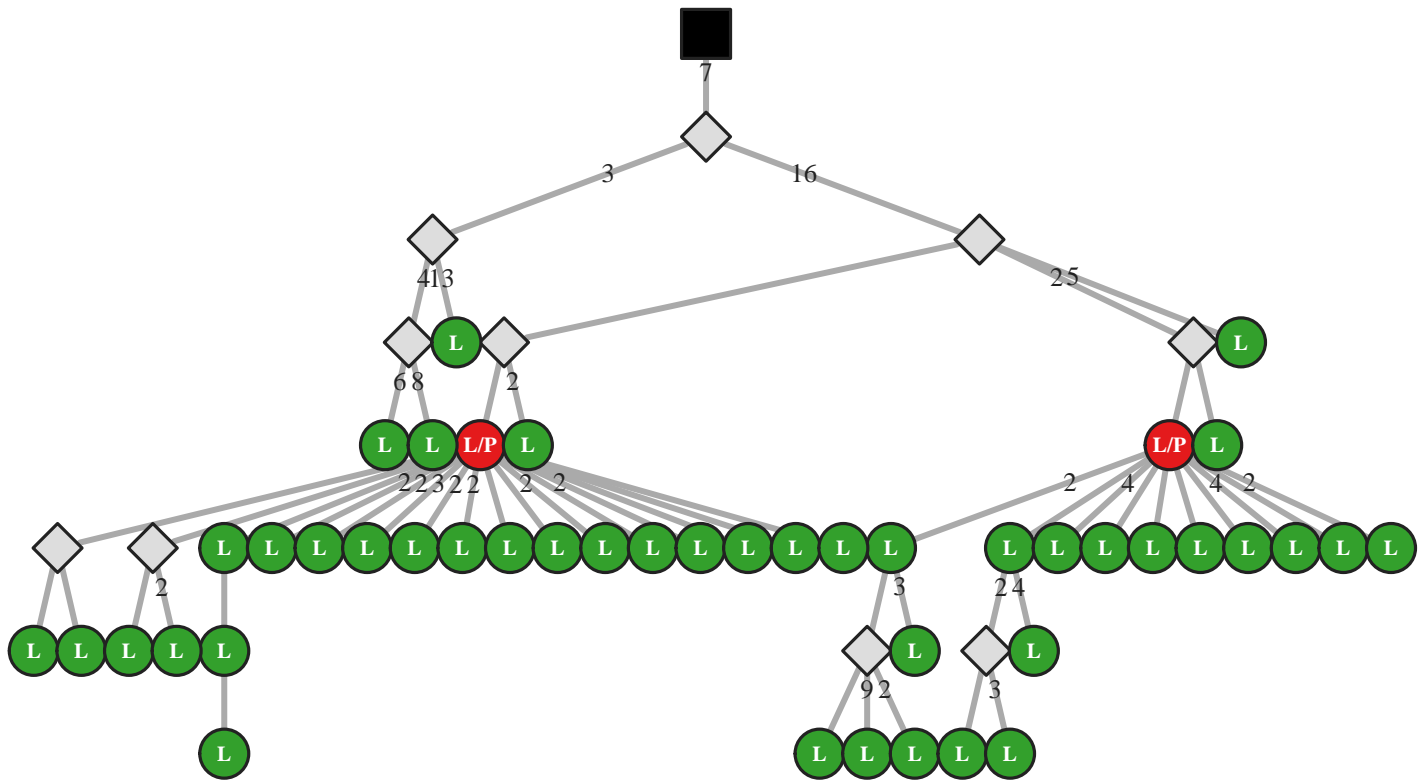

M5 IgG IGHV4-61/J4 54bp (28398)

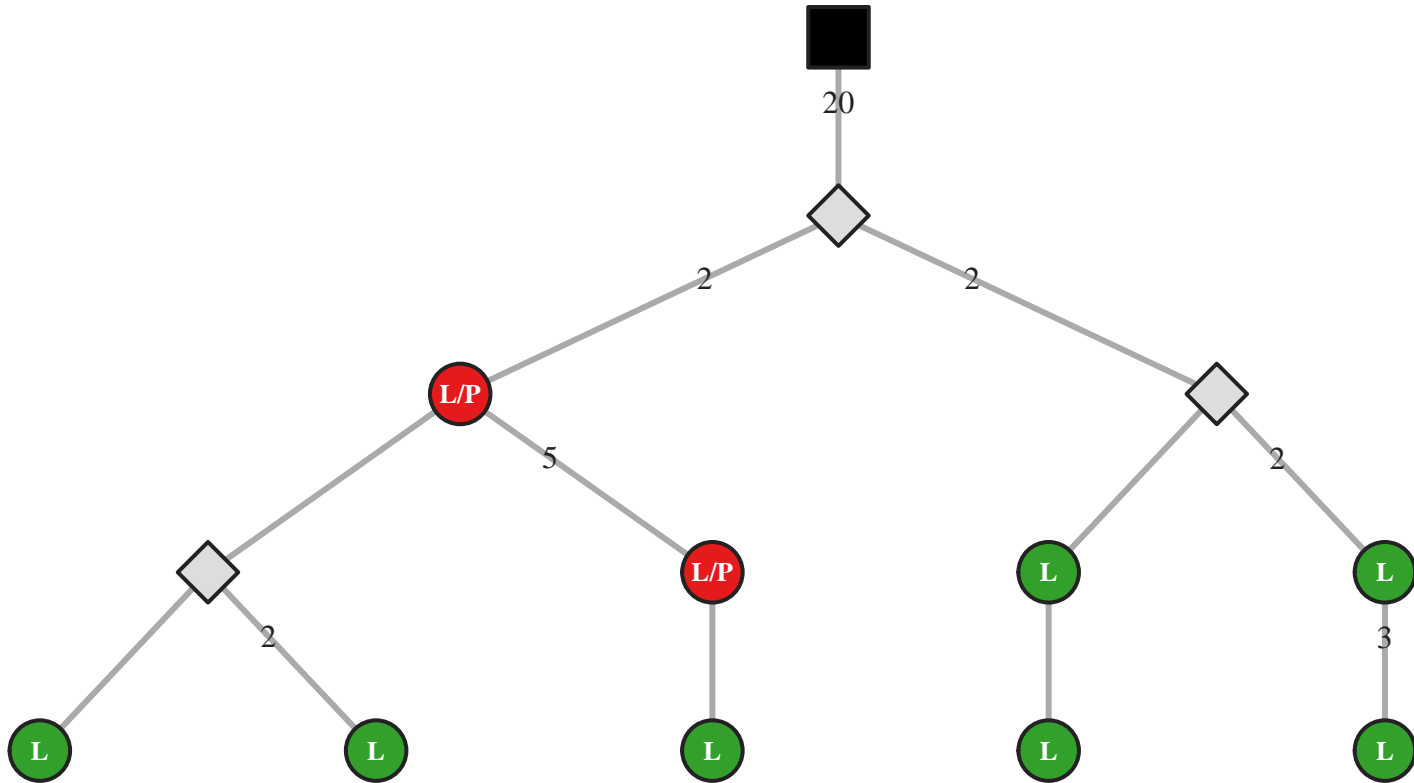

M5 IgG IGHV4-61/J5 54bp (10453)

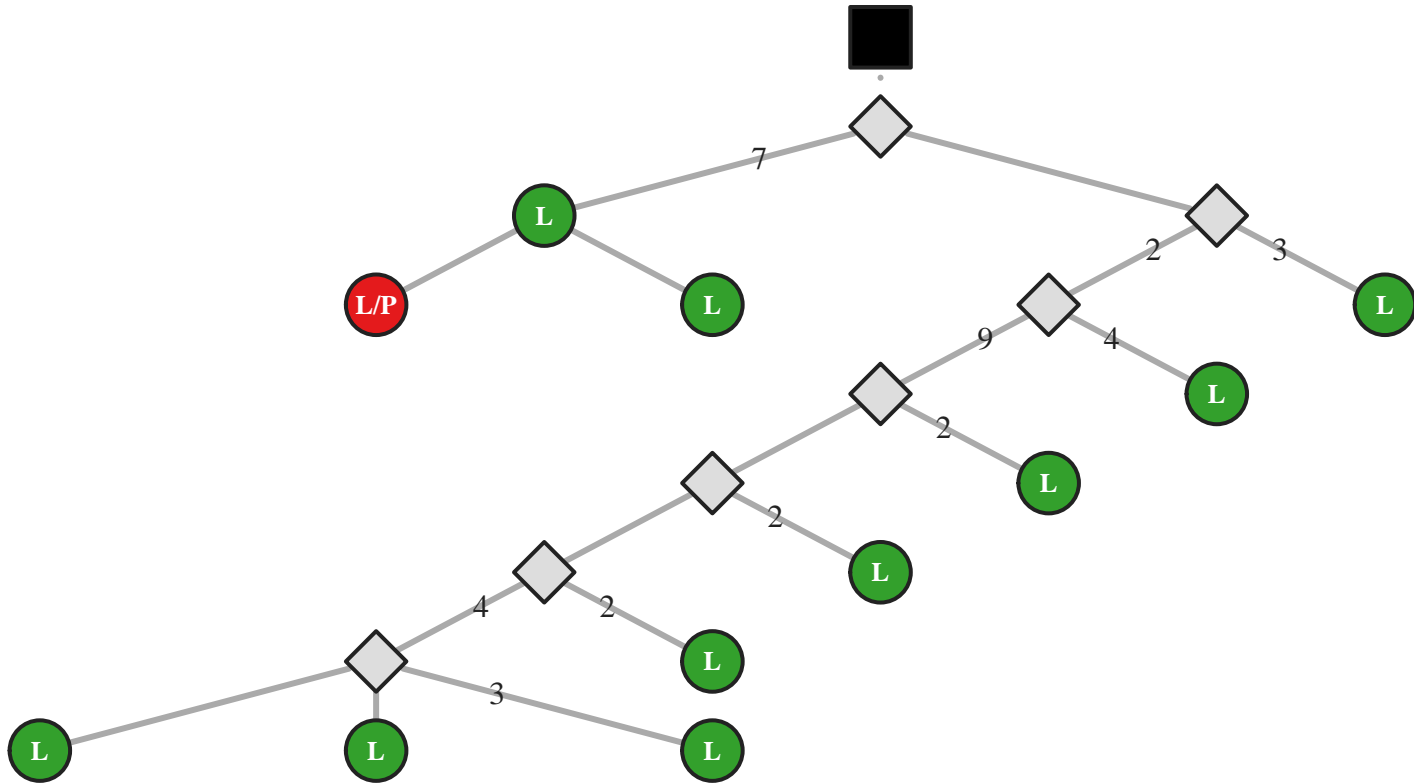

M5 IgG IGHV4-61/J5 57bp (28671)

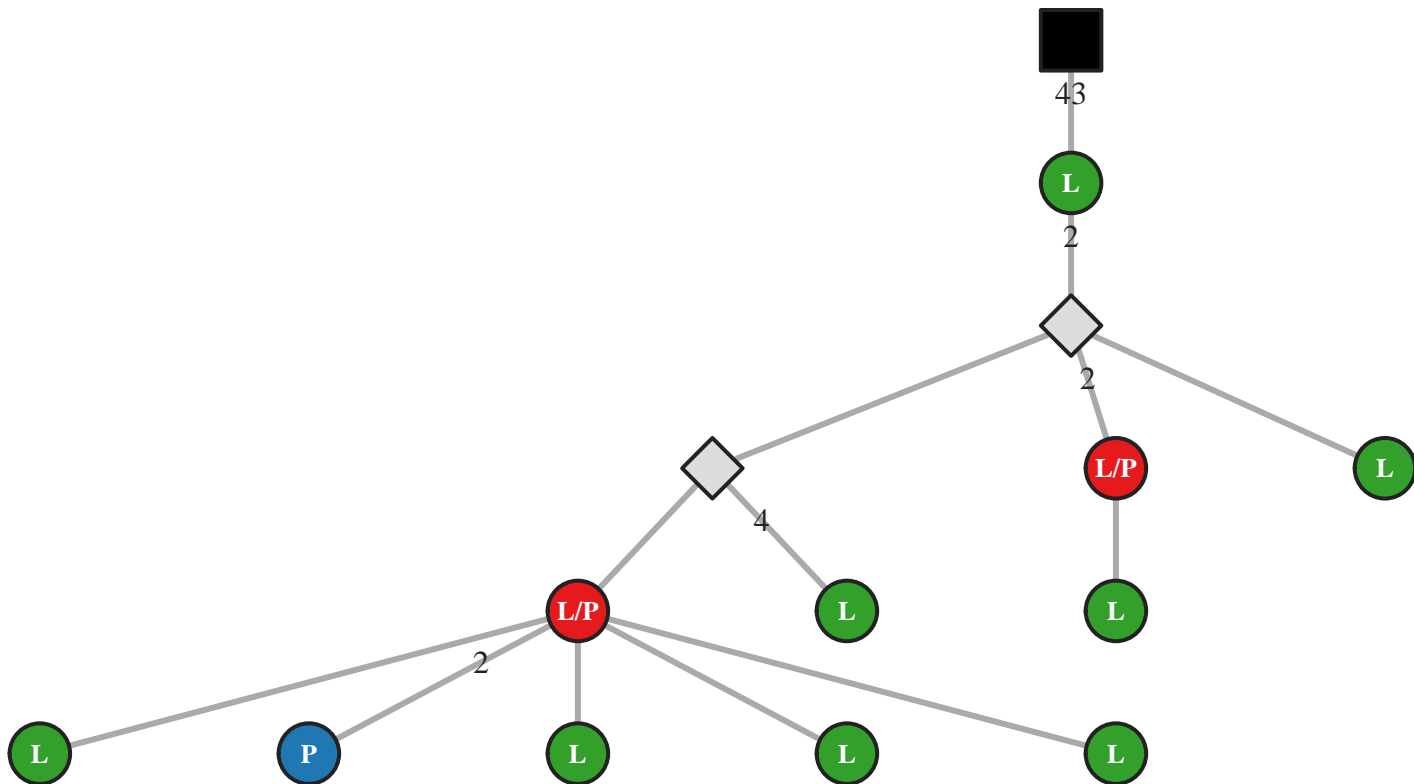

M5 IgG IGHV4-61/J6 66bp (46990)

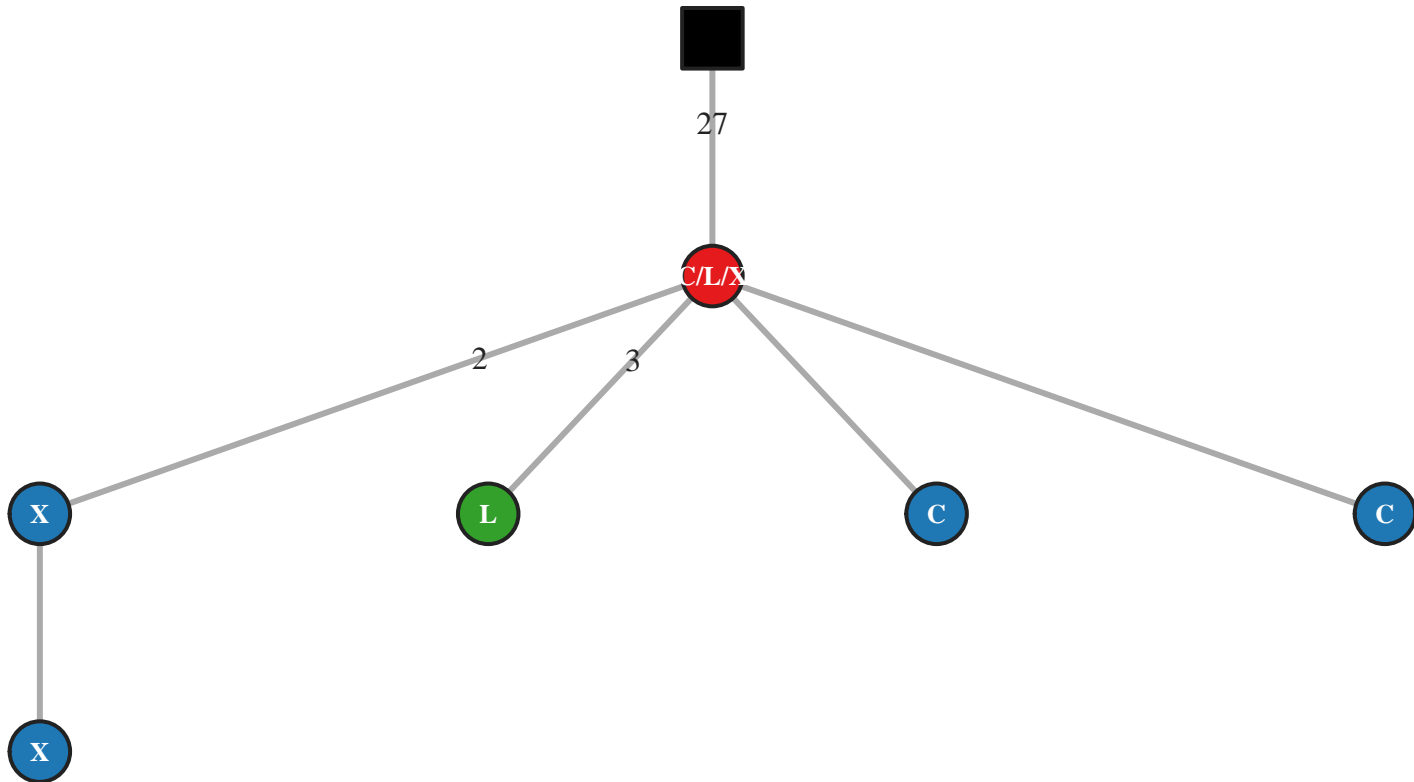

M5 IgM IGHV4-61/J6 69bp (54346)

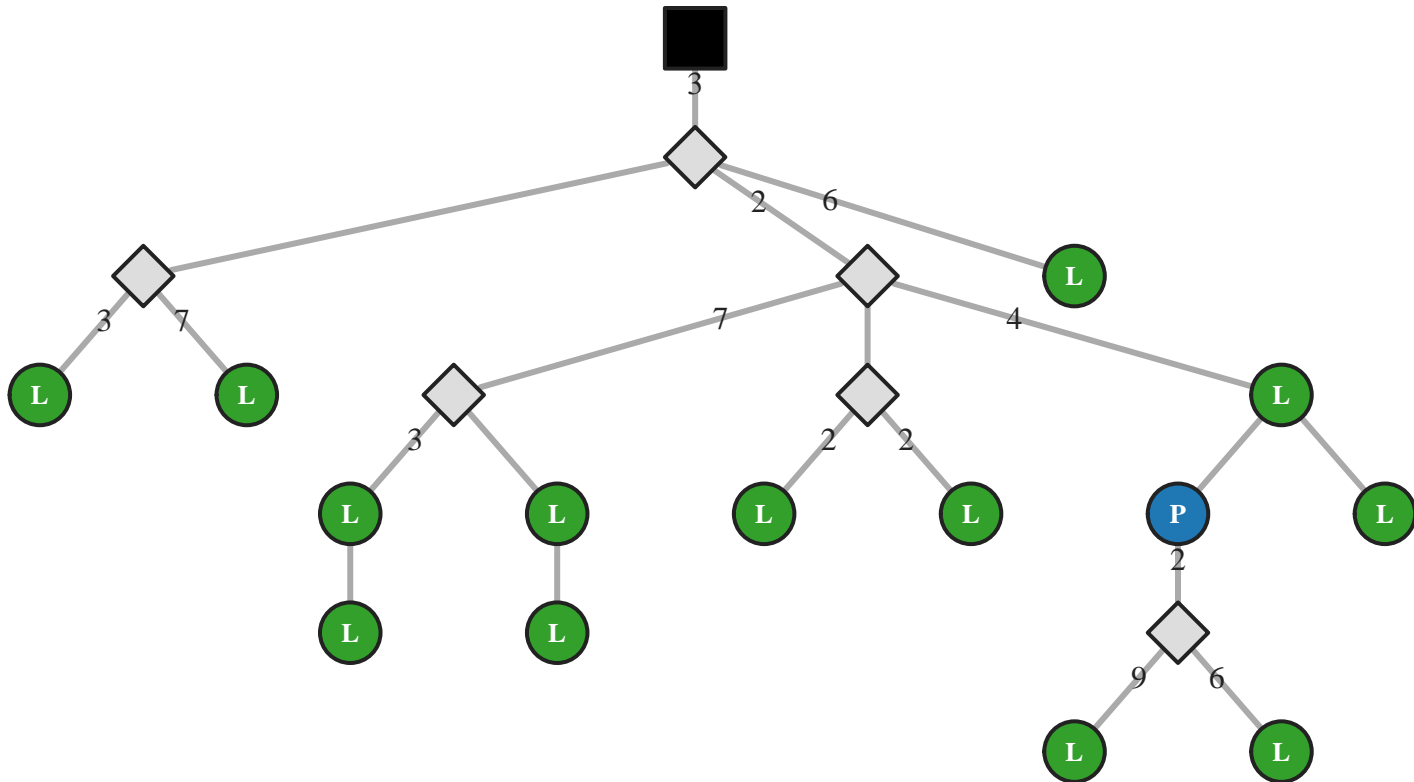

M5 IgG IGHV4-61/J6 72bp (19431)

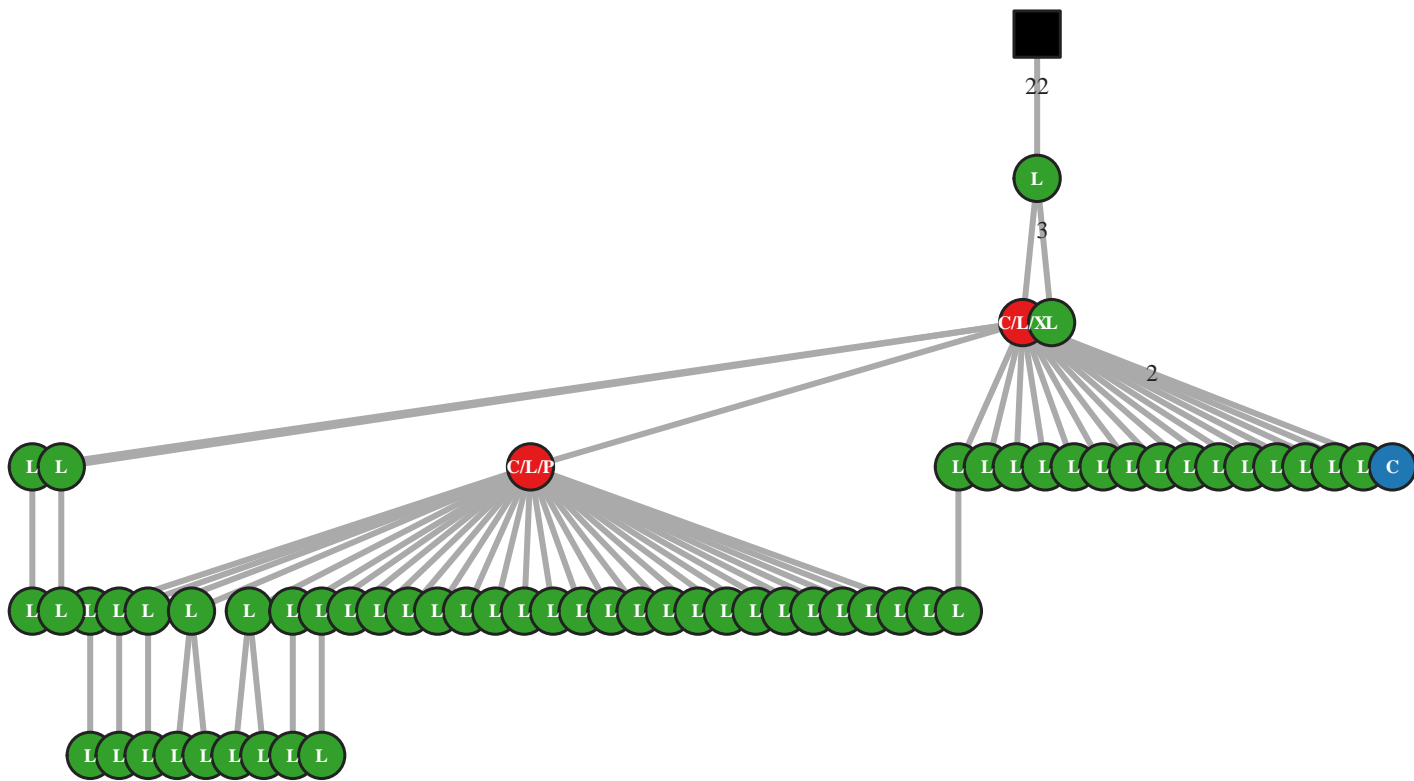

M5 IgG IGHV5-51/J1 42bp (36728)

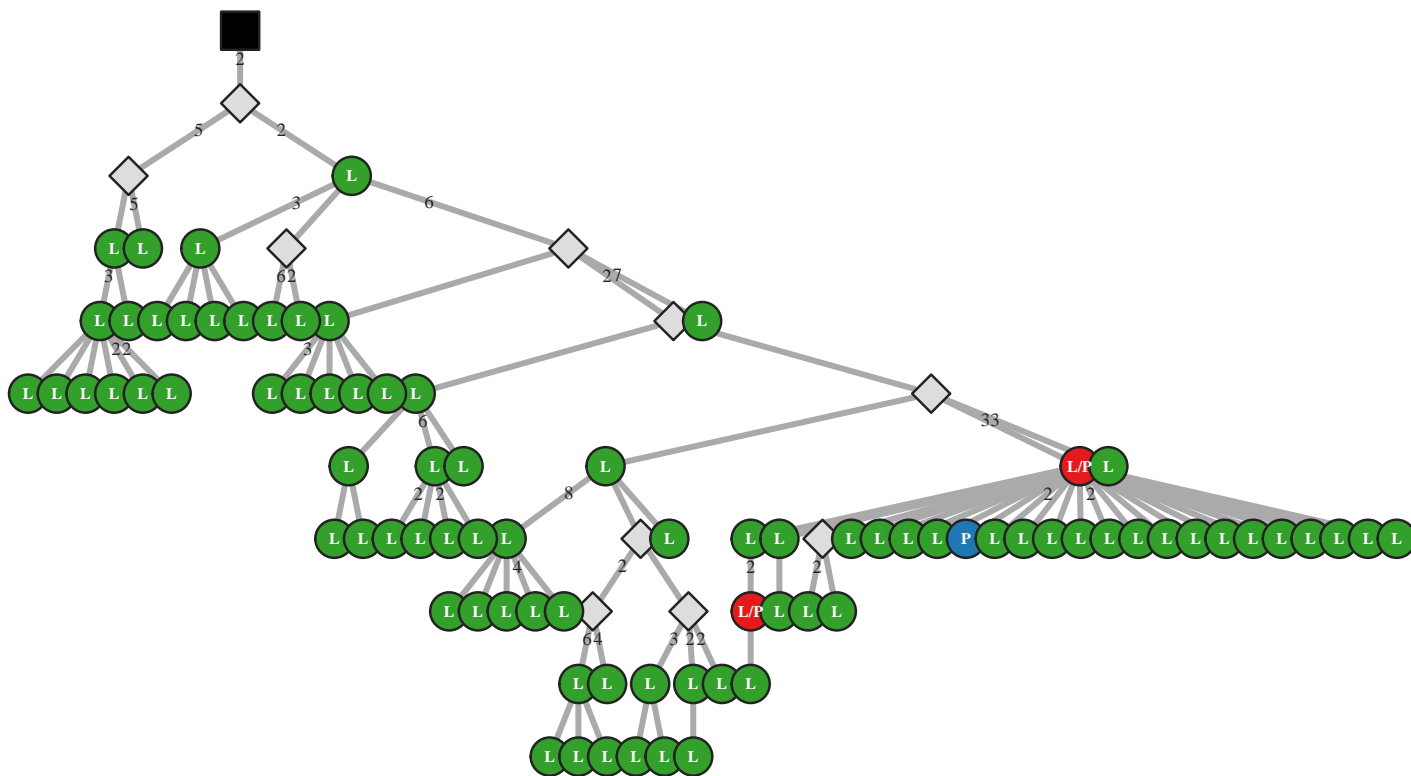

M5 IgG IGHV5-51/J1 63bp (36739)

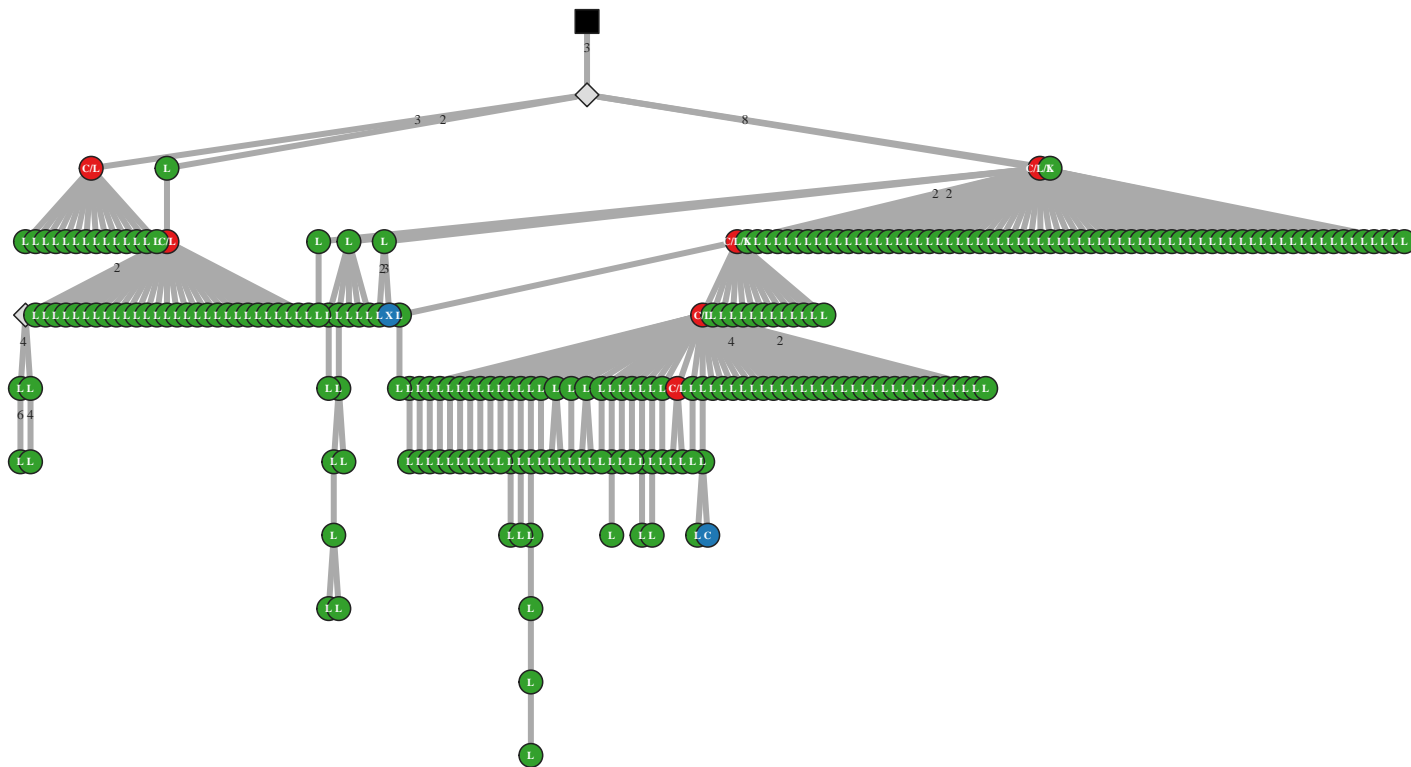

M5 IgG IGHV5-51/J2 45bp (10465)

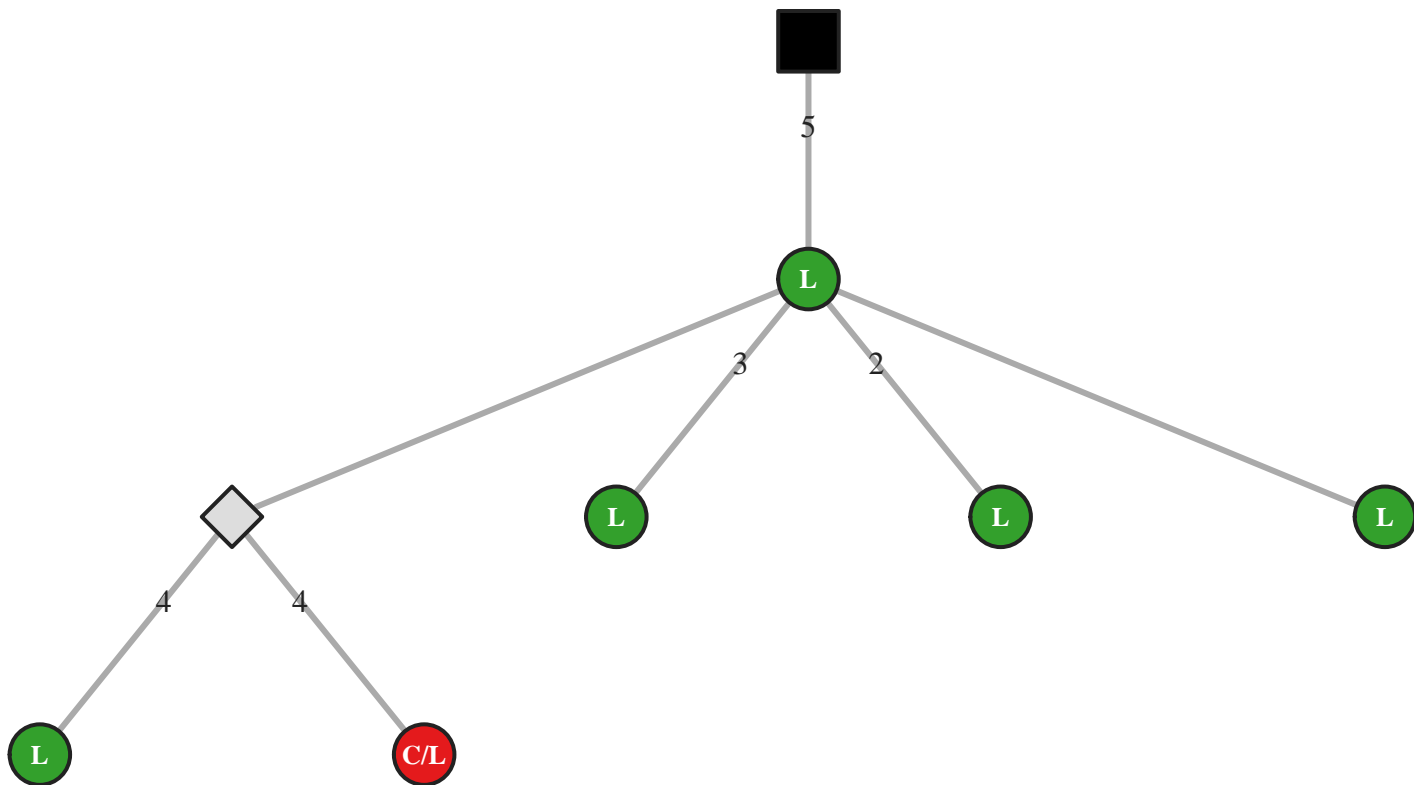

M5 IgG IGHV5-51/J2 54bp (47011)

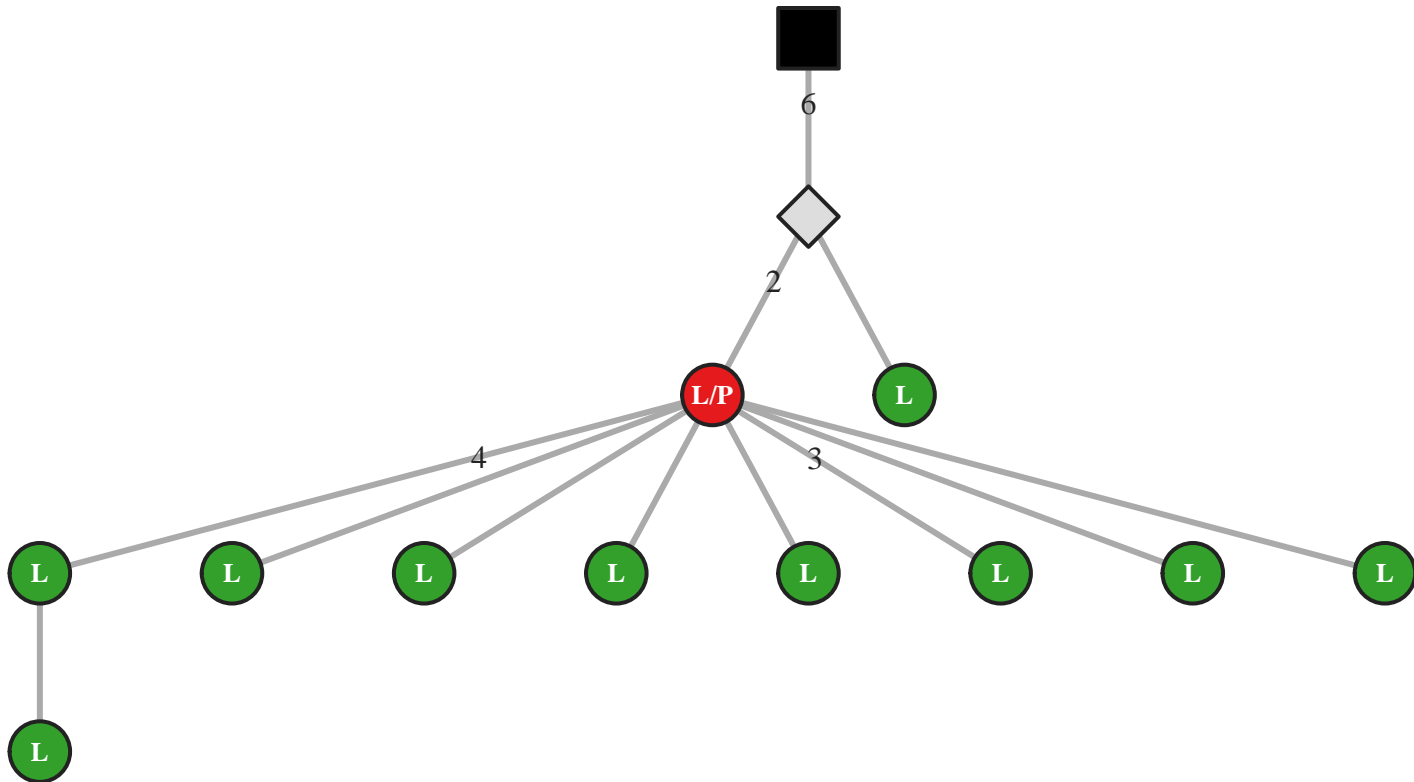

M5 IgG IGHV5-51/J2 66bp (53502)

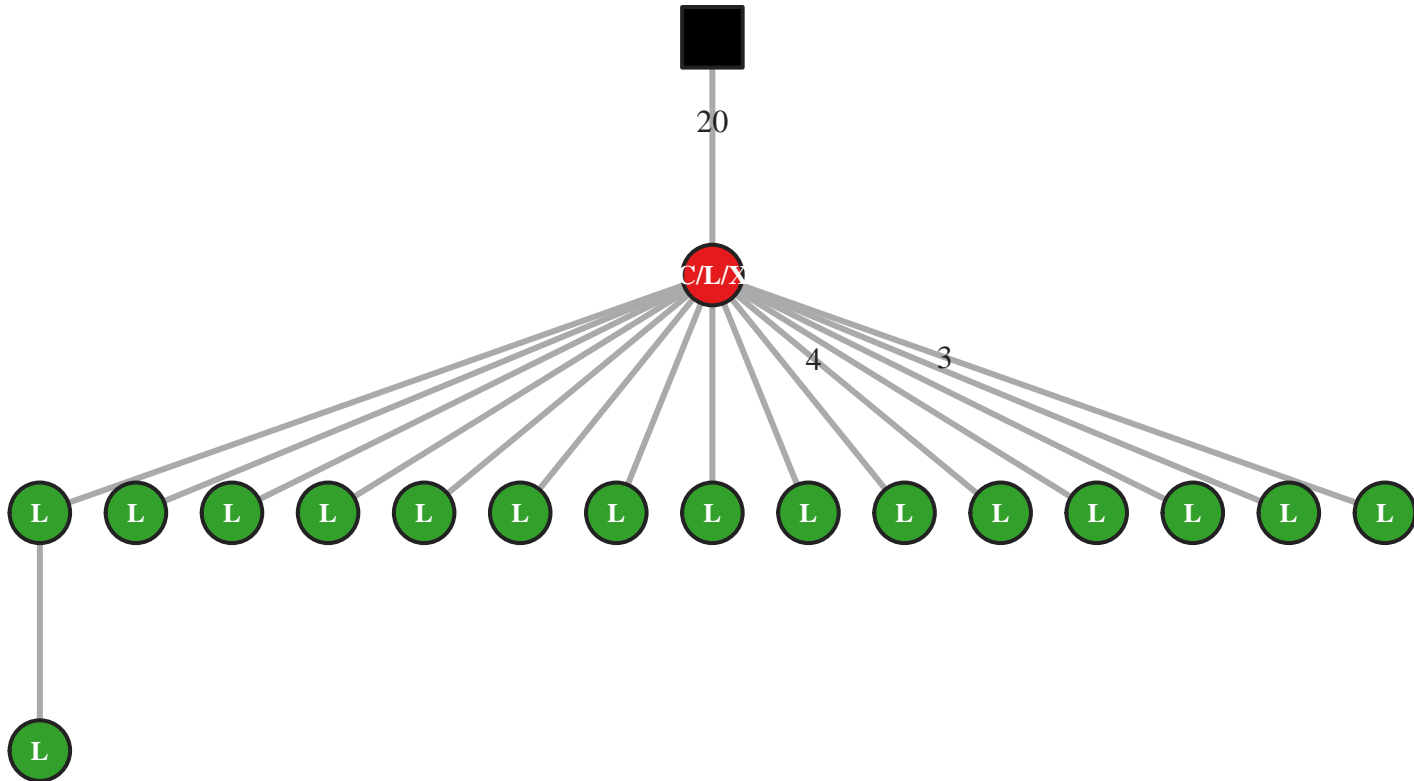

M5 IgM IGHV5-51/J2 66bp (11690)

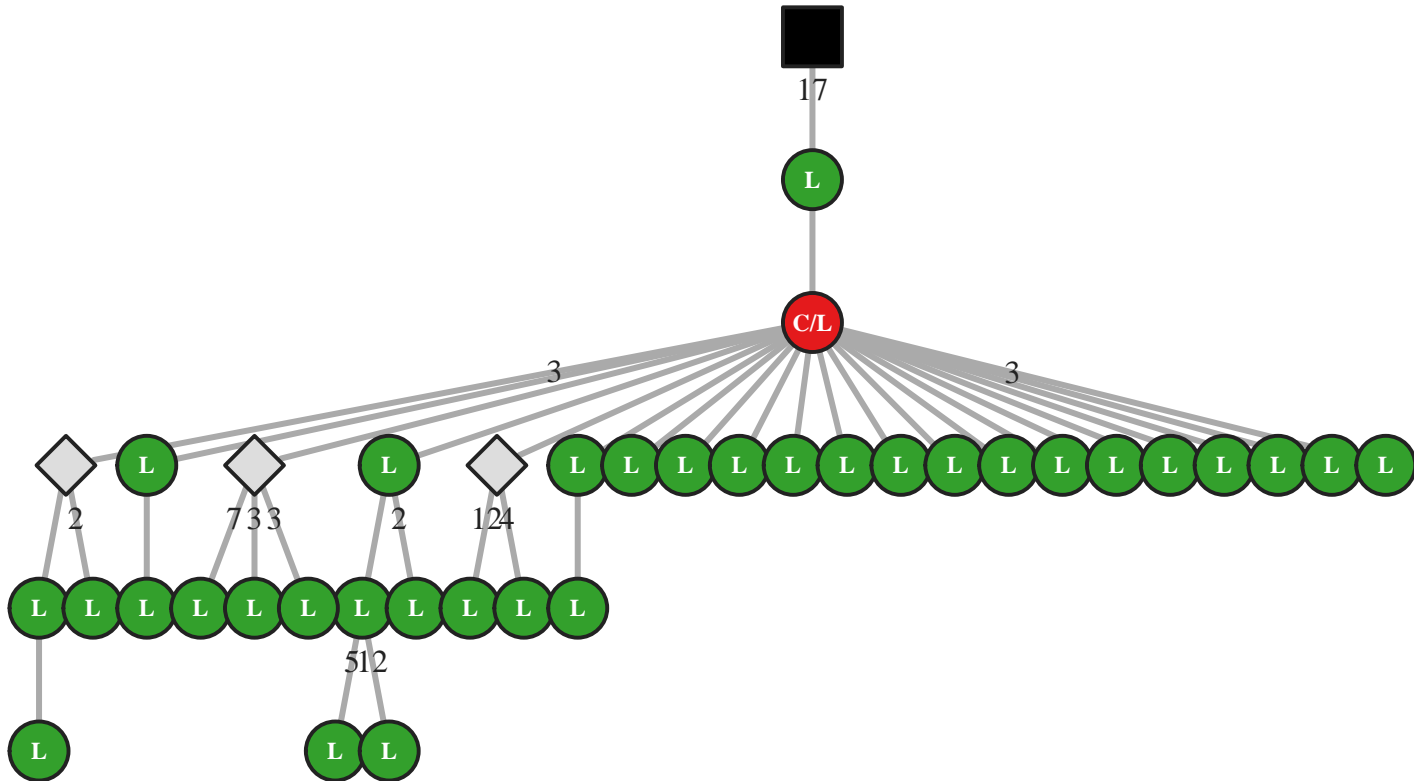

M5 IgG IGHV5-51/J3 42bp (19545)

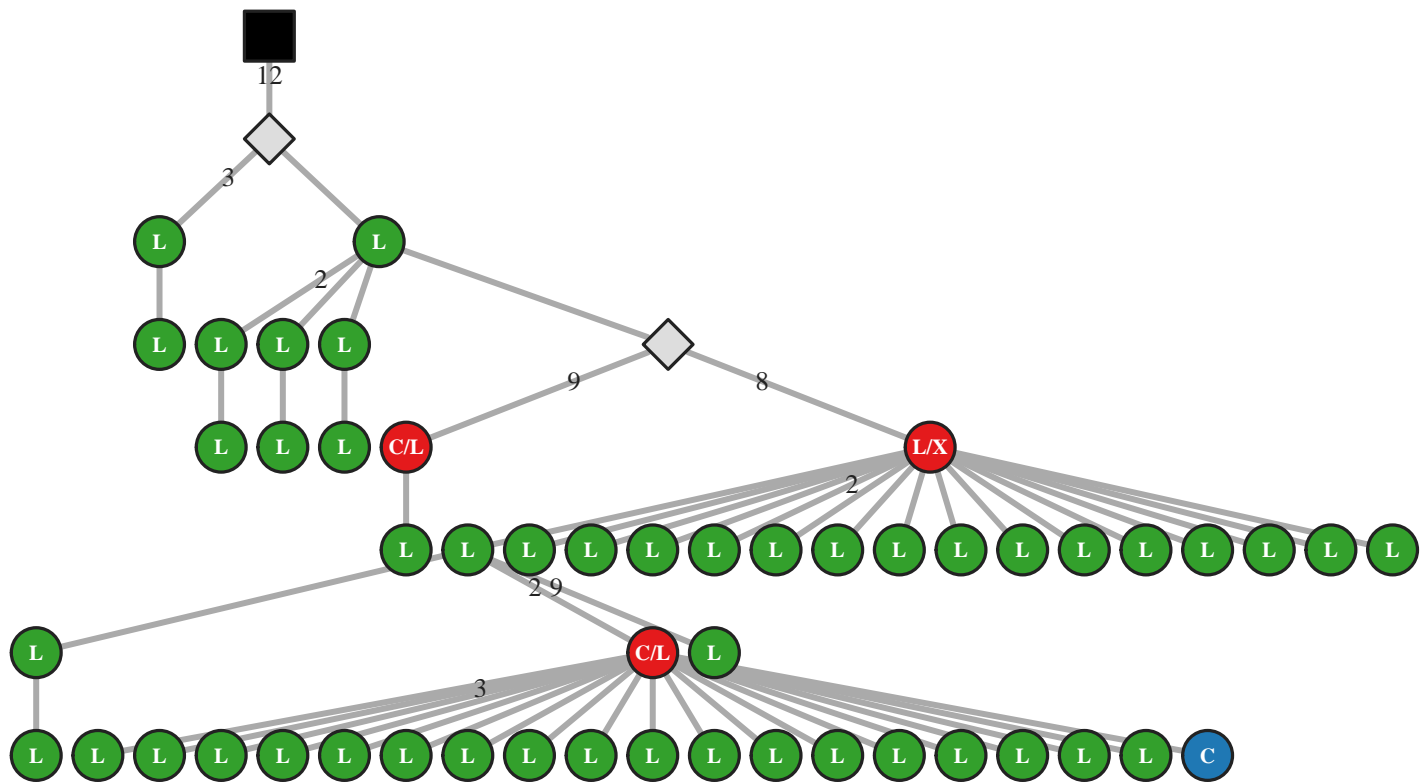

M5 IgG IGHV5-51/J3 45bp (36766)

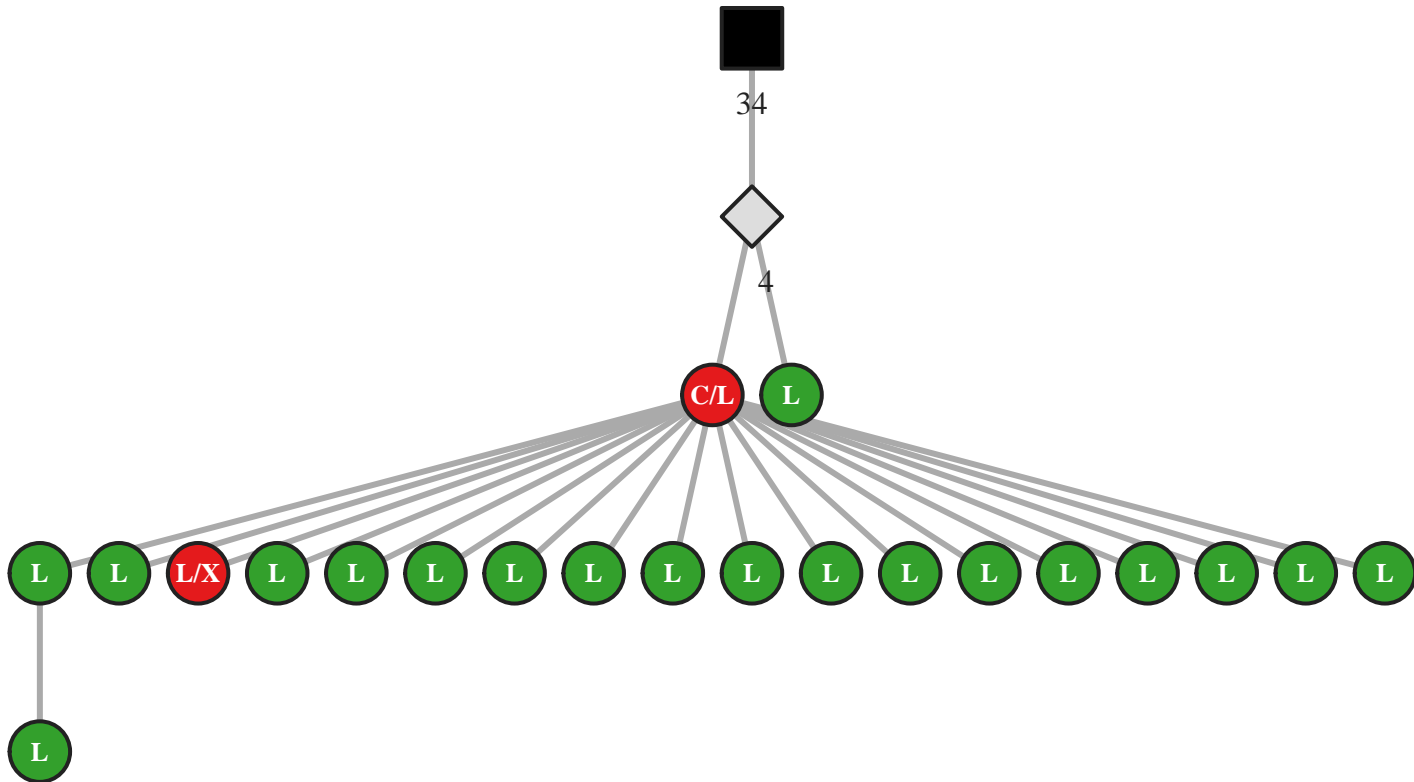

M5 IgG IGHV5-51/J3 45bp (36767)

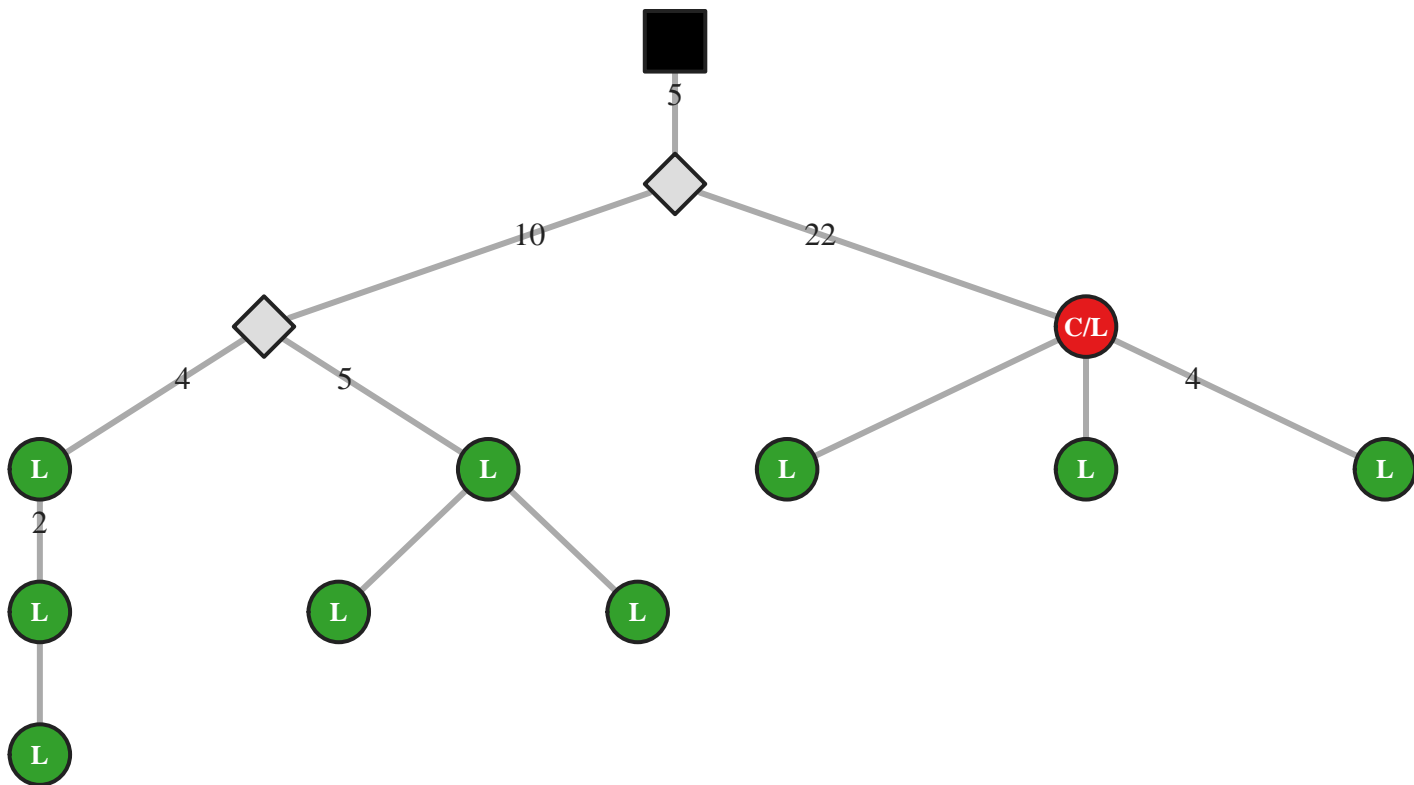

M5 IgG IGHV5-51/J3 45bp (36771)

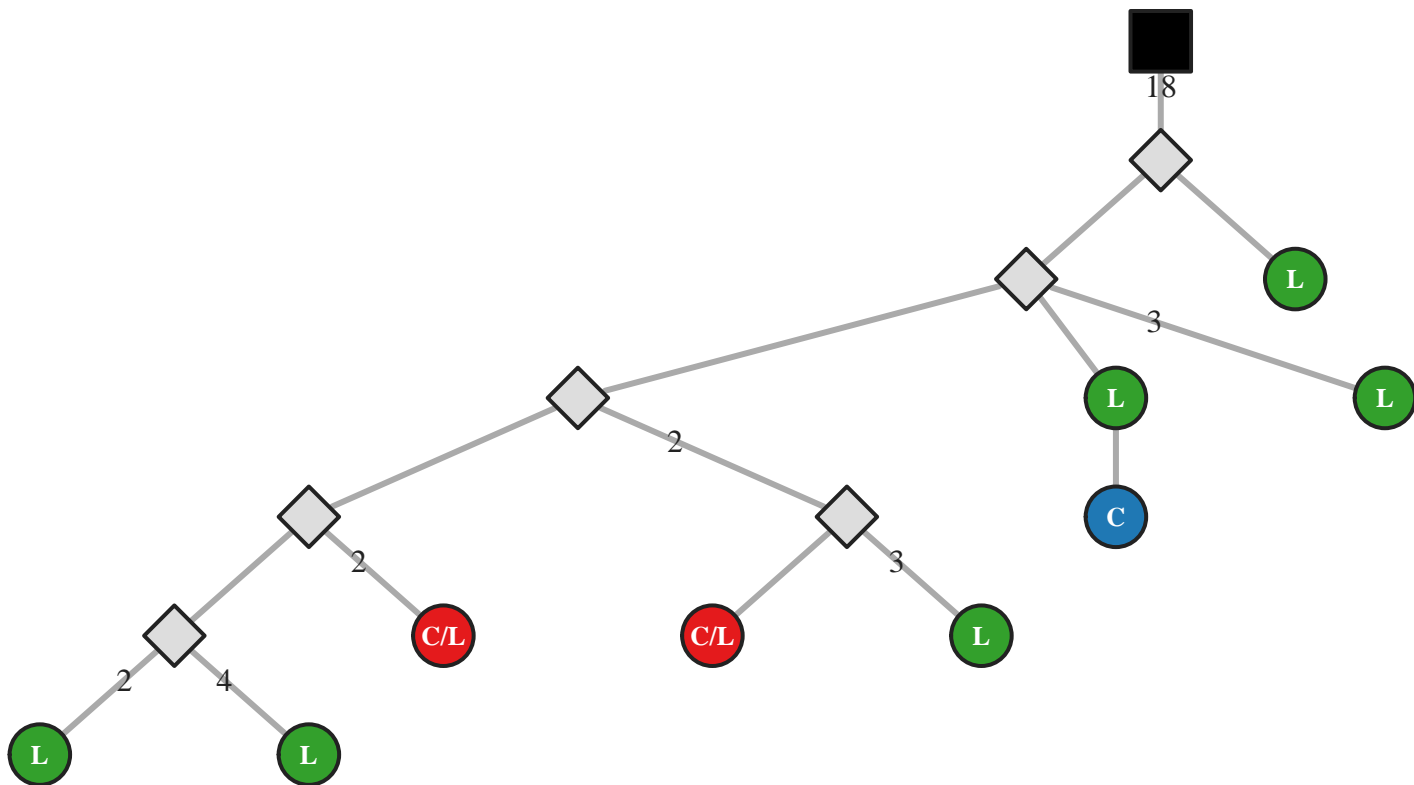

M5 IgG IGHV5-51/J3 45bp (36775)

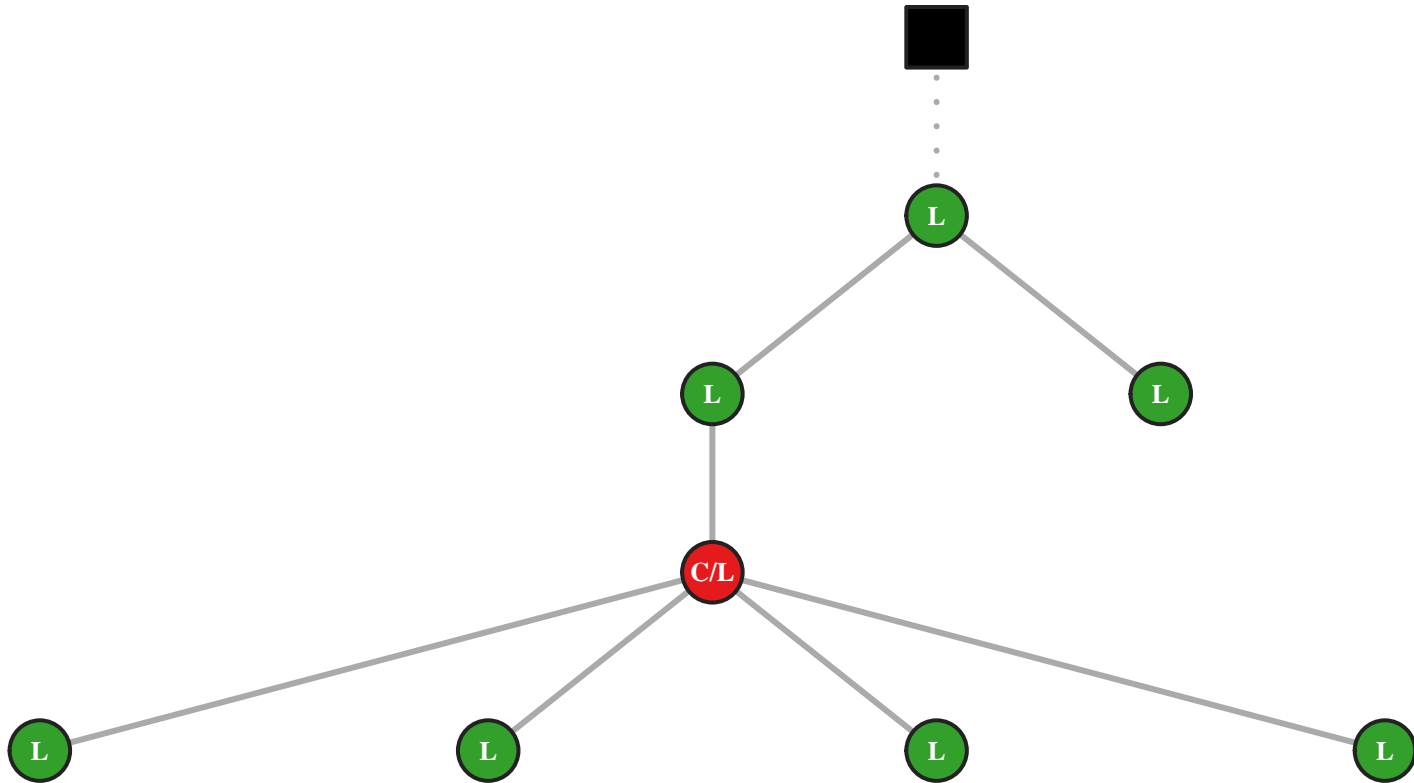

M5 IgG IGHV5-51/J3 48bp (53544)

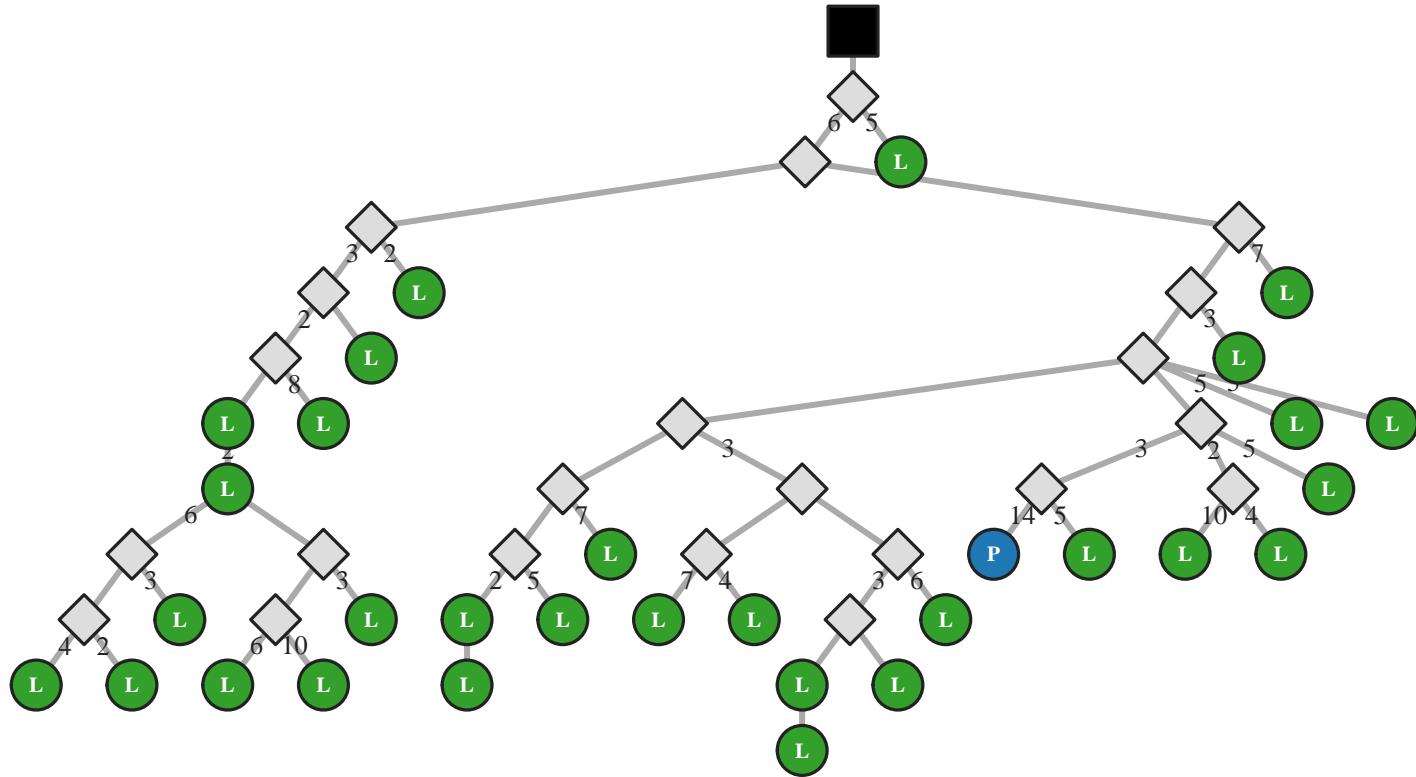

M5 IgG IGHV5-51/J3 48bp (53553)

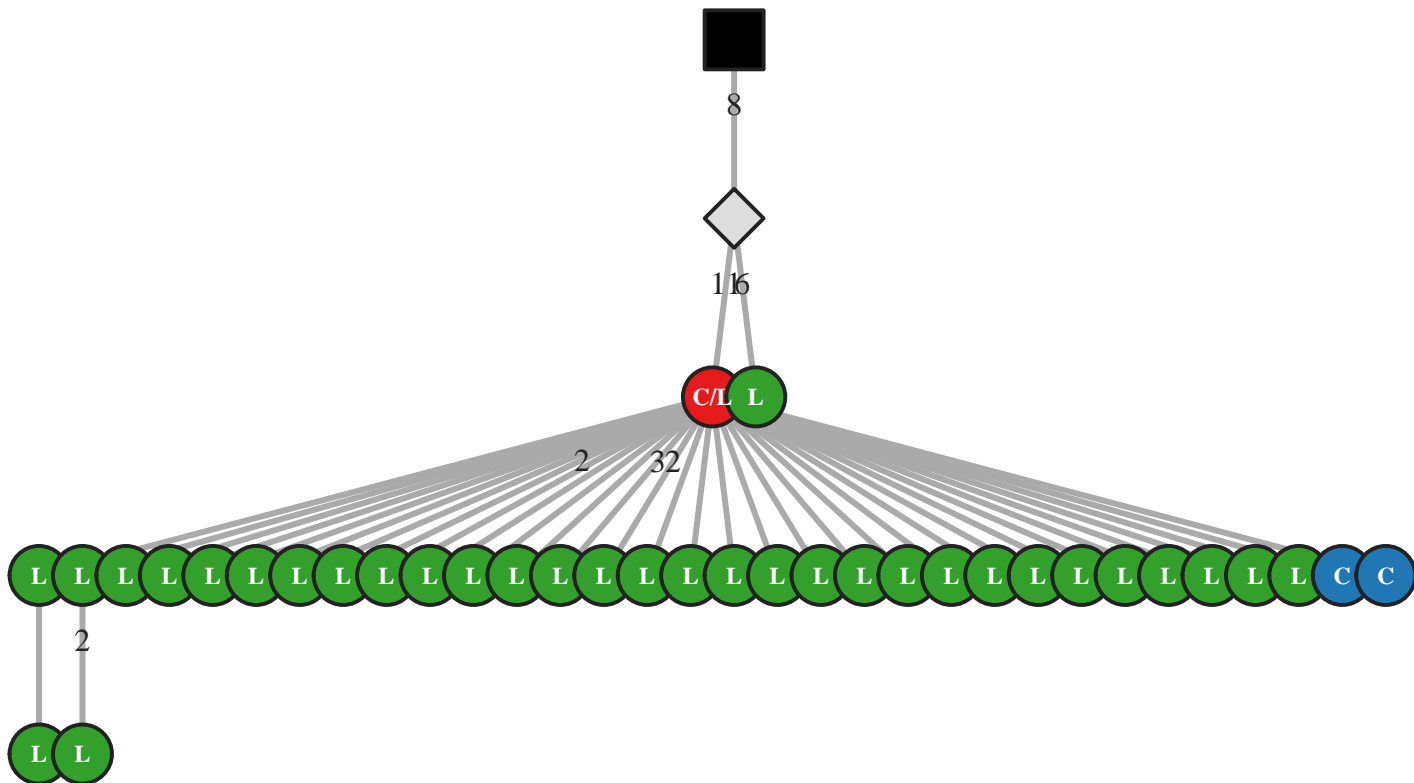

M5 IgG IGHV5-51/J3 48bp (53569)

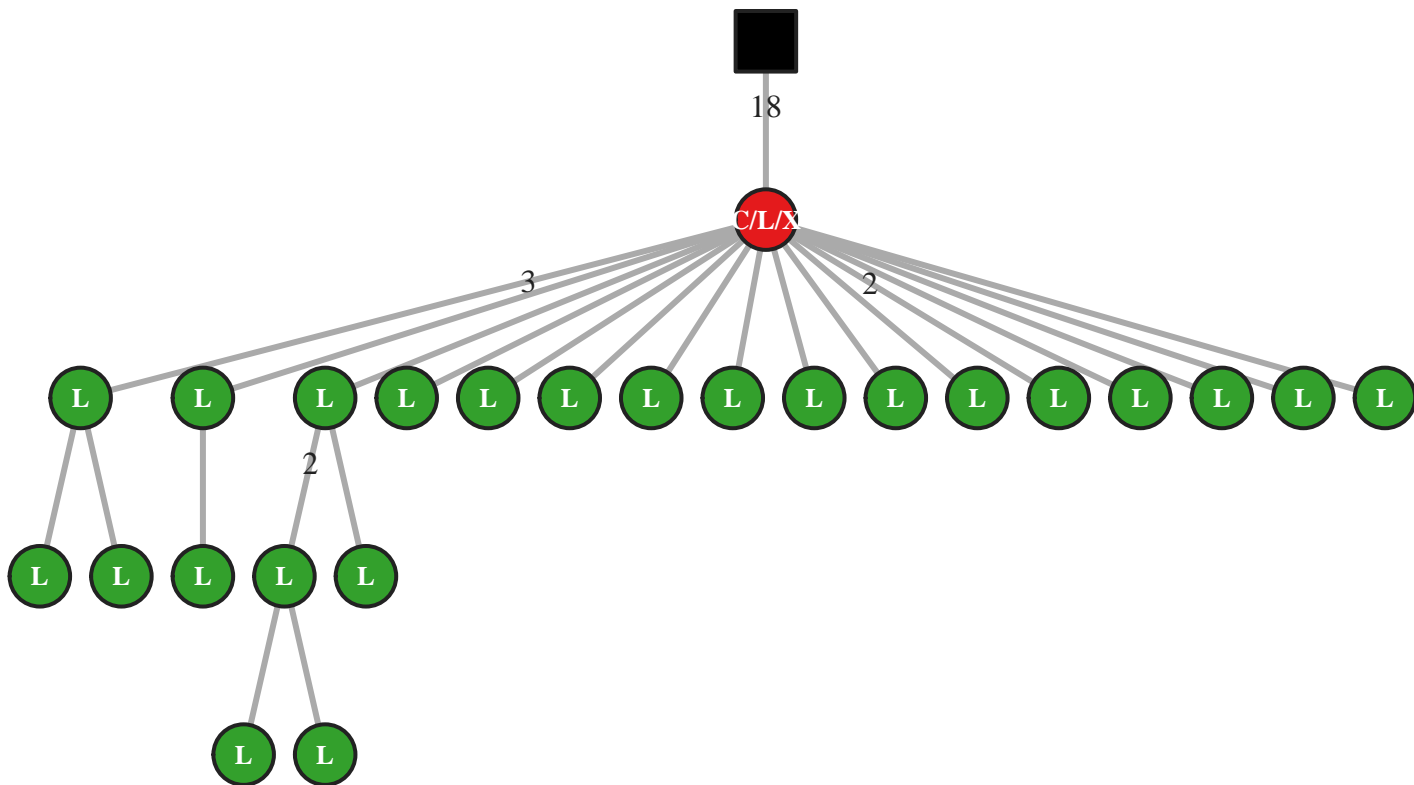

M5 IgG IGHV5-51/J3 66bp (36821)

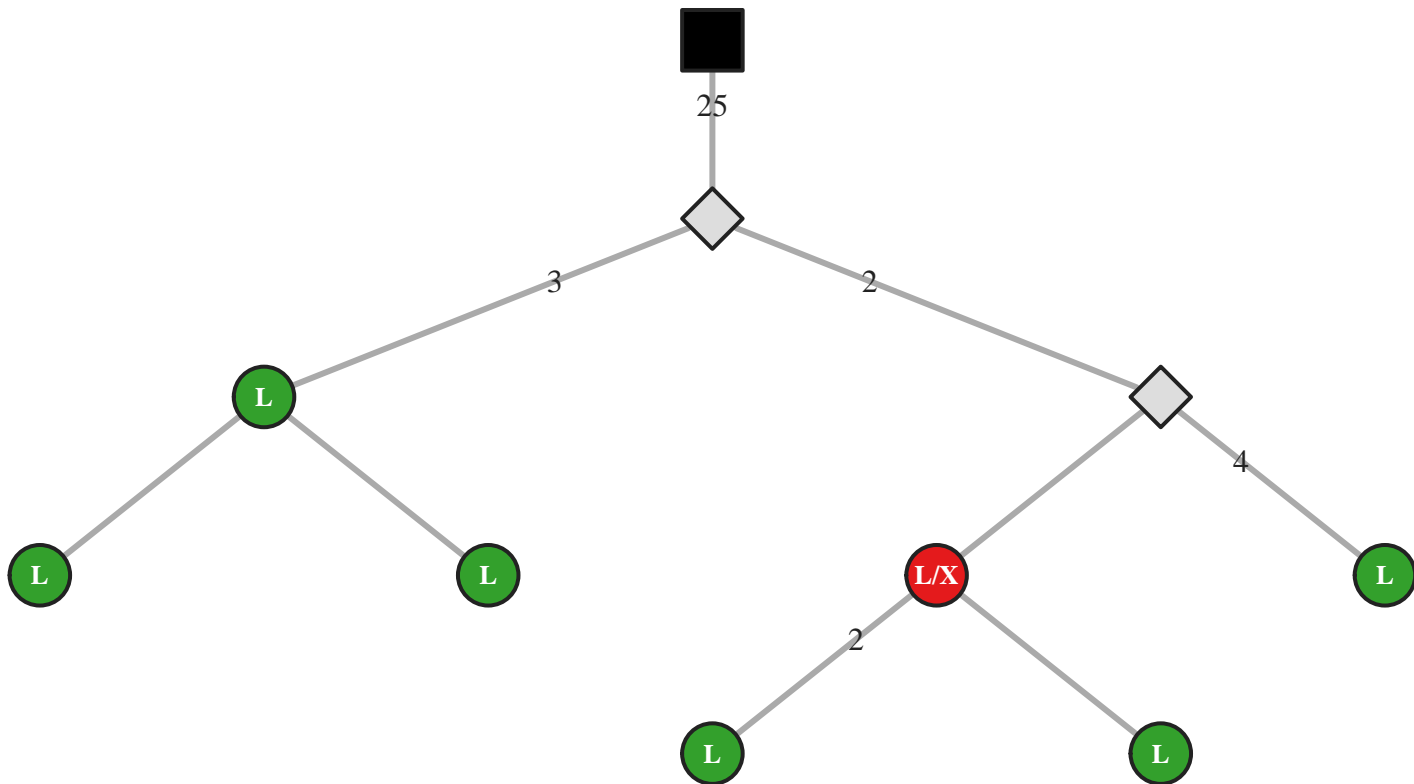

M5 IgA IGHV5-51/J4 30bp (30881)

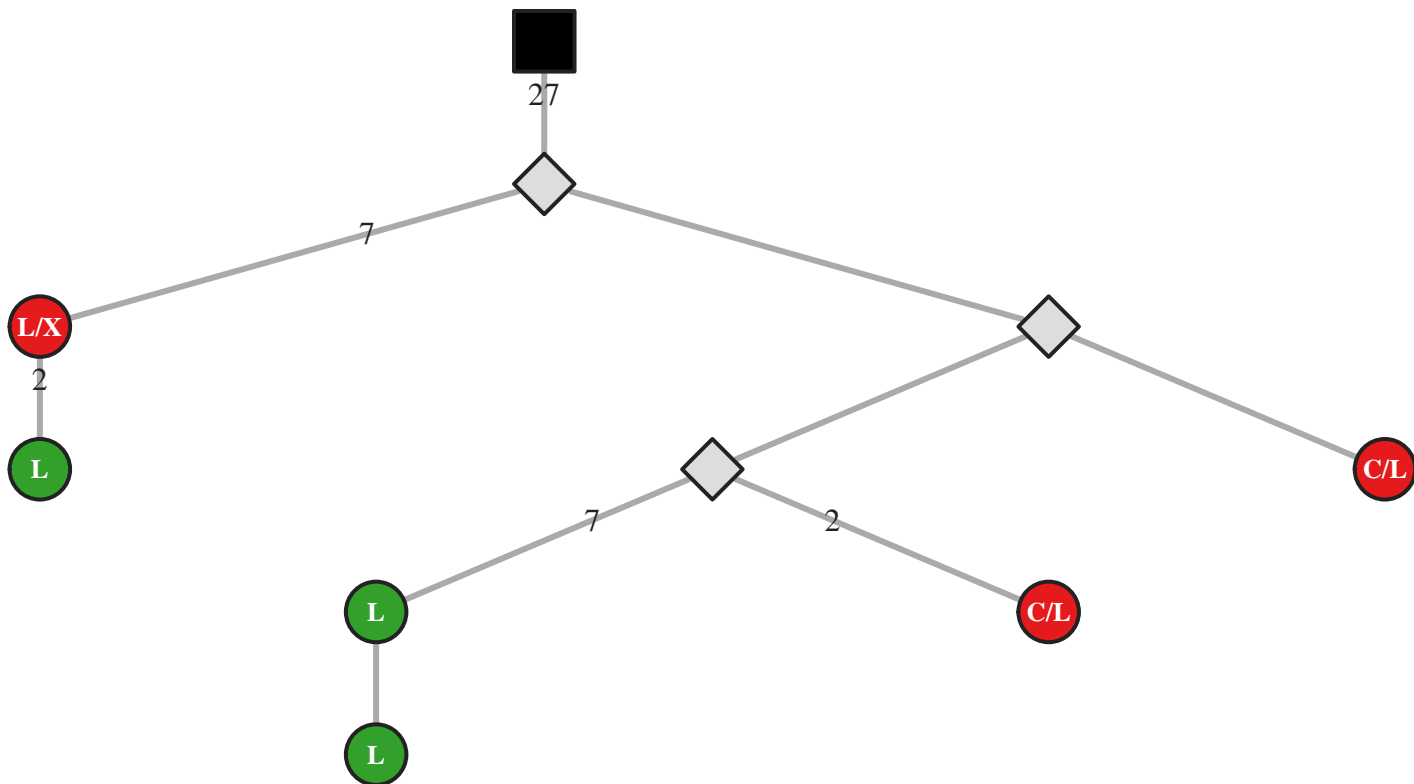

M5 IgG IGHV5-51/J4 30bp (47105)

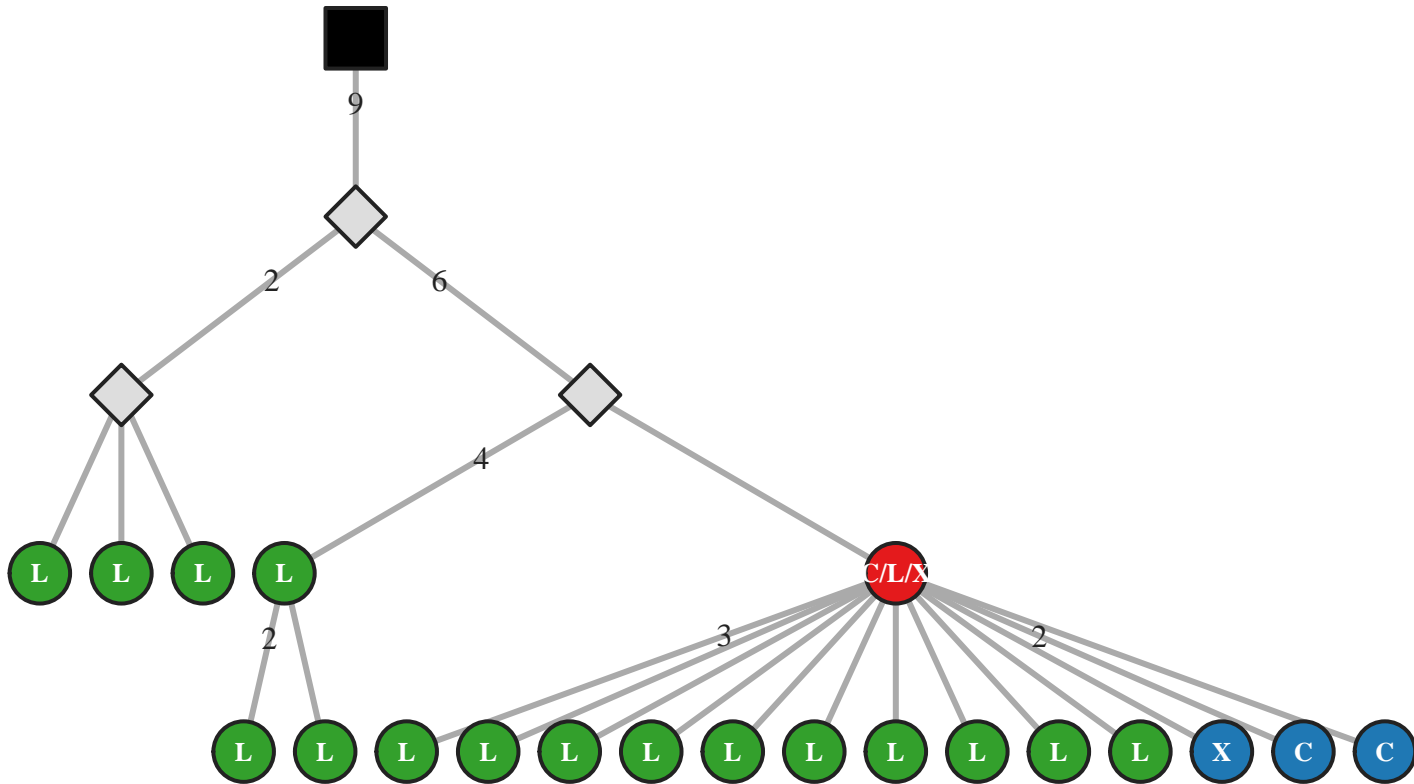

M5 IgG IGHV5-51/J4 33bp (47122)

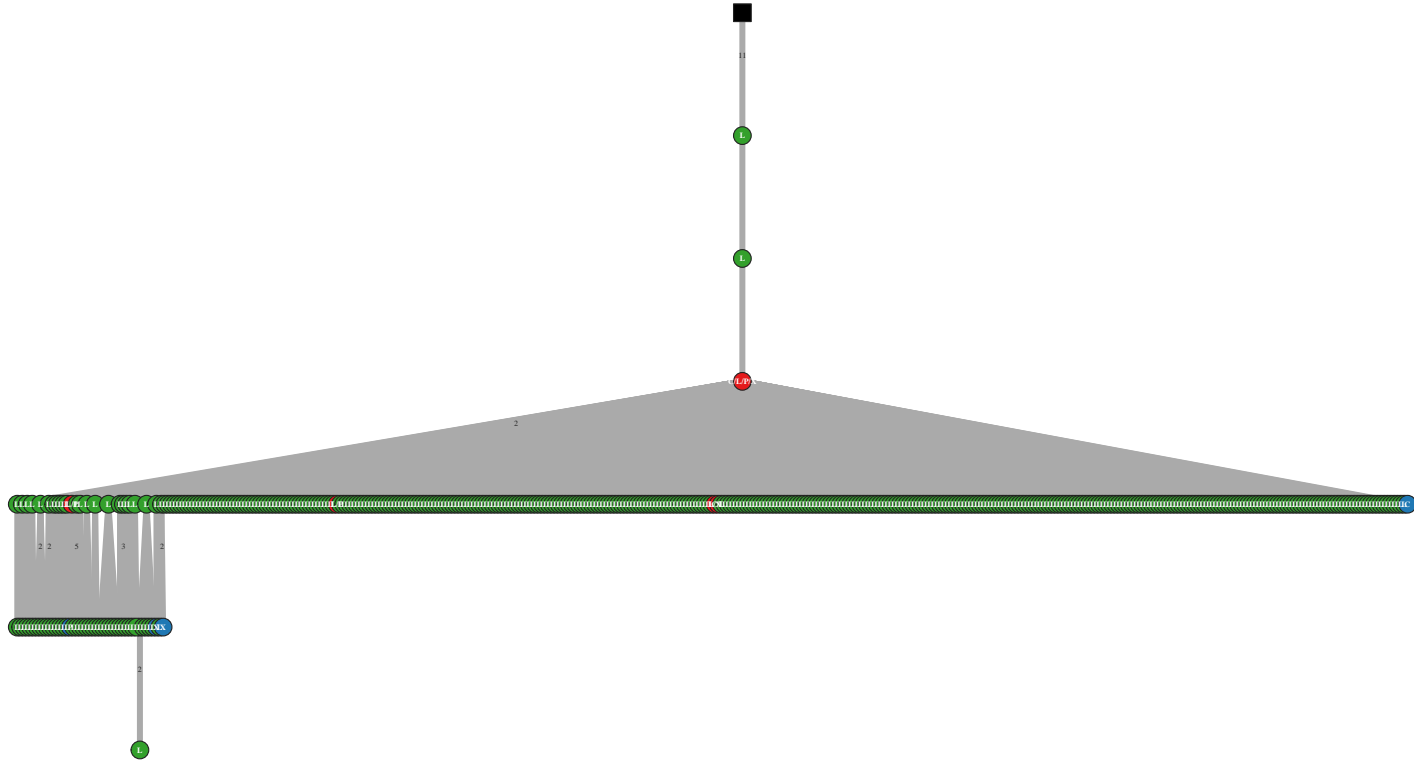

M5 IgG IGHV5-51/J4 33bp (47129)

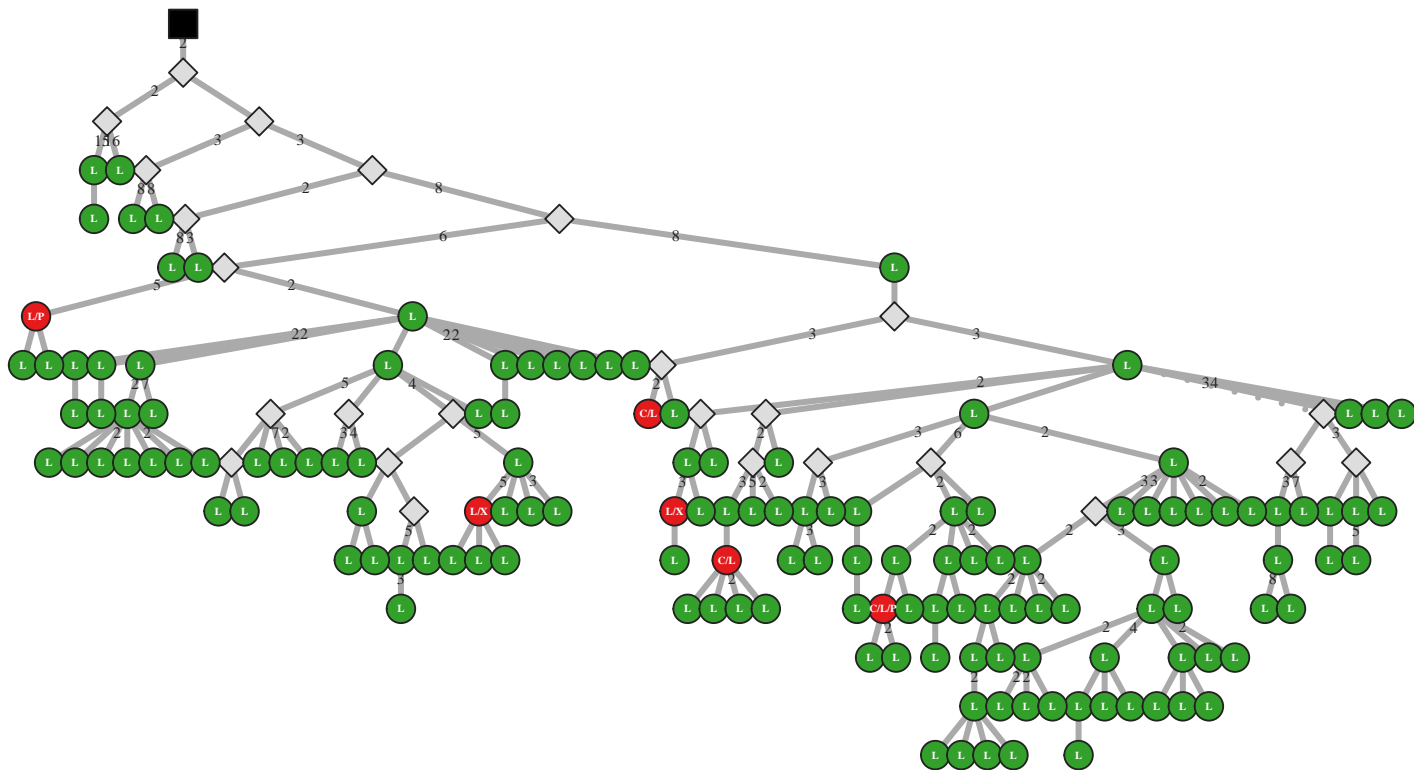

M5 IgG IGHV5-51/J4 33bp (47130)

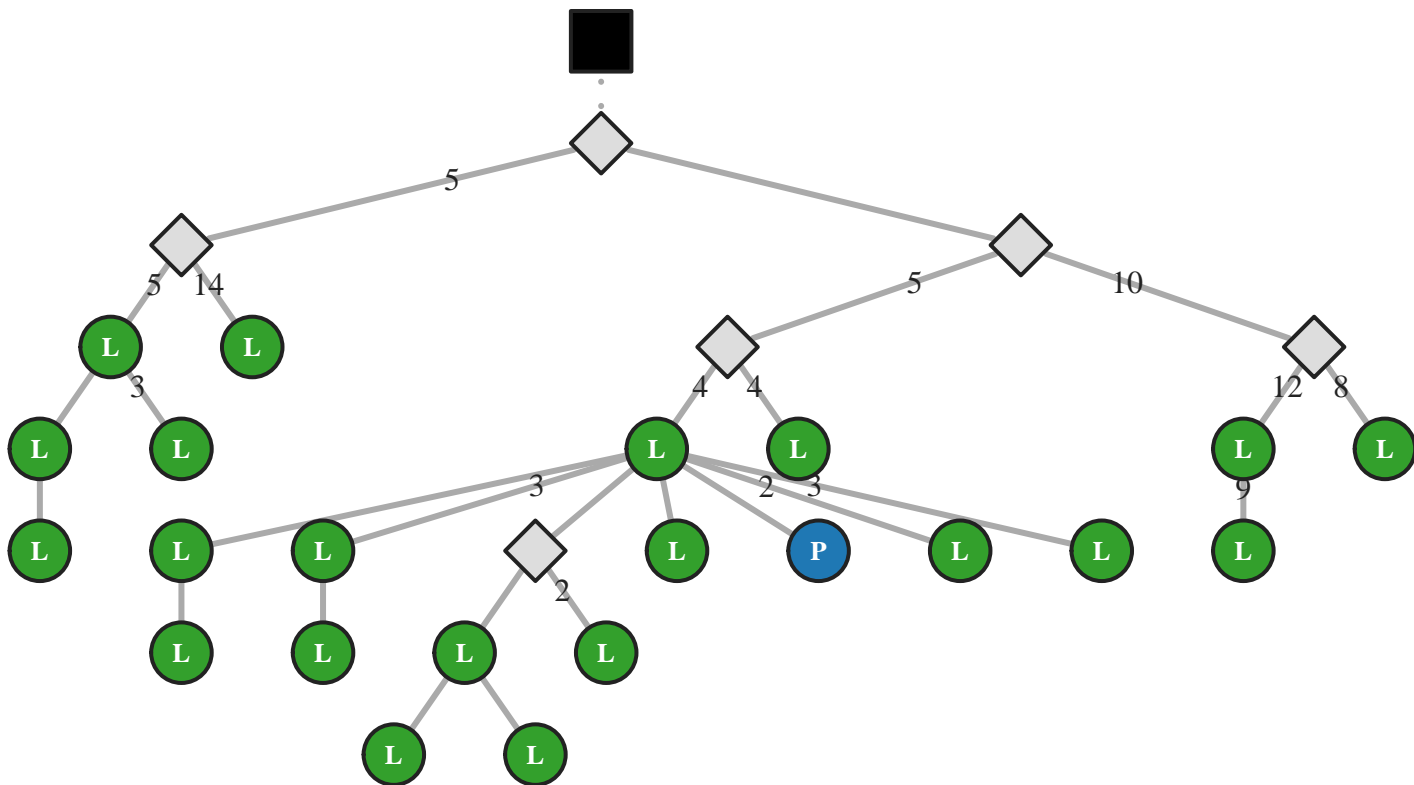

M5 IgG IGHV5-51/J4 36bp (19587)

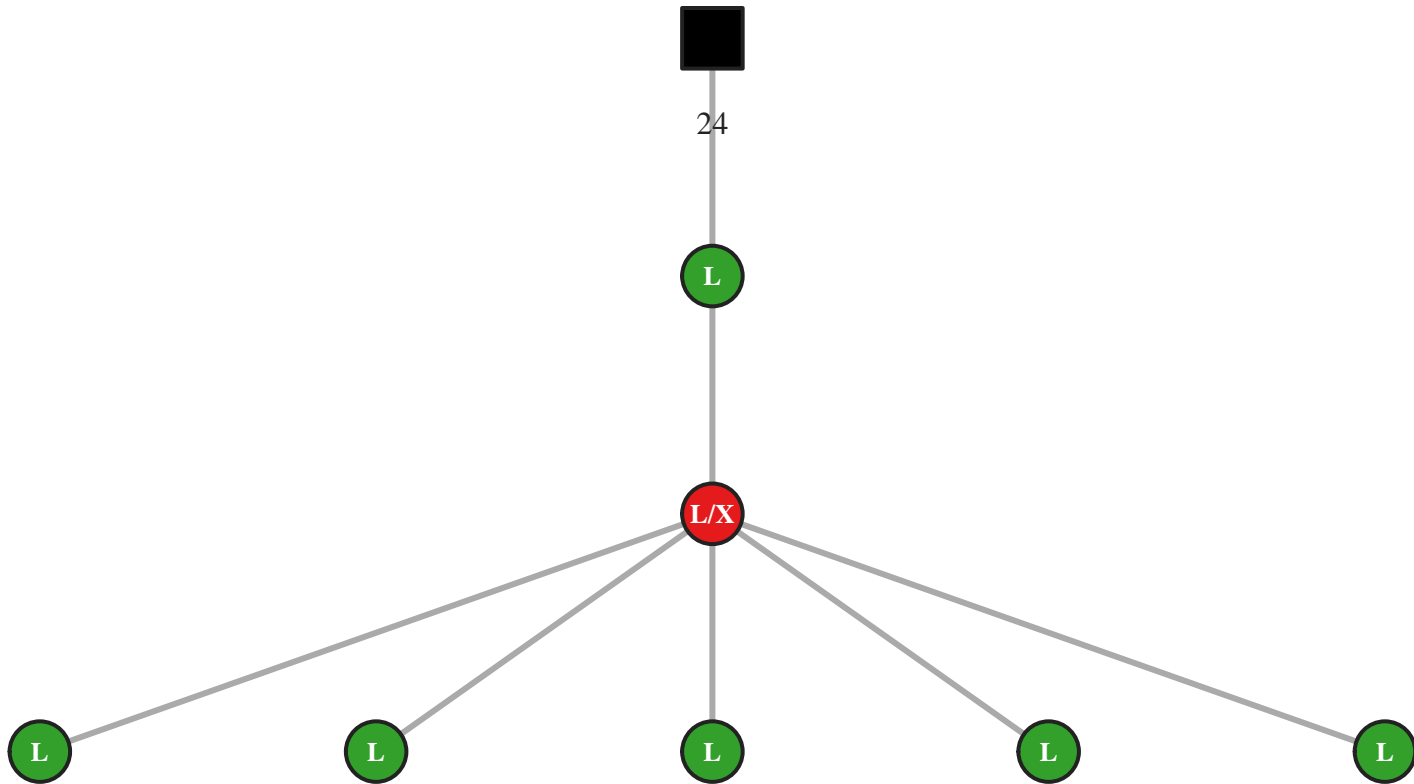

M5 IgG IGHV5-51/J4 36bp (19598)

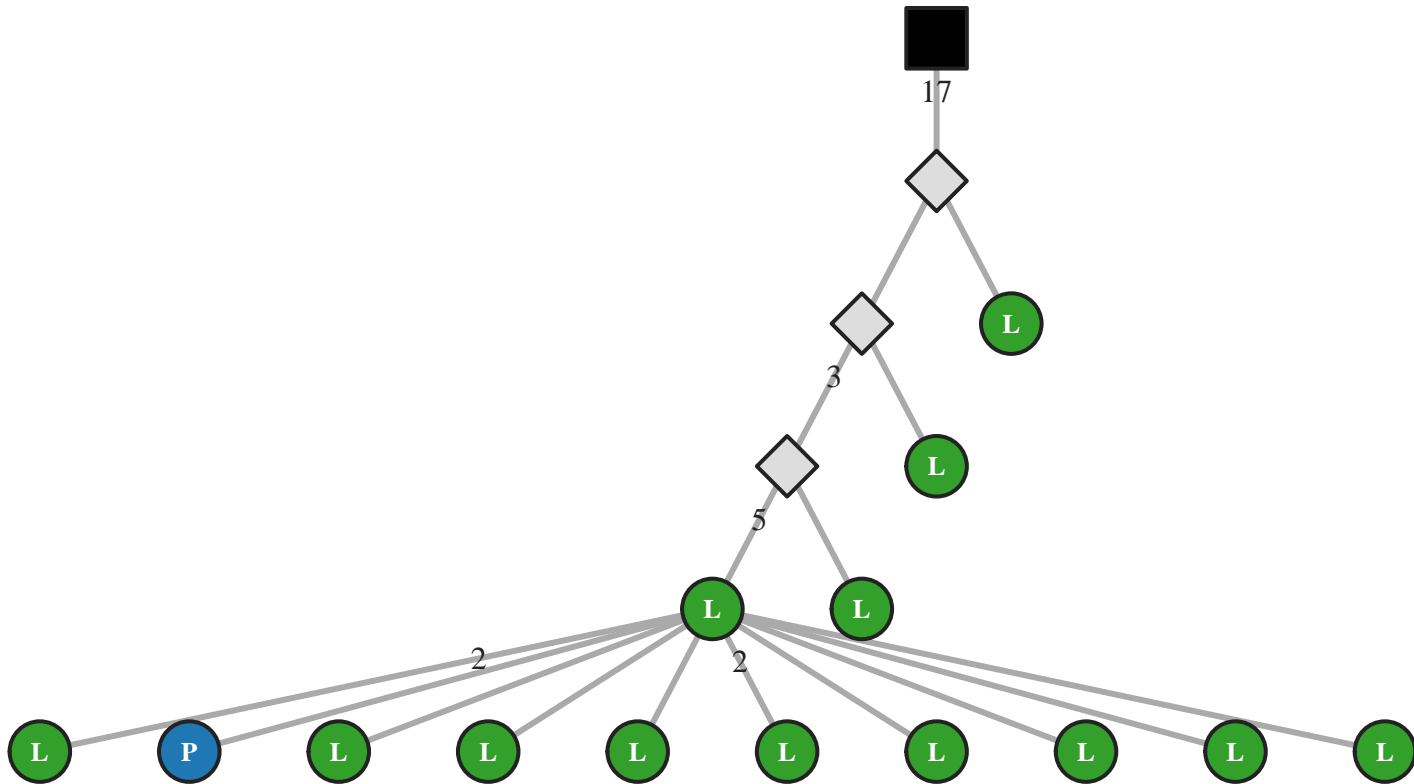

M5 IgG IGHV5-51/J4 36bp (19603)

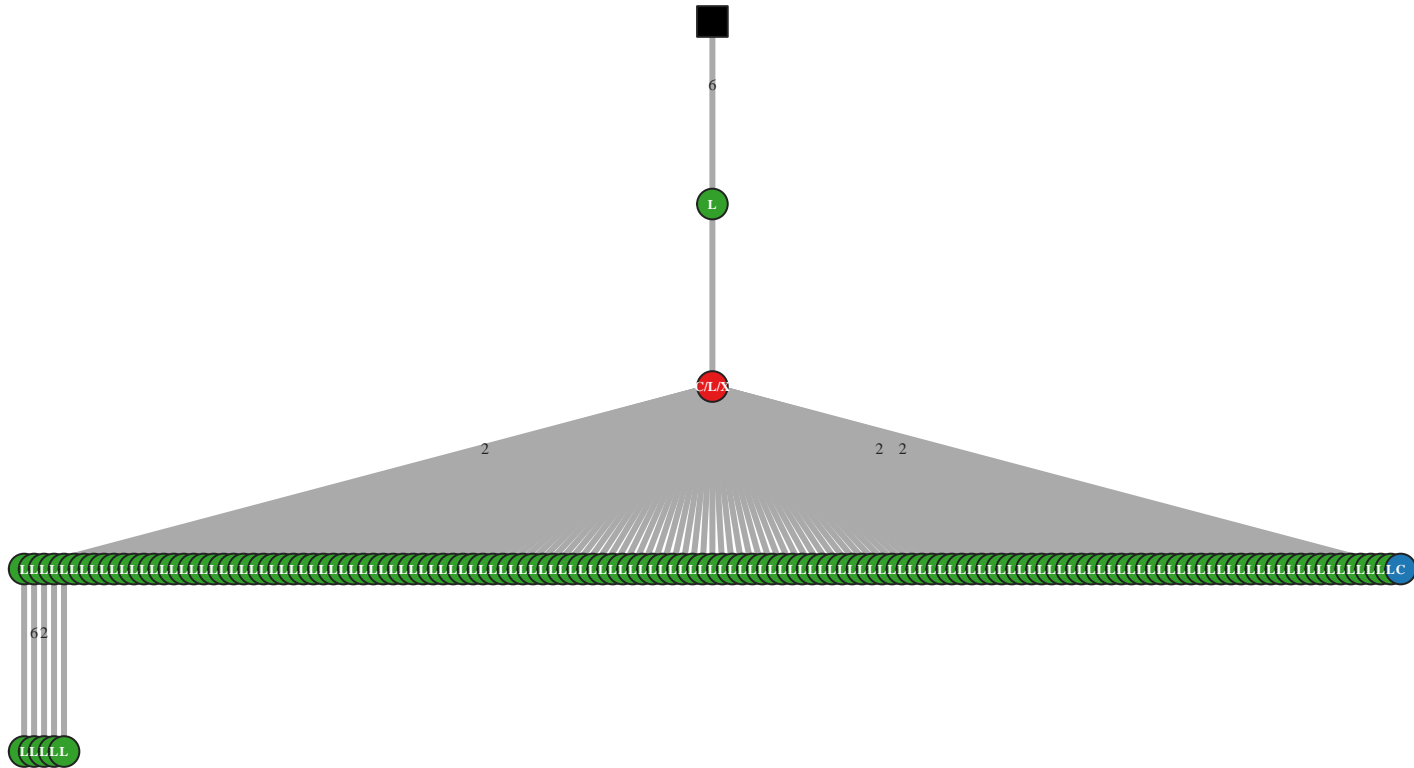

M5 IgG IGHV5-51/J4 39bp (19606)

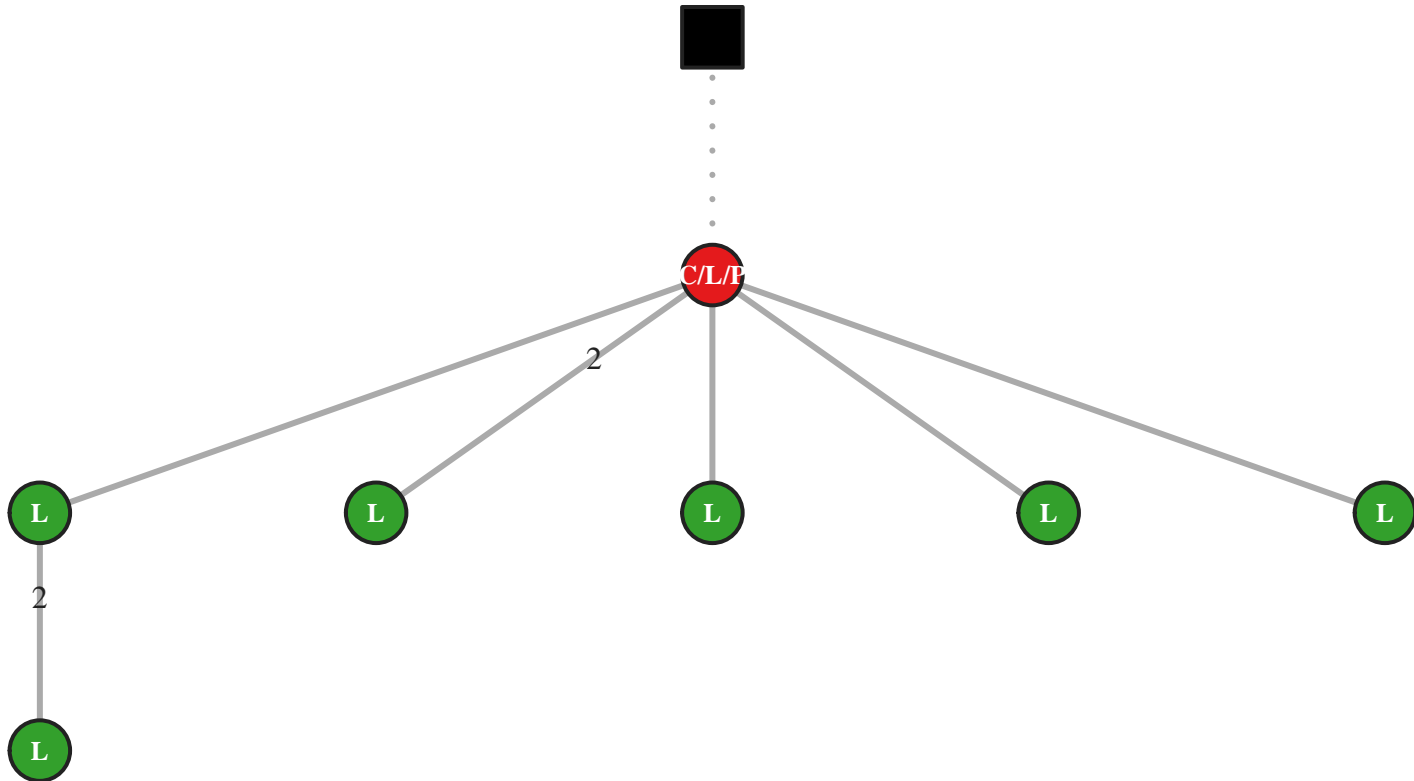

M5 IgG IGHV5-51/J4 39bp (19614)

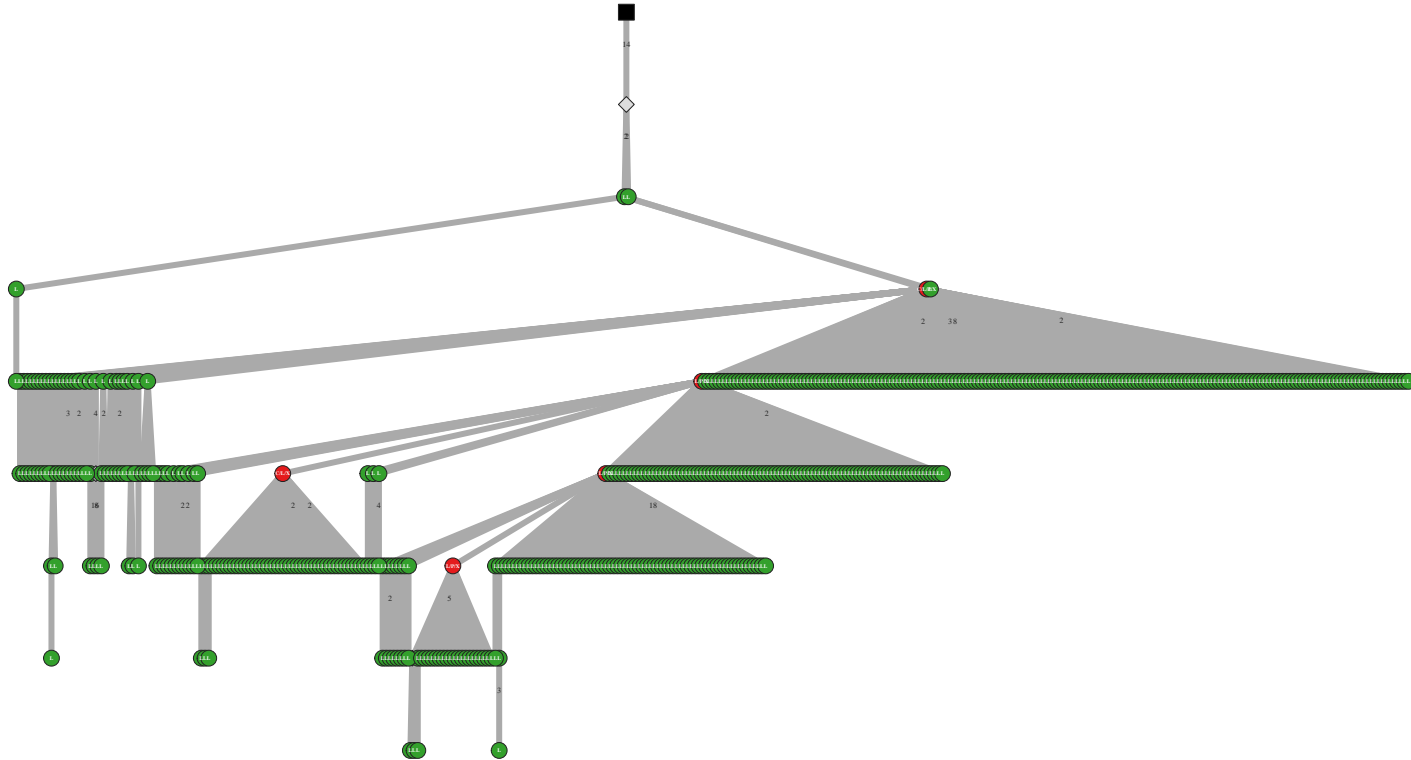

M5 IgG IGHV5-51/J4 39bp (19616)

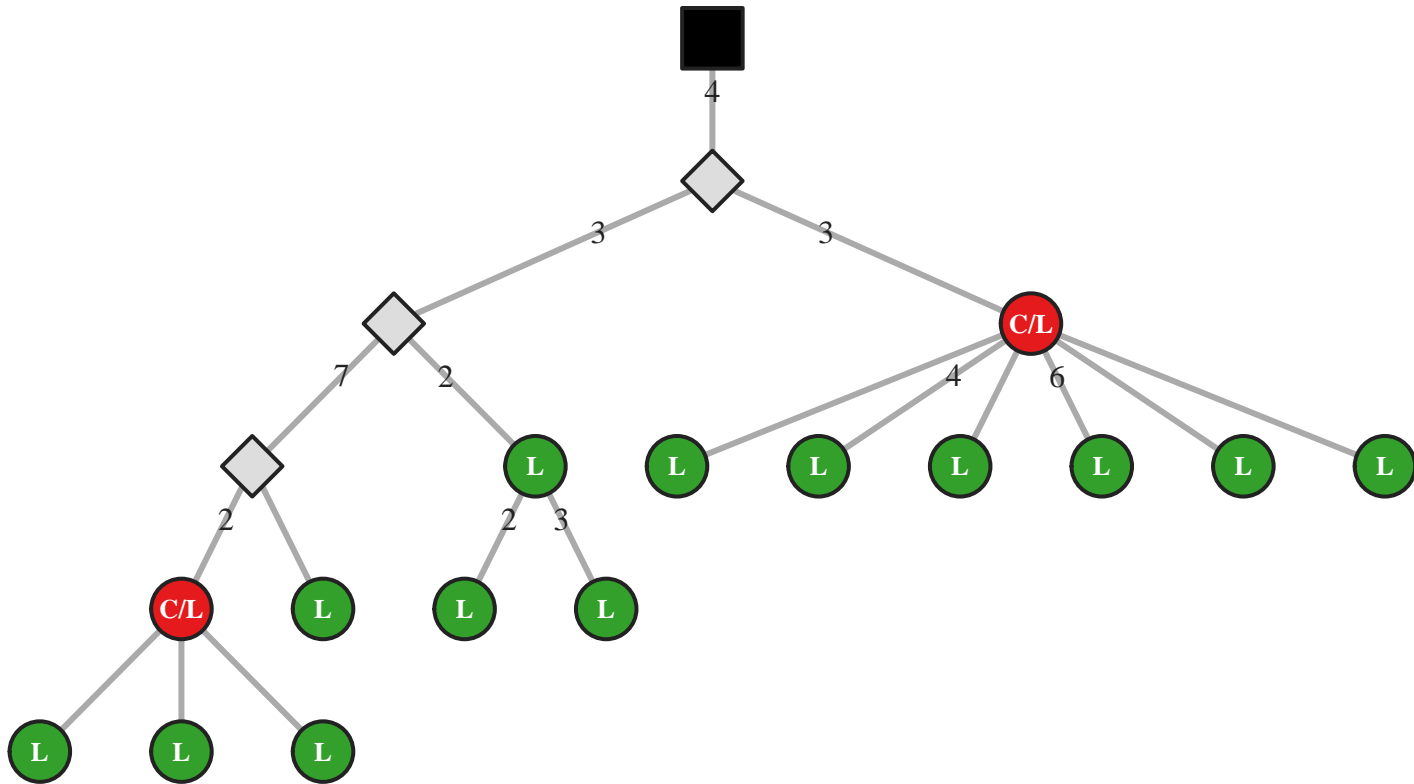

M5 IgG IGHV5-51/J4 39bp (19618)

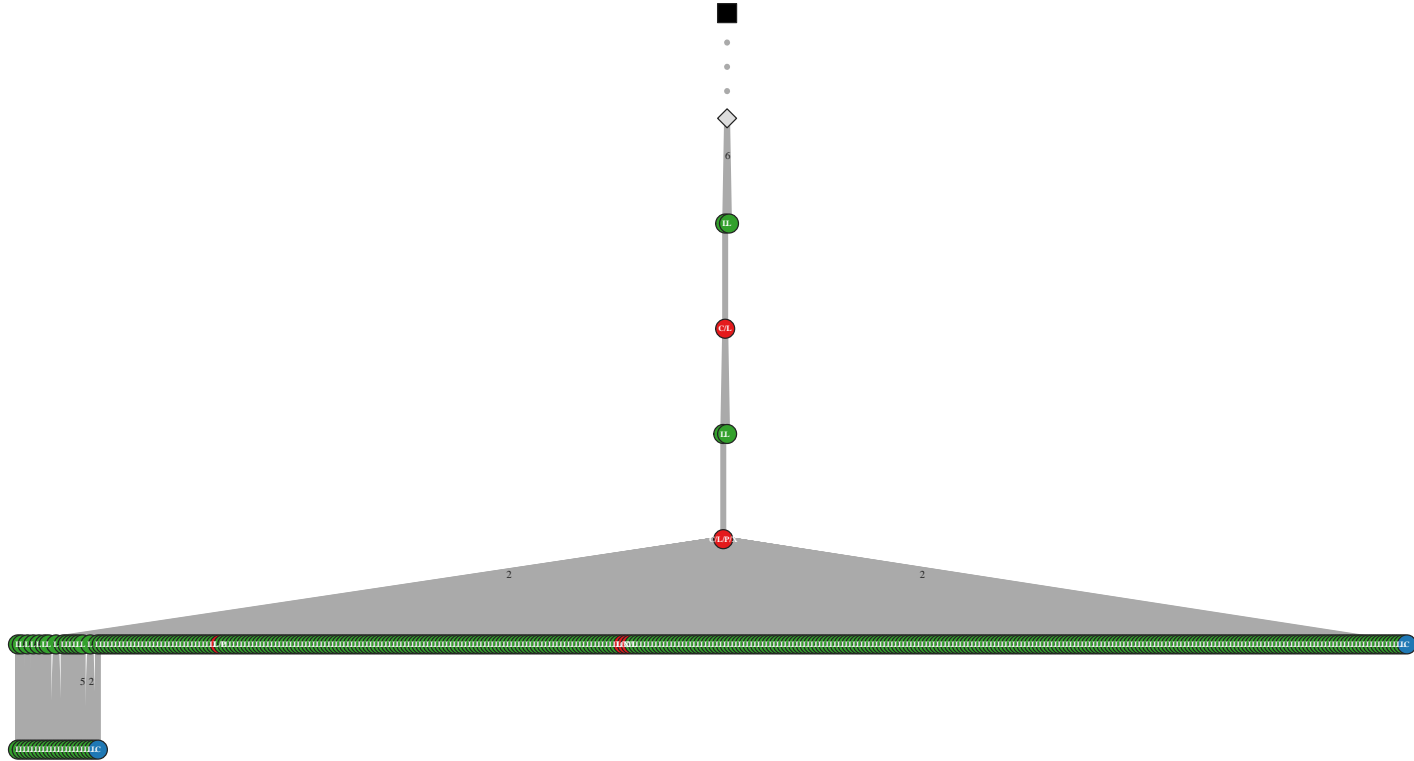

M5 IgG IGHV5-51/J4 39bp (19620)

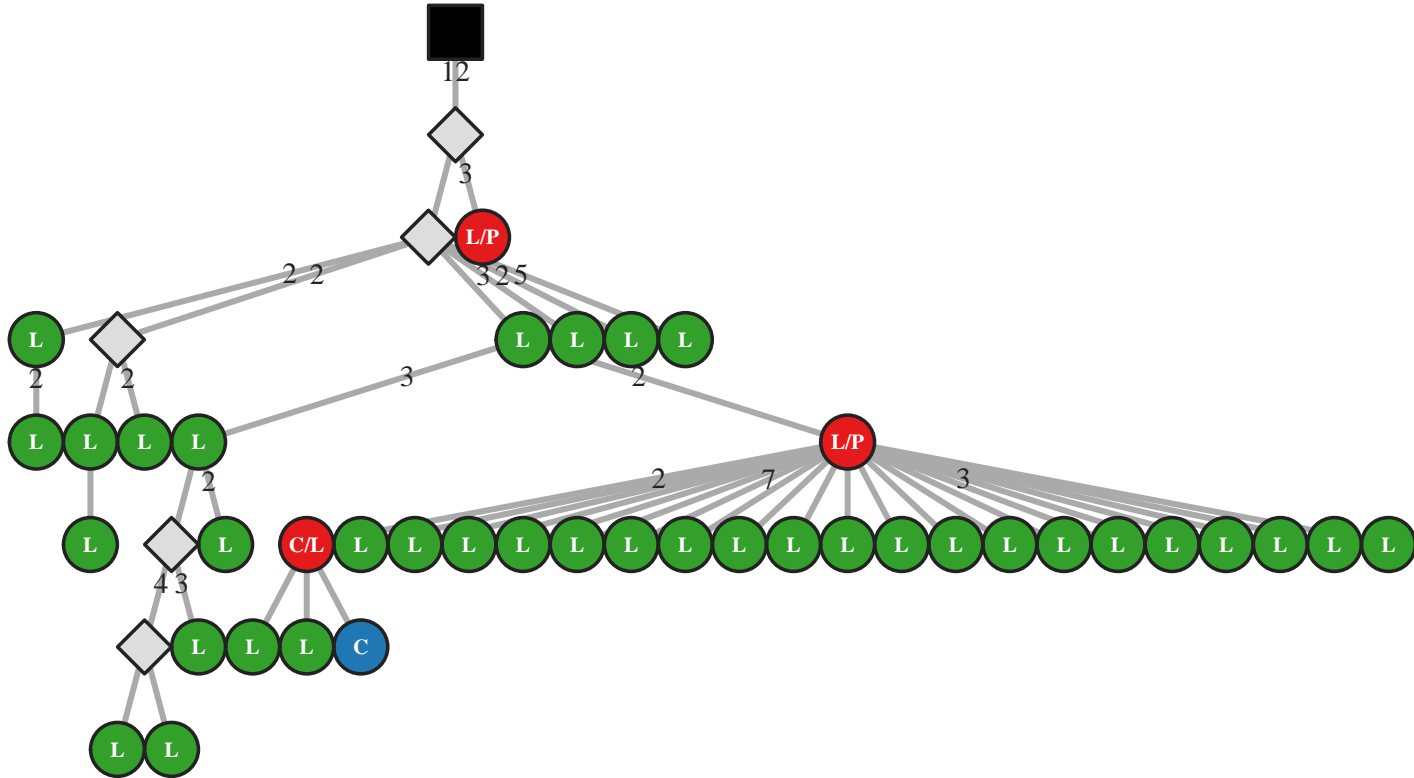

M5 IgG IGHV5-51/J4 39bp (19632)

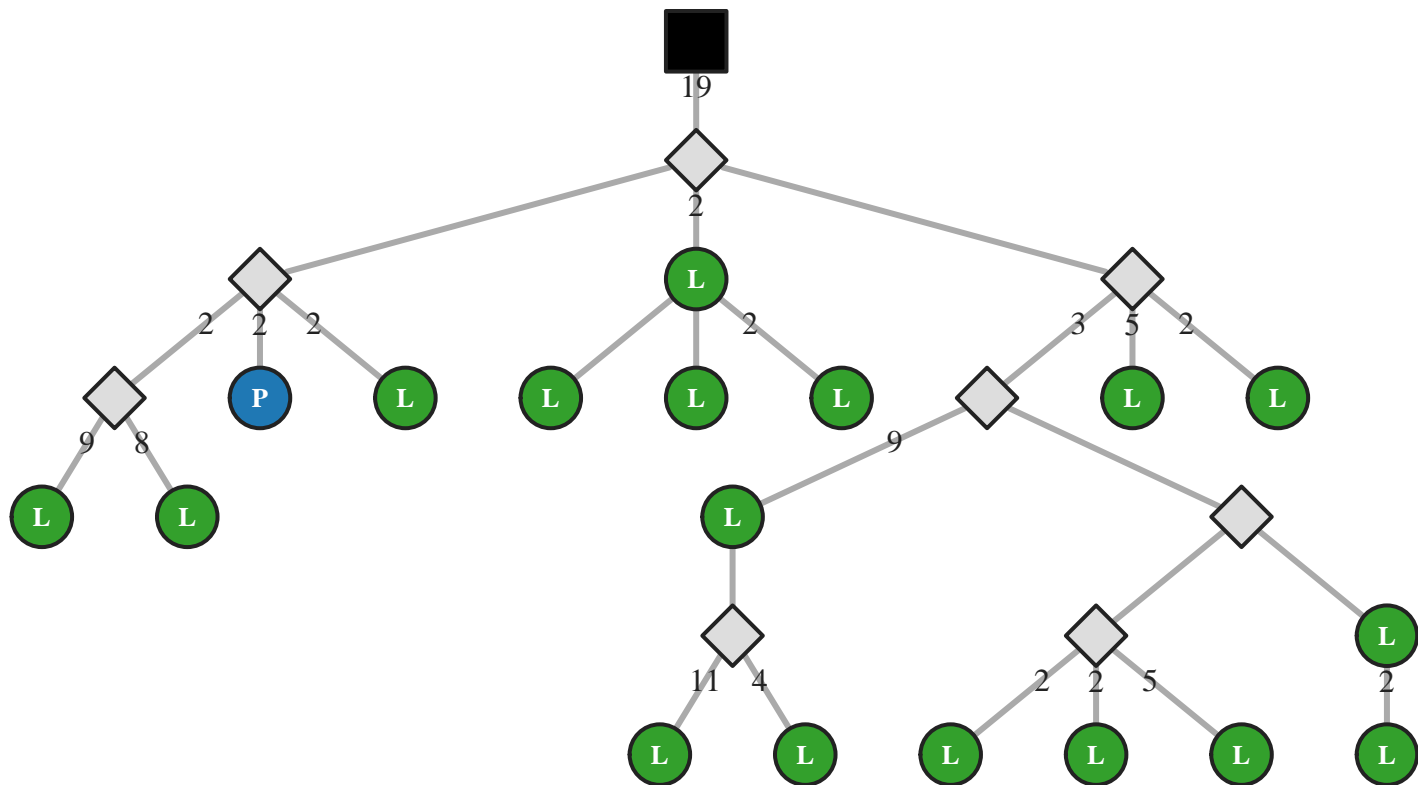

M5 IgG IGHV5-51/J4 39bp (19657)

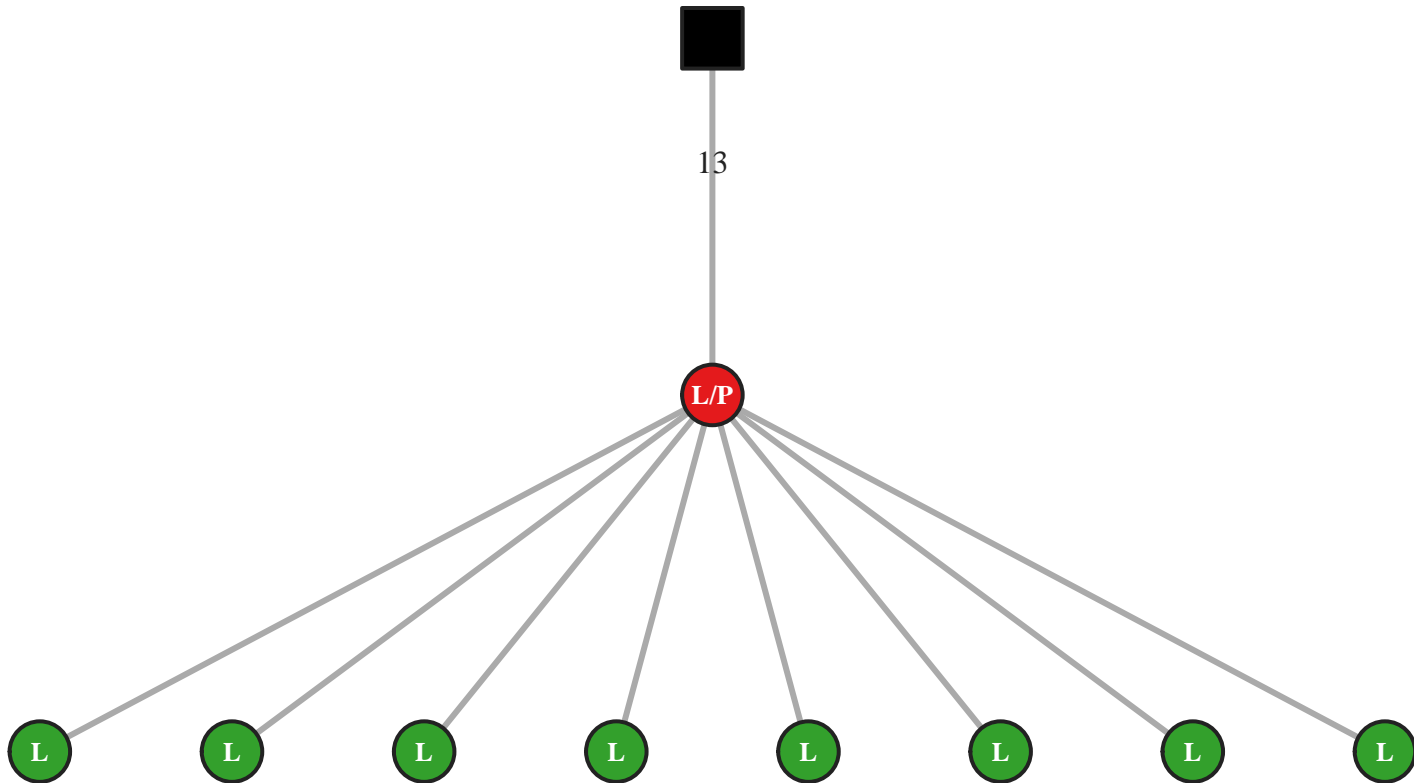

M5 IgM IGHV5-51/J4 39bp (29851)

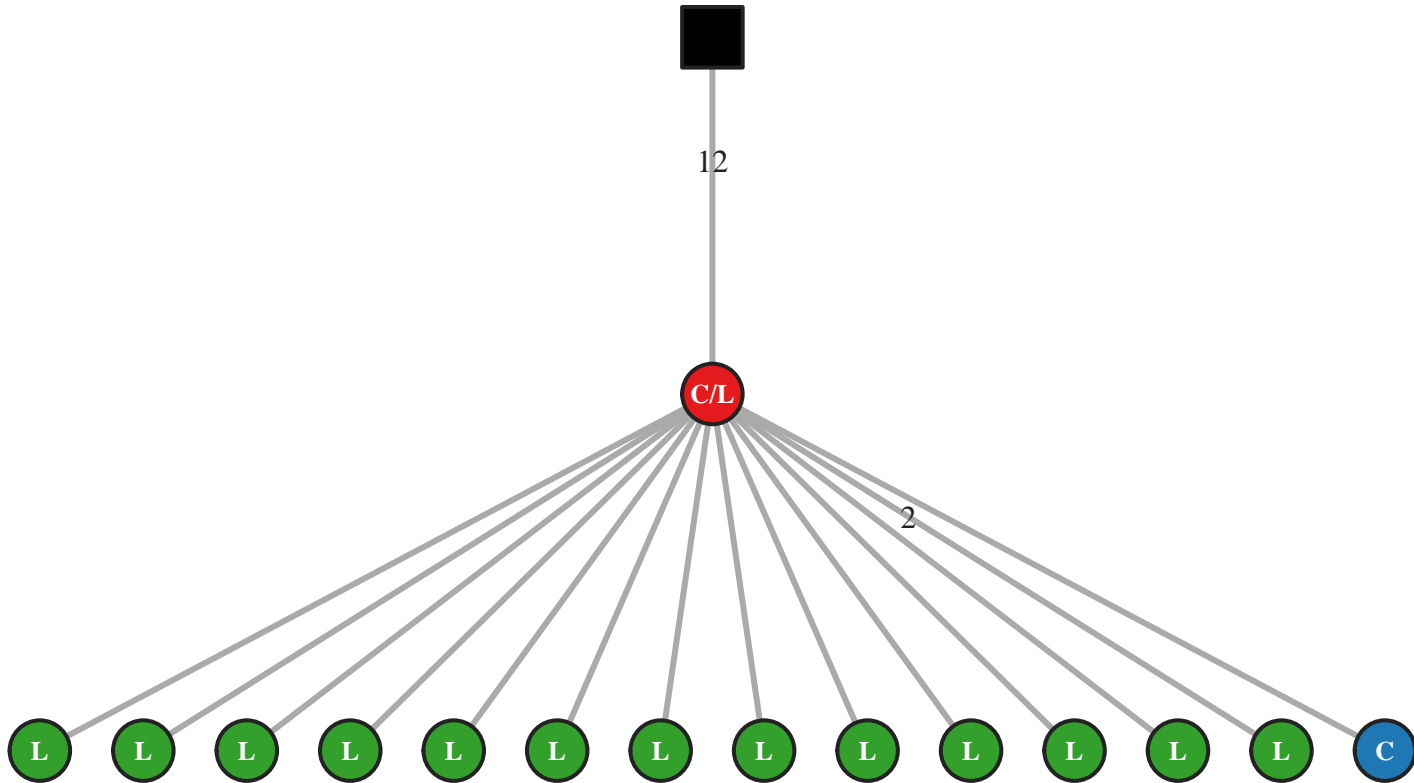

M5 IgA IGHV5-51/J4 42bp (12917)

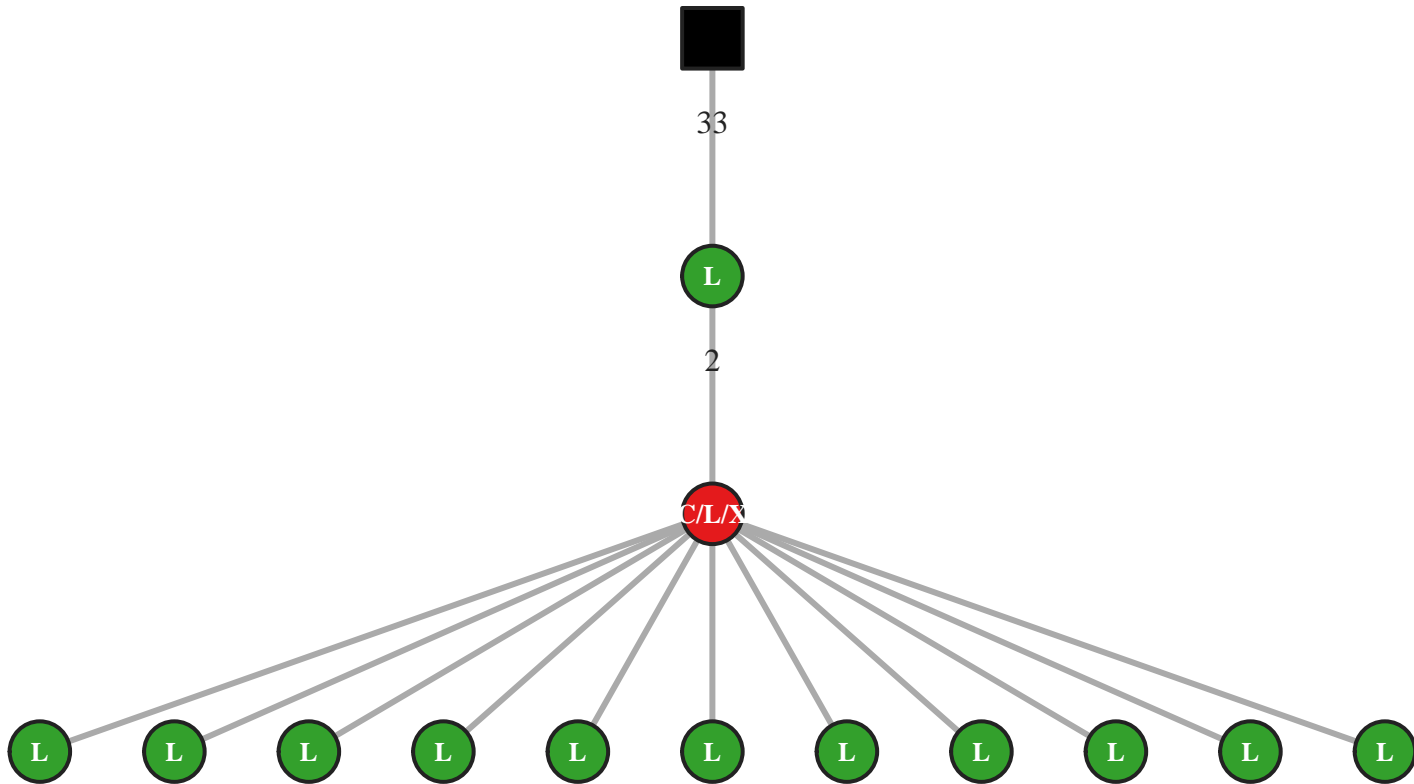

M5 IgG IGHV5-51/J4 42bp (19686)

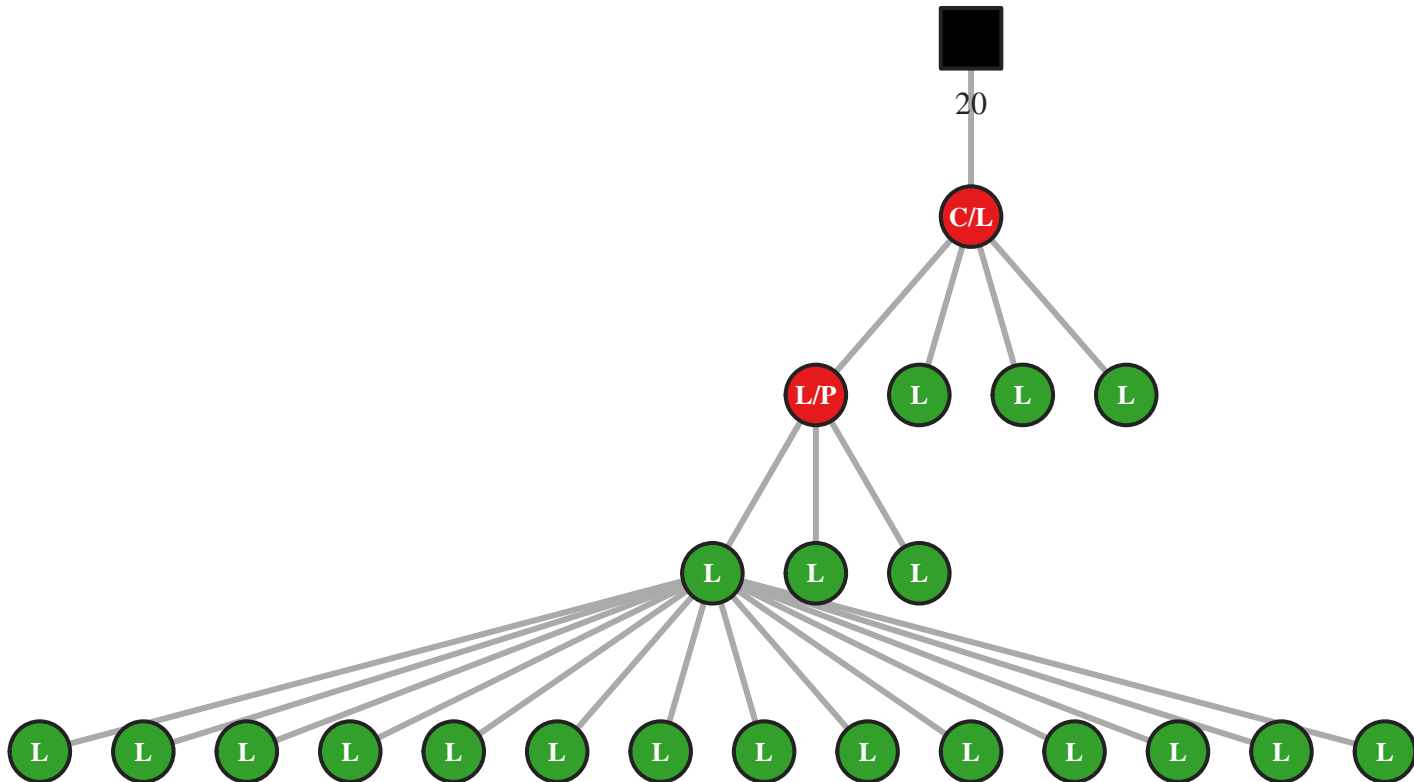

M5 IgG IGHV5-51/J4 42bp (19695)

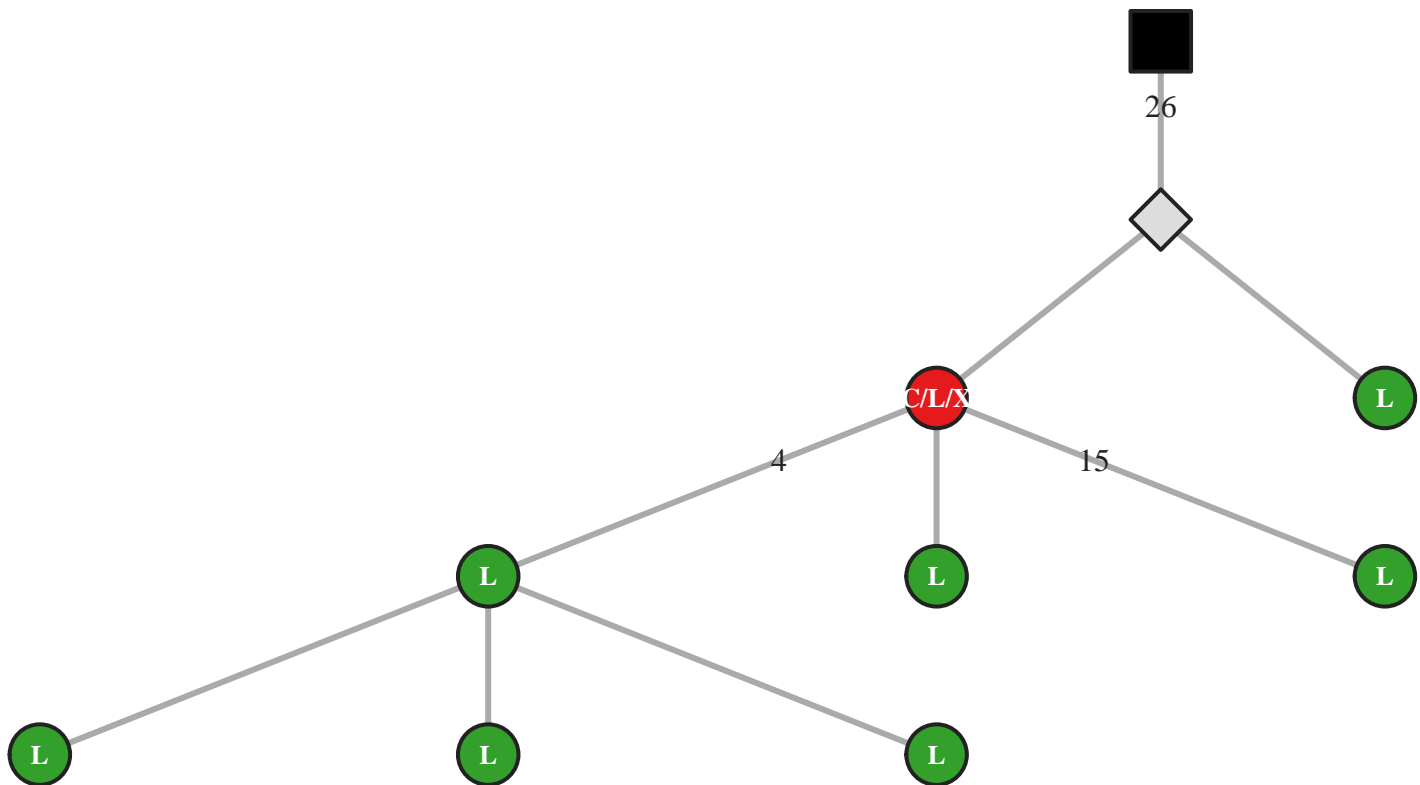

M5 IgG IGHV5-51/J4 42bp (19709)

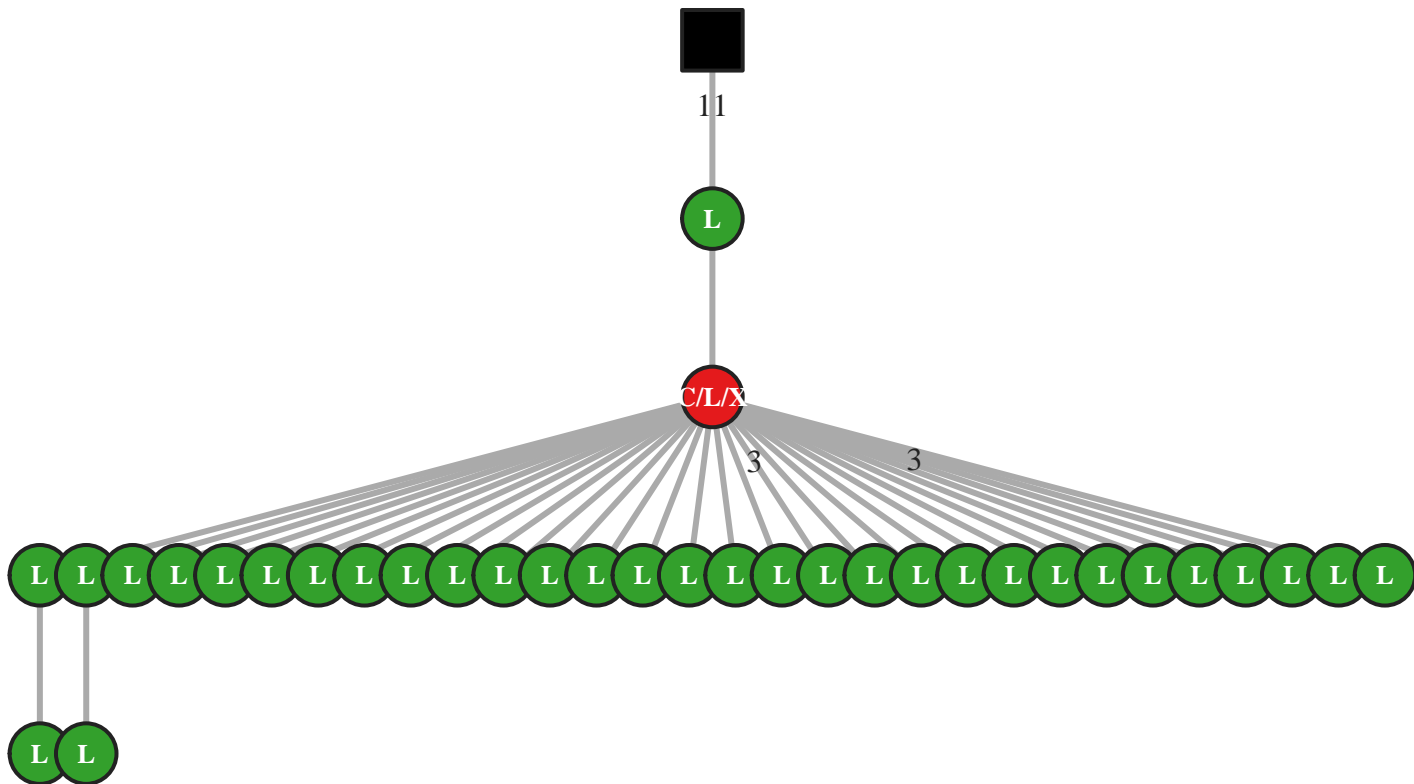

M5 IgG IGHV5-51/J4 42bp (19762)

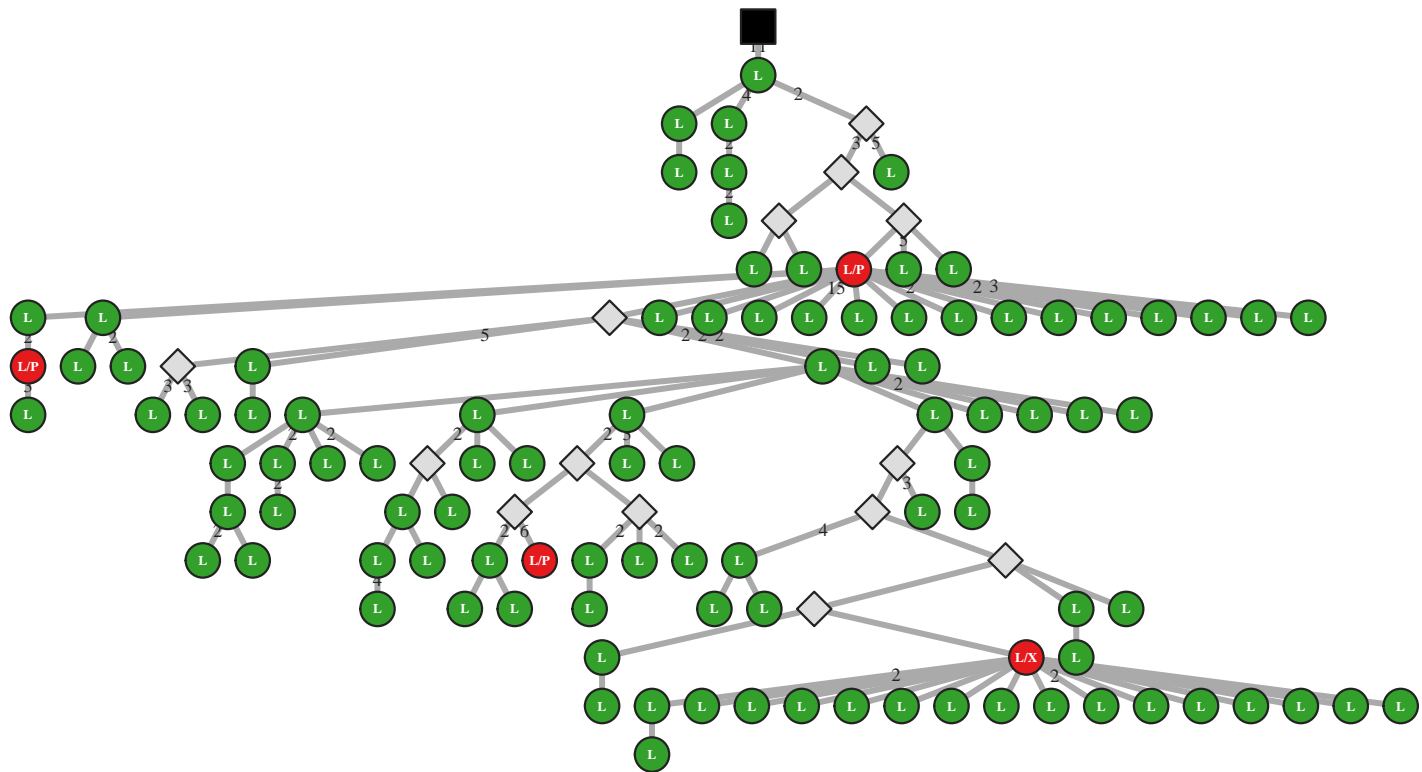

M5 IgG IGHV5-51/J4 42bp (19764)

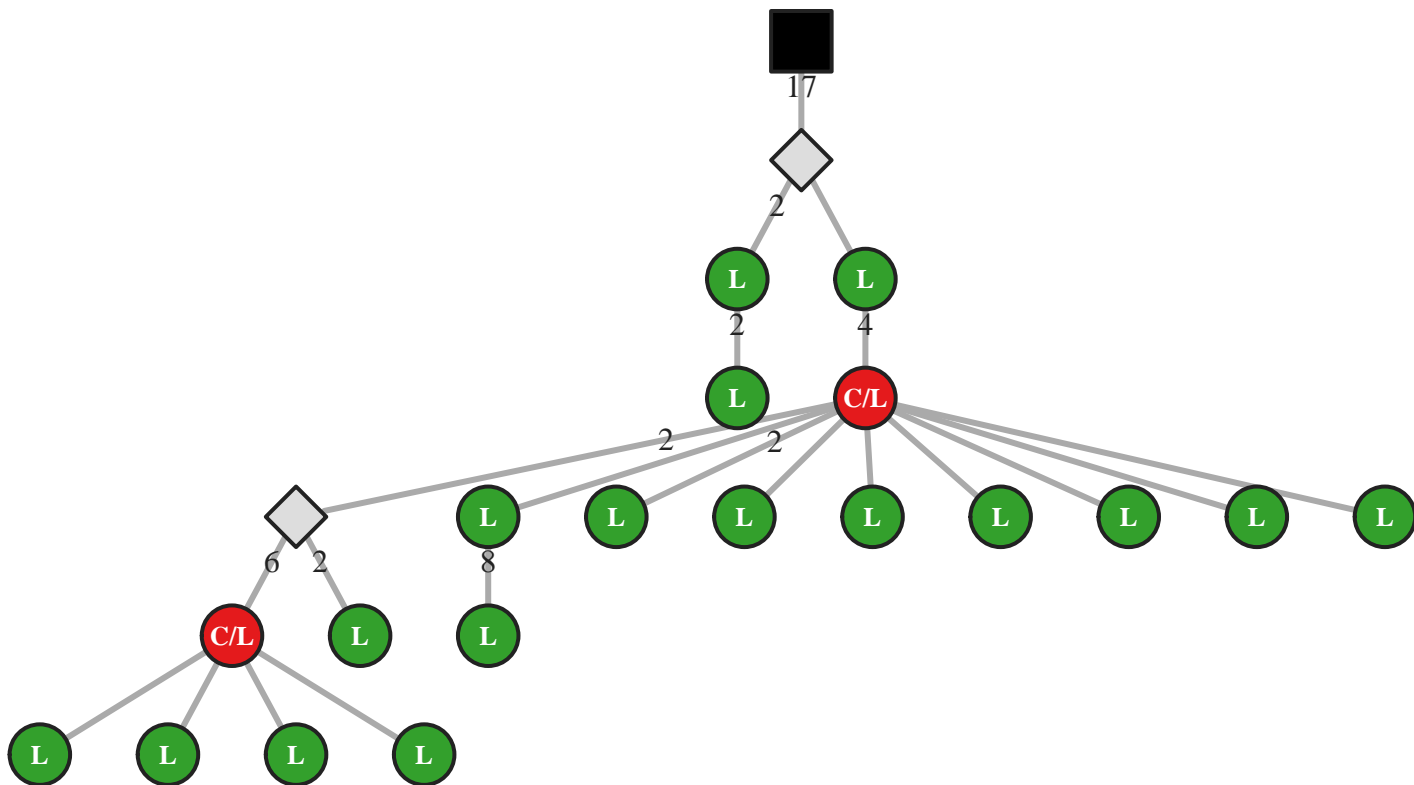

M5 IgG IGHV5-51/J4 42bp (19770)

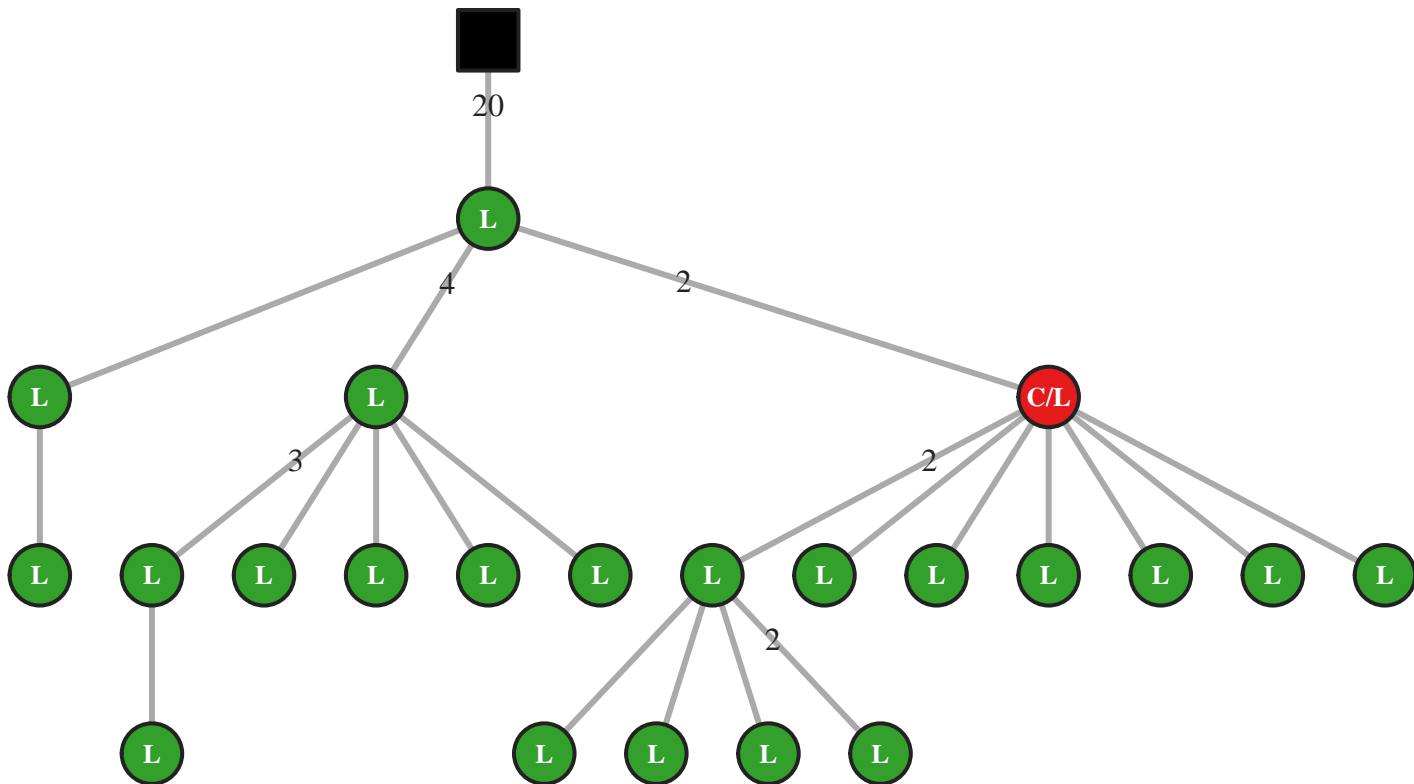

M5 IgG IGHV5-51/J4 42bp (19795)

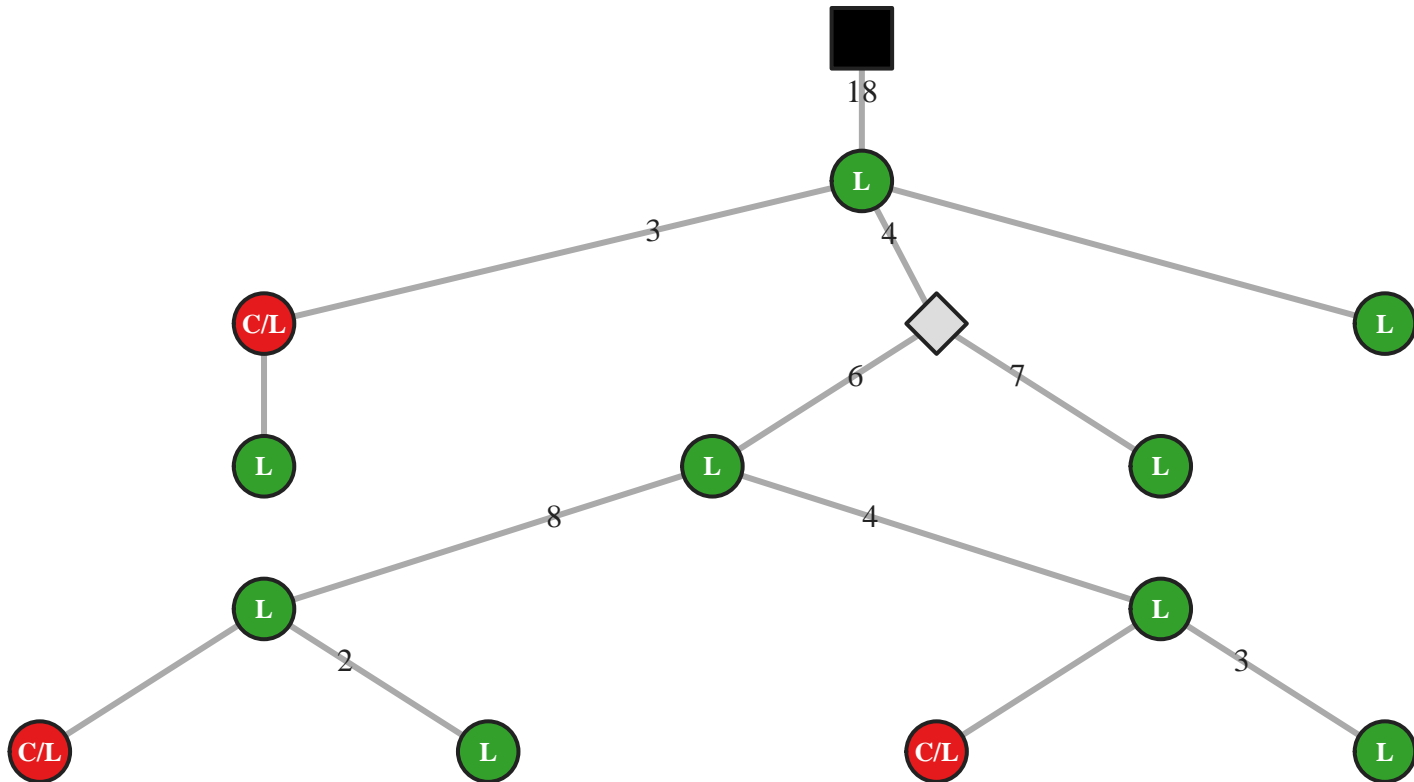

M5 IgG IGHV5-51/J4 45bp (19806)

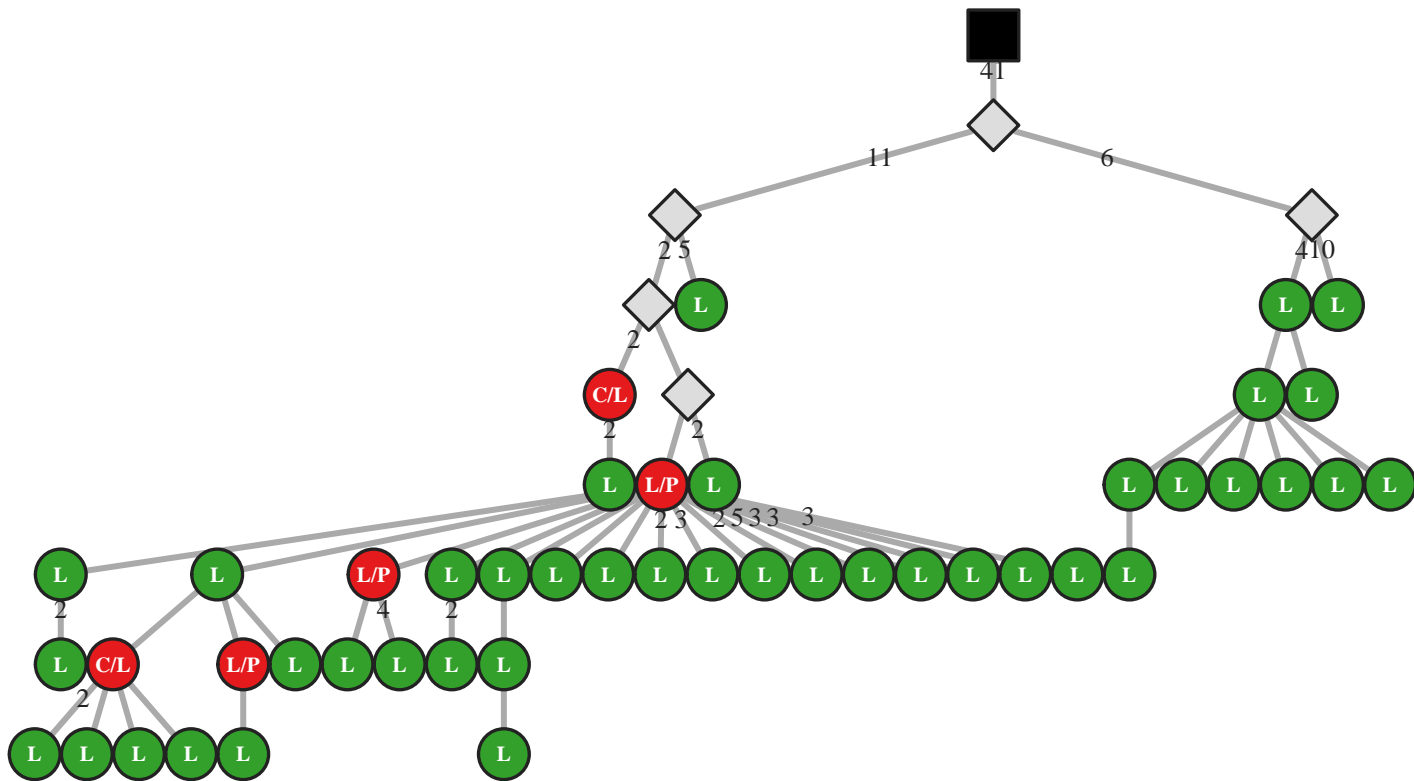

M5 IgG IGHV5-51/J4 45bp (19815)

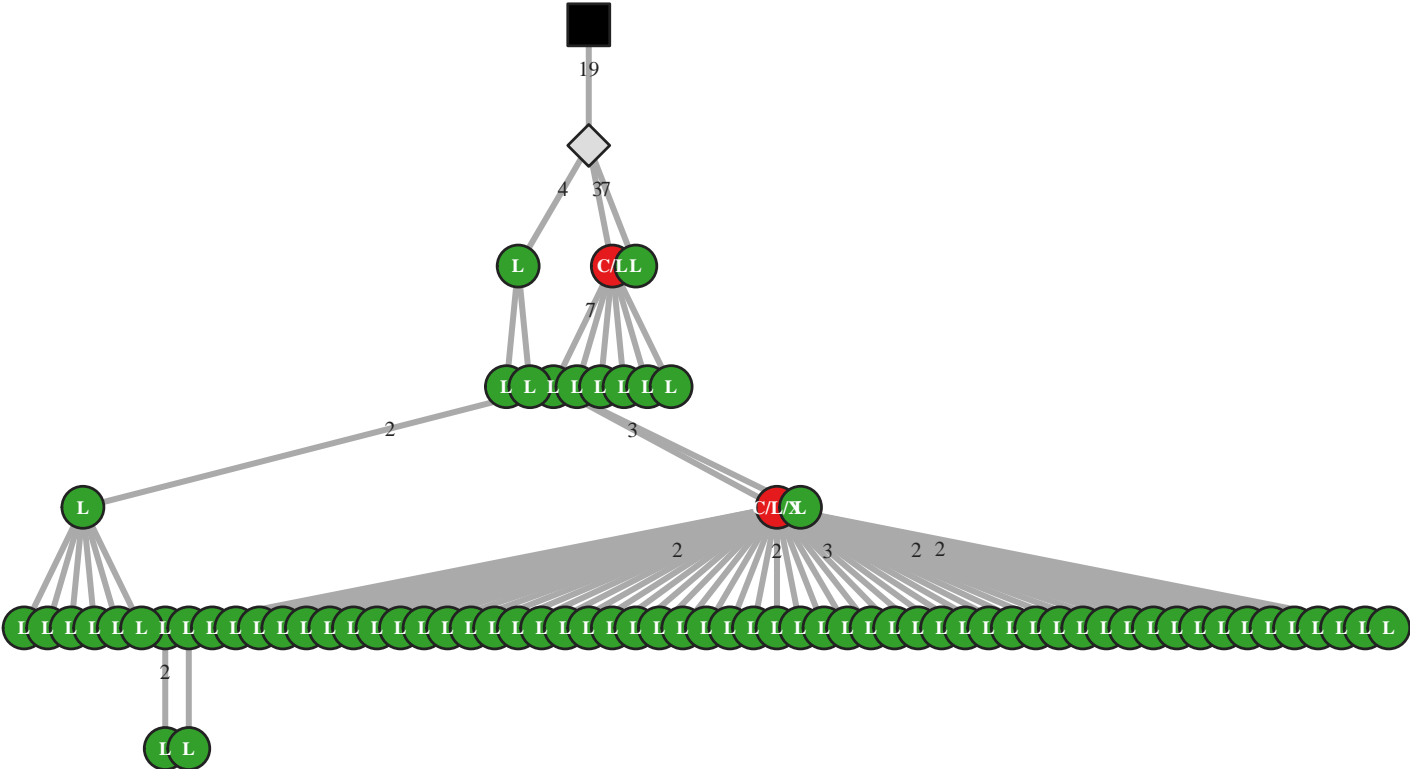

M5 IgG IGHV5-51/J4 45bp (19824)

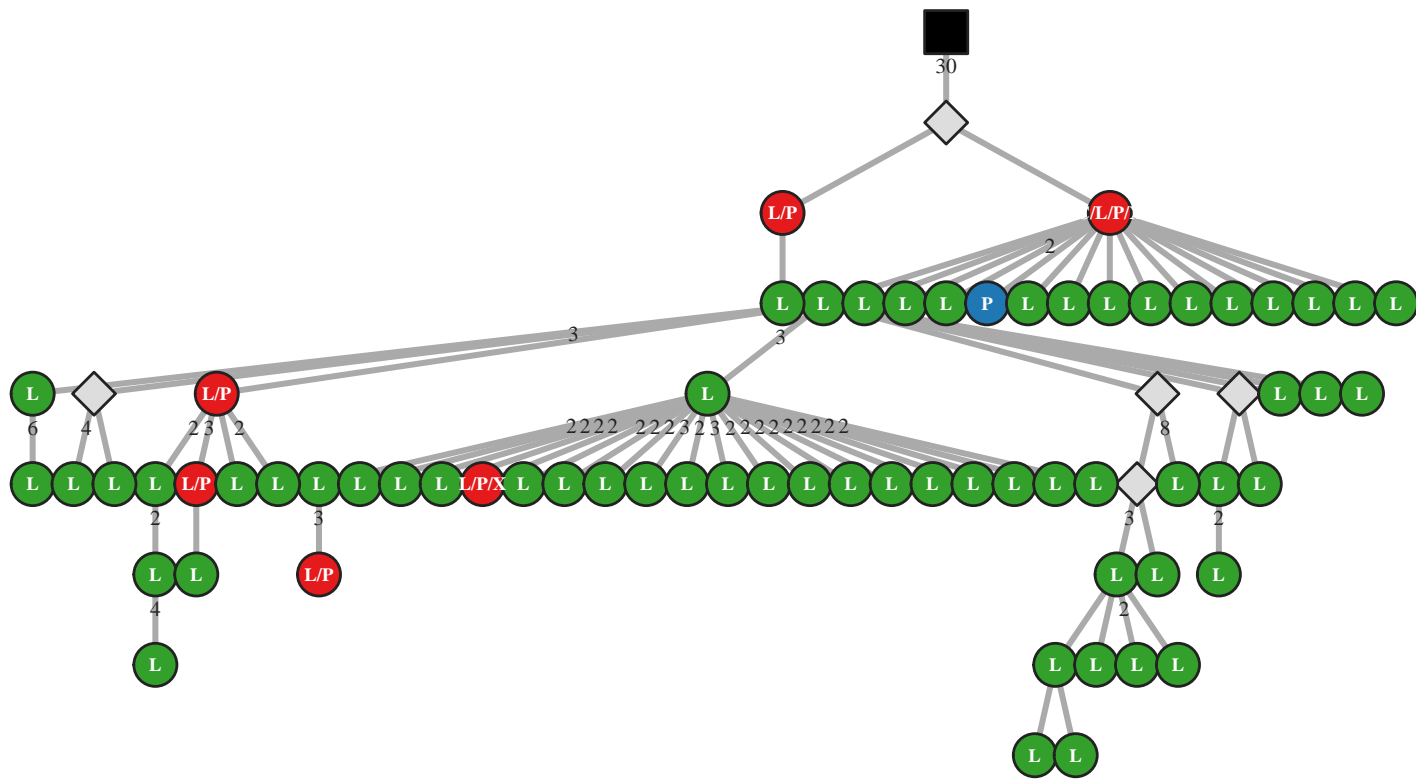

M5 IgG IGHV5-51/J4 45bp (19873)

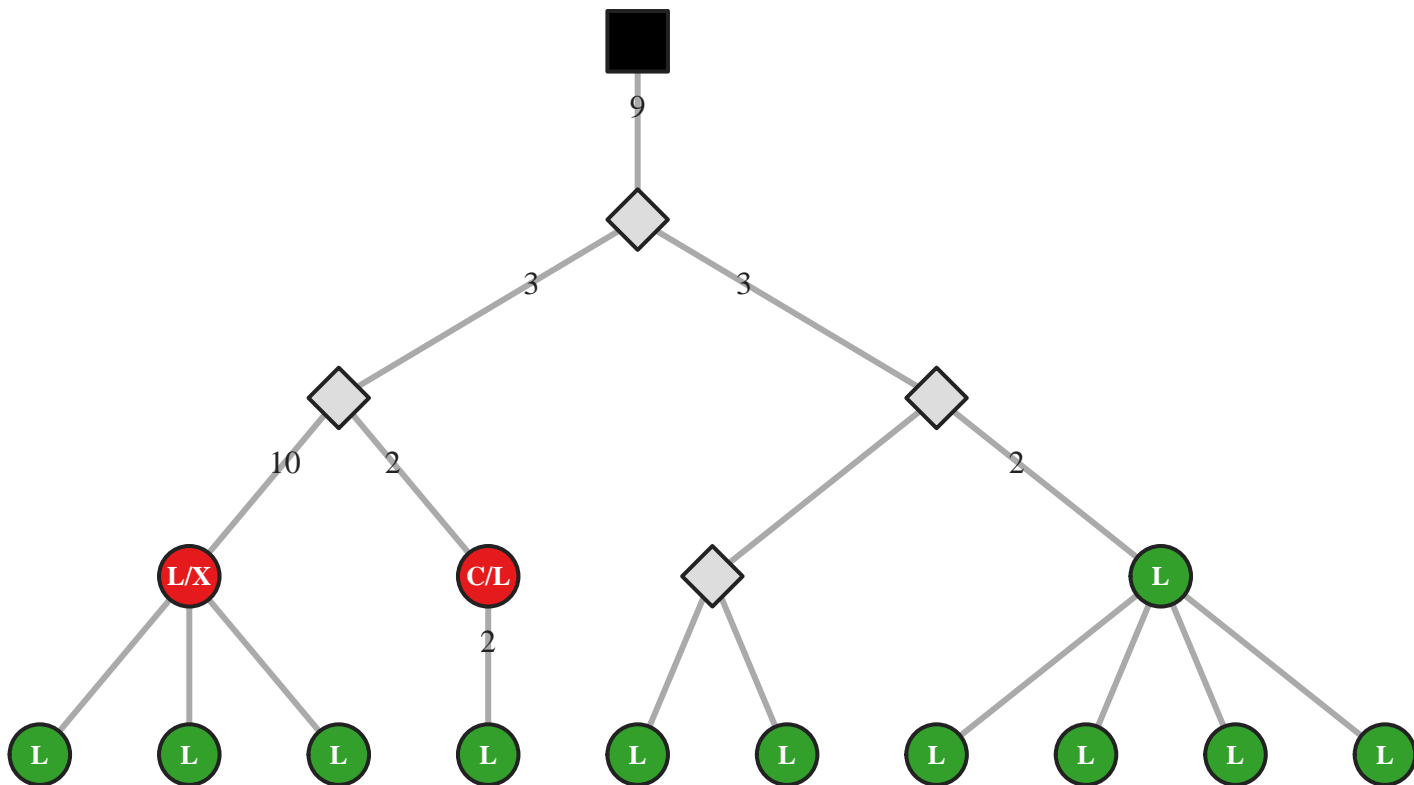

M5 IgG IGHV5-51/J4 45bp (19889)

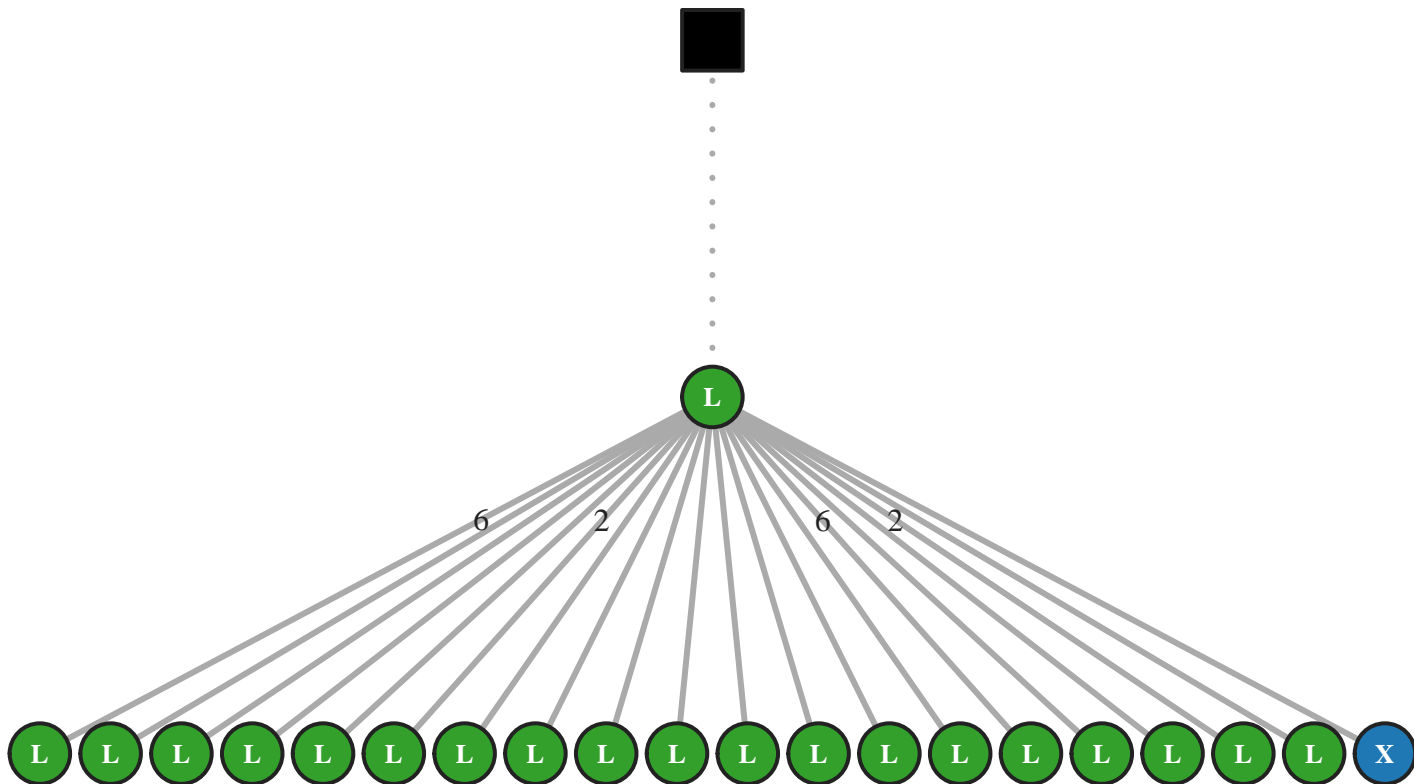

M5 IgG IGHV5-51/J4 48bp (53577)

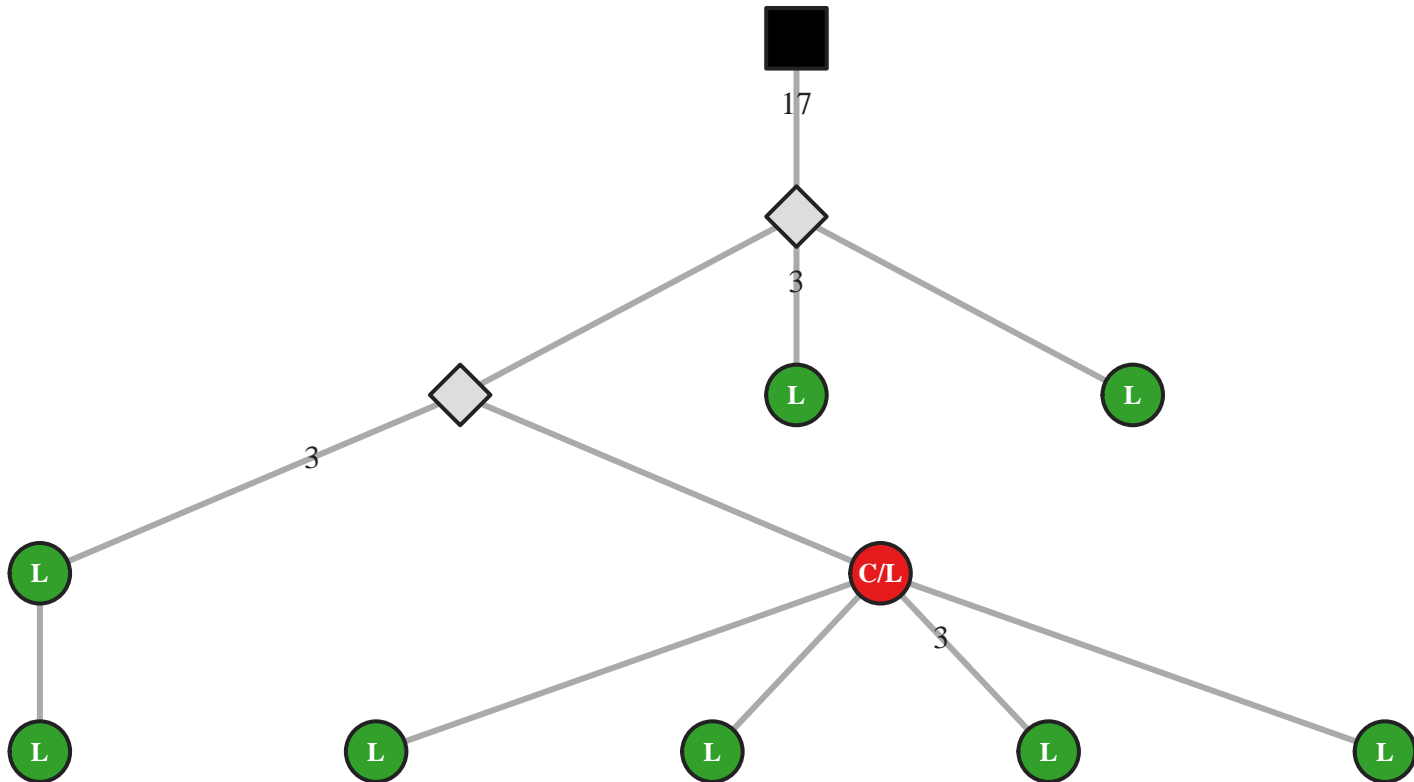

M5 IgG IGHV5-51/J4 48bp (53580)

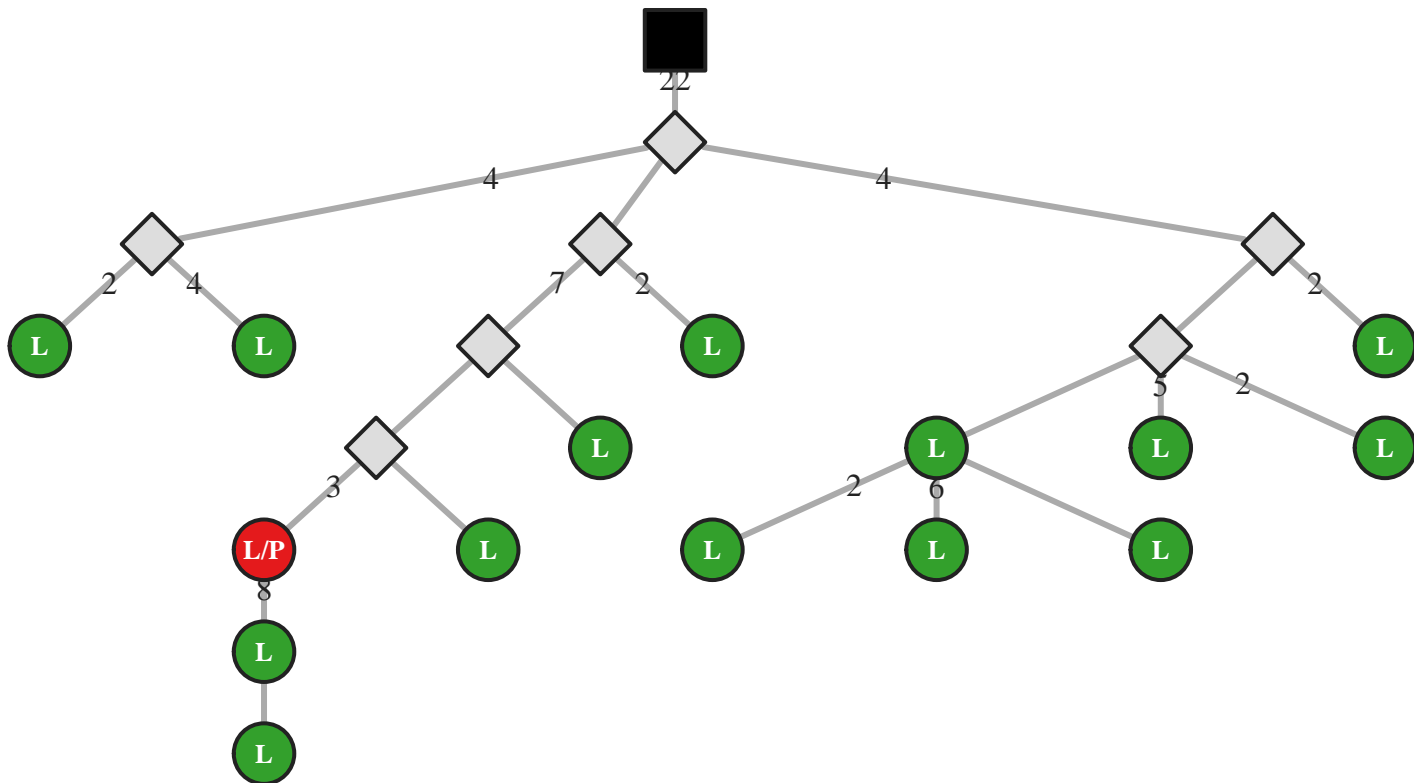

M5 IgG IGHV5-51/J4 48bp (53595)

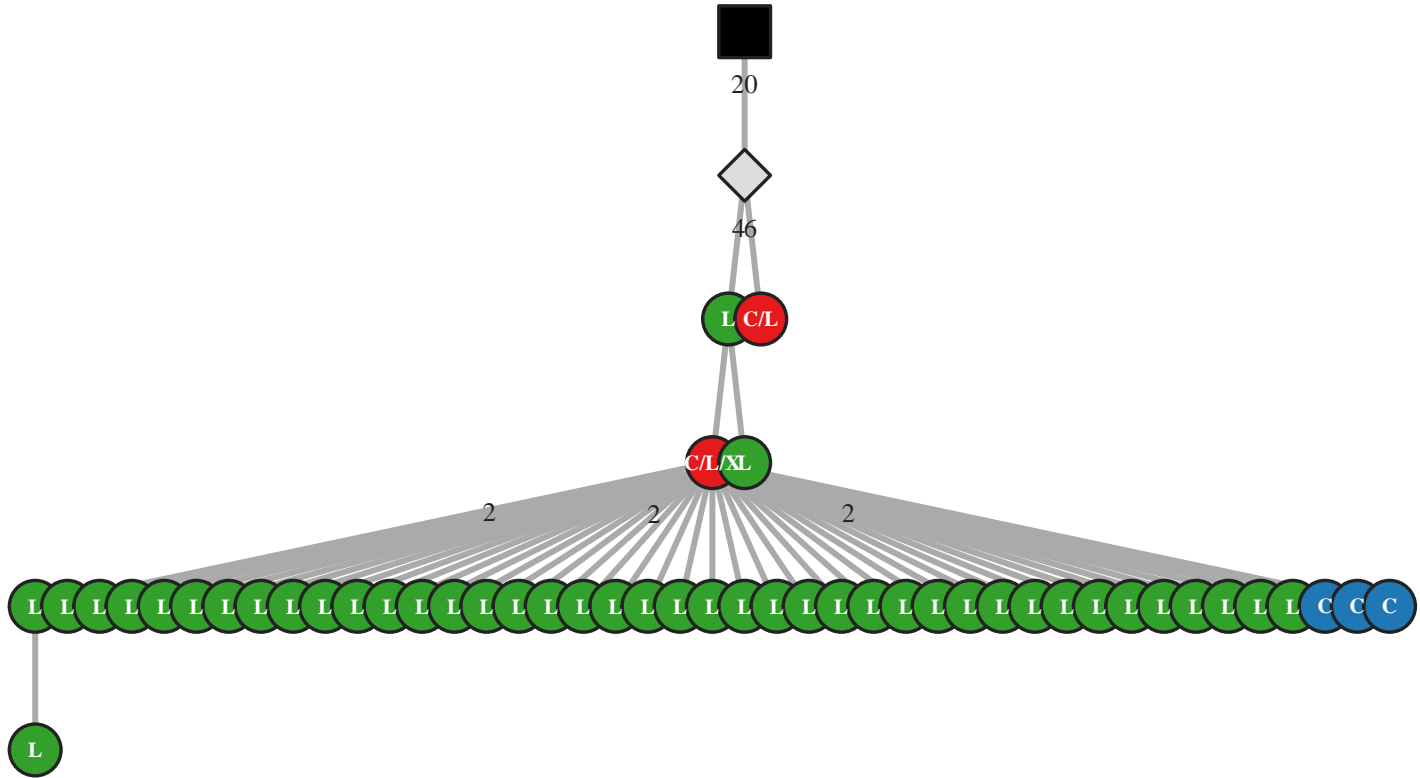

M5 IgG IGHV5-51/J4 51bp (19958)

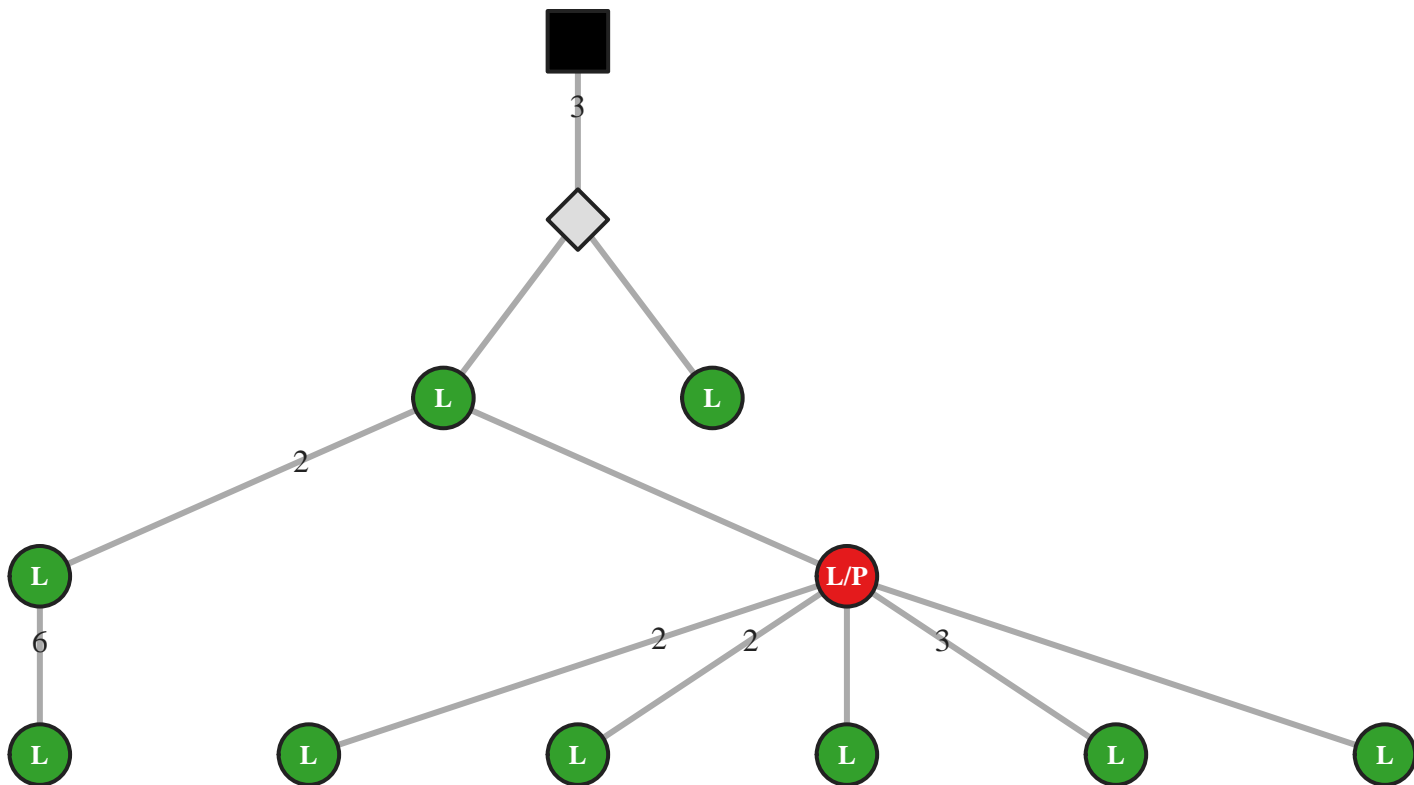

M5 IgG IGHV5-51/J4 51bp (19981)

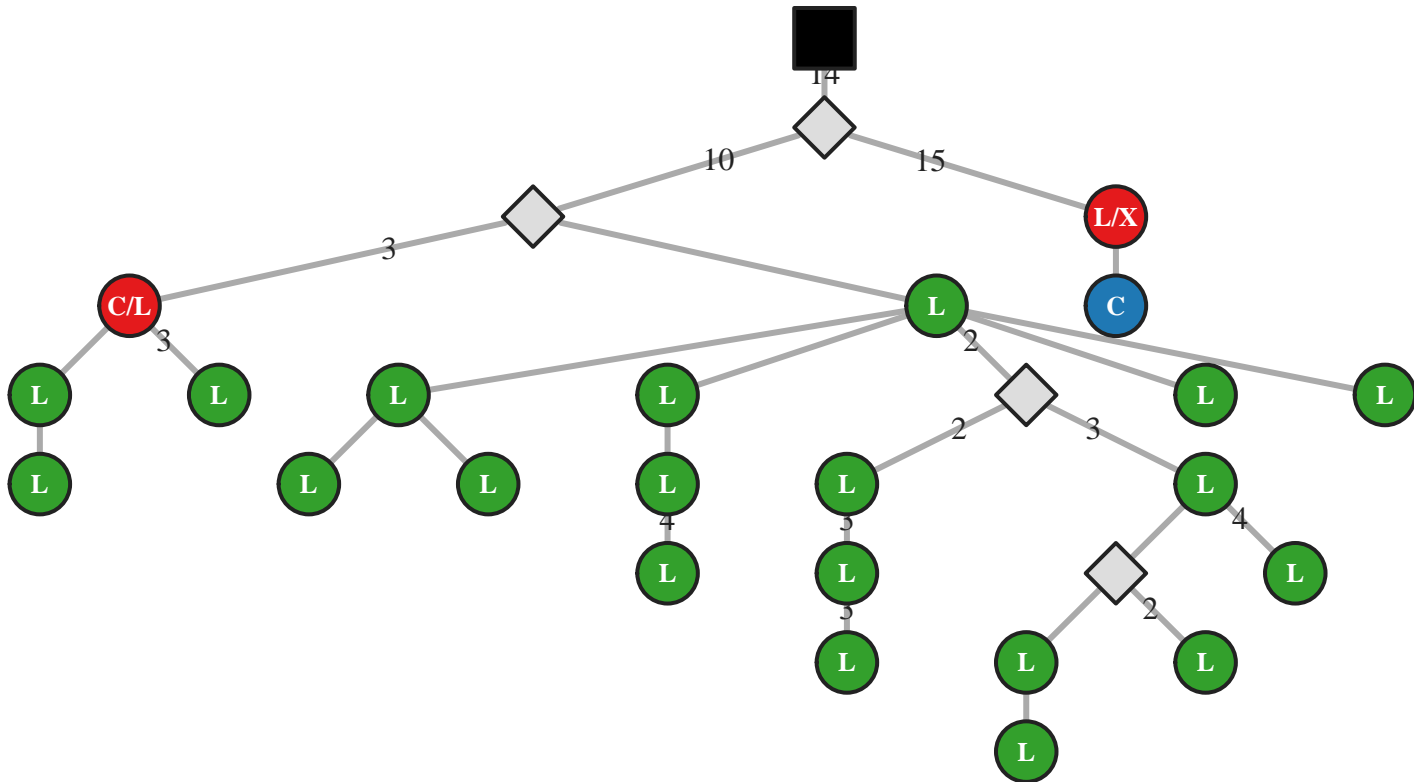

M5 IgM IGHV5-51/J4 51bp (21028)

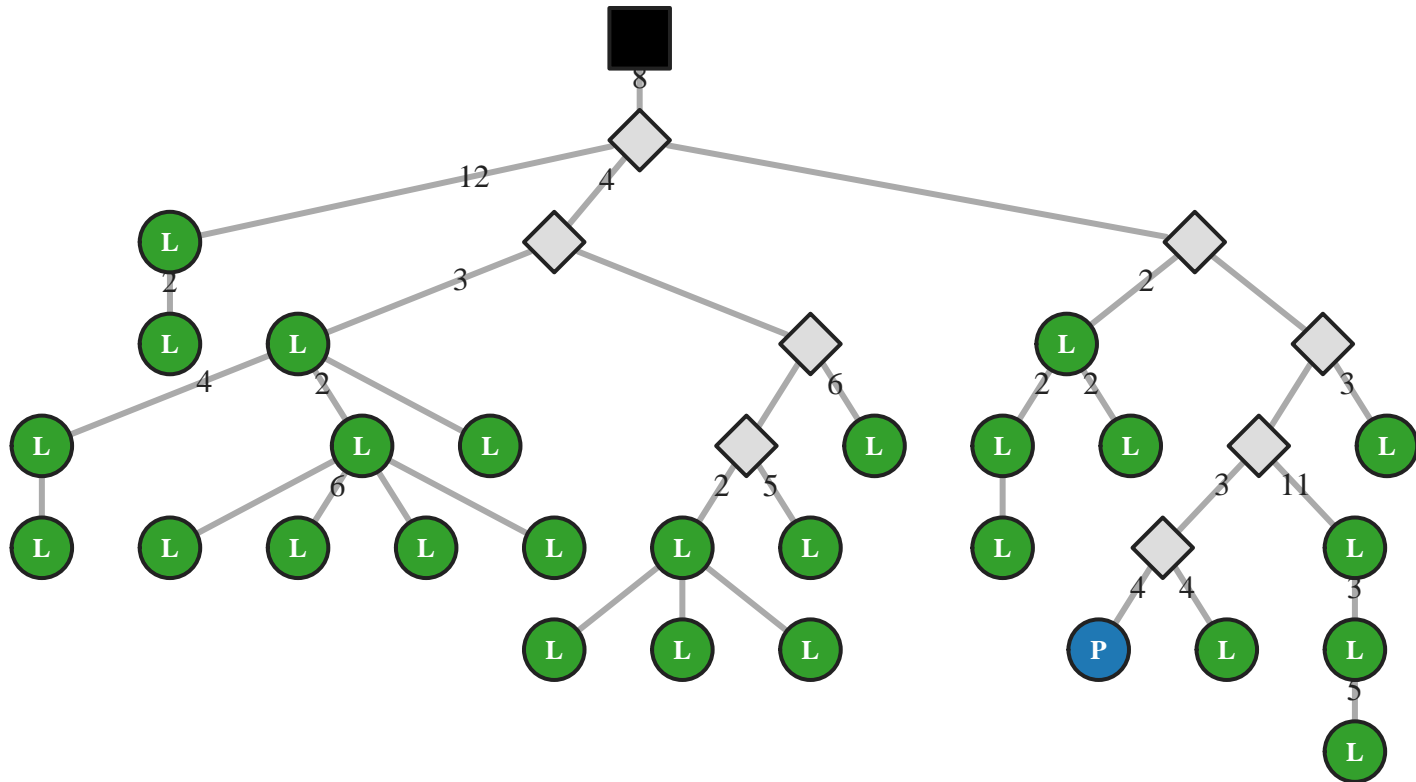

M5 IgG IGHV5-51/J4 54bp (47153)

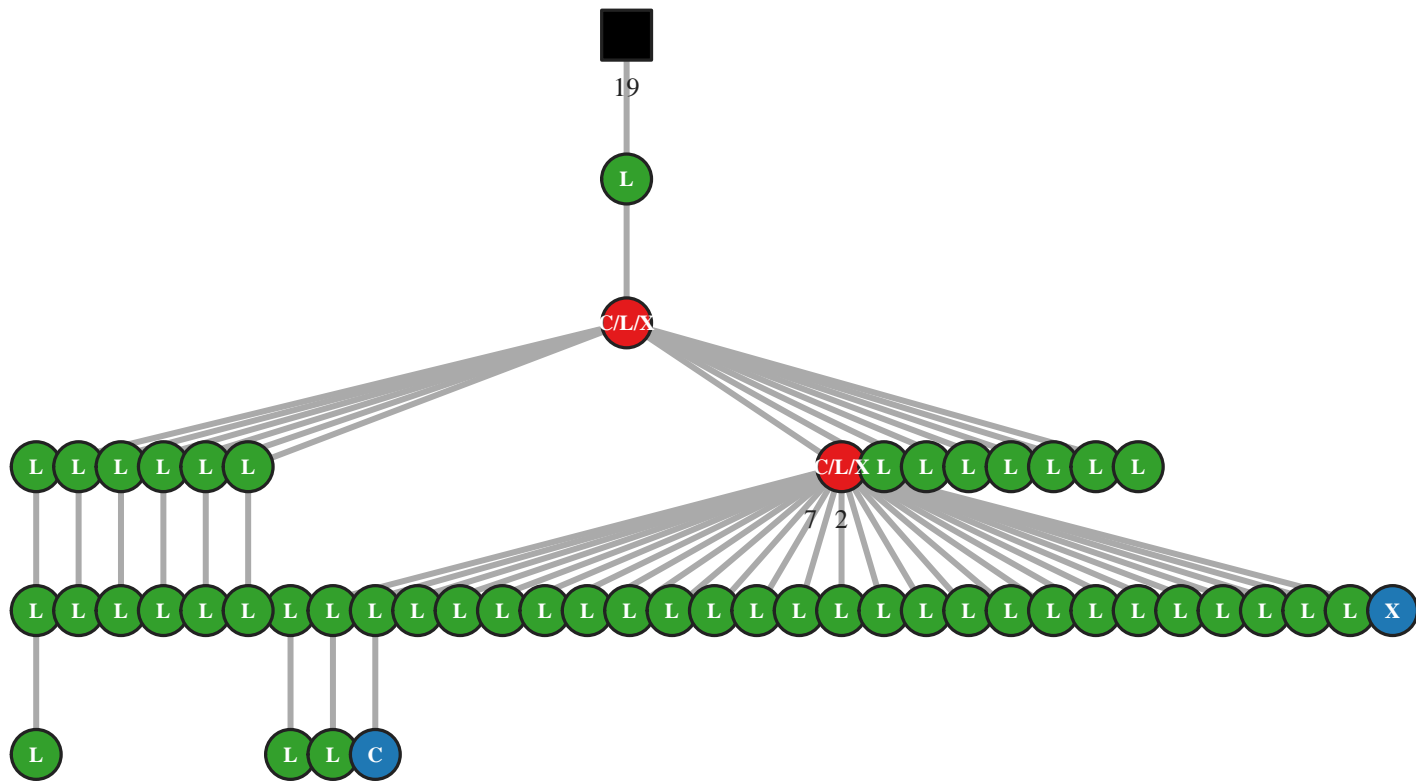

M5 IgG IGHV5-51/J4 54bp (47168)

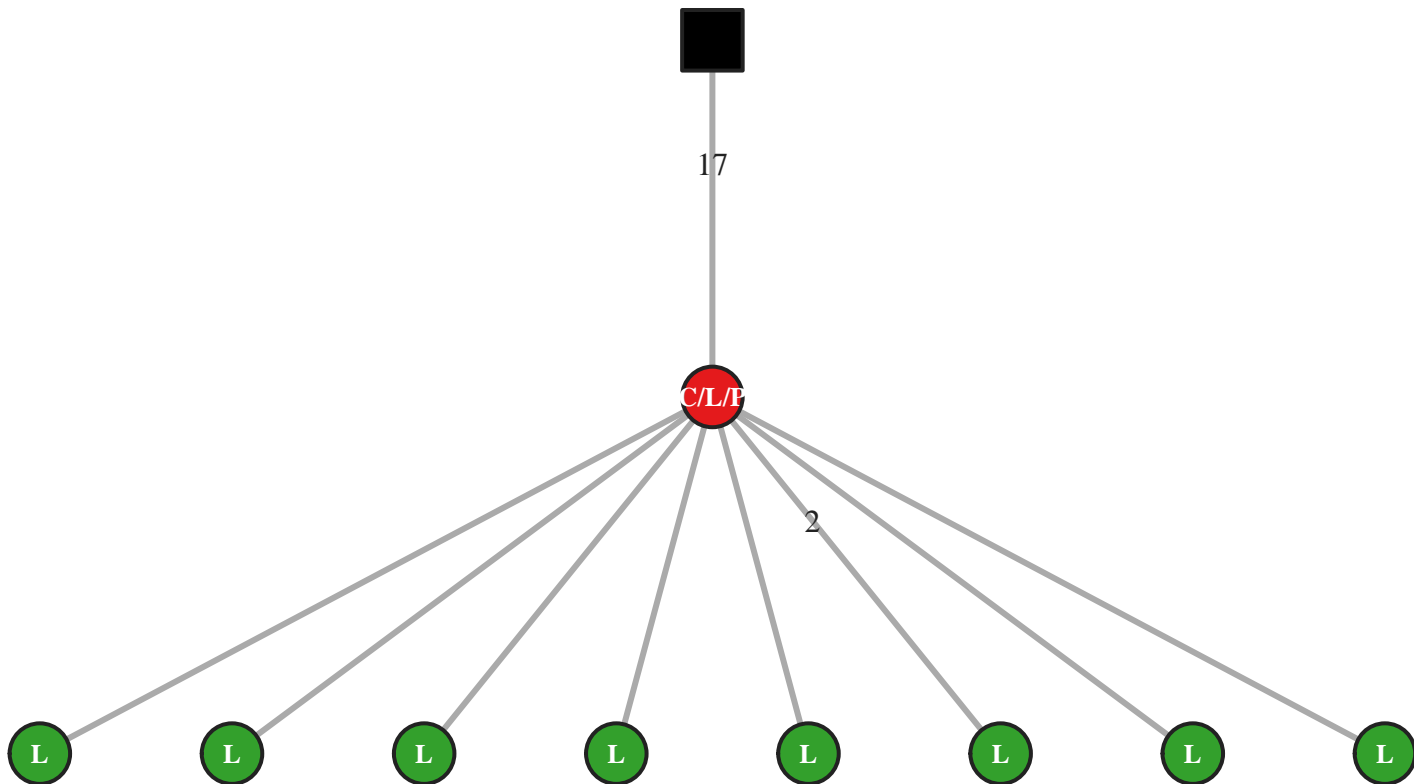

M5 IgG IGHV5-51/J4 54bp (47182)

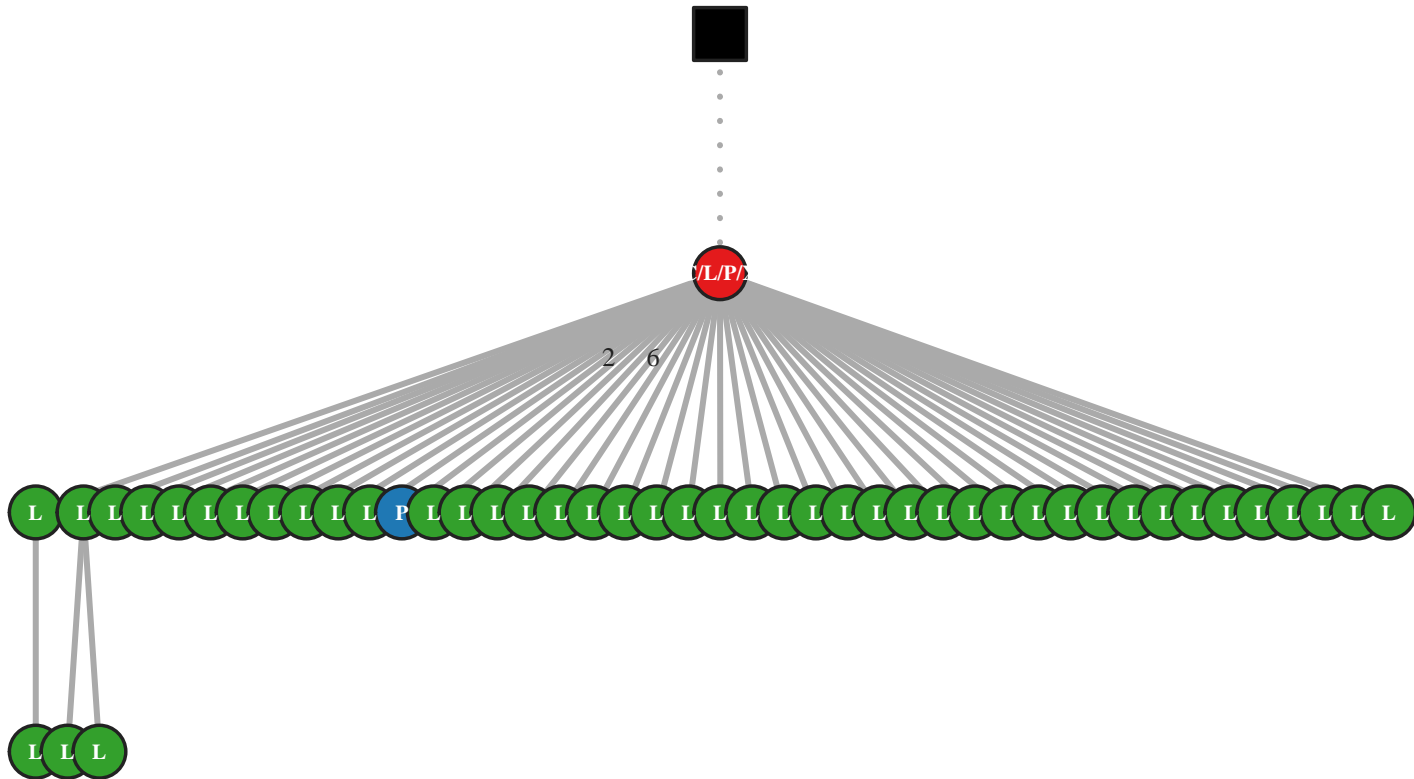

M5 IgG IGHV5-51/J4 54bp (47202)

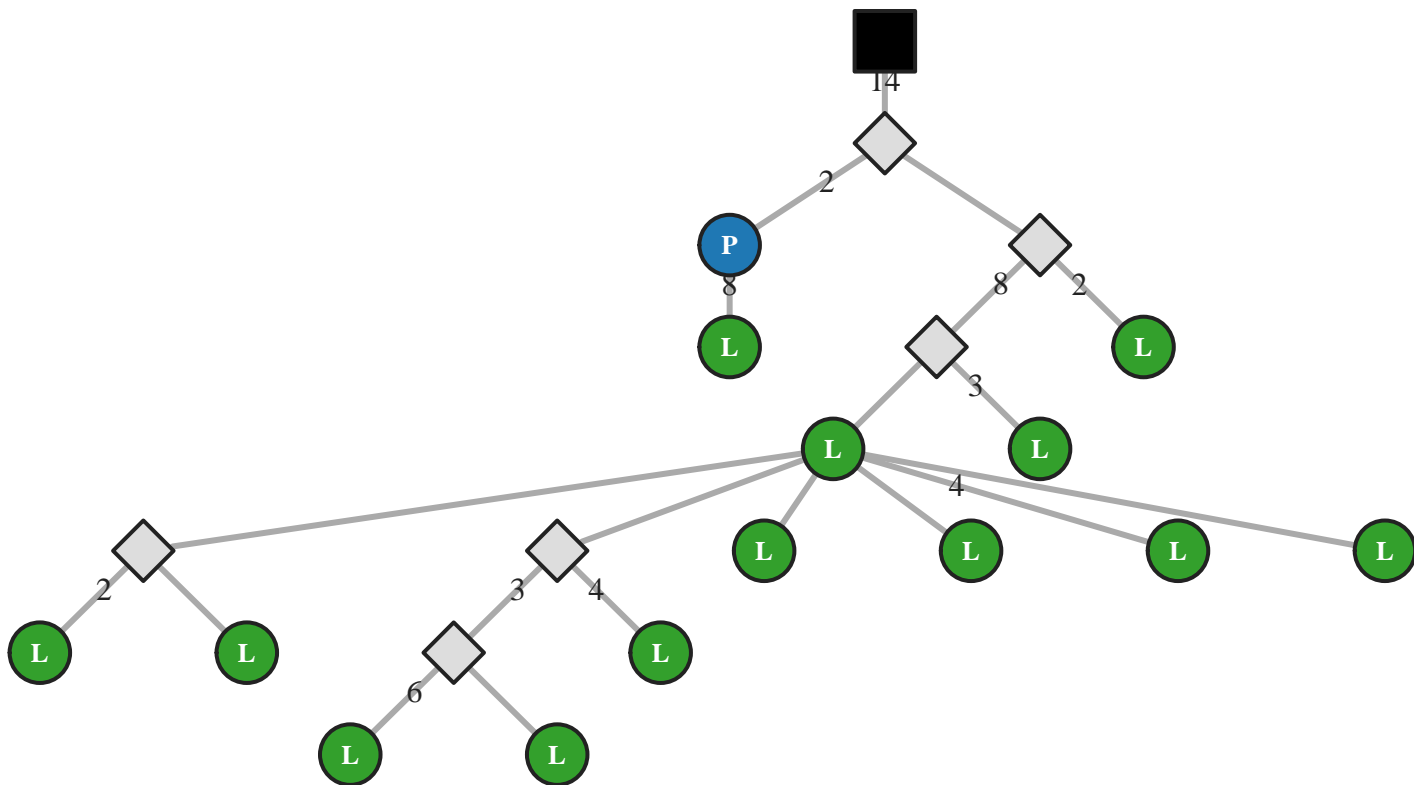

M5 IgG IGHV5-51/J4 57bp (47219)

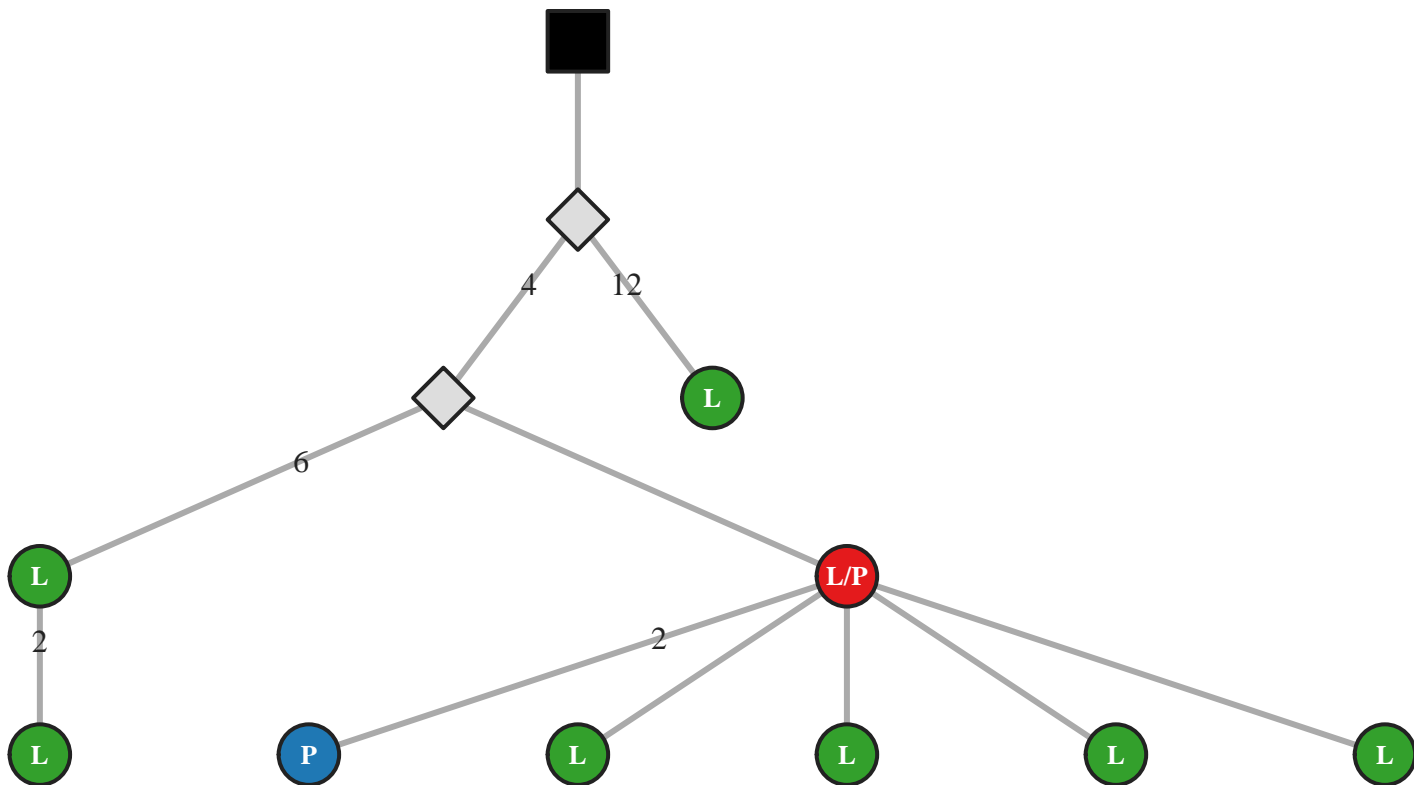

M5 IgA IGHV5-51/J4 63bp (49069)

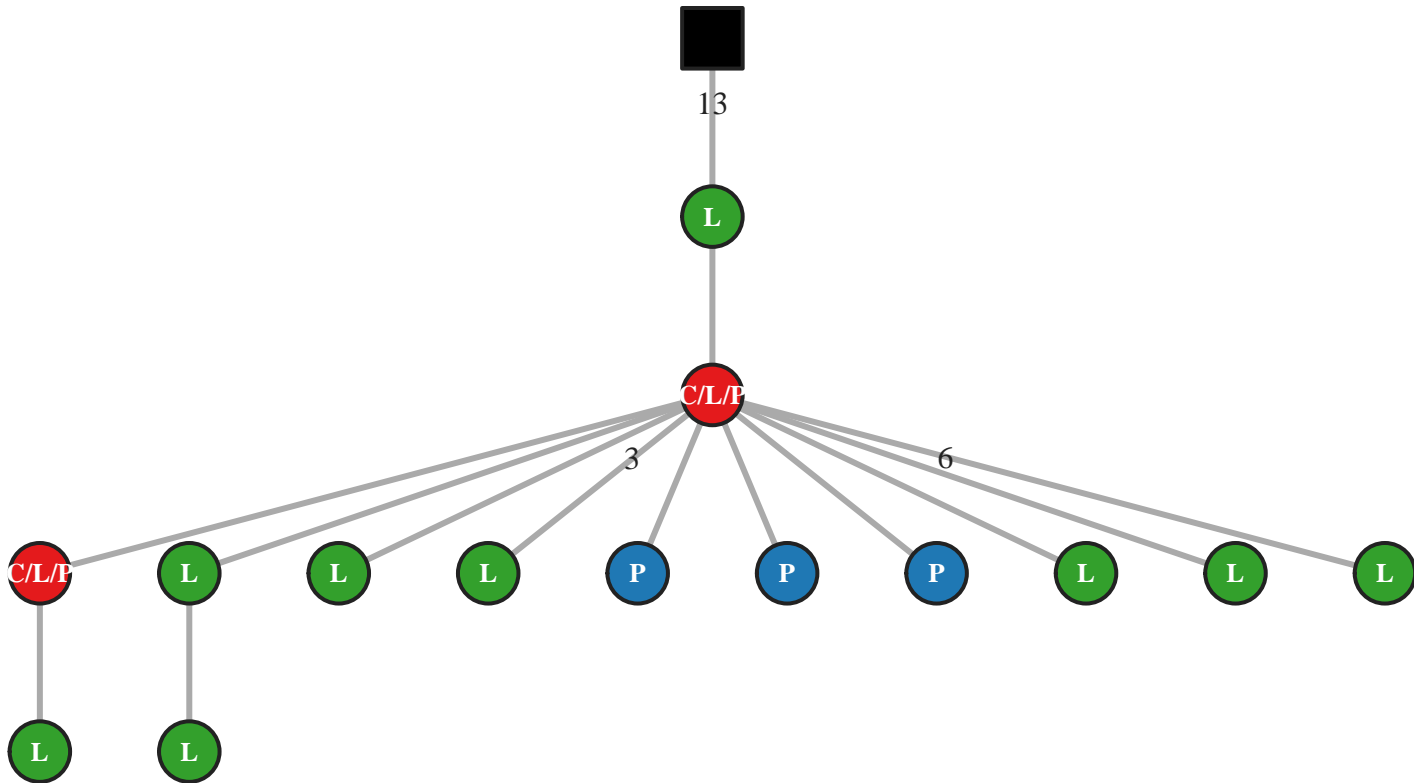

M5 IgG IGHV5-51/J4 63bp (28752)

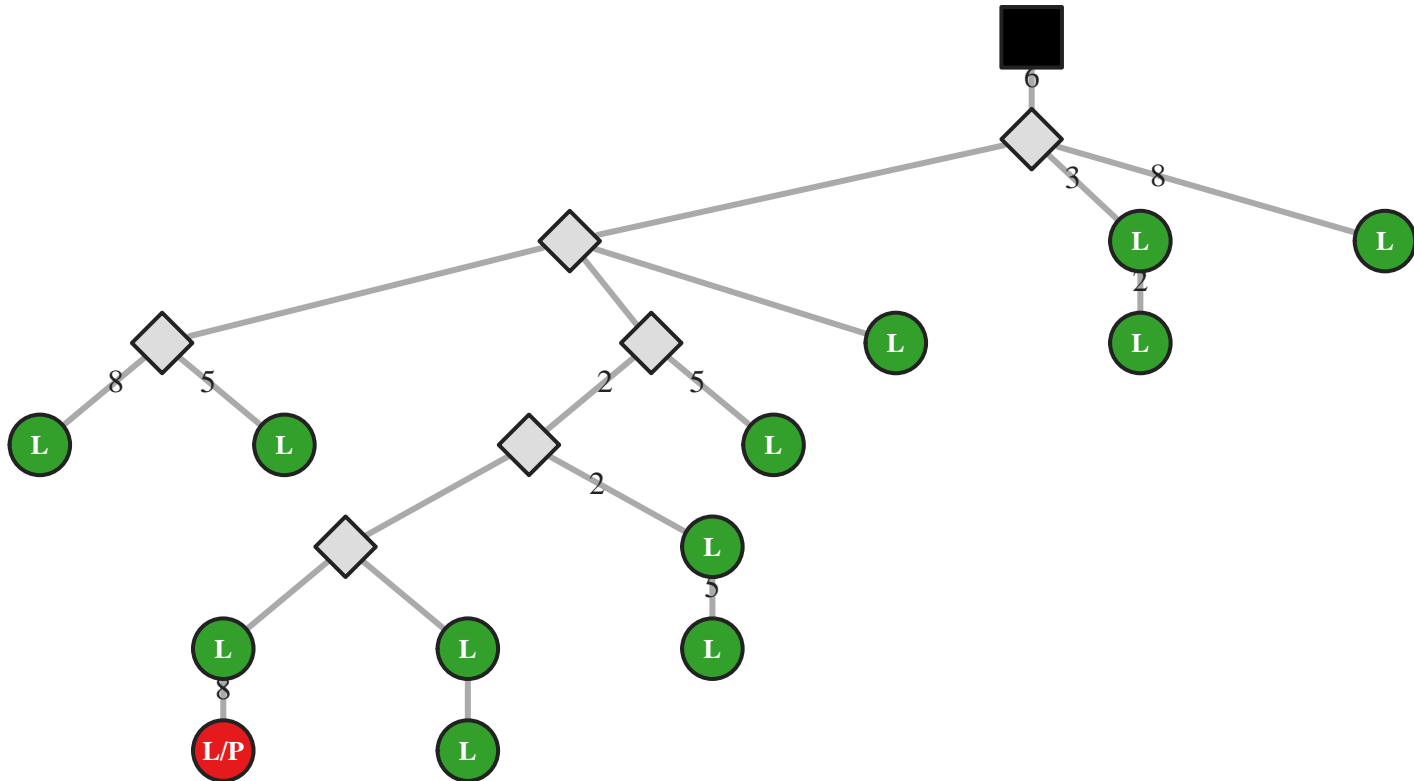

M5 IgG IGHV5-51/J4 66bp (36878)

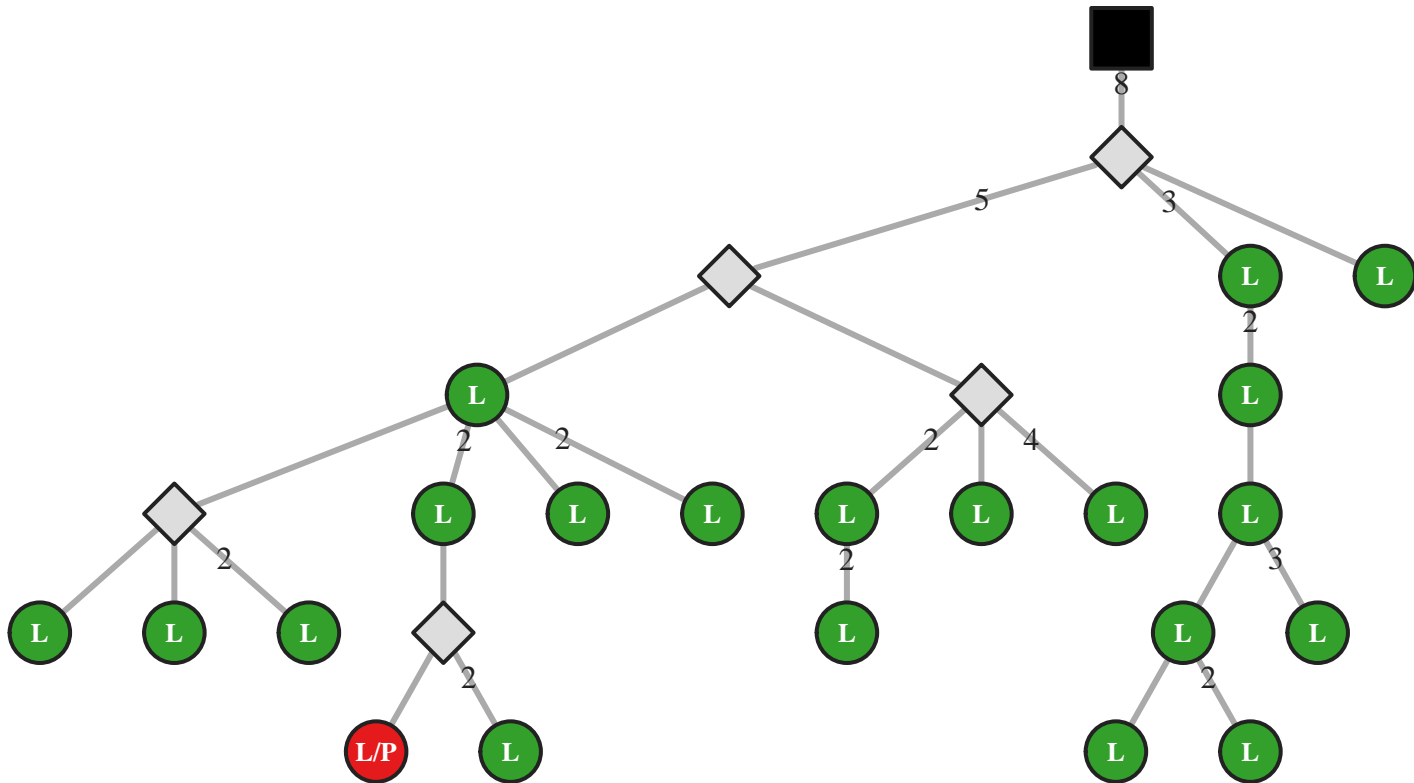

M5 IgG IGHV5-51/J5 42bp (53678)

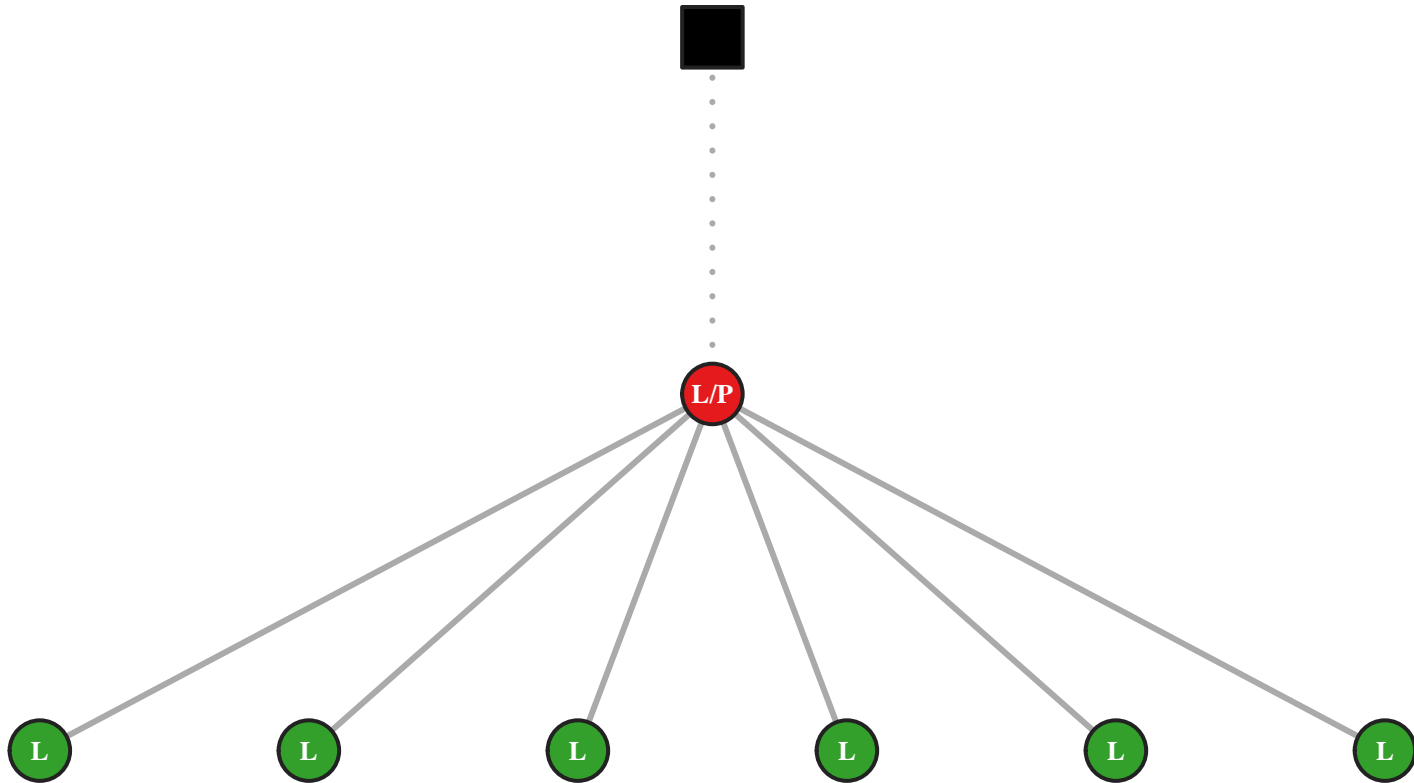

M5 IgG IGHV5-51/J5 42bp (53682)

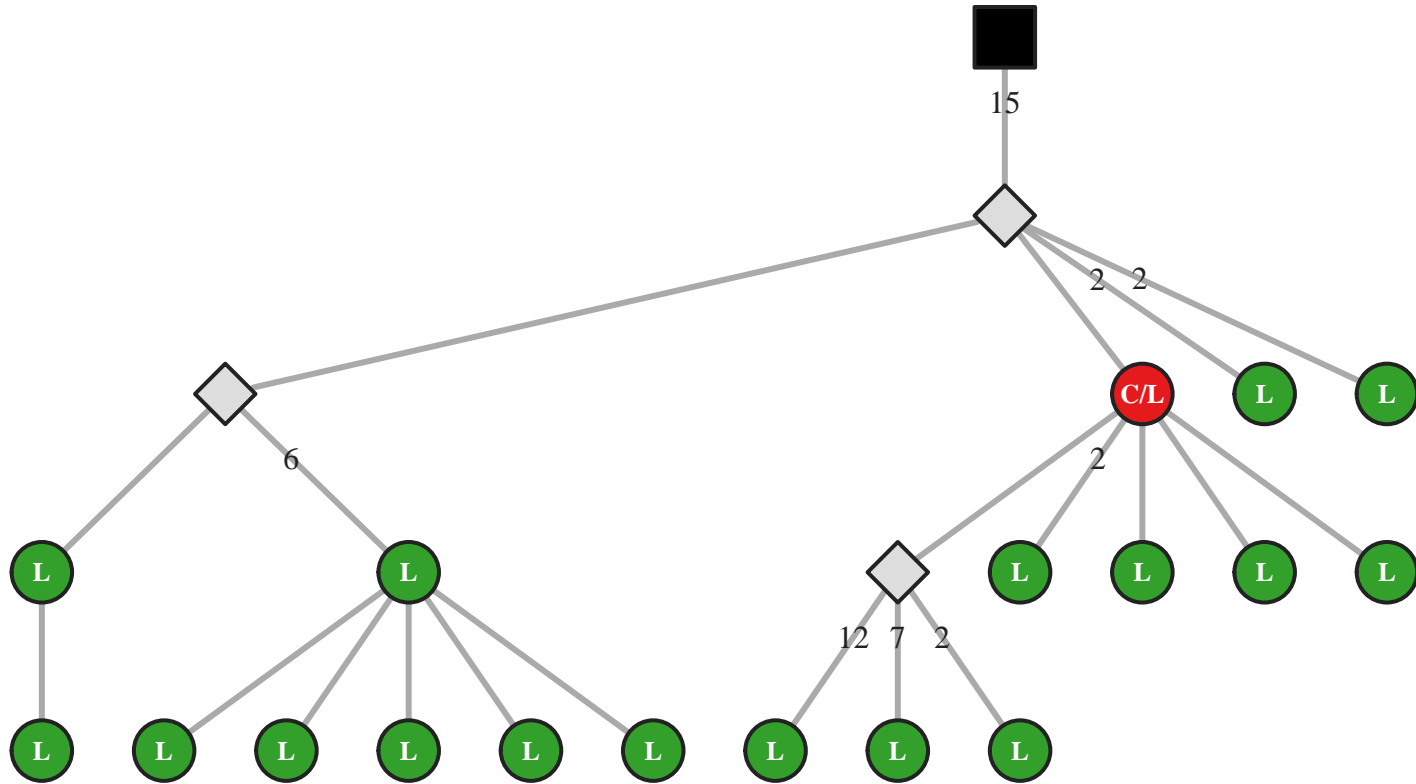

M5 IgG IGHV5-51/J5 42bp (53687)

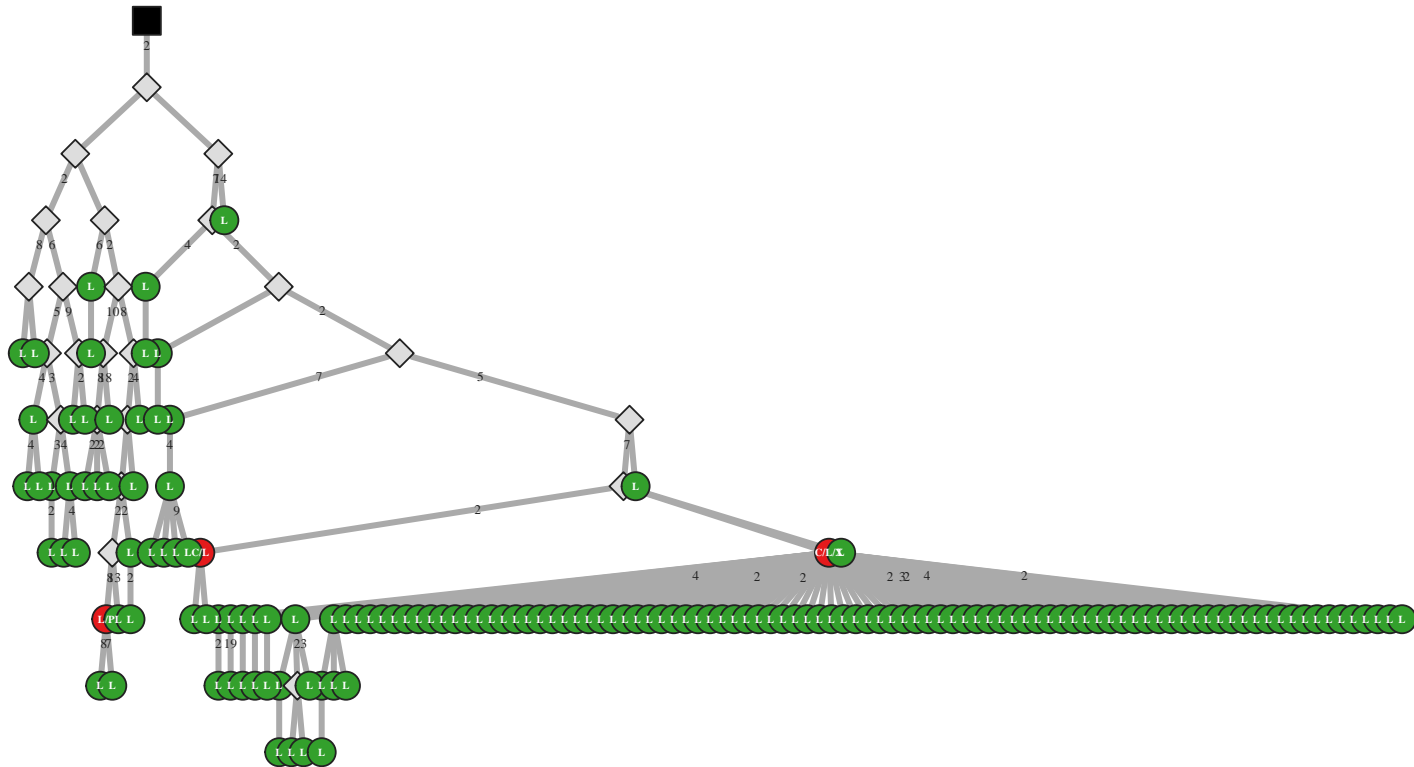

M5 IgA IGHV5-51/J5 57bp (30892)

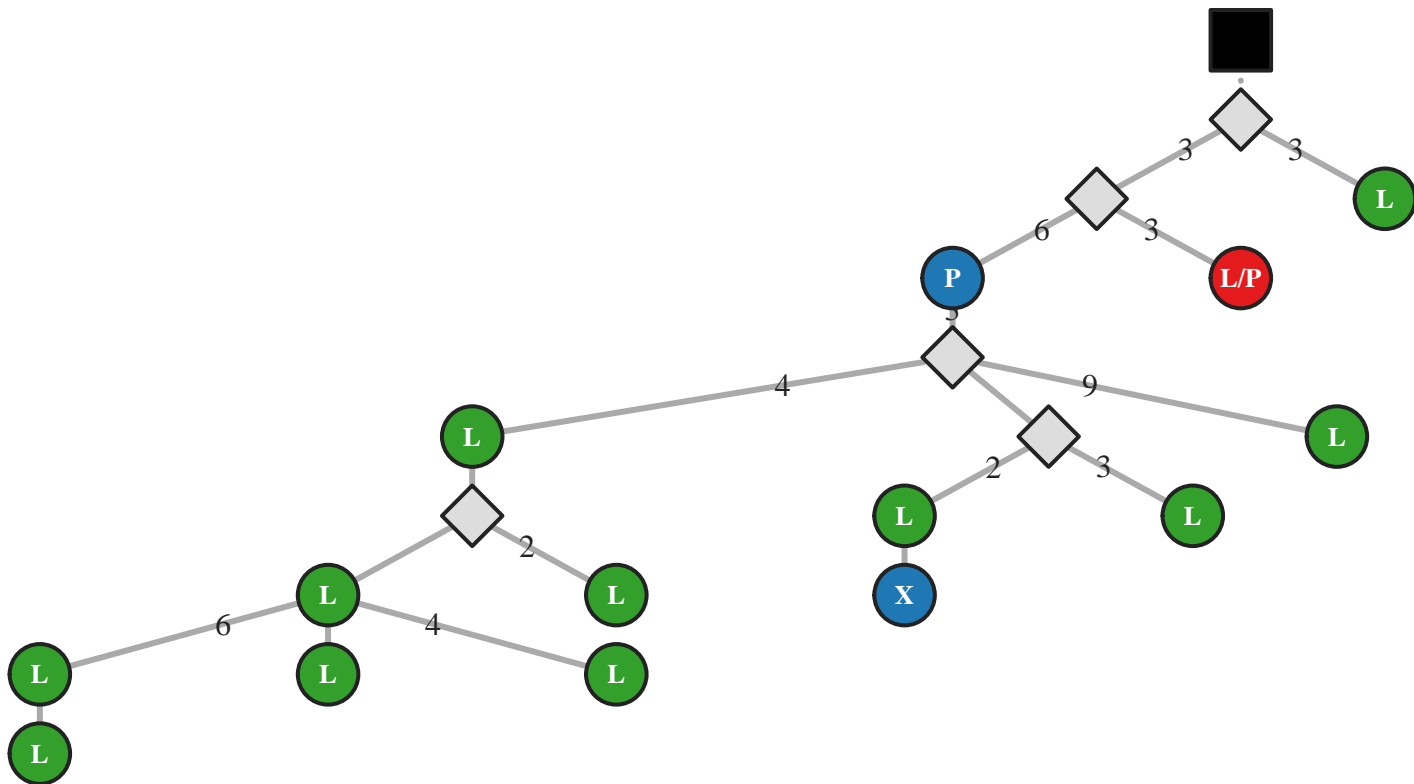

M5 IgG IGHV5-51/J5 60bp (10509)

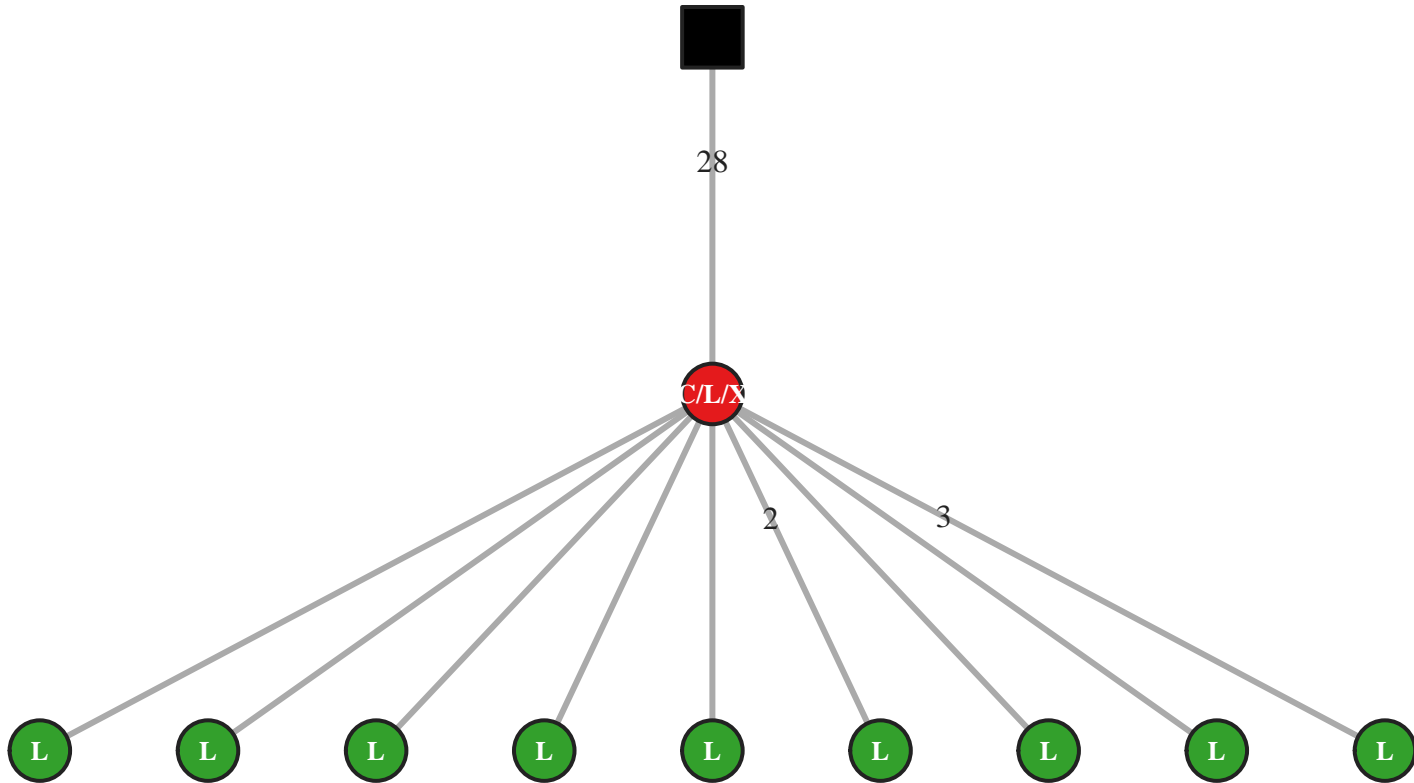

M5 IgG IGHV5-51/J5 63bp (53695)

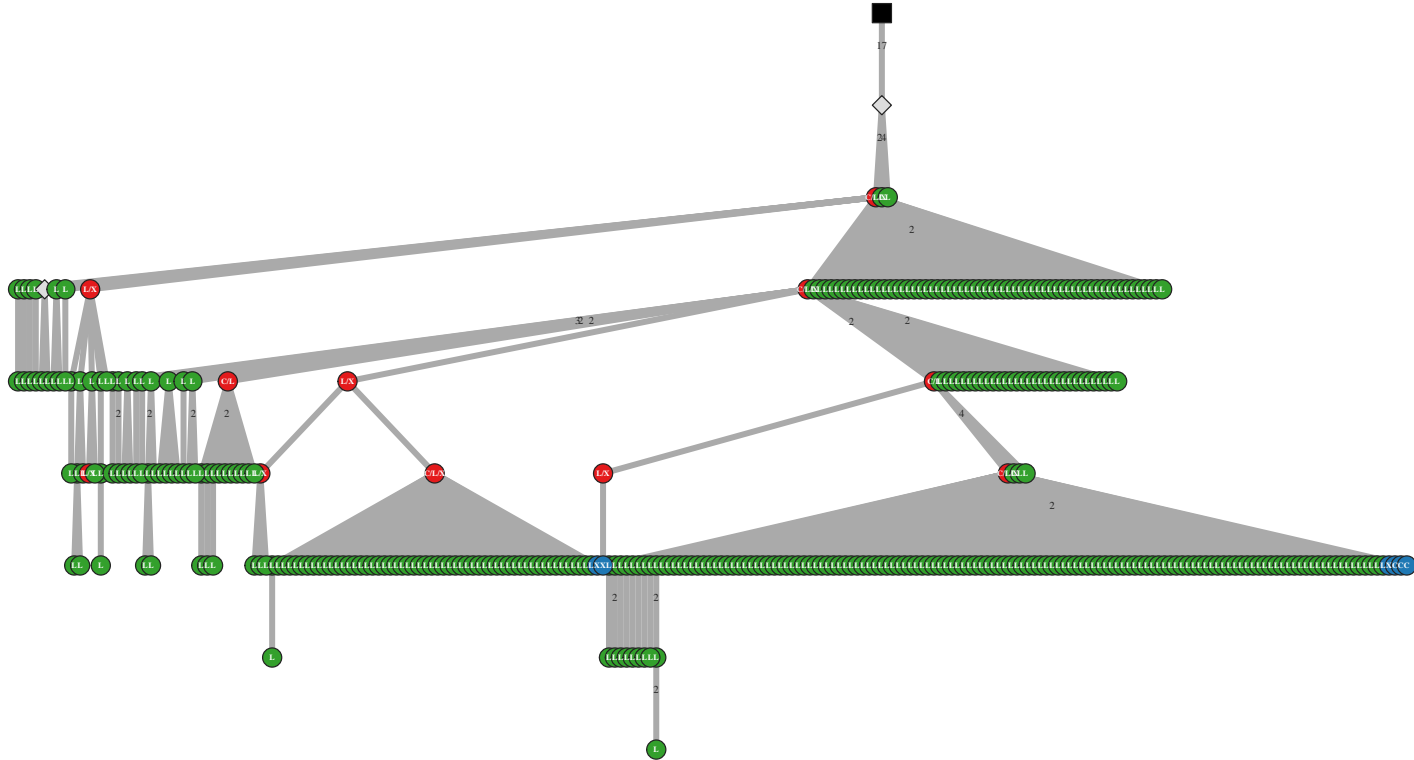

M5 IgG IGHV5-51/J6 33bp (47278)

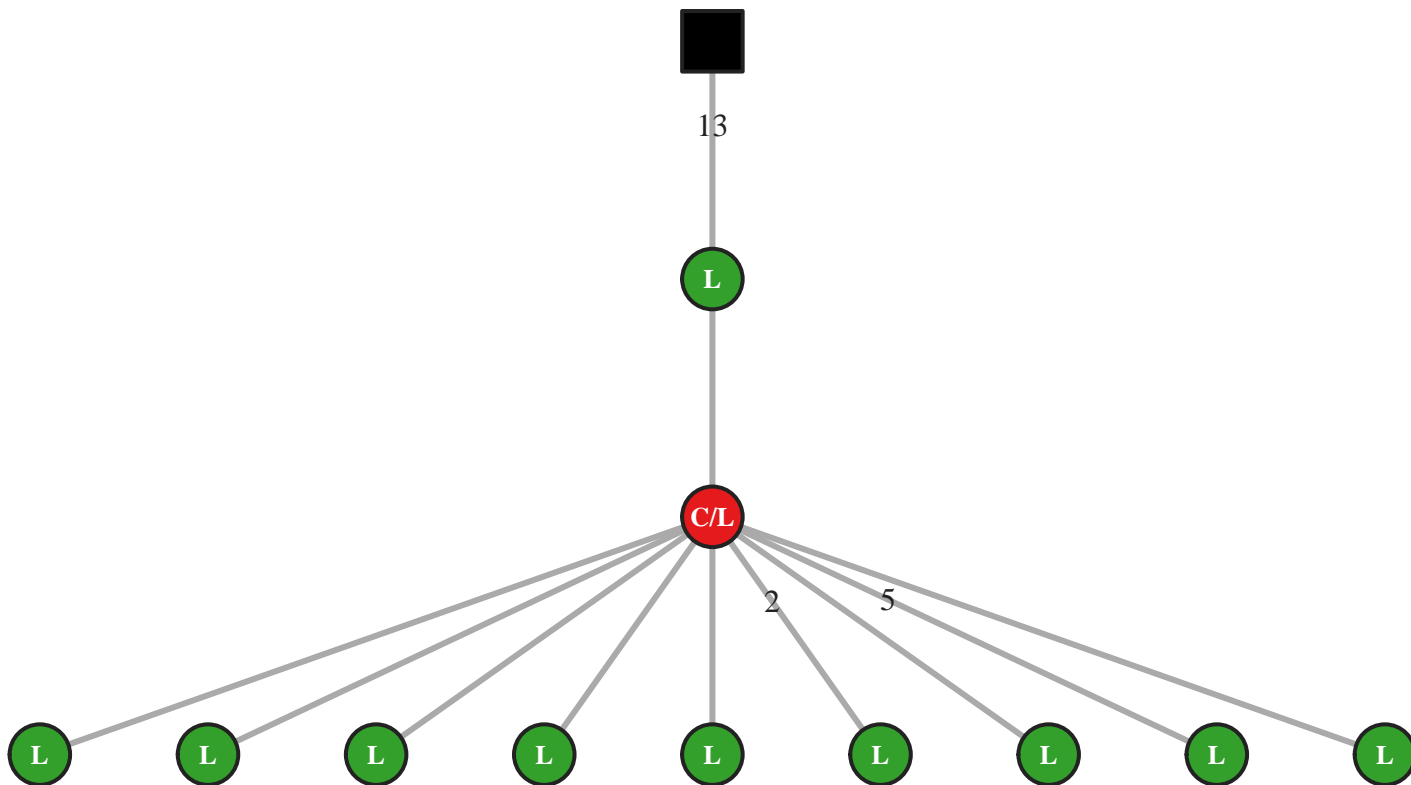

M5 IgG IGHV5-51/J6 45bp (53712)

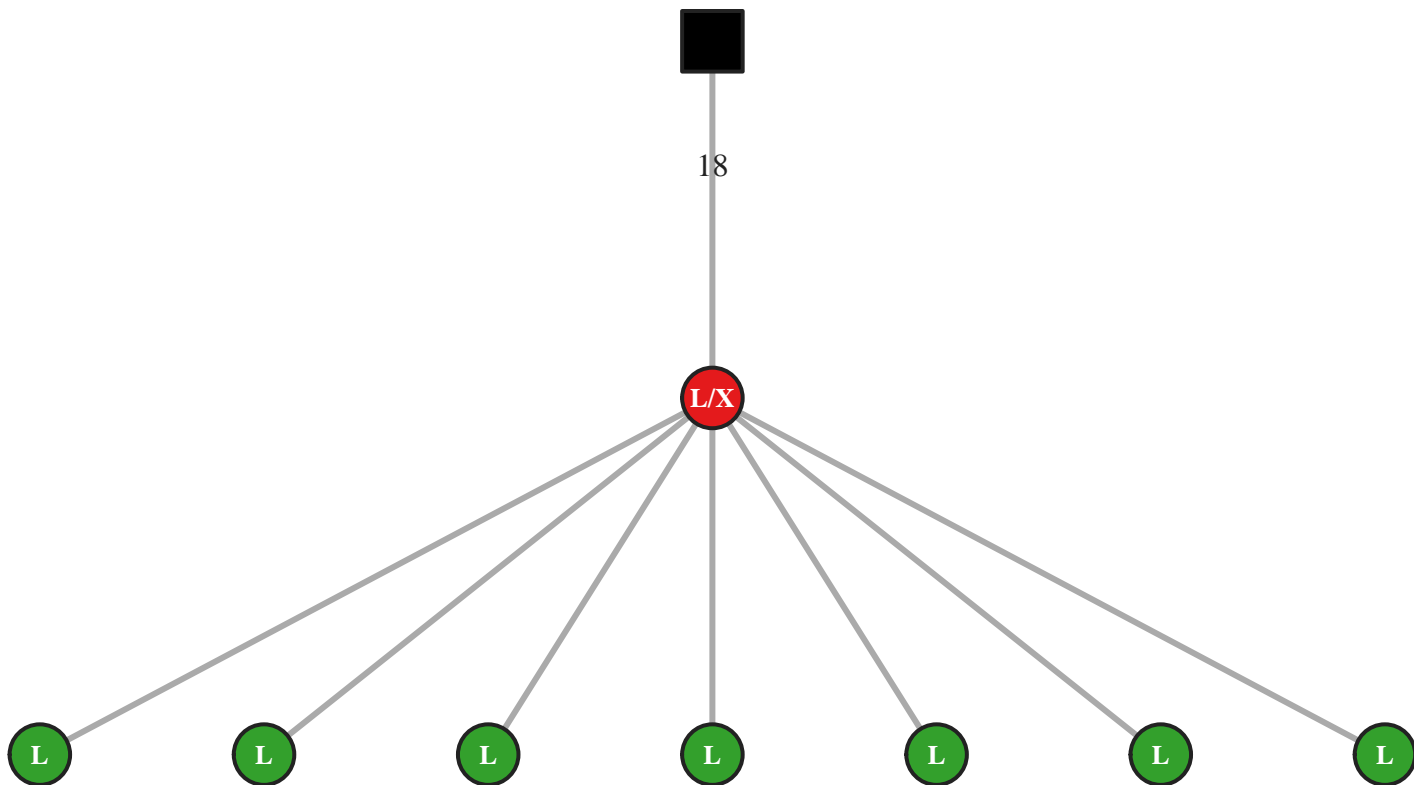

M5 IgG IGHV5-51/J6 51bp (20055)

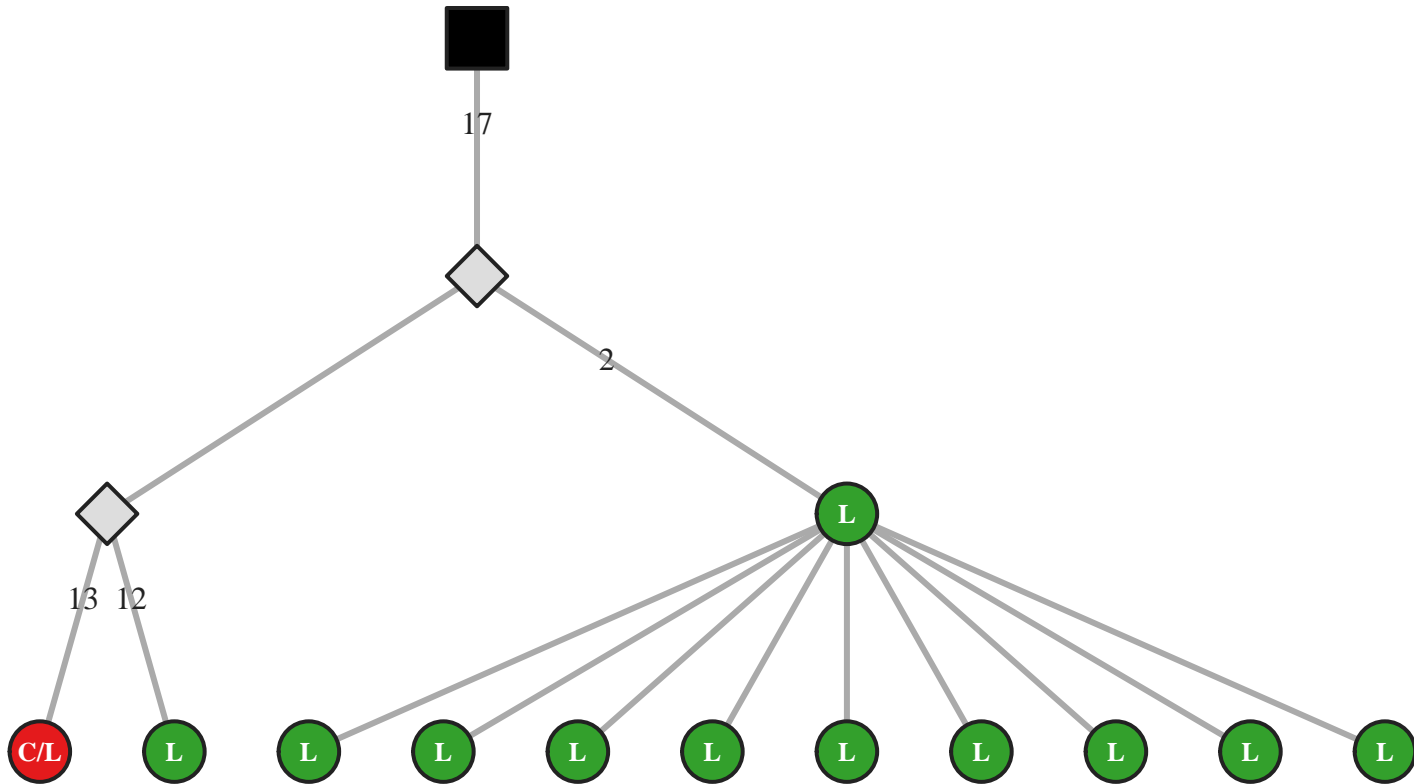

M5 IgG IGHV5-51/J6 51bp (20060)

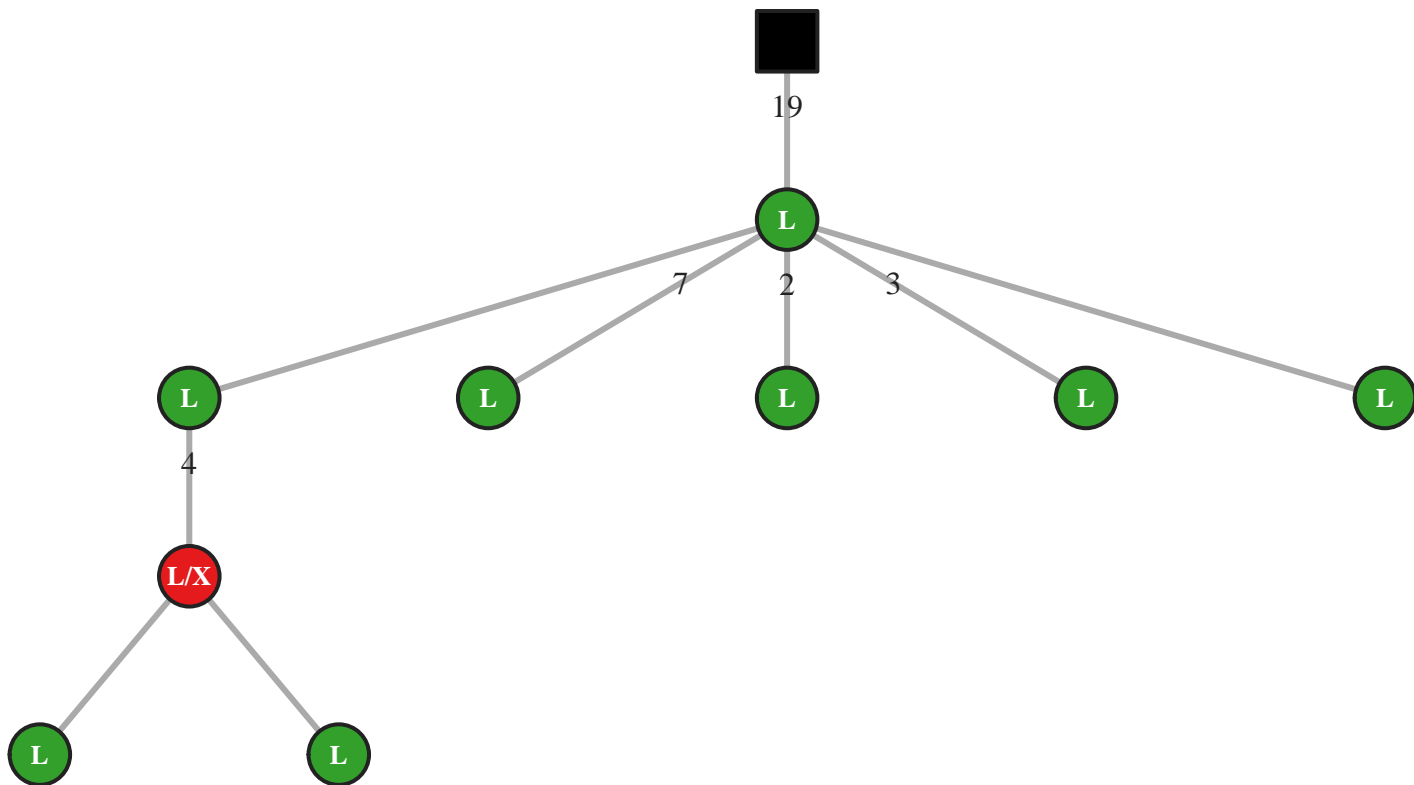

M5 IgG IGHV5-51/J6 54bp (10531)

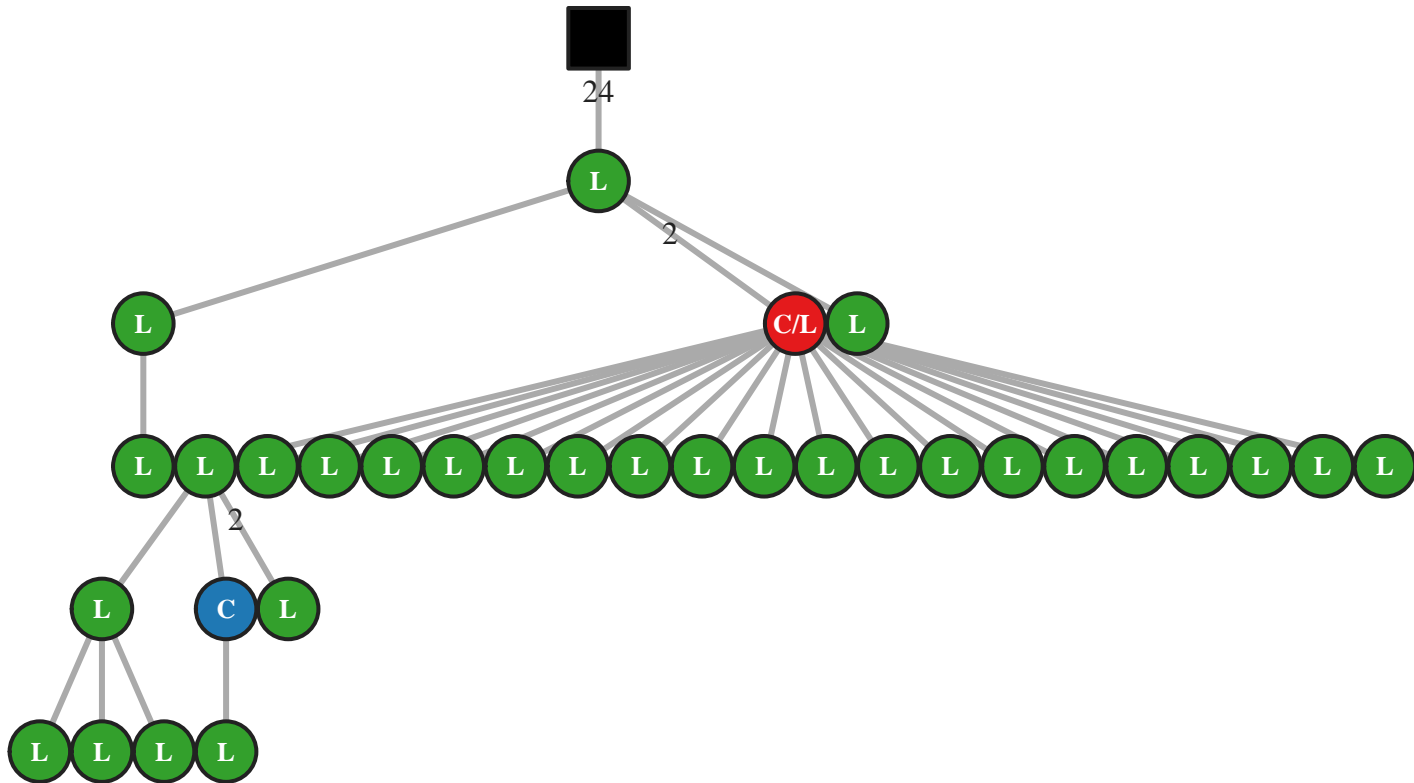

M5 IgG IGHV5-51/J6 57bp (10558)

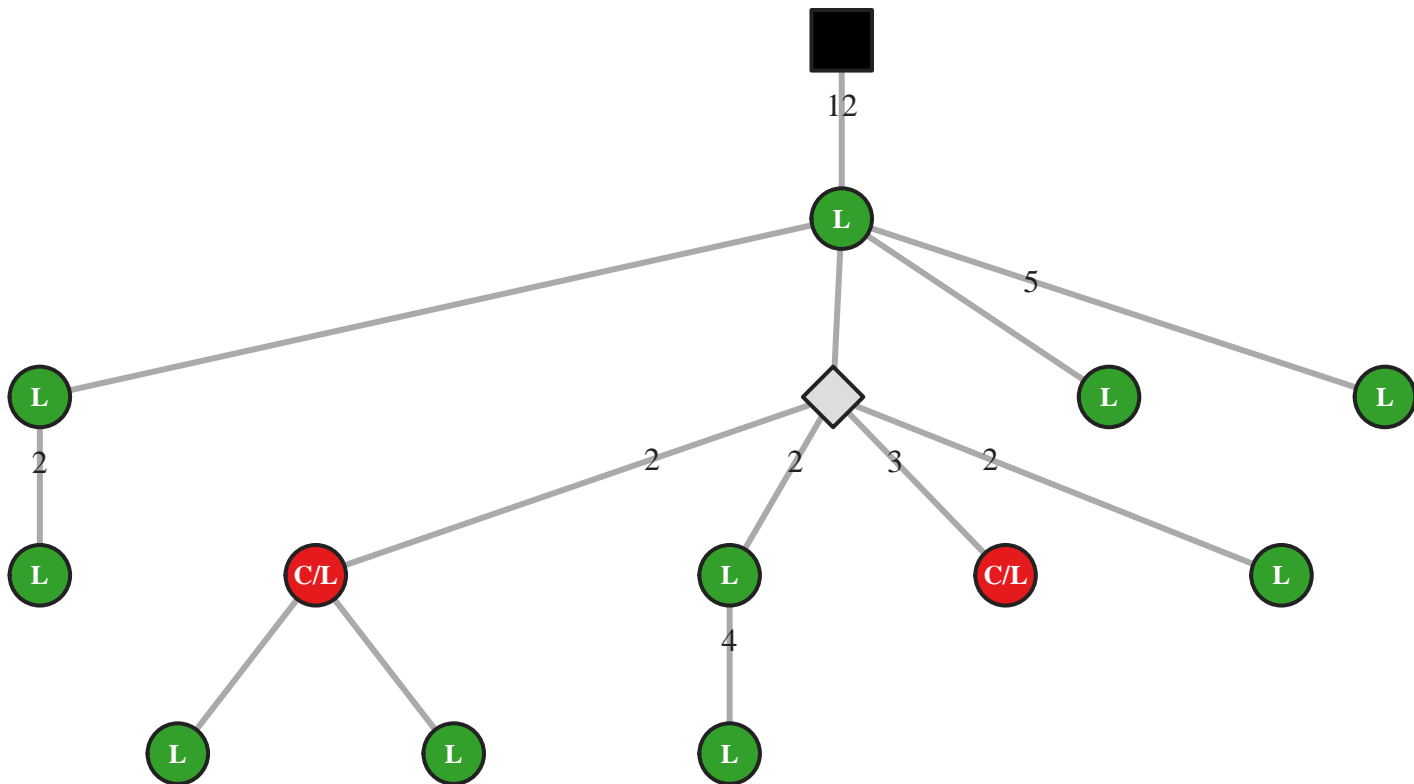

M5 IgG IGHV5-51/J6 63bp (10579)

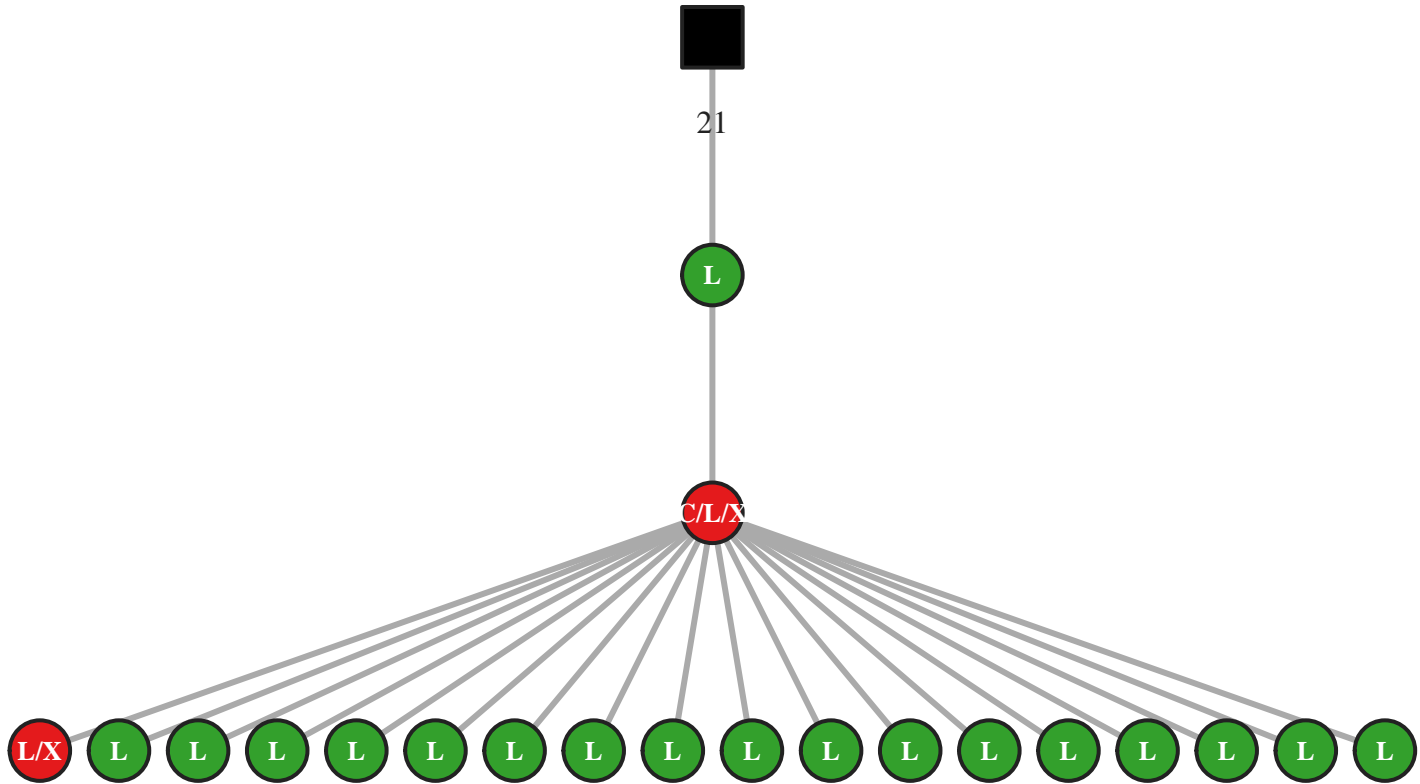

M5 IgA IGHV5-51/J6 66bp (3238)

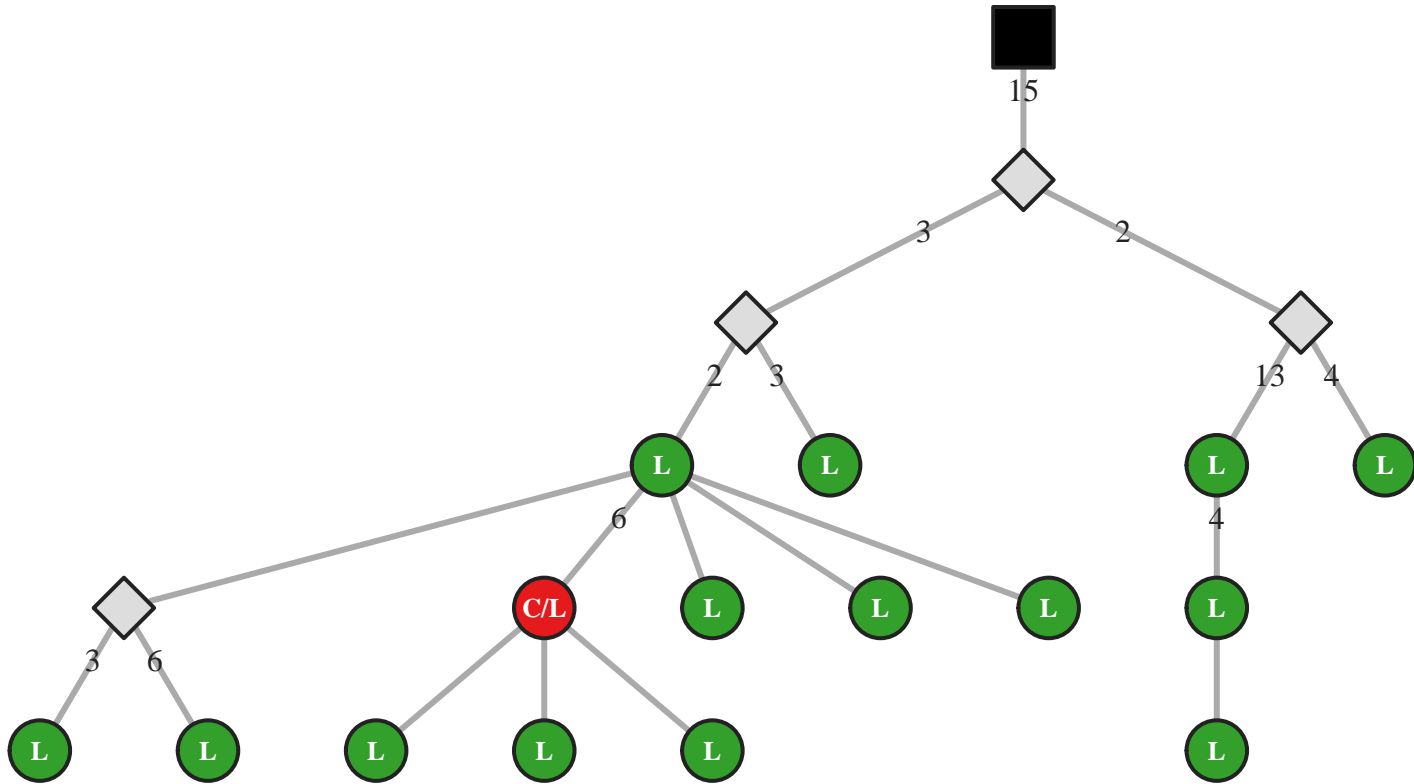

M5 IgG IGHV5-51/J6 66bp (20066)

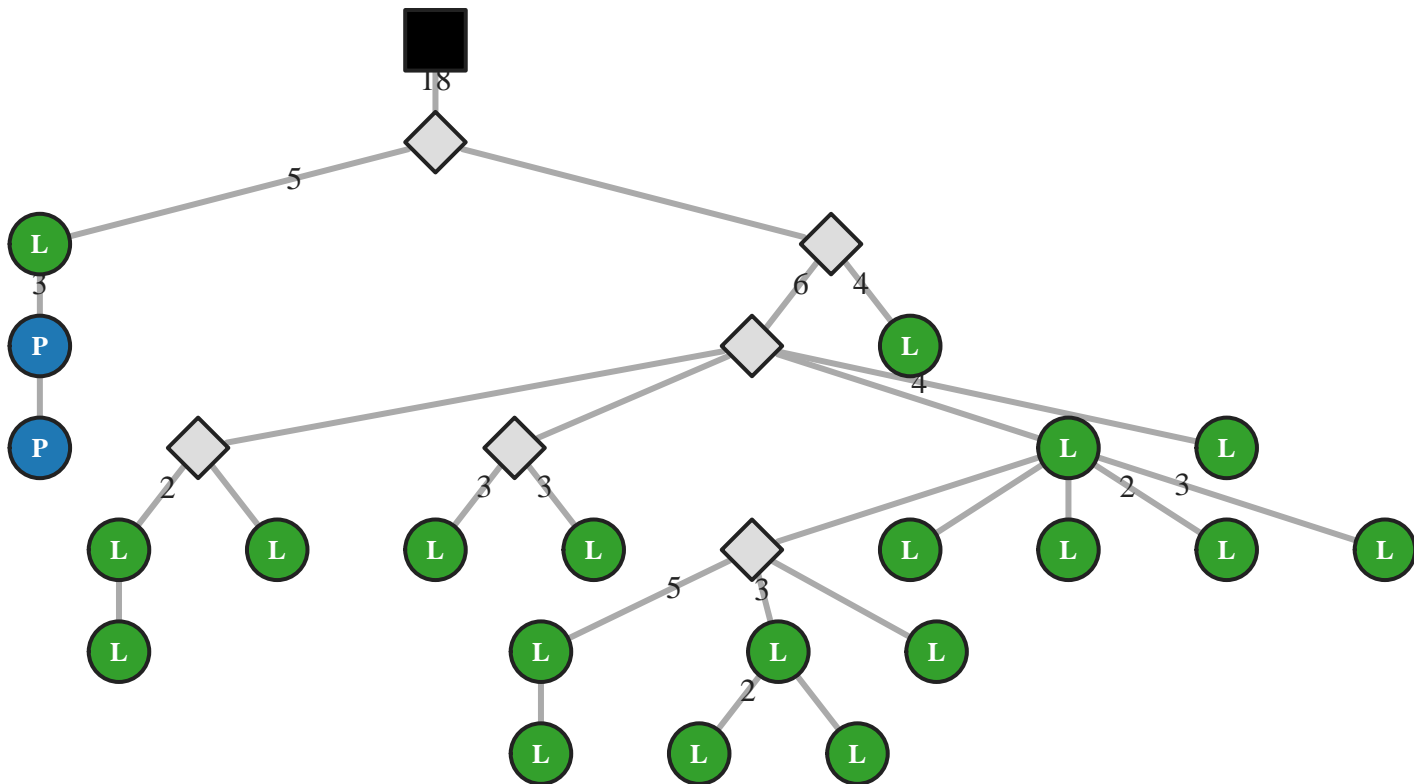

M5 IgG IGHV6-1/J4 39bp (28842)

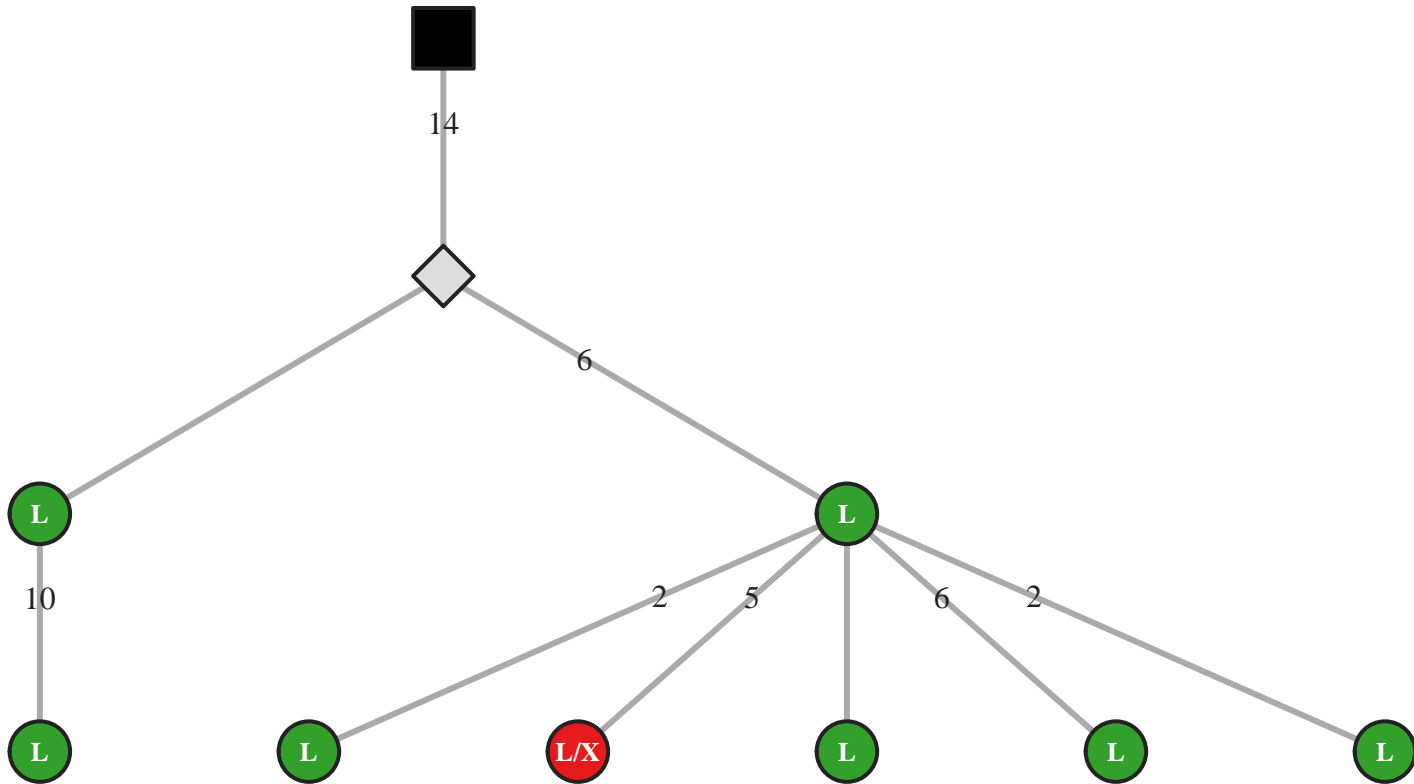

M5 IgG IGHV6-1/J4 48bp (47341)

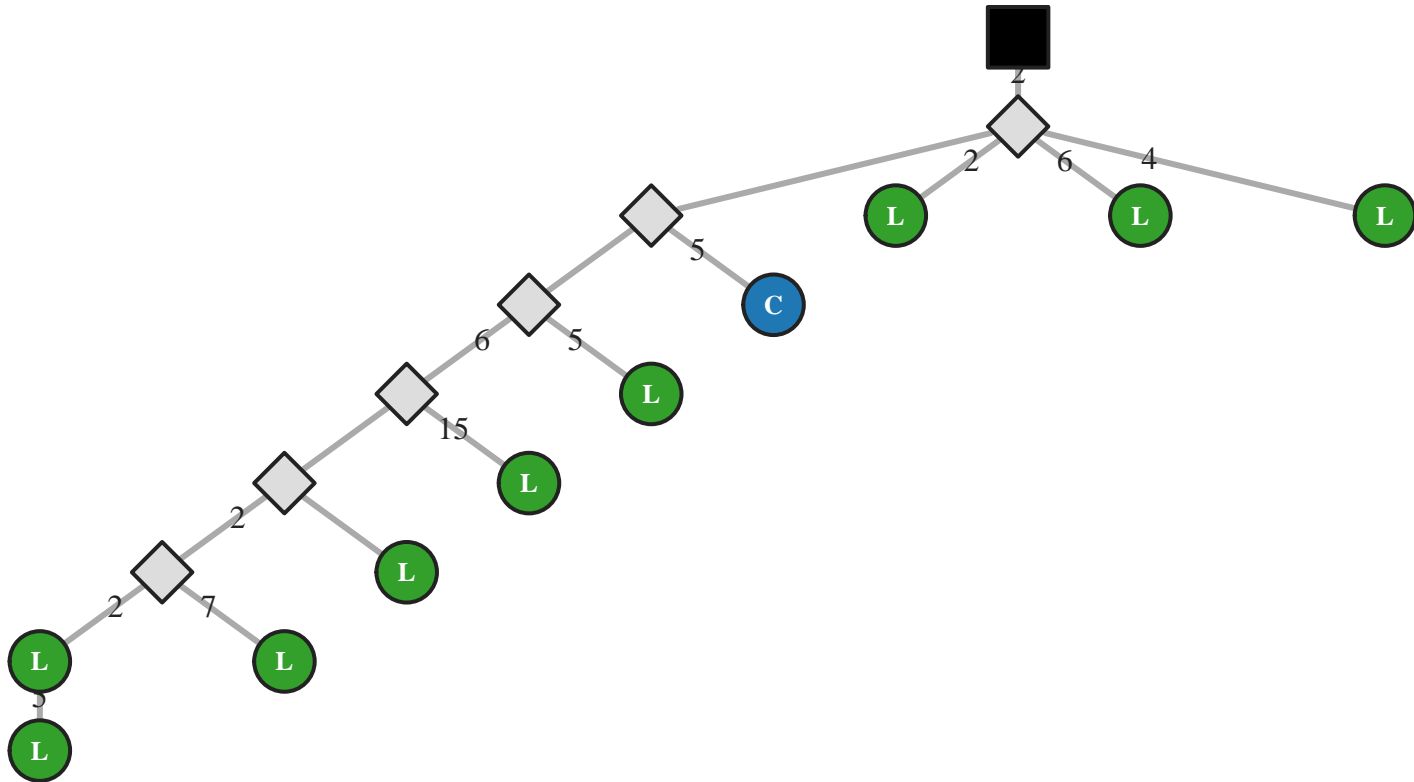

M5 IgG IGHV6-1/J6 54bp (47353)

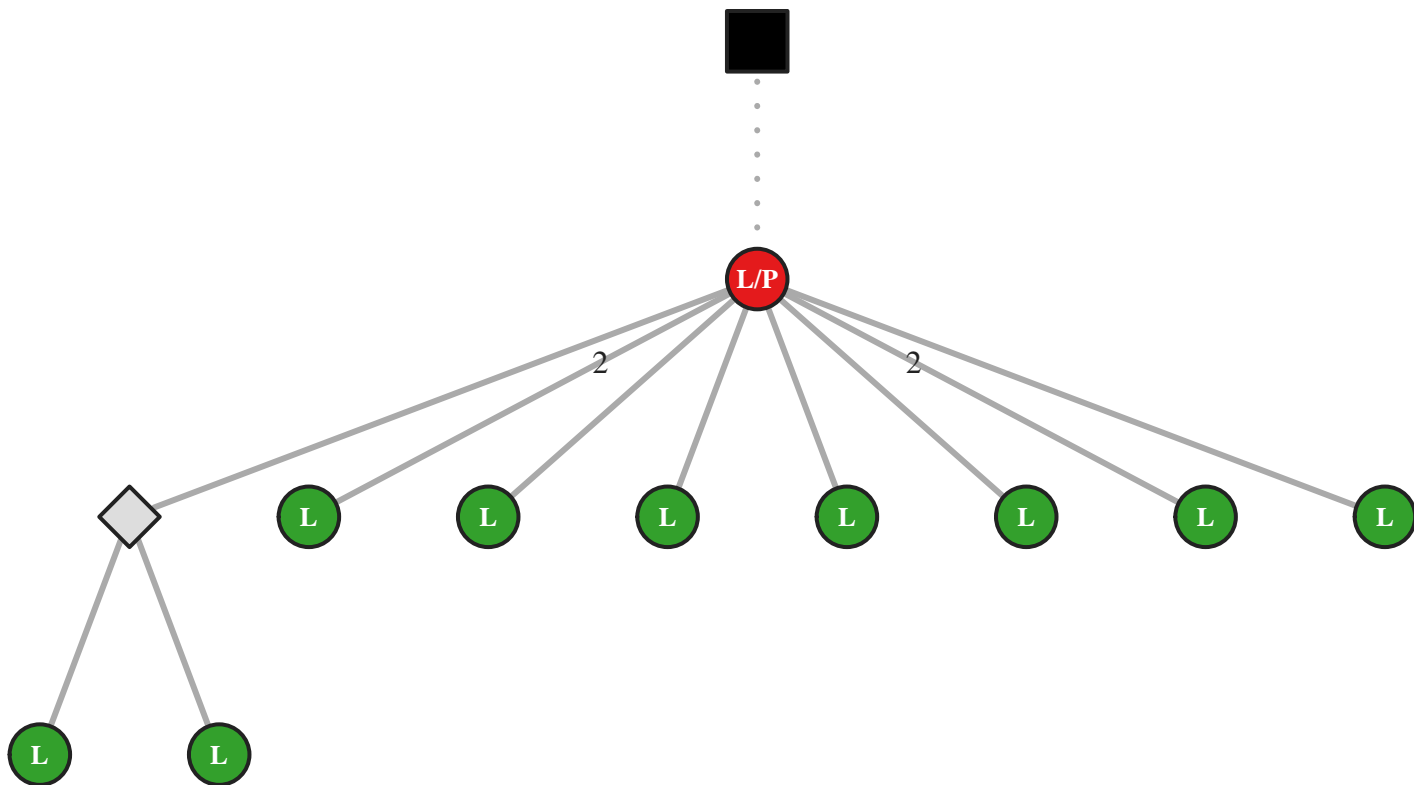

M5 IgG IGHV7-4-1/J1 39bp (47354)

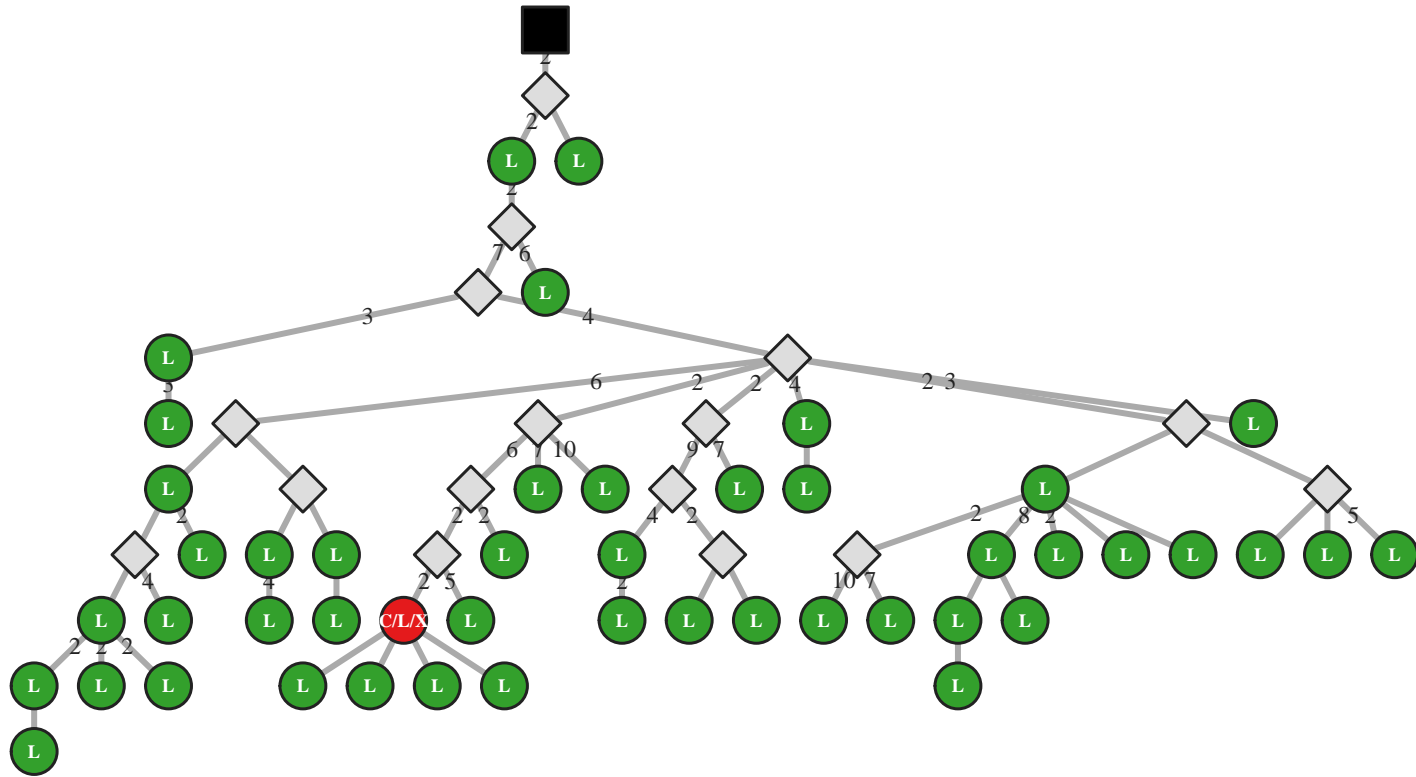

M5 IgG IGHV7-4-1/J1 48bp (10639)

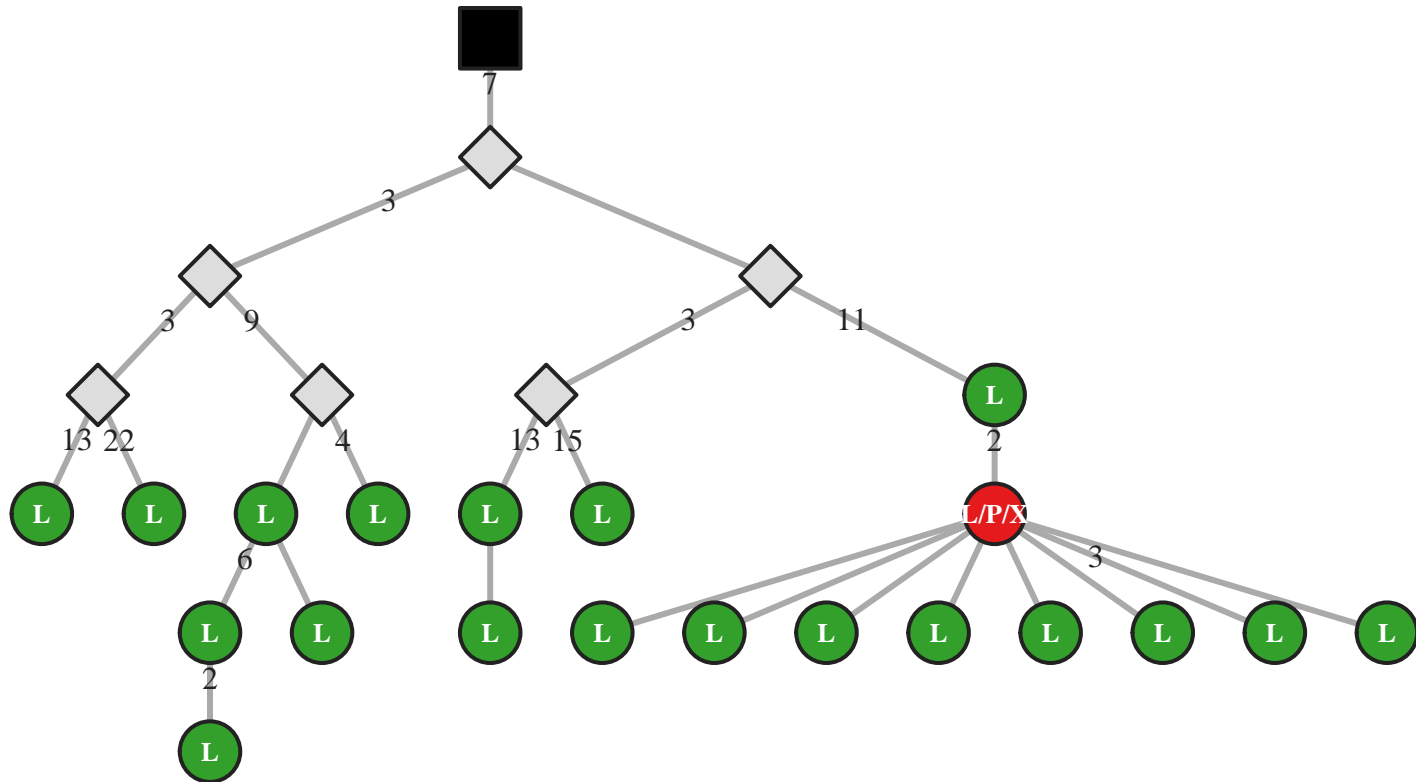

M5 IgG IGHV7-4-1/J2 45bp (36947)

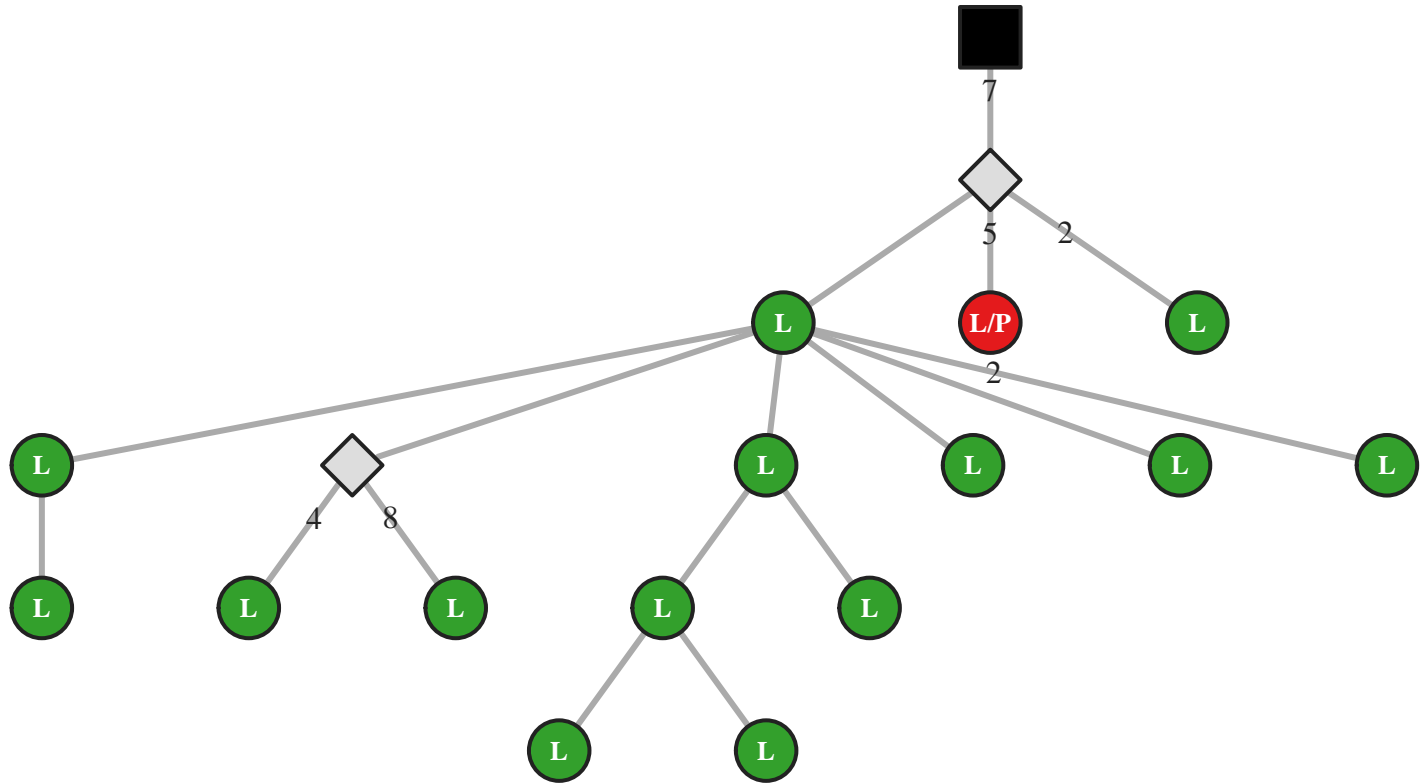

M5 IgG IGHV7-4-1/J3 45bp (36952)

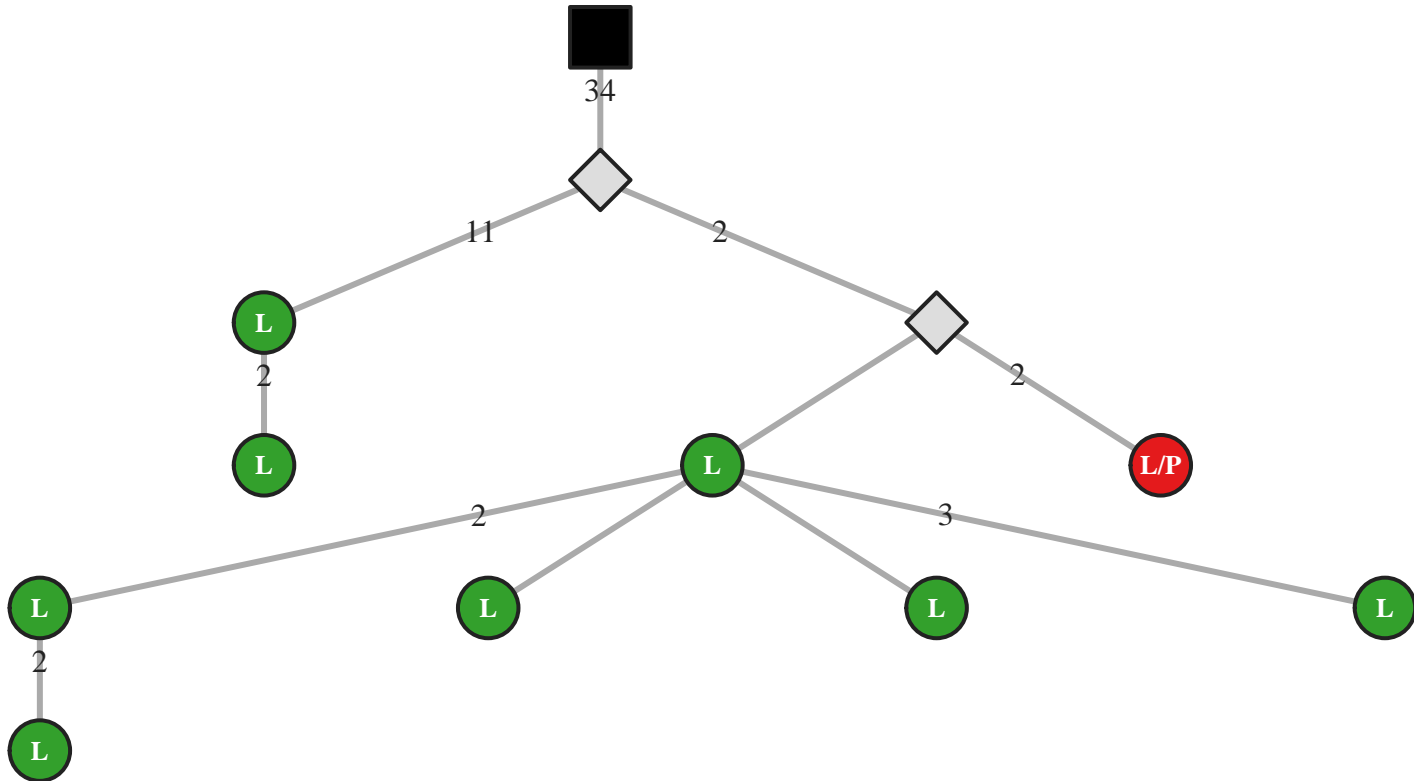

M5 IgG IGHV7-4-1/J3 48bp (47397)

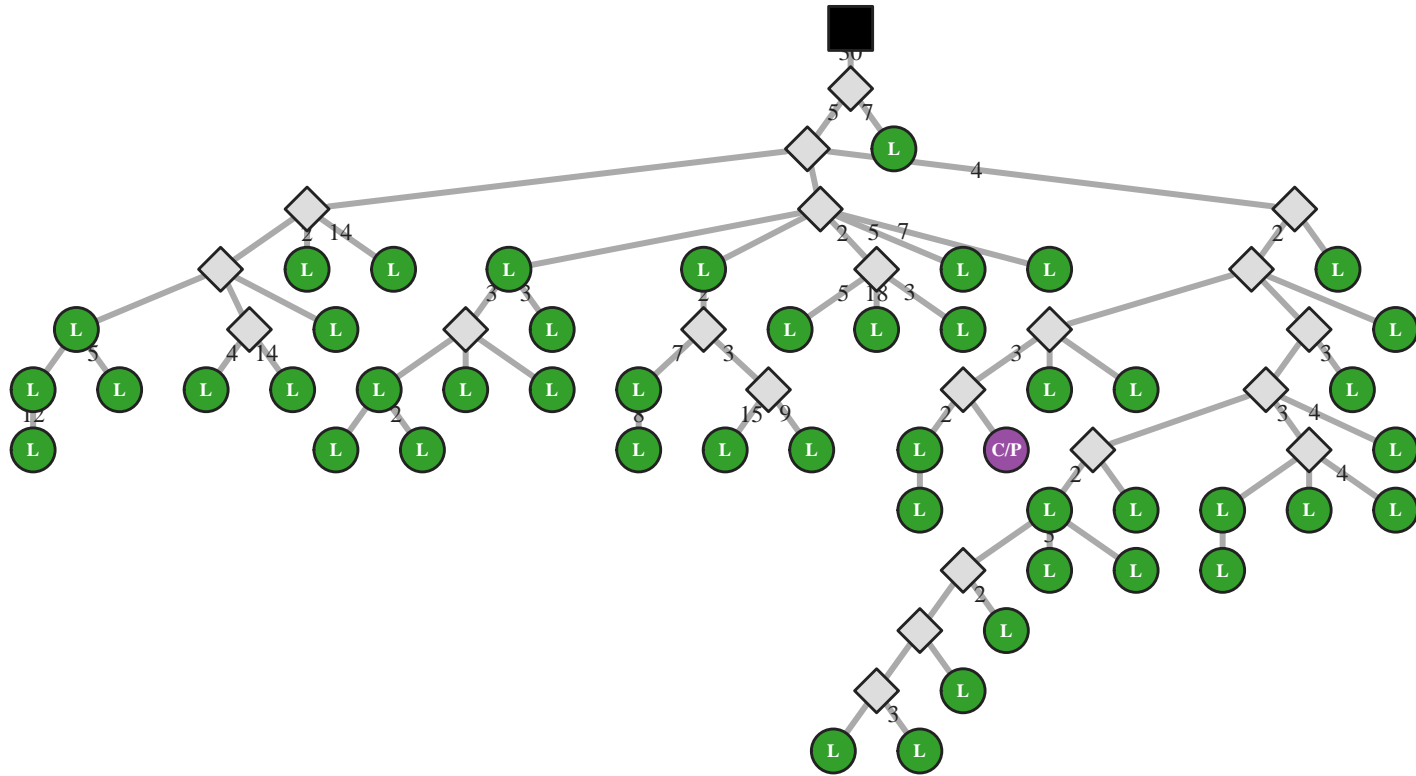

M5 IgG IGHV7-4-1/J3 57bp (20151)

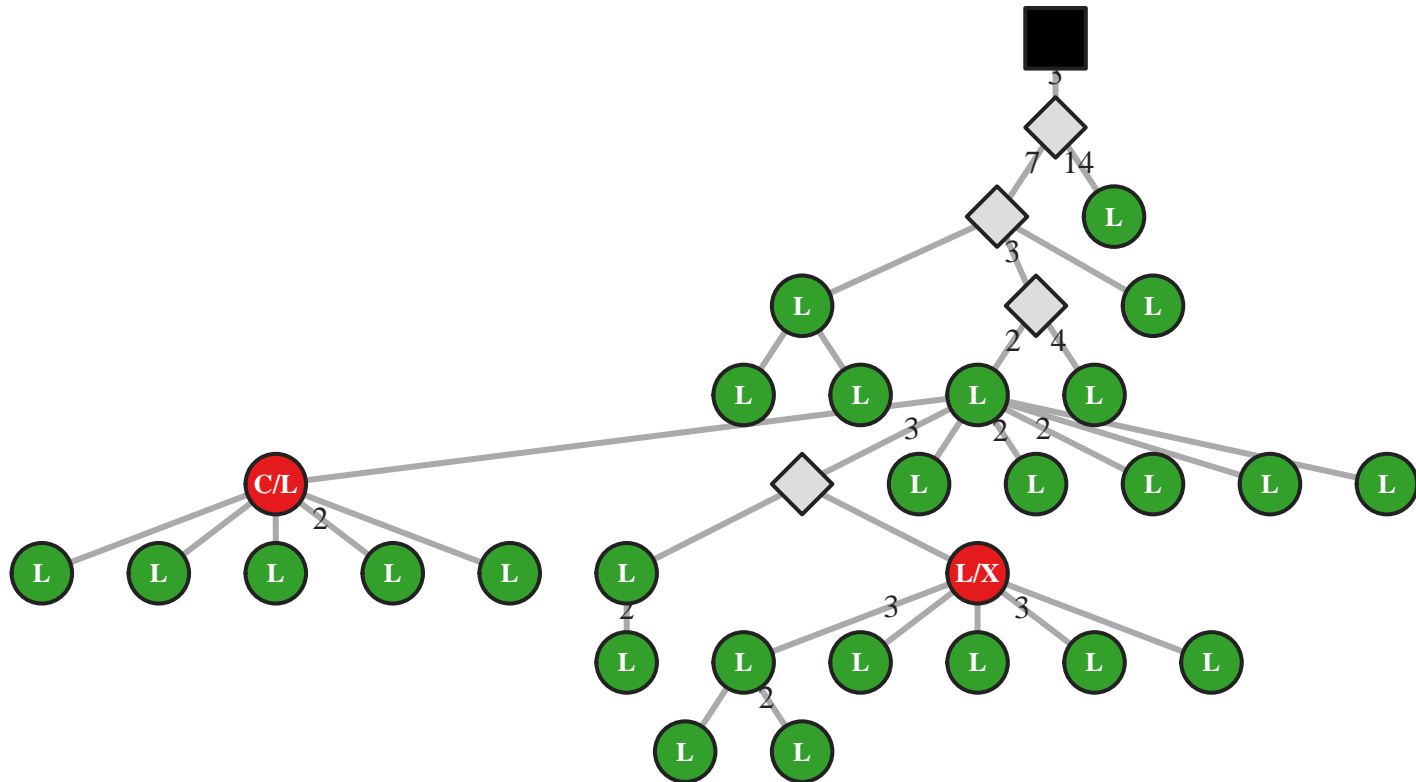

M5 IgG IGHV7-4-1/J3 63bp (36960)

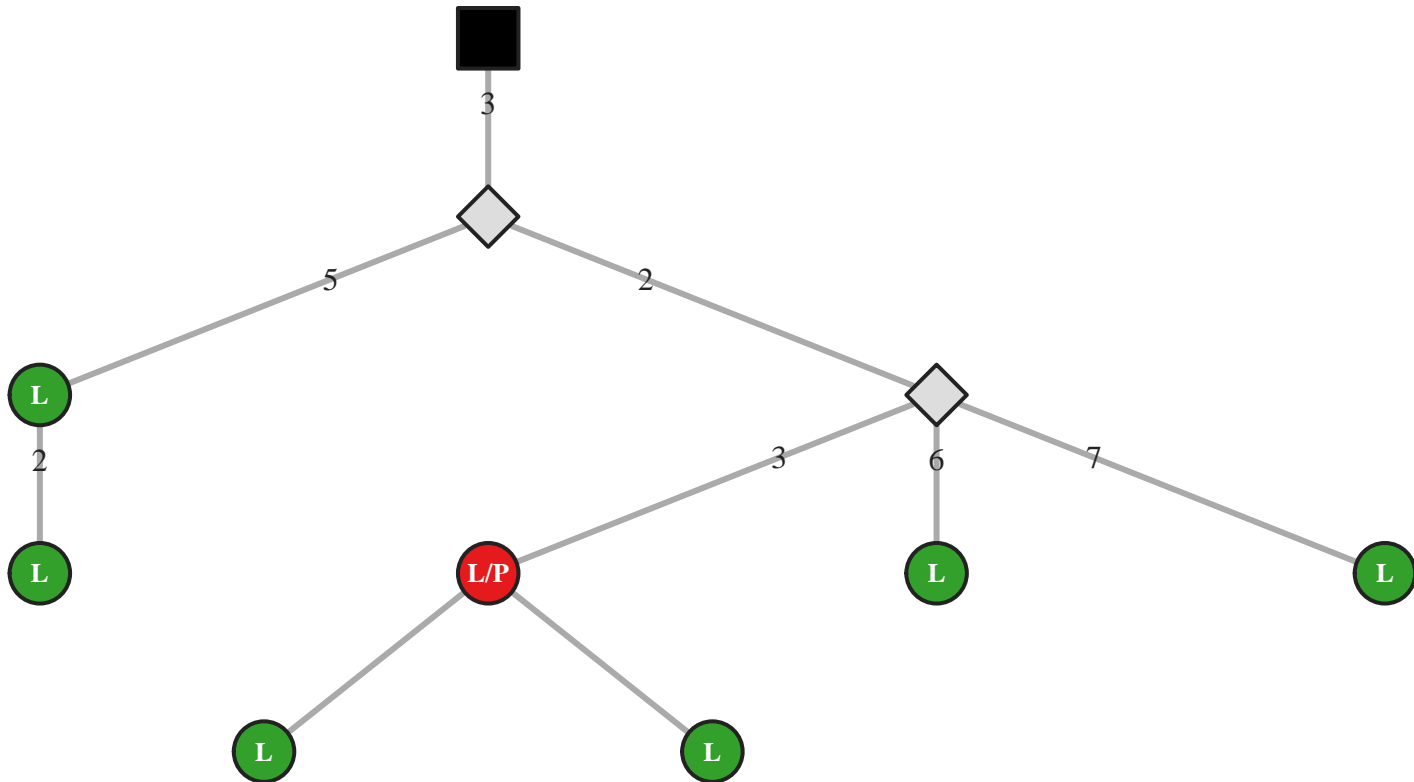

M5 IgG IGHV7-4-1/J4 30bp (20178)

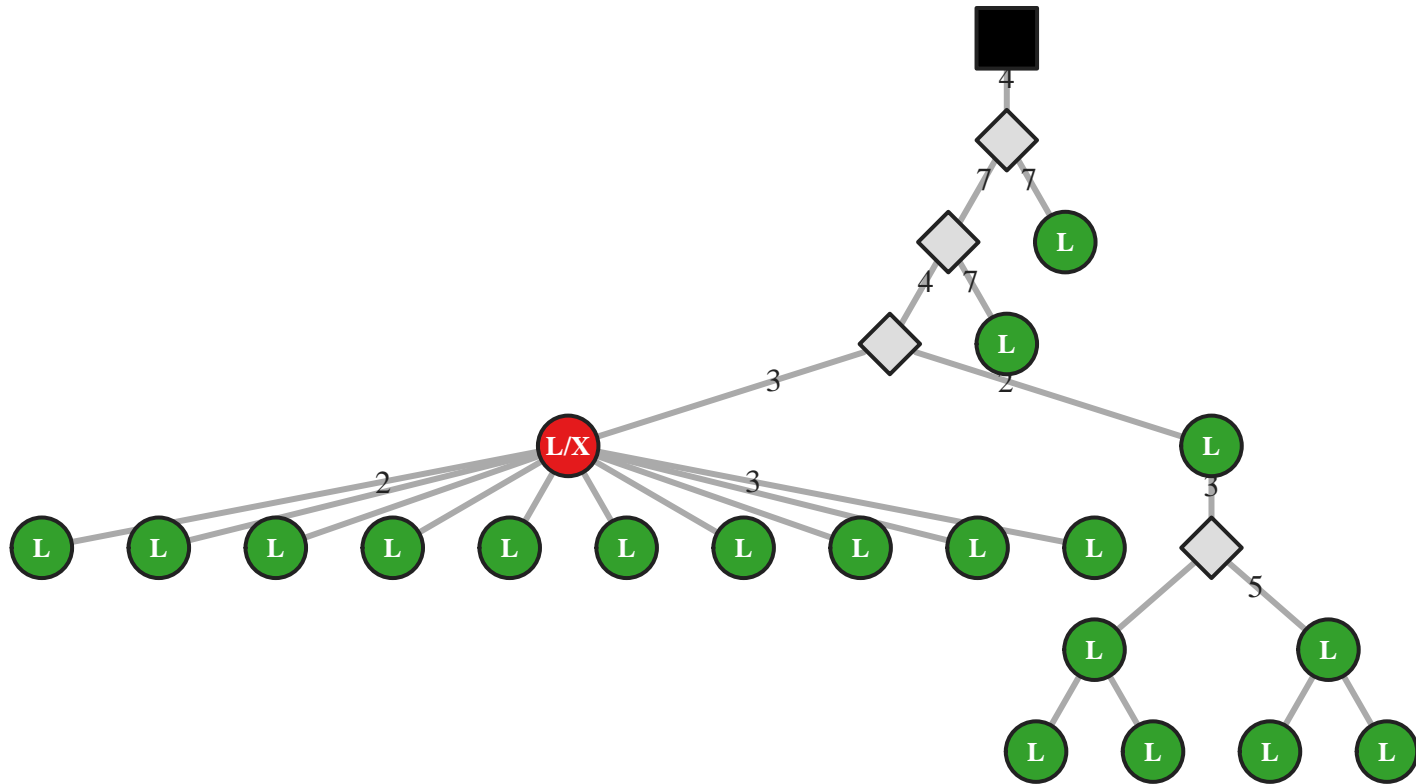

M5 IgA IGHV7-4-1/J4 39bp (3249)

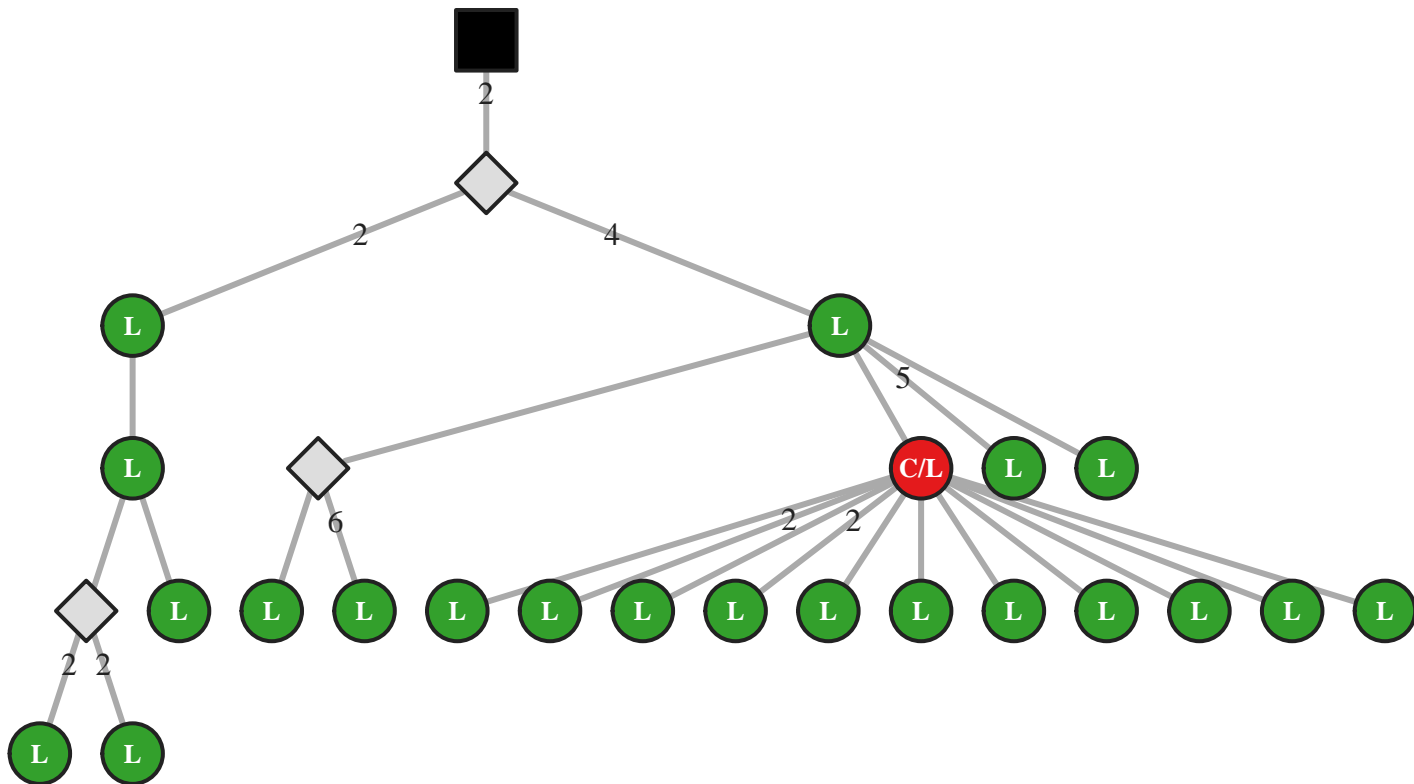

M5 IgA IGHV7-4-1/J4 39bp (3250)

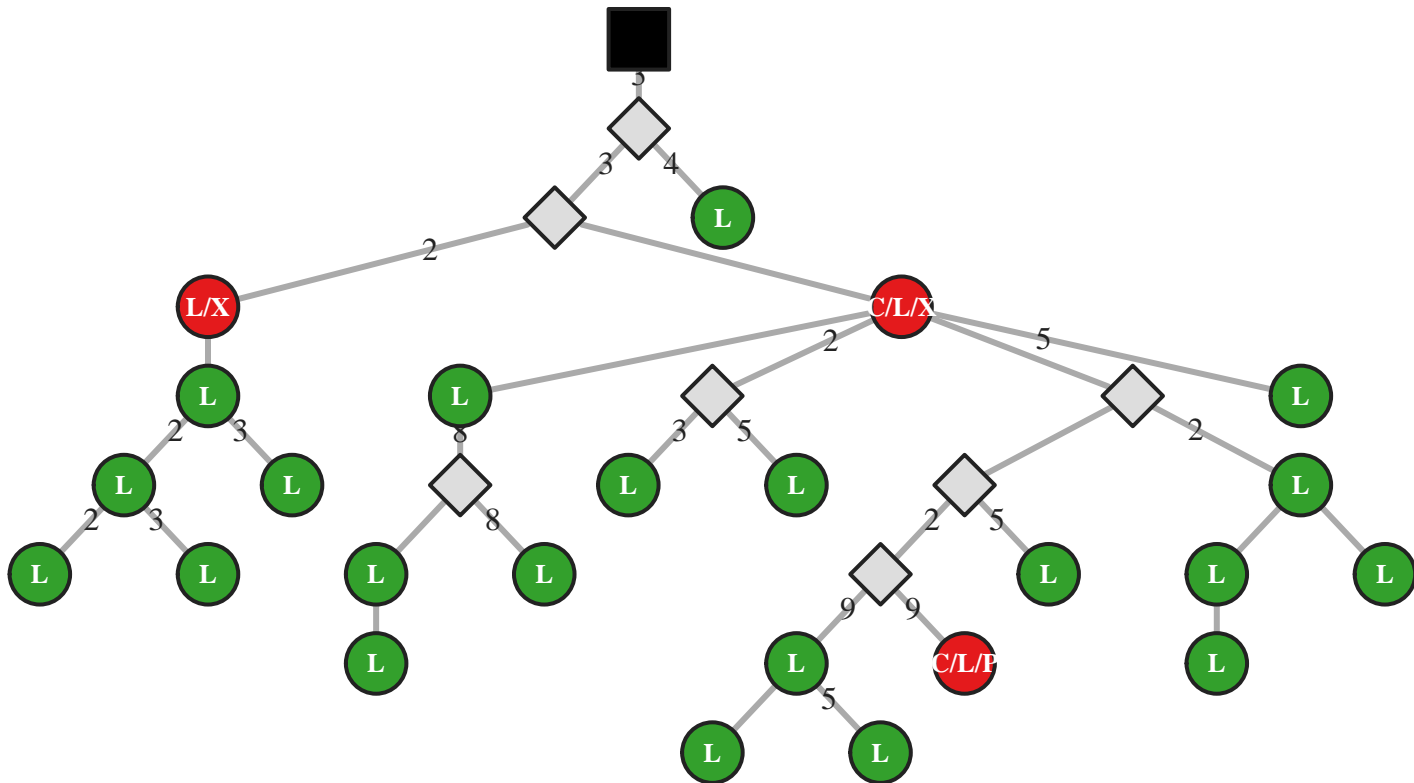

M5 IgG IGHV7-4-1/J4 39bp (47427)

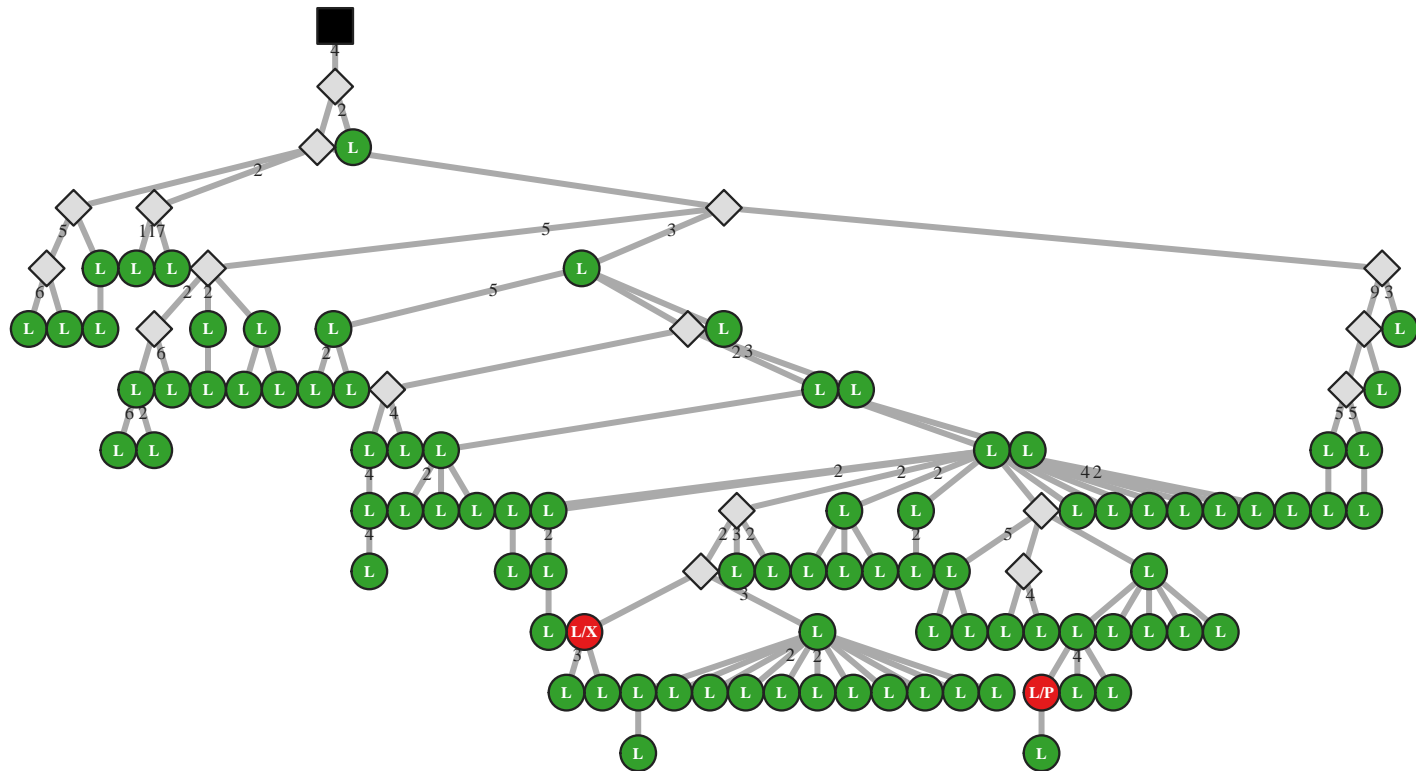

M5 IgA IGHV7-4-1/J4 42bp (3268)

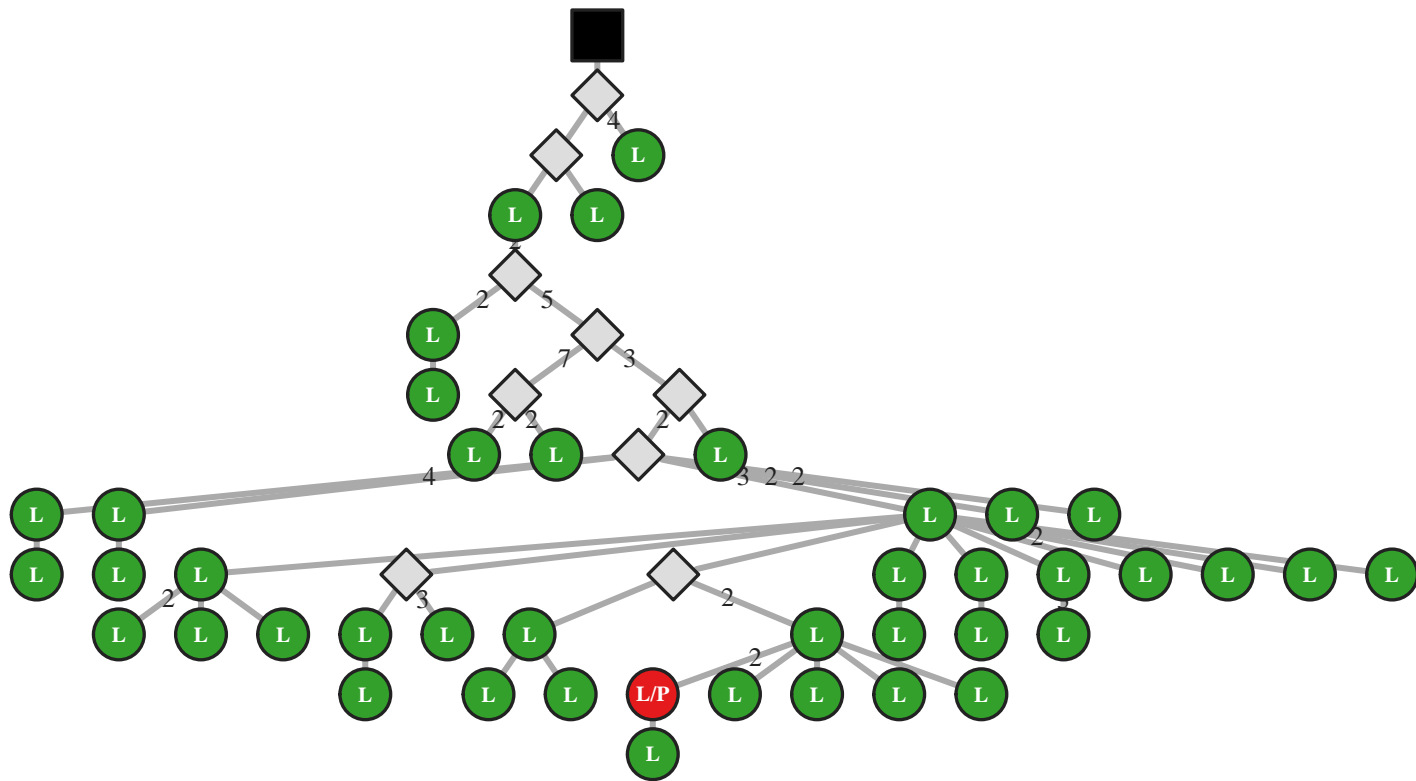

M5 IgG IGHV7-4-1/J4 42bp (37015)

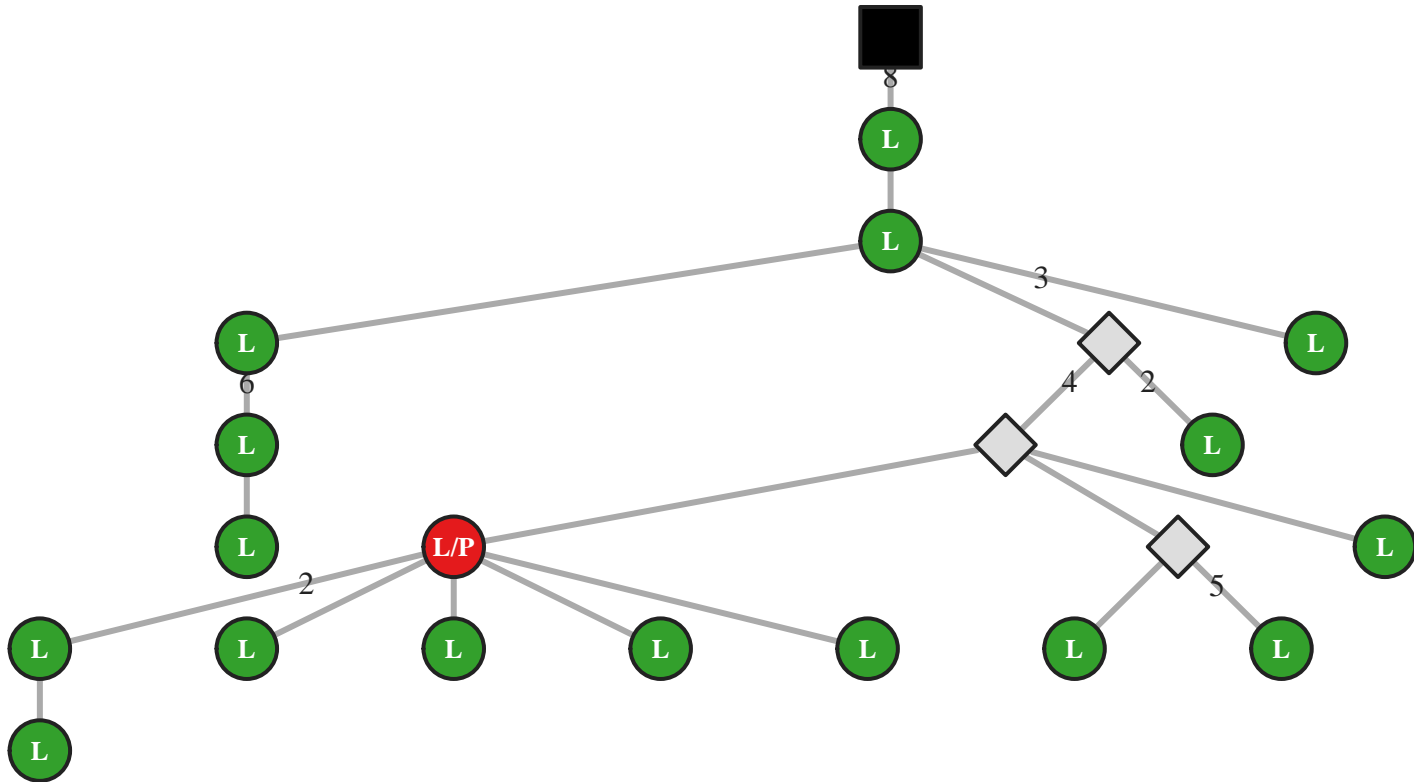

M5 IgG IGHV7-4-1/J4 42bp (37039)

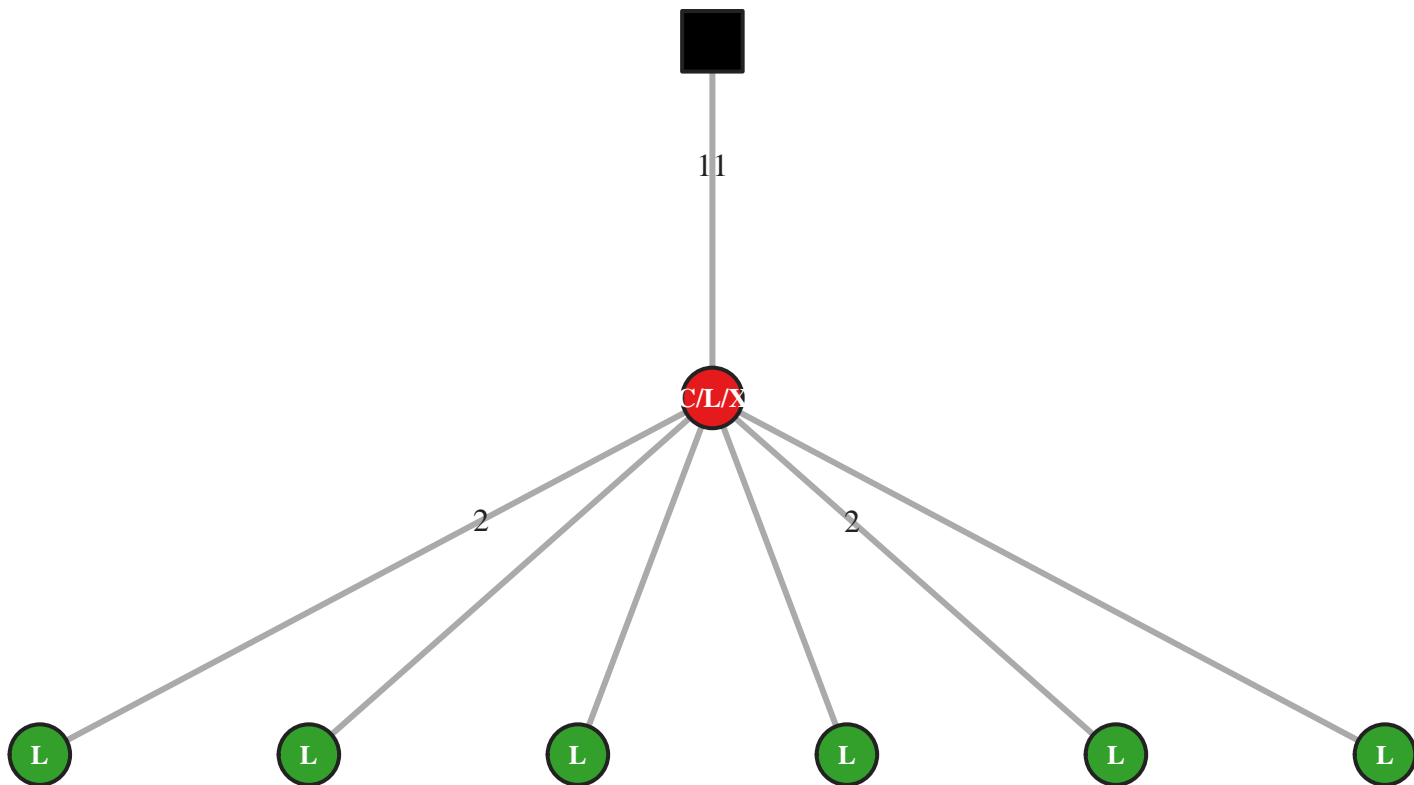

M5 IgM IGHV7-4-1/J4 42bp (11742)

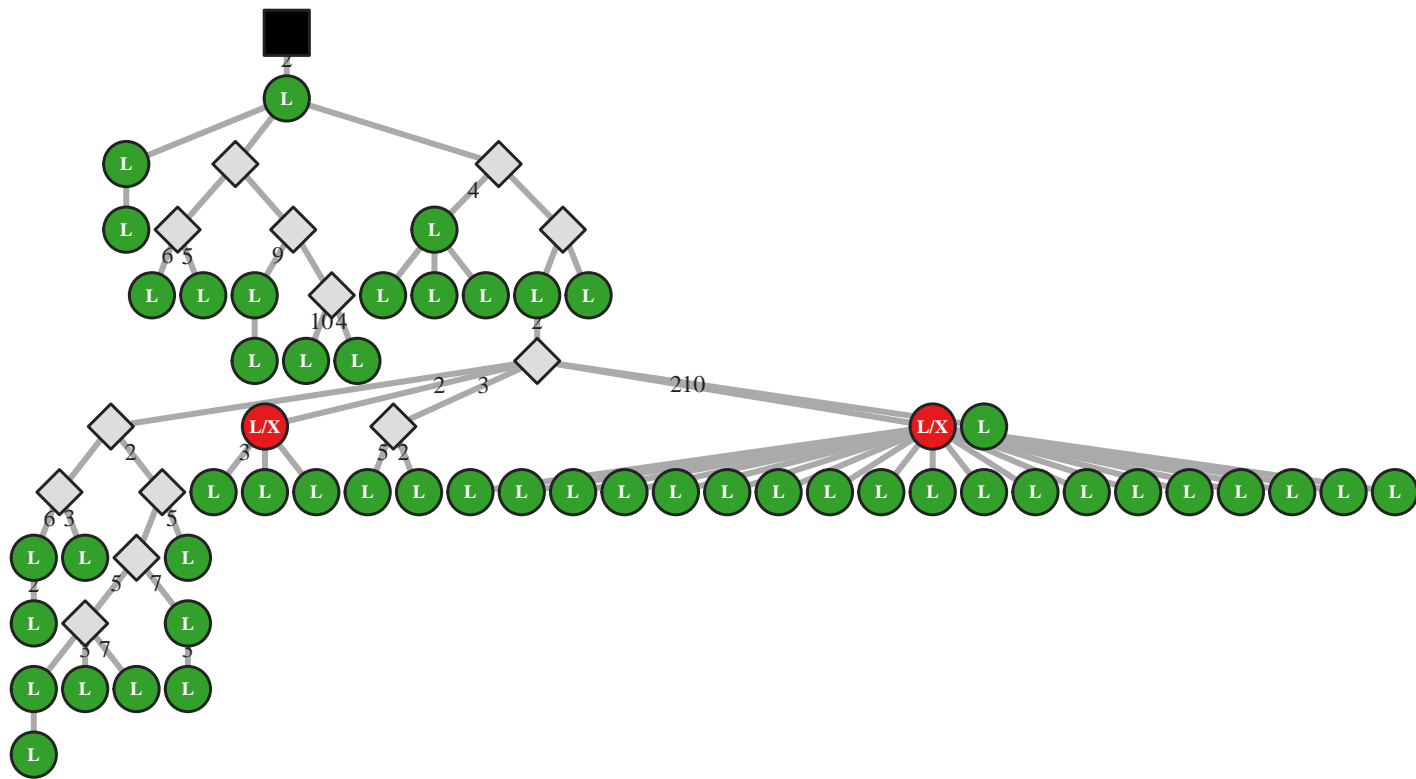

M5 IgG IGHV7-4-1/J4 45bp (10679)

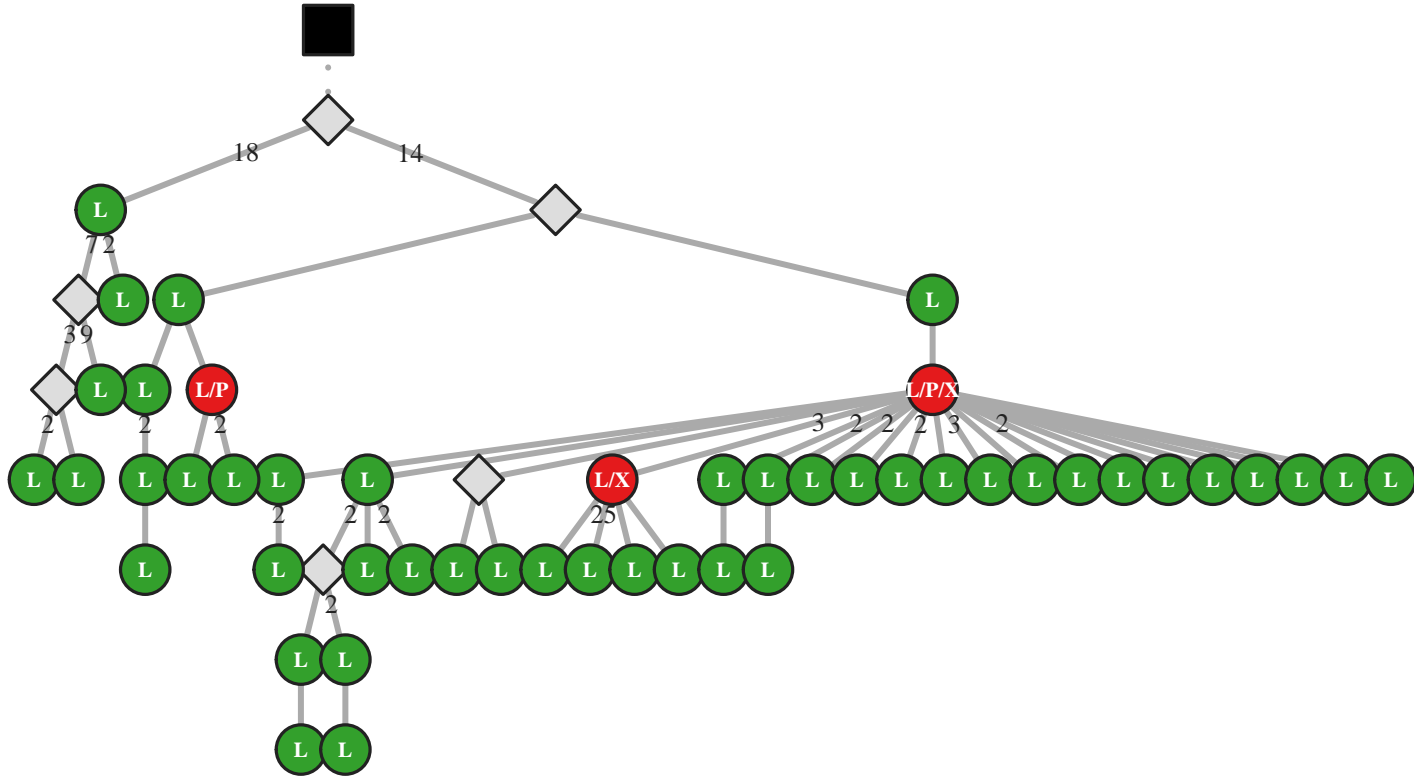

M5 IgG IGHV7-4-1/J4 45bp (10689)

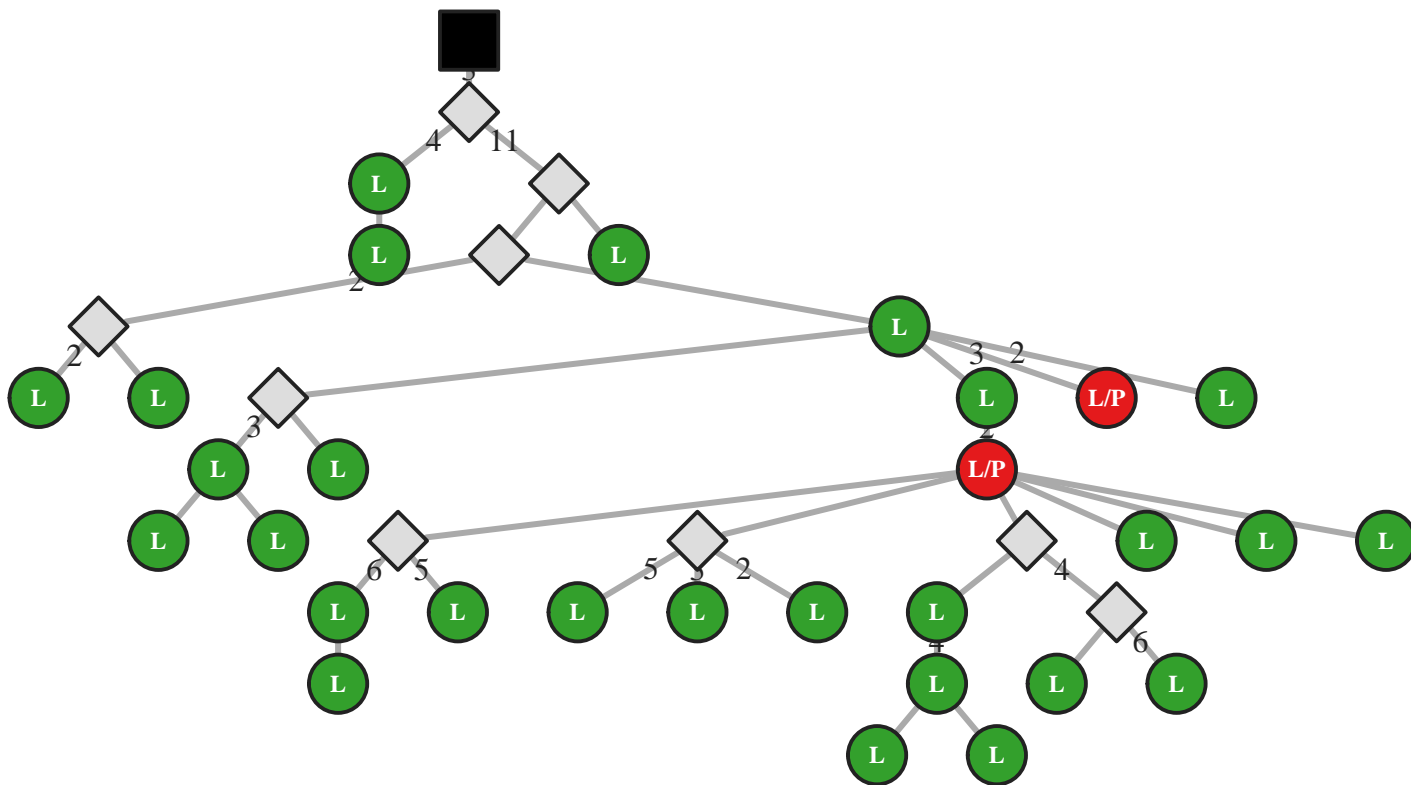

M5 IgG IGHV7-4-1/J4 45bp (10694)

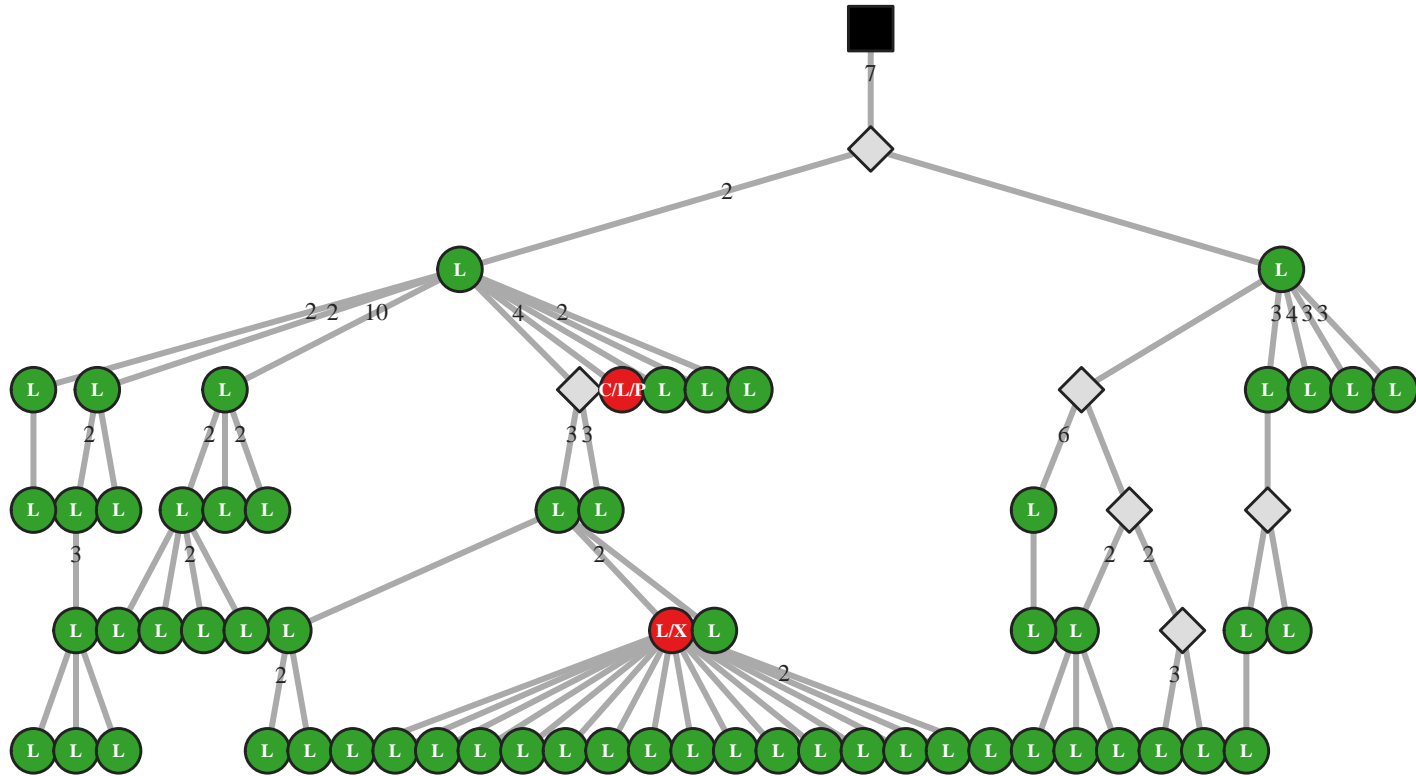

M5 IgG IGHV7-4-1/J4 45bp (10708)

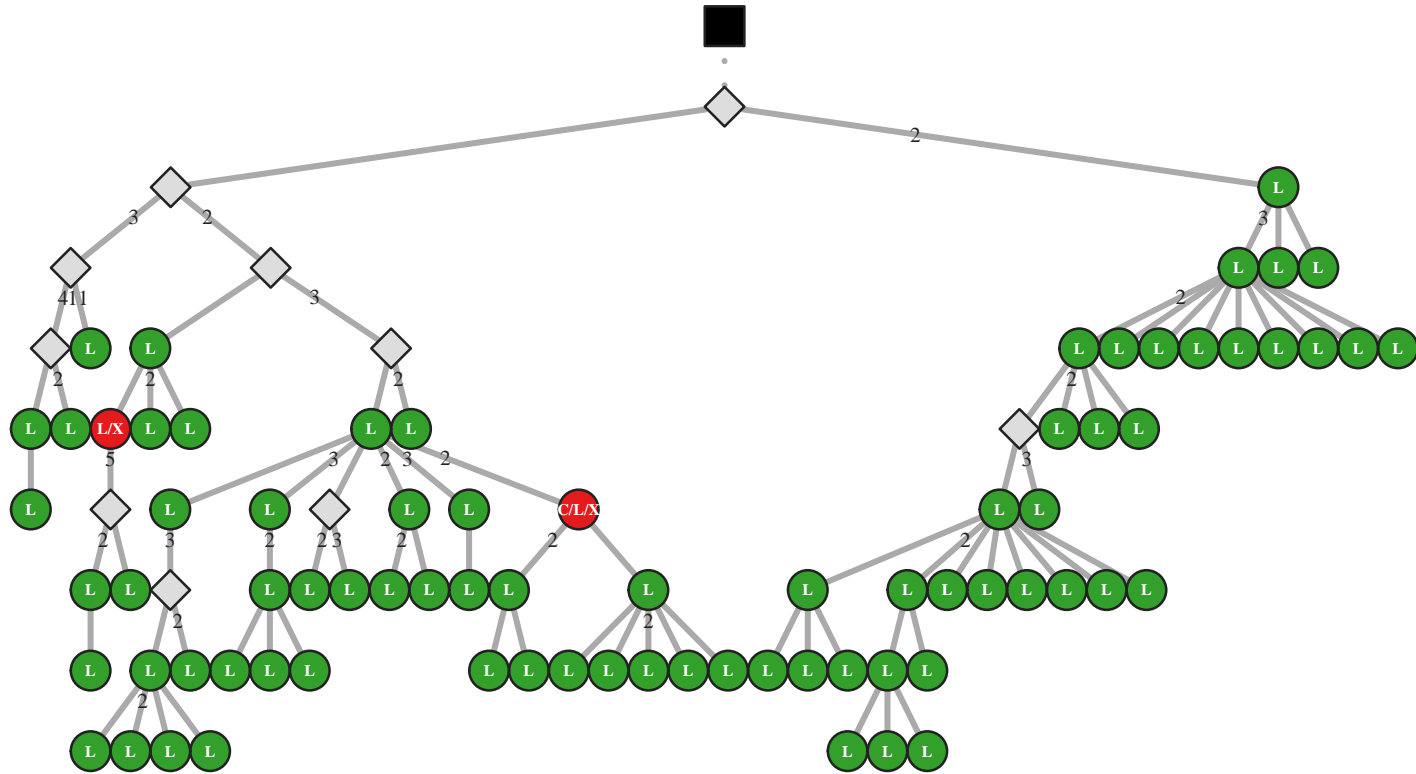

M5 IgG IGHV7-4-1/J4 45bp (10752)

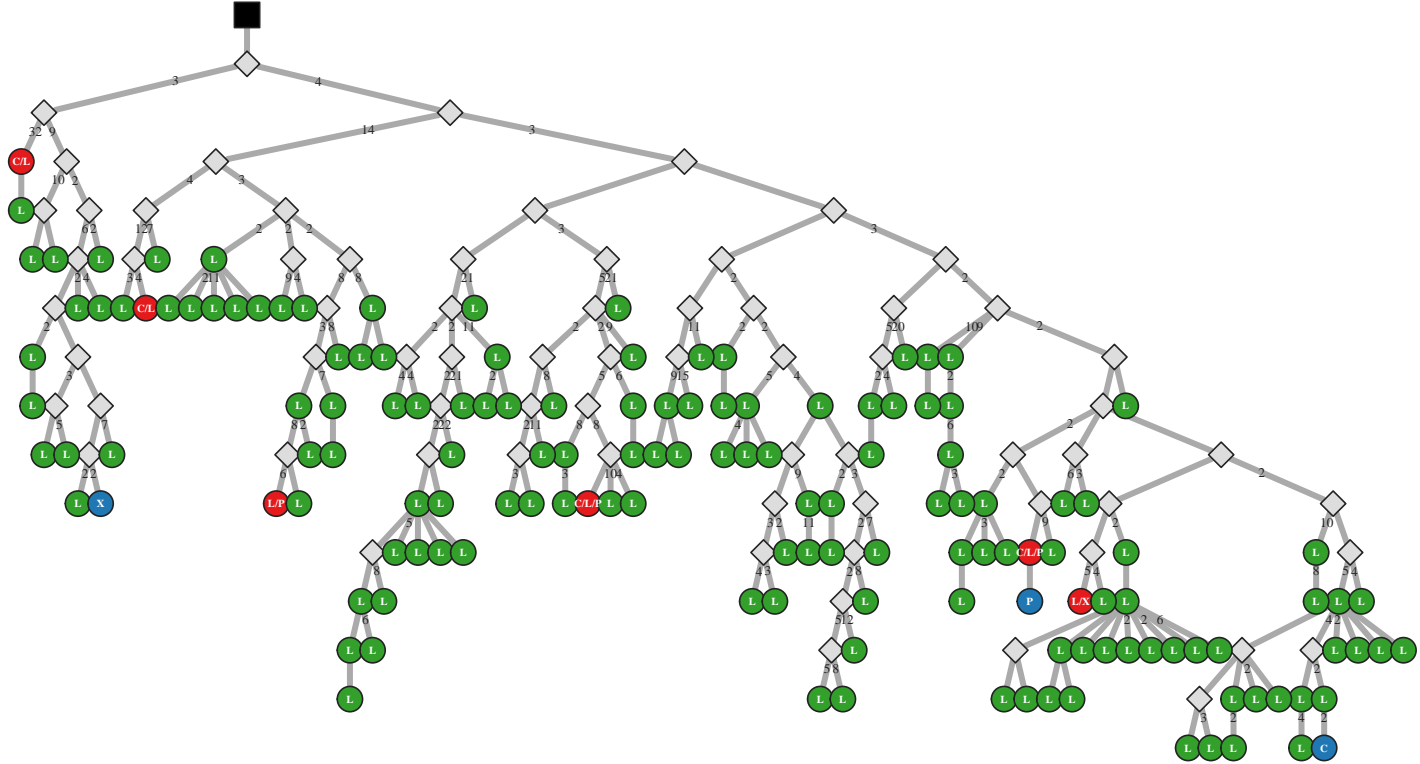

M5 IgG IGHV7-4-1/J4 48bp (28927)

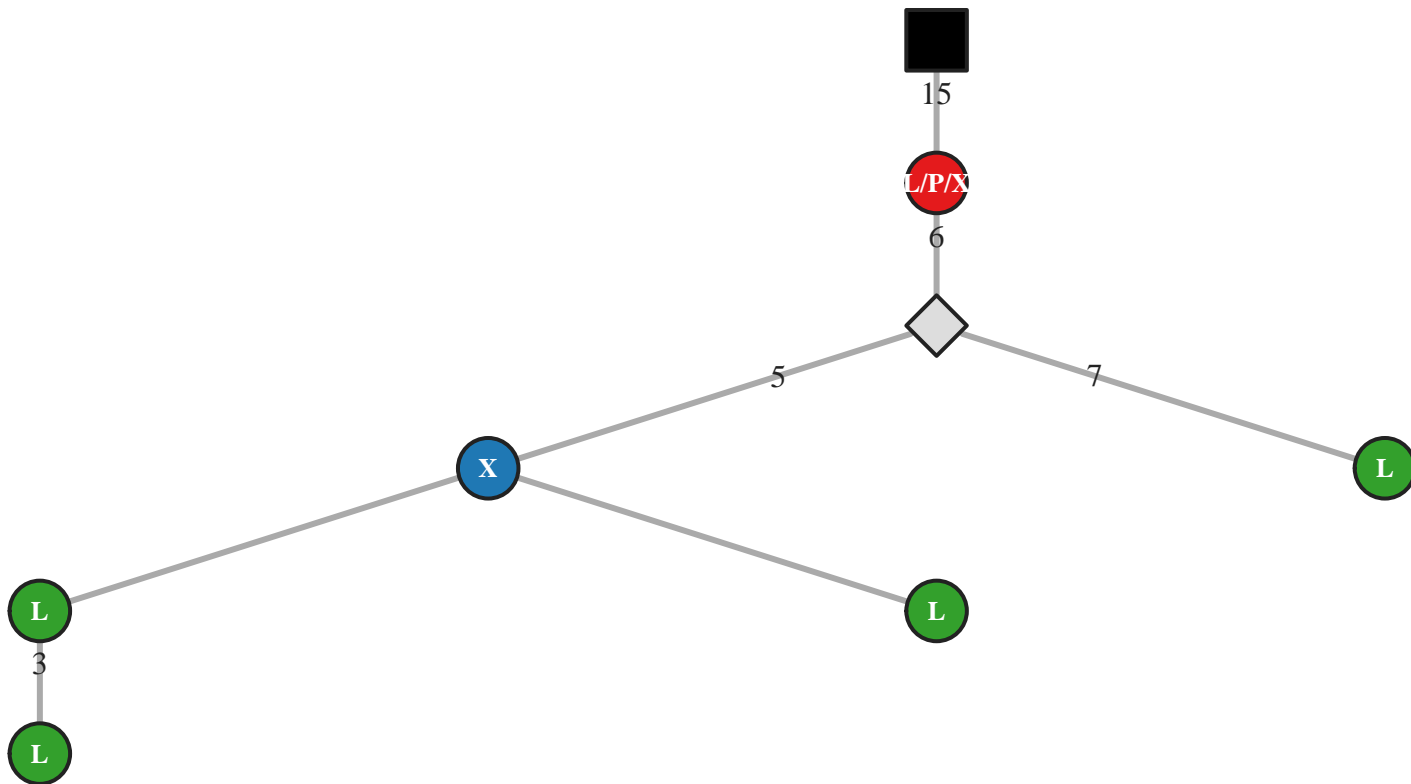

M5 IgG IGHV7-4-1/J4 51bp (37064)

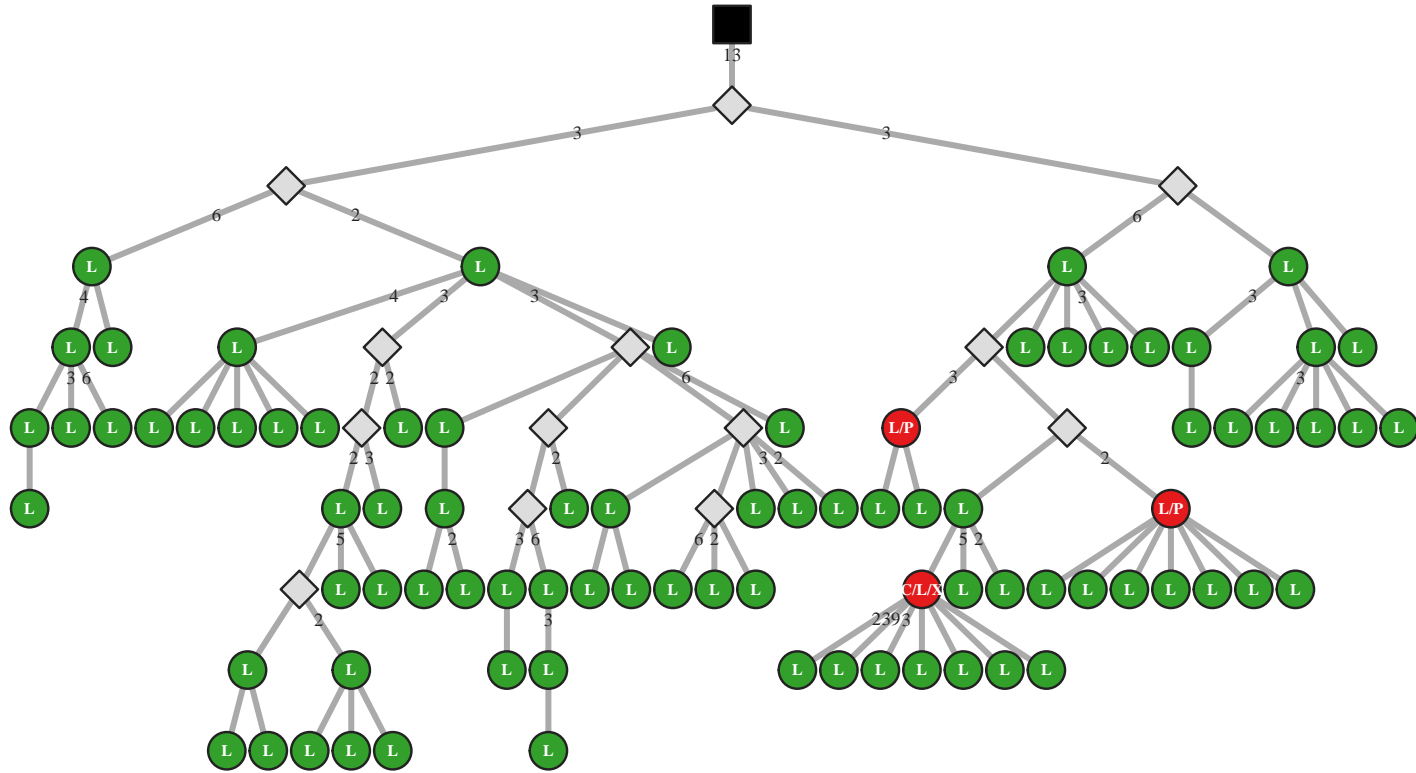

M5 IgG IGHV7-4-1/J4 51bp (37089)

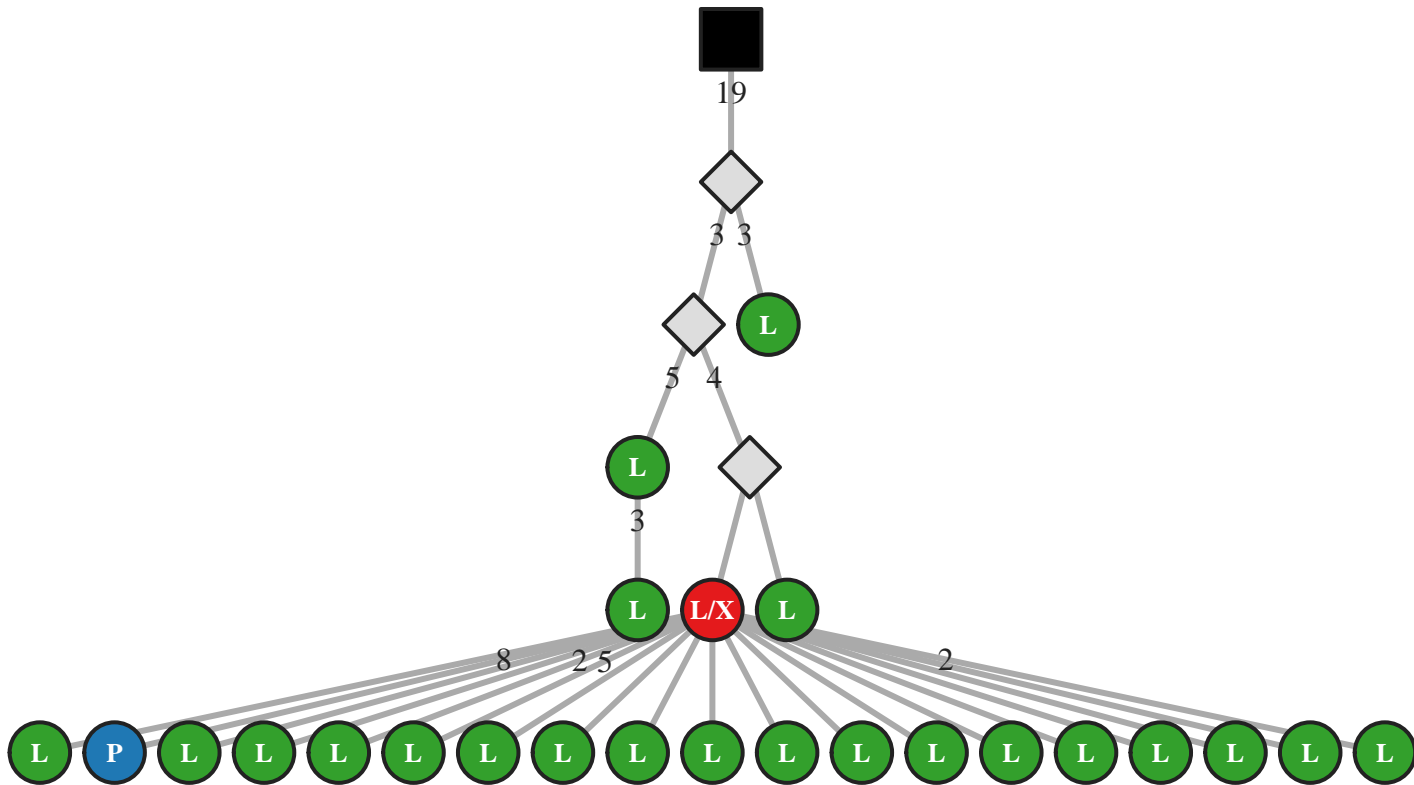

M5 IgG IGHV7-4-1/J4 51bp (37095)

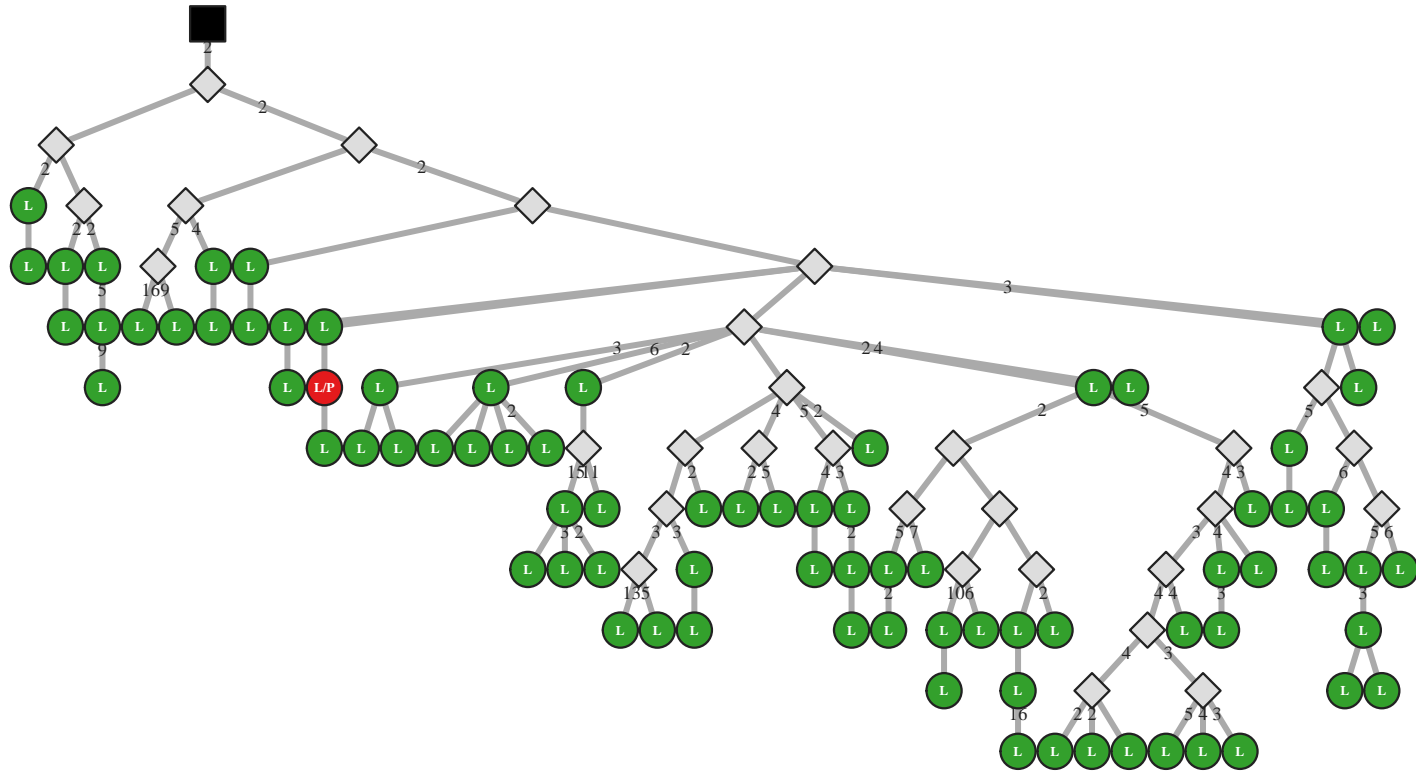

M5 IgG IGHV7-4-1/J4 51bp (37126)

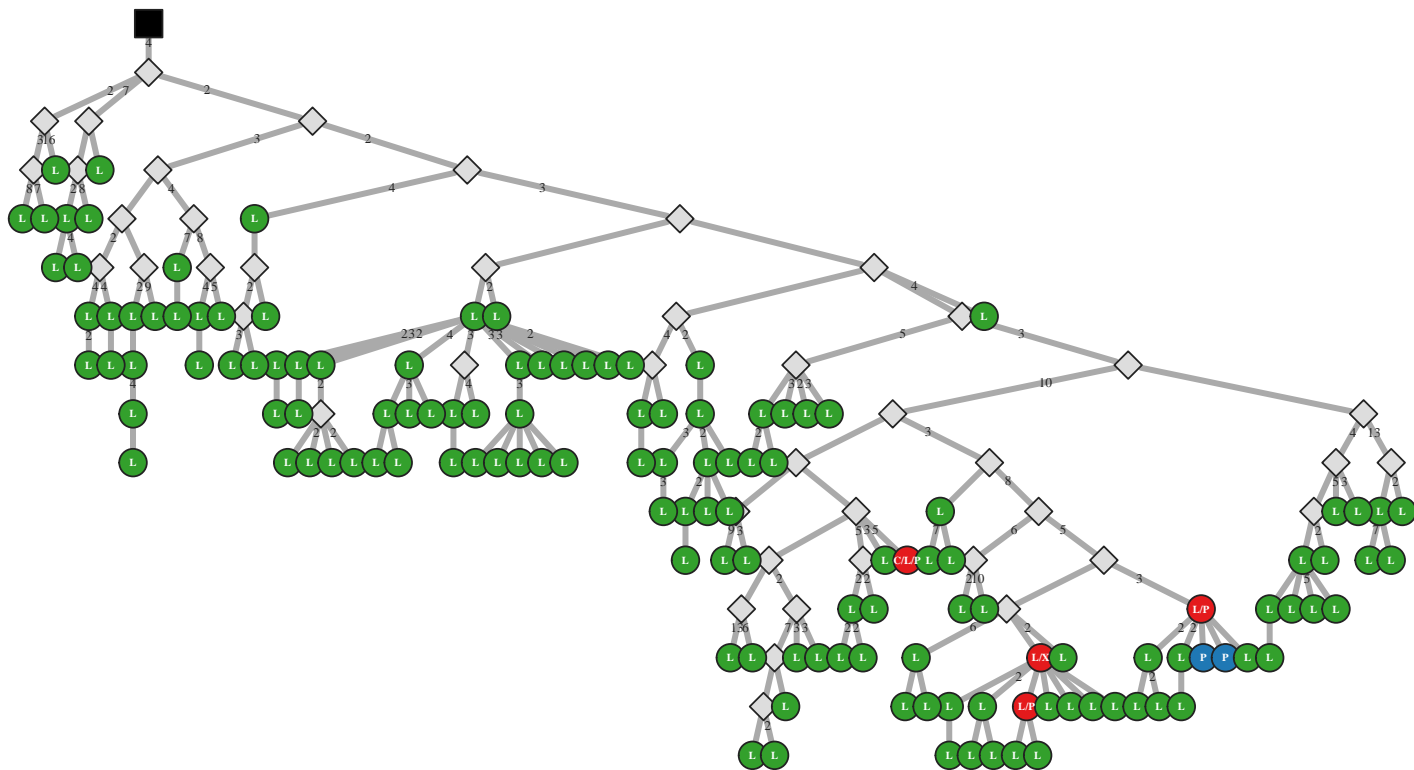

M5 IgG IGHV7-4-1/J4 51bp (37127)

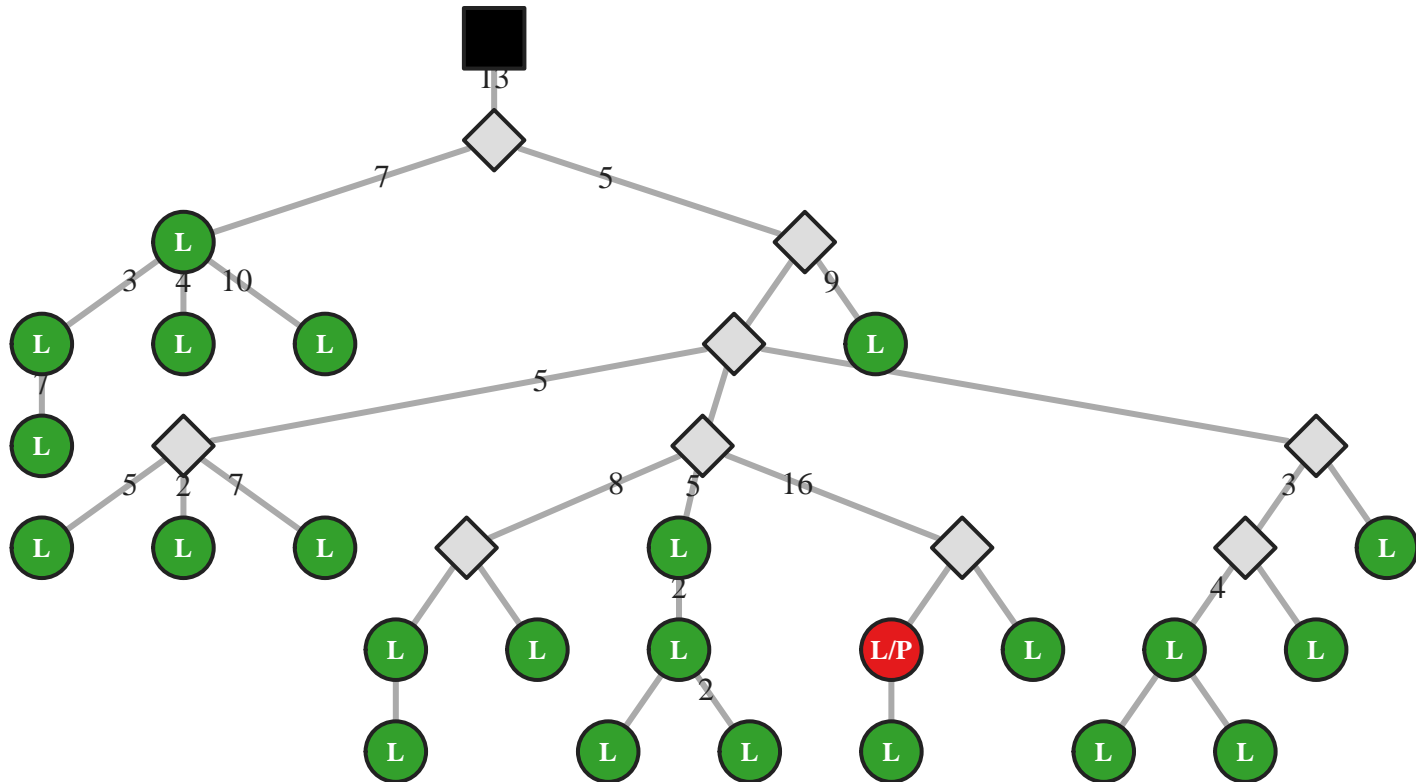

M5 IgG IGHV7-4-1/J4 54bp (37145)

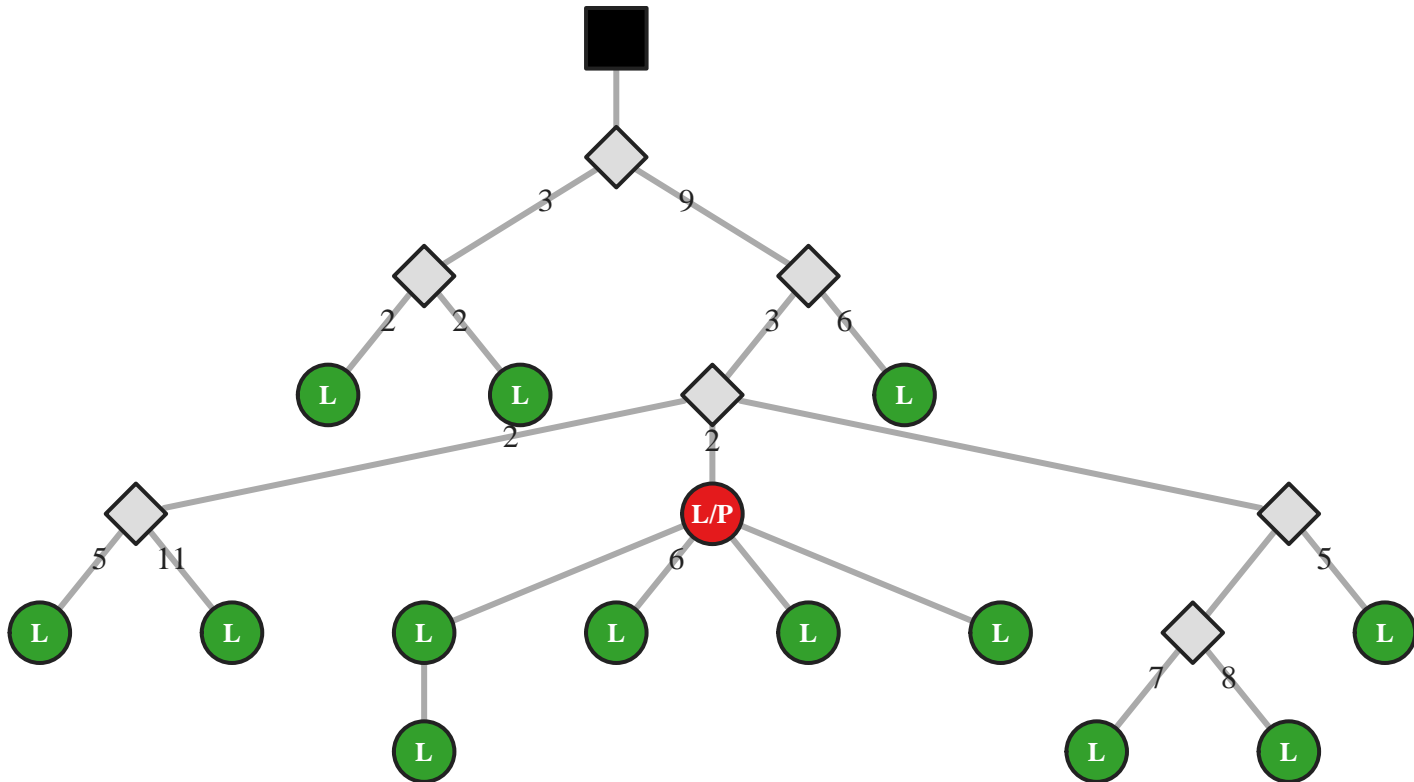

M5 IgG IGHV7-4-1/J4 54bp (37164)

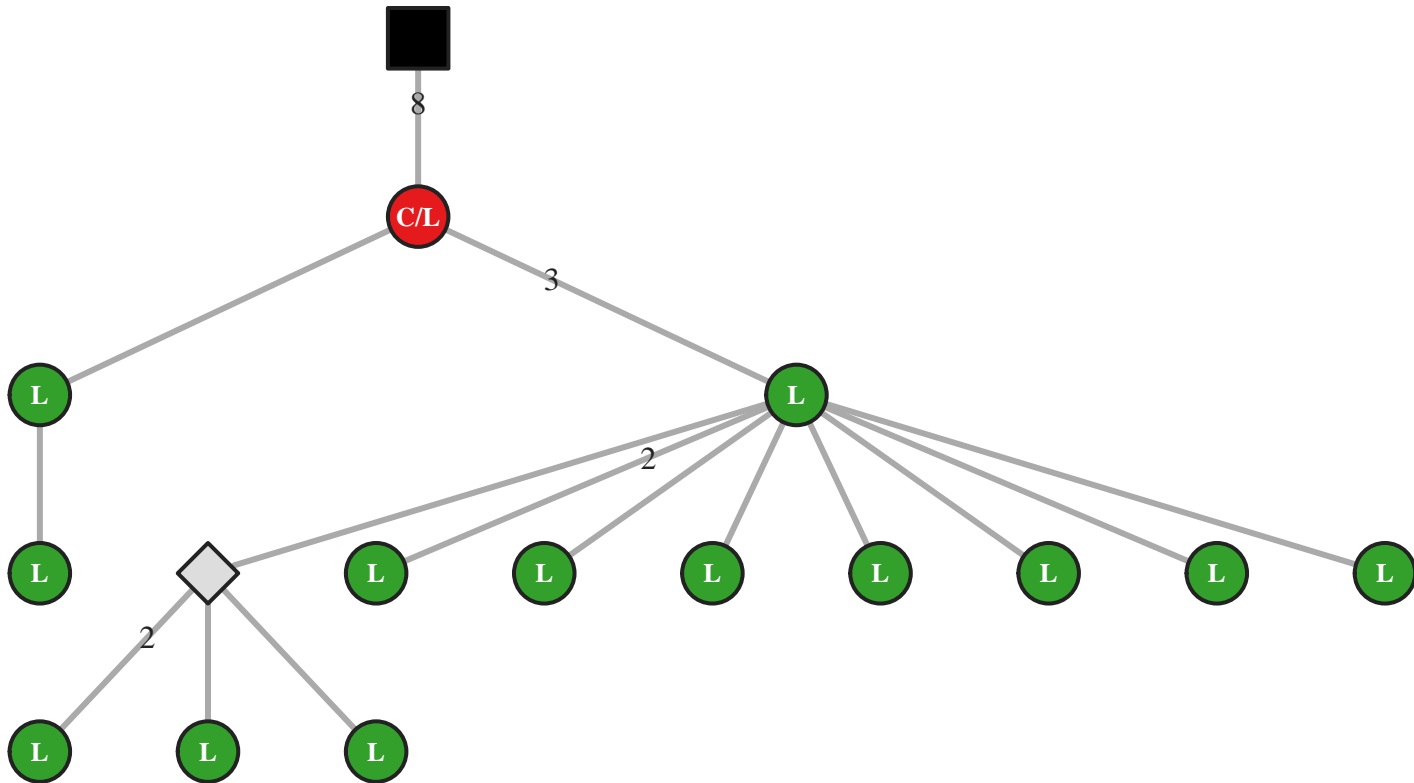

M5 IgG IGHV7-4-1/J4 57bp (28995)

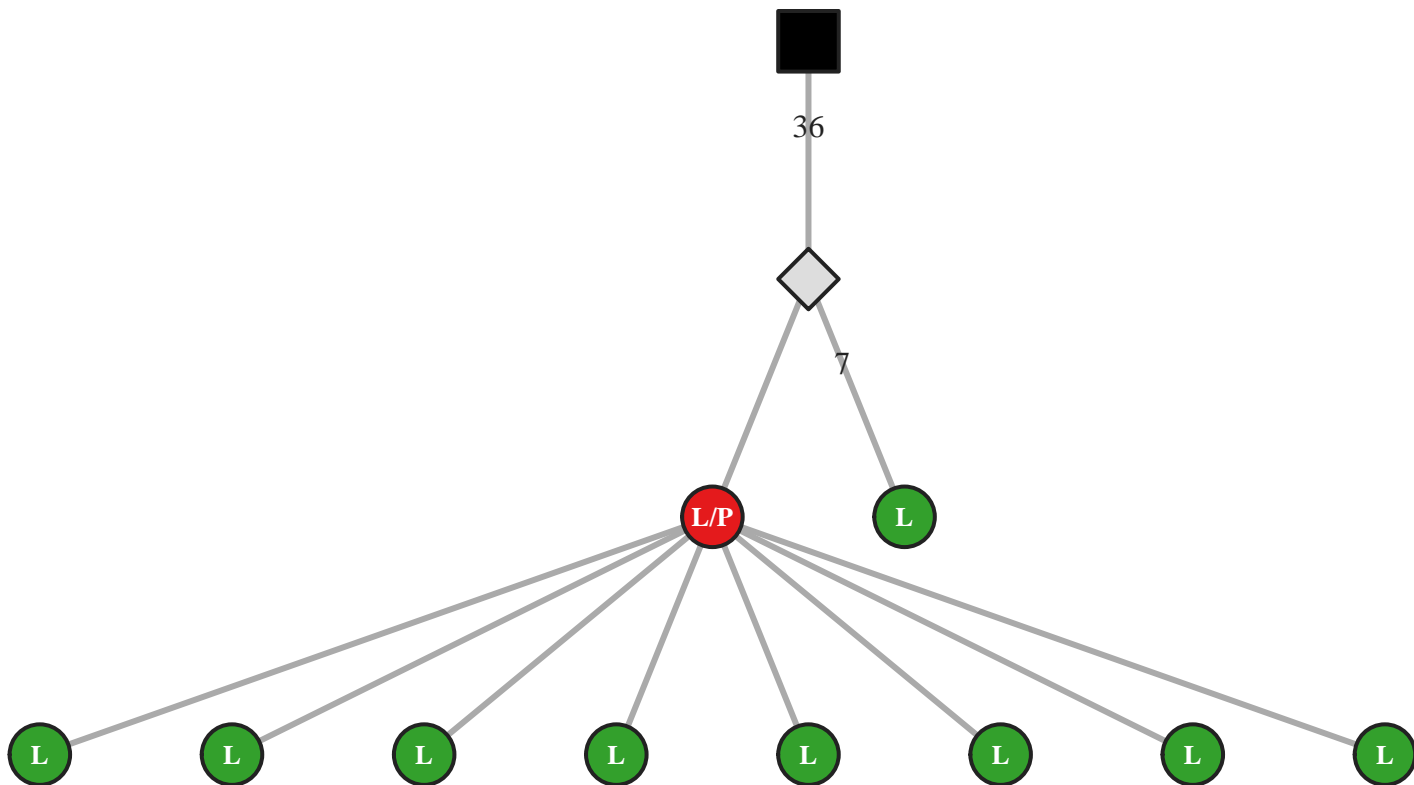

M5 IgG IGHV7-4-1/J4 60bp (37190)

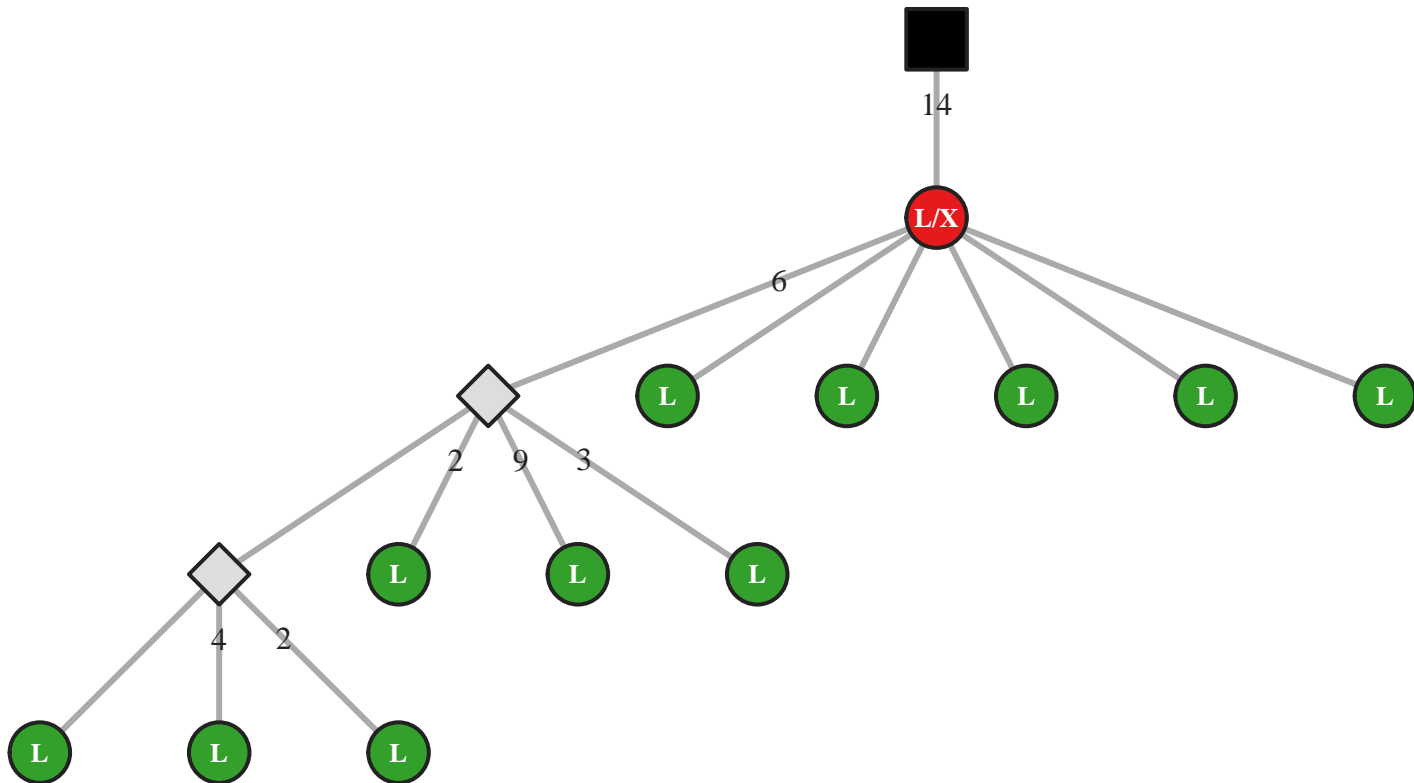

M5 IgG IGHV7-4-1/J4 60bp (37199)

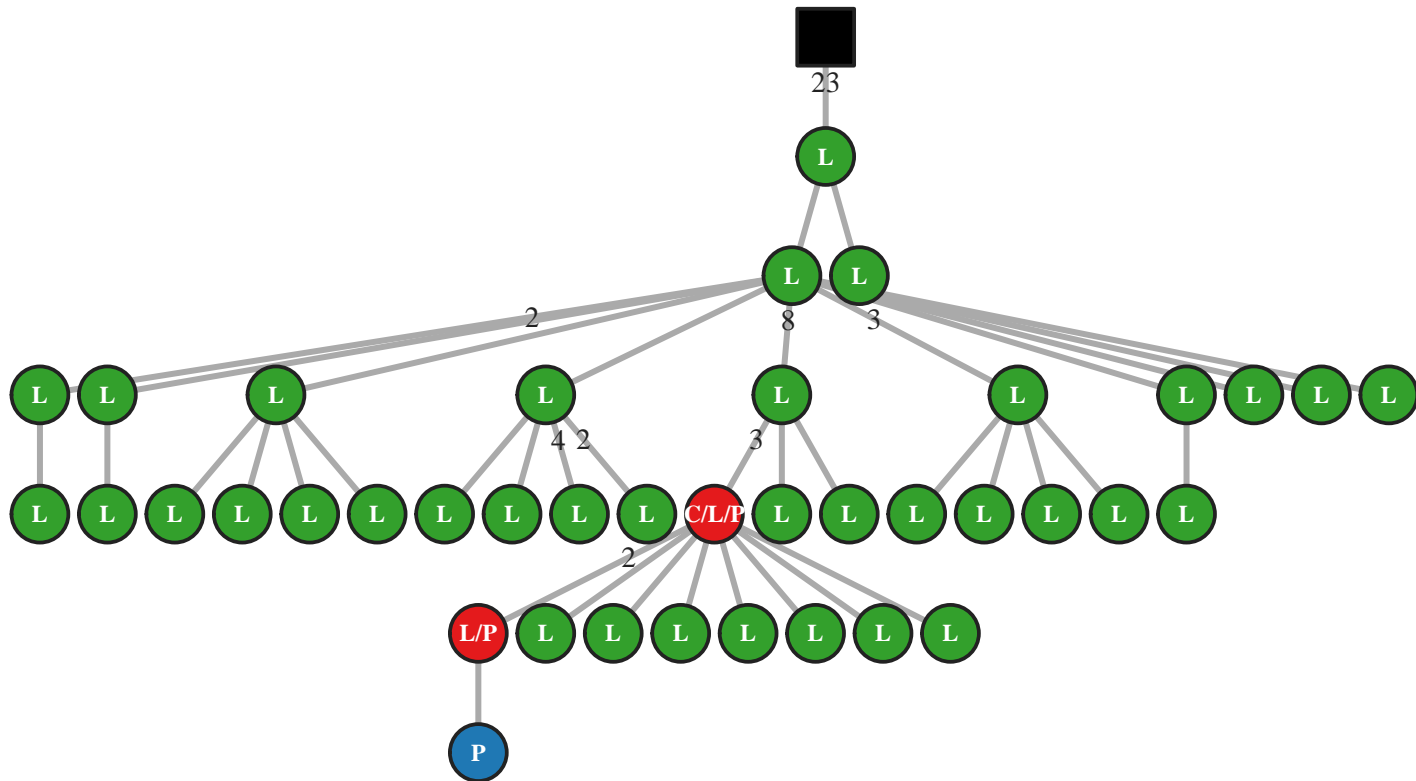

M5 IgG IGHV7-4-1/J4 60bp (37210)

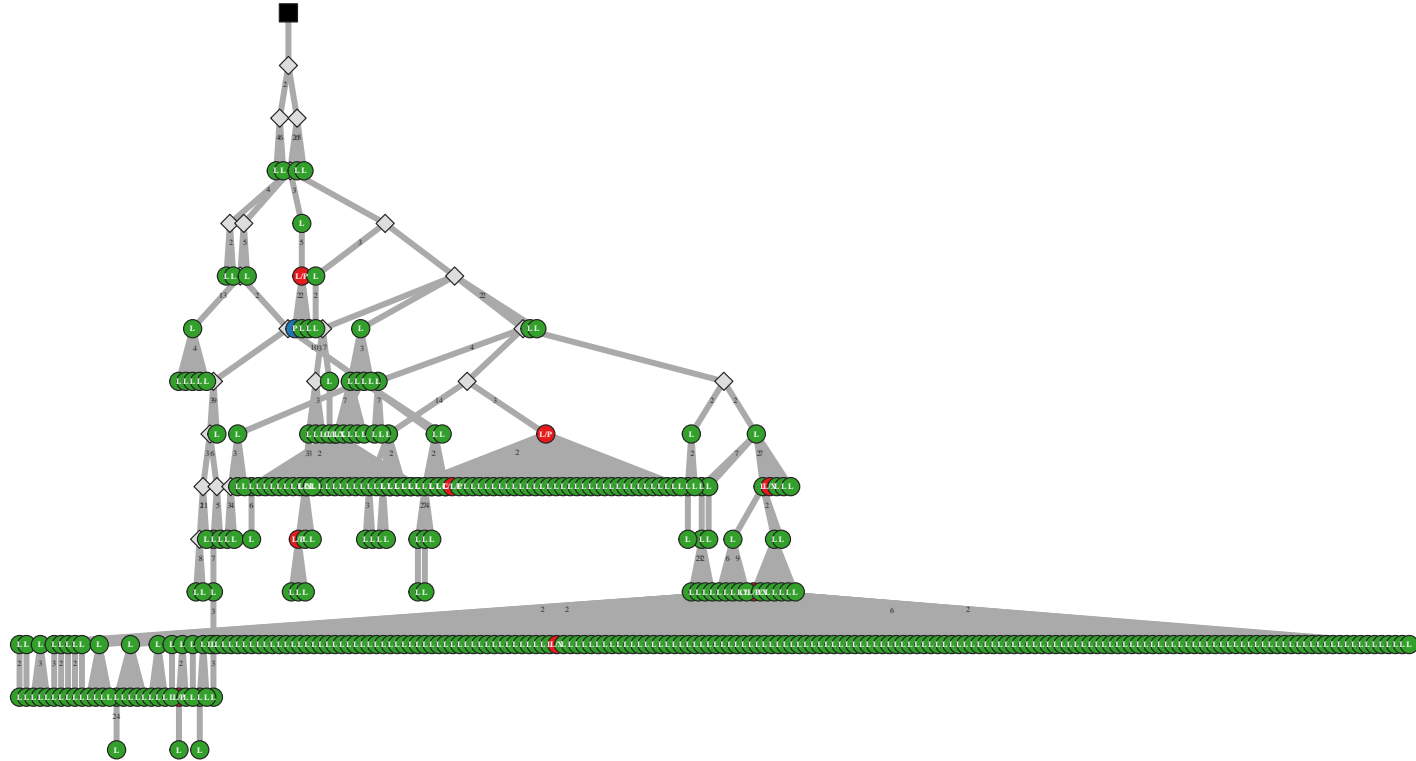

M5 IgG IGHV7-4-1/J4 60bp (37221)

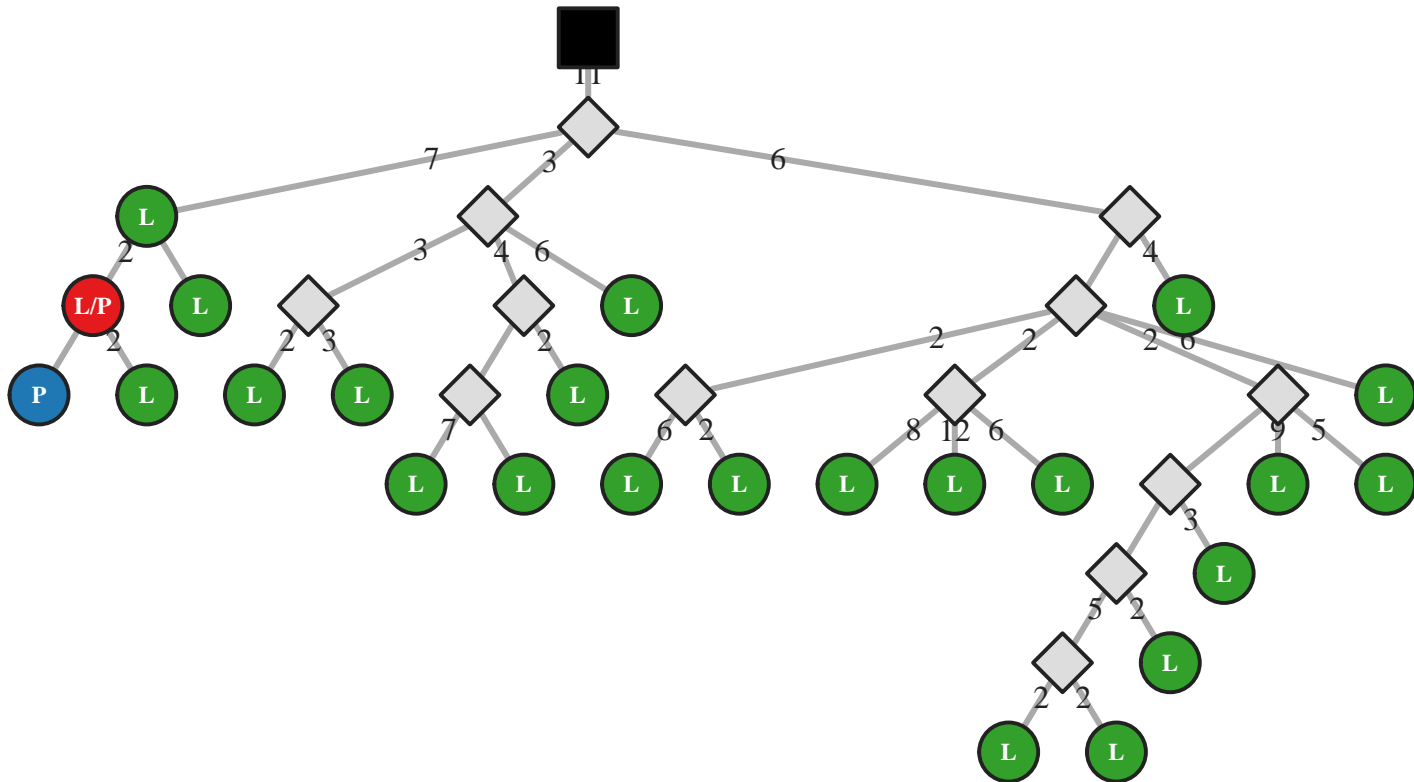

M5 IgG IGHV7-4-1/J4 60bp (37226)

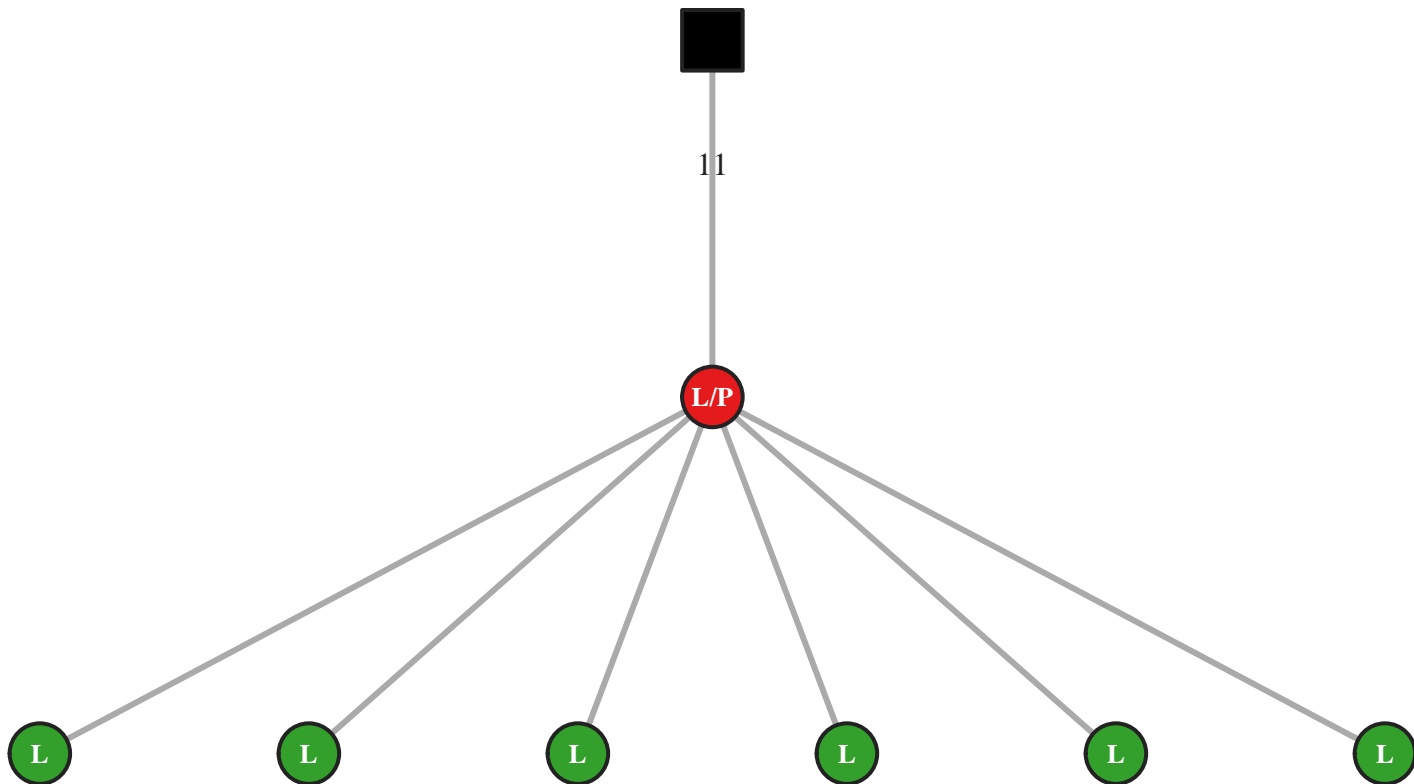

M5 IgA IGHV7-4-1/J5 42bp (30922)

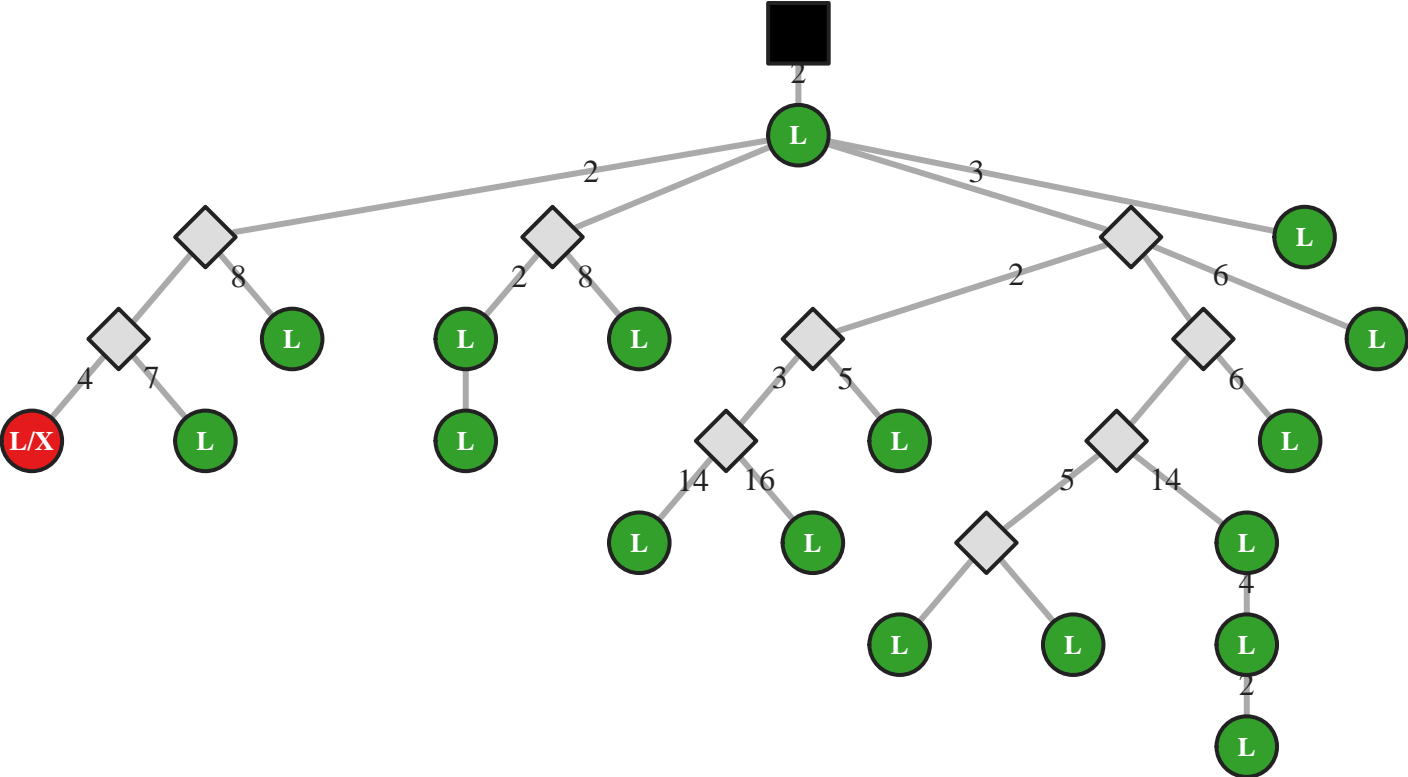

M5 IgG IGHV7-4-1/J5 42bp (47488)

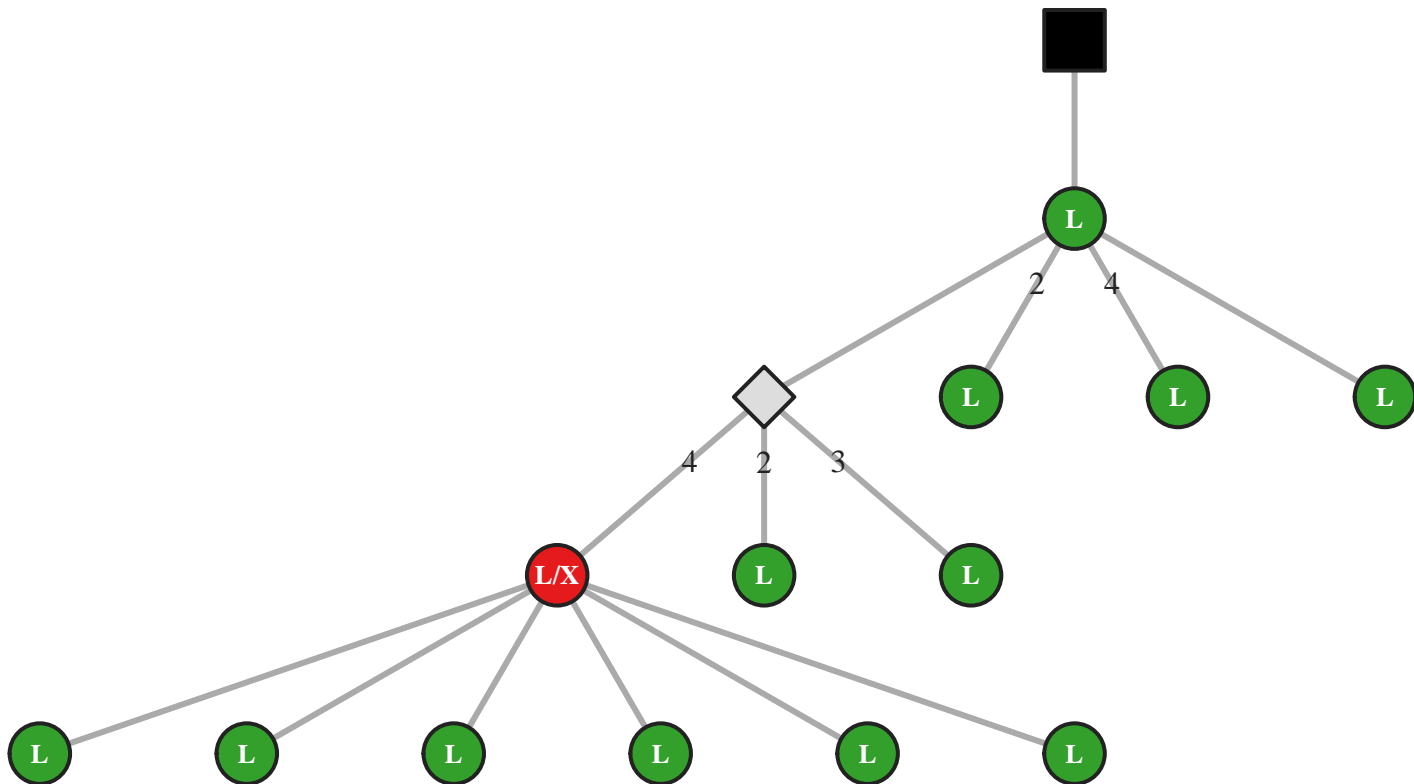

M5 IgG IGHV7-4-1/J5 42bp (47489)

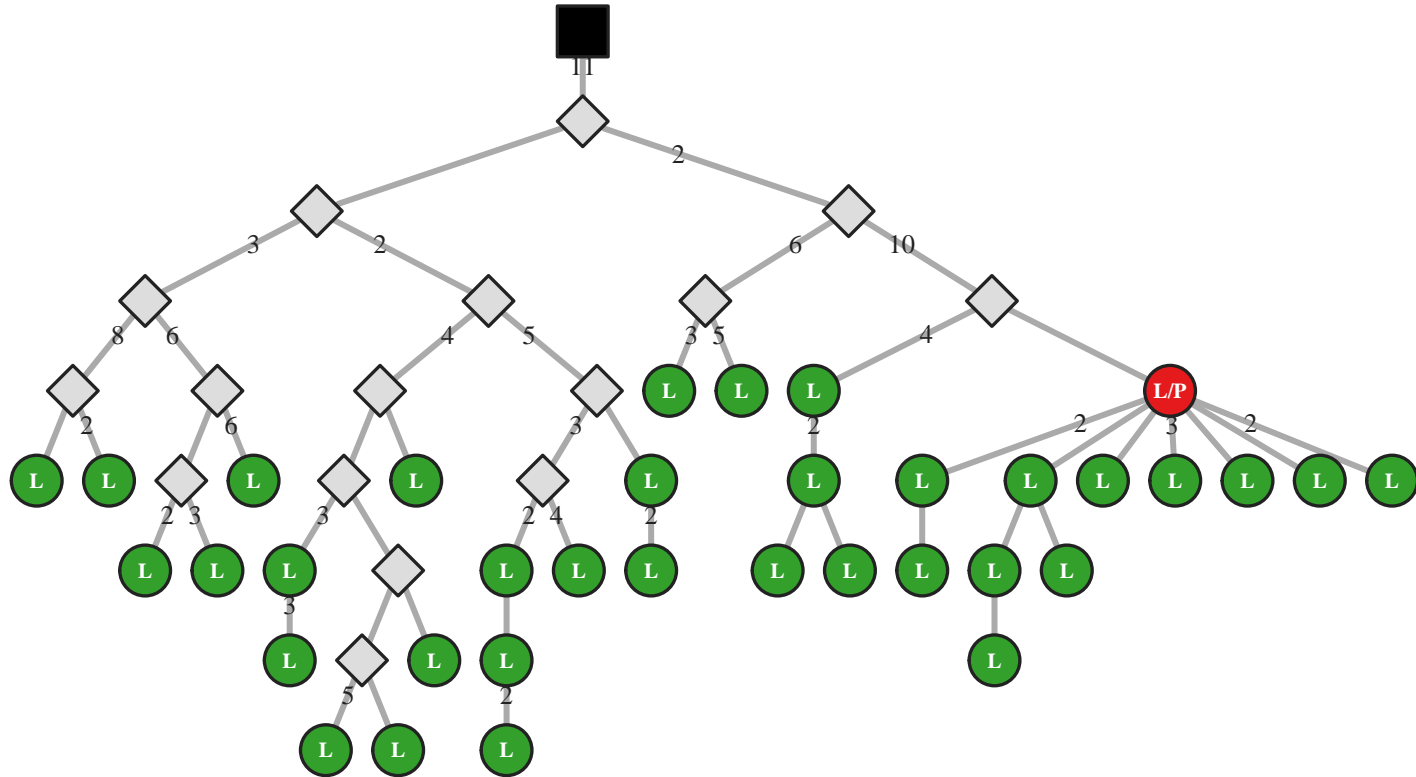

M5 IgG IGHV7-4-1/J5 60bp (20195)

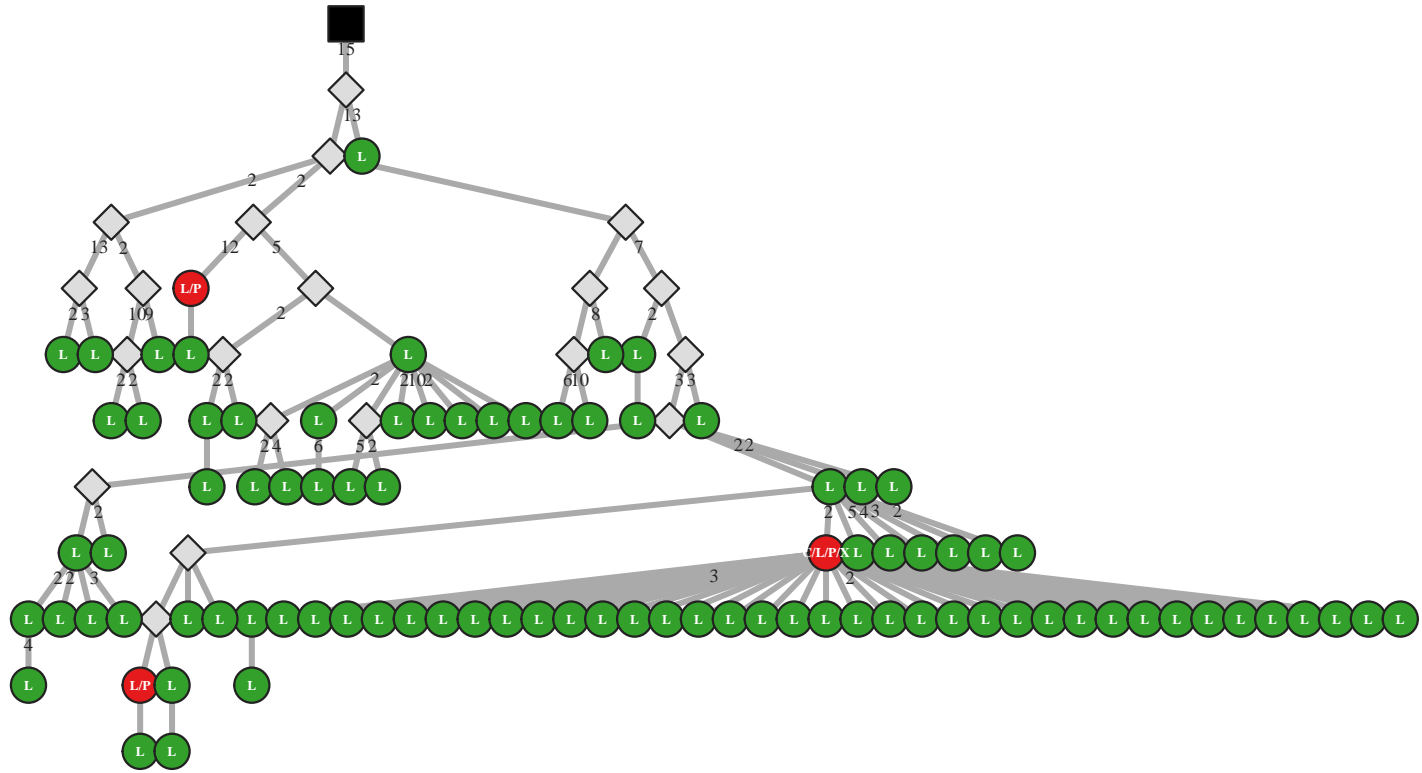

M5 IgM IGHV7-4-1/J6 48bp (21076)

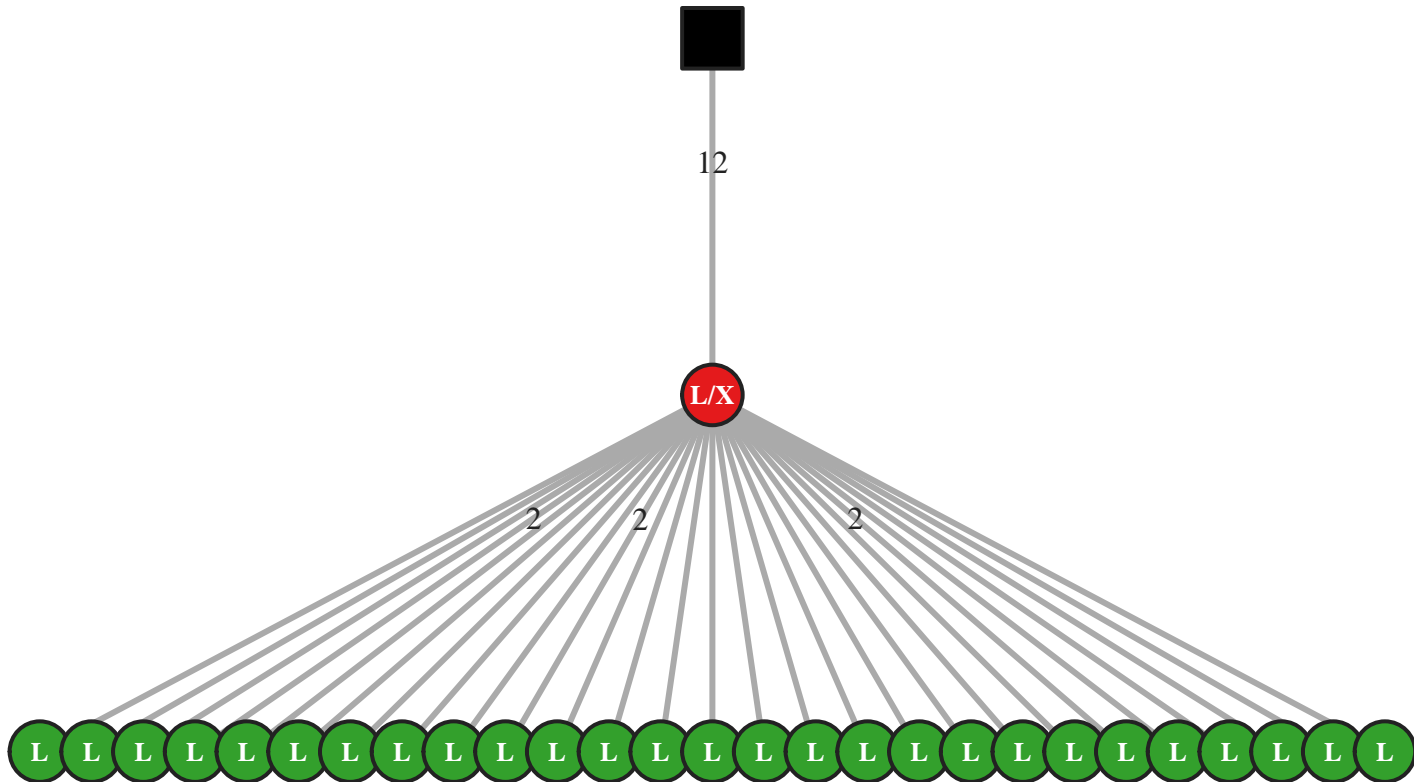

M5 IgG IGHV7-4-1/J6 63bp (37274)

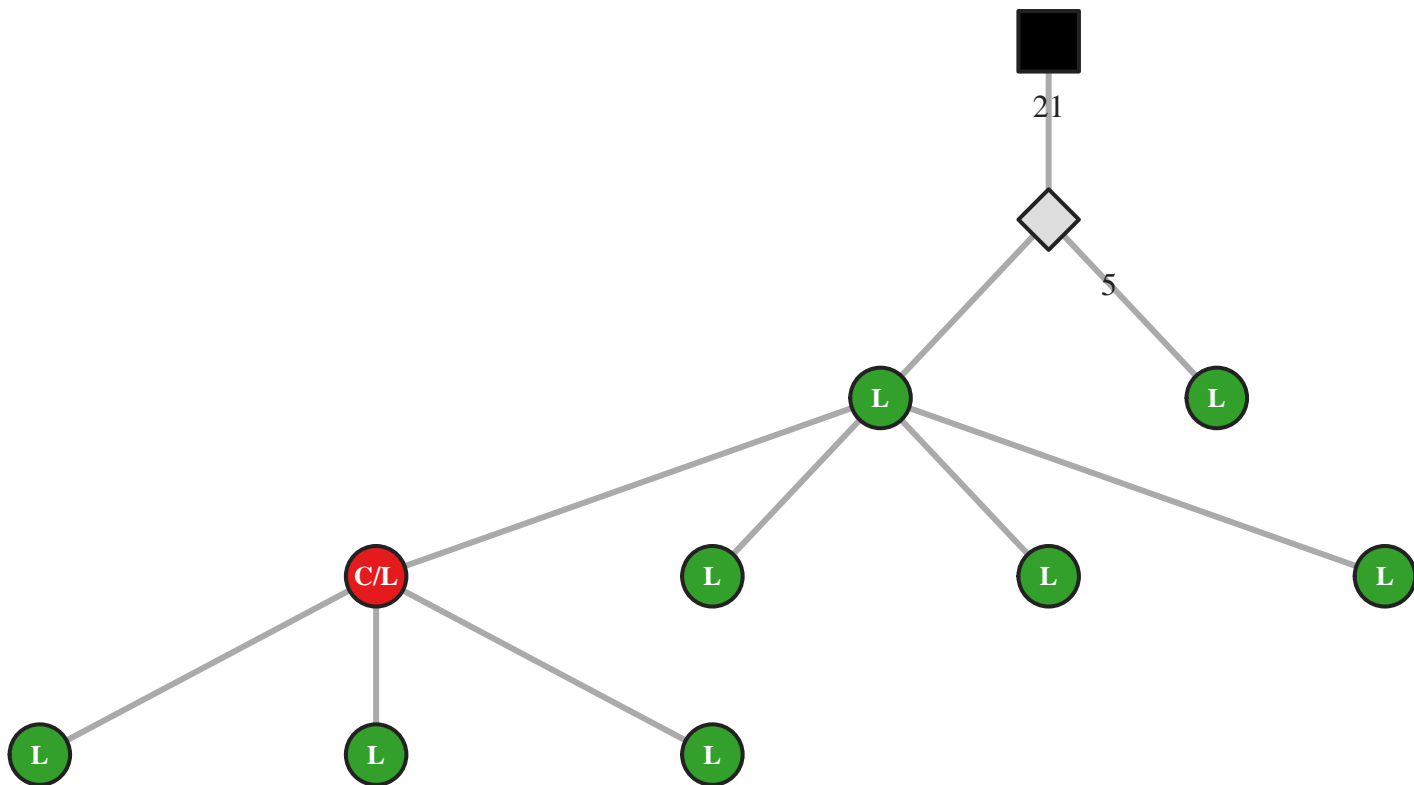

M5 IgG IGHV7-4-1/J6 63bp (37294)

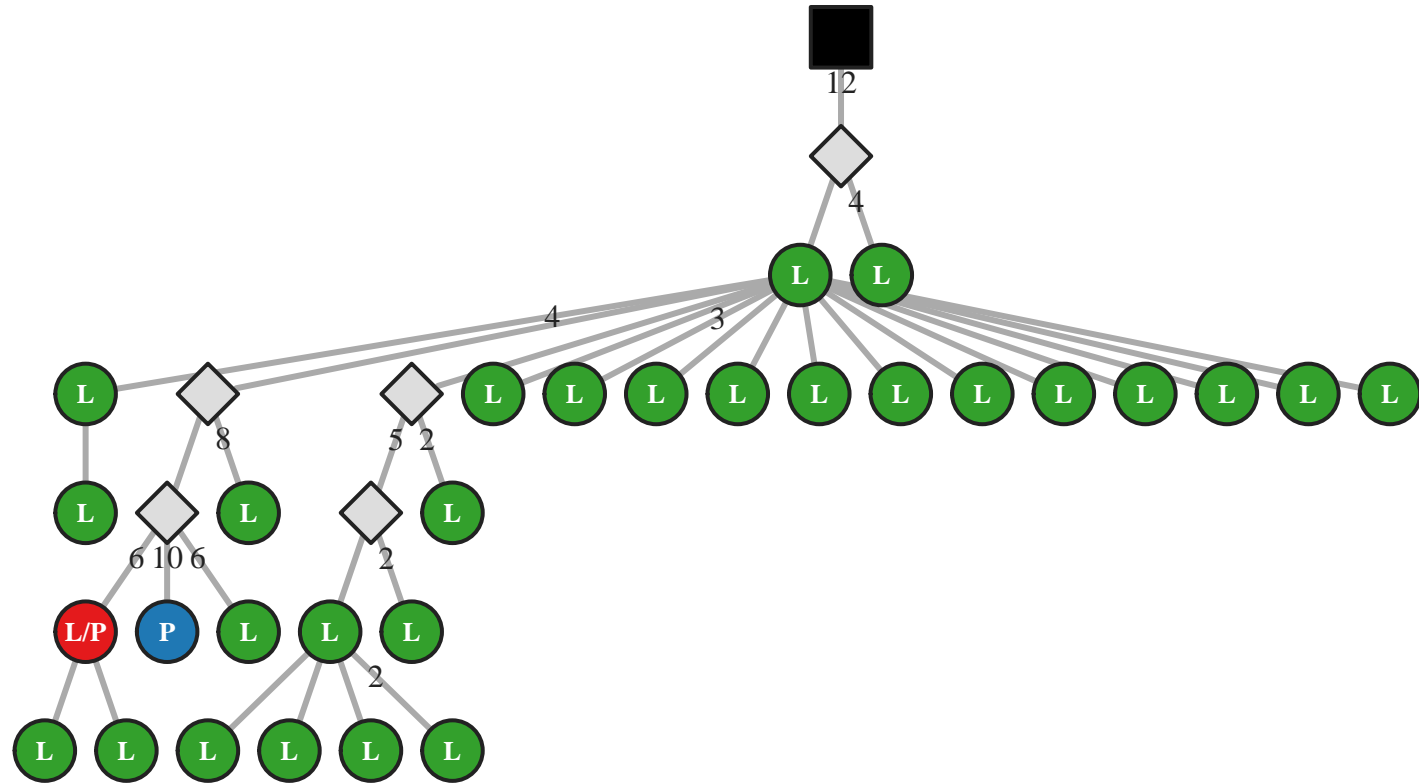

M5 IgG IGHV7-4-1/J6 72bp (53762)

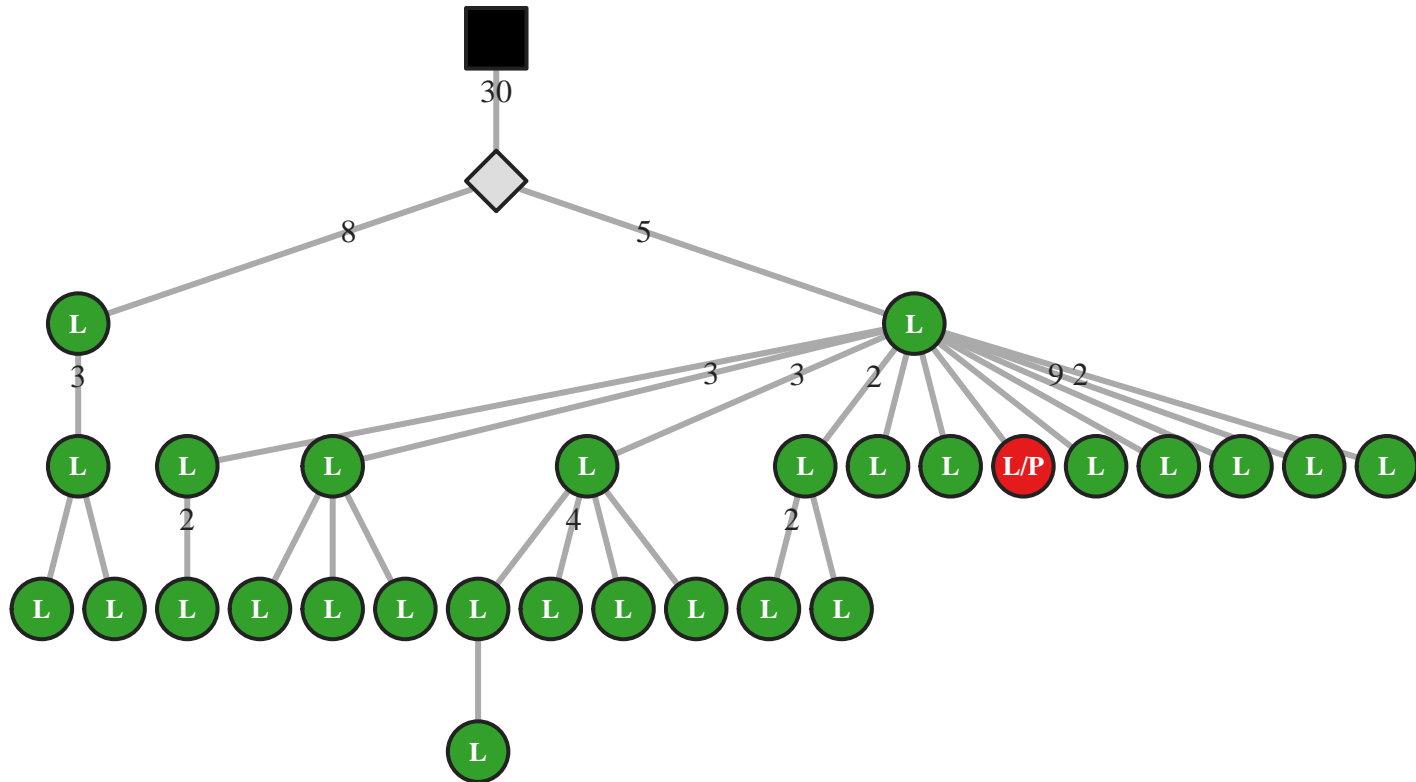

M5 IgG IGHV7-4-1/J6 72bp (53768)

